

TRAVERSING COMBINATORIAL 0/1-POLYTOPES VIA OPTIMIZATION

ARTURO MERINO AND TORSTEN MÜTZE

ABSTRACT. In this paper, we present a new framework that exploits combinatorial optimization for efficiently generating a large variety of combinatorial objects based on graphs, matroids, posets and polytopes. Our method relies on a simple and versatile algorithm for computing a Hamilton path on the skeleton of any 0/1-polytope $\text{conv}(X)$, where $X \subseteq \{0, 1\}^n$. The algorithm uses as a black box any algorithm that solves a variant of the classical linear optimization problem $\min\{w \cdot x \mid x \in X\}$, and the resulting delay, i.e., the running time per visited vertex on the Hamilton path, is only by a factor of $\log n$ larger than the running time of the optimization algorithm. When X encodes a particular class of combinatorial objects, then traversing the skeleton of the polytope $\text{conv}(X)$ along a Hamilton path corresponds to listing the combinatorial objects by local change operations, i.e., we obtain Gray code listings.

As concrete results of our general framework, we obtain efficient algorithms for generating all (c -optimal) bases and independent sets in a matroid; (c -optimal) spanning trees, forests, matchings, maximum matchings, and c -optimal matchings in a general graph; vertex covers, minimum vertex covers, c -optimal vertex covers, stable sets, maximum stable sets and c -optimal stable sets in a bipartite graph; as well as antichains, maximum antichains, c -optimal antichains, and c -optimal ideals of a poset. Specifically, the delay and space required by these algorithms are polynomial in the size of the matroid, graph, or poset, respectively. Furthermore, all of these listings correspond to Hamilton paths on the corresponding combinatorial polytopes, namely the base polytope, matching polytope, vertex cover polytope, stable set polytope, chain polytope and order polytope, respectively.

As another corollary from our framework, we obtain an $\mathcal{O}(t_{\text{LP}} \log n)$ delay algorithm for the vertex enumeration problem on 0/1-polytopes $\{x \in \mathbb{R}^n \mid Ax \leq b\}$, where $A \in \mathbb{R}^{m \times n}$ and $b \in \mathbb{R}^m$, and t_{LP} is the time needed to solve the linear program $\min\{w \cdot x \mid Ax \leq b\}$. This improves upon the 25-year old $\mathcal{O}(t_{\text{LP}} n)$ delay algorithm due to Bussieck and Lübbecke.

(Arturo Merino) DEPARTMENT OF MATHEMATICS, TU BERLIN, GERMANY

(Torsten Mütze) DEPARTMENT OF COMPUTER SCIENCE, UNIVERSITY OF WARWICK, UNITED KINGDOM
& DEPARTMENT OF THEORETICAL COMPUTER SCIENCE AND MATHEMATICAL LOGIC, CHARLES UNIVERSITY,
PRAGUE, CZECH REPUBLIC

E-mail addresses: merino@math.tu-berlin.de, torsten.mutze@warwick.ac.uk.

Arturo Merino was supported by ANID Becas Chile 2019-72200522. Torsten Mütze was supported by Czech Science Foundation grant GA 22-15272S.

1. INTRODUCTION

In mathematics and computer science, we frequently encounter different classes of combinatorial objects, for example spanning trees, matchings or vertex covers of a graph, independent sets or bases of a matroid, ideals or antichains of a poset, etc. Given a class X of objects, in *combinatorial optimization* we are interested in finding the best object from X w.r.t. some objective function f , i.e., we aim to compute a minimizer of $f(x)$ over all $x \in X$. Classical examples for such problems on graphs are computing a minimum weight spanning tree, a maximum weight matching, or a minimum size vertex cover. Motivated by countless practical instances of such problems, the field of combinatorial optimization has matured over decades into a huge body of work (see e.g. [CCPS98, Sch03a, Sch03b, Sch03c, KV18]), which combines powerful algorithmic, combinatorial and polyhedral methods. Important techniques include dynamic programming, linear and integer programming, network flows, branch-and-bound and branch-and-cut methods, approximation algorithms, parametrized algorithms etc.

Another fundamental algorithmic task apart from combinatorial optimization is *combinatorial generation*, covered in depth in Knuth’s book [Knu11]. Given a class X of objects, the task here is to exhaustively list each object from X exactly once. The running time of a generation algorithm is typically measured by its *delay*, i.e., by the time spent between generating any two consecutive objects from X . Sometimes it is reasonable to relax this worst-case measure, and to consider the *amortized delay*, i.e., the total time spent to generate X , divided by the cardinality of X . Algorithms that achieve delay $\mathcal{O}(1)$ are the holy grail, and they are sometimes called *loopless*. Compared to combinatorial optimization, the area of combinatorial generation is much less matured. Nonetheless, some general techniques are available, such as Avis and Fukuda’s reverse search [AF96], the proximity search method of Conte, Grossi, Marino, Uno and Versari [CGM⁺22], the bubble language framework of Ruskey, Sawada, and Williams [RSW12], Williams’ greedy algorithm [Wil13], and the permutation language framework of Hartung, Hoang, Mütze and Williams [HHMW22].

A particularly useful concept for developing efficient generation algorithms are Gray codes. A *combinatorial Gray code* [Rus16, Sav97, Müt22] for a class of objects is a listing of the objects such that any two consecutive objects in the list differ only by a local change. Gray codes lend themselves very well to efficient generation, and often result in algorithms with small delay, sometimes even loopless algorithms. For example, the spanning trees of any graph admit an edge exchange Gray code, i.e., they can be listed such that any two consecutive spanning trees differ in removing one edge from the current spanning tree and adding another edge from the graph to obtain the next spanning tree; see Figure 1. Furthermore, such a Gray code can be computed with amortized delay $\mathcal{O}(1)$ [Smi97] (see also [Knu11, Sec. 7.2.1.6]).

There is a trivial connection between combinatorial generation and optimization: For a given class of objects X , we can compute a minimizer of $f(x)$ by exhaustively generating X and computing $f(x)$ for each of the objects x in the list (for this the list need not be stored). In

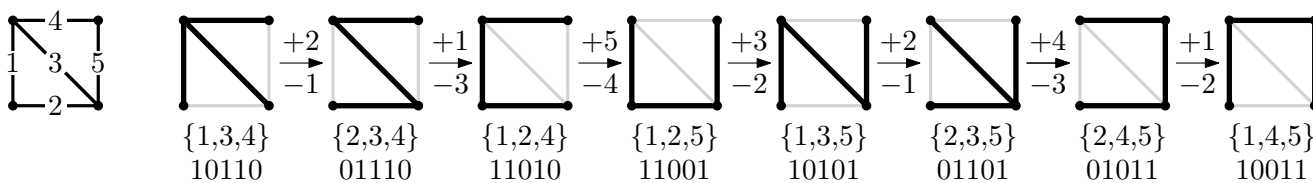

FIGURE 1. Edge exchange Gray code for the spanning trees of the diamond graph on the left. Below each spanning tree is the subset of tree edges and its indicator vector.

terms of running time, this approach is prohibitively expensive in many applications, as the size of X is often exponential in some parameter. For example, a minimum weight spanning tree in an n -vertex graph can be computed in time polynomial in n , but the number of spanning trees is typically exponential in n .

1.1. Our contribution. In this work, we establish a nontrivial connection between combinatorial generation and optimization that goes in the opposite direction. Specifically, we show that if the optimization problem $\min_{x \in X} f(x)$ can be solved efficiently, then this directly yields an efficient generation algorithm for X . More precisely, the delay for the resulting generation algorithm is only by a logarithmic factor larger than the running time of any optimization algorithm. The optimization algorithm is used as a black box inside the generation algorithm, and in this way we harness the powerful machinery of combinatorial optimization for the purpose of combinatorial generation. Furthermore, the generated listings of objects correspond to a Hamilton path on the skeleton of a 0/1-polytope that is associated naturally with the combinatorial objects, i.e., we obtain a Gray code listing. Additional notable features of our generation algorithm are: the algorithm is conceptually simple and operates greedily, it uses only elementary data structures, it is easy to implement, and it contains several tunable parameters that can be exploited for different applications. We thus provide an extremely versatile algorithmic framework to systematically solve the combinatorial generation problem for a large variety of different classes of combinatorial objects, which comes with strong guarantees for the delay and the closeness between consecutively generated objects. Table 1 summarizes the most important concrete results obtained from our framework, and those will be discussed in more detail in Section 1.6. Informally speaking, we add a new powerful ‘hammer’ to the toolbox of combinatorial generation research, which is forged by combining algorithmic, combinatorial and polyhedral ideas.

In this paper, we focus on presenting the main ingredients of our framework that connects combinatorial optimization to combinatorial generation, and we illustrate the method by deriving several new generation algorithms for a number of combinatorial objects based on graphs, matroids, posets and polytopes. This paper will be followed by others in which this new paradigm is exploited further in various directions (implementations, computational studies, improved results for special cases, etc.).

1.2. Encoding of objects by bitstrings. To run our generation algorithm, we rely on a unified method to encode the various different classes X of combinatorial objects. For this we use a set of bitstrings $X \subseteq \{0, 1\}^n$ of length n , which lends itself particularly well for computer implementation. An important notion in this context is an indicator vector. Given a subset $S \subseteq [n] := \{1, \dots, n\}$, the *indicator vector* $\mathbf{1}_S \in \{0, 1\}^n$ is defined as

$$(\mathbf{1}_S)_i := \begin{cases} 1 & \text{if } i \in S, \\ 0 & \text{if } i \notin S. \end{cases}$$

For example, the set $S = \{1, 4, 5\} \subseteq [6]$ has the indicator vector $\mathbf{1}_S = (1, 0, 0, 1, 1, 0)$. The set of bitstrings $X \subseteq \{0, 1\}^n$ that is used to encode the combinatorial objects of interest is simply the set of all corresponding indicator vectors. Specifically, combinatorial objects based on graphs are encoded by considering the corresponding subsets of vertices or edges, and by their indicator vectors. For example, indicator vectors for the spanning trees or matchings of a graph H have length m , where m is the number of edges of H ; see Figure 1. Similarly, indicator vectors for ideals or antichains of a poset P have length n , where n is the number of elements of P . Note

TABLE 1. Overview of results derived from our generation framework. For each class of combinatorial objects we show the local change operation between consecutively generated objects, the corresponding optimization problem, and the resulting (worst-case) delay per generated object, highlighted if superior to previous results. Earlier algorithms are listed in the penultimate column, and they are sometimes incomparable (worst-case delay vs. amortized delay, Gray code vs. non-Gray code). None of the earlier algorithms computes a Hamilton path on the polytope, with the only exception being the results [Smi97, MMW22] on spanning trees and matroid bases. The last column gives pointers to later sections with detailed derivations. The vector $c \in \mathbb{Z}^n$ is an arbitrary integer-valued cost vector with maximum absolute value $|c|$.

	Objects	Local change	Optimization problem	Delay	Previous work	Ref.
Other	vertices of a 0/1-polytope	edge move	linear programming with weights $\{-1, 0, 1\}$: t_{LP}	$\mathcal{O}(t_{LP} \log n)$	[BL98]: $\mathcal{O}(t_{LP} n)$ delay	Cor. 29
	c -optimal vertices of a 0/1-polytope	edge move	linear programming: t_{LP}	$\mathcal{O}(t_{LP} \text{poly}(\log n))$	[BL98]: $\mathcal{O}(t_{LP} n)$ delay	Cor. 30
	feasible solutions to a knapsack problem		knapsack with profits $\{-1, 0, 1\}$: $\mathcal{O}(n)$ (sort weights in preprocessing)	$\mathcal{O}(n \log n)$	[SW12]: $\mathcal{O}(1)$ amortized delay Gray code	
	matroid bases	element exchange	minimum weight basis with weights $\{-2, -1, 0, 1, 2\}$: t_{LO}	$\mathcal{O}(t_{LO} \log n)$	[Uno99]: amortized delay [MMW22]: delay Gray code	
	c -optimal matroid bases	same weight element exchange	minimum weight basis: t_{LO}	$\mathcal{O}(t_{LO} \log n)$		
	matroid independent sets	add/remove/exchange element	minimum weight basis with weights $\{-2, -1\}$: t_{LO}	$\mathcal{O}(t_{LO} \log n)$		
Graph	spanning trees	edge exchange	minimum spanning tree with weights $\{-2, -1, 0, 1, 2\}$: $\mathcal{O}(m)$	$\mathcal{O}(m \log n)$	[KR91]: $\mathcal{O}(1)$ amortized delay [Smi97]: $\mathcal{O}(1)$ amort. delay Gray code [MMW22]: $\mathcal{O}(m \log n (\log \log n)^3)$ delay Gray code	Cor. 31
	c -optimal spanning trees	same weight edge exchange	minimum spanning tree: $\mathcal{O}(m\alpha(m, n))$ [Cha00]	$\mathcal{O}(m\alpha(m, n) \log n)$	[YKW10]: $\mathcal{O}(m \log n)$ amortized delay	Cor. 32
	forests	add/remove/exchange edge	spanning forest computation \rightarrow graph search: $\mathcal{O}(m + n)$	$\mathcal{O}((m + n) \log n)$		
	matchings	alternating ≤ 3 -path exchange	maximum matching: $\mathcal{O}(m\sqrt{n})$ [MV80]	$\mathcal{O}(m\sqrt{n} \log n)$		Cor. 33
	maximum matchings	alternating path/cycle exchange	maximum weight matching with weights $\{m - 1, m, m + 1\}$: $\mathcal{O}(m\sqrt{n} \log n)$ [DPS18]	$\mathcal{O}(m\sqrt{n} (\log n)^2)$		Cor. 35
	c -optimal matchings	c -balanced alternating path/cycle exchange	maximum weight matching: $\mathcal{O}(m\sqrt{n} \log(n c))$ [DPS18] maximum weight matching: $\mathcal{O}(mn + n^2 \log n)$ [Gab17]	$\mathcal{O}(m\sqrt{n} \log(n c) \log n)$ $\mathcal{O}((mn + n^2 \log n) \log n)$		Cor. 34
Bipartite graph	matchings	alternating ≤ 3 -path exchange	maximum bipartite matching: $\mathcal{O}(m\sqrt{n})$ [HK73]	$\mathcal{O}(m\sqrt{n} \log n)$		
	maximum matchings	alternating path/cycle exchange	maximum weight bipartite matching with weights $\{m - 1, m, m + 1\}$: $\mathcal{O}(m\sqrt{n} \log n)$ [DS12]	$\mathcal{O}(m\sqrt{n} (\log n)^2)$	[Uno97]: $\mathcal{O}(n)$ delay	
	c -optimal matchings	c -balanced alternating path/cycle exchange	maximum weight bipartite matching: $\mathcal{O}(m\sqrt{n} \log(c))$ [DS12] maximum weight bipartite matching: $\mathcal{O}((mn + n^2 \log \log n) \log n)$ [Tho04]	$\mathcal{O}(m\sqrt{n} \log(c) \log n)$ $\mathcal{O}((mn + n^2 \log \log n) \log n)$	[FM92]: $\mathcal{O}(mn)$ delay for c -optimal perfect matchings	
	vertex covers	connected symmetric difference exchange	minimum bipartite vertex cover: $\mathcal{O}(m\sqrt{n})$ [HK73]	$\mathcal{O}(m\sqrt{n} \log n)$		
	minimum vertex covers	connected symmetric difference exchange	maximum flow with capacities $\{n - 1, n, n + 1\}$: $\mathcal{O}(mn)$ [Orl13]	$\mathcal{O}(mn \log n)$		
	c -optimal vertex covers	connected symmetric difference exchange	maximum flow: $\mathcal{O}(mn)$ [Orl13]	$\mathcal{O}(mn \log n)$		
Poset	antichains	connected symmetric difference exchange	maximum antichain \rightarrow maximum bipartite matching: $\mathcal{O}(n^{2.5}/\sqrt{\log n})$ [ABMP91] (cf. [FRS03])	$\mathcal{O}(n^{2.5} \sqrt{\log n})$		
	maximum antichains	connected symmetric difference exchange	MWCCG with weights $\{n - 1, n, n + 1\}$: $\mathcal{O}(n^4)$ [Gav00]	$\mathcal{O}(n^4 \log n)$		
	c -optimal antichains	connected symmetric difference exchange	maximum weight clique in cocomparability graph (MWCCG): $\mathcal{O}(n^4)$ [Gav00]	$\mathcal{O}(n^4 \log n)$		
	ideals	connected symmetric difference exchange	MWCCG with weights $\{-1, 1\}$: $\mathcal{O}(n^4)$ [Gav00]	$\mathcal{O}(n^4 \log n)$	[Squire 1995] (see [Rus03]): $\mathcal{O}(\log n)$ amortized delay [PR93, HMNS01]: $\mathcal{O}(n)$ amortized delay Gray code	
	c -optimal ideals	connected symmetric difference exchange	MWCCG: $\mathcal{O}(n^4)$ [Gav00]	$\mathcal{O}(n^4 \log n)$		

that this encoding is based on a particular ordering of the ground set. In other words, changing the ordering of the ground set corresponds to permuting the entries of all bitstrings in X .

1.3. Combinatorial 0/1-polytopes. A crucial feature of this encoding via bitstrings is that it allows to equip the combinatorial objects with a natural *polytope* structure. This idea is the cornerstone of polyhedral combinatorics and has been exploited extensively in combinatorial

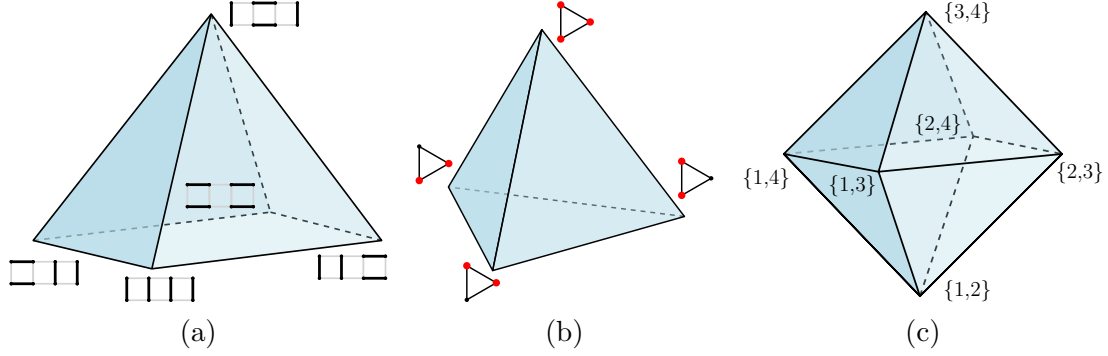

FIGURE 2. Three combinatorial 0/1-polytopes (after appropriate projections into 3-dimensional space and under combinatorial equivalence): (a) perfect matching polytope of the 2×4 grid graph; (b) vertex cover polytope of the triangle graph; (c) base polytope of the uniform matroid of 2-element subsets of the ground set $\{1, 2, 3, 4\}$.

TABLE 2. Examples of 0/1-polytopes that encode local change operations on combinatorial objects through their skeleton.

Parameter	Polytope	Vertex set X	Edges (=flips)	Ref.
integer n	n -dimensional hypercube	$\{0, 1\}^n$, i.e., bitstrings of length n	flip a single bit	
integer n	Birkhoff polytope	$n \times n$ permutation matrices	multiplication with a cycle	[Zie95]
integers n, k	uniform matroid base polytope	(n, k) -combinations	transpositions	[HK78]
connected graph H	spanning tree polytope	indicator vectors of spanning trees of H	edge exchange	[HK78]
graph H	matching polytope	indicator vectors of matchings in H	alternating path/cycle exchange	[Chv75]
graph H	perfect matching polytope	indicator vectors of perfect matchings in H	alternating cycle exchange	[Chv75]
graph H	stable set polytope	indicator vectors of stable (=independent) sets in H	connected symmetric difference exchange	[Chv75]
graph H	vertex cover polytope	indicator vectors of vertex covers in H	connected symmetric difference exchange	[HK78]
poset P	chain polytope	indicator vectors of antichains in P	connected symmetric difference exchange	[Sta86, HL19]
poset P	order polytope	indicator vectors of ideals in P	connected symmetric difference exchange	[Sta86, HL19]

optimization. Specifically, for a given set of bitstrings $X \subseteq \{0, 1\}^n$, we consider the convex hull

$$\text{conv}(X) := \left\{ \sum_{x \in X} \nu_x x \mid \nu_x \in [0, 1] \text{ for all } x \in X \text{ and } \sum_{x \in X} \nu_x = 1 \right\},$$

which is a 0/1-polytope with vertex set X . More generally, the combinatorial structure of X is encoded in the face structure of $\text{conv}(X)$. In particular, the edges of the polytope $\text{conv}(X)$ correspond to local changes between the objects from X that are the endpoints of this edge. For example, if X is the set of indicator vectors of spanning trees of a graph H , then the edges of $\text{conv}(X)$ connect pairs of spanning trees that differ in an edge exchange. Or, if X is the set of indicator vectors of matchings of H , then the edges of $\text{conv}(X)$ connect pairs of matchings that differ in an alternating path or cycle. Some examples of such combinatorial 0/1-polytopes are visualized in Figure 2, and more are listed in Table 2. Note that the dimension n quickly exceeds 3 even for moderately large examples, so the figure shows combinatorially equivalent projections into 3-dimensional space (where the coordinates are not 0/1 anymore).

We are mostly interested in the *skeleton* of the polytope under consideration, i.e., the graph defined by its vertices and edges; see Figure 3. In this context it makes sense to refer to bitstrings from X as vertices. As mentioned before, the edges of the skeleton capture local change operations between the combinatorial objects that are represented by the vertices. Such graphs are sometimes called *flip graphs* in the literature, where *flip* is a general term for a local change operation (flip graphs can be defined without reference to polytopes).

The most notable feature of the generation algorithm presented in this paper is that the listings of objects X generated by the algorithm correspond to a *Hamilton path* on the skeleton of $\text{conv}(X)$, i.e., a path that visits every vertex of the polytope exactly once. As a result, any two consecutive objects in the listing differ by a local change (=flip), i.e., we obtain a Gray code.

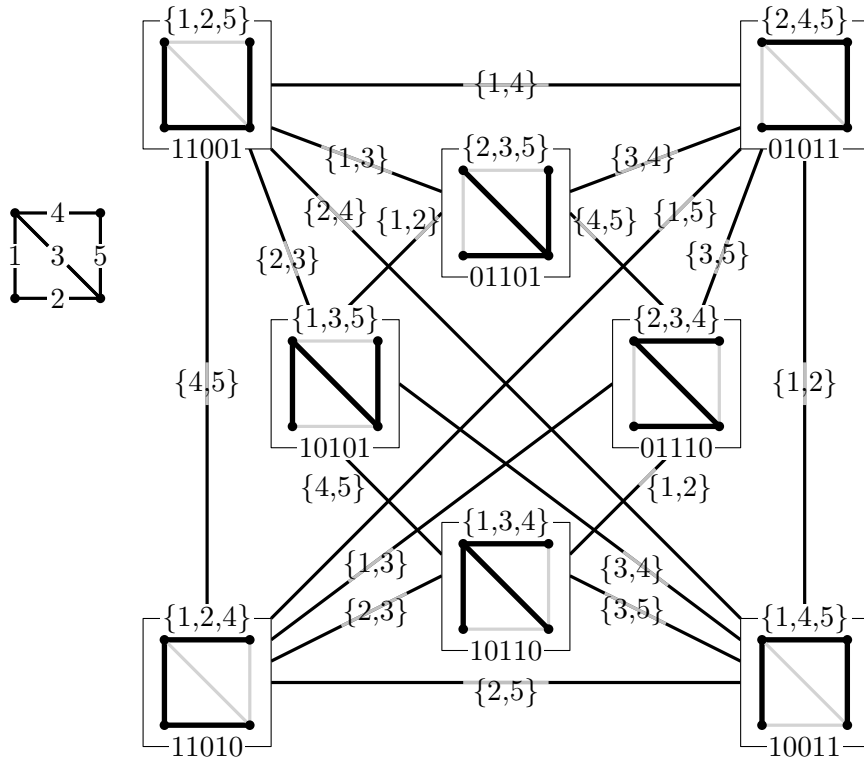

FIGURE 3. Skeleton of the spanning tree polytope of the diamond graph. The edges of the skeleton are labeled by edge exchanges.

1.4. The basic algorithm. To describe our algorithm, we define for any two distinct bitstrings $x, y \in X \subseteq \{0, 1\}^n$ the quantity $\lambda(x, y) := \max\{i \in [n] \mid x_i \neq y_i\}$. In words, $\lambda(x, y)$ is the largest index in which x and y differ. Equivalently, the longest suffix in which x and y agree has length $n - \lambda(x, y)$. For example, we have $\lambda(1010110, 0111110) = 4$ and $\lambda(01100, 11100) = 1$. For any two bitstrings $x, y \in \{0, 1\}^n$ we define the *Hamming distance* of x and y as $d(x, y) := |\{i \in [n] \mid x_i \neq y_i\}|$. In words, this is the number of positions in which x and y differ. For example, we have $d(1010110, 0111110) = 3$ and $d(01100, 11100) = 1$.

With these definitions at hand, we are in position to describe our basic generation algorithm, shown in Algorithm P as pseudocode. Algorithm P takes as input a set of bitstrings $X \subseteq \{0, 1\}^n$ (possibly given implicitly; recall Table 2) and it computes a Hamilton path on the skeleton of the 0/1-polytope $\text{conv}(X)$, starting at an initial vertex \tilde{x} that is also provided as input. The current vertex x is visited in step P2, and subsequently the next vertex to be visited is computed in steps P3 and P4. Specifically, in step P3 we compute the length β of the shortest prefix change between x and any unvisited vertex $y \in X - x$. In step P4 we consider vertices y that differ from x in a prefix of length β , i.e., $\lambda(x, y) = \beta$, and among those we select the ones with minimum Hamming distance from x into the set N . We will show that all vertices in N are actually unvisited. In step P5, one of the vertices $y \in N$ is chosen as the next vertex to be visited by the algorithm. If the set N contains more than one element, then we have freedom to pick an arbitrary vertex $y \in N$. In concrete applications, one will usually equip Algorithm P with a *tiebreaking rule*, which for a given set $N \subseteq X$ and the current state of the algorithm selects an element from N .

Algorithm P (*Traversal of 0/1-polytope by shortest prefix changes*). For a set $X \subseteq \{0, 1\}^n$, this algorithm greedily computes a Hamilton path on the skeleton of the 0/1-polytope $\text{conv}(X)$, starting from an initial vertex \tilde{x} .

P1. [Initialize] Set $x \leftarrow \tilde{x}$.

P2. [Visit] Visit x .

P3. [Shortest prefix change] Terminate if all vertices of X have been visited. Otherwise compute the length β of the shortest prefix change between x and any unvisited vertex $y \in X - x$, i.e., $\beta \leftarrow \min_{y \in X - x \wedge y \text{ unvisited}} \lambda(x, y)$.

P4. [Closest vertices] Compute the set N of vertices y with $\lambda(x, y) = \beta$ of minimum Hamming distance from x , i.e., $N \leftarrow \text{argmin}_{y \in X - x \wedge \lambda(x, y) = \beta} d(x, y)$.

P5. [Tiebreaker+update x] Pick any vertex $y \in N$, set $x \leftarrow y$ and goto P2.

The listing of spanning trees shown in Figure 1 is a possible output of Algorithm P. The corresponding Hamilton path on the skeleton of the spanning tree polytope is highlighted by a dashed line in Figure 4. This figure colors the edges (x, y) of the skeleton according to their λ -value $\lambda(x, y)$, and it shows the state of the variables x , β and N through each iteration of the algorithm. Note that in the third and fourth iteration the set N has more than one element, so ties have to be broken. Observe how the algorithm greedily gives priority to traversing edges with small λ -value (a short prefix change) compared to large λ -value (a long prefix change).

The following fundamental theorem is the basis of our approach.

Theorem 1. *For any set $X \subseteq \{0, 1\}^n$, any tiebreaking rule and any initial vertex \tilde{x} , Algorithm P computes a Hamilton path on the skeleton of $\text{conv}(X)$ starting at \tilde{x} .*

Algorithm P has a number of striking features:

- It works for *any* set of bitstrings $X \subseteq \{0, 1\}^n$, i.e., for any 0/1-polytope.

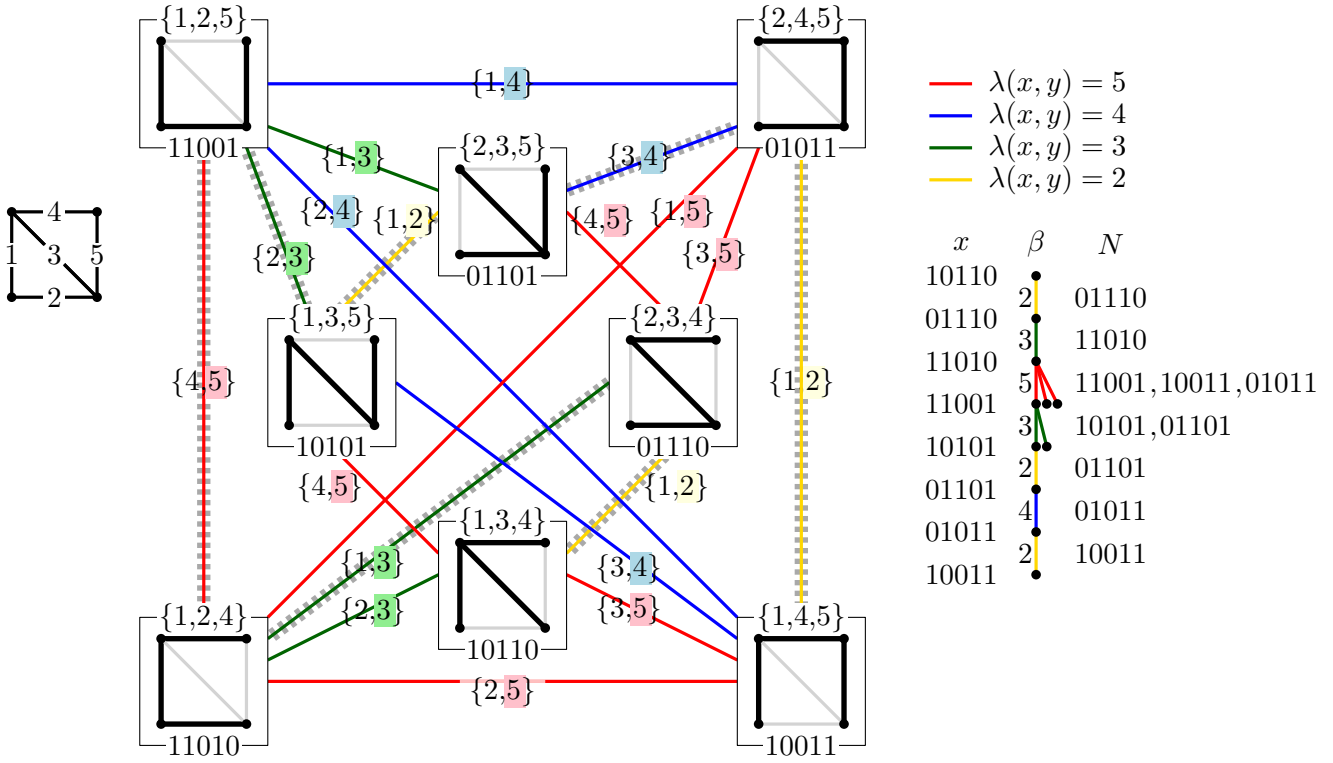

FIGURE 4. Run of Algorithm P on the skeleton from Figure 3. Edges are colored according to λ -values. The computed Hamilton path is drawn dashed, and it corresponds to the edge exchange Gray code from Figure 1.

- It works for *any* tiebreaking rule used in step P5. In an actual implementation, we would directly compute one particular vertex from N , instead of computing all of them and then selecting one. The reason why the set N appears in the pseudocode is to emphasize the freedom we have in choosing a tiebreaking rule according to the needs of the application.
- It works for *any* initial vertex \tilde{x} , which creates room for exploitation in different applications.
- It works for *any* ordering of the ground set $[n]$. In fact, we could state the algorithm in an even more general form and base the computation of λ on any total order of $[n]$. This freedom can be very helpful in various applications. For example, when computing the spanning trees of a graph H , different orderings of the edges of H will result in different listings of the spanning trees (even for the same initial spanning tree and the same tiebreaking rule).
- The ordering of bitstrings from X produced by the algorithm has the so-called *genlex* property, i.e., bitstrings with the same suffix appear consecutively. In other words, the algorithm visits vertices ending with 0 before all vertices ending with 1, or vice versa, and this property is true recursively within each block of vertices with the same suffix removed.
- The algorithm performs no polyhedral computations at all. In particular, there are no references to the edges or higher-dimensional faces of the polytope $\text{conv}(X)$ in the algorithm. Instead, it relies on combinatorial properties of the bitstrings in X , namely λ -values and Hamming distances. The fact that the resulting listing is a Hamilton path on the skeleton of the polytope $\text{conv}(X)$ is a consequence of these combinatorial properties, but not built into the algorithm.
- The algorithm computes a Hamilton path on the skeleton of the 0/1-polytope $\text{conv}(X)$, i.e., we obtain a Gray code listing of the objects encoded by X with closeness guarantees between consecutive objects; recall Table 2. Observe that the algorithm does not traverse *arbitrary*

edges of the 0/1-polytope, but only edges with minimum Hamming distance (as mentioned before, the algorithm does not even ‘know’ that these are polytope edges). As a consequence, these closeness guarantees can be strengthened considerably in many cases. For example, in the matching polytope any two matchings that differ in an alternating path or cycle are adjacent, but Algorithm P will only traverse edges corresponding to alternating paths of length ≤ 3 . Similarly, in the Birkhoff polytope any two permutations that differ in a single cycle are adjacent, but Algorithm P will only traverse edges corresponding to cycles of length 2 (i.e., transpositions).

- The computation of β in step P3 requires the qualification ‘ y unvisited’, which seems to indicate that we need to store all previously visited vertices, which would require exponential space and would therefore be very detrimental. However, we show that with some simple additional data structures, we can make the algorithm *history-free*, so no previously visited vertices need to be stored at all, but instead the algorithm uses only $\mathcal{O}(n)$ extra space (in addition to the input). This history-free implementation of Algorithm P is described as Algorithm P* in Section 6.2.
- The algorithm is straightforward to implement with few lines of code.
- As we shall explain in the next section, the computations in steps P3 and P4 can be done by solving one or more instances of a linear optimization problem over X . Consequently, we can use *any* optimization algorithm as a black box inside Algorithm P (or its history-free variant). The running time of the generation algorithm then depends on the time needed to solve the optimization problem, and the resulting delay is only by a $\log n$ factor larger than the time needed to solve the optimization problem. Specifically, the $\log n$ factor comes from solving several instances of the optimization problem, and doing binary search.
- Algorithm P thus provides a *general and automatic* way to exploit an optimization algorithm for the purpose of generation. With each new optimization algorithm we automatically obtain a baseline against which to compare any new generation algorithm for that particular class of objects. Also, the delays for concrete problems listed in Table 1 obtained from our work may improve as soon as someone finds an improved optimization algorithm.

We also mention the following two shortcomings of Algorithm P:

- For unstructured classes of objects, for example the set of all bitstrings of length n , or the set of all $n \times n$ permutation matrices, there are sometimes faster (often loopless) and more direct generation methods available than what we obtain via optimization. While Algorithm P still works in those cases, its performance shines primarily for classes of objects that arise from certain constraints, for example from a graph, a matroid, a poset, or from a cost function.
- In general, Algorithm P does not compute a Hamilton *cycle*, but only a Hamilton path on the 0/1-polytope (cf. Section 1.7 below). There are classes of objects and choices of the tiebreaking rule so that the last vertex of the computed path is adjacent to the first one, but these situations are out of our control in general. This is because the algorithm operates entirely locally on the skeleton and ‘forgets’ the location of the initial vertex \tilde{x} .

1.5. Reduction to classical linear optimization. A classical problem in combinatorial optimization, which includes for example minimum spanning tree, maximum weight (perfect) matching, maximum stable set, minimum vertex cover and many others, is the *linear optimization* problem, defined as follows:

LO Given a set $X \subseteq \{0, 1\}^n$ and a weight vector $w \in \mathbb{R}^n$, compute an element in

$$N := \operatorname{argmin}_{y \in X} w \cdot y,$$

or decide that this problem is infeasible, i.e., $N = \emptyset$.

The key insight of our paper is that the computation of β in step P3 and of the set N in step P4 of Algorithm P can be achieved by solving one of more instances of the following variant of the problem LO, which we refer to as *linear optimization with prescription*.

LOP Given a set $X \subseteq \{0, 1\}^n$, a weight vector $w \in \mathbb{R}^n$, and disjoint sets $P_0, P_1 \subseteq [n]$, compute an element in

$$N := \operatorname{argmin}_{y \in X \wedge y_{P_0}=0 \wedge y_{P_1}=1} w \cdot y,$$

or decide that this problem is infeasible, i.e., $N = \emptyset$.

The notation $y_{P_b} = b$ for $b \in \{0, 1\}$ is a shorthand for $y_i = b$ for all $i \in P_b$. In words, the value of y is prescribed to be 0 or 1 at the coordinates in P_0 and P_1 , respectively.

We explain the reduction to the problem LOP for the computation of the set

$$N := \operatorname{argmin}_{y \in X - x \wedge \lambda(x, y) = \beta} d(x, y)$$

in step P4 of Algorithm P. Given x and $\beta \in [n]$, we define the weight vector

$$w_i := \begin{cases} +1 & \text{if } x_i = 0, \\ -1 & \text{if } x_i = 1, \end{cases} \quad (1)$$

and the sets

$$P_b := \{\beta \mid x_\beta = 1 - b\} \cup \{i > \beta \mid x_i = b\} \text{ for } b \in \{0, 1\},$$

and we use w and P_0, P_1 as input for the optimization problem LOP. The definition of P_0, P_1 ensures that all feasible $y \in X$ satisfy $y_i = x_i$ for $i > \beta$ and $y_\beta = 1 - x_\beta$, which ensures that they all satisfy $\lambda(x, y) = \beta$, in particular $y \neq x$, i.e., $y \in X - x$. Furthermore, the definition of w implies that $d(x, y) = w \cdot (y - x)$, and since x is fixed, minimization of $d(x, y)$ is the same as minimization of $w \cdot y$. We consequently obtain that

$$N = \operatorname{argmin}_{y \in X - x \wedge \lambda(x, y) = \beta} d(x, y) = \operatorname{argmin}_{y \in X \wedge y_{P_0}=0 \wedge y_{P_1}=1} w \cdot y.$$

The computation of β in step P3 of our algorithm can be done similarly, however with an extra ingredient, namely binary search. The binary search causes the $\log n$ factor in the delay. Specifically, we obtain that if problem LOP over X can be solved in time t_{LOP} , then Algorithm P runs with delay $\mathcal{O}(t_{\text{LOP}} \log n)$ (Theorem 21). We also provide a variant of this reduction for generating only the elements in X that are optimal w.r.t. some cost vector $c \in \mathbb{Z}^n$ (Theorem 25).

In many cases (e.g., spanning trees, matchings, perfect matchings, etc.) the problem LOP with weights w as in (1) reduces to the problem LO directly (by removing or contracting prescribed edges). In those cases we obtain the same results as before, but with t_{LO} instead of t_{LOP} . In fact, by weight amplification the problem LOP can always be reduced to the problem LO (Lemma 27), albeit at the expense of increasing the weights, which may worsen the running time of the optimization algorithm.

1.6. Applications. It turns out that Algorithm P is very versatile, and allows efficient generation of a large variety of combinatorial objects based on graphs, matroids, posets and polytopes in Gray code order. Table 1 lists these results in condensed form, and in the following we comment on the most important entries in the table.

1.6.1. *Vertex enumeration of 0/1-polytopes.* The *vertex enumeration problem* for polytopes is fundamental in discrete and computational geometry; see the surveys [MR80] and [Dye83], and the more recent work [CHJ91, BEGM09, BEGT11, EM20].¹ Given a linear system $Ax \leq b$ of inequalities, where $A \in \mathbb{R}^{m \times n}$ and $b \in \mathbb{R}^m$, the problem is to generate all vertices of the polytope $P := \{x \in \mathbb{R}^n \mid Ax \leq b\}$. For general polytopes, this problem can be solved by the *double description method* [MRTT53], or by the *reverse search method* due Avis and Fukuda [AF92], with its subsequent improvement [Avi00]. For the special case where P is a 0/1-polytope, i.e., all vertex coordinates are from $\{0, 1\}$, Bussieck and Lübbecke [BL98] described an algorithm for generating the vertices of P with delay $\mathcal{O}(t_{\text{LP}} n)$, where t_{LP} is the time needed to solve the linear program (LP) $\min\{w \cdot x \mid Ax \leq b\}$. Furthermore, the space required by their algorithm is the space needed to solve the LP. Behle and Eisenbrand [BE07] described an algorithm for vertex enumeration of 0/1-polytopes that uses binary decision diagrams, which performs well in practice, but requires exponential space in the worst case.

Algorithm P improves upon Bussieck and Lübbecke’s algorithm in that the delay is reduced from $\mathcal{O}(t_{\text{LP}} n)$ to $\mathcal{O}(t_{\text{LP}} \log n)$ per generated vertex (Corollary 29). As an additional feature, the vertices are visited in the order of a Hamilton path on the polytope’s skeleton, whereas the earlier algorithm does not have this property. The space required by our algorithm is only the space needed to solve the LP. We can also generate all vertices that are c -optimal w.r.t. some arbitrary integer-valued cost vector $c \in \mathbb{Z}^n$, with delay $\mathcal{O}(t_{\text{LP}} \text{poly}(\log n))$ per vertex (Corollary 30).

1.6.2. *Bases and independent sets in matroids.* Algorithm P allows generating the bases of any matroid, by computing a Hamilton path on the base polytope. The delay is $\mathcal{O}(t_{\text{LO}} \log n)$, where n is the number of elements in the matroid, and t_{LO} is the time to solve the linear optimization problem (problem LO defined in Section 1.5) for the bases of the matroid. It is the first polynomial delay algorithm known for the weighted variant of the problem with cost vector c . Our algorithm can be specialized to generate bases of a graphic matroid, i.e., spanning trees of a graph (Corollaries 31 and 32), or bases of the uniform matroid, i.e., fixed-size subsets of an n -element ground set, also known as combinations. Analogous statements hold for independent sets of a matroid, and the corresponding specialization to the graphic case, namely forests of a graph.

1.6.3. *More graph objects.* We provide the first polynomial delay algorithms for generating matchings, maximum matchings, and c -optimal matchings in general graphs (Corollaries 33, 34, and 35, respectively). The obtained listings correspond to a Hamilton path on the matching polytope. We also provide the first polynomial delay algorithms for generating vertex covers, minimum vertex covers, and c -optimal vertex covers in bipartite graphs. The generated listings correspond to a Hamilton path on the vertex cover polytope. The space required by our algorithms is only the space required for solving the corresponding optimization problems, i.e., polynomial in the size of the graph. As the complement of a vertex cover is a stable (=independent) set, we also obtain efficient algorithms for generating stable sets, maximum stable sets and c -optimal stable sets in bipartite graphs, by traversing the stable set polytope.

1.6.4. *Poset objects.* We provide the first polynomial delay algorithms for generating antichains, maximum antichains, c -optimal antichains, and c -optimal ideals of a poset. The listings of objects correspond to Hamilton paths on the chain polytope and order polytope, respectively.

¹Throughout this paper we use the term ‘generation’ instead of ‘enumeration’, but since ‘vertex enumeration’ is a standard term in the polytope community, we stick to it here.

The space required by our algorithms is the space for solving the corresponding optimization problems, i.e., polynomial in the size of the poset.

1.7. Related work. Theorem 1 implies that for any 0/1-polytope P and any of its vertices, there is a Hamilton path on the skeleton of P starting at that vertex. Naddef and Pulleyblank [NP84] proved a considerable strengthening of this result. Specifically, they showed that the skeleton of any 0/1-polytope is either a hypercube and therefore Hamilton-laceable, or it is Hamilton-connected. A graph is *Hamilton-connected* if it admits a Hamilton path between any two distinct vertices, and a bipartite graph is *Hamilton-laceable* if it admits a Hamilton path between any two vertices from distinct partition classes. The Naddef-Pulleyblank construction is inductive, but it does not translate into an efficient algorithm, as the size of the skeleton is typically exponential; recall Table 2.

Conte, Grossi, Marino, Uno and Versari [CGM⁺22] recently presented a modification of reverse search called *proximity search*, which yields polynomial delay algorithms for generating several classes of objects defined by inclusion-maximal subgraphs of a given graph, specifically maximal bipartite subgraphs, maximal degenerate subgraphs, maximal induced chordal subgraphs etc. Their approach is based on traversing a suitable defined low-degree flip graph on top of the graph objects that is then traversed by backtracking. A disadvantage of their approach is that it requires exponential space to store previously visited objects along the flip graph, unlike Algorithm P which can be implemented with linear space. Also, there is no polyhedral interpretation of their method, in particular the generated listings of objects are not Gray codes.

1.8. Outline of this paper. In Section 2 we collect some notations that will be used throughout this paper. In Section 3 we present a simple greedy algorithm for computing a Hamilton path in a graph whose vertex set is a set of bitstrings. In Section 4 we consider Hamilton paths with special properties that this algorithm can compute successfully. In Section 5 we introduce a class of graphs called *prefix graphs* which admit such Hamilton paths, and we provide a history-free implementation of the basic greedy algorithm for computing a Hamilton path in those graphs. In Section 6 we show that skeleta of 0/1-polytopes are prefix graphs, and we specialize the earlier results and algorithms to the case of 0/1-polytopes. We also reduce the computational problems for our history-free algorithm to instances of linear optimization with or without prescription. The results listed in the last column of Table 1 are derived from our general theorems in Section 7. In Section 8, we discuss the relation between our generation framework and the one presented in [HHMW22], and we conclude in Section 9 with some open questions.

2. PRELIMINARIES

For a graph $G = (X, E)$ and a vertex $x \in X$ we write $E(x)$ for the set of neighbors of x in G .

We write ε for the empty bitstring. Also, for any bitstring x we write \bar{x} for the complemented string. For any two bitstrings x and y we write xy for the concatenation of x and y . Given a sequence $L = x_1, \dots, x_\ell$ of bitstrings and a bitstring y , we also define $Ly := x_1y, \dots, x_\ell y$. For any nonempty bitstring x we write x^- for the string obtained from x by deleting the last bit. Furthermore, for a set $X \subseteq \{0, 1\}^n$ we define $X^- := \{x^- \mid x \in X\} \subseteq \{0, 1\}^{n-1}$ and for any sequence $L = x_1, \dots, x_\ell$ of bitstrings we define $L^- := x_1^-, \dots, x_\ell^-$. For any set $X \subseteq \{0, 1\}^n$ and $b \in \{0, 1\}$ we define $X^b := \{x \in \{0, 1\}^n \mid x_n = b\}$. Similarly, for any sequence L of bitstrings of length n and $b \in \{0, 1\}$ we write L^b for the subsequence of strings in L that end with b .

For any predicate P and any real-valued function f defined on the set of objects X satisfying the predicate P , we write $\operatorname{argmin}[P(x) \mid f(x)] := \operatorname{argmin}_{P(x)} f(x)$ for the minimizers of f on X . This notation without subscripts is convenient for us, as the predicates we need are complicated,

so printing these long expressions as subscripts would make the formulas too unwieldy. Our new notation is typographically ‘dual’ to the minimum values $\min\{f(x) \mid P(x)\}$.

3. BINARY GRAPHS AND A SIMPLE GREEDY ALGORITHM

A *binary graph* is a graph $G = (X, E)$ such that $X \subseteq \{0, 1\}^n$ for some integer n . In our applications, the graph G is typically given implicitly, using a description of size polynomial in n , whereas the size of G will be exponential in n . Examples for such graphs are the skeletons of the polytopes listed in Table 2, which are described by the parameter listed in the first column. In the setting of Gray codes, one routinely obtains binary graphs by taking X as the set of binary strings that encodes some class of combinatorial objects, and by taking E as the pairs of objects that differ in some local changes, for example by a certain Hamming distance or by certain operations on the bitstrings like transpositions, substring shifts, or reversals.

In the following we introduce a simple greedy algorithm to compute a Hamilton path in any binary graph $G = (X, E)$, where $X \subseteq \{0, 1\}^n$.

Algorithm G starts at some initial vertex $\tilde{x} \in X$, and then repeatedly moves from the current vertex x to a neighboring vertex y that has not been visited before and that minimizes $\lambda(x, y)$ (recall the definition from Section 1.4), i.e., the algorithm greedily minimizes the lengths of the modified prefixes. If all neighbors of x have been visited, the algorithm terminates. By definition, the algorithm never visits a vertex twice, i.e., it always computes a path in G . However, it might terminate before having visited all vertices, i.e., the computed path may not be a Hamilton path.

Algorithm G (*Shortest prefix changes*). This algorithm attempts to greedily compute a Hamilton path in a binary graph $G = (X, E)$, where $X \subseteq \{0, 1\}^n$, starting from an initial vertex \tilde{x} .

G1. [Initialize] Set $x \leftarrow \tilde{x}$.

G2. [Visit] Visit x .

G3. [Shortest prefix neighbors] Compute the set N of unvisited neighbors y of x in G that minimize $\lambda(x, y)$, i.e., $N \leftarrow \operatorname{argmin}[y \in E(x) \wedge y \text{ unvisited} \mid \lambda(x, y)]$. Terminate if $N = \emptyset$.

G4. [Tiebreaker+update x] Pick any vertex $y \in N$, set $x \leftarrow y$ and goto G2.

If the set N of unvisited neighbors encountered in step G4 contains more than one element, then we have freedom to pick an arbitrary vertex $y \in N$. A tiebreaking rule may involve lexicographic comparisons between vertices in N , or their Hamming distance from x .

Note that Algorithm G operates completely locally based on the current neighborhood and never uses global information. Also note that a naive implementation of Algorithm G may require exponential space to maintain the list of previously visited vertices, in order to be able to compute the set N in step G3. We will show that in many interesting cases, we can make the algorithm history-free, i.e., by introducing suitable additional data structures, we can entirely avoid storing any previously visited vertices.

4. GENLEX ORDER

In this section, we provide a simple sufficient condition for when Algorithm G succeeds to compute a Hamilton path in a binary graph. Specifically, these are binary graphs that admit a Hamilton path satisfying a certain ordering property. We also establish important optimality properties for such orderings.

Let $X \subseteq \{0, 1\}^n$. An *ordering* of X is a sequence L that contains every element of X exactly once. Furthermore, an ordering L of X is called *genlex*, if all bitstrings with the same suffix

appear consecutively in L . An equivalent recursive definition of genlex order is as follows: The ordering L is genlex, if $L = L^0, L^1$ or $L = L^1, L^0$, and the sequences L^{0-} and L^{1-} are in genlex order.

Colexicographic order is a special case of genlex order in which only the case $L = L^0, L^1$ occurs, i.e., all strings with suffix $0x$ appear before all strings with suffix $1x$, for any $x \in \{0, 1\}^k$. In the literature, genlex orderings are sometimes referred to as *suffix-partitioned* [Wal03]. Our notion of genlex ordering is with respect to suffixes, but of course it could also be defined with respect to prefixes instead, generalizing lexicographic order, and such an ordering is sometimes called *prefix-partitioned* in the literature. Unlike lexicographic order or colexicographic order, which is unique for a given X , there can be many distinct genlex orderings for X .

We associate any ordering $L = x_1, \dots, x_\ell$ of X with a cost, defined by

$$c(L) := \sum_{i=1, \dots, \ell-1} \lambda(x_i, x_{i+1}), \quad (2)$$

which is the sum of lengths of prefixes that get modified in the ordering. Genlex orderings are characterized by the property that they minimize this cost among all possible orderings.

Lemma 2. *Let L and L' be two orderings of $X \subseteq \{0, 1\}^n$. If L is genlex, then we have $c(L) \leq c(L')$. This inequality is strict if L' is not genlex.*

Lemma 2 implies in particular that all genlex orderings of X have the same cost.

Proof. Let L' be any ordering, and assume w.l.o.g. that $L' = A0, B1, C0, D$, where the sequences A, B, C are nonempty, but D may be empty, i.e., the last bit changes at least twice in L . Furthermore, we choose the subsequence C maximally, i.e., if D is nonempty, then its first bitstring ends with 1. Consider the sequence $L := A0, C0, B1, D$, obtained from L' by swapping the order of the blocks $B1$ and $C0$. If D is empty, then $c(L) < c(L')$, as the transition to the first bitstring of $C0$ costs n in L' but strictly less in L . If D is nonempty, then we also have $c(L) < c(L')$, as the transition to the first bitstring of D costs n in L' but strictly less in L . We can repeatedly apply such exchange operations to reduce the total cost until the resulting ordering is genlex.

Note that if L is a genlex ordering, then $c(L) = c(L^{0-}) + c(L^{1-}) + n$, where the $+n$ comes from the transition between the two blocks L^0 and L^1 . By induction this implies that all genlex orderings have the same cost.

Combining these two arguments proves the lemma. \square

The next two lemmas capture further important properties of genlex orderings.

Lemma 3. *Let $L = x_1, \dots, x_\ell$ be a genlex ordering of $X \subseteq \{0, 1\}^n$. For any two indices $i, j \in [\ell]$ with $i < j$ we have $\lambda(x_i, x_{i+1}) \leq \lambda(x_i, x_j)$.*

Proof. For the sake of contradiction, suppose that there are indices $i, j \in [\ell]$ with $i < j$ such that $\lambda(x_i, x_{i+1}) > \lambda(x_i, x_j)$. Thus, the longest common suffix s of x_i and x_j has length $n - \lambda(x_i, x_j)$. Similarly, the longest common suffix of x_i and x_{i+1} has length $n - \lambda(x_i, x_{i+1}) < n - \lambda(x_i, x_j)$. In particular, s is not a suffix of x_{i+1} . Consequently, the bitstrings with suffix s do not appear consecutively in L , a contradiction. \square

Lemma 4. *Let $L = x_1, \dots, x_\ell$ be a genlex ordering of $X \subseteq \{0, 1\}^n$. For any three indices $i, j, k \in [\ell]$ with $i < j < k$ we have $\lambda(x_i, x_j) \neq \lambda(x_j, x_k)$.*

Proof. For the sake of contradiction, suppose that there are indices $i, j, k \in [\ell]$ with $i < j < k$ such that $\lambda(x_i, x_j) = \lambda(x_j, x_k)$. Thus, x_i, x_j and x_k have a common suffix s of length $n - \lambda(x_i, x_j) =$

$n - \lambda(x_j, x_k)$. Furthermore, x_i and x_j disagree in the bit to the left of this suffix (at position $\lambda(x_i, x_j) - 1 = \lambda(x_j, x_k) - 1$), and x_j and x_k disagree in this bit, which implies that x_i and x_k agree in this bit b . But this means that the bitstrings with suffix bs do not appear consecutively in L , a contradiction. \square

We now establish that Algorithm G presented in the previous section, equipped with a suitable tiebreaking rule, generates any genlex Hamilton path. This provides a simple sufficient condition for when the algorithm succeeds to compute a Hamilton path in a given binary graph. Note that any ordering $L = x_1, \dots, x_\ell$ of $X \subseteq \{0, 1\}^n$ defines a tiebreaking rule τ_L that for any given set $N \subseteq X$ returns the element from N that appears first in L . Formally, if N has size s then there are indices $i_1 < \dots < i_s$ such that $N = \{x_{i_1}, \dots, x_{i_s}\}$, and we define $\tau_L(N) := x_{i_1}$.

Theorem 5. *Let $G = (X, E)$ be a binary graph that admits a genlex Hamilton path $L = x_1, \dots, x_\ell$. Then Algorithm G with tiebreaking rule τ_L and initial vertex $\tilde{x} := x_1$ computes the path L .*

Proof. We prove by induction that for all $i = 1, \dots, \ell$, in the i th iteration of Algorithm G it will visit the vertex x_i . For $i = 1$ this is clear by the initialization with $\tilde{x} := x_1$. For the induction step let $i > 1$. The vertex x_i is computed in lines G3 and G4 at the end of the $(i - 1)$ st iteration of the algorithm. At this point, the visited vertices are x_1, \dots, x_{i-1} in this order, i.e., x_i is unvisited. Furthermore, x_i is a neighbor of x_{i-1} in G by the assumption that L is a Hamilton path, i.e., $x_i \in E(x_{i-1})$. Furthermore, by Lemma 3, x_i minimizes $\lambda(x_{i-1}, y)$ among all unvisited neighbors y of x_{i-1} . Consequently, we have $x_i \in N$, i.e., x_i is contained in the set N computed in step G3. As N contains only unvisited vertices, the tiebreaking rule τ_L indeed selects $x \leftarrow x_i$ as the next vertex in step G4. \square

Remark 6. Williams [Wil13] pioneered the greedy method as a general paradigm to reinterpret known Gray codes and to derive new ones. Specifically, in his paper he found greedy interpretations of the classical binary reflected Gray code, the Steinhaus-Johnson-Trotter listing of permutations by adjacent transpositions, the Ord-Smith/Zaks [Ord67, Zak84] ordering of permutations by prefix reversals, and for the rotation Gray code for binary trees due to Lucas, Roelants van Baronaigien, and Ruskey [LRvBR93].

The greedy method has also been very useful in discovering new Gray codes for (generalized) permutations [SW16, CSW21], for spanning trees of special graphs [CGS21], and for spanning trees of arbitrary graphs and more generally bases of any matroid [MMW22]. Also, the permutation-based framework for combinatorial generation proposed by Hartung, Hoang, Mütze and Williams [HHMW22] relies on a simple greedy algorithm.

Theorem 5 now provides us with an explanation for the success of the greedy method. Furthermore, the recent survey [Müt22] lists a large number of Gray codes from the literature that have the genlex property (there are more than 50 occurrences of the word ‘genlex’), and all of those can now be interpreted as the result of a simple algorithm that greedily minimizes the lengths of modified prefixes in each step.

Remark 7. Admittedly, one can consider the proof of Theorem 5 as ‘cheating’, as it builds knowledge about L into the tiebreaking rule τ_L of the algorithm, knowledge that one typically does not have when the goal is to come up with an algorithm to produce a listing L in the first place. Consequently, in practice the challenge is to come up with a tiebreaking rule that uses only local information about the neighborhood of the current vertex x and that can be computed efficiently. In some cases, discussed in the next section, we are in the even better position that Algorithm G works for *any* choice of tiebreaking rule, which gives dramatic additional flexibility.

5. PREFIX GRAPHS AND HISTORY-FREE IMPLEMENTATION

In this section, we exhibit a class of binary graphs for which Algorithm G succeeds for *any* tiebreaking rule, and for *any* choice of initial vertex \tilde{x} . Furthermore, for these binary graphs we can implement Algorithm G in a history-free way, i.e., without maintaining the list of all previously visited vertices, by maintaining some simple additional data structures. Furthermore, we will formulate two auxiliary problems that, when solved efficiently, imply that Algorithm G runs with short delay between consecutively visited vertices. In later sections, we will solve these auxiliary problems by combinatorial optimization methods.

5.1. Prefix graphs. For a binary graph $G = (X, E)$, where $X \subseteq \{0, 1\}^n$, and for $b \in \{0, 1\}$ we define $G^{b-} := (X^{b-}, E^{b-})$ with $E^{b-} := \{(x, y) \mid x, y \in X^{b-} \text{ and } (xb, yb) \in E\}$. We say that $G = (X, E)$ is a *prefix graph* if $X = \emptyset$, or $n = 0$ and $X = \{\varepsilon\}$, or $n > 0$ and the following two conditions hold:

- (p1) G^{0-} and G^{1-} are prefix graphs;
- (p2) If X^0 and X^1 are both nonempty, then for any $b \in \{0, 1\}$ and for every vertex $x \in X^b$ there exists a vertex $y \in X^{\bar{b}}$ such that $(x, y) \in E$.

Even though the condition (p2) may seem rather restrictive, we will see that many interesting binary graphs are indeed prefix graphs. In particular, the skeleton of *any* 0/1-polytope is a prefix graph; see Lemma 15 below.

Lemma 8. *For any prefix graph $G = (X, E)$ and any vertex $\tilde{x} \in X$, there is a genlex Hamilton path in G starting at \tilde{x} .*

Proof. We argue by induction on n . The base case $n = 0$ holds trivially. For the induction step we assume that $n > 0$. We assume without loss of generality that \tilde{x} has last bit 0, as the other case is symmetric. By this assumption X^0 and G^{0-} are nonempty. From condition (p1) of prefix graphs we obtain that G^{0-} is a prefix graph, so by induction there is a genlex Hamilton path L in G^{0-} starting at \tilde{x}^- . Let x' be the last vertex of L . If X^1 is empty, then $L0$ is a genlex Hamilton path in G and we are done. Otherwise, G^{1-} is nonempty. From condition (p1) we obtain that G^{1-} is a prefix graph. Furthermore, from condition (p2) we obtain that there is a vertex $\tilde{y} \in X^1$ such that $(x'0, \tilde{y}) \in E$. Therefore, by induction there is a genlex Hamilton path M in G^{1-} starting at \tilde{y}^- . The concatenation $L0, M1$ is the desired genlex Hamilton path in G . \square

Our next theorem strengthens Lemma 8 and makes it algorithmic. This fundamental theorem asserts that Algorithm G succeeds to compute a Hamilton path on *any* prefix graph, *regardless* of the choice of tiebreaking rule, and *regardless* of the choice of initial vertex. The importance of this result can hardly be overstated, as it gives us dramatic flexibility in many applications.

Theorem 9. *Let $G = (X, E)$ be a prefix graph. For any tiebreaking rule and any initial vertex \tilde{x} , Algorithm G computes a genlex Hamilton path on G starting at \tilde{x} .*

The proof follows the same strategy as the proof of Lemma 8.

Proof. We argue by induction on n . The base case $n = 0$ holds trivially. For the induction step we assume that $n > 0$. We assume without loss of generality that \tilde{x} has last bit 0, as the other case is symmetric. By this assumption X^0 and G^{0-} are nonempty. From condition (p1) of prefix graphs we obtain that G^{0-} is a prefix graph, so by induction Algorithm G with input G^{0-} computes a genlex Hamilton path L in G^{0-} starting at \tilde{x}^- . Let x' be the last vertex of L . Observe that Algorithm G with input G produces the path $L0$, whose last vertex is $x'0$, and we

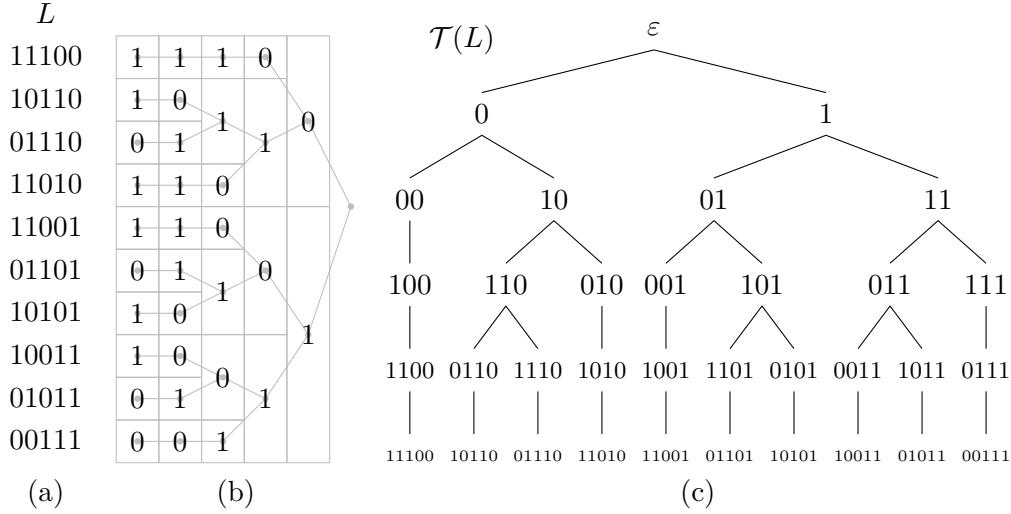

FIGURE 5. (a) A genlex ordering L of all bitstrings of length 5 with three 1s. (b) The binary tree structure in L . (c) The corresponding suffix tree $\mathcal{T}(L)$.

now consider the iteration of the algorithm where the vertex $x'0$ is visited. After visiting $x'0$ all vertices of X^0 have been visited. If X^1 is empty, then the set N computed in step G3 is empty, the algorithm terminates and we are done. Otherwise, G^{1-} is nonempty. From condition (p1) we obtain that G^{1-} is a prefix graph. Furthermore, from condition (p2) we obtain that there is a vertex $y \in X^1$ such that $(x'0, y) \in E$, i.e., we have $y \in E(x'0)$. Furthermore, y is unvisited, as its last bit equals 1 and therefore $y \in N$, implying that $N \neq \emptyset$. Consequently in step G4 the algorithm moves to some vertex $\tilde{y} \in N \subseteq X^1$, which is true regardless of the tiebreaking rule being used. We know by induction that Algorithm G with input G^{1-} computes a genlex Hamilton path M in G^{1-} starting at \tilde{y}^- . From this we conclude that Algorithm G with input G computes the genlex Hamilton path $L0, M1$. \square

5.2. Suffix trees and branchings. We now describe how to equip Algorithm G with additional data structures so that it does not need to store any previously visited vertices.

The key observation is that the suffixes of any genlex ordering form binary tree structure. Formally, let L be a genlex ordering of a set $X \subseteq \{0, 1\}^n$. The *suffix tree* $\mathcal{T}(L)$ is an ordered rooted tree whose vertices are all possible suffixes of X , with the following adjacencies; see Figure 5:

- the empty suffix ε is the root of $\mathcal{T}(L)$;
- for every suffix s of length k , its children in $\mathcal{T}(L)$ are the suffixes of length $k + 1$ that have s as a common suffix, and the order of children from left to right corresponds to the order of the suffixes in L .

Note that the set of leaves of $\mathcal{T}(L)$ equals X , and the sequence of leaves in $\mathcal{T}(L)$ from left to right equals L . Furthermore, every vertex in $\mathcal{T}(L)$ has either one or two children.

When producing a genlex ordering L , Algorithm G traverses the leaves of the suffix tree $\mathcal{T}(L)$. To obtain a history-free implementation, it is enough to store information about the current leaf and the branchings on the path from that leaf to the root. Formally, for any $x \in X$ we define

$$B(x) := \{\lambda(x, y) \mid y \in X - x\},$$

and we refer to $B(x)$ as the set of *branchings of x* . This definition is independent of L and hence of $\mathcal{T}(L)$. Note however that in any suffix tree $\mathcal{T}(L)$ and for any leaf $x \in X$, we have $i \in B(x)$ if

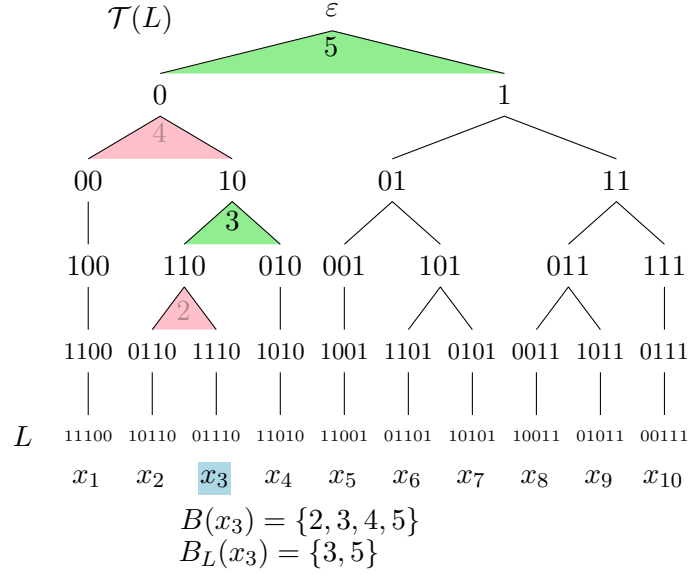

FIGURE 6. Illustration of branchings and unseen branchings for the vertex x_3 in the suffix tree from Figure 5.

and only if the node in distance i from x in $\mathcal{T}(L)$ (which has depth $n - i$ in the tree) has two children; see Figure 6.

For a genlex ordering $L = x_1, \dots, x_\ell$ of X and any $i \in [\ell]$, we define the set of *unseen branchings of x_i w.r.t. L* as

$$B_L(x_i) := \{\lambda(x_i, x_j) \mid i < j \leq \ell\} \subseteq B(x_i). \quad (3)$$

These are branchings in $\mathcal{T}(L)$ that lead to children that are visited after x_i in L ; see Figure 6.

The next lemma states two important properties about the quantities defined before.

Lemma 10. *Let $L = x_1, \dots, x_\ell$ be a genlex ordering of $X \subseteq \{0, 1\}^n$. For every $1 \leq i < \ell$ the minimum unseen branching $\beta := \min B_L(x_i)$ satisfies the following properties:*

- (i) *for every $x_j \in X - x_i$ with $\lambda(x_i, x_j) = \beta$ we have $j > i$;*
- (ii) *we have $B_L(x_i) \setminus \{\beta\} = B_L(x_{i+1}) \setminus [\beta]$.*

Proof. To prove (i), suppose for the sake of contradiction that there is some $x_j \in X - x_i$ with $\lambda(x_i, x_j) = \beta$ and $j < i$. Then we have $j < i < i + 1$ with $\lambda(x_j, x_i) = \lambda(x_i, x_{i+1}) = \beta$, contradicting Lemma 4.

To prove (ii), let $j > i + 1$ be such that $\lambda(x_{i+1}, x_j) > \lambda(x_i, x_{i+1}) = \beta$. It follows that the longest common suffix of x_i and x_{i+1} properly contain the longest common suffix of x_{i+1} and x_j . Hence, the longest common suffix of x_{i+1} and x_j is also the longest common suffix of x_i and x_j . Consequently, we have $\lambda(x_i, x_j) = \lambda(x_{i+1}, x_j)$ for every $j > i + 1$ such that $\lambda(x_{i+1}, x_j) > \lambda(x_i, x_{i+1}) = \beta$. Also note that $\beta \notin B_L(x_{i+1})$, as otherwise there would be $j > i + 1$ such that $\lambda(x_i, x_{i+1}) = \lambda(x_{i+1}, x_j)$, contradicting Lemma 4. Combining these two observations proves (ii). \square

5.3. History-free implementation. An *interval* is a subset of consecutive natural numbers. For any interval $I \subseteq [n]$ we define

$$\lambda_I(x, y) := \begin{cases} \lambda(x, y) & \text{if } \lambda(x, y) \in I, \\ \infty & \text{otherwise.} \end{cases}$$

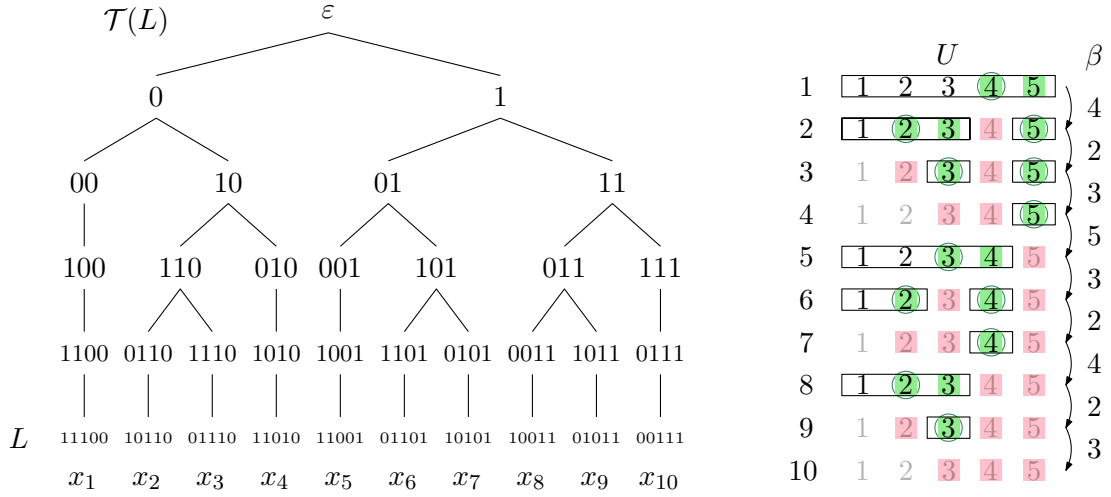

FIGURE 7. The state of the variables U and β of Algorithm G^* while traversing the genlex tree from Figure 5. Each interval I on the stack U is indicated by a box. Every branching is highlighted by a shaded square, with unseen branchings printed black and the others grayed out. Furthermore, the minimum unseen branching in each interval is circled.

Note that we have $\lambda_{[n]}(x, y) = \lambda(x, y)$.

To make Algorithm G history-free, we need to get rid of the qualification ‘ y unvisited’ in the computation of the set N in line G3. This is achieved in Algorithm G^* stated below, which takes as input a binary graph $G = (X, E)$, where $X \subseteq \{0, 1\}^n$. The algorithm keeps track of the unseen branchings of the current vertex x by maintaining a stack U of disjoint intervals that cover all unseen branchings of x , with the property that each interval I on the stack contains at least one unseen branching of x . The intervals appear on the stack U from left (top of the stack) to right (bottom of the stack), and for each interval I on the stack, the variable β_I stores the minimum unseen branching in I , i.e., we have $\beta_I = \min\{\lambda_I(x, y) \mid y \in X - x\}$. Note here Lemma 10 (i), so no extra qualification ‘ y unvisited’ is needed in this minimization. There might be more than one unseen branching in I , but only the minimum one is stored in β_I .

Algorithm G^* (*History-free shortest prefix changes*). This algorithm attempts to greedily compute a Hamilton path in a binary graph $G = (X, E)$, where $X \subseteq \{0, 1\}^n$, starting from an initial vertex \tilde{x} .

G1. [Initialize] Set $x \leftarrow \tilde{x}$ and call **branching**($[n]$).

G2. [Visit] Visit x .

G3. [Min. unseen branching] Terminate if U is empty. Otherwise set $I \leftarrow U.\text{pop}()$ and $\beta \leftarrow \beta_I$.

G4. [Shortest prefix neighbors] Compute the set N of neighbors y of x in G with $\lambda(x, y) = \beta$, i.e., $N \leftarrow \{y \in E(x) \mid \lambda(x, y) = \beta\}$.

G5. [Tiebreaker+update x] Pick any vertex $y \in N$ and set $x \leftarrow y$.

G6. [Update U] Call **branching**($I \setminus [\beta]$) and **branching**($[\beta - 1]$), and goto G2.

Algorithm G^* calls the following auxiliary function to update the stack U for a given interval I . This function reads the current vertex x and if the given interval I contains an unseen branching it modifies the variables β_I and U .

branching(I): Compute $\beta \leftarrow \min\{\lambda_I(x, y) \mid y \in X - x\}$. If $\beta < \infty$ set $\beta_I \leftarrow \beta$ and $U.\text{push}(I)$.

The stack U is initialized in step G1, the leftmost interval I containing the minimum unseen branching β_I of the current vertex x is retrieved from the stack in step G3, and the stack is updated in step G6. The correctness of these updates follows from Lemma 10 (i)+(ii).

It remains to argue that the set N of neighbors computed in step G3 of Algorithm G is the same as the set N computed in step G4 of Algorithm G*. Indeed, we have

$$\begin{aligned} N &= \operatorname{argmin}[y \in E(x) \wedge y \text{ unvisited} \mid \lambda(x, y)] \\ &= \{y \in E(x) \wedge y \text{ unvisited} \mid \lambda(x, y) = \beta\} \\ &= \{y \in E(x) \mid \lambda(x, y) = \beta\}, \end{aligned}$$

where the quantity β is the minimum unseen branching of the current vertex x defined in line G3 of Algorithm G*, and in the last step we use Lemma 10 (i).

Summarizing these observations we obtain the following result.

Theorem 11. *Let $G = (X, E)$ be a binary graph that admits a genlex Hamilton path $L = x_1, \dots, x_\ell$. Then Algorithm G* with tiebreaking rule τ_L and initial vertex $\tilde{x} := x_1$ produces the same output as Algorithm G, namely the path L .*

Combining this result with Theorem 9, we obtain the following.

Theorem 12. *Let $G = (X, E)$ be a prefix graph. For any tiebreaking rule and any initial vertex \tilde{x} , Algorithm G* computes a genlex Hamilton path on G starting at \tilde{x} .*

5.4. Two auxiliary problems. From the pseudocode of Algorithm G* we can extract the following two computational problems, which, if solved efficiently, directly lead to an efficient algorithm for computing a Hamilton path in any prefix graph:

- A** Given a set $X \subseteq \{0, 1\}^n$, an element $x \in X$ and an interval $I \subseteq [n]$, compute $\min\{\lambda_I(x, y) \mid y \in X - x\}$.
- B** Given a binary graph $G = (X, E)$, where $X \subseteq \{0, 1\}^n$, an element $x \in X$ and an integer $\beta \in [n]$ with $N := \{y \in E(x) \mid \lambda(x, y) = \beta\} \neq \emptyset$, compute an element in N .

We note that in both problems, the set X of bitstrings may be given implicitly via some other parameter; recall Table 2.

Theorem 13. *Let $G = (X, E)$ be a prefix graph, and suppose that problems A and B can be solved in time t_A and t_B , respectively. Then for any tiebreaking rule and any initial vertex \tilde{x} , Algorithm G* computes a genlex Hamilton path on G starting at \tilde{x} with delay $\mathcal{O}(t_A + t_B)$.*

The initialization time of Algorithm G* is $\mathcal{O}(t_A)$, which is majorized by the delay $\mathcal{O}(t_A + t_B)$, and the required space is the sum of the space needed to solve problems A and B.

Proof. This is immediate from Theorem 12 and the fact that each iteration of Algorithm G* consists of solving constantly many instances of problems A and B. \square

6. A BRIDGE TO COMBINATORIAL OPTIMIZATION

In this section, we consider 0/1-polytopes, i.e., polytopes that arise as the convex hull $\operatorname{conv}(X)$ of a set of binary strings $X \subseteq \{0, 1\}^n$. We first show that the skeleton of any 0/1-polytope is a prefix graph. Furthermore, we show that problems A and B reduce to solving a particular linear optimization problem on the polytope (recall Section 1.5). Consequently, if we can solve this optimization problem efficiently, then we obtain an efficient algorithm for computing a Hamilton path on the skeleton of the polytope.

6.1. Skeleta of 0/1-polytopes are prefix graphs. Recall the definition of Hamming distance $d(x, y)$ from Section 1.4.

Lemma 14 ([NP81, Proposition 2.3]). *Let P be a 0/1-polytope and let $G = (X, E)$ with $X \subseteq \{0, 1\}^n$ be its skeleton. Suppose that X^0 and X^1 are both nonempty, and let x be a vertex of X^b for some $b \in \{0, 1\}$. If a vertex $y \in X^{\bar{b}}$ minimizes $d(x, y)$, then we have $(x, y) \in E$.*

We apply Lemma 14 to prove that the skeleton of any 0/1-polytope is a prefix graph.

Lemma 15. *Let P be a 0/1-polytope and let G be its skeleton. Then G is a prefix graph.*

Proof. Let $G = (X, E)$ with $X \subseteq \{0, 1\}^n$, i.e., $P = \text{conv}(X)$. We argue by induction on n . The induction basis $n = 0$ is trivial. For the induction step we assume that $n > 0$. For $b \in \{0, 1\}$ we define $P^{b-} := \text{conv}(X^{b-})$, and we observe that G^{b-} is the skeleton of P^{b-} . By induction, we obtain that G^{0-} and G^{1-} are prefix graphs, so condition (p1) in the definition given in Section 5.1 is satisfied. It remains to prove property (p2), under the assumption that X^0 and X^1 are both nonempty. Let $b \in \{0, 1\}$, consider any vertex $x \in X^b$, and let $y \in X^{\bar{b}}$ be such that $d(x, y)$ is minimized. Then Lemma 14 shows that $(x, y) \in E$, and the lemma follows. \square

6.2. History-free version of Algorithm P. We obtain the remarkable consequence that Algorithm G or Algorithm G* compute a Hamilton path on the skeleton of *any* 0/1-polytope, *regardless* of the choice of tiebreaking rule, and *regardless* of the choice of initial vertex.

Theorem 16. *Let P be a 0/1-polytope and let G be its skeleton. For any tiebreaking rule and any initial vertex \tilde{x} , Algorithm G or Algorithm G* compute a genlex Hamilton path on G starting at \tilde{x} .*

Proof. Combine Lemma 15 with Theorems 9 and 12. \square

For 0/1-polytopes, we can specialize Algorithm G* further, and remove any references to its skeleton by slightly modifying line G4. Specifically, by Lemma 14 any vertex with minimum Hamming distance from the current vertex x is a neighbor on the skeleton, i.e., we have

$$\{y \in E(x) \mid \lambda(x, y) = \beta\} \supseteq \operatorname{argmin}[y \in X - x \wedge \lambda(x, y) = \beta \mid d(x, y)] \neq \emptyset.$$

This modification yields the following Algorithm P*. In step P5 we may still encounter ties, i.e., $|N| > 1$, which can again be broken arbitrarily.

Algorithm P* (*History-free traversal of 0/1-polytope by shortest prefix changes*). For a set $X \subseteq \{0, 1\}^n$, this algorithm greedily computes a Hamilton path on the skeleton of the 0/1-polytope $\text{conv}(X)$, starting from an initial vertex \tilde{x} .

P1. [Initialize] Set $x \leftarrow \tilde{x}$ and call **branching**($[n]$).

P2. [Visit] Visit x .

P3. [Min. unseen branching] Terminate if U is empty. Otherwise set $I \leftarrow U.\text{pop}()$ and $\beta \leftarrow \beta_I$.

P4. [Closest vertices] Compute the set N of vertices y with $\lambda(x, y) = \beta$ of minimum Hamming distance from x , i.e., $N \leftarrow \operatorname{argmin}[y \in X - x \wedge \lambda(x, y) = \beta \mid d(x, y)]$.

P5. [Tiebreaker+update x] Pick any vertex $y \in N$ and set $x \leftarrow y$.

P6. [Update U] Call **branching**($I \setminus [\beta]$) and **branching**($[\beta - 1]$), and goto P2.

The corresponding specialization of Theorem 17 reads as follows, which establishes Theorem 1 stated in Section 1.4. Note that Algorithm P* is the history-free implementation of Algorithm P stated there.

Theorem 17. *Let $X \subseteq \{0, 1\}^n$. For any tiebreaking rule and any initial vertex \tilde{x} , Algorithm P* computes a genlex Hamilton path on the skeleton of $\text{conv}(X)$ starting at \tilde{x} .*

Furthermore, the auxiliary problem B introduced in Section 5.4 can be specialized for Algorithm P* as follows:

C Given a set $X \subseteq \{0, 1\}^n$, an element $x \in X$ and an integer $\beta \in [n]$ with $N := \text{argmin}[y \in X - x \wedge \lambda(x, y) = \beta \mid d(x, y)] \neq \emptyset$, compute an element in N .

We thus obtain the following specialization of Theorem 13.

Theorem 18. *Let $X \subseteq \{0, 1\}^n$, and suppose that problems A and C can be solved in time t_A and t_C , respectively. Then for any tiebreaking rule and any initial vertex \tilde{x} , Algorithm P* computes a genlex Hamilton path on the skeleton of $\text{conv}(X)$ starting at \tilde{x} with delay $\mathcal{O}(t_A + t_C)$.*

The initialization time of Algorithm P* is $\mathcal{O}(t_A)$, which is majorized by the delay $\mathcal{O}(t_A + t_C)$, and the required space is the sum of the space needed to solve problems A and C.

6.3. Reducing problems A and C to a single linear optimization problem. It turns out that both problems A and C can be reduced to one or more instances of the following optimization problem, referred to as *linear optimization with prescription*.

LOP Given a set $X \subseteq \{0, 1\}^n$, a weight vector $w \in W^n$ with $W \subseteq \mathbb{R}$, and disjoint sets $P_0, P_1 \subseteq [n]$, compute an element in $N := \text{argmin}[y \in X \wedge y_{P_0} = 0 \wedge y_{P_1} = 1 \mid w \cdot y]$, or decide that this problem is infeasible, i.e., $N = \emptyset$.

Recall that $y_{P_b} = b$ for $b \in \{0, 1\}$ is a shorthand notation for $y_i = b$ for all $i \in P_b$. We refer to W as the *weight set*.

We first show that problem A can be solved by combining an algorithm for problem LOP with binary search.

Lemma 19. *Suppose that problem LOP with weight set $W = \{-1, 0, +1\}$ can be solved in time $t_{\text{LOP}} = \Omega(n)$. Then problem A can be solved in time $\mathcal{O}(t_{\text{LOP}} \log n)$.*

Proof. Consider a set $X \subseteq \{0, 1\}^n$, an element $x \in X$ and an interval $I \subseteq [n]$ as input for problem A. First note that $\min\{\lambda_I(x, y) \mid y \in X - x\} \subseteq [n] \cup \infty$ and that

$$\min\{\lambda_I(x, y) \mid y \in X - x\} \leq \alpha \quad (4)$$

is a monotone property in $\alpha \in I$. Therefore, it is enough to show that (4) can be decided in time $\mathcal{O}(t_{\text{LOP}})$, as then we can compute $\min\{\lambda_I(x, y) \mid y \in X - x\}$ in time $\mathcal{O}(t_{\text{LOP}} \log n)$ by doing binary search. For the given integer $\alpha \in I$ we define

$$w_i := \begin{cases} -1 & \text{if } i \geq \min I \text{ and } x_i = 0, \\ +1 & \text{if } i \geq \min I \text{ and } x_i = 1, \\ 0 & \text{if } i < \min I, \end{cases} \quad (5a)$$

and

$$P_b := \{i > \alpha \mid x_i = b\} \text{ for } b \in \{0, 1\}. \quad (5b)$$

We claim that

$$\mu := \min_{y \in X \wedge y_{P_0} = 0 \wedge y_{P_1} = 1} w \cdot y < w \cdot x =: a$$

if and only if (4) holds. Indeed, if $\mu < a$, then there is a $y^* \in X$ with $y_{P_0}^* = 0$, $y_{P_1}^* = 1$, and $y_i^* \neq x_i$ for some $i \in I$ with $i \leq \alpha$. It follows that $\lambda_I(x, y^*) \leq \alpha$, which implies (4). Conversely, if (4) holds, then there is $y^* \in X - x$ with $\lambda_I(x, y^*) \leq \alpha$, i.e., there is a position $i \in I$ with $i \leq \alpha$ such that $y_i^* \neq x_i$ and $y_j^* = x_j$ for all $j \geq i + 1$, in particular $y_{P_0}^* = 0$ and $y_{P_1}^* = 1$. As $y_i^* \neq x_i$ we have $w \cdot y^* < a$ and therefore $\mu < a$. This completes the proof of the lemma. \square

We now show that problem C can also be reduced to problem LOP.

Lemma 20. *Suppose that problem LOP with weight set $W = \{-1, +1\}$ can be solved in time $t_{\text{LOP}} = \Omega(n)$. Then problem C can be solved in time $\mathcal{O}(t_{\text{LOP}})$.*

Proof. Consider a set $X \subseteq \{0, 1\}^n$, an element $x \in X$ and an integer $\beta \in [n]$ with $N := \operatorname{argmin}[y \in X - x \wedge \lambda(x, y) = \beta \mid d(x, y)] \neq \emptyset$ as input for problem C. We define

$$w_i := \begin{cases} +1 & \text{if } x_i = 0, \\ -1 & \text{if } x_i = 1, \end{cases} \quad (6a)$$

and

$$P_b := \{\beta \mid x_\beta = \bar{b}\} \cup \{i > \beta \mid x_i = b\} \text{ for } b \in \{0, 1\}. \quad (6b)$$

By this definition we have $d(x, y) = w \cdot (y - x)$, and as x is fixed, minimization of $d(x, y)$ is the same as minimization of $w \cdot y$. Consequently, we have

$$N = \operatorname{argmin}[y \in X - x \wedge \lambda(x, y) = \beta \mid d(x, y)] = \operatorname{argmin}[y \in X \wedge y_{P_0} = 0 \wedge y_{P_1} = 1 \mid w \cdot y].$$

In this calculation we used that from our definition of P_0 and P_1 , the conditions $y_{P_0} = 0$ and $y_{P_1} = 1$ are equivalent to $y_\beta = \bar{x}_\beta$ and $y_i = x_i$ for $i > \beta$, which are equivalent to $y \neq x$ and $\lambda(x, y) = \beta$. This completes the proof of the lemma. \square

Note the opposite signs of the weights in (5a) and (6a) w.r.t. x . This is because the first minimization problem rewards y to differ from x as much as possible, whereas the second problem rewards y to agree with x as much as possible.

Combining these reductions yields the following fundamental result, which says that efficiently solving prescription optimization on X yields an efficient algorithm for computing a Hamilton path on the skeleton of $\operatorname{conv}(X)$.

Theorem 21. *Let $X \subseteq \{0, 1\}^n$ and suppose that problem LOP with weight set $W = \{-1, 0, +1\}$ can be solved in time $t_{\text{LOP}} = \Omega(n)$. Then for any tiebreaking rule and any initial vertex \tilde{x} , Algorithm P* computes a genlex Hamilton path on the skeleton of $\operatorname{conv}(X)$ starting at \tilde{x} with delay $\mathcal{O}(t_{\text{LOP}} \log n)$.*

The initialization time of Algorithm P* is the same as the delay, and the required space is the same as the space needed to solve problem LOP.

Proof. Combine Lemmas 19 and 20 with Theorem 18. \square

6.4. Cost-optimal solutions. In this section, we provide a variant of Theorem 21 for listing only the cost-optimal elements of X with respect to some linear objective function, for example, minimum weight spanning trees or maximum weight matchings in a graph. In particular, this includes minimum or maximum cardinality solutions, for example maximum matchings or minimum vertex covers in a graph.

Let $C \subseteq \mathbb{Z}$, referred as the *cost set*. Furthermore, let $c \in C^n$ be a cost vector and let X_c be the elements in X with minimum cost according to c , i.e., $X_c := \operatorname{argmin}[x \in X \mid c \cdot x]$. The elements of X_c lie on a hyperplane in n -dimensional space, and so $\operatorname{conv}(X_c)$ is a face of $\operatorname{conv}(X)$. In particular, $\operatorname{conv}(X_c)$ is a 0/1-polytope whose edges are edges of $\operatorname{conv}(X)$. The problem LOP on X_c thus becomes a bi-criteria linear optimization problem with prescription. In the following we show that by appropriate amplification of the cost vector by a factor of n , we can eliminate the bi-criteria optimization and reduce to a standard LOP. Specifically, given $c \in \mathbb{Z}^n$, we define

$$W(C) := \{-1, 0, +1\} + nC = \{w + nc \mid w \in \{-1, 0, +1\} \text{ and } c \in C\}, \quad (7)$$

and reduce to solving LOPs with weight set $W(C)$.

The following auxiliary lemma allows us to translate minimization on X_c to minimization on X via weight amplification.

Lemma 22. *Let $X \subseteq \{0, 1\}^n$, $w \in \{-1, 0, +1\}^n$, and $c \in C^n$ with $C \subseteq \mathbb{Z}$. Then the weight vector $w' := w + nc \in W(C)^n$ with $W(C)$ as defined in (7) has the following properties:*

- (i) *For any $y \in X_c$ and $y' \in X \setminus X_c$ we have $w' \cdot y \leq w' \cdot y'$. Consequently, if $y \in X_c$ and $y' \in X$ satisfy $w' \cdot y > w' \cdot y'$, then we have $y' \in X_c$.*
- (ii) *Let $\beta \in [n]$ be such that $y_\beta = y'_\beta$ for all $y, y' \in X$. Then we have $\operatorname{argmin}[y \in X_c \mid w' \cdot y] = \operatorname{argmin}[y \in X \mid w' \cdot y]$.*

Proof. To prove (i), let $y \in X_c$ and $y' \in X \setminus X_c$, i.e., y minimizes the costs and y' does not, in particular $c \cdot y < c \cdot y'$. As c is an integer vector, we therefore have $c \cdot y \leq c \cdot y' - 1$. Furthermore, as all entries of w are from $\{-1, 0, +1\}$, we have $w \cdot y \leq w \cdot y' + n$ (the same inequality holds with y and y' interchanged, but this is not needed here). Combining these inequalities yields $w' \cdot y = w \cdot y + nc \cdot y \leq w \cdot y' + n + n(c \cdot y' - 1) = (w + nc) \cdot y' = w' \cdot y'$, as claimed.

To prove (ii), note that if all bitstrings from X agree in the β th position, then the second inequality from before is strict, which yields the stronger conclusion $w' \cdot y < w' \cdot y'$, which directly proves (ii). \square

Lemmas 23 and 24 below are the analogues of Lemmas 19 and 20, respectively.

Lemma 23. *Let $X \subseteq \{0, 1\}^n$ and $c \in C^n$ with $C \subseteq \mathbb{Z}$. Suppose that problem LOP for X with weight set $W(C)$ can be solved in time $t_{\text{LOP}} = \Omega(n)$. Then problem A for X_c can be solved in time $\mathcal{O}(t_{\text{LOP}} \log n)$.*

Proof of Lemma 23. Consider the set $X_c \subseteq \{0, 1\}^n$, an element $x \in X_c$ and an interval $I \in [n]$ as input for problem A. We show that

$$\min\{\lambda_I(x, y) \mid y \in X_c - x\} \leq \alpha \quad (8)$$

can be decided in time $\mathcal{O}(t_{\text{LOP}})$, from which it follows that $\min\{\lambda_I(x, y) \mid y \in X_c - x\}$ can be computed in time $\mathcal{O}(t_{\text{LOP}} \log n)$ by doing binary search. We define P_0, P_1 and $w \in \{-1, 0, +1\}^n$ as in (5), and we also define $w' := w + nc \in W(C)^n$. We claim that

$$\mu := \min_{y \in X \wedge y_{P_0} = 0 \wedge y_{P_1} = 1} w' \cdot y < w' \cdot x = (w + nc) \cdot x =: a \quad (9)$$

if and only if (8) holds. Crucially, the minimization in (9) is over the entire set X , whereas the minimization in (8) is only over the subset $X_c \subseteq X$.

To prove one direction of the claim, note that if $\mu < a$, then there is a $y^* \in X$ with $y_{P_0}^* = 0$, $y_{P_1}^* = 1$, and $y_i^* \neq x_i$ for some $i \in I$ with $i \leq \alpha$. It follows that $\lambda_I(x, y^*) \leq \alpha$. Applying Lemma 22 (i) shows that $y^* \in X_c$, which implies (8).

To prove the other direction of the claim, if (8) holds, then there is $y^* \in X_c - x$ with $\lambda_I(x, y^*) \leq \alpha$, i.e., there is a position $i \in I$ with $i \leq \alpha$ such that $y_i^* \neq x_i$ and $y_j^* = x_j$ for all $j \geq i + 1$, in particular $y_{P_0}^* = 0$ and $y_{P_1}^* = 1$. As $y_i^* \neq x_i$ we have $w \cdot y^* < w \cdot x$. Using that $y \in X_c$ we also have $c \cdot y^* = c \cdot x$. Combining these observations yields $w' \cdot y^* = w \cdot y^* + nc \cdot y^* < w \cdot x + nc \cdot x = (w + nc) \cdot x = a$ and therefore $\mu < a$. This completes the proof of the lemma. \square

Lemma 24. *Let $X \subseteq \{0, 1\}^n$ and $c \in C^n$ with $C \subseteq \mathbb{Z}$. Suppose that problem LOP for X with weight set $W(C)$ can be solved in time $t_{\text{LOP}} = \Omega(n)$. Then problem C for X_c can be solved in time $\mathcal{O}(t_{\text{LOP}})$.*

Proof. Consider the set $X_c \subseteq \{0, 1\}^n$, an element $x \in X_c$ and an integer $\beta \in [n]$ with $N := \operatorname{argmin}[y \in X_c - x \wedge \lambda(x, y) = \beta \mid d(x, y)] \neq \emptyset$ as input for problem C. We define P_0, P_1 and w as in (6), and we also define $w' := w + nc \in W(C)^n$.

By these definitions we have $d(x, y) = w \cdot (y - x) = (w' - nc) \cdot (y - x)$, and as x is fixed and $c \cdot y$ is the same value for all $y \in X_c$, minimization of $d(x, y)$ is the same as minimization of $w' \cdot y$. Consequently, we have

$$\begin{aligned} N &= \operatorname{argmin}[y \in X_c - x \wedge \lambda(x, y) = \beta \mid d(x, y)] \\ &= \operatorname{argmin}[y \in X_c \wedge y_{P_0} = 0 \wedge y_{P_1} = 1 \mid w' \cdot y] \\ &= \operatorname{argmin}[y \in X \wedge y_{P_0} = 0 \wedge y_{P_1} = 1 \mid w' \cdot y], \end{aligned}$$

where we used the definitions of P_0 and P_1 in the first step, and Lemma 22 (ii) in the second step. \square

Theorem 25. *Let $X \subseteq \{0, 1\}^n$ and $c \in C^n$ with $C \subseteq \mathbb{Z}$. Suppose that problem LOP for X with weight set $W(C)$ as defined in (7) can be solved in time $t_{\text{LOP}} = \Omega(n)$. Then for any tiebreaking rule and any initial vertex $\tilde{x} \in X_c$, Algorithm P* computes a genlex Hamilton path on the skeleton of $\operatorname{conv}(X_c)$ starting at \tilde{x} with delay $\mathcal{O}(t_{\text{LOP}} \log n)$.*

Proof. Combine Lemmas 23 and 24 with Theorem 18. \square

Remark 26. Suppose that problem LOP for X with weight set W can be solved in time $f(n, M)$, where $M := \max W$. Then problem LOP for X with weight set $W(C)$ can be solved in time $f(n, nM)$. Often the dependency of f on M is *polylogarithmic*, and in those cases $f(n, nM)$ is only by a polylogarithmic factor in n bigger than $f(n, M)$. Then the delay of Algorithm P* is only by a polylogarithmic factor in n larger than the time for solving the corresponding optimization problem on X .

6.5. Eliminating the prescription constraints. A similar weight amplification trick can be used to reduce linear optimization with prescription to classical *linear optimization* (without prescription).

LO Given a set $X \subseteq \{0, 1\}^n$ and a weight vector $w \in W^n$ with $W \subseteq \mathbb{R}$, compute an element in $N := \operatorname{argmin}[y \in X \mid w \cdot y]$, or decide that this problem is infeasible, i.e., $N = \emptyset$.

Lemma 27. *Let $X \subseteq \{0, 1\}^n$ and $w \subseteq W^n$ with $W \subseteq \mathbb{Z} \cap [-M, +M]$. Suppose that problem LO with weight set $W \cup \{-nM, +nM\}$ can be solved in time $t_{\text{LO}} = \Omega(n)$. Then problem LOP with weight set W can be solved in time $\mathcal{O}(t_{\text{LO}})$.*

Proof. Consider X and w as in the lemma, and sets $P_0, P_1 \subseteq [n]$ as input for problem LOP. We define $Q := [n] \setminus (P_0 \cup P_1)$. Clearly, we may assume that $|P_0 \cup P_1| > 0$, or equivalently $|Q| < n$. We define a weight vector $w' \in (W \cup \{-nM, +nM\})^n$ by

$$w'_i := \begin{cases} w_i & \text{if } i \in Q, \\ +nM & \text{if } i \in P_0, \\ -nM & \text{if } i \in P_1. \end{cases}$$

We claim that

$$N := \operatorname{argmin}[y \in X \wedge y_{P_0} = 0 \wedge y_{P_1} = 1 \mid w \cdot y] = \operatorname{argmin}[y \in X \mid w' \cdot y].$$

For any $y \in X$ we define the abbreviations $f(y) := \sum_{i \in Q} w_i y_i$ and $g(y) := \sum_{i \in P_0} y_i - \sum_{i \in P_1} y_i$, so $w' \cdot y = f(y) + nMg(y)$. Furthermore, we define $X_P := \{y \in X \mid y_{P_0} = 0 \wedge y_{P_1} = 1\}$. Let $y \in X_P$ and $y' \in X \setminus X_P$. As all entries of y and y' are from $\{0, 1\}$ and $|w_i| \leq M$ we have

TABLE 3. Delay of Algorithm P* obtained from applying Theorems 21 and 25 with Lemma 27. We assume that problems LOP and LO for X can be solved in time $t_{\text{LOP}} = f(n, M)$ or $t_{\text{LO}} = g(n, M)$, respectively, where M is an upper bound on the entries of the weight vector $w \in W^n$, i.e., $W \subseteq \mathbb{Z} \cap [-M, +M]$. We also assume that both of these functions are in $\Omega(n)$.

Objects	Optimization problem	Weight set	Delay of Algorithm P*
All elements in X	LOP for X	$\{-1, 0, 1\}$	$\mathcal{O}(f(n, 1) \log n)$ Thm. 21
	LO for X	$\{-n, -1, 0, 1, n\}$	$\mathcal{O}(g(n, n) \log n)$ Thm. 21+Lemma 27
Elements in X of minimum size, i.e., $c = (+1, \dots, +1)$	LOP for X	$\{n-1, n, n+1\}$	$\mathcal{O}(f(n, n+1) \log n)$ Thm. 25
	LO for X	$\{-n(n+1), n-1, n, n+1, n(n+1)\}$	$\mathcal{O}(g(n, n(n+1)) \log n)$ Thm. 25 + Lemma 27
Elements in X of maximum size, i.e., $c = (-1, \dots, -1)$	LOP for X	$\{-n-1, -n, -n+1\}$	$\mathcal{O}(f(n, n+1) \log n)$ Thm. 25
	LO for X	$\{-n(n+1), -n-1, -n, -n+1, n(n+1)\}$	$\mathcal{O}(g(n, n(n+1)) \log n)$ Thm. 25 + Lemma 27
c -optimal elements in X where $c \in C^n$ and $C \subseteq \mathbb{Z} \cap [-M, M]$	LOP for X	$W(C)$	$\mathcal{O}(f(n, nM+1) \log n)$ Thm. 25
	LO for X	$W(C) \cup \{-n(nM+1), n(nM+1)\}$	$\mathcal{O}(g(n, n(nM+1)) \log n)$ Thm. 25 + Lemma 27

$w_i(y_i - y'_i) \leq M$ and therefore $f(y) \leq f(y') + |Q|M < f(y') + nM$. Furthermore, note that $g(y) = -|P_1|$ and $g(y') \geq -|P_1| + 1 = g(y) + 1$. Combining these inequalities yields

$$w' \cdot y = f(y) + nMg(y) < f(y') + nM + nM(g(y') - 1) = f(y') + nMg(y') = w' \cdot y',$$

which proves that $\operatorname{argmin}[y \in X \mid w' \cdot y] = \operatorname{argmin}[y \in X_P \mid w' \cdot y]$. Now observe that $w' \cdot y = w \cdot y + \sum_{i \in P_0 \cup P_1} (w'_i - w_i)y_i$, and the sum on the right hand side of this equation is a constant for all $y \in X_P$, so minimizing $w' \cdot y$ over all $y \in X_P$ is the same as minimizing $w \cdot y$ over all $y \in X_P$. This proves the claim and thus the lemma. \square

Via Lemma 27, the problem of computing a Hamilton path on the polytope $\operatorname{conv}(X)$ is reduced entirely to solving linear optimization (problem LO) over X . Lemma 27 can be applied in conjunction with Theorem 21 or Theorem 25; see Table 3.

Remark 28. The results obtained by applying Lemma 27 are incomparable to those obtained without the lemma (which rely on solving problem LOP). Specifically, while eliminating the prescription constraints one arrives at a simpler optimization problem, this comes at the cost of increasing the weights, thus potentially increasing the running time. Nevertheless, Lemma 27 provides an *automatic* way to exploit any algorithm for the linear optimization problem on X (problem LO; without prescription constraints) for computing a Hamilton path on the corresponding 0/1-polytope $\operatorname{conv}(X)$, with provable runtime guarantees for this computation.

7. APPLICATIONS

In this section, we show how to apply our general theorems to obtain efficient algorithms for generating Gray codes for different concrete classes of combinatorial objects. The list of applications shown here is not exhaustive, but exemplarily. More results are derived in short form in Table 1.

7.1. Vertices of a 0/1-polytope. Let $A \in \mathbb{R}^{m \times n}$ and $b \in \mathbb{R}^m$ be such that $P := \{x \in \mathbb{R}^n \mid Ax \leq b\}$ is a 0/1-polytope. We let $X \subseteq \{0, 1\}^n$ denote the set of vertices of P , i.e., we have $P = \text{conv}(X)$. The problem LOP defined in Section 1.5 translates to solving the LP

$$\min\{w \cdot x \mid Ax \leq b \wedge x_{P_0} = 0 \wedge x_{P_1} = 1\}.$$

By eliminating the prescribed variables from this problem, we see that it is equivalent to the standard LP

$$\min\{w \cdot x \mid Ax \leq b\} \tag{10}$$

(with modified A , b , and w , but with the same bounds on their sizes). Thus, invoking Theorem 21 we obtain the following result about the vertex enumeration problem for 0/1-polytopes. Our result improves upon the $\mathcal{O}(t_{\text{LP}} n)$ delay algorithm of Bussieck and Lübbecke [BL98], and it has the additional feature that the vertices of the polytope are visited in the order of a Hamilton path on the skeleton.

Corollary 29. *Let $P = \{x \in \mathbb{R}^n \mid Ax \leq b\}$ be a 0/1-polytope, and suppose that the LP (10) can be solved in time $t_{\text{LP}} = \Omega(mn)$. Then for any tiebreaking rule and any initial vertex \tilde{x} , Algorithm P^* computes a genlex Hamilton path on the skeleton of P starting at \tilde{x} with delay $\mathcal{O}(t_{\text{LP}} \log n)$.*

We can also apply Theorem 25 to visit only the cost-optimal vertices of P . For this we also assume that t_{LP} depends polylogarithmically on the largest weight (recall Remark 26).

Corollary 30. *Let P and t_{LP} be as in Corollary 29, and suppose that t_{LP} is polylogarithmic in the largest weight. Furthermore, let $c \in \mathbb{Z}^n$ and $P_c := \text{argmin}[x \in P \mid c \cdot x]$. Then for any tiebreaking rule and any initial vertex $\tilde{x} \in P_c$, Algorithm P^* computes a genlex Hamilton path on the skeleton of P_c starting at \tilde{x} with delay $\mathcal{O}(t_{\text{LP}} \text{poly}(\log n))$.*

The initialization time of Algorithm P^* in both results is the same as the delay, and the required space is the same as the space needed to solve the LP (10).

7.2. Spanning trees of a graph. Let H be a connected n -vertex graph with edge set $[m]$. We let X denote the set of indicator vectors of spanning trees of H , i.e.,

$$X = \{\mathbf{1}_T \mid T \subseteq [m] \text{ is a spanning tree of } H\} \subseteq \{0, 1\}^m.$$

It is well known ([HK78]) that the edges of the *spanning tree polytope* $\text{conv}(X)$ are precisely between pairs of trees T, T' that differ in an edge exchange, i.e., there are edges $i, j \in [m]$ such that $T' = T + i - j$. We thus obtain the following specialization of Algorithm G for listing all spanning trees of H by edge exchanges. The greedy update rule in step T3 minimizes the larger of the two edges in each exchange.

Algorithm T (*Spanning trees by shortest prefix changes*). Given a connected graph H with edge set $[m]$, this algorithm greedily generates all spanning trees of H by edge exchanges, starting from an initial spanning tree \tilde{T} .

T1. [Initialize] Set $T \leftarrow \tilde{T}$.

T2. [Visit] Visit T .

- T3.** [Shortest prefix change] Compute the set N of unvisited spanning trees T' that differ from T in the exchange of edges i, j with smallest value $\max\{i, j\}$, i.e., $N \leftarrow \operatorname{argmin}[T' = T + i - j \text{ spanning tree of } H \wedge T' \text{ unvisited} \mid \max\{i, j\}]$. Terminate if $N = \emptyset$.
- T4.** [Tiebreaker+update T] Pick any tree $T' \in N$, set $T \leftarrow T'$ and goto T2.

This algorithm for generating spanning trees by edge exchanges has been described before by Merino, Mütze, and Williams [MMW22]. They gave an implementation that achieves delay $\mathcal{O}(m \log n (\log \log n)^3)$. We now improve on this result using our framework via optimization.

The problem LOP defined in Section 1.5 translates to computing a minimum weight spanning tree T in H according to some weight function $w \in \mathbb{R}^m$, with the prescription constraints $P_0 \cap T = \emptyset$ and $P_1 \subseteq T$, i.e., the edges in P_0 are forbidden, and the edges in P_1 are forced. This could be achieved by computing the graph H' that is obtained from H by deleting the edges in P_0 and contracting the edges in P_1 , which may however be costly. Instead, we solve the problem on the original graph H , but with the modified weight function

$$w'_i := \begin{cases} w_i & \text{if } i \notin P_0 \cup P_1, \\ M & \text{if } i \in P_0, \\ -M & \text{if } i \in P_1, \end{cases}$$

where M is chosen so that $M > \max_{i \in [m]} |w_i|$. For applying Theorem 21 we only need to consider weights $w \in \{-1, 0, 1\}^m$, so we can take $M = 2$. For graphs with constantly many distinct edge weights (in our case $\{-2, -1, 0, 1, 2\}$), the minimum spanning tree problem can be solved in time $\mathcal{O}(m)$, by a variation of Prim's algorithm that instead of a priority queue uses one list of same weight edges for each possible weight. Theorem 21 thus yields the following corollary.

Corollary 31. *Let H be an n -vertex graph with edge set $[m]$. Then for any tiebreaking rule and any initial spanning tree \tilde{T} , Algorithm P^* computes a genlex listing of all spanning trees of H by edge exchanges starting at \tilde{T} with delay $\mathcal{O}(m \log n)$.*

To generate all cost-optimal spanning trees, we apply Theorem 25 and combine it with Chazelle's [Cha00] algorithm for computing minimum spanning trees, which runs time $\mathcal{O}(m\alpha(m, n))$, where α is the functional inverse of the Ackermann function.

Corollary 32. *Let H be an n -vertex graph with edge set $[m]$, and let $c \in \mathbb{Z}^m$. Then for any tiebreaking rule and any initial c -minimal spanning tree \tilde{T} , Algorithm P^* computes a genlex listing of all c -minimal spanning trees of H by edge exchanges starting at \tilde{T} with delay $\mathcal{O}(m\alpha(m, n) \log n)$.*

In both of these results, the initialization time of Algorithm P^* is the same as the delay, and the required space is the same as for computing a minimum spanning tree.

7.3. Matchings of a graph. Let H be an n -vertex graph with edge set $[m]$. We let X denote the set of indicator vectors of matchings of H , i.e.,

$$X = \{\mathbf{1}_M \mid M \subseteq [m] \text{ is a matching of } H\} \subseteq \{0, 1\}^m.$$

It is well known ([Chv75]) that the edges of the *matching polytope* $\operatorname{conv}(X)$ are precisely between pairs of matchings M, M' that differ in an alternating path or cycle exchange, i.e., there is a path or cycle E such that $M' = M \Delta E$, where Δ denotes the symmetric difference. We thus obtain the following specialization of Algorithm G for listing all matchings of H by alternating path/cycle exchanges. The greedy update rule in step M3 minimizes the largest of the edges in E .

Algorithm M (*Matchings by shortest prefix changes*). Given a graph H with edge set $[m]$, this algorithm greedily generates all matchings of H by alternating path/cycle exchanges, starting from an initial matching \widetilde{M} .

M1. [Initialize] Set $M \leftarrow \widetilde{M}$.

M2. [Visit] Visit M .

M3. [Shortest prefix change] Compute the set N of unvisited matchings M' that differ from M in the exchange of an alternating path/cycle E with smallest value $\max E$, i.e., $N \leftarrow \operatorname{argmin}[M' = M \Delta E \text{ matching} \wedge E \text{ path/cycle} \wedge M' \text{ unvisited} \mid \max E]$. Terminate if $N = \emptyset$.

M4. [Tiebreaker+update M] Pick any matching $M' \in N$, set $M \leftarrow M'$ and goto M2.

The problem LOP defined in Section 1.5 translates to computing a minimum weight matching M in H according to some weight function $w \in \mathbb{R}^m$, with the prescription constraints $P_0 \cap M = \emptyset$ and $P_1 \subseteq M$, i.e., the edges in P_0 are forbidden, and the edges in P_1 are forced. This can be achieved by computing the graph H' that is obtained from H by deleting the edges in P_0 and deleting the vertices that are endpoints of edges in P_1 . We then find a minimum weight matching in the smaller graph H' . For applying Theorem 21 we only need to consider weights $w \in \{-1, 0, 1\}^m$, and as LOP is a minimization problem, we can simplify H' further by deleting all edges with weights 0 or 1, which yields a graph H'' that has only edges of weight -1 . A minimum weight matching in H'' is therefore a maximum matching in H'' , and for finding this we use Micali and Vazirani's [MV80] algorithm, which runs in time $\mathcal{O}(m\sqrt{n})$. Theorem 21 thus yields the following corollary. As Algorithm P^* minimizes the Hamming distance when moving to the next matching, the alternating path/cycle will in fact always be an alternating path of length ≤ 3 .

Corollary 33. *Let H be an n -vertex graph without isolated vertices with edge set $[m]$. Then for any tiebreaking rule and any initial matching \widetilde{M} , Algorithm P^* computes a genlex listing of all matchings of H by alternating path exchanges of length ≤ 3 starting at \widetilde{M} with delay $\mathcal{O}(m\sqrt{n} \log n)$.*

To generate all cost-optimal matchings w.r.t. some cost vector $c \in \mathbb{Z}^m$, we apply Theorem 25 and combine it with Duan, Pettie and Su's [DPS18] algorithm, which runs in time $\mathcal{O}(m\sqrt{n} \log(n|c|))$, or Gabow's [Gab17] implementation of Edmond's algorithm, which runs in time $\mathcal{O}(mn + n^2 \log n)$. The quantity $|c|$ is the maximum absolute value of entries of c . These algorithms maximize the weight instead of minimizing it, but we can simply multiply all weights by -1 .

Corollary 34. *Let H be an n -vertex graph without isolated vertices with edge set $[m]$, and let $c \in \mathbb{Z}^m$. Then for any tiebreaking rule and any initial c -minimal matching \widetilde{M} , Algorithm P^* computes a genlex listing of all c -minimal matchings of H by alternating path/cycle exchanges starting at \widetilde{M} with delay*

$$\min \left\{ \mathcal{O}(m\sqrt{n} \log(n|c|) \log n), \mathcal{O}((mn + n^2 \log n) \log n) \right\}.$$

A particularly interesting case is when the cost vector is $c = (-1, \dots, -1)$, i.e., we obtain all maximum size matchings of H . In particular, if H has a perfect matching, we can generate all perfect matchings of H . The weights for our minimization problem will be $\{-m-1, -m, -m+1\}$, and for the corresponding maximization problem they will be $\{m-1, m, m+1\}$.

Corollary 35. *Let H be an n -vertex graph without isolated vertices with edge set $[m]$. Then for any tiebreaking rule and any initial maximum matching \widetilde{M} , Algorithm P^* computes a genlex listing of all maximum matchings of H by alternating path/cycle exchanges starting at \widetilde{M} with delay $\mathcal{O}(m\sqrt{n}(\log n)^2)$.*

In all three of these results, the initialization time of Algorithm P^* is the same as the delay, and the required space is the same as for computing a maximum (weight) matching.

8. DUALITY BETWEEN ALGORITHM P AND ALGORITHM J

There is an interesting duality between the generation framework proposed here and the permutation language framework due to Hartung, Hoang, Mütze and Williams [HHMW22]. Their framework encodes combinatorial objects by permutations of length n , and the local change operation to go from one permutation to the next is a cyclic substring shift by one position, subject to the constraint that the largest value j in the substring wraps around and moves to the other end of the substring. This operation is referred to as a *jump of j* , the number of *steps* of the jump is one less than the length of the shifted substring, and its *direction* is the direction of movement of j in the substring. For example $24135 \rightarrow 21345$ is a jump of the value 4 by 2 steps to the right. Similarly, $123 \cdots n \rightarrow n123 \cdots (n-1)$ is a jump of the value n by $n-1$ steps to the left. Their framework is based on a simple greedy algorithm, *Algorithm J*, which attempts to generate a set of permutations by jumps, by repeatedly and greedily performing a shortest possible jump of the largest possible value so that a previously unvisited permutation is created. Compare this to our Algorithm P, which repeatedly and greedily performs a prefix change of shortest possible length so that a previously unvisited bitstring is created. In fact, these two algorithms are dual to each other: While Algorithm J works based on values, Algorithm P works based on positions.

Specifically, we can simulate Algorithm P by Algorithm J, by encoding bitstrings of length n by permutations of length $n+1$. This encoding is defined inductively using the suffix tree generated by a run of Algorithm P, and can be done so that a prefix change of length d on the bitstrings corresponds to a jump of the value $j := n-d+2$ by $j-1$ steps in the permutations (i.e., j jumps across all values smaller than itself).

Conversely, Algorithm J can also be simulated by Algorithm P (even though Algorithm P knows only 0s and 1s). The idea is to encode each permutation $\pi = a_1 \cdots a_{n+1}$ by its *inversion table* $c = c_1 \cdots c_{n+1}$, where $0 \leq c_i \leq i-1$ counts the number of entries of π that are smaller than i and to the right of i . The value c_i of the inversion table is encoded by a bitstring of length i with a single 1 at position c_i (counted from 0), and the entire inversion table is encoded by concatenating these bitstrings in reverse order. In the simulation, a jump of the value i by d steps in the permutation changes exactly the entry c_i by $\pm d$, and so this 1-bit moves by d positions in the corresponding encoding. By the concatenation in reverse order, a jump of the largest possible value corresponds to a change of the shortest possible prefix.

9. OPEN QUESTIONS

We conclude this paper with some open questions.

- Does our theory generalize to nonbinary alphabets (cf. the discussion in the previous section)? More specifically, instead of encoding a class of objects X as bitstrings $X \subseteq \{0, 1\}^n$, we may use $X \subseteq \{0, 1, \dots, b-1\}$ for some integer $b \geq 2$. Many of the concepts introduced here generalize straightforwardly, including Algorithm G, genlex ordering, suffix trees, and Theorem 5 (recall in particular Remark 6). However, it is not clear how to generalize prefix graphs so that they

arise as the skeleta of the corresponding polytopes. Most importantly, not all polytopes admit a Hamilton path, unlike 0/1-polytopes via Naddef and Pulleyblank’s [NP84] result.

- Is there an improved amortized analysis of Algorithm P, maybe for certain classes of combinatorial objects? Such an analysis would need to consider the heights at which branchings occur in the suffix tree, and this may depend on the ordering of the ground set. For combinations (=bases of the uniform matroid) such an improved amortized analysis can be carried out and provides better average delay guarantees (see [MMW22]).
- Can we get Gray code listings for particular classes of objects from our framework that have interesting additional structural properties? For example, Knuth [Knu11] asked whether there is a simple ordering of the spanning trees of the complete graph K_n by edge exchanges. It is not completely well-defined what ‘simple’ means, but certainly efficient ranking and unranking algorithms would be desirable.

REFERENCES

- [ABMP91] H. Alt, N. Blum, K. Mehlhorn, and M. Paul. Computing a maximum cardinality matching in a bipartite graph in time $O(n^{1.5}\sqrt{m/\log n})$. *Inform. Process. Lett.*, 37(4):237–240, 1991.
- [AF92] D. Avis and K. Fukuda. A pivoting algorithm for convex hulls and vertex enumeration of arrangements and polyhedra. *Discrete Comput. Geom.*, 8(3):295–313, 1992. ACM Symposium on Computational Geometry (North Conway, NH, 1991).
- [AF96] D. Avis and K. Fukuda. Reverse search for enumeration. *Discrete Appl. Math.*, 65(1-3):21–46, 1996. First International Colloquium on Graphs and Optimization (GOI), 1992 (Grimentz).
- [Avis00] D. Avis. A revised implementation of the reverse search vertex enumeration algorithm. In *Polytopes—combinatorics and computation (Oberwolfach, 1997)*, volume 29 of *DMV Sem.*, pages 177–198. Birkhäuser, Basel, 2000.
- [BE07] M. Behle and F. Eisenbrand. 0/1 vertex and facet enumeration with BDDs. In *Proceedings of the Ninth Workshop on Algorithm Engineering and Experiments, ALENEX 2007, New Orleans, Louisiana, USA, January 6, 2007*. SIAM, 2007.
- [BEGM09] E. Boros, K. Elbassioni, V. Gurvich, and K. Makino. Generating vertices of polyhedra and related problems of monotone generation. In *Polyhedral computation*, volume 48 of *CRM Proc. Lecture Notes*, pages 15–43. Amer. Math. Soc., Providence, RI, 2009.
- [BEGT11] E. Boros, K. Elbassioni, V. Gurvich, and H. R. Tiwary. The negative cycles polyhedron and hardness of checking some polyhedral properties. *Ann. Oper. Res.*, 188:63–76, 2011.
- [BL98] M. R. Bussieck and M. E. Lübbecke. The vertex set of a 0/1-polytope is strongly P-enumerable. *Comput. Geom.*, 11(2):103–109, 1998.
- [CCPS98] W. J. Cook, W. H. Cunningham, W. R. Pulleyblank, and A. Schrijver. *Combinatorial optimization*. Wiley-Interscience Series in Discrete Mathematics and Optimization. John Wiley & Sons, Inc., New York, 1998. A Wiley-Interscience Publication.
- [CGM⁺22] A. Conte, R. Grossi, A. Marino, T. Uno, and L. Versari. Proximity search for maximal subgraph enumeration. *SIAM J. Comput.*, 51(5):1580–1625, 2022.
- [CGS21] B. Cameron, A. Grubb, and J. Sawada. A pivot Gray code listing for the spanning trees of the fan graph. In C.-Y. Chen, W.-K. Hon, L.-J. Hung, and C.-W. Lee, editors, *Proceedings of the 27th International Computing and Combinatorics Conference (COCOON 2021), Tainan, Taiwan, October 24–26*, volume 13025 of *Lecture Notes in Comput. Sci.*, pages 49–60. Springer, 2021.
- [Cha00] B. Chazelle. A minimum spanning tree algorithm with inverse-Ackermann type complexity. *J. ACM*, 47(6):1028–1047, 2000.
- [CHJ91] P.-C. Chen, P. Hansen, and B. Jaumard. On-line and off-line vertex enumeration by adjacency lists. *Oper. Res. Lett.*, 10(7):403–409, 1991.
- [Chv75] V. Chvátal. On certain polytopes associated with graphs. *J. Combinatorial Theory Ser. B*, 18:138–154, 1975.
- [CSW21] B. Cameron, J. Sawada, and A. Williams. A Hamilton cycle in the k -sided pancake network. In *Combinatorial algorithms*, volume 12757 of *Lecture Notes in Comput. Sci.*, pages 137–151. Springer, Cham, [2021] ©2021.

- [DPS18] R. Duan, S. Pettie, and H.-H. Su. Scaling algorithms for weighted matching in general graphs. *ACM Trans. Algorithms*, 14(1):Art. 8, 35 pp., 2018.
- [DS12] R. Duan and H.-H. Su. A scaling algorithm for maximum weight matching in bipartite graphs. In *Proceedings of the Twenty-Third Annual ACM-SIAM Symposium on Discrete Algorithms*, pages 1413–1424. ACM, New York, 2012.
- [Dye83] M. E. Dyer. The complexity of vertex enumeration methods. *Math. Oper. Res.*, 8(3):381–402, 1983.
- [EM20] K. Elbassioni and K. Makino. Enumerating vertices of covering polyhedra with totally unimodular constraint matrices. *SIAM J. Discrete Math.*, 34(1):843–864, 2020.
- [FM92] K. Fukuda and T. Matsui. Finding all minimum-cost perfect matchings in bipartite graphs. *Networks*, 22(5):461–468, 1992.
- [FRS03] S. Felsner, V. Raghavan, and J. Spinrad. Recognition algorithms for orders of small width and graphs of small Dilworth number. *Order*, 20(4):351–364 (2004), 2003.
- [Gab17] H. N. Gabow. A data structure for nearest common ancestors with linking. *ACM Trans. Algorithms*, 13(4):Art. 45, 28 pp., 2017.
- [Gav00] F. Gavril. Maximum weight independent sets and cliques in intersection graphs of filaments. *Inform. Process. Lett.*, 73(5-6):181–188, 2000.
- [HHMW22] E. Hartung, H. P. Hoang, T. Mütze, and A. Williams. Combinatorial generation via permutation languages. I. Fundamentals. *Trans. Amer. Math. Soc.*, 375(4):2255–2291, 2022.
- [HK73] J. E. Hopcroft and R. M. Karp. An $n^{5/2}$ algorithm for maximum matchings in bipartite graphs. *SIAM J. Comput.*, 2:225–231, 1973.
- [HK78] D. Hausmann and B. Korte. Colouring criteria for adjacency on 0–1-polyhedra. *Math. Programming Stud.*, pages 106–127, 1978. Polyhedral combinatorics.
- [HL19] T. Hibi and N. Li. Cutting convex polytopes by hyperplanes. *Mathematics*, 7(5), 2019.
- [HMNS01] M. Habib, R. Medina, L. Nourine, and G. Steiner. Efficient algorithms on distributive lattices. *Discrete Appl. Math.*, 110(2-3):169–187, 2001.
- [Knu11] D. E. Knuth. *The Art of Computer Programming. Vol. 4A. Combinatorial Algorithms. Part 1*. Addison-Wesley, Upper Saddle River, NJ, 2011.
- [KR91] S. Kapoor and H. Ramesh. Algorithms for generating all spanning trees of undirected, directed and weighted graphs. In *Algorithms and data structures (Ottawa, ON, 1991)*, volume 519 of *Lecture Notes in Comput. Sci.*, pages 461–472. Springer, Berlin, 1991.
- [KV18] B. Korte and J. Vygen. *Combinatorial optimization*, volume 21 of *Algorithms and Combinatorics*. Springer, Berlin, 2018. Theory and algorithms, Sixth edition of [MR1764207].
- [LRvBR93] J. M. Lucas, D. Roelants van Baronaigien, and F. Ruskey. On rotations and the generation of binary trees. *J. Algorithms*, 15(3):343–366, 1993.
- [MMW22] A. Merino, T. Mütze, and A. Williams. All your bases are belong to us: listing all bases of a matroid by greedy exchanges. In *11th International Conference on Fun with Algorithms*, volume 226 of *LIPICs. Leibniz Int. Proc. Inform.*, pages Paper No. 22, 28 pp. Schloss Dagstuhl. Leibniz-Zent. Inform., Wadern, 2022.
- [MR80] T. H. Mat[th]heiss and D. S. Rubin. A survey and comparison of methods for finding all vertices of convex polyhedral sets. *Math. Oper. Res.*, 5(2):167–185, 1980.
- [MRTT53] T. S. Motzkin, H. Raiffa, G. L. Thompson, and R. M. Thrall. The double description method. In *Contributions to the theory of games, vol. 2*, Annals of Mathematics Studies, no. 28, pages 51–73. Princeton University Press, Princeton, N.J., 1953.
- [Müt22] T. Mütze. Combinatorial Gray codes—an updated survey. <https://arxiv.org/abs/2202.01280>, 2022.
- [MV80] S. Micali and V. V. Vazirani. An $O(\sqrt{|V|}|E|)$ algorithm for finding maximum matching in general graphs. In *21st Annual Symposium on Foundations of Computer Science, Syracuse, New York, USA, 13-15 October 1980*, pages 17–27. IEEE Computer Society, 1980.
- [NP81] D. Naddef and W. R. Pulleyblank. Hamiltonicity and combinatorial polyhedra. *J. Combin. Theory Ser. B*, 31(3):297–312, 1981.
- [NP84] D. J. Naddef and W. R. Pulleyblank. Hamiltonicity in (0-1)-polyhedra. *J. Combin. Theory Ser. B*, 37(1):41–52, 1984.
- [Ord67] R. J. Ord-Smith. Algorithm 308: Generation of the permutations in pseudo-lexicographic order [G6]. *Commun. ACM*, 10(7):452, 1967.

- [Orl13] J. B. Orlin. Max flows in $O(nm)$ time, or better. In *STOC'13—Proceedings of the 2013 ACM Symposium on Theory of Computing*, pages 765–774. ACM, New York, 2013.
- [PR93] G. Pruesse and F. Ruskey. Gray codes from antimatroids. *Order*, 10(3):239–252, 1993.
- [RSW12] F. Ruskey, J. Sawada, and A. Williams. Binary bubble languages and cool-lex order. *J. Combin. Theory Ser. A*, 119(1):155–169, 2012.
- [Rus03] F. Ruskey. Combinatorial generation. Book draft, 2003.
- [Rus16] F. Ruskey. Combinatorial Gray code. In *Encyclopedia of Algorithms*, pages 342–347. 2016.
- [Sav97] C. Savage. A survey of combinatorial Gray codes. *SIAM Rev.*, 39(4):605–629, 1997.
- [Sch03a] A. Schrijver. *Combinatorial optimization. Polyhedra and efficiency. Vol. A*, volume 24 of *Algorithms and Combinatorics*. Springer-Verlag, Berlin, 2003. Paths, flows, matchings, Chapters 1–38.
- [Sch03b] A. Schrijver. *Combinatorial optimization. Polyhedra and efficiency. Vol. B*, volume 24 of *Algorithms and Combinatorics*. Springer-Verlag, Berlin, 2003. Matroids, trees, stable sets, Chapters 39–69.
- [Sch03c] A. Schrijver. *Combinatorial optimization. Polyhedra and efficiency. Vol. C*, volume 24 of *Algorithms and Combinatorics*. Springer-Verlag, Berlin, 2003. Disjoint paths, hypergraphs, Chapters 70–83.
- [Smi97] M. J. Smith. Generating spanning trees. Master’s thesis, University of Victoria, 1997.
- [Sta86] R. P. Stanley. Two poset polytopes. *Discrete Comput. Geom.*, 1(1):9–23, 1986.
- [SW12] J. Sawada and A. Williams. Efficient oracles for generating binary bubble languages. *Electron. J. Combin.*, 19(1):Paper 42, 20 pp., 2012.
- [SW16] J. Sawada and A. Williams. Greedy flipping of pancakes and burnt pancakes. *Discrete Appl. Math.*, 210:61–74, 2016.
- [Tho04] M. Thorup. Integer priority queues with decrease key in constant time and the single source shortest paths problem. *J. Comput. System Sci.*, 69(3):330–353, 2004.
- [Uno97] T. Uno. Algorithms for enumerating all perfect, maximum and maximal matchings in bipartite graphs. In *Algorithms and computation (Singapore, 1997)*, volume 1350 of *Lecture Notes in Comput. Sci.*, pages 92–101. Springer, Berlin, 1997.
- [Uno99] T. Uno. A new approach for speeding up enumeration algorithms and its application for matroid bases. In *Computing and combinatorics (Tokyo, 1999)*, volume 1627 of *Lecture Notes in Comput. Sci.*, pages 349–359. Springer, Berlin, 1999.
- [Wal03] T. Walsh. Generating Gray codes in $O(1)$ worst-case time per word. In *Discrete mathematics and theoretical computer science*, volume 2731 of *Lecture Notes in Comput. Sci.*, pages 73–88. Springer, Berlin, 2003.
- [Wil13] A. Williams. The greedy Gray code algorithm. In *Algorithms and data structures*, volume 8037 of *Lecture Notes in Comput. Sci.*, pages 525–536. Springer, Heidelberg, 2013.
- [YKW10] T. Yamada, S. Kataoka, and K. Watanabe. Listing all the minimum spanning trees in an undirected graph. *Int. J. Comput. Math.*, 87(14):3175–3185, 2010.
- [Zak84] S. Zaks. A new algorithm for generation of permutations. *BIT*, 24(2):196–204, 1984.
- [Zie95] G. M. Ziegler. *Lectures on polytopes*, volume 152 of *Graduate Texts in Mathematics*. Springer-Verlag, New York, 1995.