

Indonesian Text-to-Image Synthesis with Sentence-BERT and FastGAN

Made Raharja Surya Mahadi¹ and Nugraha Priya Utama¹

¹School of Engineering and Informatics Institute Technology Bandung
23520022@std.stei.itb.ac.id
utama@informatika.org

ABSTRACT

Currently, text-to-image synthesis uses text encoder and image generator architecture. Research on this topic is challenging. This is because of the domain gap between natural language and vision. Nowadays, most research on this topic only focuses on producing a photo-realistic image, but the other domain, in this case, is the language, which is less concentrated. A lot of the current research uses English as the input text. Besides, there are many languages around the world. Bahasa Indonesia, as the official language of Indonesia, is quite popular. This language has been taught in Philippines, Australia, and Japan. Translating or recreating a new dataset into another language with good quality will cost a lot. Research on this domain is necessary because we need to examine how the image generator performs in other languages besides generating photo-realistic images. To achieve this, we translate the CUB dataset into Bahasa using google translate and manually by humans. We use Sentence BERT as the text encoder and FastGAN as the image generator. FastGAN uses lots of skip excitation modules and auto-encoder to generate an image with resolution $512 \times 512 \times 3$, which is twice as bigger as the current state-of-the-art model (Zhang, Xu, Li, Zhang, Wang, Huang and Metaxas, 2019). We also get 4.76 ± 0.43 and 46.401 on Inception Score and Fréchet inception distance, respectively, and comparable with the current English text-to-image generation models. The mean opinion score also gives as 3.22 out of 5, which means the generated image is acceptable by humans. Link to source code: <https://github.com/share424/Indonesian-Text-to-Image-synthesis-with-Sentence-BERT-and-FastGAN>

Keywords: Generative Adversarial Networks, Text-to-Image Synthesis, Bahasa Indonesia

1 Introduction

Text-to-Image generation is challenging task because there is a domain gap between natural language and vision. Nowadays, researchers use text encoder and image generator architecture to produce photo-realistic images (Reed, Akata, Yan, Logeswaran, Schiele and Lee, 2016; Zhang et al., 2019; Qiao, Zhang, Xu and Tao, 2019b; Tsue, Li and Sen, 2020; Hu, Liao, Yang and Rosenhahn, 2021; Xu, Zhang, Huang, Zhang, Gan, Huang and He, 2018). They use CNN-LSTM as the text encoder and Generative Adversarial Networks proposed by Goodfellow, Pouget-Abadie, Mirza, Xu, Warde-Farley, Ozair, Courville and Bengio 2014 as the image generator.

Lots of research in this area focus on how to generate a photo-realistic image, but on the other hand, research on the language area is rarely done. There is a thousand language across the world. One of the popular languages in South-East Asia is Bahasa Indonesia. Bahasa Indonesia is the official language of Indonesia and has been taught in the Philippines, Australia, and Japan. This language is also used in other countries such as Canada, Vietnamese, and Ukraine.

The main problem why research in this area is rarely done is because translating or creating a new dataset with good quality for those languages needs much cost. To examine how well text-to-image generation models perform in other languages, we translate the dataset using Google Translate. To increase the translation result, we also manually translate some of them.

To maintain the resolution of the generated image, we use FastGAN (Liu, Zhu, Song and Elgammal, 2021) as the image generator, which is can generate high-resolution image and comparable with StyleGAN2 (Karras, Laine, Aittala, Hellsten, Lehtinen and Aila, 2020). FastGAN proposed a skip excitation module, which is a skip connection layer. This architecture can generate a high-resolution image in just minimal iteration. The discriminator used auto-encoder-like architecture to distinguish real and fake images. To get better results, we also use Sentence-BERT (Reimers and Gurevych, 2020) as the text encoder. Sentence-BERT can produce text embedding with lower cosine similarity on similar semantic sentence and vice versa.

2 Related Works

Nowadays, text-to-image generation uses a text encoder and image generator architecture. Mansimov, Parisotto, Ba and Salakhutdinov 2016 first proposed a method that uses deep learning, where LSTM as the text encoder and DRAW as the image generator. This method will generate an image by patches based on the attended features on the text. Next, Reed et al. 2016 uses Generative Adversarial Networks (Goodfellow et al., 2014) as the image generator, and CNN-LSTM as the text encoder. The text encoder generates text embedding and concatenates it with random vector $Z \sim \mathcal{N}(0, 1)$. This latent vector is also used as input in the discriminator, making the discriminator distinguish wrong images.

In order to generate high-resolution image, Zhang et al. 2019 uses a stack of GAN to generate an image from low features to higher features. They proposed Conditioning Augmentation networks to generate smooth latent vectors and small random perturbations to increase the generated images variations. They also proposed a JCU discriminator to perform the unconditional and conditional tasks. The unconditional GAN discriminator can only distinguish between real and fake images, and the conditional GAN discriminator can distinguish real, fakes, and wrong images. They use three stacks of GAN: the first GAN generates 64×64 images, the second GAN generates 128×128 images, and the last GAN generates 256×256 . This method becomes the first and state-of-the-art photo-realistic text to image generation.

Xu et al. 2018 proposed Attention GAN to improve the generated image using word-level attention. They proposed a new Deep Attentional Multimodal Similarity Model (DAMSM) to perform the attention. While Qiao et al. 2019b use different approaches by improving the learning text-to-image generation idea using their proposed new module, Semantic Text Module (STEM), Global-Local collaborative Attentive Module in Cascaded Image Generators (GLAM), and Semantic Text Regeneration and Alignment Module (STREAM). STEM perform text embedding using global sentence features and word-level features. GLAM is a multi-stage Generator to generate a realistic image. STREAM is an image captioning module that semantically aligns with the given text descriptions.

In the same year, Qiao, Zhang, Xu and Tao 2019a also proposed a new method to perform text-to-image generation, which is inspired by how humans draw a picture from a given description. To mimic this process, they propose LeicaGAN, which consists of three-phase, firstly is multiple priors learning via Textual-Visual Co-Embedding (TVE), next is Imagination via Multiple Priors Aggregations (MPA), and the last one is Creation via Cascaded Attentive Generator (CAG). TVE is a module that generates text embedding with the same common semantic space as an image. MPA is used to imagine what image will be generated. The text embedding and text mask from the TVE module are used to convey visual information about the semantics, textures, colors, shapes, and layouts. CAG module is the actual generator module to produce the image.

To improve the attention results from Xu et al. 2018, Tsue et al. 2020 use BERT (Devlin, Chang, Lee and Toutanova, 2019) as the text encoder and CycleGAN (Zhu, Park, Isola and Efros, 2017) as the Generator. They proposed a new cyclic design to learn and map the generated image back to text descriptions. This method increases the inception score significantly.

Currently, to generate high-resolution images, researchers use a multi-stage generator. This makes the model size is significantly huge. Liu, Lin, Cao, Hu, Wei, Zhang, Lin and Guo 2021 proposed new lightweight GAN architecture that can be trained on a small amount of image and minimum computing cost to generate a high-resolution image on 1024×1024 . They use skip-layer channel-wise excitation module and an auto-encoder-like discriminator to generate a high-resolution image that can be compared to the state-of-the-art StyleGAN2 (Karras et al., 2020).

Many research focuses on generating high-resolution images and semantically correct with the given text description. But research on the text encoder and other languages is necessary. CNN-LSTM has become popular text embedding since Reed et al. 2016 use that method. Then Xu et al. 2018 improve the text encoder with word-level attention to improve the generated image details. And then Tsue et al. 2020 use BERT as text encoder and word embedding. One of the BERT variants that is suitable for sentence embedding is Sentence BERT (Reimers and Gurevych, 2020). This variant uses a siamese architecture network to produce text embedding that can then be compared with cosine similarity to find sentence with similar meanings.

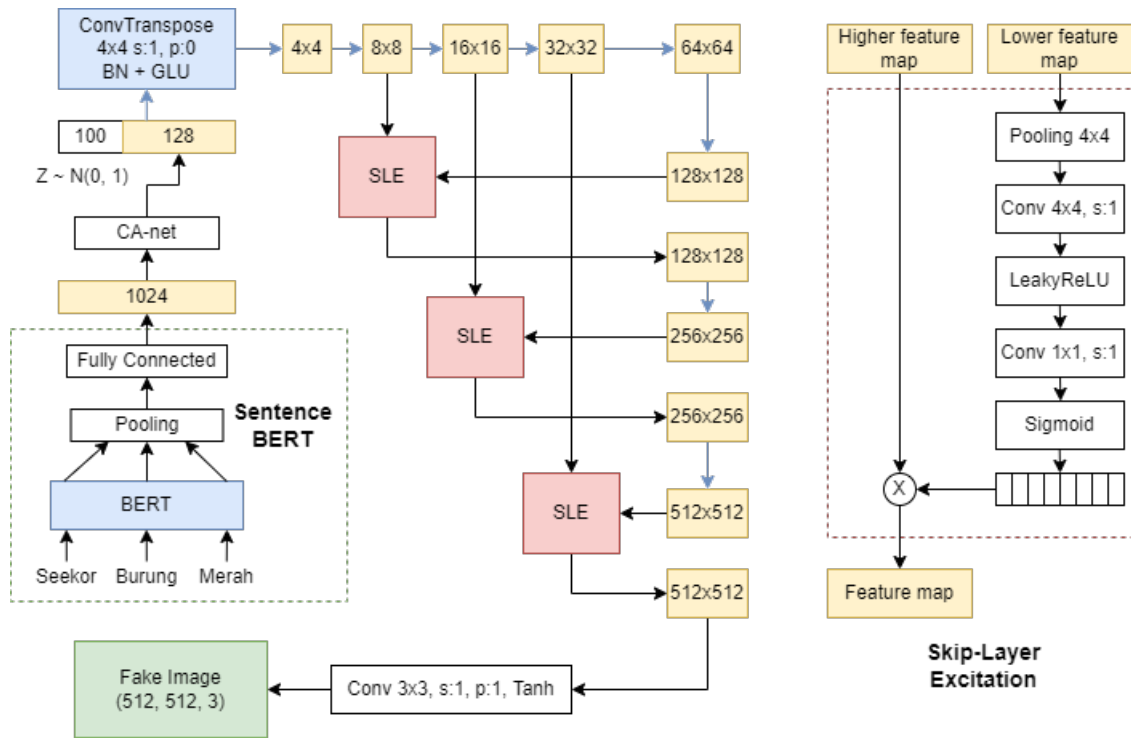

Figure 1: Our Generator Architecture. The blue box and arrow represent the same up-sampling structure, the Yellow box represents the features map on the spatial size, and the red box represents the skip-layer excitation module.

3 Dataset

In this research, we only use CUB dataset (Wah, Branson, Welinder, Perona and Belongie, 2011) and translated into Bahasa Indonesia using google translate and manually by humans. This dataset contains 200 birds species and almost 12k images. Each image has 10 captions in English. We split the dataset into 8.855 as training data and 2.933 as validation data. This makes the total captions for training data is 88.550 and 29.330 for the validation data. Because we use google translate as the translation tool, we cannot expect the translation results grammatically correct. So we were trying to fix this as much as possible manually.

4 Method

4.1 Text Encoder

To generate an image from a given text description, we need to extract the feature from the given text and use that feature as input to the image generator. The easiest way to achieve this is to use text embedding. Current state-of-the-art language modeling is BERT (Devlin et al., 2019), and their variant for generating text embedding is Sentence BERT (Reimers and Gurevych, 2020). This architecture uses a siamese network to perform the training process.

Usually, BERT produces a sequence of word features. The easiest way to generate a single fixed-vector as the text embedding is to feed the output into the pooling layer. As seen in the

figure 1, the output from the BERT is forwarded into the pooling layer to generate a fixed vector. We can feed the feature into fully connected layers to generate different vector sizes.

To train this module, first, we need to pre-train the BERT. Currently, there are state-of-the-art pre-trained BERT models in Bahasa Indonesia trained by (Wirawan, 2020) using 522MB of Indonesian Wikipedia. This model is uncased and trained under Masked Language Modeling (MLM) objective. The generated word features vector shape is 786. We increase the output size to 1024 using a fully connected layer.

Next, fine-tune the model using siamese network architecture. The loss function plays an important role here because it can determine how well the model performs on a specific task. We use cosine similarity loss with $[0.8, 1)$ on positive pair and $[0.4, 0.6]$ on negative pair. Sentence with same image class is positive pair and vice versa. Because every sentence on the dataset talks about birds, we did not use the non-zero label on the negative pair.

4.2 Image Generator

To perform image generation, we need a model that can generate images from given features vector from the text encoder. To achieve this, we can use Generative Adversarial Networks (GAN) (Goodfellow et al., 2014). GAN can generate high-resolution images from a single latent vector. To build GAN architecture, we need a generator and discriminator. Generator and discriminator need input from the text encoder to distinguish real, fake, and wrong images.

In order to generate high-resolution images, we use FastGAN (Liu, Zhu, Song and Elgammal, 2021) as the image generator. We can train this model with minimal effort to generate high-resolution images. Data augmentation plays an important role in this architecture.

4.2.1 Generator

Liu, Zhu, Song and Elgammal 2021 proposed a novel skip-layer excitation module with reformulate the skip-connection idea from ResNet (He, Zhang, Ren and Sun, 2016). They use channel-wise multiplication between the activations to reduce the computational cost. Since the channel-wise multiplication does not require equal spatial dimension, we can perform a skip-connection layer between longer range resolutions, making a long shortcut to the gradient flow.

Skip excitation module can be defined as:

$$y = F(x_{low}, \{W_i\}) \cdot x_{high} \quad (4.1)$$

Where x is the input feature, and y is the output feature-maps, the function F performs the operation on the lower feature of x , and W_i is the weights to be learned.

Figure 1 illustrate our Generator architecture with the output image is $512 \times 512 \times 3$. In order to generate diversity image from a single text description, We use the conditioning variable \hat{c}

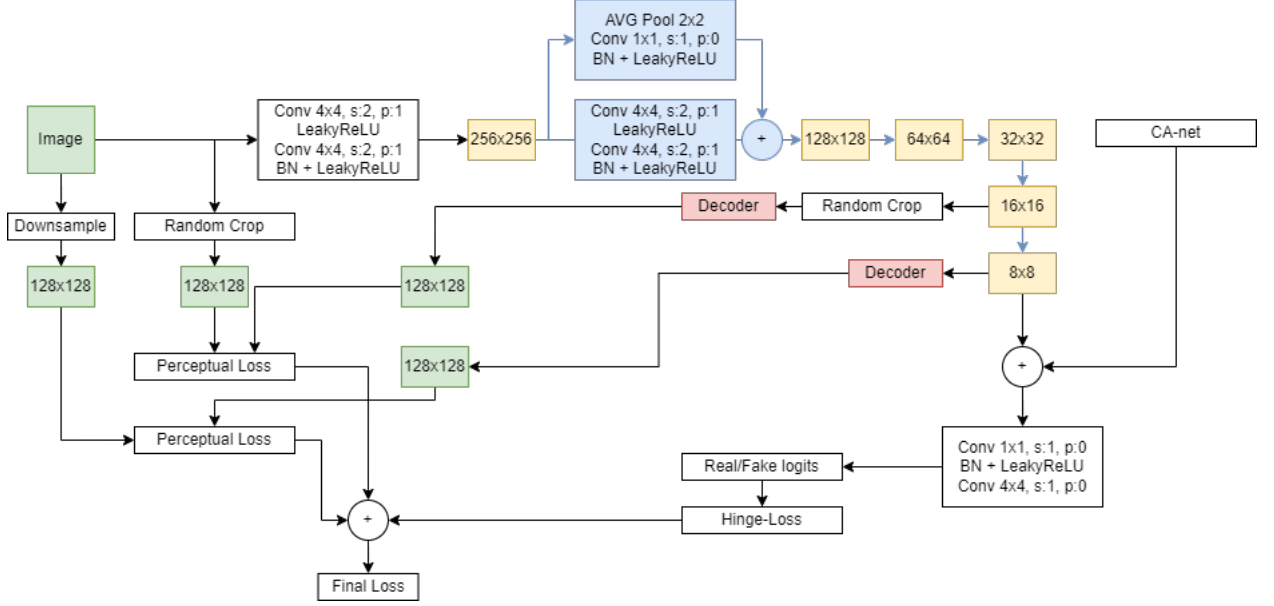

Figure 2: Our Discriminator Architecture. Blue box and arrow represent the same down-sampling structure, Yellow box represent the features map on the spatial size, and red box represent the decoder module

from CA-net (Zhang et al., 2019) and concatenate it with the random vector $z \sim \mathcal{N}(0, 1)$. To obtain \hat{c} , we can use equation 4.2

$$\hat{c} = \mu + \sigma \odot z \quad (4.2)$$

Feed the text embedding φ_t into a fully connected layer to obtain μ and σ (first-half element is μ and the rest is σ). The \odot symbol is element-wise multiplication. The output dimension of the \hat{c} is 128, and the z dimension is 100, which makes our latent vector dimension is 228. We find that normal distribution performs better than the uniform distribution for generating z vector.

4.2.2 Discriminator

In order to perform strong regularization of the discriminator, we can treat the discriminator as auto-encoder-like architecture. There are differences with typical auto-encoder architecture, where the discriminator only decodes the image for real images on small resolution. The discriminator also performs a random crop with $\frac{1}{8}$ of its height and width on both input real images and the generated image from the decoder. The decoder only consists of $4 \times$ nearest up-sampling layer, 3×3 convolution layer, Batch Normalization, and GLU activation function. This technique makes the discriminator learn how to reproduce the input image.

In order to perform conditional GAN, we use the $\mu(\varphi_t)$ from the CA-net and concatenate it with the extracted feature from the discriminator, where φ_t is the text embedding. To calculate the total loss of this architecture, we divide it into two conditions. The first is when the input is the real images. We use perceptual loss (Zhang, Isola, Efros, Shechtman and Wang, 2018) to the auto-encoder-like architecture and hinge adversarial loss (Lim and Ye, 2017) to the

discriminator output and sum the total. And the last one is when the input is the fake or wrong image, we only use the hinge adversarial loss from the generator output.

We can define the loss function for the generator and discriminator as:

$$\begin{aligned}
\mathcal{L}_{percept} &= \mathbb{E}_{f \sim D_{encode}(x), x \sim I_{real}} [||\mathcal{G}(f) - \mathcal{T}(x)||] \\
\mathcal{L}_D &= -\mathbb{E}_{x \sim I_{real}} [\min(0, -1 + D(x, \mu))] \\
&\quad - \mathbb{E}_{x' \sim I_{wrong}} [\min(0, -1 - D(x', \mu))] \\
&\quad - \mathbb{E}_{\hat{x} \sim G(z, \hat{c})} [\min(0, -1 - D(\hat{x}, \mu))] \\
&\quad + \mathcal{L}_{percept} \\
\mathcal{L}_G &= -\mathbb{E}_{z \sim \mathcal{N}} [D(G(z, \hat{c}), \mu)]
\end{aligned} \tag{4.3}$$

where $\mathcal{L}_{percept}$ is the perceptual loss from (Zhang et al., 2018), μ is the variational text embedding from equation 4.2.

5 Experiment

5.1 Training Details

In this section will explain the training details for both text encoder and image generator in this research.

5.1.1 Text Encoder

In order to train Sentence BERT, we need pre-trained BERT models. In this research, we use (Wirawan, 2020) pre-trained BERT on Bahasa Indonesia language. We need appropriate labels for both positive and negative pairs to get better results. In the section 4.1, we explain that we use $[0.8, 1)$ as the positive pair label and $[0.4, 0.6]$ as the negative pair labels. To train Sentence BERT, we pass both sentences in the pair to the same networks, compare them with cosine similarity, and perform mean-squared error to calculate the loss value. We train our models for 10 epochs and save the best model only.

5.1.2 Image Generator

We perform both unconditional and conditional tasks to compare the results. We train our models within 50.000 iterations and batch size 10. First, we encode all text descriptions into their embedding vector φ_t .

Unconditional. In this part, we only feed the generator with random vector $z \sim \mathcal{N}(0, 1)$ and conditioning text embedding \hat{c} . Because every image has 10 captions, we select one randomly and feed it into CA-net. The real and fake images are then augmented with random color brightness, saturation, contrast, and translation. Next, we calculate the loss value to update the discriminator. For the real images, we perform both perceptual and hinge loss from equation 4.3 (without the wrong image part).

Conditional. We perform the same things with the generator on the unconditional task for this task. We feed real, wrong, and fake images with the conditioning augmentation vector μ from the CA-net in the discriminator. We calculate the loss using the equation 4.3.

5.2 Evaluation

To evaluate generative models is quite challenging because calculating the suitability of the resulting image with the given text is challenging to do. So we perform both quantitative and qualitative evaluation metrics.

Inception Score. This method calculates the distribution of the generated images. It makes us can calculate how the objectness of the generated image. Inception score is often used as an evaluation metric on generative models.

Fréchet inception distance. On the other hand, Fréchet inception distance (Heusel, Ramsauer, Unterthiner, Nessler and Hochreiter, 2017) has a better approach. This method calculates the distance between training and fake images data distribution. However, this method still cannot evaluate how appropriate the generated image is with the given text description.

Mean Opinion Score. In order to perform qualitative evaluation, we evaluate our models by conducting a survey. The respondent will be given 10 pair of fake images and their text description. Every fake image consists of 4 generated images. They will select one of them and then do scoring between 0 and 5. While 0 means the generated image is not appropriate with the given text description and the image is not clear, and 5 means the generated image is appropriate with the given text description and the generated image is clear.

6 Results

We train both text encoder and image generator separately and then combine them on evaluation. To investigate our models, we also compare them with current state-of-the-art text-to-image synthesis models to examine how the text encoder performs in a different language, especially Bahasa Indonesia.

As shown in figure 3, our text encoder reaches the best score at epoch 3 within 0.82 on cosine pearson. This means our text encoder can produce text embedding with higher cosine similarity on the similar sentence and vice versa.

The fréchet inception distance and inception score of our model compared with other English text-to-image synthesis are shown in Table 1. Our model easily beats StackGAN, AttentionGAN, and MirrorGAN on the inception score, which means our model can generate high-quality objects. However, our FID is higher than other models, which means our models, compared to the training data, have different data distribution and makes our generated images different from our datasets.

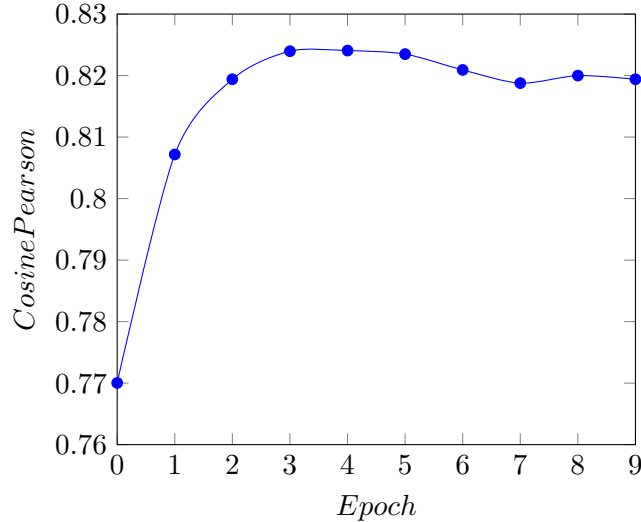

Figure 3: Text encoder training results

Table 1: Evaluation results both on Inception Score and Fréchet inception distance compared with other English text-to-image generation models on CUB datasets

Method	Inception Score	FID
AttGAN (Xu et al., 2018)	4.36 ± 0.03	23.98
StackGAN (Zhang et al., 2019)	4.04 ± 0.05	15.30
MirrorGAN (Qiao et al., 2019b)	4.56 ± 0.05	-
CycleGAN+BERT (Tsue et al., 2020)	5.92	-
SSA-GAN (Hu et al., 2021)	5.17 ± 0.08	15.61
Our Unconditional	4.75 ± 0.19	99.12
Our Conditional	4.76 ± 0.43	46.401

The Inception Score for our unconditional GAN is slightly lower than our conditional GAN but has a much higher FID. This means our unconditional and conditional GAN has the same objectness but different image data distribution against the datasets.

As shown in Table 2, we find out that our unconditional GAN is on collapse modes. This is a common problem on generative adversarial networks because the generator always tries to produce a similar image to fool the discriminator. This can happen when the discriminator cannot distinguish between fake and real images from different inputs. On the other hand, the conditional GAN can fix this problem using the conditioning augmentation from CA-net as input for the discriminator.

The conditional GAN also produces some novel images. The generator tries to generate a red bird with blue wings on the third output, which does not exist in the datasets. However, there is a red bird with black wings, so the generator is trying to change the wing color to blue. That makes the wing dark blue. Furthermore, there is no yellow bird on the water in the dataset, but the generator is trying to output that in the last sentence. So the generator is trying to change the existing yellow bird background with something like water.

Table 2: Examples of images generated by our Unconditional and Conditional GAN. The input sentences in English is "A red bird perched on a tree branch", "This bird has yellow wing and black beak", "A bird with blue wing and red tail", "A blackbird perched on a tree", and "A yellow bird on the water"









Sentence	Unconditional	Conditional
seekor burung merah yang hinggap di cabang pohon		
burung ini memiliki sayap berwarna kuning dengan paruh berwarna hitam		
seekor burung dengan sayap berwarna biru dan ekor berwarna merah		
seekor burung hitam sedang bertengger di atas pohon		
seekor burung kuning di atas air		

Table 3: The mean opinion score for both our unconditional and conditional GAN

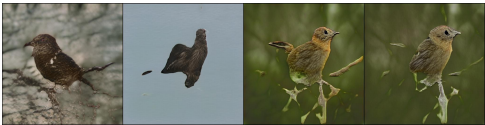
Method	Mean Opinion Score
Our Unconditional	1.41
Our Conditional	3.22

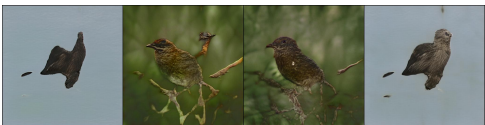
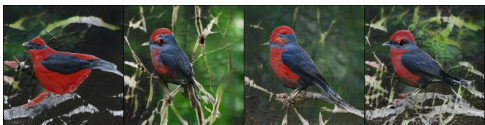
In order to perform a qualitative evaluation, we conduct a survey and average the results. As shown in Table 3, our conditional GAN easily beats our unconditional GAN. The mean opinion score of the conditional GAN is 3.22, which means our models are still acceptable by humans.

7 Conclusion

This research investigates the text-to-image synthesis performance in different languages, especially Bahasa Indonesia. To break through the gap between natural language and vision,

we use the current state-of-the-art sentence embedding, Sentence BERT as the text encoder. In order to generate photo-realistic images within minimal training effort, we use FastGAN as the image generator. We implement the Conditioning Augmentation network to make the generated images more diverse and use its output as input for generator and discriminator. This makes our conditional GAN perform superior to generating novel images. Our proposed architecture can generate high-resolution images using Bahasa Indonesia as the input language.

For future works, we suggest properly translating the datasets to produce a high-quality language model. We find out that text embeddings play an essential role in generating the image details. Implementing weighted sum on the discriminator loss also can produce high-quality images. AttentionGAN (Xu et al., 2018) become another alternative to produce high-quality details. Using another challenging dataset such as COCO datasets (Lin, Maire, Belongie, Bourdev, Girshick, Hays, Perona, Ramanan, Zitnick and Dollár, 2014) or even ImageNet datasets can evaluate the model performance on different image distributions. It would be helpful to train the model longer to increase the inception score and FID. Trying other GAN variants also can produce different image resolutions, such as StyleGAN2 (Karras et al., 2020).

References

- Devlin, J., Chang, M. W., Lee, K. and Toutanova, K. 2019. BERT: Pre-training of deep bidirectional transformers for language understanding, *NAACL HLT 2019 - 2019 Conference of the North American Chapter of the Association for Computational Linguistics: Human Language Technologies - Proceedings of the Conference* **1**(Mlm): 4171–4186.
- Goodfellow, I., Pouget-Abadie, J., Mirza, M., Xu, B., Warde-Farley, D., Ozair, S., Courville, A. and Bengio, Y. 2014. Generative adversarial nets, *in* Z. Ghahramani, M. Welling, C. Cortes, N. D. Lawrence and K. Q. Weinberger (eds), *Advances in Neural Information Processing Systems 27*, Curran Associates, Inc., pp. 2672–2680.
URL: <http://papers.nips.cc/paper/5423-generative-adversarial-nets.pdf>
- He, K., Zhang, X., Ren, S. and Sun, J. 2016. Deep residual learning for image recognition, *Proceedings of the IEEE Computer Society Conference on Computer Vision and Pattern Recognition 2016-Decem*: 770–778.
- Heusel, M., Ramsauer, H., Unterthiner, T., Nessler, B. and Hochreiter, S. 2017. GANs trained by a two time-scale update rule converge to a local Nash equilibrium, *Advances in Neural Information Processing Systems 2017-December*(Nips): 6627–6638.
- Hu, K., Liao, W., Yang, M. Y. and Rosenhahn, B. 2021. Text to Image Generation with Semantic-Spatial Aware GAN, (1).
URL: <http://arxiv.org/abs/2104.00567>
- Karras, T., Laine, S., Aittala, M., Hellsten, J., Lehtinen, J. and Aila, T. 2020. Analyzing and improving the image quality of stylegan, *Proceedings of the IEEE Computer Society Conference on Computer Vision and Pattern Recognition* pp. 8107–8116.

- Lim, J. H. and Ye, J. C. 2017. Geometric gan.
- Lin, T.-Y., Maire, M., Belongie, S., Bourdev, L., Girshick, R., Hays, J., Perona, P., Ramanan, D., Zitnick, C. L. and Dollár, P. 2014. Microsoft coco: Common objects in context. cite arxiv:1405.0312Comment: 1) updated annotation pipeline description and figures; 2) added new section describing datasets splits; 3) updated author list.
URL: <http://arxiv.org/abs/1405.0312>
- Liu, B., Zhu, Y., Song, K. and Elgammal, A. 2021. Towards Faster and Stabilized GAN Training for High-fidelity Few-shot Image Synthesis, pp. 1–22.
URL: <http://arxiv.org/abs/2101.04775>
- Liu, Z., Lin, Y., Cao, Y., Hu, H., Wei, Y., Zhang, Z., Lin, S. and Guo, B. 2021. Swin Transformer: Hierarchical Vision Transformer using Shifted Windows.
URL: <http://arxiv.org/abs/2103.14030>
- Mansimov, E., Parisotto, E., Ba, J. L. and Salakhutdinov, R. 2016. Generating images from captions with attention, *4th International Conference on Learning Representations, ICLR 2016 - Conference Track Proceedings* pp. 1–12.
- Qiao, T., Zhang, J., Xu, D. and Tao, D. 2019a. Learn, imagine and create: Text-to-image generation from prior knowledge, *Advances in Neural Information Processing Systems 32*(NeurIPS): 1–11.
- Qiao, T., Zhang, J., Xu, D. and Tao, D. 2019b. Mirrorgan: Learning text-to-image generation by redescription, *Proceedings of the IEEE Computer Society Conference on Computer Vision and Pattern Recognition 2019-June*: 1505–1514.
- Reed, S., Akata, Z., Yan, X., Logeswaran, L., Schiele, B. and Lee, H. 2016. Generative adversarial text to image synthesis, *33rd International Conference on Machine Learning, ICML 2016 3*: 1681–1690.
- Reimers, N. and Gurevych, I. 2020. Sentence-BERT: Sentence embeddings using siamese BERT-networks, *EMNLP-IJCNLP 2019 - 2019 Conference on Empirical Methods in Natural Language Processing and 9th International Joint Conference on Natural Language Processing, Proceedings of the Conference* pp. 3982–3992.
- Tsue, T., Li, J. and Sen, S. 2020. Cycle Text-to-Image GAN with BERT, *arXiv* .
- Wah, C., Branson, S., Welinder, P., Perona, P. and Belongie, S. 2011. The Caltech-UCSD Birds-200-2011 Dataset, *Technical Report CNS-TR-2011-001*, California Institute of Technology.
- Wirawan, C. 2020. Indonesian BERT base model (uncased), <https://huggingface.co/cahya/bert-base-indonesian-522M>. [Online; accessed 30-August-2021].
- Xu, T., Zhang, P., Huang, Q., Zhang, H., Gan, Z., Huang, X. and He, X. 2018. AttnGAN: Fine-Grained Text to Image Generation with Attentional Generative Adversarial Networks,

Proceedings of the IEEE Computer Society Conference on Computer Vision and Pattern Recognition pp. 1316–1324.

Zhang, H., Xu, T., Li, H., Zhang, S., Wang, X., Huang, X. and Metaxas, D. N. 2019. StackGAN++: Realistic Image Synthesis with Stacked Generative Adversarial Networks, *IEEE Transactions on Pattern Analysis and Machine Intelligence* **41**(8): 1947–1962.

Zhang, R., Isola, P., Efros, A. A., Shechtman, E. and Wang, O. 2018. The Unreasonable Effectiveness of Deep Features as a Perceptual Metric, *Proceedings of the IEEE Computer Society Conference on Computer Vision and Pattern Recognition* (1): 586–595.

Zhu, J. Y., Park, T., Isola, P. and Efros, A. A. 2017. Unpaired Image-to-Image Translation Using Cycle-Consistent Adversarial Networks, *Proceedings of the IEEE International Conference on Computer Vision* **2017-October**: 2242–2251.