RECENT ADVANCEMENTS IN DEEP LEARNING APPLICATIONS AND METHODS FOR AUTONOMOUS NAVIGATION - A COMPREHENSIVE REVIEW

Arman Asgharpoor Golroudbari

Department of Aerospace,
Faculty of New Sciences & Technologies,
University of Tehran,
Tehran, Iran
a.asgharpoor@ut.ac.ir

Mohammad Hossein Sabour

Department of Aerospace,
Faculty of New Sciences & Technologies,
University of Tehran,
Tehran, Iran
sabourmh@ut.ac.ir

ABSTRACT

This review article is an attempt to survey all recent AI based techniques used to deal with major functions in This review paper presents a comprehensive overview of end-to-end deep learning frameworks used in the context of autonomous navigation, including obstacle detection, scene perception, path planning, and control. The paper aims to bridge the gap between autonomous navigation and deep learning by analyzing recent research studies and evaluating the implementation and testing of deep learning methods. It emphasizes the importance of navigation for mobile robots, autonomous vehicles, and unmanned aerial vehicles, while also acknowledging the challenges due to environmental complexity, uncertainty, obstacles, dynamic environments, and the need to plan paths for multiple agents. The review highlights the rapid growth of deep learning in engineering data science and its development of innovative navigation methods. It discusses recent interdisciplinary work related to this field and provides a brief perspective on the limitations, challenges, and potential areas of growth for deep learning methods in autonomous navigation. Finally, the paper summarizes the findings and practices at different stages, correlating existing and future methods, their applicability, scalability, and limitations. The review provides a valuable resource for researchers and practitioners working in the field of autonomous navigation and deep learning.

Keywords Deep Learning · Navigation · Inertial Sensors, Intelligent Filter · Sensor Fusion · Long-Short Term Memory · Convolutional Neural Network

1 Introduction

Navigation is a critical task for systems that operate in dynamic environments, including robots, autonomous systems, and unmanned aerial vehicles [1]. It requires the ability to perceive the surroundings, plan a path, execute it, and adapt as needed, all while avoiding obstacles and collisions to ensure safe, efficient, and accurate travel. Recent developments in deep learning have made navigation more reliable, effective, and efficient, enabling its use in a wide range of applications, including transportation, search and rescue, and delivery. Autonomous systems are becoming increasingly prevalent and can determine their actions based on the current situation. These systems have numerous uses, such as self-driving cars [2], drones [3], and search-and-rescue robots [4].

Autonomous systems fall into two broad categories [5]: reactive and deliberative. **Reactive systems**, also known as behavior-based systems, are designed to respond to the environment using predefined rules. These systems are typically used in robotics applications, where the environment is relatively stable, and the system has a specific task, such as pick and place. On the other hand, **deliberative systems** are designed to plan and execute a path to a destination. These systems are commonly used in transportation, where the environment is complex, and the system must navigate efficiently and safely.

The deliberative systems can be further classified into two categories [6]: (1) model-based and (2) model-free systems. Model-based systems use a mathematical model of the environment to plan a path, such as using dynamic programming or graph search algorithms [7]. Model-free systems, also known as model-agnostic systems, do not rely on a model of the environment to plan a path [8]. Instead, these systems use techniques such as Reinforcement Learning [9] or Apprenticeship Learning [10] to learn the optimal policy for navigation. The choice of autonomous system, whether reactive or deliberative and model-based or model-free, depends on the specific requirements and constraints of the task.

Autonomous systems require effective and successful navigation to operate in dynamic environments without human intervention and guidance. This involves integrating various technologies, including sensors, actuators, and control systems. To improve the accuracy, efficiency, and robustness of navigation algorithms, deep learning has been applied to various navigation tasks such as perception and planning. Deep learning’s ability to learn complex representations from vast amounts of data is well-suited for these tasks, such as image analysis and integrating multiple sources of information, such as speech and text. However, deep learning-based navigation systems must overcome challenges such as limited data, reliability, ethical concerns, such as privacy and bias. Techniques such as transfer learning, multi-modal fusion, model uncertainty estimation, and safety-critical architectures can address these challenges. Additionally, differential privacy and fairness-aware machine learning techniques can address privacy and bias concerns, respectively.

The application of deep learning in navigation has seen a rise in recent times, as evidenced by numerous studies and surveys (refer to Tables 1 and 2). Although deep learning holds great promise in enhancing navigation systems, it is crucial to tackle the challenges and ethical considerations that come with its usage. Furthermore, there is a need for further exploration on how deep learning techniques can be integrated with conventional navigation methods.

Numerous surveys have been conducted on the applications of deep learning in various navigation domains, including urban navigation[11], visual navigation [12, 13], reinforcement learning [14, 9], obstacle detection [15], and spacecraft navigation [16, 17]. However, there is a lack of comprehensive surveys that provide a general overview of the use of deep learning in navigation. This survey aims to fill this gap by presenting a comprehensive overview of the applications of deep learning in navigation. The paper is structured as follows: Section 2 provides an overview of deep learning and its methods, while Section 3 discusses the different activation functions used in deep learning. Section 4 presents an overview of navigation, autonomy, and autonomous navigation. Section 5 discusses the applications of deep learning in navigation, and Section 6 delves into the various components of deep learning in autonomous navigation, such as perception, localization, mapping, planning, and control. Finally, Section 7 concludes the paper and highlights future directions.

Table 1: Recent articles on deep learning for navigation

Title	Application
Goal-guided Transformer-enabled Reinforcement Learning for Efficient Autonomous Navigation [18]	Autonomous Navigation
DeepNAVI: A deep learning based smartphone navigation assistant for people with visual impairments [19]	Visual Navigation
Monocular vision with deep neural networks for autonomous mobile robots navigation [20]	Visual Navigation
URWalking: Indoor Navigation for Research and Daily Use [21]	Indoor Navigation
A Simple Self-Supervised IMU Denoising Method For Inertial Aided Navigation [22]	Inertial Navigation
Multi-Scale Fully Convolutional Network-Based Semantic Segmentation for Mobile Robot Navigation [23]	Visual Navigation
Drone Navigation Using Octrees and Object Recognition for Intelligent Inspections [24]	Visual Navigation
Deep learning-enabled fusion to bridge GPS outages for INS/GPS integrated navigation [25]	Inertial Navigation
Deep learning based wireless localization for indoor navigation [26]	Indoor Navigation
Efficient and robust LiDAR-based end-to-end navigation [27]	Terrain modelling
End-to-End Deep Learning Framework for Real-Time Inertial Attitude Estimation using 6DoF IMU [28]	Inertial Navigation

Table 2: Recent surveys on navigation or deep learning for navigation

Year	Topic	Highlight
2017	Unmanned Aerial Vehicles	Deep learning for UAV (navigation, motion control, and situational awareness) [29].
2017	Adaptive Navigation	AI-based planetary rovers autonomous navigation [30].
2019	Deep Learning Approaches	State-of-the-art deep learning approaches [31].
2019	Visual Navigation	Reinforcement Learning for visual autonomous navigation [32].
2020	Deep Learning Approaches	Major architectures and applications of deep learning [33].
2020	Autonomous Driving	Deep learning architectures Autonomous Driving [34].
2020	Inertial Sensors	Enhancement of various aspects of inertial sensors (sensor fusion, calibration, and navigation) [35].
2020	Autonomous Driving	Deep learning architectures for autonomous driving [36].
2020	Perception	Localization and Mapping [37]
2021	Convolutional Neural Networks	Applications of CNNs [38].
2021	Indoor Navigation	Machine learning for indoor localization [39].
2021	Assistive navigation	Outdoor and urban navigation for people with visual impairments [11].
2022	Visual Navigation	Agricultural robot navigation [12].
2022	Spacecraft Navigation	Deep learning for spacecraft dynamics control, guidance and navigation [40].
2022	Visual Navigation	Unmanned underwater vehicles [41].
2022	Unmanned Aerial Vehicle	Reinforcement Learning for UAVs [14].
2022	Autonomous Driving	Visual obstacle detection for unmanned ground vehicles [15]
2022	Autonomous Driving	Deep Learning for Perception [42]
2022	Spacecraft Navigation	Autonomous relative navigation for orbital applications [16]

2 A brief overview of deep learning

In this section we provide a brief overview of deep learning for a more detailed discussion, the reader is referred to [43]. We begin by defining machine learning and deep learning, followed by a brief history of deep learning. We then discuss the different types of deep learning algorithms and their applications.

Machine learning is a subfield of artificial intelligence (AI) which focuses on developing algorithms that allow computers to learn and improve from experience without being explicitly programmed. Machine learning algorithms are designed to identify patterns and make predictions based on data inputs, and the algorithms improve their performance over time as they are exposed to more data. Deep learning, on the other hand, is a subset of machine learning that is based on Artificial Neural Networks (ANN), which are inspired by the structure of the human brain. Deep learning algorithms consist of multiple layers of ANN that are trained to recognize patterns in large amounts of data. Unlike traditional machine learning algorithms, these algorithms can automatically extract and learn relevant features from the data, making them well-suited for tasks such as image and speech recognition, natural language processing, and autonomous navigation. In short, machine learning is a broader field that includes deep learning, but deep learning is a specialized type of machine learning that is based on ANNs [43].

Deep learning has its roots in the 1940s and 1950s with the introduction of the concept of artificial neurons by Warren McCulloch and Walter Pitts [44] which was later extended by Frank Rosenblatt [45] to include a learning mechanism. In 1957, Rosenblatt introduced the perceptron [45], which is single-layer artificial neural network that is used for binary classification and composed of a set of artificial neurons, each of which is connected to an input and has a weight associated with it. The output is determined by the weighted sum of the inputs, which is then passed through an activation function. The weights of the perceptron are adjusted during training to minimize the error between the output and the desired output. However, the field did not gain significant traction until the late 1980s and early 1990s, when the backpropagation algorithm [46] was introduced for training ANNs.

In the early 2000s, deep learning began to be applied to tasks such as image [47] and speech recognition [48]. The success of these early applications led to increased interest in the field and further developments. In the late 2000s and early 2010s, deep learning began to gain significant attention due to the availability of large amounts of data and the development of more powerful hardware for training.

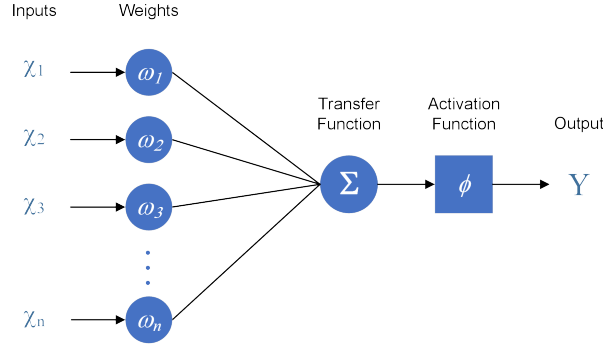

Figure 1: Structure of an artificial neuron

AlexNet [49], a deep convolutional neural network trained on a large dataset of images, achieved state-of-the-art results in the ImageNet visual recognition challenge in 2012, which marked a turning point in deep learning.

Since then, deep learning has been used in a wide range of applications, including image recognition, natural language processing [50], speech recognition [51], self-driving cars [52], healthcare [53], computational biology [54], and gaming [55]. The field has continued to evolve and improve, with the development of new architectures and techniques such as Generative Adversarial Networks (GANs) [56], and attention mechanisms [57].

Today, deep learning is considered a powerful tool for solving complex tasks and is widely used across industries and research fields. With the increasing availability of large amounts of data and powerful computing resources, the future of deep learning looks promising with more advancements and breakthroughs in the field.

There are several common structures of deep neural networks, each of which is suited for different types of tasks and applications. Some of the most common structures will be discussed in the following sections.

2.1 Artificial Neuron

An artificial neuron is a mathematical function that is used to model the behavior of biological neurons. It was first introduced by Warren McCulloch and Walter Pitts in 1943. The idea of artificial neurons is that an input signal weighted by a weight w with a bias b is passed through an activation function f to produce an output signal y [58]. Figure 1 and Equation 1 shows the structure of an artificial neuron.

$$y = f(w \cdot x + b) \quad (1)$$

where the activation function f performs a non-linear transformation on the weighted sum of the inputs.

2.2 Deep Feedforward Neural Networks

A deep feedforward neural network is composed of multiple layers of artificial neurons, each of which is fully connected to the next layer. This type of neural network is also known as a multilayer perceptron (MLP) [43]. All data is passed through the network in a forward direction. The input is passed through the first layer, which is then passed through the second layer, and so on until the output of the network is produced. The output is determined by the output of the last layer. Figure 2 and Equation 2 shows the structure of a deep feedforward neural network.

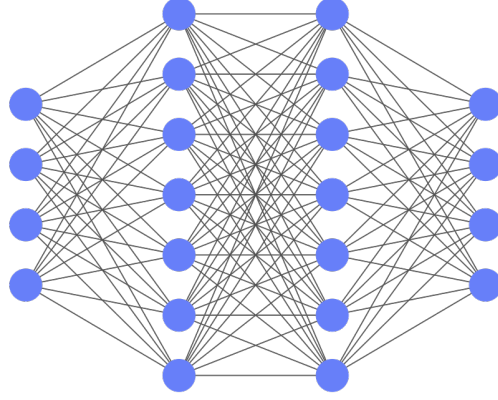

Input Layer $\in \mathbb{R}^4$ Hidden Layer $\in \mathbb{R}^7$ Hidden Layer $\in \mathbb{R}^7$ Output Layer $\in \mathbb{R}^4$

Figure 2: Structure of a deep feedforward neural network

$$\begin{aligned}
 \text{Input: } & \mathbf{x} \in \mathbb{R}^n \\
 \text{Hidden layers: } & \mathbf{h}_1, \mathbf{h}_2, \dots, \mathbf{h}_L \\
 \text{Weights: } & \mathbf{w}_1, \mathbf{w}_2, \dots, \mathbf{w}_L \\
 \text{Biases: } & \mathbf{b}_1, \mathbf{b}_2, \dots, \mathbf{b}_L \\
 \text{Activation function: } & f \\
 \text{Output:} & \\
 & \mathbf{h}_1 = f(\mathbf{w}_1 \cdot \mathbf{x} + \mathbf{b}_1) \\
 & \mathbf{h}_i = f(\mathbf{w}_i \cdot \mathbf{h}_{i-1} + \mathbf{b}_i), \quad i = 2, \dots, L \\
 & \mathbf{y} = \mathbf{w}_L \cdot \mathbf{h}_L + \mathbf{b}_L \\
 \text{Output: } & \mathbf{y} \in \mathbb{R}^m
 \end{aligned} \tag{2}$$

2.3 Autoencoder

An autoencoder is designed to learn a compressed representation of input data and composed of two main parts: (1) encoder and (2) decoder. The encoder takes in the input data and learns to compress it into a lower-dimensional representation, typically called a latent representation or bottleneck. The decoder then takes this compressed representation and learns to reconstruct the original input data from it. The goal is to learn a compressed representation that captures the most important features of the input data while discarding the unnecessary or redundant information. They can be used for a variety of tasks such as dimensionality reduction, data denoising, and generative modeling. There are different variations of autoencoders such as convolutional autoencoder, variational autoencoder, and more. Figure 3 shows the structure of a standard feedforward autoencoder:

2.4 Convolutional Neural Network (CNN)

A CNN used convolution operation to extract features from data. This operation involves combining two sets of data, such as an image and a filter, in order to extract meaningful features from the input. By using this technique, CNNs can identify patterns in complex datasets that would otherwise be difficult or impossible for traditional algorithms to detect. CNNs are particularly useful for tasks such as image recognition, object detection, and image segmentation. It is composed of multiple layers which are arranged in a hierarchical structure, with the lower layers extracting simple features such as edges, and the higher layers extracting more complex features such as patterns and objects. Figure 4 shows the structure of a CNN:

2.5 Deep Belief Networks (DBN)

Deep belief network was first introduced in 2006 by Hinton et al. [59] which is composed of multiple layers of hidden units, where each layer is a Restricted Boltzmann Machine (RBM). RBMs are shallow, two-layer neural networks

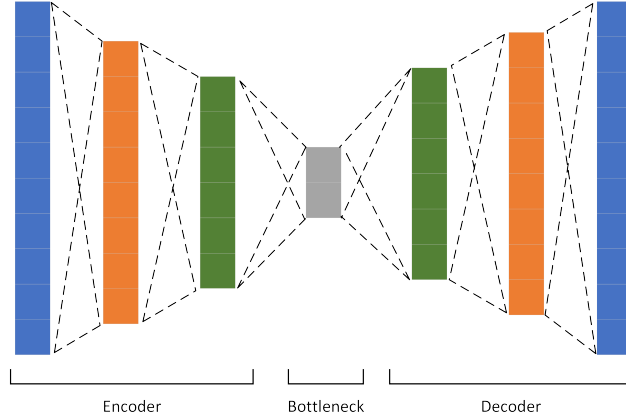

Figure 3: Structure of an autoencoder

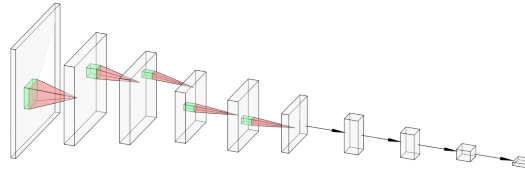

Figure 4: Structure of a CNN

where the visible units are connected to the hidden units, but not to each other. In a DBN, the RBMs are stacked on top of each other to form a deep network. The equation for an RBM can be represented as follows:

$$P(v, h) = \frac{1}{Z} \exp(-E(v, h)) \quad (3)$$

$$E(v, h) = - \sum_i^m b_i v_i - \sum_j^n c_j h_j - \sum_i^m \sum_j^n v_i w_{ij} h_j \quad (4)$$

where v and h are the visible and hidden layer activations respectively, b and c are the biases of the visible and hidden layer, w is the weight matrix between the visible and hidden layer, and Z is the normalizing constant.

DBNs can be trained using an unsupervised learning algorithm, where the input data is used to learn the generative model. DBNs have been applied in several domains, including computer vision, speech recognition, natural language processing, and bioinformatics, for tasks such as image classification, feature extraction, and language recognition.

2.6 Recurrent Neural Network (RNN)

Recurrent neural networks have gained popularity in recent years due to their ability to process sequential data, such as time series, speech, and text. They are characterized by the presence of recurrent connections, which allow information to flow through the network over multiple time steps. This allows RNNs to maintain a hidden state that can be updated at each time step, allowing them to remember previous input and use that information to inform their current output [43].

The most basic form of an RNN is the simple recurrent neural network (SRN), which has a single hidden layer with recurrent connections. The SRN's hidden state at time t , h_t , is a function of the current input x_t and the previous hidden state h_{t-1} . The output y_t is then computed based on the hidden state h_t . The basic equation of a Recurrent Neural

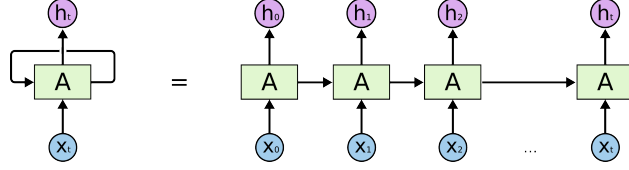

Figure 5: A simple RNN

Network can be represented as follows:

$$\begin{aligned}
 \text{Input: } & x \in \mathbb{R}^n \\
 \text{Output: } & y \in \mathbb{R}^m \\
 \text{Hidden state: } & h \in \mathbb{R}^k \\
 \text{Weights: } & W(hh), W(hx) \\
 \text{Biases: } & b(h) \\
 \text{Activation function: } & f \\
 \text{Output: } & y = f(W(yh)h + b(y))
 \end{aligned} \tag{5}$$

where h is the hidden state, x is the input, $W(hh)$, $W(hx)$ and $b(h)$ are the weights and bias for the hidden state, $W(yh)$ and $b(y)$ are the weights and bias for the output, and f is the activation function. The hidden state at the current time step is a function of the previous hidden state and the current input, with the weights and bias being learned during training. The output of the RNN at each time step is a function of the current hidden state, with the weights and bias for the output also being learned during training. The hidden state at time step t is defined as follows:

$$h(t) = f(W(hh)h(t-1) + W(hx)x(t) + b(h)) \tag{6}$$

where $h(t-1)$ is the hidden state at the previous time step, $x(t)$ is the input at time step t , and f is the activation function. The output of the RNN at each time step is a function of the current hidden state, with the weights and bias for the output also being learned during training.

Long short-term memory (LSTM) and gated recurrent units (GRUs) are two variations of RNNs that have been developed to address the problem of vanishing gradients which occur when the gradients of the parameters of the network become very small during the backpropagation process, making it difficult to train the network [60]. LSTM and GRUs both introduce gating mechanisms that allow the network to selectively choose which information to forget or remember at each time step, thus addressing the vanishing gradients problem.

Another variant of RNNs is the bidirectional RNN (BRNN), which allows the network to take into account future context in addition to past context. In a BRNN, two RNNs are used to process the input in the forward direction and reverse direction. The output of the two RNNs is then concatenated and used as the final output.

RNNs have been used in a variety of applications, including natural language processing, speech recognition, and time series prediction and used for tasks such as language translation, text summarization, sentiment analysis, and forecast future values based on past values.

One of the main benefits of RNNs is their ability to handle sequential data, which allows them to model temporal dependencies and patterns. However, RNNs also have some limitations. One limitation is that they can be sensitive to the order of input data, which can be a problem when dealing with permuted data. Additionally, RNNs can be computationally expensive and may require a large amount of memory to store the hidden states. Figure 5 shows a diagram of a simple RNN.

2.7 Gate Recurrent Unit (GRU)

GRU is introduced by Cho et al. in 2014 [61]. The main difference between a traditional RNN and a GRU is that a GRU has two gates, called the update gate and the reset gate, which control the flow of information between the previous hidden state and the current hidden state.

The update gate controls how much of the previous hidden state should be kept, and the reset gate controls how much of the previous hidden state should be forgotten. This allows a GRU to effectively handle long-term dependencies in the input sequence, as it can selectively choose which information to keep and which to discard.

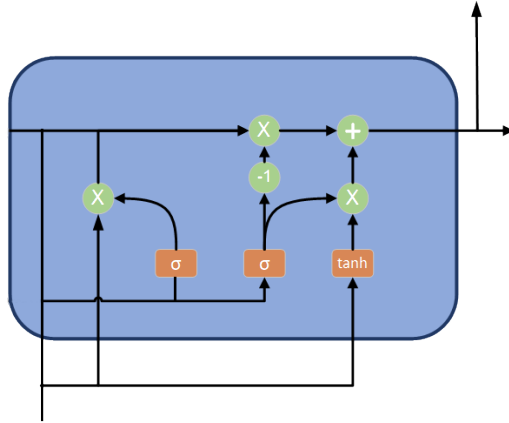

Figure 6: A GRU

The mathematical equation for the hidden state update in a GRU is as follows:

$$h_t = z_t * h_{t-1} + (1 - z_t) * \tilde{h}_t \quad (7)$$

where h_t is the hidden state at time t , h_{t-1} is the hidden state at time $t - 1$, z_t is the update gate, and \tilde{h}_t is the candidate hidden state.

The update gate z_t is computed using the following equation:

$$z_t = \sigma(W_z x_t + U_z h_{t-1} + b_z) \quad (8)$$

where W_z is the weight matrix for the input, U_z is the weight matrix for the previous hidden state, x_t is the input at time t , and b_z is the bias term for the update gate.

The candidate hidden state \tilde{h}_t is computed using the following equation:

$$\tilde{h}_t = \tanh(W_h x_t + U_h (h_{t-1} \circ r_t) + b_h) \quad (9)$$

where W_h is the weight matrix for the input, U_h is the weight matrix for the previous hidden state, r_t is the reset gate, and b_h is the bias term for the candidate hidden state. \circ is the element-wise multiplication operator.

The reset gate r_t is computed using the following equation:

$$r_t = \sigma(W_r x_t + U_r h_{t-1} + b_r) \quad (10)$$

where W_r is the weight matrix for the input, U_r is the weight matrix for the previous hidden state, x_t is the input at time t , and b_r is the bias term for the reset gate.

The output of the GRU at time t is calculated by using the following equation:

$$y_t = \sigma(W_y h_t + b_y) \quad (11)$$

where W_y is the weight matrix for the hidden state and b_y is the bias term for the output. Figure 6 shows a diagram of a GRU.

2.8 Long Short-Term Memory (LSTM)

An LSTM is introduced in 1997 by S. Hochreiter and J. Schmidhuber [62]. It has a memory cell that is used to retain information from previous inputs and use it to process the current input. LSTMs are consists of three gates, an input gate, an output gate, and a forget gate. The input gate is used to decide which values from the current input should be added to the memory cell. The forget gate is used to decide which values from the memory cell should be removed.

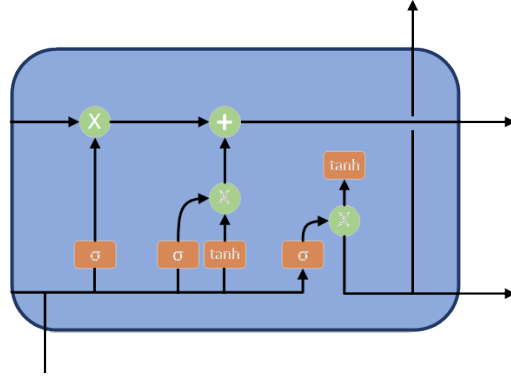

Figure 7: An LSTM

The output gate is used to decide which values from the memory cell should be used to produce the output. LSTMs are particularly useful for tasks such as language modeling, machine translation, and speech recognition. The main advantage of LSTMs over other RNNs is that they can learn long-term dependencies. Its equation is as follows:

Input Gate:

$$i_t = \sigma(W_{xi}x_t + W_{hi}h_{t-1} + b_i) \quad (12)$$

Forget Gate:

$$f_t = \sigma(W_{xf}x_t + W_{hf}h_{t-1} + b_f) \quad (13)$$

Output Gate:

$$o_t = \sigma(W_{xo}x_t + W_{ho}h_{t-1} + b_o) \quad (14)$$

Cell State:

$$\tilde{C}_t = \tanh(W_{xc}x_t + W_{hc}h_{t-1} + b_c) \quad (15)$$

Figure 7 shows a diagram of an LSTM.

2.9 Transformer

Transformer is a neural network architecture introduced by Vaswani et al. in 2017 [57]. It is a type of encoder-decoder architecture that utilizes self-attention mechanisms to process sequential data.

The transformer architecture consists of an encoder and a decoder, each of which is made up of multiple layers. The encoder takes in a sequence of input data, such as a sentence or a document, and produces a set of hidden representations called the "keys" and "values". The decoder then takes in the keys and values and generates a new sequence of output data, such as a translated sentence or a summary of the input.

One of the key features of this architecture is its use of self-attention mechanisms which allows the model to weigh the importance of different parts of the input sequence when generating the output. This is done by computing a set of attention weights for each element in the input sequence, which are used to weigh the contribution of each element to the final output.

Another important feature is the use of multi-head attention. Multi-head attention allows the model to attend to different parts of the input sequence in parallel, rather than serially. This allows the model to learn more complex relationships between different parts of the input sequence.

This architecture has been used in a wide range of natural language processing tasks, such as machine translation, text summarization, and language modeling. It has also been adapted for other types of data, such as images and time series. It has proven to be very effective at these tasks and has become a popular choice among researchers and practitioners.

2.10 Generative Adversarial Network (GAN)

The GAN was first introduced in 2014 by Goodfellow and his colleagues [63]. It is designed to generate new, previously unseen examples from a given dataset, such as images, text, or audio. GANs consist of two main components: a generator network and a discriminator network.

The generator network is responsible for creating new examples that are similar to the examples in the given dataset which takes a random noise input and maps it to a sample from the target distribution. The generator is typically a deep neural network with multiple layers, such as a fully connected or convolutional neural network.

The discriminator network is responsible for distinguishing between the examples generated by the generator and the examples from the real dataset. It takes an example as input and produces a probability value indicating the likelihood that the example is real. The discriminator is also typically a deep neural network with multiple layers.

The two networks are trained together in a two-player minimax game, where the generator is trying to produce examples that can fool the discriminator into thinking they are real, while the discriminator is trying to correctly identify which examples are real and which are fake. As the training progresses, the generator becomes better at producing realistic examples, and the discriminator becomes better at identifying them.

The goal of training is to reach a point where the generator can produce examples that are indistinguishable from real examples, and the discriminator is unable to make a clear distinction between the two. At this point, the generator can be used to generate new examples from the target distribution, such as new images that look like photographs of faces, or new audio samples that sound like speech.

GANs have been used in a wide range of applications, such as image synthesis, image-to-image translation, video synthesis, and text-to-speech synthesis. They have also been used for unsupervised learning tasks, such as anomaly detection and feature learning.

It's worth noting that GANs are considered one of the most difficult models to train and stabilize due to the adversarial nature of the training process and the potential for the generator and discriminator to get stuck in equilibrium where neither network makes progress. Therefore, multiple techniques have been proposed to stabilize the training process like Wasserstein GAN [64], Improved WGAN [65], and BEGAN [66].

Table 3 summarizes the main architectures discussed in this section and their main properties and applications.

Table 3: Deep Learning Architectures, Properties, and Applications.

Arch	Properties	Applications
CNN	Uses convolutional layers Proper for extracting features from images	Obstacle detection [67] Object classification [68] Lane detection [69] Traffic sign detection [70] Outdoor Navigation [71] Indoor Navigation [72]
RNN	Uses recurrent layers Memory and store hidden states Extracts features from sequential data Learn temporal dependencies	Attitude Estimation [73] Denoising [74] Dead Reckoning [75] Inertial Navigation [76]
Transformer	Uses self-attention mechanisms Uses multi-head attention	Visual Navigation [77] Pedestrian Navigation [78]
GAN	Uses a generator network Uses a discriminator network	Trajectory Prediction [79] Obstacle Detection [80] Path Planning [81]

3 Activation Functions

Activation functions introduce non-linearity into the network. Without non-linearity, a neural network would be limited to linear operations and would not be able to learn complex representations [43].

One of the earliest activation functions used in neural networks is the step function, invented by W. McCulloch and W. Pitts in 1943 [44]. The step function outputs a value of 1 if the input is greater than a certain threshold and 0

otherwise. This function is not used in modern neural networks, as it is not differentiable and therefore not useful for backpropagation.

Another early activation function is the sigmoid function, invented by Frank Rosenblatt in 1958 [45] which maps the input to a value between 0 and 1, making it useful for binary classification tasks. However, it is not recommended for use in modern neural networks, as it can saturate and produce vanishing gradients. It takes an input between $-\infty$ and $+\infty$ and outputs a value between 0 and 1. This can be considered as a likelihood or probability of the input being in a certain class. It is defined as follows:

$$f(x) = \frac{1}{1 + e^{-x}} \quad (16)$$

A more recent activation function is the rectified linear unit (ReLU) function, invented by Fukushima [82] in 1975. The ReLU function outputs the input if it is positive and 0 otherwise, making it computationally efficient and effective in avoiding the vanishing gradients problem. It is defined as follows:

$$f(x) = \max(0, x) \quad (17)$$

Leaky ReLU is an extension of the ReLU function, which introduces small negative slope in the negative part, to overcome the dying neurons problem [83]. The difference between Leaky ReLU and ReLU is that Leaky ReLU is how to handle negative values. Instead of setting them to zero, Leaky ReLU sets them to a small negative value. This small negative value is called the leaky coefficient which is a hyperparameter that can be tuned. It is defined as follows:

$$f(x) = \max(0, x) + \alpha \min(0, x) \quad (18)$$

where α is the leaky coefficient. Another popular activation function is the hyperbolic tangent (tanh) function, which maps the input to a value between -1 and 1. This function is similar to the sigmoid function but is symmetric around the origin, which can be useful in certain situations. Tanh could be used instead of sigmoid function to avoid the vanishing gradient problem. It is defined as follows:

$$f(x) = \frac{e^x - e^{-x}}{e^x + e^{-x}} \quad (19)$$

The exponential linear unit (ELU) function, invented by Clevert [84] in 2015, which is similar to ReLU but it is defined as negative when the input is less than zero. This function can be useful to help the network to learn faster and overcome the problem of dying neurons.

$$f(x) = \begin{cases} x & \text{if } x > 0 \\ \alpha(e^x - 1) & \text{if } x \leq 0 \end{cases} \quad (20)$$

where α is the negative slope coefficient, which is a hyperparameter that can be tuned.

Softmax function is another activation function that is commonly used in the output layer of a neural network for multi-class classification problems [85, 86]. The softmax function maps the input to a probability distribution over multiple classes. It is defined as follows:

$$f(x) = \frac{e^x}{\sum_{i=1}^n e^x} \quad (21)$$

Softplus function is another activation function that is commonly used in the output layer of a neural network for multi-class classification problems [87]. The softplus function maps the input to a probability distribution over multiple classes. It is defined as follows:

$$f(x) = \log(1 + e^x) \quad (22)$$

Swish function is commonly used in the output layer of a neural network for multi-class classification problems [88] which maps the input to a probability distribution over multiple classes. It helps to overcome the problem of vanishing gradient making it suitable for deep neural networks. It is defined as follows:

$$f(x) = x \cdot \text{sigmoid}(\beta x) \quad (23)$$

$$f(x) = x \cdot \frac{1}{1 + e^{-\beta x}} \quad (24)$$

where β is the slope coefficient, which is a hyperparameter that can be a constant or a learnable parameter.

Randomized ReLU (RRelu) is introduced by Xu et al. in 2015[89] which is a variation of the traditional ReLU. With ReLU, the negative part of the input is dropped or set to zero, whereas with RReLU, this negative part is assigned a non-zero slope. This means that a randomly determined slope is assigned to the negative part, and can update during the training process. The advantage of using this is that it improves the performance of a convolutional neural network and can lead to better results on image classification tasks. It is defined as follows:

$$f(x) = \begin{cases} x & \text{if } x > 0 \\ \alpha x & \text{if } x \leq 0 \end{cases} \quad (25)$$

In 2019 Misra et al. [90] introduced a new activation function called Mish, which is self-regularized non-monotonic activation function. It combines the advantages of ReLU and tanh functions to create a more robust non-linearity. It can be mathematically defined as:

$$f(x) = x \cdot \tanh(\text{softplus}(x)) = x \cdot \tanh(\ln(1 + e^x)) \quad (26)$$

In conclusion, activation functions play a crucial role in deep neural networks by introducing non-linearity and allowing the network to learn complex representations. Different activation functions have their own advantages and disadvantages and are suitable for different types of problems. ReLU and its variants are widely used in modern neural networks due to their effectiveness and computational efficiency.

Some of popular activation functions has been listed in the table below: In Table 4, we summarized some related works in the navigation field using deep learning.

Table 4: Activation Functions.

Activation	Equation	Gradient
Sigmoid [44]	$\frac{1}{1+e^{-x}}$	$\frac{e^{-x}}{(1+e^{-x})^2}$
ReLU [91]	$\max(0, x)$	$\begin{cases} 1 & \text{if } x > 0 \\ 0 & \text{if } x \leq 0 \end{cases}$
Leaky ReLU [83]	$\max(ax, x)$	$\begin{cases} 1 & \text{if } x > 0 \\ a & \text{if } x \leq 0 \end{cases}$
Softmax [86]	$\frac{e^{x_i}}{\sum_{j=1}^n e^{x_j}}$	$\frac{e^{x_i}(1 - \frac{e^{x_i}}{\sum_{j=1}^n e^{x_j}})}{\sum_{j=1}^n e^{x_j}}$
Tanh	$\frac{e^x - e^{-x}}{e^x + e^{-x}}$	$\frac{4e^{2x}}{(e^x + e^{-x})^2}$
Softplus [87]	$\ln(1 + e^x)$	$\frac{e^x}{1+e^x}$
Swish [88]	$x \cdot \text{sigmoid}(\beta x)$	$x \cdot \text{sigmoid}(\beta x) \cdot (1 - \text{sigmoid}(\beta x)) + \text{sigmoid}(\beta x) \cdot \beta$
Mish [90]	$x \cdot \tanh(\ln(1 + e^x))$	$x \cdot \tanh(\ln(1 + e^x)) \cdot (1 - \tanh(\ln(1 + e^x))) + \tanh(\ln(1 + e^x)) \cdot \ln(1 + e^x)'$
ELU [84]	$\max(0, x) + \min(0, \alpha(e^x - 1))$	1
PReLU [92]	$\begin{cases} ax & \text{if } x < 0 \\ x & \text{if } x \geq 0 \end{cases}$	$\begin{cases} a & \text{if } x < 0 \\ 1 & \text{if } x \geq 0 \end{cases}$
GELU [93]	$\frac{1}{2}x(1 + \tanh(\sqrt{\frac{2}{\pi}}(x + \alpha x^3)))\alpha = 0.044715$	$\frac{1}{2}(1 + \tanh(\sqrt{\frac{2}{\pi}}(x + \alpha x^3))) + \frac{1}{2}x\sqrt{\frac{2}{\pi}}(1 - \frac{\tanh^2(\sqrt{\frac{2}{\pi}}(x + \alpha x^3))}{2})$
SELU [94]	$\begin{cases} \lambda x & \text{if } x \geq 0 \\ \lambda \alpha(e^x - 1) & \text{if } x < 0 \end{cases}$	$\begin{cases} \lambda & \text{if } x \geq 0 \\ \lambda \alpha(e^x) & \text{if } x < 0 \end{cases}$
Softsign	$\frac{x}{1+ x }$	$\frac{1}{(1+ x)^2}$
Hard shrink	$\begin{cases} x & \text{if } x > \lambda \\ x & \text{if } x < -\lambda \\ 0 & \text{otherwise} \end{cases}$	$\begin{cases} 1 & \text{if } x > \lambda \\ 1 & \text{if } x < -\lambda \\ 0 & \text{otherwise} \end{cases}$
Soft shrink	$\begin{cases} x - \lambda & \text{if } x > \lambda \\ x + \lambda & \text{if } x < -\lambda \\ 0 & \text{otherwise} \end{cases}$	$\begin{cases} 1 & \text{if } x > \lambda \\ 1 & \text{if } x < -\lambda \\ 0 & \text{otherwise} \end{cases}$
Tanh shrink	$x - \tanh(x)$	$1 - \tanh^2(x)$
LiSHT [95]	$x \cdot \tanh(x)$	$x \cdot \tanh(x) \cdot (1 - \tanh(x)) + \tanh(x)$
Snake [96]	$x + \frac{1}{a} \sin^2(ax) = x - \frac{1}{2a} \cos(2ax) + \frac{1}{2a}$	$\frac{1}{a} \cos^2(ax) = \frac{1}{2a} \cos(2ax) - \frac{1}{2a}$

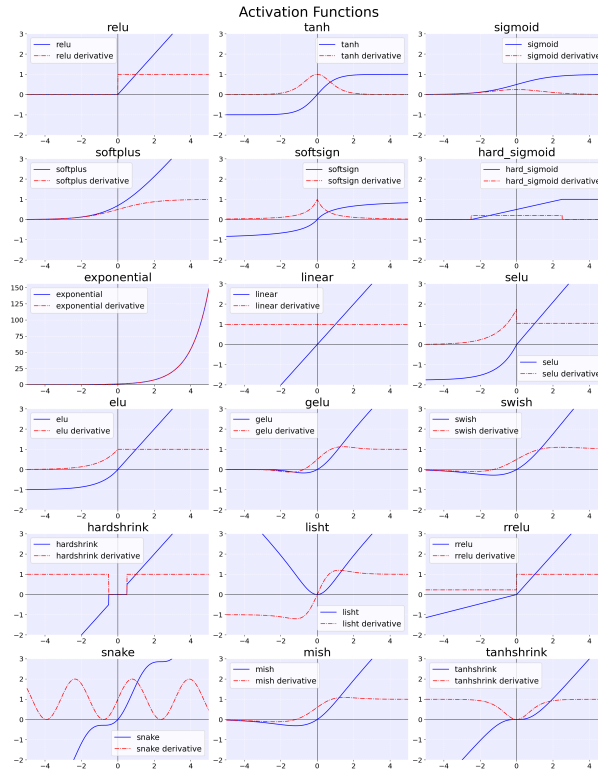

Figure 8: Activation Functions

In figures 8 and 9, the most common activation functions have been shown.

In conclusion, activation functions play a crucial role in deep learning as they add non-linearity to the model and determine the output of each neuron in a network. The choice of activation function depends on the type of problem being solved and its desired output so there is no ultimate answer for the question "What is the best activation function?". However, it is important to consider the characteristics and limitations of each activation function when designing a deep learning model.

4 Autonomous Navigation

Navigation refers to the process of determining the position and orientation of an object and determining a suitable path to reach a destination. It is a crucial aspect of many fields including transportation, robotics, and space exploration. In the last few decades, navigation systems have evolved significantly, and with the advancement of technology, they have become even more sophisticated and reliable.

Navigation systems can be broadly categorized into two main types: **indoor** and **outdoor** navigation. **Indoor navigation** systems are used in indoor environments, such as buildings, malls, and airports. Usually, this type of navigation suffers from the weak signals and other external references. Outdoor navigation systems, on the other hand, are used to navigate in outdoor environments, such as roads, highways, and parks. Despite the availability of GPS signals, outdoor navigation systems are more challenging due to the presence of obstacles and other factors that can affect the accuracy of the system.

Autonomy refers to the ability of a system or agent to act independently without external control or influence. In the context of engineering and robotics, autonomy often refers to the ability to operate without direct human intervention, making its own decisions and take actions based on its internal programming and external inputs from sensors and other sources. This is the basis of autonomous systems, such as autonomous vehicles, drones, and robots, which are designed to make decisions and perform tasks and on their own, without the need for human guidance.

Autonomy could be divided into two main approach: (1) Heuristic Approach and (2) Optimal Approach. **Heuristic approach** is based on rules to make decision which relies on a set of predefined heuristics or "rules of thumb". This approach does not require a lot of computational power, but it may not always lead to an optimal decision. On the other

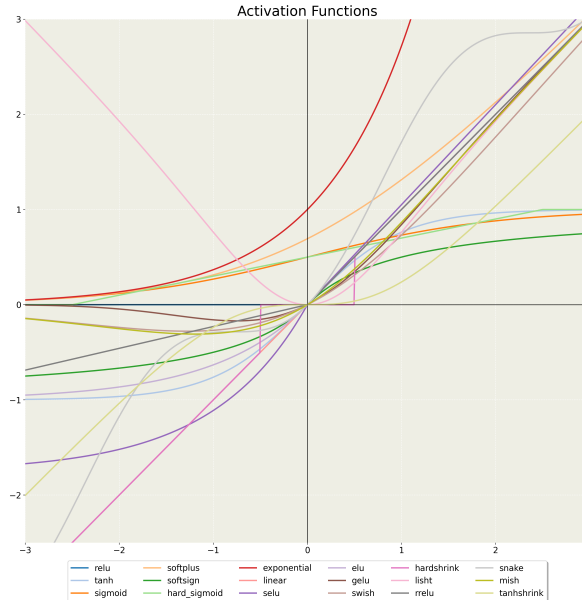

Figure 9: Compare Activation Functions

hand, the optimal approach involves finding the best decision based on a specific objective functions and constraints, often using mathematical models and algorithms. This approach usually requires more computational power and can be more complex, on the other hand it is often more accurate and efficient. Both approaches have their own advantages and disadvantages, and the choice of approach depends on the specific application and context.

Autonomous systems needs to interact with physical world by collecting data via sensors. The measurements are used to perceive the environment. These collected data are often noisy and/or incomplete, which makes it difficult for the system to make accurate decisions. To address this, sensor fusion can be used to combine data from multiple sources to improve the overall performance and reduce the uncertainty. For example, a GPS sensor can be used to determine the position of the system, while a camera can be used to detect obstacles and map the the environment. The data from these sensors can be combined to improve the accuracy of the pose estimation algorithm. With these information the agent or system could create a plan to reach its destination by considering the system constraints. Finally, the system could execute the plan by controlling the actuators. The process of collecting data, perceiving the environment, planning, and actuating is known as the **autonomous navigation cycle** which is shown in figure 10.

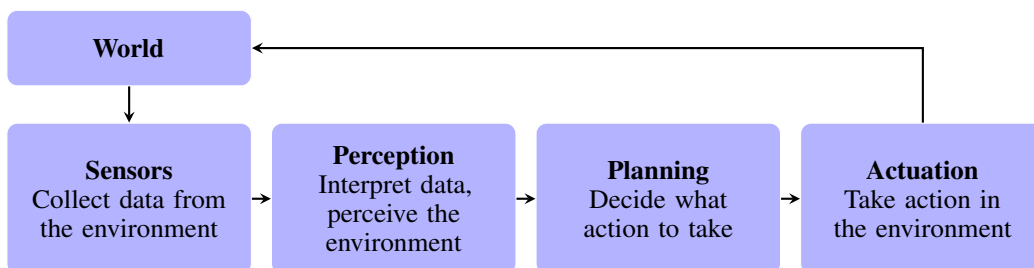

Figure 10: The Autonomous Navigation Cycle

Autonomous navigation systems have become increasingly vital in recent years, especially with the rise of automation and the need for efficient and safe transportation. These systems can be found in a wide range of applications and can be further categorized based on the environment they operate in: **Land, Marine, Aerial, Space, Underwater**. Each type of system presents unique challenges and requirements, and specific constraints and characteristics of the environment must be take into account when developing these systems.

Regardless of the environment, the main components of autonomous navigation systems include:

- **Obstacle detection** - Detect and avoid obstacles in the environment.

- **Path planning and generation** - Plan a path to reach the destination and generate a trajectory to follow the path.
- **Motion control** - Control the motion of the vehicle to follow the trajectory.
- **Localization** - Determine its position and orientation in the environment.
- **Mapping** - Create a map of the environment.
- **Environment sensing and perception** - Collect and process information about the environment.
- **Decision making and control** - Make decisions and take actions based on the information collected from the environment.
- **Trajectory optimization** - Adjust the trajectory to improve the efficiency and accuracy of the navigation.
- **Sensor fusion** - Combine data from multiple sensors to improve the overall performance of the navigation system.

These components work together to ensure that the navigation system can safely and efficiently move from one point to another. In conclusion, navigation is a crucial aspect of many fields, and with the advent of technology, it has become even more sophisticated and reliable. Autonomous navigation systems play a critical role in various applications and have the potential to greatly improve efficiency and safety.

5 Applications of Deep Learning in Autonomous Navigation

One of the key applications of deep learning in recent years has been autonomous navigation. Using deep learning to develop advanced and sophisticated navigation systems that can operate without human intervention has revolutionized this field. Deep learning provide a powerful way to learn complex mappings between inputs and outputs, making it possible to perform a wide range of tasks in autonomous navigation, such as pose estimation, perception, decision-making, and control.

One of the main areas where deep learning has been applied is perception systems which are responsible for processing data from a range of sensors, such as cameras, LiDARs, RADARs, and Infrared to obtain information about the surrounding environment.

- **Camera:** One of the most common sensors used in autonomous navigation. They are used to obtain images of the surrounding environment, which can then be processed by deep learning algorithms to extract relevant information, such as road markings, traffic signs, and obstacles. But they are limited by the visibility conditions, such as low light, fog, and rain.
- **LiDAR:** Used to obtain 3D point clouds of the surrounding environment, which provides 360-degree mapping of the environment but they are limited by low reflective targets.
- **RADAR:** Provide mapping of the environment at medium to long distances which can be used in worse weather conditions. But they are limited by low resolution.
- **Infrared:** Can be used in low light conditions to obtain images of the environment.

Deep learning algorithms, particularly convolutional neural networks, have been shown to be highly effective in processing images and extracting relevant features [97, 98, 99], such as road markings [100, 101], obstacles [102, 103, 104], and traffic signs [105, 106]. Another important area where deep learning has been applied in autonomous navigation is in decision-making which is the ability to make decisions based on the information collected from the environment.

Deep learning has also been applied in the development of control systems for autonomous vehicles which are responsible for controlling the movements, such as steering, acceleration, and braking, to ensure that it follows a safe and efficient trajectory.

In the following sections, we will discuss the applications of deep learning in autonomous navigation in more detail.

5.1 Autonomous Drive

Self-driving cars are becoming an increasingly popular topic in the field of autonomous navigation. The technology behind these vehicles is being developed by companies such as Tesla, Google, and BMW, among others. Autonomous Driving uses a combination of computer vision, machine learning, and other technologies to enable vehicles to operate without human intervention, Figure 11. The goal of self-driving cars is to make driving safer, more efficient, and more

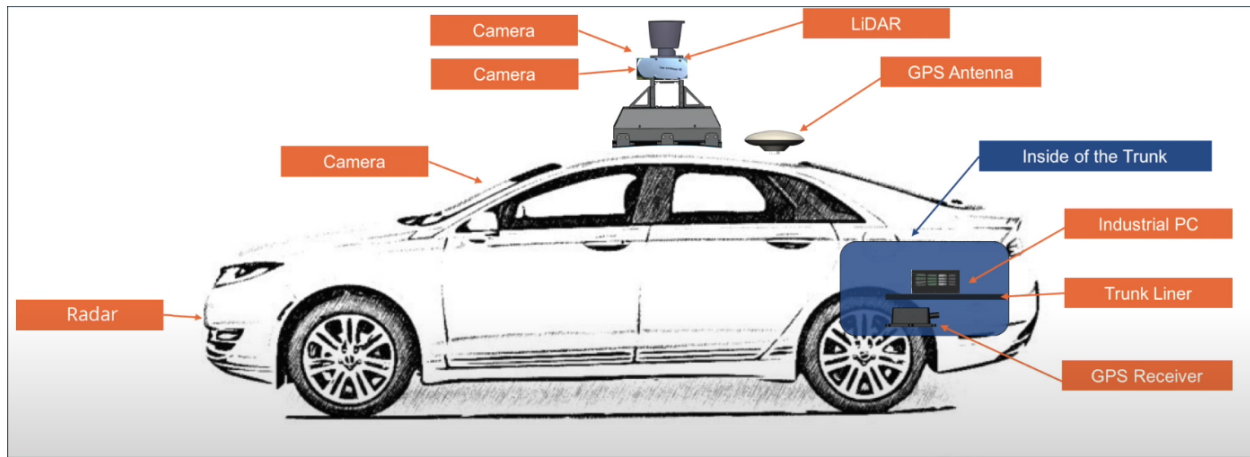

Figure 11: Sensors in Autonomous Vehicles [107]

convenient by eliminating human error. The key component of a self-driving car is Artificial intelligence (AI) system that enables it to make decisions and operate autonomously. Deep learning is at the forefront of this technology and is responsible for much of the recent progress in self-driving cars.

In order to make autonomous driving a reality, it is essential to have reliable and robust algorithms that can process large amounts of data from cameras, RADARs, and LiDARs in real-time. Deep learning algorithms, with their ability to learn from data, have proven to be effective in solving these complex challenges. Deep learning algorithms have been applied to various aspects of autonomous driving, including object detection, lane detection, and trajectory prediction. Object detection is a critical component of autonomous driving, as it involves identifying and classifying objects such as pedestrians, vehicles, and traffic signs. Lane detection is another crucial aspect, as it involves accurately identifying the location of the vehicle within the lane. Trajectory prediction is also important, as it involves predicting the future behavior of other vehicles on the road.

Self-driving cars can reduce the carbon emission levels, risk of drastic accidents, and increase road safety and smoothen traffic flow [108]. Based on J3016 standard last update in 2019 [109], there are six levels of driving automation from “no automation” to “full automation”. The first level is “no automation” where the driver is responsible for all driving tasks. The second level is “driver assistance” where the driver is responsible for all driving tasks but the system can assist the driver. The third level is “partial automation” where the driver is responsible for all driving tasks but the system can take over in certain situations. The fourth level is “conditional automation” where the driver is responsible for all driving tasks but the system can take over in certain situations. The fifth level is “high automation” where the driver is responsible for all driving tasks but the system can take over in certain situations. The sixth level is “full automation” where the driver is not responsible for any driving tasks and the system is responsible for all driving tasks. Figure 12 shows the six levels of driving automation.

Self-driving cars core components are sensors, perception, localization and mapping, path planning, and control. Sensors are the eyes of the car which are responsible for sensing the environment and providing information about the surrounding environment. Perception is the brain of the car which is responsible for processing the data from the sensors and extracting relevant information and used for tasks such as obstacle detection, traffic sign detection, and lane detection. Localization and mapping are responsible for determining the location of the vehicle within the environment, building a map of the environment and tracking the vehicle’s trajectory within the map. Planning is the heart of the car that is responsible for determining the best trajectory for the vehicle to follow while avoiding all the obstacles in the environment. Control is the hands of the car to control the movements of the vehicle, such as steering, acceleration, and braking, to ensure that it follows the planned trajectory.

5.2 Autonomous Flight

The use of autonomous drones has rapidly grown in recent years and is expected to continue its upward trend [110, 111, 112, 113]. The ability of these vehicles to operate without human intervention opens up a wide range of applications and possibilities. From delivering packages (Figure 13) to performing complex aerial photography and remote sensing, autonomous flying vehicles are poised to revolutionize various industries and make our lives easier and more convenient [14].

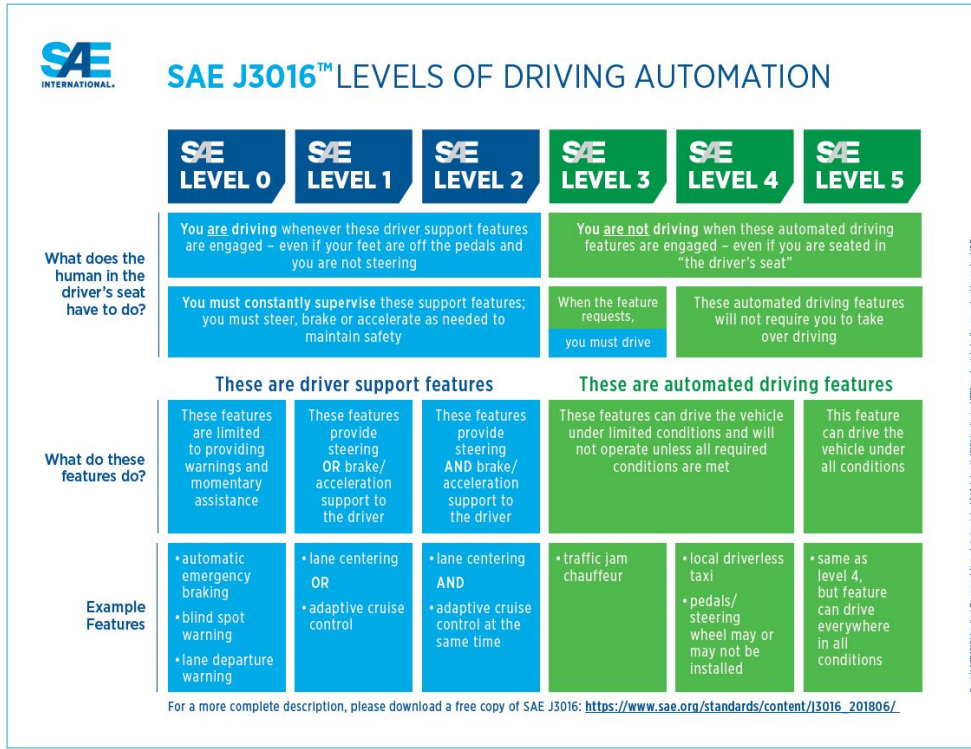

Figure 12: Levels of Automation, described by the Society of Automobile Engineers (SAE) [109]



Figure 13: Autonomous Delivery Drone [114]

One of the primary goals of autonomous flying vehicles is to improve safety by reducing the risk of human error. This is especially important in hazardous scenarios such as search and rescue missions, where a misstep by a human pilot could be catastrophic. With autonomous flying vehicles, the risk of human error is greatly reduced, making these missions much safer [115].

The backbone of autonomous flying vehicles is their Artificial Intelligence system that enables them to make decisions and operate autonomously. The AI system is responsible for processing vast amounts of data obtained from sensors, such as cameras and LiDARs, to gain an understanding of the surrounding environment. Using this information, the AI system then makes decisions about the flying actions of the vehicle which includes obstacle avoidance, autonomous movement, and even autonomous take-off and landing. Deep learning is playing a major role in the development of autonomous drones and has been instrumental in advancing the technology. Deep learning algorithms have been used to develop perception and decision-making systems that enable autonomous flying vehicles to perform complex tasks with high accuracy. For example, deep learning algorithms can be trained to recognize and classify objects in real-time, enabling autonomous flying vehicles to identify obstacles and avoid them [116].

The SAE’s Six levels of autonomy, ranging from "no automation" to "full automation," were originally developed for autonomous ground vehicles but are applicable to any vehicle capable of autonomy, including drones. The first level is “no automation” where the pilot is responsible for all flying tasks. Our analysis maps the functionality of drone navigation against these levels, starting at Level 1 with assisted features like GPS guidance and landing zone evaluation, which are already available in commercially available drones. Level 2, known as "pilot assistance," includes specific and use case-dependent navigational operations, such as "follow me" and "track target" commands. Level 3, or "partial automation," allows for autonomous navigation in certain identified environments. At Level 4, or "conditional automation," the drone can navigate autonomously without human interaction in most use cases. Finally, Level 5, or "full automation," is the theoretical ideal of autonomy in all possible use cases, environments, and conditions which indicating that the system is responsible for all flying tasks [3]. Table 5 shows the six levels of flying automation and the tasks that are performed at each level.

Table 5: Levels of Automation for Flying Vehicles

Level	0	1	2	3	4	5
Obstacle Detection		✓	✓	✓	✓	✓
Adaptive Cruise Control		✓	✓	✓	✓	✓
Spatial Awareness		✓	✓	✓	✓	✓
Object Distinction			✓	✓	✓	✓
Obstacle Avoidance			✓	✓	✓	✓
Autonomous Movement			✓	✓	✓	✓
Environmental Awareness				✓	✓	✓
Non-planar Movement				✓	✓	✓
Autonomous Take off & Landing					✓	✓
Path Generation					✓	✓
Autonomous Flight						✓

5.3 Autonomous Space Flight

In the past decades AI has made significant contributions to the space industry, especially in the field of Guidance, Navigation, and Control. Notably, deep learning algorithms have facilitated the development of sophisticated pose estimation [117, 118], path planning [119], and collision avoidance [120] systems for autonomous spacecraft, such as satellites and planetary rovers. These AI-powered navigation systems have enabled spacecraft to operate autonomously, leveraging real-time data from onboard sensors and cameras to make informed decisions without human intervention. The utilization of AI in spacecraft navigation has enhanced the efficiency and precision of spacecraft operations, thereby enabling exploration of previously inaccessible domains in space. As space exploration continues to evolve, AI is expected to play an increasingly critical role in spacecraft navigation and other space-related applications.

Furthermore, AI has addressed several key challenges in space missions, such as low earth orbit attitude determination [121], simultaneous navigation and characterization [122], pose tracking [123], planetary landing [124, 125], crater detection [126, 127], deep space missions [128, 129], gravity field modeling [130], motion planning [131]

AI-based autonomous systems can process and interpret data much faster than traditional methods, enabling spacecraft to react quickly to dynamic situations, such as the detection of a hazard or a change in the terrain [132]. Additionally,

Table 6: Applications of AI in Autonomous Spacecraft

Ref	Application	Method	Description
[133]	Relative Motion Guidance	Reinforcement Learning	An actor-critical reinforcement learning algorithm based on lightweight feedback guidance was proposed for proximity operations in the cis-lunar environment.
[134]	Relative Motion Guidance	Deep learning	Convolutional Siamese network used to estimate the attitude and rotational state of an uncooperative debris satellite with unknown geometry
[117]	Pose Estimation	Deep Learning	A CNN pose estimation of known uncooperative spacecrafts approach build upon SPEED dataset and presented present a simulator called URSO built on Unreal Engine 4.
[135]	Fault Detection	Deep Learning	A one-dimensional convolutional neural network (1D-CNN) coupled with an LSTM network architecture is used for detecting and identifying anomalies in spacecraft reaction wheels.
[136]	Magnetic Dipole modeling	Deep Learning	MDMnet, a deep-learning neural network, models the magnetic signature of spacecraft units using synthetic magnetic flux density data generated by virtual dipole sources and achieves high predictive accuracy.
[137]	Debris Detection	Deep Learning	A multi-modal learning approach is employed to detect space objects, including spacecraft and debris which integrates a vision transformer based on RGB and CNN based network to classify 11 object categories.
[138]	Procedure Generation	Reinforcement Learning	Examined the feasibility and safety of deep reinforcement learning for spacecraft decision-making, and the hybridization of DRL-driven policy generation algorithms with correct-by-construction control techniques.
[139]	Navigation	Deep Learning	The Cascade Mask R-CNN was used for detecting craters from monocular images for autonomous spacecraft navigation, and for learning transfer functions from real lunar images acquired by the lunar reconnaissance orbiter.
[140]	Sensor Tracking	Reinforcement Learning	A deep reinforcement learning agent to task a space-based narrow-FOV sensor in low Earth orbit for space situational awareness
[141]	Sensor Tracking	Reinforcement Learning	Detect, characterize, and track resident space objects in increasingly complex environments using ground-based optical telescopes.
[142]	Control	Reinforcement Learning	Optimized proximal policies for 6 DoF closed-loop control for cooperating clients in spacecraft docking missions

autonomous spacecraft navigation systems are less susceptible to human error and can operate in hazardous environments, which is particularly useful in missions to explore unknown territories in space [16]. Table 6 summarizes the recent research on the main applications of AI in autonomous spacecraft.

Despite the considerable progress made in the field of AI-enabled spacecraft navigation, numerous challenges remain, which require further research and development. A major challenge is the limited computational resources available in space, which means that algorithms must be optimized for both accuracy and efficiency. Moreover, since spacecraft operate in unpredictable and demanding conditions, the reliability and robustness of AI-enabled systems must be thoroughly tested and verified to ensure mission success. Therefore, the development of reliable and efficient AI-

enabled spacecraft navigation systems requires a multifaceted approach incorporating cutting-edge research in artificial intelligence, rigorous engineering design, testing and validation.

In summary, the implementation of AI technology in autonomous spacecraft has represented a paradigm shift in the space industry by providing the ability to operate autonomously, leveraging sensory data to make real-time decisions. As the field of space exploration continues to progress, it is evident that AI technology will become increasingly indispensable for space-related applications, thus paving the way for humanity to explore new and unprecedented frontiers in space. Indeed, the continued development of AI-enabled spacecraft navigation systems promises to revolutionize the space industry and usher in a new era of space exploration, with boundless potential for discovery and innovation.

Table 7 summarizes recent research in AI-enabled space missions. The table includes

Table 7: Recent Research in AI-enabled Space Missions

Ref	Method	Backbone	Dataset	Task
[143]	Supervised	YOLO	Synthetic	Fault Detection
[144]	Supervised	YOLO + MobileNet	SPEED	Pose Estimation
[145]	Supervised	Faster R-CNN + HRNet	SPEED	Pose Estimation
[146]	Reinforcement Learning	Deep Reinforcement Learning	✗	Landing
[138]	Reinforcement Learning	Deep Reinforcement Learning	✗	Decision Making
[147]	Reinforcement Learning	Deep Reinforcement Learning	✗	Control
[148]	Supervised	Gaussian Process Regression	Synthetic	Control
[149]	Supervised	ResNet-50	OrViS	Pose Estimation
[150]	Supervised	Dense	Synthetic	Motion Planning
[151]	Supervised	Track3D	Synthetic	Tracking
[152]	Supervised	CNN	Synthetic	Pose Estimation
[142]	Reinforcement Learning	Deep Reinforcement Learning	✗	Control
[153]	Reinforcement Learning	Deep Reinforcement Learning	✗	Space Situational Awareness
[154]	Supervised	CNN	Synthetic	Maneuver Classification
[141]	Reinforcement Learning	Deep Reinforcement Learning	✗	Space Situational Awareness
[135]	Supervised	CNN-LSTM	Synthetic	Fault Detection
[155]	Supervised	DeepLabv3+	SPEED + URSO	Image Segmentation
[140]	Reinforcement Learning	Deep Reinforcement Learning	✗	Space Situational Awareness
[156]	Supervised	RNN-CNN	Synthetic	Pose Estimation
[137]	Supervised	CNN	SPARK	Space Situational Awareness
[157]	Supervised	TCN	SMAP/MSL	Anomaly Detection
[133]	Reinforcement Learning	Deep Reinforcement Learning	✗	Relative Motion Guidance

6 Deep Learning Components in Autonomous Navigation

6.1 Signal Processing

A key component of autonomous navigation is signal processing, which generates and processes sensory data so that relevant information about the environment can be extracted. Signal processing is used to improve the quality of sensory data, which in turn improves the accuracy of the decision-making process of autonomous systems. Filtering, segmentation, feature extraction, classification, and registration are some of the signal processing techniques used in autonomous navigation systems. The use of deep learning techniques for signal processing has improved the performance of autonomous navigation systems in a variety of areas, including image segmentation and data denoising.

Furthermore, deep learning techniques have been utilized for multi sensor data fusion, which involves combining data from multiple sensors to reduce the uncertainty and obtain a more comprehensive representation of the environment. The fusion of data from different sensors, such as RADAR, camera and LiDAR, has been shown to improve the accuracy of object detection and classification. The use of deep neural networks in sensor fusion has enabled the system to learn more complex representations of the environment and make more accurate decisions.

Signal denoising is a fundamental task in signal processing and has wide applications in various domains such as inertial navigation, attitude estimation, image processing, and biomedical signal analysis. Traditional methods for denoising such as wavelet transforms and filtering techniques have limitations in effectively removing noise while preserving the

signal's fidelity. Recently, deep learning techniques have been applied to denoise signals, and shown promising results due to their ability to learn complex features and patterns directly from raw data.

For instance, [158] used LSTM network to filter MEMS-based gyroscope outputs to improve the accuracy of standalone INS. The results indicate that the denoising scheme was effective for improving MEMS INS accuracy, and the proposed LSTM method was more preferable in this application. This study also compares LSTM with Auto Regressive and Moving Average (ARMA) models with fixed parameters, and the LSTM method performed better in this application. Similarly [74] demonstrated that CNNs can denoise IMU measurements to achieve remarkable accuracy in attitude estimation, by filtering out noise caused by sensor drift, environmental disturbances, and dynamic effects .

Four hybrid models consist of LSTM-LSTM, GRU-GRU, and LSTM-GRU LSTM-LSTM, GRU-GRU, and LSTM-GRU, are proposed in [159], and static and dynamic experiments were conducted to validate the effectiveness of the proposed networks. The results show that LSTM-GRU network has the best noise reduction effect, while GRU-LSTM network is overfitting the large amount of data. The study demonstrates the potential of using deep learning algorithms in MEMS gyroscope noise reduction and improving the accuracy of MEMS-IMU systems.

Chen et al.[160] utilized CNN to reduce noises from IMU sensors in autonomous vehicles. The proposed system does not need external measuring sources such as GPS or vehicle sensors, unlike EKF approaches, and the method can be applied for both high-grade and low-grade IMUs. Three CNNs were developed, and the results showed up to 32.5% error improvement in straight-path motion and up to 38.69% error improvement in oval motion compared with the ground truth. The authors' primary objective was to develop algorithms with higher performance and lower complexity that would allow implementation on ultra-low power artificial intelligence microcontrollers such as the Analog Devices MAX78000. Similarly, RNNs [161] have been used to remove noise from accelerometer measurements,

Deep learning approaches have the advantage of learning complex noise patterns, which can vary depending on the input signal's type and nature. As a result, deep learning-based denoising techniques have the potential to optimize denoising performance for various applications, thus enhancing the accuracy and reliability of autonomous navigation systems. In addition, signal processing, including tasks such as filtering, segmentation, feature extraction, classification, registration, and sensor data fusion, plays a crucial role in the development of autonomous navigation systems. Deep learning has demonstrated significant improvements in the accuracy and speed of signal processing tasks. Furthermore, deep learning has been applied to denoise signals with promising results, improving the accuracy and reliability of sensor data for various applications, including inertial navigation, attitude estimation, and image processing. The ability of deep learning algorithms to learn complex noise patterns makes them an attractive option for enhancing the accuracy and reliability of autonomous navigation systems.

6.2 Perception

Perception is a critical aspect of robotics and engineering, which involves the ability to interpret sensory data to understand and make sense of the surrounding environment. In the context of autonomous navigation systems, perception is a fundamental element enables the system to detect and analyze the physical world around it, make decisions based on that information, and take actions accordingly. A more detailed discussion can be found in [162].

Perception is a complex process which involves multiple stages. In the first stage the system takes in data from various sources, including camera, LiDAR, RADAR, and inertial sensors. The second stage involves data preprocessing, where the raw sensory data is filtered and processed to extract meaningful information and features. The final stage is interpretation, where the system uses the extracted information and features to make sense and perceive the environment and take appropriate action.

In recent years, deep learning algorithms have been extensively used for perception tasks in various systems. These algorithms have proven to be highly effective for tasks such as object detection, object recognition, and scene understanding, which are crucial for navigation and decision making.

As the system trained on vast amounts of data, they have the ability to learn and improve over time. This will enables them to recognize and classify object and obstacles with high accuracy. As the system continues to operate, it can refine and improve its perception abilities through continuous learning. Some of the datasets listed in Table 8

Despite the many benefits of deep learning-based perception systems, there are still some challenges that need to be addressed. One significant challenge is the potential for bias in the training data, which can result in inaccuracies in perception. Additionally, these systems can struggle in complex and dynamic environments, where there is a high degree of uncertainty and unpredictability. Also, these systems may require a high computation power.

In this section, we discuss the use of deep learning algorithms for perception in autonomous navigation systems.

Table 8: Some of the most popular publicly available datasets for autonomous navigation

Dataset	Year	Sensor	Scene	Application
KITTI [163]	2012	Camera + LiDAR + IMU	Urban	Ground Vehicle
EuRoC MAV [164]	2014	Cameras + IMU	Indoor	Drone
NCLT [165]	2015	Camera + LiDAR + IMU + GPS + Wheel	Urban	Ground Vehicle
SUN RGB-D [166]	2015	Camera	Indoor	Scene Understanding
Cityscapes [167]	2016	Camera + GPS	Urban	Ground Vehicle
LISA Traffic Light [168]	2016	Camera	Urban	Traffic light detection
Stanford Drone [169]	2016	Camera	Outdoor	UAV + Trajectory Prediction
UAV123 dataset [170]	2016	Camera	Indoor	Drone
Zurich Urban MAV [171]	2017	Camera + GPS + IMU	Outdoor	Drone
Oxford RobotCar [172]	2017	Camera + LiDAR + RADAR + GPS	Urban	Ground Vehicle
DAVIS Dataset [173]	2017	Camera	-	Object Tracking
BDD100K [174]	2017	Camera + GPS + IMU	Urban	Ground Vehicle
ApolloScape [175]	2018	Camera + LiDAR + GPS + IMU	Urban	Ground Vehicle
UPenn Fast Flight [176]	2018	Camera + GPS + IMU	Outdoor	Drone
ScanNetV2 [177]	2018	Camera + Mesh	Indoor	Scene Understanding
KAIST [178]	2018	Camera + LiDAR + GPS + IMU	Urban	Ground Vehicle
UZH-FPV [179]	2019	Camera + IMU	Indoor + Outdoor	Drone
Argoverse [180]	2019	Camera + LiDAR + GPS	Urban	Ground Vehicle
H3D [181]	2019	Camera + LiDAR + GPS + IMU	Urban	Ground Vehicle
Lyft [182]	2019	Camera + LiDAR	Urban	Ground Vehicle
A2D2 [183]	2019	Camera + LiDAR	Urban	Ground Vehicle
A*3D [184]	2019	Camera + LiDAR	Urban	Ground Vehicle
Carla Simulator [185]	2019	Camera + LiDAR	Simulation	Ground Vehicle
nuScenes [186]	2019	Camera + LiDAR + RADAR + GPS + IMU	Urban	Ground Vehicle
Waymo Open [187]	2020	Camera + LiDAR	Urban	Ground Vehicle
Blackbird [188]	2020	Camera + IMU	Indoor + Outdoor	Drone
VisDrone dataset [189]	2021	Camera	Outdoor	Drone
WHUVID [190]	2022	Camera + IMU	Urban	Ground Vehicle
HDIN [191]	2022	Camera	Indoor	Drone

6.2.1 ObjectObstacle Detection and Segmentation

Object detection is the process of identifying an object’s presence and class in an image or video frame and determining its location. This technique is widely used in computer vision applications such as robotics, surveillance, and autonomous navigation, and involves creating bounding boxes around objects and labeling them with class labels [192]. Table 9 provides an overview of the most popular object detection algorithms.

Obstacle detection is a critical component and core technical problem in autonomous navigation systems, as it involves identifying and classifying static and dynamics objects such as vehicles, pedestrians, and other obstacles that may be present in the vehicle’s path. In the past decades, various sensors have been utilized and developed for this purpose, including cameras, ultrasonic sensors, LiDARs, and RADARs. However, the most common sensor used for obstacle detection is the camera, as it is the most cost-effective and widely available sensor which are also capable of capturing a wide field of view, making it possible to detect objects that are far away from the vehicle.

Segmentation, involves identifying and labeling each pixel in an image or video as belonging to a particular object or class. This technique is more precise than object detection as it provides a more detailed understanding and partitioning the digital image or video frames. It can be used for tasks such as satellite image analysis, medical image analysis, face recognition and detection, object tracking and scene understanding. Segmentation algorithms use various techniques, such as thresholding, clustering, and deep learning, to segment the objects. On the other hand, semantic segmentation is a type of image segmentation that assigns each pixel in an image a semantic label or category. The goal is to identify

Table 9: Object Detection Algorithms

Algorithm	Description
VJ Det. [193]	Viola-Jones detector, a real-time face detection algorithm
HOG Det. [194]	Histogram of Oriented Gradients, used to detect objects in images
DPM [195]	Deformable Parts Model, used for detecting objects with a combination of local parts
RCNN [196]	Region-based Convolutional Neural Networks, uses selective search for region proposals and a CNN to classify objects
SPPNet [197]	Spatial Pyramid Pooling Network, a CNN architecture that can handle images of arbitrary size and aspect ratio
Fast RCNN [198]	Faster Region-based Convolutional Neural Networks, an improvement of RCNN that shares computation among the region proposals
Faster RCNN [199]	A faster version of Fast RCNN that uses a Region Proposal Network to generate region proposals
YOLOv1 [200]	You Only Look Once version 1, a single-shot object detection model that predicts the bounding boxes and class probabilities directly from the image
YOLO9000 [201]	You Only Look Once version 2, an improved version of YOLOv1 that uses anchor boxes to improve the accuracy of object detection
YOLOv3 [202]	You Only Look Once version 3, an even more accurate version of YOLO that uses feature maps to predict object classes and bounding boxes
YOLOv4 [203]	You Only Look Once version 4, the latest version of YOLO that uses several new techniques, including spatial pyramid pooling, path aggregation networks, and cross-stage partial connections
SSD [204]	Single Shot MultiBox Detector, a single-shot object detection model that uses a series of convolutional layers to predict object classes and bounding boxes
FPN [205]	Feature Pyramid Network, a CNN architecture that can handle images of different scales and resolutions by constructing a feature pyramid
RetinaNet [206]	A single-shot object detection model that uses a feature pyramid network and a focal loss function to handle the class imbalance problem
CornerNet [207]	A keypoint-based object detection model that uses corners as keypoints to detect objects and their orientations
CenterNet [208]	A keypoint-based object detection model that predicts the center point of objects and their size and orientation
DETR [209]	Detection Transformer, a transformer-based object detection model that uses an attention mechanism to directly predict the set of objects in an image
Cascade R-CNN [210]	A variant of Faster R-CNN that uses a cascade of detectors to improve accuracy.
EfficientDet [211]	A family of object detection models that use EfficientNet as a backbone and incorporate various design changes to improve speed and accuracy.
Sparse R-CNN [212]	A variant of Faster R-CNN that uses sparse convolutional layers to reduce computation and memory requirements.
RepPoints [213]	A method that represents object instances as a set of points and performs detection by matching these points to features in the image.
FCOS [214]	A fully convolutional object detection method that predicts the bounding box, class, and objectness score for each pixel in the feature map.

and classify the objects and regions of interest within an image, such as cars, buildings, people, or background. The output of semantic segmentation is a pixel-level map that associates each pixel with a specific object or region class [215]. In summary, while image segmentation aims to group pixels into visually similar parts, semantic segmentation goes further by assigning a semantic meaning to each of these parts. Figure 14 shows the difference between image segmentation, semantic segmentation, and object detection.

In Table 10, we summarize the most popular object segmentation algorithms.

There are several limitations to object detection and segmentation techniques in autonomous navigation. One of the major limitations is the requirement for large datasets and computational resources to train the models. These models require extensive training data to achieve high accuracy, which can be challenging to obtain in real-world environments. In addition, the computational resources required to process the image or video frames in real-time can be a limiting factor, especially for embedded systems.

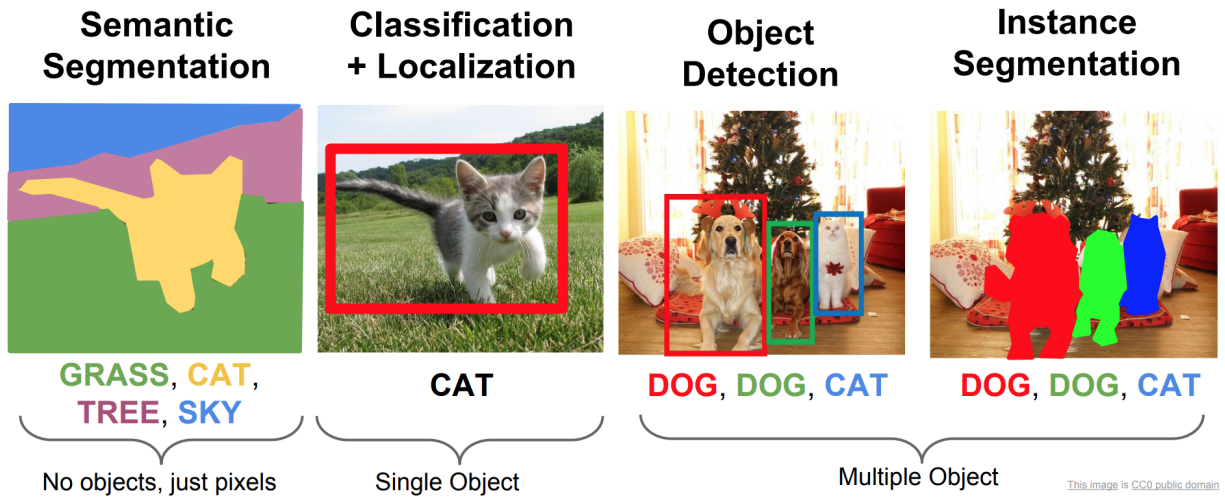

Figure 14: Image segmentation, semantic segmentation, and object detection. [216]

Despite these limitations, object detection and segmentation techniques have shown great potential in enabling autonomous navigation in various applications. As the technology continues to evolve, it is expected that these techniques will become even more accurate and efficient, making autonomous navigation safer and more reliable.

Object detection and segmentation are critical components of autonomous navigation, as they enable the system to identify and locate objects, such as obstacles, objects, and pedestrians in real-time. Deep learning algorithms, particularly convolutional neural networks, have been shown to be highly effective in object detection tasks and one of its main advantages is their ability to learn rich and complex representations of the objects being detected which allows them to identify objects with more accuracy and robustness, even in challenging scenarios such as adverse weather conditions or low-light environments. Additionally, deep learning algorithms can also be trained on large and diverse datasets, enabling them to learn to detect a wide range of objects. Additionally, deep learning approaches can handle real-time data from various sensors, including cameras, LiDARs, and radars. The information from these sensors can be processed and analyzed by deep learning algorithms in real-time, allowing the autonomous vehicle to respond quickly and accurately to any obstacles that may be present in its path.

Object detection techniques, such as Faster R-CNN and YOLO, have been shown to achieve high accuracy and speed in object detection, making them ideal for real-time applications. These techniques use deep learning models to analyze the digital image or video frames and identify the objects of interest. For example, in [230], Faster R-CNN and YOLOv5 has been used for relative navigation task in On-Orbit Servicing and Active Space Debris Removal Technology. They showed that in a formation flight simulation, while Faster R-CNN is more accurate than YOLOv5 but YOLO is 10 times faster. Visual SLAM has been used for semantic labeling and object detection by combining DeepCNN with Real-Time Graph-Based SLAM for an open-source ground robot [231].

In [232] a multi model based object detection with environment-context awareness introduced to solve the environment class imbalance problem for an autonomous mobile robots. They used YOLOv5m [233] with Objects365 [234] dataset for environment-specific object detection, ResNet [235] trained by Places365 [236] for scene classification. Authors in [237] use KITTI [163] and Lyft [238] dataset to train a doubled stereo-guided monocular 3D (SGM3D) object detection framework based on monocular images for autonomous vehicles navigation.

Furthermore, deep learning has the potential to leverage robots' indoor navigation performance. In a recent study by Afif et al. [239], lightweight EfcientDet [211] was evaluated as an assistive navigation system for the visually impaired people. The study demonstrated that deep learning-based object detection and classification can effectively aid indoor navigation for individuals with visual impairments. By utilizing the lightweight and efficient object detection algorithm EfficientDet, mobile robots with limited resources can accurately detect obstacles and environmental features in real-time in indoor environments. This technology can greatly enhance the safety and efficiency of indoor navigation, particularly for visually impaired individuals.

In recent years, there have been many advances in the field of deep learning-based obstacle detection. For example, researchers in [240] used TensorFlow [241] and OpenCV [242] for real-time classify and detect obstacles in each image pixel. Also, it provides a high resolution binary obstacle image.

Table 10: Image Segmentation Algorithms

Algorithm	Description
FCN [217]	Fully Convolutional Network, a CNN architecture that can output pixel-level predictions for semantic segmentation
UNet [218]	A CNN architecture that combines convolutional and deconvolutional layers to produce high-resolution segmentation masks
SegNet [219]	A CNN architecture that uses an encoder-decoder structure with skip connections to segment images
DeepLab [220]	A CNN architecture that uses atrous convolution and a global pooling layer to capture context for semantic segmentation
PSPNet [221]	Pyramid Scene Parsing Network, a CNN architecture that uses spatial pyramid pooling and multi-scale feature aggregation for semantic segmentation
ICNet [222]	A CNN architecture that performs real-time semantic segmentation by using a multi-resolution cascade and a shared feature extractor
ENet [223]	An efficient CNN architecture for real-time semantic segmentation on mobile devices
DeepLabv3+ [224]	An improved version of DeepLab that uses a feature pyramid and an encoder-decoder structure for semantic segmentation
HRNet [225]	A CNN architecture that uses a high-resolution representation for semantic segmentation, achieving state-of-the-art performance on various datasets
Mask R-CNN [226]	An extension of Faster R-CNN that adds a segmentation branch to predict the pixel-level mask for each object instance
LinkNet [227]	A lightweight encoder-decoder architecture for fast and accurate segmentation, which uses residual connections between the encoder and decoder to improve information flow
RefineNet [228]	A multi-path refinement network that employs residual connections and multi-scale feature fusion to produce accurate and detailed segmentations
BiSeNet [229]	A two-pathway network for real-time semantic segmentation, which combines spatial path (short and fast processing path) and context path (long and slow processing path) for accurate segmentation

A local and global defogging algorithm based on deep learning models for object detection in harsh weather scenarios proposed by Jiao and Wang [243]. The approach fuses the rich representation capability of visual sensors and the weather-resilient performance of inertial sensors to achieve robust positioning in all-weather conditions. Markov random field model is used by fusing gradient, curvature prior, and depth variance potential for obstacle segmentation in [244]. A CNN model is trained to predict the steering wheel angle and navigate the vehicle safely in a complex environment. LiteSeg [245] introduced by Luu et al. which is a lightweight architecture for adaptive road detection method that combines lane lines and obstacle boundaries. This model simultaneously detect lanes and avoid obstacles. They used NVIDIA Jetson TX2 and Unity software to test their model in a simulated environment. Deep Simple Online and Realtime Tracking (deep SORT) was combined with YOLOv3 to detect and track the dynamic obstacles in [246]. This model is used to detect and track buffaloes and human in paddy field environment.

Authors in [247] have developed a very deep CNN, so called U19-Net which improved encoder-decoder architecture for vehicle and pedestrian detection. The output of this model is a pixel-level mask which detects the presence of vehicles and pedestrians in each pixel. Ci et al. presented a new unexpected obstacle detection method for Advanced Driving Assistance Systems (ADAS) based on computer vision [248] which consists of two independent detection methods: a semantic segmentation method and an open-set recognition algorithm, that are combined in a Bayesian framework. This model is tested on the Lost and Found dataset [249] and shows improved detection rate and relatively low false-positive rate, particularly when detecting long-distance and small-size obstacles. The authors acknowledge the limitations of the method, including the false-positive rate of the open-set recognition algorithm, and suggest further work to reduce this rate and to improve the semantic segmentation network. Researchers in [250] used Deformable Detection Transformer to detect farmland obstacles in aerial images. In another study [67], the ME Mask R-CNN is proposed to conduct fine-grained detection of 11 kinds of obstacles so that the detection accuracy of train obstacle identification can be improved. Li et al. [251] presented a real-time computational efficient object detection framework. They collected a real world stereo dataset which consists of indoor and outdoor scenes. The authors used a stereo camera to generate a 3D point cloud and then used a voxelization method to convert the point cloud into a voxel grid. The voxel grid is then fed into a 3D convolutional neural network to detect objects. The authors compared their method with other 3D object detection methods and showed that their method is more computationally efficient than other methods. Further, Cortés et al. [252] presented an unsupervised domain adaptation training strategy for the semantic labeling of

3D point clouds. It bridges the domain gap caused by different LiDAR beams in 3D object detection tasks using LiDAR Distillation. This is done by training a model on data from one domain and then applying it to data from another domain, allowing the model to recognize objects in 3D point clouds even when they are misjudged as background points. The improved YOLOv3 algorithm (YOLOv3-4L) is used in [253] to detect obstacles by simplifying darknet-53 and forming a four-scale detection structure. The output is the type and position of obstacles coincident with dangerous areas. In [254], authors presented an on-board and UAV-based vision systems for long-range obstacle detection in railways. A CNN-based Obstacle Detection and Collision Prevention developed in [255] which has a Raspberry Pi 4 Model B as its control and processing unit. A support system for visually impaired person is developed in [256] to detect obstacles and notify the person. This model used YOLOv3-tiny with seven CNNs to extract the features from the image and identify the obstacles. Byun et al. [257] proposed an obstacle detection method for autonomous driving in agricultural environments based on point clouds from pulsed LiDAR technology. Deep learning model is used to detect property information of obstructions. YOLO model is used for lane detection and obstacle identification in [258] to Control Self-Driving Cars. They used real-time videos and the TuSimple dataset to test the proposed algorithm. Another study used YOLOv5 for real-time obstacle detection in maritime environments for autonomous berthing in [259]. Authors improved YOLOv5s by Convolutional Block Attention Module (CBAM) also, they developed squeeze-and-excitation block called YOLOv5-SE. Additionally in [260] YOLO model is used to detect and track obstacles for trains.

In the context of self-driving cars, object detection plays a critical role in detecting and tracking other vehicles, pedestrians, and traffic signs for ensuring safe navigation. One crucial aspect of the object detection system is its ability to accurately determine the presence of objects and classify them into their respective categories. Achieving high accuracy in object detection is crucial for the overall safety and success of autonomous driving systems. To address this problem Gasperini et al. [261] proposed CertainNet to estimate the uncertainty of the outputs (presence of object, and its class, location and size). They used KITTI dataset to train the model. In another study [262], the researchers investigated how LiDARs placement affects on the performance of object detection models. They showed that sensor placement is significant in 3D point cloud-based object detection, contributing to 5% to 10% performance discrepancy.

Another method for object detection in low visibility conditions is to fuse mmWave radar with visual sensor. The authors [263] proposed a method for object detection in low visibility conditions by using a combination of mmWave radar and camera. This method used in to develop Spatial Attention Fusion (SAF) for merging the feature maps of radar and camera. Their model has build upon FCOS [214] framework and trained on nuScenes dataset.

Autonomous Underwater Vehicles (AUVs) are one the key component for ocean exploration and surveillance. However, the underwater environment due to the presence of turbid water makes it difficult for AUVs to detect and recognize objects. In [264] the authors proposed DeepRecog framework for improving the performance of AUV vision systems for underwater exploration. The framework employs a three-pronged approach for image deblurring using CNNs, adaptive, and transformative filters, in addition to an ensemble object detection and recognition module that surpasses existing algorithms in terms of precision, such as YOLOv3, FasterRCNN + VGG16, and FasterRCNN. This approach offers real-time detection and recognition. They provide a practical solution to tackle the challenges faced by AUV vision systems in underwater settings. The combination of image deblurring and object detection within a single framework is a noteworthy achievement. The experimental results demonstrate the superior performance of the proposed method and its potential for real-world applications.

To enhance the safety of train operations it is crucial to detect the objects in rail region autonomously. Authors in [265], used LiDAR and camera to detect the obstacle within the rail region by utilizing CNNs for semantic segmentation and pixel-wise object detection. An encoder-decoder architecture based on CNNs was used to segment images for the purpose of identifying rail regions. In addition, the residual network structure and depth-wise separable convolution were used for obstacle detection. By using LiDAR, the model was able to cope with unpredictable weather conditions more robustly. The results shows a precision of 99.994%.

6.3 Localization and Mapping

A number of autonomous systems, including mobile robots and autonomous vehicles, use the concept of localization and mapping to accomplish their tasks. The purpose of these systems is to determine the vehicle's position and orientation based on the surrounding environment and to create a map of the environment as a result.

One of the primary challenges in localization and mapping is dealing with uncertainties in sensor measurements and motion models. To address this challenge, various probabilistic methods such as Kalman filters [266], particle filters [267], and graph-based SLAM (Simultaneous Localization and Mapping) [268] have been developed. These methods allow the system to estimate the robot's position and orientation and update the map of the environment as the robot moves.

In recent years, there has been significant progress in localization and mapping, thanks to advancements in sensor technology, algorithms, and machine learning. For example, deep learning-based methods have shown promising results in visual localization and mapping tasks by leveraging large-scale datasets and powerful neural network architectures. Furthermore, advances in multi-sensor fusion and cooperative localization have enabled more robust and accurate localization and mapping in complex environments.

Overall, localization and mapping are critical technologies for autonomous systems, enabling them to operate in dynamic and complex environments. The ongoing research and development in this area are expected to result in further advancements and improvements in the accuracy, robustness, and efficiency of these systems.

In following, we will discuss the application of deep learning for localization and mapping methods in detail.

6.3.1 Simultaneous Localization and Mapping (SLAM)

SLAM, or Simultaneous Localization and Mapping, is a method used in robotics and autonomous systems for building a map of an unknown environment while simultaneously determining the position of the system within the environment. The goal of SLAM is to provide the system with a consistent and accurate map of the environment while allowing it to navigate and make decisions based on its location within the map.

SLAM has been widely studied and has various applications in fields such as autonomous vehicles [269], unmanned aerial vehicles [270, 271], planetary rovers [272], spacecrafts [273], and robotics [274]. It is a fundamental problem in robotics and is considered a crucial component in the development of autonomous systems.

The majority of current SLAM techniques are built around the idea of using visual geometry to model the camera projections, movements, and surroundings. These techniques are characterized by their reliance on explicit modeling and as such, they are often referred to as model-based visual SLAM methods.

Model-based SLAM techniques are designed to perform well in environments where the camera projections, motions, and environments can be accurately represented using mathematical models. These techniques are generally robust and reliable, but they can also be sensitive to errors in the models, particularly in complex and changing environments.

These techniques can be divided into two main categories: direct methods and feature-based methods. Direct methods directly estimate the camera pose and map from the camera observations. Feature-based methods extract features from the camera observations and use them to estimate the camera pose and map.

In recent years, deep learning has been applied to SLAM to improve its accuracy and robustness. Deep learning-based SLAM methods have shown promising results in various applications such as visual SLAM, LiDAR SLAM, and RGB-D SLAM. For example, deep learning-based visual SLAM methods use deep neural networks to estimate depth information from monocular or stereo camera inputs, while deep learning-based LiDAR SLAM methods use deep neural networks to classify and segment the environment into different objects, making it easier to build a map.

Deep learning has also been applied to SLAM for the purpose of addressing challenges such as handling dynamic objects, improving real-time performance, and dealing with large-scale environments. The DynaVINS approach, as presented in the recent paper by Song et al. [275], represents a promising application of deep learning to enhance the robustness of visual-inertial SLAM in dynamic environments. This approach enables the system to continue building and updating the map even when the environment undergoes changes, thereby improving its overall robustness.

In conclusion, the integration of deep learning with SLAM has shown significant promise and has the potential to significantly improve the performance of SLAM systems. There is still ongoing research in this field and it is expected that deep learning will continue to play an important role in the development of SLAM technology.

A method for constructing object-oriented semantic maps developed in [276]. It combines the semantic information extracted from instance segmentation with RGB-D version of ORB-SLAM2 [277]. The method not only reduces the absolute positional errors (APE) and improves the positioning performance of the system, but also segments the point cloud model of objects in the environment with high accuracy. The proposed method that can help a robot better understand and interact with its environment, with potential applications in the field of human-computer interaction. The paper emphasizes that in order for a robot to have sophisticated interactions with its surroundings, it needs access to 3D semantic information about the environment. The paper also outlines the method of target tracking based on instance segmentation and provides experimental results on a TUM dataset [278].

A visual SLAM-based robotic mapping method, which utilizes a stereo camera system on a rover, has been proposed in [279] to address the planetary construction problem. The effectiveness of the proposed method for local 3D terrain mapping has been evaluated with point-clouds from terrestrial LiDAR. However, the paper notes that the camera system on the rover is susceptible to varying illumination conditions, and global localization remains a concern for correcting the rover's trajectory estimate. To create a dense 3D point-cloud map, a self-supervised CNN model is trained using

the stereo camera system to estimate a disparity map. The paper acknowledges the method's technical limitations and proposes adaptive robotic mapping as a means to enhance the stereo SLAM's capabilities for the construction of highly detailed and accurate 3D point-clouds.

6.3.2 Attitude Estimation

Accurate attitude estimation is an essential requirement for effective navigation in any environment. It refers to the process of determining the orientation of a robot relative to a fixed reference frame [280]. It plays a critical role in the development of autonomous systems. Different types of sensors can be used to perform attitude estimation, including visual, inertial, and GNSS-based sensors.

Inertial sensors measure the robot's linear and angular velocity, which are then integrated over time to accurately estimate its position and orientation. However, the integration process can be susceptible to a range of error sources such as sensor noise, drift, and biases. To ensure reliable and precise attitude estimation, sensor fusion techniques can be employed to combine the measurements from various sensors to minimize the impact of individual sensor errors [28]. Additionally, advanced machine learning algorithms, including Kalman filters or particle filters, can be applied to further improve the accuracy of attitude estimation.

Attitude estimation is a crucial component for a range of applications, including navigation, mapping, and obstacle avoidance. Reliable and accurate attitude estimation allows a robot to determine its position and orientation relative to a fixed reference frame, which is necessary for navigation and obstacle avoidance tasks. Mapping tasks require knowledge of the robot's location and orientation to create a 3D representation of the environment, which is essential for path planning and other navigation tasks. Reliable attitude estimation is also critical for obstacle avoidance tasks, allowing a robot to avoid collisions with objects in its environment by accurately estimating its position and orientation. The development of advanced attitude estimation techniques has made it possible to build autonomous systems capable of operating in complex and dynamic environments, making attitude estimation a vital component of the robotics and autonomous systems field.

Several techniques have been developed for attitude estimation, including the complementary filter, Kalman filter, and particle filter. The complementary filter is a simple and effective method that combines the high-frequency response of the gyroscope with the low-frequency response of the accelerometer. The Kalman filter is a popular state estimation technique that uses a probabilistic model to estimate the true state of the system from noisy sensor measurements. The particle filter is a non-parametric filtering method that uses a set of weighted particles to represent the probability distribution of the robot's state.

In summary, attitude estimation is a critical component in the development of autonomous systems, and its accuracy is essential for successful navigation and mapping. With the advancements in sensor technologies and filtering techniques, attitude estimation has become more accurate and reliable, enabling robots to operate in complex environments with greater efficiency and effectiveness.

6.3.3 Odometry

Odometry is the process to determine the relative change in the position and orientation between two or more coordinate frames [281]. There are various odometry techniques, including visual [282], inertial [283], encoder [284], optical flow [285], GPS/GNSS [286], and lots of others.

The most common odometry techniques are as follows [287]:

- **Inertial Odometry:**
- **Visual Odometry:** Utilizing computer vision to estimate the position and orientation of a camera relative to a fixed reference frame. Deep learning can be employed to extract high-level features from visual data which could be used as an alternative solution to the Odometry problem.
- **Visual-Inertial Odometry:** Fusing visual and inertial data to estimate pose and trajectory. It involves the integration of measurements from the IMU with visual data from a camera. This enables the reconstruction of the 3D scene structure and the camera's motion through it. The visual data collected from the camera is egocentric, meaning it is from the camera's point of view, while the IMU data is in the global reference frame.

Further, visual odometry techniques can be broadly divided into two distinct categories:

- **Supervised:** The most popular VO techniques and used when the ground truth data is available which maps the extracted features from image to motion transformation [288].

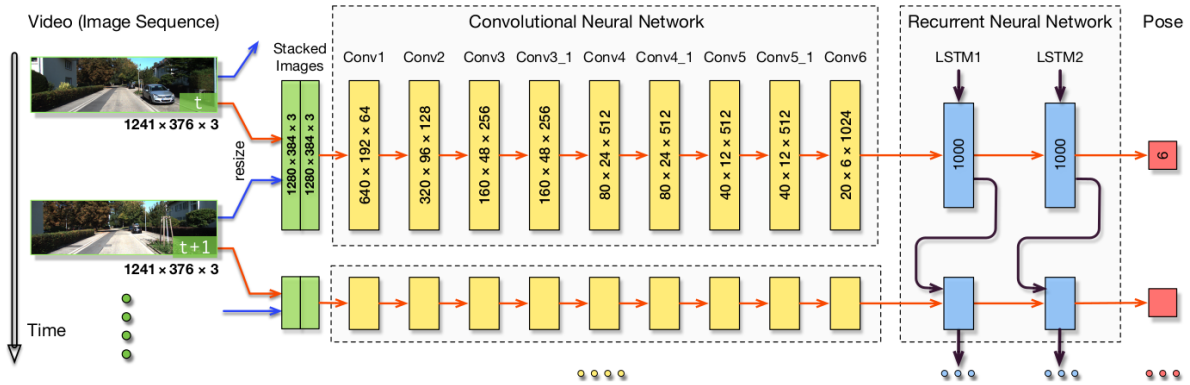

Figure 15: DeepVO, A typical structure of an End-to-End Visual Odometry [289]

- **Unsupervised:** A learning scheme where the model is trained on unlabeled data, without the need for explicit ground truth information. In the context of visual data, unsupervised learning can be used to extract meaningful features or representations from an unlabeled dataset and when ground truth labels are not available or too expensive to obtain.

One of the earliest works on the supervised VO, conducted by Konda et al. [290]. They utilized CNN to predict velocity and changes in direction. DeepVO [289] combined CNN and RNN to develop an End-to-End deep learning framework for pose estimation. Authors used deep neural network to extract the features from images via CNN and learn the temporal dependencies through RNNs. They used KITTI dataset [291] to train and test the model. To calculate the error between the prediction and true position and orientation they used the Mean Square Error (MSE) of all positions \mathbf{p} and orientations ϕ in the sequence. The MSE of the position is defined as:

$$\theta^* = \frac{1}{N} \sum_{i=1}^N \sum_{t=1}^T \|\mathbf{p}_t^* - \mathbf{p}_t\|_2^2 + \|\phi_t^* - \phi_t\|_2^2 \quad (27)$$

where \mathbf{p}_t^* and ϕ_t^* are the predicted position and orientation at time t , \mathbf{p}_t and ϕ_t are the true position and orientation at timestep t , and N is the number of samples. Based on this architecture, various models have been developed, since. Similarly, MagicVO [292] combined CNN and Bi-LSTM to 6 DoF pose estimation. They replaced LSTM layers with Bi-LSTM layers followed by a 256 unit dense layer. The results shows an improvement in terms of translational and rotational error. However their comparison results consist of only five sequences.

In contrast with DeepVO, UnDeepVO [293], employed unsupervised techniques to develop an end-to-end VO framework. They used VGG-based CNN [294] as the pose estimator and it trained using stereo images instead of consecutive monocular images

The monocular visual odometry algorithm UnDeepVO, proposed by Li et al. [293], offers an alternative approach to DeepVO. Unlike DeepVO, UnDeepVO is an end-to-end framework for visual odometry that employs unsupervised learning to estimate the camera's motion. It uses a VGG-based CNN [294] as the pose estimator, which is trained on stereo images, rather than consecutive monocular images (Figure 16). The authors use unsupervised learning to train the CNN, incorporating both spatial and temporal dense information in the loss function to improve accuracy and robustness.

By incorporating unsupervised learning and stereo images, UnDeepVO can estimate both pose and depth using a deep neural network. Compared to other monocular methods such as ORB-SLAM without loop closure, this model has been shown to be more accurate and robust. Overall, UnDeepVO provides a promising approach to visual odometry that does not rely on labeled data and can achieve comparable or superior performance to other monocular methods. Its use of unsupervised learning and stereo images provides a foundation for future research in this area.

GANVO [295] used Generative Adversarial Network for unsupervised learning to estimate pose and generate depth map for a monocular video sequences. Their result shows that the model outperform conventional and other unsupervised methods. An end-to-end, Sequence-to-sequence Probabilistic Visual Odometry (ESP-VO) deep learning framework is presented by Wang et al. [296] which used monocular camera and Recurrent Convolutional Neural Network (RCNN) for pose estimation directly from raw images.

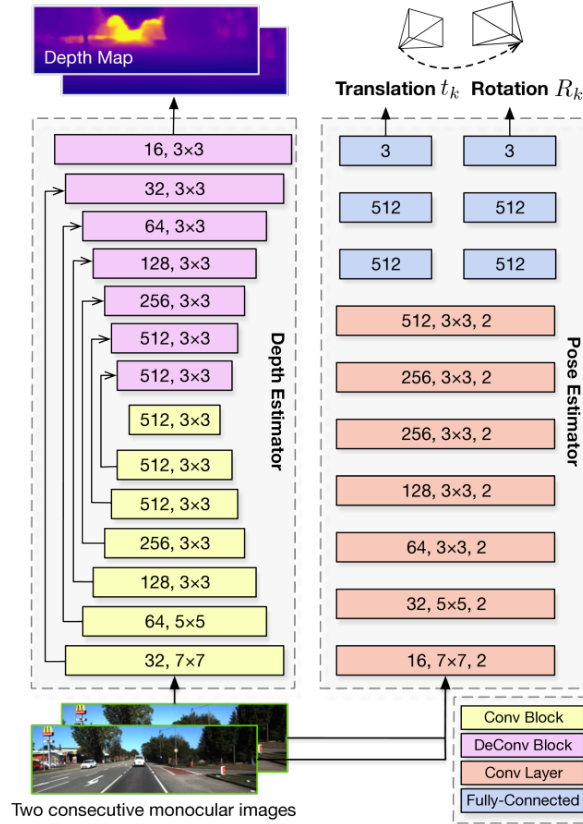

Figure 16: UnDeepVO Architecture for Unsupervised End-to-End Visual Odometry [293]

VINet [297] use monocular camera and IMU for pose estimation. It was one of the first End-to-End Visual-Inertial Odometry (VIO) deep learning models which formulates the odometry a sequential learning problem. VINet contains two main parts, (1) CNN and (2) LSTM. CNN takes two sequential images to produce the feature vector describing the motion. In contrast, LSTM network process the IMU measurements to extract the temporal motion characteristics hidden in sensor raw data. Furthermore, a core LSTM networks combined and fused the features obtained from CNN and LSTM to predict the pose information. Employing both visual and inertial data increased its robustness. VINet trained and tested on KITTI dataset. Similarly, HVIONet proposed for Unmanned Aerial System [298], which is hybrid CNN-BiLSTM network and trained on EuRoC dataset. Compare to VINet, it has multiple fully connected layer after CNN and LSTM networks. However they only tested their network on EuRoC dataset and ROS environment. Yang et al. [299] presented an adaptive visual inertial odometry system that reduces computational redundancy by selectively deactivating the visual modality. The proposed method employs a policy network that learns to deactivate the visual feature extractor based on the current motion state and IMU readings, achieving up to 78.8% computational complexity reduction for KITTI dataset evaluation. The authors argue that visual data processing is considerably more resource-intensive than that of the inertial measurement unit, and may not always enhance pose estimation accuracy. The findings suggest that the proposed approach outperforms simple sub-optimal strategies and offers an interpretable, scenario-dependent adaptive behavior. Notably, the authors note that the learned strategy is model-agnostic and can be easily implemented in other deep VIO systems.

Another study [300] was conducted to assess the feasibility of using VIO as a redundant positioning system for high-altitude drone operation and the collected data through this research has been published in [301]. The study shows that the stereo-VIO provided the results, with a baseline of 30 cm providing better results than the mono-VIO for all flying altitudes of 40-100 m. Also they found that external conditions affected the estimation accuracy, and fusing IMU data improved positioning performance and the robustness of the system to external conditions. The authors suggest future research could focus on developing well-engineered systems capable of real-time estimation, integrating additional sensors to reduce drifts, evaluating whether robust positioning with stereo-VIO outperforms commonly used mono-VIO algorithms, and studying the effects of system calibration models.

Tu et al. have presented a novel EMA-VIO framework [302] that utilizes external memory and attention-based fusion mechanism to estimate the position and translation of mobile agents using visual-inertial data. The proposed framework has shown superior performance in different scenarios, including challenging ones such as overcast days and water-filled ground, and has outperformed traditional and learning-based VIO baselines. The paper introduces a multi-state geometric constraint in the pose loss function that accelerates training convergence and provides more accurate pose results. The experimental results on both the KITTI dataset and the authors’ own robot dataset validate the effectiveness of the proposed framework, especially in challenging environments such as overcast days and wet ground that are difficult for traditional VIOs to extract and match visual features. The findings demonstrate that EMA-VIO surpasses both traditional VIO models and other learning-based VIO models.

SelfVIO [303] is a deep learning-based monocular Visual-Inertial Odometry (VIO) system that utilizes self-supervised learning to estimate both the camera pose (position and orientation) and depth of objects in the environment. Monocular VIO systems only use a single camera, as opposed to stereo or multi-camera systems, and use both visual information and inertial data from an IMU to estimate the camera’s pose and depth. The system is trained on unlabeled data and learns to predict the motion of the camera and depth of objects based on the observations themselves.

Authors in [304] used CNN-FFNN to estimate the speed by using IMU raw measurements over a window of 2 seconds. IONet [305], one of the first Inertial End-to-End deep learning network for odometry. It consist of two stacked Bi-LSTM layers, each layer has 96 units. The first layer takes the accelerometer and gyroscope readings in a windows of 200 frames and stride of 10 as input, and the second layer takes the output of the first layer as input. The output is the polar vector as the relative position and orientation of the sensor.

$$(\mathbf{a}, \omega)_{200,6} \rightarrow (\delta \mathbf{p}, \delta \phi)_1 \quad (28)$$

Authors in [306] used deep learning to estimate displacement in polar coordinates and the corresponding uncertainty over a window of 200 frames by using IMU raw data. The model input shape is $(200, 6)$, where 6 is the number of features (accelerometer and gyroscope readings) and 200 is the window size. The input fed a fully connected layer with 128 units, followed by a 128 and 256 units Bi-LSTM layers. The output of the last Bi-LSTM fed into a 128 units fully connected layer, which is followed by double 2 units fully connected layer to predict the displacement in polar coordinates amd the uncertainty.

AbolDeepIO [307] utilized a novel triple channel LSTM-based network for autonomous vehicle inertial odometry. The proposed model extract the relationship between accelerometer and gyroscope readings followed by their sampling rate to estimate any changes in position and orientation of the sensor.

Lima et al. [308] proposed a deep inertial odometry method that utilizes a combination of convolutional neural networks (CNN) and bidirectional long short-term memory (BiLSTM) layers. The model takes two distinct inputs of the shape $(200, 3)$, which represents the window size of 200 and the number of axis. The CNN extracts features from the inertial measurement unit (IMU) sensor readings, which are then passed to two BiLSTM layers. The output of the final BiLSTM layer is fed into a fully connected layer with seven units, representing the orientation in quaternion form and position in metric form. Additionally, a multi-task learning framework is integrated to balance the pose distance metrics. The equation multi-task learning is as follows:

$$\mathbf{L}_{MTL} = \sum_{i=1}^N \exp(-\log \sigma_i^2) L_i + \log \sigma_i^2 \quad (29)$$

where σ_i and L_i represent the variance and loss function of task i , respectively. The multi-task learning framework is implemented by training the model to predict both the device’s translation and rotation. The loss function is a weighted sum of the translation and rotation error, and the weights of the two tasks are dynamically adjusted during training to balance the contributions of the translation and rotation errors. The additional output layer predicts the rotation quaternion between two sequential moments. The loss function for the multi-task learning is a combination of the mean absolute error of the predicted translation and rotation, weighted by two coefficients that control the relative importance of the two tasks. The coefficients are updated during training using a technique called dynamic weighting, which balances the contributions of the two tasks based on their performance.

The multi-task learning approach allows the model to learn to balance the importance of rotation and translation, leading to improved accuracy in estimating the device’s position and orientation. The proposed method outperforms recent inertial odometry methods in both qualitative and quantitative evaluations.

One of the primary constraints of Lima et al.’s method is its generalizability. This model demonstrates optimal performance solely on the dataset on which it was trained. Furthermore, due to the model’s inability to handle variations in gyroscope sampling rates, it is incapable of accurately estimating the position and orientation of the sensor when exposed to diverse sampling rates [?].

Another deep inertial odometry model, called Tightly-coupled Extended Kalman Filter framework (TILO) developed by Liu et al. [309]. This model used IMU measurements to estimate relative position and orientation by using a deep neural network coupled by an EKF. Two Bidirectional-LSTM is used to estimate the foot trajectory in gait analysis by using the accelerometer and gyroscope readings with window size of 256 [310]. In [311], authors presented a real-time pedestrian position estimation based on smartphone internal IMU measurements. They used window size of 150, the first 100 frames are selected from the past measurements and the rest of 50 frames are selected from the future measurements. This method helps them to reduce the latency of the system in comparison to the other methods such as IONet. The model is similar to Lima et al. network, consist of two distinct input (accelerometer and gyroscope), each input followed by two CNN layer and a max pooling layer with concatenated and fed into two-Bidirectional-LSTM layer.

Uno et al. [312] introduced Deep Inertial Underwater Odometry (DIUO) system for underwater 6-DOF odometry based on TLIO network. Convolutional block attention modules is combined with Res2Net in [313], to estimate the velocity in x and y axis. They test their model on the RONIN and OxIOD dataset and the results show that the proposed model outperforms the other models in most of scenarios. A LSTM-based model for visual-inertial odometry has been proposed for UAVs in GNSS denied environments by Deraz et al. [314]. Wang et al. introduced A2DIO model which used a hybrid CNN-LSTM architecture with a temporal attention block for pedestrian odometry based on a window of 2-second IMU measurements [315].

One of the major drawbacks of using GNSS and GPS for navigation is their weakness against signal obstruction, such as tall buildings or natural obstacles like mountains. To address the lack of reliable indoor positioning alternatives to GNSS/INS, authors presented L5IN+ [316]. The proposed methods consist of two approaches, namely deep inertial odometry and Kalman Filtering, to predict velocity vector elements and relative positions with noisy labeled data from 5G networks. The authors also develop an analytical platform for data collection and a simulation website for researchers to generate ground truth trajectories and simulate cellular measurements with assigned quality and exact error values. The major contribution of this paper is the development of a novel combination of DNN and KF for the relative and absolute positioning. The DNN model is designed to be robust to noisy labelled data, for example, data from a 5G network. The authors also introduce a semantic error generation approach to their simulation model.

The errors and time-varying biases present in the measurements of MEMS-based IMUs cause large drift in pose estimates, and only relying on the integration of the inertial measurements for state estimation is infeasible. In [317], authors proposed a learning-based odometry algorithm for autonomous drone racing tasks that uses an IMU as the only sensor modality. The proposed algorithm aims to overcome this problem by combining an EKF, which is driven by the IMU measurements, with a learning-based module, which has access to the control commands, in the form of commanded collective thrust. The learning-based module is a TCN that takes as input a buffer of commanded collective thrust and gyroscope measurements and outputs an estimate of the distance traveled by the quadrotor, which is used to update the filter. The proposed algorithm is compared to state-of-the-art filter-based and optimization-based visual-inertial odometry algorithms, as well as the state-of-the-art learned-inertial odometry algorithm TLIO, and achieves superior performance. The main contribution of this work is the development of an inertial odometry algorithm that combines a model-based filter with a learning-based module to improve the accuracy of state estimation for agile quadrotor flight. Another study [318] conducted on improving quadrotor state estimation. The proposed framework, Dido, employs GRU-based networks to learn both IMU and dynamic properties for better performance in quadrotor state estimation. The paper demonstrates that the system provides precise observations with only raw IMU and tachometer data, and combines quadrotor dynamic constraints and network observations within a two-stage EKF to jointly estimate kinematic, dynamic states and extrinsic parameters.

Legged robots offer advantages over wheeled robots in traversing uneven terrain, but controlling and navigating them is challenging due to the complex dynamics of legged locomotion. Navigation and odometry are crucial, involving determining the robot's position and movement through sensor data analysis. Legged robots commonly use multiple sensors such as cameras, IMUs, and range finders to improve accuracy and reliability. Ongoing research focuses on the development of advanced algorithms and sensors to enhance legged robot navigation and odometry. Legged robots have the potential to play a vital role in exploring remote and hazardous environments, disaster response, and search and rescue operations.

To address the challenges in legged robots navigation, Buchanan et al. [319] proposed a new method to improve proprioceptive state estimation. The approach is based on using a learned displacement measurement from IMU readings, which reduces the drift in state estimation caused by unreliable leg odometry on challenging terrains such as slipping and compressible surfaces. The displacement measurement from IMU readings is combined with traditional leg odometry, and results from real robot experiments show a reduction in relative pose error by 37% in challenging scenarios and a 22% reduction in error when used with vision systems in visually degraded environments. The article's contributions include a kinematics-inertial estimator based on learned IMU displacement measurements, integration with

both a filter-based estimator and a factor graph, and extensive testing on a quadruped robot, including field experiments navigating a mine. The study concludes that the addition of the learned measurement significantly improved state estimation compared to a traditional kinematic-inertial estimator without the learned measurement.

The heading/yaw angle could be calculated by magnetometer however, this method suffers from the magnetic interference, drift, bias. The authors of [320] proposed a system to estimate the magnetometer bias online to provide a global consistent heading estimation in magnetic disturbances. They used a graph-optimization-based system which fused learning-based inertial odometry and magnetometer readings. The proposed system showed a 50% improvement in positioning accuracy in an indoor scenario. They simplified the model to perform a real-time estimation and compensation procedure and achieved superior positioning performance when compared to calibrated magnetometer data and raw magnetometer data. The proposed method is suitable for consumer-grade devices as it does not require calibration before use. The study combined network and traditional empirical models to form a robust pedestrian positioning solution. The testing stage fuses the information from IMU, the pre-trained network, and magnetometer to provide a trajectory without heading drift and is not affected by local magnetic field disturbance. The system uses the long-term mean value of the geomagnetic field to obtain a consistent global heading direction and stores magnetic field observations for a sufficiently long time or keyframes to estimate magnetometer biases.

The research conducted by Saha and colleagues [321] proposes a new framework for neural inertial navigation that addresses the challenge of deploying machine learning models on ultra-resource-constrained (URC) devices in GPS-denied environments. The framework, named TinyOdom, utilizes a hardware-in-the-loop (HIL) automated machine learning (AutoML) framework based on Bayesian Optimization (BO) to create lightweight inertial odometry models that are suitable for deployment on URC devices. The framework incorporates hardware and quantization-aware Bayesian neural architecture search (NAS) and a TCN backbone to develop lightweight models. Moreover, the proposed framework incorporates a magnetometer, physics, and velocity-centric sequence learning formulation to enhance the localization performance of the lightweight models, along with a barometric g-h filter that tracks altitude with high accuracy and is resistant to disturbances and dynamics. The authors evaluated their framework on four different URC hardware platforms for four different applications, and the results show that it is an effective and efficient solution for neural inertial navigation on URC devices. They also suggest that their work has the potential to enhance the cost and energy footprint of embedded odometry while being adaptable to any reduced footprint hardware.

6.4 Path Planning and Obstacle Avoidance

This sub-section could describe the use of deep learning in the development of algorithms for autonomous navigation systems to plan safe and efficient paths while avoiding obstacles in the environment. It could discuss the use of deep reinforcement learning, deep neural networks, and other deep learning algorithms to model the relationships between the vehicle's actions and the environment.

Authors in [322] developed an adaptive deep meta-learning energy-aware path planner that uses a 1D convolutional neural network to analyze terrains sequentially, as experienced by an autonomous mobile robot (AMR), to provide energy estimates in real-time. The paper provides evidence of the method's improved robustness to provide more informed energy estimations and energy-efficient paths when navigating challenging uneven terrains. The method integrates the adaptive energy estimator into a state-lattice A* path planner to consider actual robot mobility constraints. The experimental results show the model's performance in simulation over several typologies of natural terrains and unstructured geometries, and it is compared with alternative state-of-the-art deep learning solutions. The method's main novelty is the development of a deep meta-learning architecture that efficiently adapts its energy estimates to new terrains based on a small number of local measurements. The paper is well-structured, and the proposed method is adequately explained with diagrams and figures. The results are promising and show the method's potential in improving energy efficiency in autonomous mobile robots.

7 Conclusion

However one of the main challenging parts of utilizing deep learning for autonomous navigation is training, not only the computational cost, but also the availability of datasets. While for various applications you should synthesize their own dataset because of unavailability of dataset, for other applications you must spend much time for data preprocessing due to missing data, false labels, or

Acknowledgements

The study presented in this paper is based on A. Asgharpoor Golroudbari's M.Sc. Thesis ("Design and Simulation of Attitude and Heading Estimation Algorithm", Department of Aerospace, Faculty of New Sciences & Technologies, University of Tehran). We would like to express our sincere gratitude to Prof. Parvin Pasalar, Dr. Farsad Nourizade, and Dr. Maryam Karbasi Motlagh at the Students' Scientific Research Center at Tehran University of Medical Sciences. Their invaluable scientific advice and support in the form of access to computational resources were instrumental in the success of our research. We are deeply appreciative of their contributions and the time they dedicated to helping us.

Conflict of Interest

The authors declare no competing interests.

References

- [1] Kenneth R Britting. *Inertial navigation systems analysis*. Artech House Print on Demand, 2010.
- [2] Jianjun Ni, Kang Shen, Yinan Chen, Weidong Cao, and Simon X Yang. An improved deep network-based scene classification method for self-driving cars. *IEEE Transactions on Instrumentation and Measurement*, 71:1–14, 2022.
- [3] Thomas Lee, Susan Mckeever, and Jane Courtney. Flying free: A research overview of deep learning in drone navigation autonomy. *Drones*, 5(2):52, 2021.
- [4] Farzad Niroui, Kaicheng Zhang, Zendai Kashino, and Goldie Nejat. Deep reinforcement learning robot for search and rescue applications: Exploration in unknown cluttered environments. *IEEE Robotics and Automation Letters*, 4(2):610–617, 2019.
- [5] Nicola Muscettola, Gregory A Dorais, Chuck Fry, Richard Levinson, Christian Plaunt, and Daniel Clancy. Idea: Planning at the core of autonomous reactive agents. In *Sixth International Conference on AI Planning and Scheduling*, pages ., 2002.
- [6] Adrian M Haith and John W Krakauer. Model-based and model-free mechanisms of human motor learning. In *Progress in motor control: Neural, computational and dynamic approaches*, pages 1–21. Springer, 2013.
- [7] Artur Wolek and Craig A Woolsey. Model-based path planning. *Sensing and Control for Autonomous Vehicles: Applications to Land, Water and Air Vehicles*, pages 183–206, 2017.
- [8] George P Kontoudis and Kyriakos G Vamvoudakis. Kinodynamic motion planning with continuous-time q-learning: An online, model-free, and safe navigation framework. *IEEE transactions on neural networks and learning systems*, 30(12):3803–3817, 2019.
- [9] Kai Zhu and Tao Zhang. Deep reinforcement learning based mobile robot navigation: A review. *Tsinghua Science and Technology*, 26(5):674–691, 2021.
- [10] Pieter Abbeel, Dmitri Dolgov, Andrew Y Ng, and Sebastian Thrun. Apprenticeship learning for motion planning with application to parking lot navigation. In *2008 IEEE/RSJ International Conference on Intelligent Robots and Systems*, pages 1083–1090. IEEE, 2008.
- [11] Fatma El-Zahraa El-Taher, Ayman Taha, Jane Courtney, and Susan Mckeever. A systematic review of urban navigation systems for visually impaired people. *Sensors*, 21(9):3103, 2021.
- [12] Tianhai Wang, Bin Chen, Zhenqian Zhang, Han Li, and Man Zhang. Applications of machine vision in agricultural robot navigation: A review. *Computers and Electronics in Agriculture*, 198:107085, 2022.
- [13] Niall O'Mahony, Sean Campbell, Lenka Krpalkova, Daniel Riordan, Joseph Walsh, Aidan Murphy, and Conor Ryan. Deep learning for visual navigation of unmanned ground vehicles: A review. In *2018 29th Irish Signals and Systems Conference (ISSC)*, pages 1–6. IEEE, 2018.
- [14] Fadi AlMahamid and Katarina Grolinger. Autonomous unmanned aerial vehicle navigation using reinforcement learning: A systematic review. *Engineering Applications of Artificial Intelligence*, 115:105321, 2022.
- [15] Samira Badrloo, Masood Varshosaz, Saied Pirasteh, and Jonathan Li. Image-based obstacle detection methods for the safe navigation of unmanned vehicles: A review. *Remote Sensing*, 14(15):3824, 2022.
- [16] Jianing Song, Duarte Rondao, and Nabil Aouf. Deep learning-based spacecraft relative navigation methods: A survey. *Acta Astronautica*, 191:22–40, 2022.

- [17] Erdem Turan, Stefano Speretta, and Eberhard Gill. Autonomous navigation for deep space small satellites: Scientific and technological advances. *Acta Astronautica*, 2022.
- [18] Wenhui Huang, Yanxin Zhou, Xiangkun He, and Chen Lv. Goal-guided transformer-enabled reinforcement learning for efficient autonomous navigation. *arXiv preprint arXiv:2301.00362*, 2023.
- [19] Bineeth Kuriakose, Raju Shrestha, and Frode Eika Sandnes. Deepnavi: A deep learning based smartphone navigation assistant for people with visual impairments. *Expert Systems with Applications*, 212:118720, 2023.
- [20] Walead Kaled Sleaman, Alaa Ali Hameed, and Akhtar Jamil. Monocular vision with deep neural networks for autonomous mobile robots navigation. *Optik*, 272:170162, 2023.
- [21] Bernd Ludwig, Gregor Donabauer, Dominik Ramsauer, and Karema al Subari. Urwalking: Indoor navigation for research and daily use. *KI-Künstliche Intelligenz*, pages 1–8, 2023.
- [22] Kaiwen Yuan and Z Jane Wang. A simple self-supervised imu denoising method for inertial aided navigation. *IEEE Robotics and Automation Letters*, 2023.
- [23] Thai-Viet Dang and Ngoc-Tam Bui. Multi-scale fully convolutional network-based semantic segmentation for mobile robot navigation. *Electronics*, 12(3):533, 2023.
- [24] Alejandro Martinez Acosta. Drone navigation using octrees and object recognition for intelligent inspections. In *AIAA SCITECH 2023 Forum*, page 1075, 2023.
- [25] Yaohua Liu, Qingsong Luo, and Yimin Zhou. Deep learning-enabled fusion to bridge gps outages for ins/gps integrated navigation. *IEEE Sensors Journal*, 22(9):8974–8985, 2022.
- [26] Roshan Ayyalasomayajula, Aditya Arun, Chenfeng Wu, Sanatan Sharma, Abhishek Rajkumar Sethi, Deepak Vasisht, and Dinesh Bharadia. Deep learning based wireless localization for indoor navigation. In *Proceedings of the 26th Annual International Conference on Mobile Computing and Networking*, pages 1–14, 2020.
- [27] Zhijian Liu, Alexander Amini, Sibozhu, Sertac Karaman, Song Han, and Daniela L Rus. Efficient and robust lidar-based end-to-end navigation. In *2021 IEEE International Conference on Robotics and Automation (ICRA)*, pages 13247–13254. IEEE, 2021.
- [28] Arman Asgharpour Golroudbari and Mohammad Hossein Sabour. End-to-end deep learning framework for real-time inertial attitude estimation using 6dof imu. *arXiv preprint arXiv:2302.06037*, 2023.
- [29] Adrian Carrio, Carlos Sampedro, Alejandro Rodriguez-Ramos, and Pascual Campoy. A review of deep learning methods and applications for unmanned aerial vehicles. *Journal of Sensors*, 2017, 2017.
- [30] Cuebong Wong, Erfu Yang, Xiu-Tian Yan, and Dongbing Gu. Adaptive and intelligent navigation of autonomous planetary rovers—a survey. In *2017 NASA/ESA Conference on Adaptive Hardware and Systems (AHS)*, pages 237–244. IEEE, 2017.
- [31] Md Zahangir Alom, Tarek M Taha, Chris Yakopcic, Stefan Westberg, Paheding Sidike, Mst Shamima Nasrin, Mahmudul Hasan, Brian C Van Essen, Abdul AS Awwal, and Vijayan K Asari. A state-of-the-art survey on deep learning theory and architectures. *electronics*, 8(3):292, 2019.
- [32] Muhammad Mudassir Ejaz, Tong Boon Tang, and Cheng-Kai Lu. Autonomous visual navigation using deep reinforcement learning: An overview. In *2019 IEEE Student Conference on Research and Development (SCoReD)*, pages 294–299. IEEE, 2019.
- [33] Frank Emmert-Streib, Zhen Yang, Han Feng, Shailesh Tripathi, and Matthias Dehmer. An introductory review of deep learning for prediction models with big data. *Frontiers in Artificial Intelligence*, 3:4, 2020.
- [34] Sorin Grigorescu, Bogdan Trasnea, Tiberiu Cocias, and Gigel Macesanu. A survey of deep learning techniques for autonomous driving. *Journal of Field Robotics*, 37(3):362–386, 2020.
- [35] You Li, Ruizhi Chen, Xiaoji Niu, Yuan Zhuang, Zhouzheng Gao, Xin Hu, and Naser El-Sheimy. Inertial sensing meets artificial intelligence: Opportunity or challenge? *arXiv preprint arXiv:2007.06727*, 2020.
- [36] Jianjun Ni, Yanan Chen, Yan Chen, Jinxiu Zhu, Deena Ali, and Weidong Cao. A survey on theories and applications for self-driving cars based on deep learning methods. *Applied Sciences*, 10(8):2749, 2020.
- [37] Changhao Chen, Bing Wang, Chris Xiaoxuan Lu, Niki Trigoni, and Andrew Markham. A survey on deep learning for localization and mapping: Towards the age of spatial machine intelligence, 2020.
- [38] Zewen Li, Fan Liu, Wenjie Yang, Shouheng Peng, and Jun Zhou. A survey of convolutional neural networks: analysis, applications, and prospects. *IEEE transactions on neural networks and learning systems*, 2021.
- [39] Priya Roy and Chandreyee Chowdhury. A survey of machine learning techniques for indoor localization and navigation systems. *Journal of Intelligent & Robotic Systems*, 101(3):63, 2021.

- [40] Stefano Silvestrini and Michèle Lavagna. Deep learning and artificial neural networks for spacecraft dynamics, navigation and control. *Drones*, 6(10):270, 2022.
- [41] Jiangying Qin, Ming Li, Deren Li, Jiageng Zhong, and Ke Yang. A survey on visual navigation and positioning for autonomous uavs. *Remote Sensing*, 14(15):3794, 2022.
- [42] Li-Hua Wen and Kang-Hyun Jo. Deep learning-based perception systems for autonomous driving: A comprehensive survey. *Neurocomputing*, 2022.
- [43] Ian Goodfellow, Yoshua Bengio, and Aaron Courville. *Deep learning*. MIT press, 2016.
- [44] Warren S McCulloch and Walter Pitts. A logical calculus of the ideas immanent in nervous activity. *The bulletin of mathematical biophysics*, 5:115–133, 1943.
- [45] Frank Rosenblatt. The perceptron: a probabilistic model for information storage and organization in the brain. *Psychological review*, 65(6):386, 1958.
- [46] David E Rumelhart, Geoffrey E Hinton, and Ronald J Williams. Learning representations by back-propagating errors. *nature*, 323(6088):533–536, 1986.
- [47] Yann LeCun, Léon Bottou, Yoshua Bengio, and Patrick Haffner. Gradient-based learning applied to document recognition. *Proceedings of the IEEE*, 86(11):2278–2324, 1998.
- [48] Geoffrey Hinton, Li Deng, Dong Yu, George E Dahl, Abdel-rahman Mohamed, Navdeep Jaitly, Andrew Senior, Vincent Vanhoucke, Patrick Nguyen, Tara N Sainath, et al. Deep neural networks for acoustic modeling in speech recognition: The shared views of four research groups. *IEEE Signal processing magazine*, 29(6):82–97, 2012.
- [49] Alex Krizhevsky, Ilya Sutskever, and Geoffrey E Hinton. Imagenet classification with deep convolutional neural networks. *Communications of the ACM*, 60(6):84–90, 2017.
- [50] Daniel W Otter, Julian R Medina, and Jugal K Kalita. A survey of the usages of deep learning for natural language processing. *IEEE transactions on neural networks and learning systems*, 32(2):604–624, 2020.
- [51] Li Deng and John Platt. Ensemble deep learning for speech recognition. In *Proc. interspeech*, pages ,, 2014.
- [52] Qing Rao and Jelena Frtunikj. Deep learning for self-driving cars: Chances and challenges. In *Proceedings of the 1st international workshop on software engineering for AI in autonomous systems*, pages 35–38, 2018.
- [53] Andre Esteva, Alexandre Robicquet, Bharath Ramsundar, Volodymyr Kuleshov, Mark DePristo, Katherine Chou, Claire Cui, Greg Corrado, Sebastian Thrun, and Jeff Dean. A guide to deep learning in healthcare. *Nature medicine*, 25(1):24–29, 2019.
- [54] Christof Angermueller, Tanel Pärnamaa, Leopold Parts, and Oliver Stegle. Deep learning for computational biology. *Molecular systems biology*, 12(7):878, 2016.
- [55] Niels Justesen, Philip Bontrager, Julian Togelius, and Sebastian Risi. Deep learning for video game playing. *IEEE Transactions on Games*, 12(1):1–20, 2019.
- [56] Alankrita Aggarwal, Mamta Mittal, and Gopi Battineni. Generative adversarial network: An overview of theory and applications. *International Journal of Information Management Data Insights*, 1(1):100004, 2021.
- [57] Ashish Vaswani, Noam Shazeer, Niki Parmar, Jakob Uszkoreit, Llion Jones, Aidan N Gomez, Łukasz Kaiser, and Illia Polosukhin. Attention is all you need. *Advances in neural information processing systems*, 30, 2017.
- [58] Jürgen Schmidhuber. Deep learning in neural networks: An overview. *Neural networks*, 61:85–117, 2015.
- [59] Geoffrey E Hinton, Simon Osindero, and Yee-Whye Teh. A fast learning algorithm for deep belief nets. *Neural computation*, 18(7):1527–1554, 2006.
- [60] Sepp Hochreiter. The vanishing gradient problem during learning recurrent neural nets and problem solutions. *International Journal of Uncertainty, Fuzziness and Knowledge-Based Systems*, 6(02):107–116, 1998.
- [61] Kyunghyun Cho, Bart Van Merriënboer, Caglar Gulcehre, Dzmitry Bahdanau, Fethi Bougares, Holger Schwenk, and Yoshua Bengio. Learning phrase representations using rnn encoder-decoder for statistical machine translation. *arXiv preprint arXiv:1406.1078*, 2014.
- [62] Sepp Hochreiter and Jürgen Schmidhuber. Long short-term memory. *Neural computation*, 9(8):1735–1780, 1997.
- [63] Ian Goodfellow, Jean Pouget-Abadie, Mehdi Mirza, Bing Xu, David Warde-Farley, Sherjil Ozair, Aaron Courville, and Yoshua Bengio. Generative adversarial networks. *Communications of the ACM*, 63(11):139–144, 2020.
- [64] Martin Arjovsky, Soumith Chintala, and Léon Bottou. Wasserstein generative adversarial networks. In *International conference on machine learning*, pages 214–223. PMLR, 2017.

- [65] Ishaan Gulrajani, Faruk Ahmed, Martin Arjovsky, Vincent Dumoulin, and Aaron C Courville. Improved training of wasserstein gans. *Advances in neural information processing systems*, 30, 2017.
- [66] David Berthelot, Thomas Schumm, and Luke Metz. Began: Boundary equilibrium generative adversarial networks. *arXiv preprint arXiv:1703.10717*, 2017.
- [67] Deqiang He, Yefeng Qiu, Jian Miao, Zhiheng Zou, Kai Li, Chonghui Ren, and Guoqiang Shen. Improved mask r-cnn for obstacle detection of rail transit. *Measurement*, 190:110728, 2022.
- [68] Mouna Aftf, Riadh Ayachi, Yahia Said, Edwige Pissaloux, and Mohamed Atri. Indoor object classification for autonomous navigation assistance based on deep cnn model. In *2019 IEEE International Symposium on Measurements & Networking (M&N)*, pages 1–4. IEEE, 2019.
- [69] Wei Wang, Hui Lin, and Junshu Wang. Cnn based lane detection with instance segmentation in edge-cloud computing. *Journal of Cloud Computing*, 9:1–10, 2020.
- [70] Xiaomei Li, Zhijiang Xie, Xiong Deng, Yanxue Wu, and Yangjun Pi. Traffic sign detection based on improved faster r-cnn for autonomous driving. *The Journal of Supercomputing*, pages 1–21, 2022.
- [71] Alexandros Kouris and Christos-Savvas Bouganis. Learning to fly by myself: A self-supervised cnn-based approach for autonomous navigation. In *2018 IEEE/RSJ International Conference on Intelligent Robots and Systems (IROS)*, pages 1–9. IEEE, 2018.
- [72] Jian Gong, Ju Ren, and Yaoxue Zhang. Deepnav: A scalable and plug-and-play indoor navigation system based on visual cnn. *Peer-to-Peer Networking and Applications*, 14:3718–3736, 2021.
- [73] Narumol Chumuang, Adil Farooq, Muhammad Irfan, Sumair Aziz, and Moomal Qureshi. Feature matching and deep learning models for attitude estimation on a micro-aerial vehicle. In *2022 International Conference on Cybernetics and Innovations (ICCI)*, pages 1–6. IEEE, 2022.
- [74] Martin Brossard, Silvere Bonnabel, and Axel Barrau. Denoising imu gyroscopes with deep learning for open-loop attitude estimation. *IEEE Robotics and Automation Letters*, 5(3):4796–4803, 2020.
- [75] Edoardo Topini, Alberto Topini, Matteo Franchi, Alessandro Bucci, Nicola Secciani, Alessandro Ridolfi, and Benedetto Allotta. Lstm-based dead reckoning navigation for autonomous underwater vehicles. In *Global Oceans 2020: Singapore–US Gulf Coast*, pages 1–7. IEEE, 2020.
- [76] Qianqian Tong, Xiaosa Li, Kai Lin, Caizi Li, Weixin Si, and Zhiyong Yuan. Cascade-lstm-based visual-inertial navigation for magnetic levitation haptic interaction. *IEEE Network*, 33(3):74–80, 2019.
- [77] Heming Du, Xin Yu, and Liang Zheng. Vtnet: Visual transformer network for object goal navigation. *arXiv preprint arXiv:2105.09447*, 2021.
- [78] Cunjun Yu, Xiao Ma, Jiawei Ren, Haiyu Zhao, and Shuai Yi. Spatio-temporal graph transformer networks for pedestrian trajectory prediction. In *Computer Vision—ECCV 2020: 16th European Conference, Glasgow, UK, August 23–28, 2020, Proceedings, Part XII 16*, pages 507–523. Springer, 2020.
- [79] Debaditya Roy, Tetsuhiro Ishizaka, C Krishna Mohan, and Atsushi Fukuda. Vehicle trajectory prediction at intersections using interaction based generative adversarial networks. In *2019 IEEE Intelligent transportation systems conference (ITSC)*, pages 2318–2323. IEEE, 2019.
- [80] George Dimas, Charis Ntakolia, and Dimitris K Iakovidis. Obstacle detection based on generative adversarial networks and fuzzy sets for computer-assisted navigation. In *Engineering Applications of Neural Networks: 20th International Conference, EANN 2019, Xersonisos, Crete, Greece, May 24-26, 2019, Proceedings 20*, pages 533–544. Springer, 2019.
- [81] Mehdi Mohammadi, Ala Al-Fuqaha, and Jun-Seok Oh. Path planning in support of smart mobility applications using generative adversarial networks. In *2018 IEEE International Conference on Internet of Things (iThings) and IEEE Green Computing and Communications (GreenCom) and IEEE Cyber, Physical and Social Computing (CPSCom) and IEEE Smart Data (SmartData)*, pages 878–885. IEEE, 2018.
- [82] Kunihiko Fukushima. Cognitron: A self-organizing multilayered neural network. *Biological cybernetics*, 20(3-4):121–136, 1975.
- [83] Andrew L Maas, Awni Y Hannun, Andrew Y Ng, et al. Rectifier nonlinearities improve neural network acoustic models. In *Proc. icml*, volume 30, page 3. Atlanta, Georgia, USA, 2013.
- [84] Djork-Arné Clevert, Thomas Unterthiner, and Sepp Hochreiter. Fast and accurate deep network learning by exponential linear units (elus). *arXiv preprint arXiv:1511.07289*, 2015.
- [85] John S Bridle. Probabilistic interpretation of feedforward classification network outputs, with relationships to statistical pattern recognition. In *Neurocomputing: Algorithms, architectures and applications*, pages 227–236. Springer, 1990.

- [86] John Bridle. Training stochastic model recognition algorithms as networks can lead to maximum mutual information estimation of parameters. *Advances in neural information processing systems*, 2, 1989.
- [87] Charles Dugas, Yoshua Bengio, François Bélisle, Claude Nadeau, and René Garcia. Incorporating second-order functional knowledge for better option pricing. *Advances in neural information processing systems*, 13, 2000.
- [88] Prajit Ramachandran, Barret Zoph, and Quoc V Le. Searching for activation functions. *arXiv preprint arXiv:1710.05941*, 2017.
- [89] Bing Xu, Naiyan Wang, Tianqi Chen, and Mu Li. Empirical evaluation of rectified activations in convolutional network. *arXiv preprint arXiv:1505.00853*, 2015.
- [90] Diganta Misra. Mish: A self regularized non-monotonic neural activation function. *arXiv preprint arXiv:1908.08681*, 4(2):10–48550, 2019.
- [91] Vinod Nair and Geoffrey E Hinton. Rectified linear units improve restricted boltzmann machines. In *Proceedings of the 27th international conference on machine learning (ICML-10)*, pages 807–814, 2010.
- [92] Kaiming He, Xiangyu Zhang, Shaoqing Ren, and Jian Sun. Delving deep into rectifiers: Surpassing human-level performance on imagenet classification. In *Proceedings of the IEEE international conference on computer vision*, pages 1026–1034, 2015.
- [93] Dan Hendrycks and Kevin Gimpel. A baseline for detecting misclassified and out-of-distribution examples in neural networks. *arXiv preprint arXiv:1610.02136*, 2016.
- [94] Günter Klambauer, Thomas Unterthiner, Andreas Mayr, and Sepp Hochreiter. Self-normalizing neural networks. *Advances in neural information processing systems*, 30, 2017.
- [95] Swalpa Kumar Roy, Suvojit Manna, Shiv Ram Dubey, and Bidyut Baran Chaudhuri. Lisht: Non-parametric linearly scaled hyperbolic tangent activation function for neural networks. *arXiv preprint arXiv:1901.05894*, 2019.
- [96] Liu Ziyin, Tilman Hartwig, and Masahito Ueda. Neural networks fail to learn periodic functions and how to fix it. *Advances in Neural Information Processing Systems*, 33:1583–1594, 2020.
- [97] Zhenming Hu, Weibo Fang, Tong Gou, Wenshuai Wu, Jiumei Hu, Shufang Zhou, and Ying Mu. A novel method based on a mask r-cnn model for processing dpcr images. *Analytical Methods*, 11(27):3410–3418, 2019.
- [98] T Matsumoto, T Yokohama, H Suzuki, R Furukawa, A Oshimoto, T Shimmi, Y Matsushita, T Seo, and LO Chua. Several image processing examples by cnn. In *IEEE International Workshop on Cellular Neural Networks and their Applications*, pages 100–111. IEEE, 1990.
- [99] Paolo Arena, Adriano Basile, Maide Bucolo, and Luigi Fortuna. Image processing for medical diagnosis using cnn. *Nuclear Instruments and Methods in Physics Research Section A: Accelerators, Spectrometers, Detectors and Associated Equipment*, 497(1):174–178, 2003.
- [100] Jin Tian, Jiazheng Yuan, and Hongzhe Liu. Road marking detection based on mask r-cnn instance segmentation model. In *2020 international conference on computer vision, image and deep learning (CVIDL)*, pages 246–249. IEEE, 2020.
- [101] Aklima Akter Lima, Md Mohsin Kabir, Sujoy Chandra Das, Md Nahid Hasan, and MF Mridha. Road sign detection using variants of yolo and r-cnn: An analysis from the perspective of bangladesh. In *Proceedings of the International Conference on Big Data, IoT, and Machine Learning: BIM 2021*, pages 555–565. Springer, 2022.
- [102] Gowdham Prabhakar, Binsu Kailath, Sudha Natarajan, and Rajesh Kumar. Obstacle detection and classification using deep learning for tracking in high-speed autonomous driving. In *2017 IEEE region 10 symposium (TENSymp)*, pages 1–6. IEEE, 2017.
- [103] Chaowei Hu, Yunpeng Wang, Guizhen Yu, Zhangyu Wang, Ao Lei, and Zhehua Hu. Embedding cnn-based fast obstacles detection for autonomous vehicles. Technical report, SAE Technical Paper, 2018.
- [104] Lorenzo Lamberti, Luca Bompani, Victor Javier Kartsch, Manuele Rusci, Daniele Palossi, and Luca Benini. Bio-inspired autonomous exploration policies with cnn-based object detection on nano-drones. *arXiv preprint arXiv:2301.12175*, 2023.
- [105] Alexander Shustanov and Pavel Yakimov. Cnn design for real-time traffic sign recognition. *Procedia engineering*, 201:718–725, 2017.
- [106] Christine Dewi, Rung-Ching Chen, Xiaoyi Jiang, and Hui Yu. Deep convolutional neural network for enhancing traffic sign recognition developed on yolo v4. *Multimedia Tools and Applications*, 81(26):37821–37845, 2022.
- [107] Shahrokh Paravarzar and Belqes Mohammad. Motion prediction on self-driving cars: A review. *arXiv preprint arXiv:2011.03635*, 2020.

- [108] Jamil Fayyad, Mohammad A Jaradat, Dominique Gruyer, and Homayoun Najjaran. Deep learning sensor fusion for autonomous vehicle perception and localization: A review. *Sensors*, 20(15):4220, 2020.
- [109] Jennifer Shuttleworth. Sae standards news: J3016 automated-driving graphic update. *SAE International*, 2019.
- [110] Roger Clarke. Understanding the drone epidemic. *Computer Law & Security Review*, 30(3):230–246, 2014.
- [111] Rico Merkert and James Bushell. Revolution or epidemic? a systematic literature review on the effective control of airborne drones. 2020.
- [112] Panagiotis Radoglou-Grammatikis, Panagiotis Sarigiannidis, Thomas Lagkas, and Ioannis Moscholios. A compilation of uav applications for precision agriculture. *Computer Networks*, 172:107148, 2020.
- [113] Bander Alzahrani, Omar Sami Oubbati, Ahmed Barnawi, Mohammed Atiquzzaman, and Daniyal Alghazzawi. Uav assistance paradigm: State-of-the-art in applications and challenges. *Journal of Network and Computer Applications*, 166:102706, 2020.
- [114] Amazon. Mk4, amazon prime air drone, 2022.
- [115] Syed Agha Hassnain Mohsan, Muhammad Asghar Khan, Fazal Noor, Insaf Ullah, and Mohammed H Alsharif. Towards the unmanned aerial vehicles (uavs): A comprehensive review. *Drones*, 6(6):147, 2022.
- [116] Sifat Rezwani and Wooyeol Choi. Artificial intelligence approaches for uav navigation: Recent advances and future challenges. *IEEE Access*, 2022.
- [117] Pedro F Proença and Yang Gao. Deep learning for spacecraft pose estimation from photorealistic rendering. In *2020 IEEE International Conference on Robotics and Automation (ICRA)*, pages 6007–6013. IEEE, 2020.
- [118] Tae Ha Park and Simone D’Amico. Robust multi-task learning and online refinement for spacecraft pose estimation across domain gap. *arXiv preprint arXiv:2203.04275*, 2022.
- [119] Rogerio R Santos, Domingos A Rade, and Ijar M da Fonseca. A machine learning strategy for optimal path planning of space robotic manipulator in on-orbit servicing. *Acta Astronautica*, 191:41–54, 2022.
- [120] Thomas Uriot, Dario Izzo, Luís F Simões, Rasit Abay, Nils Einecke, Sven Rebhan, Jose Martinez-Heras, Francesca Letizia, Jan Siminski, and Klaus Merz. Spacecraft collision avoidance challenge: Design and results of a machine learning competition. *Astrodynamics*, 6(2):121–140, 2022.
- [121] Zibin Sun, Jules Simo, and Shengping Gong. Satellite attitude identification and prediction based on neural network compensation. *Space: Science & Technology*, 2023.
- [122] Nathan Stacey and Simone D’Amico. Robust autonomous spacecraft navigation and environment characterization. *Authorea Preprints*, 2022.
- [123] Tae Ha Park and Simone D’Amico. Adaptive neural network-based unscented kalman filter for spacecraft pose tracking at rendezvous. *arXiv preprint arXiv:2206.03796*, 2022.
- [124] Brian Gaudet, Richard Linares, and Roberto Furfaro. Deep reinforcement learning for six degree-of-freedom planetary landing. *Advances in Space Research*, 65(7):1723–1741, 2020.
- [125] Roberto Furfaro, Ilaria Bloise, Marcello Orlandelli, Pierluigi Di Lizia, Francesco Topputo, Richard Linares, et al. Deep learning for autonomous lunar landing. *Advances in the Astronautical Sciences*, 167:3285–3306, 2018.
- [126] Lena M Downes, Ted J Steiner, and Jonathan P How. Neural network approach to crater detection for lunar terrain relative navigation. *Journal of Aerospace Information Systems*, 18(7):391–403, 2021.
- [127] Lena Downes, Ted J Steiner, and Jonathan P How. Deep learning crater detection for lunar terrain relative navigation. In *AIAA SciTech 2020 Forum*, page 1838, 2020.
- [128] Hiroyasu Tsukamoto, Soon-Jo Chung, Benjamin Donitz, Michel Ingham, Declan Mages, and Yashwanth Kumar Nakka. Neural-rendezvous: Learning-based robust guidance and control to encounter interstellar objects. *arXiv preprint arXiv:2208.04883*, 2022.
- [129] Benjamin PS Donitz, Declan Mages, Hiroyasu Tsukamoto, Peter Dixon, Damon Landau, Soon-Jo Chung, Erica Bufanda, Michel Ingham, and Julie Castillo-Rogez. Interstellar object accessibility and mission design. *arXiv preprint arXiv:2210.14980*, 2022.
- [130] Daniel Neamati, Yashwanth Kumar K Nakka, and Soon-Jo Chung. Learning-based methods to model small body gravity fields for proximity operations: Safety and robustness. In *AIAA SCITECH 2022 Forum*, page 2271, 2022.
- [131] Yashwanth Kumar Nakka. *Spacecraft Motion Planning and Control under Probabilistic Uncertainty for Coordinated Inspection and Safe Learning*. PhD thesis, California Institute of Technology, 2021.
- [132] Rahul Moghe and Renato Zanetti. On-line hazard detection algorithm for precision lunar landing using semantic segmentation. In *AIAA Scitech 2020 Forum*, page 0462, 2020.

- [133] Andrea Scorsoglio, Roberto Furfaro, Richard Linares, and Mauro Massari. Relative motion guidance for near-rectilinear lunar orbits with path constraints via actor-critic reinforcement learning. *Advances in Space Research*, 71(1):316–335, 2023.
- [134] Ben Guthrie, Minkwan Kim, Hodei Urrutxua, and Jonathon Hare. Image-based attitude determination of co-orbiting satellites using deep learning technologies. *Aerospace Science and Technology*, 120:107232, 2022.
- [135] Abd-Elsalam R Abd-Elhay, Wael A Murtada, and Mohamed I Youssef. A reliable deep learning approach for time-varying faults identification: Spacecraft reaction wheel case study. *IEEE Access*, 10:75495–75512, 2022.
- [136] Sotirios T Spantideas, Anastasios E Giannopoulos, Nikolaos C Kapsalis, and Christos N Capsalis. A deep learning method for modeling the magnetic signature of spacecraft equipment using multiple magnetic dipoles. *IEEE Magnetics Letters*, 12:1–5, 2021.
- [137] Nouar AlDahoul, Hezerul Abdul Karim, and Mhd Adel Momo. Rgb-d based multi-modal deep learning for spacecraft and debris recognition. *Scientific Reports*, 12(1):3924, 2022.
- [138] Andrew Harris, Trace Valade, Thibaud Teil, and Hanspeter Schaub. Generation of spacecraft operations procedures using deep reinforcement learning. *Journal of Spacecraft and Rockets*, 59(2):611–626, 2022.
- [139] Roberto Del Prete, Alfonso Saveriano, and Alfredo Renga. A deep learning-based crater detector for autonomous vision-based spacecraft navigation. In *2022 IEEE 9th International Workshop on Metrology for AeroSpace (MetroAeroSpace)*, pages 231–236. IEEE, 2022.
- [140] Peng Mun Siew, Daniel Jang, Thomas G Roberts, and Richard Linares. Space-based sensor tasking using deep reinforcement learning. *The Journal of the Astronautical Sciences*, pages 1–38, 2022.
- [141] Peng Mun Siew and Richard Linares. Optimal tasking of ground-based sensors for space situational awareness using deep reinforcement learning. *Sensors*, 22(20):7847, 2022.
- [142] Charles E Oestreich, Richard Linares, and Ravi Gondhalekar. Autonomous six-degree-of-freedom spacecraft docking with rotating targets via reinforcement learning. *Journal of Aerospace Information Systems*, 18(7):417–428, 2021.
- [143] Trupti Mahendrakar, Ryan T White, Markus Wilde, and Madhur Tiwari. Spaceyolo: A human-inspired model for real-time, on-board spacecraft feature detection. *arXiv preprint arXiv:2302.00824*, 2023.
- [144] Tae Ha Park, Sumant Sharma, and Simone D’Amico. Towards robust learning-based pose estimation of noncooperative spacecraft. *arXiv preprint arXiv:1909.00392*, 2019.
- [145] Bo Chen, Jiewei Cao, Alvaro Parra, and Tat-Jun Chin. Satellite pose estimation with deep landmark regression and nonlinear pose refinement. In *Proceedings of the IEEE/CVF International Conference on Computer Vision Workshops*, pages 0–0, 2019.
- [146] Andrea Scorsoglio, Andrea D’Ambrosio, Luca Ghilardi, Roberto Furfaro, Brian Gaudet, Richard Linares, and Fabio Curti. Safe lunar landing via images: A reinforcement meta-learning application to autonomous hazard avoidance and landing. In *Proceedings of the 2020 AAS/AIAA Astrodynamics Specialist Conference, Virtual*, pages 9–12, 2020.
- [147] J Elkins, R Sood, and C Rumpf. Autonomous spacecraft attitude control using deep reinforcement learning. In *71st International Astronautical Congress (IAC)*, volume 2020, 2020.
- [148] Sandeep K Singh and John L Junkins. Stochastic learning and extremal-field map based autonomous guidance of low-thrust spacecraft. *Scientific Reports*, 12(1):17774, 2022.
- [149] Zhou Hao, RB Ashith Shyam, Arunkumar Rathinam, and Yang Gao. Intelligent spacecraft visual gnc architecture with the state-of-the-art ai components for on-orbit manipulation. *Frontiers in Robotics and AI*, 8:639327, 2021.
- [150] Kyongsik Yun, Changrak Choi, Ryan Alimo, Anthony Davis, Linda Forster, Amir Rahmani, Muhammad Adil, and Ramtin Madani. Multi-agent motion planning using deep learning for space applications. In *ASCEND 2020*, page 4233. 2020.
- [151] Dong Zhou, Gunaghui Sun, and Xiaopeng Hong. 3d visual tracking framework with deep learning for asteroid exploration. *arXiv preprint arXiv:2111.10737*, 2021.
- [152] Wenxiu Huan, Mingmin Liu, and Qinglei Hu. Pose estimation for non-cooperative spacecraft based on deep learning. In *2020 39th Chinese Control Conference (CCC)*, pages 3339–3343. IEEE, 2020.
- [153] Thomas G Roberts, Peng Mun Siew, Daniel Jang, and Richard Linares. A deep reinforcement learning application to space-based sensor tasking for space situational awareness. In *Proceedings of the 2021 Advanced Maui Optical and Space Surveillance Technologies Conference (AMOS), Wailea Beach Resort, Maui, HI, USA*, pages 14–17, 2021.

- [154] Thomas G Roberts and Richard Linares. Geosynchronous satellite maneuver classification via supervised machine learning. In *Advanced Maui Optical and Space Surveillance Technologies Conference*. Maui, Hawaii, 2021.
- [155] Yuan Liu, Ming Zhu, Jing Wang, Xiangji Guo, Yifan Yang, and Jiarong Wang. Multi-scale deep neural network based on dilated convolution for spacecraft image segmentation. *Sensors*, 22(11):4222, 2022.
- [156] Duarte Rondao, Nabil Aouf, and Mark A Richardson. Chinet: Deep recurrent convolutional learning for multimodal spacecraft pose estimation. *IEEE Transactions on Aerospace and Electronic Systems*, 2022.
- [157] Liang Liu, Ling Tian, Zhao Kang, and Tianqi Wan. Spacecraft anomaly detection with attention temporal convolution networks. *Neural Computing and Applications*, pages 1–9, 2023.
- [158] Changhui Jiang, Shuai Chen, Yuwei Chen, Boya Zhang, Ziyi Feng, Hui Zhou, and Yuming Bo. A mems imu de-noising method using long short term memory recurrent neural networks (lstm-rnn). *Sensors*, 18(10):3470, 2018.
- [159] Shipeng Han, Zhen Meng, Xingcheng Zhang, and Yuepeng Yan. Hybrid deep recurrent neural networks for noise reduction of mems-imu with static and dynamic conditions. *Micromachines*, 12(2):214, 2021.
- [160] Hua Chen, Tarek M Taha, and Vamsy P Chodavarapu. Towards improved inertial navigation by reducing errors using deep learning methodology. *Applied Sciences*, 12(7):3645, 2022.
- [161] Daniel Engelsman and Itzik Klein. Data-driven denoising of accelerometer signals. *arXiv preprint arXiv:2206.05937*, 2022.
- [162] Sebastian Thrun. Probabilistic robotics. *Communications of the ACM*, 45(3):52–57, 2002.
- [163] Andreas Geiger, Philip Lenz, and Raquel Urtasun. Are we ready for autonomous driving? the kitti vision benchmark suite. In *2012 IEEE conference on computer vision and pattern recognition*, pages 3354–3361. IEEE, 2012.
- [164] Michael Burri, Janosch Nikolic, Pascal Gohl, Thomas Schneider, Joern Rehder, Sammy Omari, Markus W Achtelik, and Roland Siegwart. The euroc micro aerial vehicle datasets. *The International Journal of Robotics Research*, 35(10):1157–1163, 2016.
- [165] Nicholas Carlevaris-Bianco, Arash K Ushani, and Ryan M Eustice. University of michigan north campus long-term vision and lidar dataset. *The International Journal of Robotics Research*, 35(9):1023–1035, 2016.
- [166] Shuran Song, Samuel P Lichtenberg, and Jianxiong Xiao. Sun rgb-d: A rgb-d scene understanding benchmark suite. In *Proceedings of the IEEE conference on computer vision and pattern recognition*, pages 567–576, 2015.
- [167] Marius Cordts, Mohamed Omran, Sebastian Ramos, Timo Rehfeld, Markus Enzweiler, Rodrigo Benenson, Uwe Franke, Stefan Roth, and Bernt Schiele. The cityscapes dataset for semantic urban scene understanding. In *Proceedings of the IEEE conference on computer vision and pattern recognition*, pages 3213–3223, 2016.
- [168] Morten Bornø Jensen, Mark Philip Philipsen, Andreas Møgelmoose, Thomas Baltzer Moeslund, and Mohan Manubhai Trivedi. Vision for looking at traffic lights: Issues, survey, and perspectives. *IEEE Transactions on Intelligent Transportation Systems*, 17(7):1800–1815, 2016.
- [169] Alexandre Robicquet, Amir Sadeghian, Alexandre Alahi, and Silvio Savarese. Learning social etiquette: Human trajectory prediction. In *European Conference on Computer Vision (ECCV)*, volume 3, 2016.
- [170] Matthias Mueller, Neil Smith, and Bernard Ghanem. A benchmark and simulator for uav tracking. In *Computer Vision–ECCV 2016: 14th European Conference, Amsterdam, The Netherlands, October 11–14, 2016, Proceedings, Part I 14*, pages 445–461. Springer, 2016.
- [171] András L Majdik, Charles Till, and Davide Scaramuzza. The zurich urban micro aerial vehicle dataset. *The International Journal of Robotics Research*, 36(3):269–273, 2017.
- [172] Will Maddern, Geoffrey Pascoe, Chris Linegar, and Paul Newman. 1 year, 1000 km: The oxford robotcar dataset. *The International Journal of Robotics Research*, 36(1):3–15, 2017.
- [173] Federico Perazzi, Jordi Pont-Tuset, Brian McWilliams, Luc Van Gool, Markus Gross, and Alexander Sorkine-Hornung. A benchmark dataset and evaluation methodology for video object segmentation. In *Proceedings of the IEEE conference on computer vision and pattern recognition*, pages 724–732, 2016.
- [174] Fisher Yu, Haofeng Chen, Xin Wang, Wenqi Xian, Yingying Chen, Fangchen Liu, Vashisht Madhavan, and Trevor Darrell. Bdd100k: A diverse driving dataset for heterogeneous multitask learning. In *Proceedings of the IEEE/CVF conference on computer vision and pattern recognition*, pages 2636–2645, 2020.

- [175] Xinyu Huang, Xinjing Cheng, Qichuan Geng, Binbin Cao, Dingfu Zhou, Peng Wang, Yuanqing Lin, and Ruigang Yang. The apolloscape dataset for autonomous driving. In *Proceedings of the IEEE conference on computer vision and pattern recognition workshops*, pages 954–960, 2018.
- [176] Ke Sun, Kartik Mohta, Bernd Pfrommer, Michael Watterson, Sikang Liu, Yash Mulgaonkar, Camillo J Taylor, and Vijay Kumar. Robust stereo visual inertial odometry for fast autonomous flight. *IEEE Robotics and Automation Letters*, 3(2):965–972, 2018.
- [177] Angela Dai, Angel X Chang, Manolis Savva, Maciej Halber, Thomas Funkhouser, and Matthias Nießner. Scannet: Richly-annotated 3d reconstructions of indoor scenes. In *Proceedings of the IEEE conference on computer vision and pattern recognition*, pages 5828–5839, 2017.
- [178] Yukyung Choi, Namil Kim, Soonmin Hwang, Kibaek Park, Jae Shin Yoon, Kyoungwan An, and In So Kweon. Kaist multi-spectral day/night data set for autonomous and assisted driving. *IEEE Transactions on Intelligent Transportation Systems*, 19(3):934–948, 2018.
- [179] Jeffrey Delmerico, Titus Cieslewski, Henri Rebecq, Matthias Faessler, and Davide Scaramuzza. Are we ready for autonomous drone racing? the UZH-FPV drone racing dataset. In *IEEE Int. Conf. Robot. Autom. (ICRA)*, 2019.
- [180] Ming-Fang Chang, John Lambert, Patsorn Sangkloy, Jagjeet Singh, Slawomir Bak, Andrew Hartnett, De Wang, Peter Carr, Simon Lucey, Deva Ramanan, et al. Argoverse: 3d tracking and forecasting with rich maps. In *Proceedings of the IEEE/CVF conference on computer vision and pattern recognition*, pages 8748–8757, 2019.
- [181] Abhishek Patil, Srikanth Malla, Haiming Gang, and Yi-Ting Chen. The h3d dataset for full-surround 3d multi-object detection and tracking in crowded urban scenes. In *2019 International Conference on Robotics and Automation (ICRA)*, pages 9552–9557. IEEE, 2019.
- [182] R Kesten, M Usman, J Houston, T Pandya, K Nadhamuni, A Ferreira, M Yuan, B Low, A Jain, P Ondruska, et al. Lyft level 5 av dataset 2019. [urlhttps://level5.lyft.com/dataset](https://level5.lyft.com/dataset), 1:3, 2019.
- [183] Jakob Geyer, Yohannes Kassahun, Mentar Mahmudi, Xavier Ricou, Rupesh Durgesh, Andrew S Chung, Lorenz Hauswald, Viet Hoang Pham, Maximilian Mühlegg, Sebastian Dorn, et al. A2d2: Audi autonomous driving dataset. *arXiv preprint arXiv:2004.06320*, 2020.
- [184] Quang-Hieu Pham, Pierre Sevestre, Ramanpreet Singh Pahwa, Huijing Zhan, Chun Ho Pang, Yuda Chen, Armin Mustafa, Vijay Chandrasekhar, and Jie Lin. A 3d dataset: Towards autonomous driving in challenging environments. In *2020 IEEE International Conference on Robotics and Automation (ICRA)*, pages 2267–2273. IEEE, 2020.
- [185] Jean-Emmanuel Deschaud. Kitti-carla: a kitti-like dataset generated by carla simulator. *arXiv preprint arXiv:2109.00892*, 2021.
- [186] Holger Caesar, Varun Bankiti, Alex H Lang, Sourabh Vora, Venice Erin Liong, Qiang Xu, Anush Krishnan, Yu Pan, Giancarlo Baldan, and Oscar Beijbom. nuscenes: A multimodal dataset for autonomous driving. In *Proceedings of the IEEE/CVF conference on computer vision and pattern recognition*, pages 11621–11631, 2020.
- [187] Pei Sun, Henrik Kretschmar, Xerxes Dotiwalla, Aurelien Chouard, Vijaysai Patnaik, Paul Tsui, James Guo, Yin Zhou, Yuning Chai, Benjamin Caine, et al. Scalability in perception for autonomous driving: Waymo open dataset. In *Proceedings of the IEEE/CVF conference on computer vision and pattern recognition*, pages 2446–2454, 2020.
- [188] Amado Antonini, Winter Guerra, Varun Murali, Thomas Sayre-McCord, and Sertac Karaman. The blackbird uav dataset. *The International Journal of Robotics Research*, 39(10-11):1346–1364, 2020.
- [189] Pengfei Zhu, Longyin Wen, Dawei Du, Xiao Bian, Heng Fan, Qinghua Hu, and Haibin Ling. Detection and tracking meet drones challenge. *IEEE Transactions on Pattern Analysis and Machine Intelligence*, 44(11):7380–7399, 2021.
- [190] Tianyang Chen, Fangling Pu, Hongjia Chen, and Zhihong Liu. Whuvid: A large-scale stereo-imu dataset for visual-inertial odometry and autonomous driving in chinese urban scenarios. *Remote Sensing*, 14(9):2033, 2022.
- [191] Yingxiu Chang, Yongqiang Cheng, John Murray, Shi Huang, and Guangyi Shi. The hdn dataset: A real-world indoor uav dataset with multi-task labels for visual-based navigation. *Drones*, 6(8):202, 2022.
- [192] Zhengxia Zou, Keyan Chen, Zhenwei Shi, Yuhong Guo, and Jieping Ye. Object detection in 20 years: A survey. *Proceedings of the IEEE*, 2023.
- [193] Paul Viola and Michael J Jones. Robust real-time face detection. *International journal of computer vision*, 57:137–154, 2004.

- [194] Navneet Dalal and Bill Triggs. Histograms of oriented gradients for human detection. In *2005 IEEE computer society conference on computer vision and pattern recognition (CVPR'05)*, volume 1, pages 886–893. Ieee, 2005.
- [195] Pedro Felzenszwalb, David McAllester, and Deva Ramanan. A discriminatively trained, multiscale, deformable part model. In *2008 IEEE conference on computer vision and pattern recognition*, pages 1–8. Ieee, 2008.
- [196] Ross Girshick, Jeff Donahue, Trevor Darrell, and Jitendra Malik. Rich feature hierarchies for accurate object detection and semantic segmentation. In *Proceedings of the IEEE conference on computer vision and pattern recognition*, pages 580–587, 2014.
- [197] Kaiming He, Xiangyu Zhang, Shaoqing Ren, and Jian Sun. Spatial pyramid pooling in deep convolutional networks for visual recognition. *IEEE transactions on pattern analysis and machine intelligence*, 37(9):1904–1916, 2015.
- [198] Ross Girshick. Fast r-cnn. In *Proceedings of the IEEE international conference on computer vision*, pages 1440–1448, 2015.
- [199] Shaoqing Ren, Kaiming He, Ross Girshick, and Jian Sun. Faster r-cnn: Towards real-time object detection with region proposal networks. *Advances in neural information processing systems*, 28, 2015.
- [200] Joseph Redmon, Santosh Divvala, Ross Girshick, and Ali Farhadi. You only look once: Unified, real-time object detection. In *Proceedings of the IEEE conference on computer vision and pattern recognition*, pages 779–788, 2016.
- [201] Joseph Redmon and Ali Farhadi. Yolo9000: better, faster, stronger. In *Proceedings of the IEEE conference on computer vision and pattern recognition*, pages 7263–7271, 2017.
- [202] Joseph Redmon and Ali Farhadi. Yolov3: An incremental improvement. *arXiv preprint arXiv:1804.02767*, 2018.
- [203] Alexey Bochkovskiy, Chien-Yao Wang, and Hong-Yuan Mark Liao. Yolov4: Optimal speed and accuracy of object detection. *arXiv preprint arXiv:2004.10934*, 2020.
- [204] Wei Liu, Dragomir Anguelov, Dumitru Erhan, Christian Szegedy, Scott Reed, Cheng-Yang Fu, and Alexander C Berg. Ssd: Single shot multibox detector. In *Computer Vision–ECCV 2016: 14th European Conference, Amsterdam, The Netherlands, October 11–14, 2016, Proceedings, Part I 14*, pages 21–37. Springer, 2016.
- [205] Tsung-Yi Lin, Piotr Dollár, Ross Girshick, Kaiming He, Bharath Hariharan, and Serge Belongie. Feature pyramid networks for object detection. In *Proceedings of the IEEE conference on computer vision and pattern recognition*, pages 2117–2125, 2017.
- [206] Tsung-Yi Lin, Priya Goyal, Ross Girshick, Kaiming He, and Piotr Dollár. Focal loss for dense object detection. In *Proceedings of the IEEE international conference on computer vision*, pages 2980–2988, 2017.
- [207] Hei Law and Jia Deng. Cornernet: Detecting objects as paired keypoints. In *Proceedings of the European conference on computer vision (ECCV)*, pages 734–750, 2018.
- [208] Xingyi Zhou, Dequan Wang, and Philipp Krähenbühl. Objects as points. *arXiv preprint arXiv:1904.07850*, 2019.
- [209] Nicolas Carion, Francisco Massa, Gabriel Synnaeve, Nicolas Usunier, Alexander Kirillov, and Sergey Zagoruyko. End-to-end object detection with transformers. In *Computer Vision–ECCV 2020: 16th European Conference, Glasgow, UK, August 23–28, 2020, Proceedings, Part I 16*, pages 213–229. Springer, 2020.
- [210] Zhaowei Cai and Nuno Vasconcelos. Cascade r-cnn: Delving into high quality object detection. In *Proceedings of the IEEE conference on computer vision and pattern recognition*, pages 6154–6162, 2018.
- [211] Mingxing Tan, Ruoming Pang, and Quoc V Le. Efficientdet: Scalable and efficient object detection. In *Proceedings of the IEEE/CVF conference on computer vision and pattern recognition*, pages 10781–10790, 2020.
- [212] Peize Sun, Rufeng Zhang, Yi Jiang, Tao Kong, Chenfeng Xu, Wei Zhan, Masayoshi Tomizuka, Lei Li, Zehuan Yuan, Changhu Wang, et al. Sparse r-cnn: End-to-end object detection with learnable proposals. In *Proceedings of the IEEE/CVF conference on computer vision and pattern recognition*, pages 14454–14463, 2021.
- [213] Ze Yang, Shaohui Liu, Han Hu, Liwei Wang, and Stephen Lin. Reppoints: Point set representation for object detection. In *Proceedings of the IEEE/CVF international conference on computer vision*, pages 9657–9666, 2019.
- [214] Zhi Tian, Chunhua Shen, Hao Chen, and Tong He. Fcos: Fully convolutional one-stage object detection. In *Proceedings of the IEEE/CVF international conference on computer vision*, pages 9627–9636, 2019.
- [215] Tsung-Yi Lin, Michael Maire, Serge Belongie, James Hays, Pietro Perona, Deva Ramanan, Piotr Dollár, and C Lawrence Zitnick. Microsoft coco: Common objects in context. In *Computer Vision–ECCV 2014: 13th European Conference, Zurich, Switzerland, September 6-12, 2014, Proceedings, Part V 13*, pages 740–755. Springer, 2014.

- [216] Fei-Fei Li, Justin Johnson, and Serena Yeung. Lecture 11: Detection and segmentation, 2017.
- [217] Jonathan Long, Evan Shelhamer, and Trevor Darrell. Fully convolutional networks for semantic segmentation. In *Proceedings of the IEEE conference on computer vision and pattern recognition*, pages 3431–3440, 2015.
- [218] Olaf Ronneberger, Philipp Fischer, and Thomas Brox. U-net: Convolutional networks for biomedical image segmentation. In *Medical Image Computing and Computer-Assisted Intervention–MICCAI 2015: 18th International Conference, Munich, Germany, October 5-9, 2015, Proceedings, Part III 18*, pages 234–241. Springer, 2015.
- [219] Vijay Badrinarayanan, Alex Kendall, and Roberto Cipolla. Segnet: A deep convolutional encoder-decoder architecture for image segmentation. *IEEE transactions on pattern analysis and machine intelligence*, 39(12):2481–2495, 2017.
- [220] Liang-Chieh Chen, George Papandreou, Iasonas Kokkinos, Kevin Murphy, and Alan L Yuille. Deeplab: Semantic image segmentation with deep convolutional nets, atrous convolution, and fully connected crfs. *IEEE transactions on pattern analysis and machine intelligence*, 40(4):834–848, 2017.
- [221] Hengshuang Zhao, Jianping Shi, Xiaojuan Qi, Xiaogang Wang, and Jiaya Jia. Pyramid scene parsing network. In *Proceedings of the IEEE conference on computer vision and pattern recognition*, pages 2881–2890, 2017.
- [222] Hengshuang Zhao, Xiaojuan Qi, Xiaoyong Shen, Jianping Shi, and Jiaya Jia. Icnet for real-time semantic segmentation on high-resolution images. In *Proceedings of the European conference on computer vision (ECCV)*, pages 405–420, 2018.
- [223] Adam Paszke, Abhishek Chaurasia, Sangpil Kim, and Eugenio Culurciello. Enet: A deep neural network architecture for real-time semantic segmentation. *arXiv preprint arXiv:1606.02147*, 2016.
- [224] Liang-Chieh Chen, George Papandreou, Florian Schroff, and Hartwig Adam. Rethinking atrous convolution for semantic image segmentation. *arXiv preprint arXiv:1706.05587*, 2017.
- [225] Jingdong Wang, Ke Sun, Tianheng Cheng, Borui Jiang, Chaorui Deng, Yang Zhao, Dong Liu, Yadong Mu, Mingkui Tan, Xinggang Wang, et al. Deep high-resolution representation learning for visual recognition. *IEEE transactions on pattern analysis and machine intelligence*, 43(10):3349–3364, 2020.
- [226] Kaiming He, Georgia Gkioxari, Piotr Dollár, and Ross Girshick. Mask r-cnn. In *Proceedings of the IEEE international conference on computer vision*, pages 2961–2969, 2017.
- [227] Abhishek Chaurasia and Eugenio Culurciello. Linknet: Exploiting encoder representations for efficient semantic segmentation. In *2017 IEEE visual communications and image processing (VCIP)*, pages 1–4. IEEE, 2017.
- [228] Guosheng Lin, Anton Milan, Chunhua Shen, and Ian Reid. Refinenet: Multi-path refinement networks for high-resolution semantic segmentation. In *Proceedings of the IEEE conference on computer vision and pattern recognition*, pages 1925–1934, 2017.
- [229] Changqian Yu, Jingbo Wang, Chao Peng, Changxin Gao, Gang Yu, and Nong Sang. Bisenet: Bilateral segmentation network for real-time semantic segmentation. In *Proceedings of the European conference on computer vision (ECCV)*, pages 325–341, 2018.
- [230] Trupti Mahendrakar, Andrew Ekblad, Nathan Fischer, Ryan White, Markus Wilde, Brian Kish, and Isaac Silver. Performance study of yolov5 and faster r-cnn for autonomous navigation around non-cooperative targets. In *2022 IEEE Aerospace Conference (AERO)*, pages 1–12. IEEE, 2022.
- [231] Shabnam Sadeghi Esfahlani, Alireza Sanaei, Mohammad Ghorabian, and Hassan Shirvani. The deep convolutional neural network role in the autonomous navigation of mobile robots (srobo). *Remote Sensing*, 14(14):3324, 2022.
- [232] Donghun Shin, Joongho Cho, and Jaeho Kim. Environment-adaptive object detection framework for autonomous mobile robots. *Sensors*, 22(19):7647, 2022.
- [233] Glenn Jocher, Alex Stoken, Jirka Borovec, Ayush Chaurasia, and L Changyu. ultralytics/yolov5. *GitHub Repository, YOLOv5*, 2020.
- [234] Shuai Shao, Zeming Li, Tianyuan Zhang, Chao Peng, Gang Yu, Xiangyu Zhang, Jing Li, and Jian Sun. Objects365: A large-scale, high-quality dataset for object detection. In *Proceedings of the IEEE/CVF international conference on computer vision*, pages 8430–8439, 2019.
- [235] Kaiming He, Xiangyu Zhang, Shaoqing Ren, and Jian Sun. Deep residual learning for image recognition. In *Proceedings of the IEEE conference on computer vision and pattern recognition*, pages 770–778, 2016.
- [236] Bolei Zhou, Agata Lapedriza, Aditya Khosla, Aude Oliva, and Antonio Torralba. Places: A 10 million image database for scene recognition. *IEEE transactions on pattern analysis and machine intelligence*, 40(6):1452–1464, 2017.

- [237] Zheyuan Zhou, Liang Du, Xiaoqing Ye, Zhikang Zou, Xiao Tan, Li Zhang, Xiangyang Xue, and Jianfeng Feng. Sgm3d: stereo guided monocular 3d object detection. *IEEE Robotics and Automation Letters*, 7(4):10478–10485, 2022.
- [238] John Houston, Guido Zuidhof, Luca Bergamini, Yawei Ye, Long Chen, Ashesh Jain, Sammy Omari, Vladimir Iglovikov, and Peter Ondruska. One thousand and one hours: Self-driving motion prediction dataset. In *Conference on Robot Learning*, pages 409–418. PMLR, 2021.
- [239] Mouna Afif, Riadh Ayachi, Yahia Said, and Mohamed Atri. An evaluation of efficientdet for object detection used for indoor robots assistance navigation. *Journal of Real-Time Image Processing*, 19(3):651–661, 2022.
- [240] Ajay Talele, Aseem Patil, and Bhushan Barse. Detection of real time objects using tensorflow and opencv. *Asian Journal For Convergence In Technology (AJCT) ISSN-2350-1146*, 2019.
- [241] Martín Abadi, Paul Barham, Jianmin Chen, Zhifeng Chen, Andy Davis, Jeffrey Dean, Matthieu Devin, Sanjay Ghemawat, Geoffrey Irving, Michael Isard, et al. Tensorflow: a system for large-scale machine learning. In *Osd*, volume 16, pages 265–283. Savannah, GA, USA, 2016.
- [242] Gary Bradski. The opencv library. *Dr. Dobb's Journal: Software Tools for the Professional Programmer*, 25(11):120–123, 2000.
- [243] Shuangjian Jiao and Lingling Wang. Road obstacle detection in bad weather based on deep learning. In *Journal of Physics: Conference Series*, volume 1881, page 042041. IOP Publishing, 2021.
- [244] Malik Haris and Jin Hou. Obstacle detection and safely navigate the autonomous vehicle from unexpected obstacles on the driving lane. *Sensors*, 20(17):4719, 2020.
- [245] Van-Tin Luu, Viet-Cuong Huynh, Vu-Hoang Tran, Trung-Hieu Nguyen, et al. Traditional method meets deep learning in an adaptive lane and obstacle detection system. In *2020 5th International Conference on Green Technology and Sustainable Development (GTSD)*, pages 148–152. IEEE, 2020.
- [246] Zhengjun Qiu, Nan Zhao, Lei Zhou, Mengcen Wang, Liangliang Yang, Hui Fang, Yong He, and Yufei Liu. Vision-based moving obstacle detection and tracking in paddy field using improved yolov3 and deep sort. *Sensors*, 20(15):4082, 2020.
- [247] Albert Aarón Cervera-Urbe and Paul Erick Mendez-Monroy. U19-net: a deep learning approach for obstacle detection in self-driving cars. *Soft Computing*, 26(11):5195–5207, 2022.
- [248] Wenyan Ci, Tianxiang Xu, Runze Lin, and Shan Lu. A novel method for unexpected obstacle detection in the traffic environment based on computer vision. *Applied Sciences*, 12(18):8937, 2022.
- [249] Peter Pinggera, Sebastian Ramos, Stefan Gehrig, Uwe Franke, Carsten Rother, and Rudolf Mester. Lost and found: detecting small road hazards for self-driving vehicles. In *2016 IEEE/RSJ International Conference on Intelligent Robots and Systems (IROS)*, pages 1099–1106. IEEE, 2016.
- [250] DASHUAI Wang, ZHUOLIN Li, XIAOQIANG Du, ZENGHONG Ma, and XIAOGUANG Liu. Farmland obstacle detection from the perspective of uavs based on non-local deformable detr. *Agriculture*, 12(12):1983, 2022.
- [251] Hongyu Li, Zhengang Li, Neset Unver Akmandor, Huaizu Jiang, Yanzhi Wang, and Taskin Padir. Stereovoxelnet: Real-time obstacle detection based on occupancy voxels from a stereo camera using deep neural networks. *arXiv preprint arXiv:2209.08459*, 2022.
- [252] Irene Cortés, Jorge Beltrán, Arturo De La Escalera, and Fernando García. Dali: Domain adaptation in lidar point clouds for 3d obstacle detection. In *2022 IEEE 25th International Conference on Intelligent Transportation Systems (ITSC)*, pages 3837–3842. IEEE, 2022.
- [253] Wenshan Wang, Shuang Wang, Yongcun Guo, and Yanqiu Zhao. Obstacle detection method of unmanned electric locomotive in coal mine based on yolov3-4l. *Journal of Electronic Imaging*, 31(2):023032–023032, 2022.
- [254] Marten Franke, Chaitra Reddy, Danijela Ristić-Durrant, Jehan Jayawardana, Kai Michels, Milan Banić, and Miloš Simonović. Towards holistic autonomous obstacle detection in railways by complementing of on-board vision with uav-based object localization. In *2022 IEEE/RSJ International Conference on Intelligent Robots and Systems (IROS)*, pages 7012–7019. IEEE, 2022.
- [255] Y Sarada Devi, S Sathvik, P Ananya, P Tharuni, and N Naga Krishna Vamsi. Vision-based obstacle detection and collision prevention in self-driving cars. In *Journal of Physics: Conference Series*, volume 2335, page 012019. IOP Publishing, 2022.
- [256] Naoya Hayashida and Hiroyoshi Miwa. Obstacle detection support system using monocular camera. In *Advances in Intelligent Networking and Collaborative Systems: The 14th International Conference on Intelligent Networking and Collaborative Systems (INCoS-2022)*, pages 62–73. Springer, 2022.

- [257] Sung-Woo Byun, Donghee Noh, and Hea-Min Lee. Design of obstacle detection method for autonomous driving in agricultural environments. In *2022 Thirteenth International Conference on Ubiquitous and Future Networks (ICUFN)*, pages 494–496. IEEE, 2022.
- [258] Phat Nguyen Huu, Quyen Pham Thi, and Phuong Tong Thi Quynh. Proposing lane and obstacle detection algorithm using yolo to control self-driving cars on advanced networks. *Advances in Multimedia*, 2022, 2022.
- [259] Guotong Chen, Jiangtao Qi, and Zeyu Dai. Real-time maritime obstacle detection based on yolov5 for autonomous berthing. In *Bio-Inspired Computing: Theories and Applications: 16th International Conference, BIC-TA 2021, Taiyuan, China, December 17–19, 2021, Revised Selected Papers, Part II*, pages 412–427. Springer, 2022.
- [260] Wenhua Ma, Xin Wang, and Baohua Wang. Fast obstacle detection platform based on yolo. In *Proceedings of the 5th International Conference on Electrical Engineering and Information Technologies for Rail Transportation (EITRT) 2021: Rail Transportation System Safety and Maintenance Technologies*, pages 218–226. Springer, 2022.
- [261] Stefano Gasperini, Jan Haug, Mohammad-Ali Nikouei Mahani, Alvaro Marcos-Ramiro, Nassir Navab, Benjamin Busam, and Federico Tombari. Certainnet: Sampling-free uncertainty estimation for object detection. *IEEE Robotics and Automation Letters*, 7(2):698–705, 2021.
- [262] Hanjiang Hu, Zuxin Liu, Sharad Chitlangia, Akhil Agnihotri, and Ding Zhao. Investigating the impact of multi-lidar placement on object detection for autonomous driving. In *Proceedings of the IEEE/CVF Conference on Computer Vision and Pattern Recognition*, pages 2550–2559, 2022.
- [263] Shuo Chang, Yifan Zhang, Fan Zhang, Xiaotong Zhao, Sai Huang, Zhiyong Feng, and Zhiqing Wei. Spatial attention fusion for obstacle detection using mmwave radar and vision sensor. *Sensors*, 20(4):956, 2020.
- [264] MV Pranav, AV Shreyas Madhav, and Janaki Meena. Deeprecog: Threefold underwater image deblurring and object recognition framework for auv vision systems. *Multimedia Systems*, pages 1–11, 2022.
- [265] Qiang Zhang, Fei Yan, Weina Song, Rui Wang, and Gen Li. Automatic obstacle detection method for the train based on deep learning. *Sustainability*, 15(2):1184, 2023.
- [266] Inam Ullah, Yu Shen, Xin Su, Christian Esposito, and Chang Choi. A localization based on unscented kalman filter and particle filter localization algorithms. *IEEE Access*, 8:2233–2246, 2019.
- [267] Gunasekaran Raja, Sailakshmi Suresh, Sudha Anbalagan, Aishwarya Ganapathisubramaniyan, and Neeraj Kumar. Pfin: An efficient particle filter-based indoor navigation framework for uavs. *IEEE Transactions on Vehicular Technology*, 70(5):4984–4992, 2021.
- [268] Giorgio Grisetti, Rainer Kümmerle, Cyrill Stachniss, and Wolfram Burgard. A tutorial on graph-based slam. *IEEE Intelligent Transportation Systems Magazine*, 2(4):31–43, 2010.
- [269] Tong Qin, Tongqing Chen, Yilun Chen, and Qing Su. Avp-slam: Semantic visual mapping and localization for autonomous vehicles in the parking lot. In *2020 IEEE/RSJ International Conference on Intelligent Robots and Systems (IROS)*, pages 5939–5945. IEEE, 2020.
- [270] Hriday Bavle, Paloma De La Puente, Jonathan P How, and Pascual Campoy. Vps-slam: Visual planar semantic slam for aerial robotic systems. *IEEE Access*, 8:60704–60718, 2020.
- [271] Koray Celik and Arun K Somani. Monocular vision slam for indoor aerial vehicles. *Journal of electrical and computer engineering*, 2013:4–4, 2013.
- [272] Dimitrios Geromichalos, Martin Azkarate, Emmanouil Tsardoulis, Levin Gerdes, Loukas Petrou, and Carlos Perez Del Pulgar. Slam for autonomous planetary rovers with global localization. *Journal of Field Robotics*, 37(5):830–847, 2020.
- [273] Francesca Baldini, Alexei Harvard, Soon-Jo Chung, Issa Nesnas, and Shyamkumar Bhaskaran. Autonomous small body mapping and spacecraft navigation via real-time spc-slam. 2018.
- [274] Yulun Tian, Yun Chang, Fernando Herrera Arias, Carlos Nieto-Granda, Jonathan P How, and Luca Carlone. Kimera-multi: Robust, distributed, dense metric-semantic slam for multi-robot systems. *IEEE Transactions on Robotics*, 38(4), 2022.
- [275] Seungwon Song, Hyungtae Lim, Alex Junho Lee, and Hyun Myung. Dynavins: A visual-inertial slam for dynamic environments. *IEEE Robotics and Automation Letters*, 7(4):11523–11530, 2022.
- [276] Ying Sun, Jun Hu, Juntong Yun, Ying Liu, Dongxu Bai, Xin Liu, Guojun Zhao, Guozhang Jiang, Jianyi Kong, and Baojia Chen. Multi-objective location and mapping based on deep learning and visual slam. *Sensors*, 22(19):7576, 2022.
- [277] Raul Mur-Artal and Juan D Tardós. Orb-slam2: An open-source slam system for monocular, stereo, and rgb-d cameras. *IEEE transactions on robotics*, 33(5):1255–1262, 2017.

- [278] Jürgen Sturm, Nikolas Engelhard, Felix Endres, Wolfram Burgard, and Daniel Cremers. A benchmark for the evaluation of rgb-d slam systems. In *2012 IEEE/RSJ international conference on intelligent robots and systems*, pages 573–580. IEEE, 2012.
- [279] Sungchul Hong, Antyanta Bangunharcana, Jae-Min Park, Minseong Choi, and Hyu-Soung Shin. Visual slam-based robotic mapping method for planetary construction. *Sensors*, 21(22):7715, 2021.
- [280] Arman Asgharpour Golroudbari. *Design and Simulation of Attitude and Heading Estimation Algorithm*. PhD thesis, University of Tehran, 2022.
- [281] Mohammad OA Aqel, Mohammad H Marhaban, M Iqbal Saripan, and Napsiah Bt Ismail. Review of visual odometry: types, approaches, challenges, and applications. *SpringerPlus*, 5:1–26, 2016.
- [282] David Nistér, Oleg Naroditsky, and James Bergen. Visual odometry. In *Proceedings of the 2004 IEEE Computer Society Conference on Computer Vision and Pattern Recognition, 2004. CVPR 2004.*, volume 1, pages I–I. Ieee, 2004.
- [283] Arno Solin, Santiago Cortes, Esa Rahtu, and Juho Kannala. Inertial odometry on handheld smartphones. In *2018 21st International Conference on Information Fusion (FUSION)*, pages 1–5. IEEE, 2018.
- [284] Martin Brossard and Silvere Bonnabel. Learning wheel odometry and imu errors for localization. In *2019 International Conference on Robotics and Automation (ICRA)*, pages 291–297. IEEE, 2019.
- [285] Peter Muller and Andreas Savakis. Flowdometry: An optical flow and deep learning based approach to visual odometry. In *2017 IEEE Winter Conference on Applications of Computer Vision (WACV)*, pages 624–631. IEEE, 2017.
- [286] Kazunori Ohno, Takashi Tsubouchi, Bunji Shigematsu, and Shin’ichi Yuta. Differential gps and odometry-based outdoor navigation of a mobile robot. *Advanced Robotics*, 18(6):611–635, 2004.
- [287] Changhao Chen, Peijun Zhao, Chris Xiaoxuan Lu, Wei Wang, Andrew Markham, and Niki Trigoni. Deep-learning-based pedestrian inertial navigation: Methods, data set, and on-device inference. *IEEE Internet of Things Journal*, 7(5):4431–4441, 2020.
- [288] Liming Han, Yimin Lin, Guoguang Du, and Shiguo Lian. Deepvio: Self-supervised deep learning of monocular visual inertial odometry using 3d geometric constraints. In *2019 IEEE/RSJ International Conference on Intelligent Robots and Systems (IROS)*, pages 6906–6913. IEEE, 2019.
- [289] Sen Wang, Ronald Clark, Hongkai Wen, and Niki Trigoni. Deepvo: Towards end-to-end visual odometry with deep recurrent convolutional neural networks. In *2017 IEEE international conference on robotics and automation (ICRA)*, pages 2043–2050. IEEE, 2017.
- [290] Kishore Reddy Konda and Roland Memisevic. Learning visual odometry with a convolutional network. *VISAPP (1)*, 2015:486–490, 2015.
- [291] Andreas Geiger, Philip Lenz, Christoph Stiller, and Raquel Urtasun. Vision meets robotics: The kitti dataset. *The International Journal of Robotics Research*, 32(11):1231–1237, 2013.
- [292] Jichao Jiao, Jian Jiao, Yaokai Mo, Weilun Liu, and Zhongliang Deng. Magicvo: An end-to-end hybrid cnn and bi- lstm method for monocular visual odometry. *IEEE Access*, 7:94118–94127, 2019.
- [293] Ruihao Li, Sen Wang, Zhiqiang Long, and Dongbing Gu. Undeepvo: Monocular visual odometry through unsupervised deep learning. In *2018 IEEE international conference on robotics and automation (ICRA)*, pages 7286–7291. IEEE, 2018.
- [294] Karen Simonyan and Andrew Zisserman. Very deep convolutional networks for large-scale image recognition. *arXiv preprint arXiv:1409.1556*, 2014.
- [295] Yasin Almalioglu, Muhamad Risqi U Saputra, Pedro PB De Gusmao, Andrew Markham, and Niki Trigoni. Ganvo: Unsupervised deep monocular visual odometry and depth estimation with generative adversarial networks. In *2019 International conference on robotics and automation (ICRA)*, pages 5474–5480. IEEE, 2019.
- [296] Sen Wang, Ronald Clark, Hongkai Wen, and Niki Trigoni. End-to-end, sequence-to-sequence probabilistic visual odometry through deep neural networks. *The International Journal of Robotics Research*, 37(4-5):513–542, 2018.
- [297] Ronald Clark, Sen Wang, Hongkai Wen, Andrew Markham, and Niki Trigoni. Vinet: Visual-inertial odometry as a sequence-to-sequence learning problem. In *Proceedings of the AAAI Conference on Artificial Intelligence*, volume 31, pages ,, 2017.
- [298] Muhammet Fatih Aslan, Akif Durdu, Abdullah Yusefi, and Alper Yilmaz. Hvionet: A deep learning based hybrid visual–inertial odometry approach for unmanned aerial system position estimation. *Neural Networks*, 155:461–474, 2022.

- [299] Mingyu Yang, Yu Chen, and Hun-Seok Kim. Efficient deep visual and inertial odometry with adaptive visual modality selection. In *Computer Vision—ECCV 2022: 17th European Conference, Tel Aviv, Israel, October 23–27, 2022, Proceedings, Part XXXVIII*, pages 233–250. Springer, 2022.
- [300] Anand George, Niko Koivumäki, Teemu Hakala, Juha Suomalainen, and Eija Honkavaara. Visual-inertial odometry using high flying altitude drone datasets. *Drones*, 7(1):36, 2023.
- [301] Anand George, Niko Koivumäki, Teemu Hakala, Juha Suomalainen, and Eija Honkavaara. Fgi masala stereo-visual-inertial dataset 2021. <https://doi.org/10.23729/f4c5d2d0-eddb-40a1-89ce-601c252dab35>, 11 2022. National Land Survey of Finland, FGI Dept. of Remote sensing and photogrammetry.
- [302] Zheming Tu, Changhao Chen, Xianfei Pan, Ruochen Liu, Jiarui Cui, and Jun Mao. Ema-vio: Deep visual-inertial odometry with external memory attention. *IEEE Sensors Journal*, 22(21):20877–20885, 2022.
- [303] Yasin Almalioglu, Mehmet Turan, Muhamad Risqi U Saputra, Pedro PB de Gusmão, Andrew Markham, and Niki Trigoni. Selfvio: Self-supervised deep monocular visual-inertial odometry and depth estimation. *Neural Networks*, 150:119–136, 2022.
- [304] Santiago Cortés, Arno Solin, and Juho Kannala. Deep learning based speed estimation for constraining strapdown inertial navigation on smartphones. In *2018 IEEE 28th International Workshop on Machine Learning for Signal Processing (MLSP)*, pages 1–6. IEEE, 2018.
- [305] Changhao Chen, Xiaoxuan Lu, Andrew Markham, and Niki Trigoni. Ionet: Learning to cure the curse of drift in inertial odometry. In *Proceedings of the AAAI Conference on Artificial Intelligence*, volume 32, pages , 2018.
- [306] Changhao Chen, Chris Xiaoxuan Lu, Johan Wahlström, Andrew Markham, and Niki Trigoni. Deep neural network based inertial odometry using low-cost inertial measurement units. *IEEE Transactions on Mobile Computing*, 20(4):1351–1364, 2019.
- [307] Mahdi Abolfazli Esfahani, Han Wang, Keyu Wu, and Shenghai Yuan. Aboldeepio: A novel deep inertial odometry network for autonomous vehicles. *IEEE Transactions on Intelligent Transportation Systems*, 21(5):1941–1950, 2019.
- [308] João Paulo Silva do Monte Lima, Hideaki Uchiyama, and Rin-ichiro Taniguchi. End-to-end learning framework for imu-based 6-dof odometry. *Sensors*, 19(17):3777, 2019.
- [309] Wenxin Liu, David Caruso, Eddy Ilg, Jing Dong, Anastasios I Mourikis, Kostas Daniilidis, Vijay Kumar, and Jakob Engel. Tlio: Tight learned inertial odometry. *IEEE Robotics and Automation Letters*, 5(4):5653–5660, 2020.
- [310] Vânia Guimarães, Inês Sousa, and Miguel Velhote Correia. A deep learning approach for foot trajectory estimation in gait analysis using inertial sensors. *Sensors*, 21(22):7517, 2021.
- [311] M Serhat Soyer, A Abdel-Qader, and Mehmet Cengiz Onbaşlı. An efficient and low-latency deep inertial odometer for smartphone positioning. *IEEE Sensors Journal*, 21(24):27676–27685, 2021.
- [312] Takuma Uno, Naoya Isoyama, Hideaki Uchiyama, Nobuchika Sakata, and Kiyoshi Kiyokawa. Deep inertial underwater odometry system. *CEUR Workshop Proceedings*, 2022.
- [313] Boxuan Chen, Ruifeng Zhang, Shaochu Wang, Liqiang Zhang, and Yu Liu. Deep-learning-based inertial odometry for pedestrian tracking using attention mechanism and res2net module. *IEEE Sensors Letters*, 6(11):1–4, 2022.
- [314] Ashraf A Deraz, Osama Badawy, Mostafa A Elhosseini, Mostafa Mostafa, Hesham A Ali, and Ali I El-Desouky. Deep learning based on lstm model for enhanced visual odometry navigation system. *Ain Shams Engineering Journal*, page 102050, 2022.
- [315] Yingying Wang, Hu Cheng, and Max Q-H Meng. A2dio: Attention-driven deep inertial odometry for pedestrian localization based on 6d imu. In *2022 International Conference on Robotics and Automation (ICRA)*, pages 819–825. IEEE, 2022.
- [316] Hossein Shoushtari, Firas Kassawat, Dorian Harder, Korvin Venzke, Jörg Müller-Lietzkow, and Harald Sternberg. L5in+: From an analytical platform to optimization of deep inertial odometry. In *12th International Conference on Indoor Positioning and Indoor Navigation-Work-in-Progress Papers (IPIN-WiP 2022)*, 5-7 September 2022, Beijing, China., pages . CEUR-WS, 2022.
- [317] Giovanni Cioffi, Leonard Bauersfeld, Elia Kaufmann, and Davide Scaramuzza. Learned inertial odometry for autonomous drone racing. *arXiv preprint arXiv:2210.15287*, 2022.
- [318] Kunyi Zhang, Chenxing Jiang, Jinghang Li, Sheng Yang, Teng Ma, Chao Xu, and Fei Gao. Dido: Deep inertial quadrotor dynamical odometry. *IEEE Robotics and Automation Letters*, 7(4):9083–9090, 2022.
- [319] Russell Buchanan, Marco Camurri, Frank Dellaert, and Maurice Fallon. Learning inertial odometry for dynamic legged robot state estimation. In *Conference on Robot Learning*, pages 1575–1584. PMLR, 2022.

- [320] Yan Wang, Jian Kuang, You Li, and Xiaoji Niu. Magnetic field-enhanced learning-based inertial odometry for indoor pedestrian. *IEEE Transactions on Instrumentation and Measurement*, 71:1–13, 2022.
- [321] Swapnil Sayan Saha, Sandeep Singh Sandha, Luis Antonio Garcia, and Mani Srivastava. Tinyodom: Hardware-aware efficient neural inertial navigation. *Proceedings of the ACM on Interactive, Mobile, Wearable and Ubiquitous Technologies*, 6(2):1–32, 2022.
- [322] Marco Visca, Roger Powell, Yang Gao, and Saber Fallah. Meta-conv1d energy-aware path planner for mobile robots in unstructured terrains. 2022.