

Deterministic regular functions of infinite words

Olivier Carton ✉ 

Université Paris Cité, CNRS, IRIF, F-75013, Paris, France

Gaëtan Douéneau-Tabot ✉

Université Paris Cité, CNRS, IRIF, F-75013, Paris, France

Direction générale de l'armement - Ingénierie des projets, Paris, France

Emmanuel Filiot ✉ 

Université libre de Bruxelles & F.R.S.-FNRS, Brussels, Belgium

Sarah Winter ✉ 

Université libre de Bruxelles & F.R.S.-FNRS, Brussels, Belgium

Abstract

Regular functions of infinite words are (partial) functions realized by deterministic two-way transducers with *infinite* look-ahead. Equivalently, Alur et. al. have shown that they correspond to functions realized by deterministic Muller streaming string transducers, and to functions defined by MSO-transductions. Regular functions are however not computable in general (for a classical extension of Turing computability to infinite inputs), and we consider in this paper the class of *deterministic regular functions* of infinite words, realized by deterministic two-way transducers *without* look-ahead. We prove that it is a well-behaved class of functions: they are computable, closed under composition, characterized by the *guarded* fragment of MSO-transductions, by deterministic Büchi streaming string transducers, by deterministic two-way transducers with *finite* look-ahead, and by finite compositions of sequential functions and one fixed basic function called **map-copy-reverse**.

2012 ACM Subject Classification Theory of computation → Formal languages and automata theory

Keywords and phrases infinite words, streaming string transducers, two-way transducers, monadic second-order logic, look-aheads, factorization forests

1 Introduction

Transducers extend automata with output mechanisms, turning finite state machines from language acceptors to computational models for functions. Inspired by a seminal work by Engelfriet and Hoogetboom [21], the last decade has seen an increasing interest in characterizing the class of functions defined by deterministic two-way transducers over finite words (2-dT), now called the class of *regular functions of finite words*. This class admits several (effective) characterizations: it corresponds to the functions definable by MSO-transductions [21], by an MSO-based logic on origin graphs [14], by an extension of regular expressions called combinator expressions [4, 5, 19], and computed by *copyless streaming string transducers* (SST) (a deterministic one-way model which uses registers to store and update partial output words [2]). Moreover, the class of regular functions over finite words is closed under composition [10], and it has decidable equivalence problem [24].

► **Example 1.1.** Let Σ be an alphabet, the function **map-copy-reverse** : $(\Sigma \uplus \{\mid\})^* \rightarrow (\Sigma \uplus \{\mid\})^*$ takes any word of the form $u_1 \mid \dots \mid u_n$ where each u_i is \mid -free, and outputs $u_1 \mid \widetilde{u_1} \mid \dots \mid u_n \mid \widetilde{u_n}$, where $\widetilde{u_i}$ is the mirror image of u_i . The function **map-copy-reverse** is regular.

Regular functions can also be characterized as the compositions of sequential functions (functions computed by deterministic *one-way* finite transducers) and **map-copy-reverse** [6].

Regular functions of infinite words The class of regular functions has been extended to infinite words in [3], and defined as the class of functions definable by MSO-transductions over

infinite words. Equivalently, they have been shown to be the functions realized by deterministic two-way transducers with regular look-ahead, and by streaming string transducers with a Muller selection condition (the register holding the final output word is selected depending on the set of states seen infinitely often). As for finite words, regular functions of infinite words are closed under composition, and have decidable equivalence problem [3].

► **Example 1.2.** Let $\Sigma = \{a, b, c\}$ be an alphabet, and consider the function $\text{double} : \Sigma^\omega \rightarrow \Sigma^\omega$ which behaves like the identity function except that any occurrence of a is replaced by aa if there exists a b in the future of that occurrence. For example, $(ab)^\omega$ is mapped to $(aab)^\omega$ and $acaab(ac)^\omega$ is mapped to $aacaaaab(ac)^\omega$. The function double is regular, as it can be realized by a one-way transducer which, when reading an a , uses regular look-aheads to determine whether there exists a b or not in the future, and produces either a or aa accordingly.

► **Example 1.3.** Let $\Sigma' = \{a, b, 1, 2\}$ and consider the function copy which maps:

- $u_1\sigma_1u_2 \dots \sigma_nu \mapsto u_1^{\sigma_1}\sigma_1 \dots u_n^{\sigma_n}\sigma_nu$ where $u_1u_2 \dots u_nu \in \{a, b\}^\omega$ and $\sigma_1, \dots, \sigma_n \in \{1, 2\}$;
- $u_1\sigma_1 \dots u_i\sigma_i \dots \mapsto u_1^{\sigma_1}\sigma_1 \dots u_i^{\sigma_i}\sigma_i \dots$ (if there are infinitely many $\sigma_i \in \{1, 2\}$).

For example, $\text{copy}(ab2a1b^\omega) = abab2a1b^\omega$ and $\text{copy}((a2)^\omega) = (aa2)^\omega$. The function copy is regular, for instance realized by a deterministic two-way transducer which, using two-wayness, makes one or two passes on the blocks u_i , depending on whether they are followed by $\sigma_i = 2$. On the first pass, it always outputs what it reads, so that if no separator in $\{1, 2\}$ is ever read again (which means it is reading the infinite suffix u), then it outputs u .

Despite the robustness of the class of regular functions of infinite words, witnessed by its various characterizations and algorithmic properties, they suffer from a severe downside when it comes to computability. Indeed, there are regular functions of infinite words which are *not* computable. At this point, we make clear what is meant by computability, since the input is infinite. We refer the reader to [17, 18] (and the references therein) for a formal definition of computability, and rather give intuitions here. A function f of infinite words is computable if there is a Turing machine with an infinite read-only tape which contains some infinite input word u in the domain of the function, a bidirectional working tape, and a write-only left-to-right output tape, such that by reading longer and longer input prefixes, the machine writes longer and longer prefixes of $f(u)$ on the output tape. Informally, it is an algorithm which takes the input as a stream and is able to produce the output as a stream, so that infinitely often, at least one output symbol is produced. For instance, the function double above is not computable. On reading prefixes of the form ac^n for increasing values of n , it can safely output one a symbol, but not more. Indeed, if it outputs one more a , then it is a wrong output for continuation c^ω , and if it outputs a c , then it is a wrong output for continuation b^ω , as $\text{double}(ac^n c^\omega) = ac^\omega$ and $\text{double}(ac^n b^\omega) = aac^n b^\omega$. Its implementation by a two-way transducer indeed requires an infinite look-ahead to check the absence of a b in the future. On the other hand, copy is realized by a deterministic two-way transducer with *no* look-ahead, so it is computable. So, deterministic two-way transducers with (infinite) look-ahead, and their equivalent model Muller streaming string transducers, *cannot* be considered as models of computation for infinite word functions. This was observed in [18], where it is shown that the problem of deciding whether a given regular function of infinite words is computable is PSPACE-C. On the other hand, deterministic two-way transducers *without look-ahead* are a proper model of computation for functions of infinite words.

Deterministic regular functions of infinite words Motivated by the latter observation, the class of functions computed by deterministic two-way transducers *without* look-ahead,

coined the class of *deterministic regular functions*, was introduced in [9], where it is shown that they are also equivalently computed by Büchi SST (BSST). In BSST, there is one special designated register **out** in which to write the output word, which is required to be updated with at least one new symbol infinitely often. For example, **copy** can be implemented by a single-state BSST with two registers **out** and **τ**, updated as follows. On reading $\sigma \in \{a, b\}$, it performs the updates $\mathbf{out} \mapsto \mathbf{out}.\sigma$ and $\mathbf{\tau} \mapsto \mathbf{\tau}.\sigma$, on reading 1, it does $\mathbf{out} \mapsto \mathbf{out}.1$ and $\mathbf{\tau} \mapsto \varepsilon$, and on reading 2, it does $\mathbf{out} \mapsto \mathbf{out}.\mathbf{\tau}.2$ and $\mathbf{\tau} \mapsto \varepsilon$.

Several important questions remain on the class of deterministic regular functions, such as whether it is closed under composition, whether it can be logically characterized by a natural fragment of MSO-transductions, and whether they can be obtained as finite compositions of “simple” functions. In this paper, we provide positive answers to these questions.

Contributions Concerning the class of deterministic regular functions, our main results are:

- its effective closure under composition;
- its characterization by means of finite compositions of sequential functions and an extension of **map-copy-reverse** to infinite words;
- a logical characterization by a natural syntactic fragment of MSO-transductions, the guarded fragment, called MSOT_g .

An MSO-transduction is defined as an MSO-interpretation, where the predicates of the output word structure, namely the successor and label relations, are defined by MSO formulas with two and one free first-order variables respectively, interpreted over a fixed number of copies of the input. The guarded fragment is defined by a classical restriction (see e.g. [23] and references therein) on the MSO formulas composing the MSO-transduction. They have to be prefixed by an existential quantifier $\exists \mathbf{g}$, where \mathbf{g} is a word position, and all quantifiers of the formula are guarded by the guard $x \leq \mathbf{g}$ (and $\forall x \in X, x \leq \mathbf{g}$ for any set variable X). So, guarded MSO formulas on infinite words, only speak about finite prefixes. Consider again the function **copy**. Two copies of the input are needed to account for potential duplication of the blocks, but the presence or not of a successor edge between two nodes of the output word structure, only depends on local properties, which are definable by guarded MSO formulas. E.g., such a property may be “if position $x + 1$ is labeled 2, then there is a successor between the 1st copy of x and the 2nd copy of first position of the block to which x belongs”.

In general, guarded MSO formulas can test non-local properties, which is the main source of technical difficulties in the paper. It is illustrated by the next example.

► **Example 1.4.** The function $\mathbf{replace} : \{0, a, b\}^\omega \rightarrow \{a, b\}^\omega$ of domain $\text{Dom}(\mathbf{replace}) = \{u \in \{0, a, b\}^\omega : |u|_a = \infty \text{ or } |u|_b = \infty\}$ and mapping $0^{n_1}\sigma_1 0^{n_2}\sigma_2 \dots \mapsto \sigma_1^{n_1+1}\sigma_2^{n_2+1} \dots$ if $\sigma_i \in \{a, b\}$ and $n_i \in \mathbb{N}$, is deterministic regular. Replacing a zero at position x by a or b depends on the next non-zero symbol in the future of x , which can be arbitrarily faraway, but occurs in a finite prefix if $u \in \text{Dom}(\mathbf{replace})$. This property is expressible with a guarded MSO formula, which defines the position holding this non-zero symbol as a guard.

Proof techniques and additional results We now give an overview of the proof techniques used to show the logical characterization, along with some other interesting and useful results. We prove that deterministic two-way transducers (2-dT) are expressively equivalent to MSOT_g . The conversion of 2-dT into MSOT_g is standard and follows the same line as [21]. The converse is more involved and requires new techniques. First, we convert MSO_g -transductions into deterministic two-way transducers with *finite look-ahead* (2-dT^{FLA}), which

account for non-local, but finite, properties, as illustrated before. 2-dT^{FLA} are equipped with regular languages of finite words on their transitions, which act as finite look-aheads in the following sense: when the reading head is at some position i of an infinite word u , in some state q , a transition from q with look-ahead L is enabled if there exists a position $j \geq i$, called witness, such that the infix $u[i:j]$ starting at position i and ending at position j , belongs to L . If no transition is enabled at state q , the computation fails. To ensure determinism, if several transitions are enabled, only the transition with minimal (i.e. smallest) witness j is triggered, and a disjointness requirement on the look-aheads make sure that this j is unique. The condition to consider only the transition with minimal witness j is crucial to ensure that 2-dT^{FLA} define only computable functions. Indeed, a 2-dT^{FLA} can be executed as follows: all finite look-aheads, supposed for instance to be finitely represented by DFA, are executed in parallel. By the minimality requirement for j and the disjointness of look-aheads, *as soon as* a prefix is accepted by one look-ahead DFA, the corresponding transition is triggered.

Adding look-aheads to two-way transducers in order to capture MSO-transductions is standard on finite words [21, 13], for example because the “moves” of the MSO-transduction depends on non-local properties. Look-aheads are then directly removed by using the closure under composition of deterministic two-way transducers [10]. Closure under composition of deterministic two-way transducers on infinite words is, to the best of our knowledge, unknown, and instead we give a direct proof of finite look-ahead removal. It is our main technical result: any 2-dT^{FLA} is effectively equivalent to some 2-dT . To prove this result, classical techniques, such as Hopcroft-Ullman construction [1] or the tree outline construction [15] do not apply, as they heavily rely on the fact that words are finite. In our setting, we instead use a new technique, based on summarizing the computations of the look-aheads into trees which we prove to be bounded. As a side result of finite look-ahead removal, we prove that 2-dT (and so deterministic regular functions) are closed under composition. Classically, closure under composition of MSO-transductions is direct, by formula substitutions [13]. This technique however does not apply here, as the guarded MSO formulas are not syntactically closed under formula substitution, making the correspondence between MSOT_g and 2-dT crucial to obtain closure under composition of MSO_g -transductions.

Structure of the paper In Section 2, we introduce the class of deterministic regular functions. In Section 3, we prove its closure under composition and the decomposition result. In Section 4, we introduce guarded MSO-transductions and state the logical characterization. Since its proof is based on a compilation into deterministic two-way transducers with finite look-ahead, we prove in Section 5 how to remove those look-aheads. Finally, we prove the logical characterization in Section 6. All transformations are effective in the paper. Some proofs are only sketched or simply omitted, but the proof details can be found in Appendix.

2 Deterministic regular functions

In this section, we introduce the class of *deterministic regular functions of infinite words* and recall that it can be described by two computation models: *deterministic two-way transducers* and *deterministic Büchi streaming string transducers*.

Notations Letters Σ, Γ denote alphabets, i.e. finite sets of letters. The set Σ^* (resp. Σ^+ , Σ^ω) denotes the set of finite words (resp. non-empty finite words, infinite words) over the alphabet Σ . Let $\Sigma^\infty := \Sigma^* \cup \Sigma^\omega$. If $u \in \Sigma^\infty$, we let $|u| \in \mathbb{N} \cup \{\infty\}$ be its length, $|u|_\sigma \in \mathbb{N} \cup \{\infty\}$ be the number of occurrences of $\sigma \in \Sigma$ and $u[i] \in \Sigma$ be the i -th letter of u for $1 \leq i \leq |u|$.

If $1 \leq i \leq j \leq |u|$, $u[i:j]$ stands for $u[i] \cdots u[j]$. We write $u[i:]$ for $u[i:|u|]$. If $j > |u|$ we let $u[i:j] := u[i:|u|]$. If $j < i$ we let $u[i:j] := \varepsilon$. In this paper, functions are *by default* partial (i.e. possibly with non-total domain). A (partial) function f from S to T is denoted $f : S \rightarrow T$, and its domain is denoted $\text{Dom}(f) \subseteq S$. A total function from S to T is denoted $f : S \rightarrow T$.

Two-way transducers Let us recall the syntax of two-way transducers. We consider here that the machines work on infinite words, and have a Büchi acceptance condition.

► **Definition 2.1** (Two-way transducer). A deterministic two-way transducer (2-dT) denoted $\mathcal{T} = (\Sigma, \Gamma, Q, q_0, F, \delta, \lambda)$ consists of:

- an input alphabet Σ and an output alphabet Γ ;
- a finite set of states Q with an initial state $q_0 \in Q$ and a set of final states $F \subseteq Q$;
- a transition function $\delta : Q \times (\Sigma \uplus \{\vdash\}) \rightarrow Q \times \{\triangleleft, \triangleright\}$;
- an output function $\lambda : Q \times (\Sigma \uplus \{\vdash\}) \rightarrow \Gamma^*$ with same domain as δ .

A configuration of \mathcal{T} over $u \in (\Sigma \cup \{\vdash\})^\omega$ is a tuple (q, i) where $q \in Q$ is the current state and $1 \leq i \leq |u|$ is the current position of the reading head. The transition relation \rightarrow is defined as follows. Given a configuration (q, i) , let $(q', \star) := \delta(q, u[i])$. Then $(q, i) \rightarrow (q', i')$ whenever either $\star = \triangleleft$ and $i' = i - 1$ (move left), or $\star = \triangleright$ and $i' = i + 1$ (move right). A run over u is a (finite or infinite) sequence of consecutive configurations $(q_1, i_1) \rightarrow (q_2, i_2) \rightarrow \cdots$.

Now, we define the infinite output produced by \mathcal{T} when given the infinite word $u \in \Sigma^\omega$ as input. First, we let $u[0] := \vdash$, i.e. we force the symbol \vdash to be used to mark the beginning of the input. An *accepting* run is an infinite run that starts in $(q_0, 0)$, visits infinitely often configurations of the form (q, i) with $q \in F$ and such that $i_n \rightarrow \infty$ when $n \rightarrow \infty$ (without this last condition, the transducer may enter an infinite loop without reading its whole input). The partial function $f : \Sigma^\omega \rightarrow \Gamma^\omega$ computed by \mathcal{T} is defined as follows. Let $u \in \Sigma^\omega$ be such that there exists a (unique) accepting run $(q_0^u, i_0^u) \rightarrow (q_1^u, i_1^u) \rightarrow \cdots$ labelled by $\vdash u$. Let $v := \prod_{j=1}^{\infty} \lambda(q_j^u, (\vdash u)[i_j^u]) \in \Gamma^* \cup \Gamma^\omega$ be the concatenation of the outputs produced along this run. If $v \in \Gamma^\omega$, we define $f(u) := v$. Otherwise $f(u)$ is undefined.

► **Definition 2.2.** The class of deterministic regular functions of infinite words is the class of (partial) functions computed by deterministic two-way transducers.

We have explained in Example 1.3 how to compute the function `copy` using a 2-dT (without look-aheads). Observe that the function `replace` from Example 1.4 can be computed in a similar fashion. Hence both functions are deterministic regular.

► **Example 2.3.** Let us extend the function `map-copy-reverse` of Example 1.1 to infinite words. Let Σ be an alphabet, we define `map-copy-reverse` : $(\Sigma \uplus \{\})^\omega \rightarrow (\Sigma \uplus \{\})^\omega$ as follows:

- `map-copy-reverse`($u_1|u_2|\cdots$) := $u_1|\widetilde{u_1}|u_2|\widetilde{u_2}|\cdots$ with $u_i \in \Sigma^*$ for all $i \geq 0$;
- `map-copy-reverse`($u_1|\cdots|u_n|u$) := $u_1|\widetilde{u_1}|\cdots|u_n|\widetilde{u_n}|u$ for $u_i \in \Sigma^*$ and $u \in \Sigma^\omega$.

This function is deterministic regular since we can build a 2-dT that processes twice each $|$ -free factor (or only once for the last infinite one if it exists).

Büchi Streaming String Transducers Now, we describe a model of a one-way machine with registers which captures deterministic regular functions of infinite words. Over finite words, it is well-known that deterministic two-way transducers are equivalent to *copyless streaming string transducers* [2]. A similar equivalence holds for the class of *regular functions of infinite words*, which can equivalently be described by *deterministic two-way transducers with regular look-aheads* or *copyless streaming string transducers with Muller conditions* [3]. However,

Muller conditions enable to check regular properties of the infinite input, and thus describe functions which are not (Turing) computable [3]. Now, let us recall the model of *Büchi deterministic streaming string transducer* (BSST), introduced by Carton and Douéneau-Tabot in [9], that captures exactly the class of deterministic regular functions.

Formally, a Büchi deterministic streaming string transducer consists of a one-way deterministic automaton with a finite set \mathfrak{R} of registers that store words from Γ^* . We use a distinguished register **out** to store the output produced when reading an infinite word. The registers are modified when reading the input using *substitutions*, i.e. mappings $\mathfrak{R} \rightarrow (\Gamma \uplus \mathfrak{R})^*$. We denote by $\mathcal{S}_{\mathfrak{R}}^{\Gamma}$ the set of these substitutions. They can be extended morphically from $(\Gamma \uplus \mathfrak{R})^*$ to $(\Gamma \uplus \mathfrak{R})^*$ by preserving the elements of Γ .

► **Example 2.4** (Substitutions). Let $\mathfrak{R} = \{\mathfrak{r}, \mathfrak{s}\}$ and $\Gamma = \{b\}$. Consider $\tau_1 := \mathfrak{r} \mapsto b, \mathfrak{s} \mapsto b\mathfrak{r}\mathfrak{s}b$ and $\tau_2 := \mathfrak{r} \mapsto \mathfrak{r}b, \mathfrak{s} \mapsto \mathfrak{r}\mathfrak{s}$, then $\tau_1 \circ \tau_2(\mathfrak{r}) = \tau_1(\mathfrak{r}b) = bb$ and $\tau_1 \circ \tau_2(\mathfrak{s}) = \tau_1(\mathfrak{r}\mathfrak{s}) = b\mathfrak{b}\mathfrak{r}\mathfrak{s}b$.

► **Definition 2.5.** A Büchi deterministic streaming string transducer (BSST) denoted by $\mathcal{T} = (\Sigma, \Gamma, Q, F, q_0, \delta, \mathfrak{R}, \mathbf{out}, \lambda)$ consists of:

- a finite input (resp. output) alphabet Σ (resp. Γ);
- a finite set of states Q with $q_0 \in Q$ initial and $F \subseteq Q$ final;
- a transition function $\delta : Q \times \Sigma \rightarrow Q$;
- a finite set of registers \mathfrak{R} with a distinguished output register $\mathbf{out} \in \mathfrak{R}$;
- an update function $\lambda : Q \times \Sigma \rightarrow \mathcal{S}_{\mathfrak{R}}^{\Gamma}$ such that for all $(q, \sigma) \in \text{Dom}(\lambda) = \text{Dom}(\delta)$:
 - $\lambda(q, \sigma)(\mathbf{out}) = \mathbf{out} \cdots$;
 - there is no other occurrence of **out** among the $\lambda(q, \sigma)(\mathfrak{r})$ for $\mathfrak{r} \in \mathfrak{R}$.

This machine defines a partial function $f : \Sigma^{\omega} \rightarrow \Gamma^{\omega}$ as follows. For $i \geq 0$ let $q_i^u := \delta(q_0, u[1:i])$ (when defined). For $i \geq 1$, we let $\lambda_i^u := \lambda(q_{i-1}^u, u[i])$ (when defined) and $\lambda_0^u(\mathfrak{r}) = \varepsilon$ for all $\mathfrak{r} \in \mathfrak{R}$. For $i \geq 0$, let $\llbracket \cdot \rrbracket_i^u := \lambda_0^u \circ \cdots \circ \lambda_i^u$. By construction $\llbracket \mathbf{out} \rrbracket_i^u$ is a prefix of $\llbracket \mathbf{out} \rrbracket_{i+1}^u$ (when defined). If $\llbracket \mathbf{out} \rrbracket_i^u$ is defined for all $i \geq 0$, q_i^u is a state of F infinitely often, and $\llbracket \mathbf{out} \rrbracket_i^u \rightarrow +\infty$, then we let $f(u) := \bigvee_i \llbracket \mathbf{out} \rrbracket_i^u$ (the symbol \bigvee is used to denote the unique $v \in \Gamma^{\omega}$ such that $\llbracket \mathbf{out} \rrbracket_i^u$ is a prefix of v for all $i \geq 0$). Otherwise $f(u)$ is undefined.

► **Example 2.6.** The function `replace` from Example 1.4 can be computed by a BSST. For all $i \geq 1$, it crosses the block 0^{n_i} and computes 1^{n_i} and 2^{n_i} in two registers. Once it sees σ_i it adds in **out** the register storing $\sigma_i^{n_i}$.

► **Definition 2.7** (Copyless, bounded copy). We say that a substitution $\tau \in \mathcal{S}_{\mathfrak{R}}^B$ is copyless (resp. K -bounded) if for all $\mathfrak{r} \in \mathfrak{R}$, \mathfrak{r} occurs at most once in $\{\tau(\mathfrak{s}) : \mathfrak{s} \in \mathfrak{R}\}$ (resp. for all $\mathfrak{r}, \mathfrak{s} \in \mathfrak{R}$, \mathfrak{r} occurs at most K times in $\tau(\mathfrak{s})$). We say that a BSST $\mathcal{T} = (\Sigma, \Gamma, Q, q_0, \delta, \mathfrak{R}, \mathbf{out}, \lambda)$ is copyless (resp. K -bounded) if for all $u \in \Sigma^{\omega}$ and $i \leq j$ such that $\lambda_i^u \circ \cdots \circ \lambda_j^u$ is defined, this substitution is copyless (resp. K -bounded).

► **Remark 2.8.** The composition of two copyless substitutions is copyless, hence a BSST is copyless as soon as $\lambda(q, \sigma)$ is copyless for all $q \in Q$ and $\sigma \in \Sigma$. However, K -boundedness is not necessarily preserved under composition.

Observe that the BSST described in Example 2.6 is copyless. Now, we recall the result of Carton and Douéneau-Tabot that proves equivalence between two-way transducers, copyless, and bounded copy Büchi deterministic streaming string transducers.

► **Theorem 2.9** ([9, Theorem 3.7]). The following machines compute the same class of partial functions over infinite words:

1. deterministic two-way transducers (2-dT);

2. K -bounded deterministic Büchi streaming string transducers (K -bounded BSST);
3. copyless deterministic Büchi streaming string transducers (copyless BSST).

Furthermore, all the conversions are effective.

► **Remark 2.10.** The original proof of [9] which transforms a 2-dT into a BSST only considers machines where all states are final. Nevertheless, the proof can easily be adapted to transducers with non-final states. Furthermore, given a BSST (possibly with non-final states) one can build an equivalent BSST where all states are final by [9, Lemma D.1] (the Büchi conditions are hidden in the fact that the output must be infinite). All in all, all the models (with all states final or not) exactly capture the class of deterministic regular functions.

Finally, we recall the domains of deterministic regular functions. We say that a language is *Büchi deterministic* if it is accepted by a deterministic Büchi automaton (see e.g. [25]).

► **Proposition 2.11** ([9]). *If f is deterministic regular, then $\text{Dom}(f)$ is Büchi deterministic.*

3 Composition and decomposition theorems

In this section, we show that deterministic regular functions are closed under composition, and that conversely they can be written as the composition of some “basic” functions.

It is known since [10] (resp. [3]) that the class of regular functions of finite (resp. infinite) words is closed under composition. We transport this result to deterministic regular functions of infinite words in Theorem 3.1. However, its proof is not an immediate extension of the regular case, and it illustrates the main difficulty of this paper: since look-aheads are not allowed, it is complex for a 2-dT to check if some property happens *after* its current position.

► **Theorem 3.1.** *Deterministic regular functions are (effectively) closed under composition.*

Proof idea. The approach is to compose the two transducers directly (using a product construction); the difficulty in the composition of two computations arises when one transducer is moving forward and the other backward. In that case, we need to rewind the computation of the transducer that moves backward by one computation step.

To recover the previous configuration look-ahead comes in handy. As mentioned above, (infinite) look-aheads are not permitted, but we use a weaker form of *finite* look-aheads (to be introduced in Section 5) which does not increase the expressiveness of deterministic two-way transducers over infinite words (and can be effectively removed), see Theorem 5.2. Finite look-aheads account for non-local but finite properties. The look-ahead we define basically re-traces the computation that the two-way transducer has taken so far. Note that this is indeed a finite property as only a prefix of the input has been visited by the computation of the two-way transducer. ◀

As an easy consequence of Theorem 3.1, let us observe that deterministic regular functions (effectively) preserve Büchi deterministic languages by inverse image. Analogue results hold for regular functions of finite (resp. infinite) words with regular languages.

► **Proposition 3.2.** *If $f : \Sigma^\omega \rightarrow \Gamma^\omega$ is deterministic regular and $L \subseteq \Gamma^\omega$ is Büchi deterministic, then $f^{-1}(L) \subseteq \Sigma^\omega$ is (effectively) Büchi deterministic.*

Proof. The function $f \circ \text{id}_L$ (where $\text{id}_L : \Gamma^\omega \rightarrow \Gamma^\omega$ is the identity function restricted to L) is deterministic regular. Its domain $f^{-1}(L)$ is Büchi deterministic by Proposition 2.11. ◀

Let us now focus on the converse of Theorem 3.1, i.e. showing that any deterministic regular function can be written as a composition of “basic” functions. As mentioned in introduction, regular functions of finite words can be written as compositions of `map-copy-reverse` (see Example 1.1) and sequential functions (computed by one-way transducers).

► **Theorem 3.3** ([6, Theorem 13]). *Over finite words, a function is regular if and only if it can (effectively) be written as a composition of `map-copy-reverse` and sequential functions.*

To state our similar result for deterministic regular functions of infinite words, we first recall formally the definition of sequential functions of infinite words.

► **Definition 3.4** (Sequential functions). *A deterministic one-way transducer is a 2-dT $(\Sigma, \Gamma, Q, q_0, F, \delta, \lambda)$ such that for all $q \in Q$ and $\sigma \in (\Sigma \uplus \{\vdash\})$, $\delta(q, \sigma)$ has shape $(_, \triangleright)$ (when defined). The class of (partial) functions over infinite words computed by one-way deterministic transducers is called sequential functions of infinite words.*

► **Example 3.5.** Any function that replaces some letter of its input by another letter is sequential. The functions `replace` and `map-copy-reverse` of Examples 2.3 and 1.4 are *not* sequential (this can be shown using a pumping argument). Observe that `replace` can be written as the composition of: a sequential function that replaces each $\sigma_i \in \{1, 2\}$ by $|\sigma_i|$, the function `map-copy-reverse`, and finally a sequential function that uses the first copy of each block to determine the value of σ_i , and transforms the (mirror) second copy accordingly.

Now, we state the decomposition result, that also uses `map-copy-reverse` from Example 2.3. Its proof is somehow technical and it illustrates once more the main difficulty of this paper: deterministic regular functions are not able to check many properties about the “future”.

► **Theorem 3.6.** *A function is deterministic regular if and only if it can (effectively) be written as a composition of `map-copy-reverse` and sequential functions of infinite words.*

Proof idea. In the case of finite words, the proofs of [7, 6] rely on Simon’s factorization forests theorem [27]. They first build a factorization forest, and then use its structure to simulate the runs of a transducer. Furthermore, over finite words, such forests can be computed by a *rational function*, which is a composition of sequential functions and `map-copy-reverse`. We follow a similar proof sketch for infinite words, but the main issue is that factorization forests can no longer be computed by a composition of sequential functions and `map-copy-reverse` (their structure may depend on regular properties of the input). Thus we use instead a weakened version of forests, introduced by Colcombet under the name of *forward Ramseyan splits* [11]. Such splits can be computed with a sequential function. Our new techniques show how to simulate the runs of a transducer by using a forward Ramseyan split. ◀

4 Guarded MSO-transductions

In this section, we define the logic MSO over finite and infinite words, as well as MSO-transductions, and its guarded fragment. We also state the logical characterization of deterministic regular functions (Theorem 4.8).

MSO on infinite words Infinite words over Σ are seen as structures of domain \mathbb{N} , over the signature $\mathcal{W}_\Sigma = \{S(x, y), (\sigma(x))_{\sigma \in \Sigma}\}$ which consists of the successor predicate $S(x, y)$, naturally interpreted as the successor over \mathbb{N} , and unary predicates $\sigma(x)$ for all $\sigma \in \Sigma$,

interpreted as the set of positions labelled σ . Given an infinite word $u \in \Sigma^\omega$, we denote by G_u the structure it induces, and just u when it is clear that u denotes the structure G_u .

Monadic second-order formulas are defined as first-order logic formulas, which can additionally use quantifiers $\exists X, \forall X$ over sets of positions, and membership atomic formulas of the form $x \in X$, where x is a first-order variable while X is a set variable. We denote by $\text{MSO}[\Sigma, S, \leq]$ (or just MSO when the predicates are clear from the context), the set of monadic second-order formulas over the word signature \mathcal{W}_Σ extended with the order predicate \leq (interpreted by the natural order on \mathbb{N}). It is well-known that the predicate \leq is syntactic sugar. The semantics is defined as expected (details can be found in [28, 13] for instance). For a formula ϕ with sets of free first-order and set variables \bar{x}, \bar{X} (we use the tuple notation which implicitly assumes an order between variables), we may write it $\phi(\bar{x}, \bar{X})$ to explicit the free variables of ϕ . We also denote by $\text{Free}(\phi)$ the free (first-order and set) variables of ϕ . Given a word w , an n -tuple of positions \bar{p} of w and an m -tuple \bar{P} of sets of positions of w , we write $w \models \phi(\bar{p}, \bar{P})$ to mean that the structure induced by w is a model of ϕ under assignments \bar{p} and \bar{P} .

► **Example 4.1.** The formula $\text{first}(x) = \forall y \cdot \neg S(y, x)$ is satisfied by any word and position x such that x is the first position to the left.

Over an alphabet Σ , any *closed* formula $\phi \in \text{MSO}$ defines a regular language $L_\phi = \{u \in \Sigma^\omega \mid u \models \phi\}$. By Büchi-Elgot-Trakhtenbrot's theorem [29, 8, 20], it is known MSO defines precisely the class of regular languages over alphabet Σ : for any language L over Σ , L is regular if and only if $L = L_\phi$ for some $\phi \in \text{MSO}$. MSO formulas can also be interpreted over finite word structures, whose domains are the (finite) set of word positions. It is also well-known that a language of finite words is regular iff it is MSO -definable.

MSO-transductions of infinite words MSO -transductions define transformations of graph structures, and have been studied in the context of finite words by Engelfriet and Hoogeboom in [21] (see also [13] for a more recent introduction to MSO -transductions). The main result of [21] is a Büchi-like theorem: a function of finite words is MSO -definable if and only if it is regular (i.e. recognizable by a deterministic two-way transducer). This result was then lifted to functions of infinite words in [3], but deterministic two-way transducers may need infinite look-aheads to capture the full expressive power of MSO -transductions.

In an MSO -transduction, the output word structure is defined via an MSO interpretation over a fixed number k of copies of the input word (seen as a structure). Therefore, the nodes of the output word are copies 1 to k of the nodes of the input word. Output nodes are pairs (i, c) (often denoted i^c), for every copy c and input node i .

The output label and successor predicates are defined by MSO formulas with one and two free first-order variables respectively, interpreted over the input structure. For instance, over the output alphabet $\Gamma = \{a, b\}$, to set all the output labels to a , one just specifies the formulas $\phi_a^c(x) = \top$ and $\phi_b^c(x) = \perp$ for all copies c . The output successor predicate relates input nodes of possibly different copies, and is therefore defined by formulas of the form $\phi_S^{c,d}(x, y)$, indexed by copies $c, d \in \{1, \dots, k\}$.

Finally, there is one distinguished copy c_0 together with a formula $\phi_{\text{fst}}^{c_0}(x)$, which must be satisfied by at most one node x . Intuitively, if the output structure is a word, this formula defines the first node of the output word. The domain of the output structure is composed of all nodes that can be reached from the initial node x^{c_0} by following multiple successor edges. In general, the output structure of an input word u by an MSO -transduction \mathcal{T} might not be an infinite word structure, in which case u is not in the domain of the function defined by \mathcal{T} .

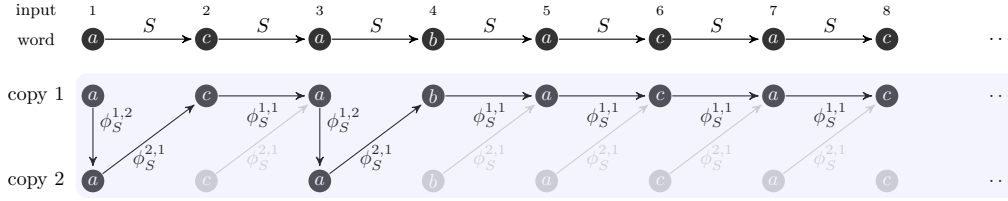

(a) Input and output structures of the MSO-transduction for the function double of Example 1.2 on input word $acab(ac)^\omega$

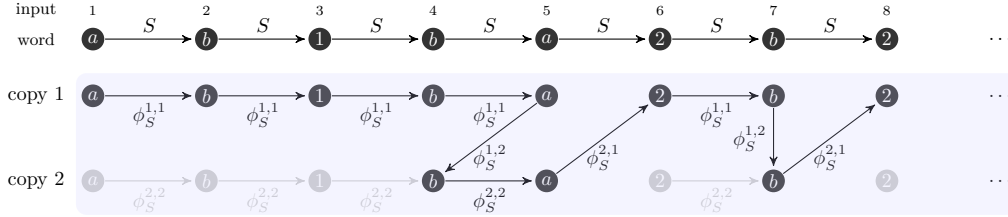

(b) Input and output structures of the MSO-transduction for the function copy of Example 1.3 on input word $ab1ba2b2\dots$

Formally, an *MSO-transduction* over an input alphabet Σ and output alphabet Γ is a tuple $\mathcal{T} = (k, (\phi_\gamma^c(x))_{1 \leq c \leq k, \gamma \in \Gamma}, (\phi_S^{c,d}(x, y))_{1 \leq c, d \leq k}, c_0, \phi_{\text{fst}}^{c_0}(x))$ where $k \in \mathbb{N} \setminus \{0\}$, $1 \leq c_0 \leq k$ and for all input $u \in \Sigma^\omega$, there is at most one position i such that $u \models \phi_{\text{fst}}^{c_0}(i)$. We may omit c_0 in the tuple above.

We now formally define the semantics of MSO-transductions. Let $u \in \Sigma^\omega$ and $N \subseteq \mathbb{N} \times \{1, \dots, k\}$. We first define the set of output nodes that can be reached from N in zero or more steps. We let $\text{Post}_u^0(N) = N$ and for all $\ell > 0$,

$$\text{Post}_u^\ell(N) = \{j^d \mid \exists i^c \in \text{Post}_u^{\ell-1}(N) \cdot u \models \phi_S^{c,d}(i, j)\} \text{ and } \text{Post}_u^*(N) = \bigcup_{\ell \geq 0} \text{Post}_u^\ell(N)$$

Given an MSO-transduction \mathcal{T} as above, and input word $u \in \Sigma^\omega$, the *output structure*, denoted $\mathcal{T}(u)$, is the structure over signature \mathcal{W}_Γ defined by the following interpretation:

- the domain is $D = \text{Post}_u^*(\{i^{c_0} \mid u \models \phi_{\text{fst}}^{c_0}(i)\})$ (note that the argument of Post_u^* is either empty or a singleton)
- a node $i^c \in D$ is labelled $\gamma \in \Gamma$ if $u \models \phi_\gamma^c(i)$
- a node j^d is a successor of a node i^c if $u \models \phi_S^{c,d}(i, j)$.

The output structure $\mathcal{T}(u)$ may not be a word structure. For instance, a node might have multiple labels, $\mathcal{T}(u)$ may contain cycles, or branching. So we restrict semantically the function defined by \mathcal{T} to word structures. Formally, the *function defined by \mathcal{T}* is the function $\llbracket \mathcal{T} \rrbracket : \Sigma^\omega \rightarrow \Gamma^\omega$ whose graph is:

$$\{(u, v) \in \Sigma^\omega \times \Gamma^\omega \mid G_v \text{ (the structure associated with } v) \text{ is isomorphic to } \mathcal{T}(u)\}$$

We denote by MSOT the set of MSO-transductions and say that a function $f : \Sigma^\omega \rightarrow \Gamma^\omega$ is MSOT-definable if $f = \llbracket \mathcal{T} \rrbracket$ for some $\mathcal{T} \in \text{MSOT}$.

► **Example 4.2.** We consider again the function double of Example 1.2, illustrated on Figure 1a and show how to define it with an MSO-transduction. Since some a must be duplicated, two copies are needed, so $k = 2$. Labels are preserved: $\phi_\sigma^c(x) = \sigma(x)$ for all $c \in \{1, 2\}$ and $\sigma \in \Sigma$. The first copy c_0 is 1, and $\phi_{\text{fst}}^{c_0}(x) = \text{first}(x)$. The successor formulas distinguish if there is a b in the future or not. First, from the 2nd to the 1st copy, there is always a

successor relation from a node to its successor in copy 1: $\phi_S^{2,1}(x, y) = S(x, y)$. There is a successor from x^1 to y^2 if $x = y$, x is labelled a and there is a b in the remaining infinite suffix starting at x : $\phi_S^{1,2}(x, y) = a(x) \wedge (x = y) \wedge \exists z \cdot x \leq z \wedge b(z)$. On the first copy, it depends on the label of the input: $\phi_S^{1,1}(x, y) = S(x, y) \wedge (a(x) \rightarrow (\forall z \geq x \cdot \neg b(z)))$. On the second copy, there is never a predicate edge: $\phi_S^{2,2} = \perp$. On Figure 1a, the interpretation of those formulas is depicted, in bold if they are part of the output word, in light grey otherwise. One can see that the output structure induced by all the descendants of the first node (by the transitive closure of the successor relation) is isomorphic to the structure $G_{aacaab(ac)^\omega}$.

The function `copy` of Example 1.3, illustrated in Figure 1b, is definable by an MSOT with two copies ($k = 2$). Formulas $\phi_{\text{fst}}^{c_0}$ and ϕ_σ^c are the same as for `double`. Then:

$$\begin{aligned} \phi_S^{1,1}(x, y) &= \phi_S^{2,2}(x, y) = S(x, y) \wedge \neg 2(y) & \phi_S^{2,1}(x, y) &= S(x, y) \wedge 2(y) \\ \phi_S^{1,2}(x, y) &= \exists \mathbf{g} \cdot y < x \leq \mathbf{g} \wedge 2(\mathbf{g}) \wedge \forall z \leq y \cdot (S(z, y) \rightarrow (1(z) \vee 2(z))) \wedge \\ & \quad \forall t \cdot (y \leq t \leq x) \rightarrow (a(t) \vee b(t)) \end{aligned}$$

The class of regular functions of infinite words has been defined in [3] as the class of functions recognizable by deterministic two-way transducers extended with regular (infinite) look-ahead: to take a transition, such a transducer can query a regular oracle on the infinite current suffix (given as a deterministic parity automaton for example). Equivalently, this class corresponds to functions recognizable by (deterministic) SST: they work as BSST but are not forced to output the content of a special register infinitely often. Instead, the output of a run depends on the set of states that are seen infinitely often along that run, and can be “computed” only once the infinite input has been processed (see [3]) for more details. The following provides a logical characterization of the class of regular functions:

► **Theorem 4.3** ([3]). *A function $f : \Sigma^\omega \rightarrow \Gamma^\omega$ is regular if and only if it is MSOT-definable.*

The definition of MSOT in [3] is slightly different, but equivalent, to the definition we take in this paper.

Guarded MSO-transductions of infinite words Guarded MSO formulas are a syntactical restriction of MSO formulas. This restriction requires all the free variables and quantifiers to be guarded by a first-order variable \mathbf{g} , in the sense that quantifiers should only talk about positions which are *before* \mathbf{g} (i.e. smaller than \mathbf{g}). Intuitively, the satisfiability of a guarded formula on an infinite word only depends on the finite prefix up to position \mathbf{g} . Formally, given two first-order variables x and \mathbf{g} , we let $\mathbf{G}(x, \mathbf{g})$ be the formula $x \leq \mathbf{g}$ (x is guarded by \mathbf{g}), and for a set variable X , we let $\mathbf{G}(X, \mathbf{g})$ be the formula $\forall x \in X, \mathbf{G}(x, \mathbf{g})$. Then, an MSO formula φ is *guarded by some variable \mathbf{g}* if it is equal to $\psi(\mathbf{g}) \wedge \bigwedge_{\alpha \in \text{Free}(\psi)} \mathbf{G}(\alpha, \mathbf{g})$ for some $\psi(\mathbf{g})$ such that all its quantified subformulas, i.e. subformulas of the form $QX \cdot \psi'$ or $Qx \cdot \psi'$ for some $Q \in \{\exists, \forall\}$, are in one of the following forms:

$$(1) \forall x \cdot \mathbf{G}(x, \mathbf{g}) \rightarrow \zeta \quad (2) \exists x \cdot \mathbf{G}(x, \mathbf{g}) \wedge \zeta \quad (3) \forall X \cdot \mathbf{G}(X, \mathbf{g}) \rightarrow \zeta \quad (4) \exists X \cdot \mathbf{G}(X, \mathbf{g}) \wedge \zeta$$

An MSO formula is *guarded* if it is of the form $\exists \mathbf{g} \cdot \varphi$ where φ is guarded by \mathbf{g} . We denote by MSO_g the set of guarded MSO-formulas. For conciseness, we may write $\forall x : \mathbf{g} \cdot \zeta$ instead of $\forall x \cdot \mathbf{G}(x, \mathbf{g}) \rightarrow \zeta$, and $\exists x : \mathbf{g} \cdot \zeta$ instead of $\exists x \cdot \mathbf{G}(x, \mathbf{g}) \wedge \zeta$ (and similarly for set variables).

► **Example 4.4.** All the formulas of the MSO-transduction of Example 4.2 defining the function `double` are guarded, or trivially equivalent to a guarded formula. For example, the formula `first(x)` is equivalent to the guarded formula $\exists \mathbf{g} \cdot x \leq \mathbf{g} \wedge \forall y \leq \mathbf{g} \cdot \neg S(y, x)$.

The order predicate $x \leq y$ is definable by the guarded formula $\exists \mathbf{g} \cdot x \leq \mathbf{g} \wedge y \leq \mathbf{g} \wedge y = \mathbf{g}$. Since $\neg(x \leq y)$ is equivalent to $y \leq x \wedge y \neq x$, we easily get that any MSO_g -formula ϕ is equivalent to an MSO_g -formula ψ in which the order predicate is only used to guard quantifiers, by existentially quantifying a global guard, guarding all the local guards used to define the atomic formulas of the form $z \leq t$ occurring in ϕ (assumed to occur positively).

► **Remark 4.5.** MSO_g formulas only talk about prefixes, in the following sense: If $\varphi = \exists \mathbf{g} \cdot \psi(\mathbf{g})$ is a closed guarded formula and $w \in \Sigma^\omega$, then $w \models \varphi$ if and only if there exists a finite prefix u of w such that $u \models \psi(\ell)$, where ℓ is the last position of u . This allows us to get the following immediate characterization: A language $L \subseteq \Sigma^\omega$ is MSO_g -definable if and only if there exists a regular language $F \subseteq \Sigma^*$ such that $L = F\Sigma^\omega$.

► **Definition 4.6** (Guarded MSO-transductions). *A guarded MSO-transduction (MSOT_g) is an MSO-transduction all formulas of which are guarded.*

► **Example 4.7.** As explained in Example 4.4, all formulas of the MSO-transduction of Example 4.2 defining `double` are guarded, or trivially equivalent to a guarded formula.

We can now state the logical characterization of deterministic regular functions:

► **Theorem 4.8** (Logical characterization). *A function $f : \Sigma^\omega \rightarrow \Gamma^\omega$ is deterministic regular if and only if it is MSOT_g -definable.*

The proof is given in Section 6. As an application of this result, since deterministic regular functions are (effectively) closed under composition by Theorem 3.1, we obtain that MSOT_g are (effectively) closed under composition as well. This is a well-known result for MSOT over finite strings [21], infinite strings [3] and more generally any structure [12], yet with purely logic-based and direct proofs, while we use here involved automata-based arguments (look-ahead removal). Indeed, composition closure of MSOT is obtained by formula substitutions. To compose two MSOT $\mathcal{T}_2 \circ \mathcal{T}_1$, the predicates occurring in \mathcal{T}_2 are substituted by their definition in \mathcal{T}_1 . Such a direct proof idea does not work in the guarded fragment MSOT_g , as guarded formulas are not closed under negation.

We conclude this section by discussing an alternative definition of MSO_g -transductions, denoted $\text{MSOT}_g[\leq]$, where instead of defining the output successor relation, it requires to define the total order \leq of the output structure with MSO_g formulas. This however allows to define non-computable functions, as stated by the following proposition proved in Appendix:

► **Proposition 4.9.** *There exists an $\text{MSOT}_g[\leq]$ which defines an uncomputable function.*

Without the guarded restriction, the two definitions both define the class of regular functions of infinite words.

5 Two-way transducers with finite look-ahead

We extend deterministic two-way transducers with finite look-ahead. Transitions are additionally labelled by a regular language of *finite words*, called (finite) look-ahead. A transition with look-ahead L can only be taken if the remainder of the input sequence has a prefix that belongs to L . Such a finite prefix is called a *look-ahead witness* for L . To ensure determinism, if several look-aheads succeed, it is required that there is a unique shortest look-ahead witness. The transducer follows the transition which minimizes the length of the witness. If no look-aheads succeed the computation fails.

► **Definition 5.1** (Finite look-ahead). A deterministic two-way transducer with finite look-ahead (2-dT^{FLA}) is a tuple $\mathcal{T} = (\Sigma, \Gamma, Q, q_0, F, \delta, \lambda)$ where $\Sigma, \Gamma, Q, q_0, F, \lambda$ are defined as for deterministic two-way transducers w/o look-ahead, δ is a transition function $Q \times (\Sigma \uplus \{\vdash\}) \times \mathcal{R}^*(\Sigma) \rightarrow Q \times \{\triangleright, \triangleleft\}$ where $\mathcal{R}^*(\Sigma)$ is the set of all regular languages of finite words over Σ . The function δ is required to have finite domain. The look-ahead for a transition $(q, \sigma, L) \mapsto (q, d)$ is L . Furthermore, we require that if $\delta(q, \sigma, L)$ and $\delta(q, \sigma, L')$ are defined, then $L \cap L' = \emptyset$ for all $L, L' \in \mathcal{R}^*(\Sigma)$, $q \in Q$ and $\sigma \in \Sigma$. Finally, it is assumed that the look-ahead languages are represented by deterministic finite automata.

The semantics of a deterministic two-way transducer with finite look-ahead remains unchanged compared to the model without look-ahead. The only difference in the presence of look-ahead is when a transition is enabled: A transition with look-ahead L can only be taken if the remainder of the input sequence has a prefix that belongs to L . Formally, in a configuration (q, i) over input u , a transition of the form $\delta(q, \sigma, L)$ where $L \subseteq \Sigma^*$ is enabled if $u[i] = \sigma$ and there exists some $i < j$ such that $u[i+1:j] \in L$. The word $u[i+1:j]$ is called a *witness* for L . To ensure determinism, whenever the transducer is in a configuration (q, i) , if several look-aheads L_1, \dots, L_k are enabled, the triggered transition is the unique (ensured by the disjointness requirement) transition with shortest witness.

Removing finite look-ahead We know that infinite look-ahead is strictly more expressive than finite look-ahead. The natural question is how much expressiveness is gained by adding finite look-ahead to deterministic two-way transducers w/o look-ahead. As already explained in the introduction, any function defined by such a transducer is (Turing machine) computable: A Turing machine can memorize where it is in the input, verify which look-ahead succeeds, and continue the computation from the memorized position. A two-way transducer does not have the ability to memorize a position arbitrarily far away in the input. Hence, verifying (in the absence of some look-ahead “oracle”) that some finite prefix of the remainder of the input is a witness for some look-ahead and returning to a specific position becomes a problem to be solved. This problem is not unique to two-way transducers over infinite words, it also appears when some regular property of the remainder of a finite input word must be checked and subsequently the two-way transducer must return to the position it has been in before checking the property. On finite words, this task can be handled using the Hopcroft-Ullman [1] or the improved tree-outline construction [15]. However, these constructions rely on the fact that the input word is finite. We prove that this task can be also accomplished for infinite words using different techniques.

In the following, we show that no expressiveness is gained by allowing finite look-ahead.

► **Theorem 5.2** (Finite look-ahead removal). *Given a 2-dT^{FLA} , one can effectively construct an equivalent 2-dT .*

Proof sketch. The proof is divided into two parts. The main part is to translate a given 2-dT^{FLA} into an equivalent BSST with bounded copy. We then use Theorem 2.9 to obtain an equivalent 2-dT . Given a deterministic two-way transducer *without* look-ahead, the standard approach to obtain an equivalent SST is to simulate the right-to-right runs of the deterministic two-way transducer on the so-far read prefix of the infinite input, store their outputs in registers and compose these registers in the right way (with the output of the “main” left-to-right run) to re-create the output of the two-way transducer. Since the two-way transducer is deterministic there is a global bound on the number of different right-to-right runs on any prefix of the input. The constructions presented in [3, 16, 9] are all built on this idea. In

[2], equivalence between SST and two-way transducers on finite words is shown but the work exhibits no direct translation.

Our goal is to design a similar construction for deterministic two-way transducers *with* finite look-ahead. The main difficulty is that there is no global bound on the number of different runs that can occur on a prefix. The reason is that such a transducer is non-deterministic in the sense that it must make a decision which look-ahead will succeed. This choice is verified a posteriori when a look-ahead witness is seen.

Hence, we extend the standard construction to go from a deterministic two-way transducer to an SST by additionally taking the look-ahead choices into account. This approach results in a tree structure representation of the possible runs (similar to a standard run-tree of a non-deterministic automaton, here the non-determinism is the look-ahead choice). A branch in such a tree corresponds to a possible run and the nodes additionally contain information to detect when look-ahead choices succeed or are doomed to fail. The size of the tree representations is kept bounded by sharing information and a relevant pruning strategy. The strategy takes care of removing branches whose look-ahead choices *cannot succeed* and (prefixes of) branches where the look-ahead choices *already have succeeded*. Applying this construction to a deterministic two-way transducer without look-ahead yields the standard translation construction. ◀

6 Logic-transducer correspondence: proof of Theorem 4.8

In this section, we give an overview of the proof of the logical characterization of Theorem 4.8. We first prove that any deterministic regular function is MSOT_g -definable. The proof is standard and uses same ideas as for regular functions of finite words [21] and infinite words [3].

► **Lemma 6.1.** *If a function $f : \Sigma^\omega \rightarrow \Gamma^\omega$ is deterministic regular, then it is MSOT_g -definable.*

Proof. The main idea is to define in MSOT_g the runs of a 2-dT. Each copy of the MSOT_g represents a state of the 2-dT, and there is a successor edges between node x^p to node y^q , where x, y are input positions and p, q are states, if and only if there exists a *finite* run from configuration (p, x) to configuration (q, y) which produces output symbols only in configuration (p, x) and (q, y) . This property can be expressed by an MSO_g formula. ◀

Proving the converse of Lemma 6.1 is more involved. We first go to an intermediate model with MSO instructions, in the spirit of [21], called *jumping* MSO_g -transducers, proved to be equivalent to 2-dT. It is a finite-state model which can (i) test MSO_g properties of the current position (called look-around), (ii) test safety constraints defined by MSO formulas, and (iii) jump from one position to another one with binary MSO_g formulas. Formally, it has a finite set of states (all final), and transitions are of the form $p \xrightarrow{\phi_{\text{la}}(x)|w, \phi_{\text{mv}}(x, y), \phi_{\text{sf}}(x)} q$ where p, q are states, $\phi_{\text{la}}, \phi_{\text{mv}}$ are MSO_g formulas, ϕ_{sf} is an MSO formula, and w is a finite word. Look-around occurring on transitions with same source state are assumed to be pairwise disjoint (their conjunction is not satisfiable). The initial configuration is $(q_0, 0)$ where q_0 is the initial state. Whenever it is in a configuration (q, i) , over an infinite word $u \in \Sigma^\omega$, it enables the transitions whose look-around $\phi_{\text{la}}(i)$ holds on u , and select the transition with shortest witness. Call t this transition. It triggers t only if there exists j such that $\phi_{\text{mv}}(i, j)$ holds and for all $k \geq i$, $u[k] \models \phi_{\text{sf}}(i)$ (otherwise the computation fails). It then outputs γ and moves to some position j such that $\phi_{\text{mv}}(i, j)$ holds. Note that there could be several j , and therefore several runs on the same input in general. We thus make the following *assumption*, which

can be described informally as follows: for any reachable configuration of the transducer from the initial configuration, there is always a unique j . Formally, for all infinite sequence of configurations $(q_0, i_0 = 0)(q_1, i_1)(q_2, i_2) \dots$, for all $k \geq 0$, for any transition t triggered from configuration (q_k, i_k) to (q_{k+1}, i_{k+1}) , if $\phi_{\text{mv}}(x, y)$ is the jumping formula of t , then i_{k+1} is the unique position such that $\phi_{\text{mv}}(i_k, i_{k+1})$ holds. As for two-way transducers, a sequence of configurations $(q_0, i_0 = 0)(q_1, i_1) \dots$ is *accepting* if $\lim_{k \rightarrow \infty} i_k = \infty$ and it produces an infinite word.

We show that this model defines deterministic regular functions:

► **Lemma 6.2.** *Any jumping MSO_g -transducer defines a deterministic regular function.*

Sketch of proof. The proof goes in two steps. First, it is shown that jumping MSO_g -transducers are equivalent to *walking* MSO_g -transducers, i.e. MSO_g -transducers which moves (backward or forward) between successive positions. This step is standard (it appears e.g. in [21] in the non-guarded setting). Then, walking MSO_g -transducers are shown to be equivalent to an extension of 2-dT with finite look-around and safety constraints, then proved to be equivalent to 2-dT by transforming look-arounds into look-aheads, and then removing look-aheads (based on the techniques of Section 5) and safety constraints. ◀

► **Lemma 6.3.** *Any MSO_g -transduction is equivalent to a jumping MSO_g -transducer.*

Proof. Let $\mathcal{T} = (k, (\phi_\gamma^c)_{c \in [k], \gamma \in \Gamma}, (\phi_S^{c,d})_{c,d \in [k]}, \phi_{\text{fst}}^{c_0}(x))$ be an MSOT_g defining f . We construct a jumping MSO_g -transducer \mathcal{T}' equivalent to \mathcal{T} . The set of states of \mathcal{T}' is $\{0, 1, \dots, k\}$. In state 0, \mathcal{T}' first jumps to the initial position, i.e. the position y which satisfies $\phi_{\text{fst}}^{c_0}(y)$ and moves to state c_0 . This is done by a transition going from state 0 to state c_0 , with the trivial look-around and safety constraint \top , and the move $\phi_{\text{mv}}(x, y) := \text{first}(x) \wedge \phi_{\text{fst}}^{c_0}(y)$. Then, it follows the successor relation of \mathcal{T} , and uses the label formulas to determine which label to output. Using safety constraints, \mathcal{T}' also makes sure that the output graph structure is a word structure. In particular, they express that for any reachable node, there is exactly one label and at most one successor. There is no need to check that there is *at least* one successor, because if there is none, then the run of \mathcal{T}' stops and the input is not accepted, which is consistent with the semantics of \mathcal{T} (the input is also rejected by \mathcal{T} in that case). There is also no need to check that there is no cycle, because if there is some, then \mathcal{T}' will never visit all input positions, and hence the input will be rejected, which is again consistent with the semantics of \mathcal{T} . Formally, for all copies $c, d \in \{1, \dots, k\}$ and output label γ , since $\phi_S^{c,d}(x, y)$ and $\phi_\gamma(x)$ are guarded, there are of the form $\phi_S^{c,d}(x, y) = \exists \mathbf{g} \cdot \psi_S(x, y, \mathbf{g})$ and $\phi_\gamma(x) = \exists \mathbf{g} \cdot \psi_\gamma(x, \mathbf{g})$. Then we add the following transition to \mathcal{T}' , from c to d :

$$c \xrightarrow{\phi_{\text{la}}(x) := \exists \mathbf{g} \exists z \leq \mathbf{g} \cdot \psi_S^{c,d}(x, z, \mathbf{g}) \wedge \psi_\gamma^c(x, \mathbf{g}) \wedge \text{disj}_{c,d,\gamma}(x, \mathbf{g}) \mid \gamma, \phi_{\text{mv}}(x, y) := \phi_S^{c,d}(x, y), \phi_{\text{sf}}(x)} d$$

in which $\text{disj}_{c,d,\gamma}(x, \mathbf{g}) = \forall \mathbf{g}' \leq \mathbf{g} \cdot \bigwedge_{\gamma' \neq \gamma} \neg \psi_{\gamma'}^c(x, \mathbf{g}') \wedge \bigwedge_{d' \neq d} \forall z' \leq \mathbf{g}' \cdot \neg \psi_S^{c,d'}(x, z', \mathbf{g}')$ ensures disjointness of the look-around, and $\phi_{\text{sf}}(x)$ equals

$$\begin{aligned} & (\bigwedge_{d' \neq d} \forall y \cdot \neg \phi_S^{c,d'}(x, y)) \wedge && \text{no successor of } x \text{ in any copy } d' \neq d \\ & (\forall y \forall y' \cdot (\phi_S^{c,c}(x, y) \wedge \phi_S^{c,c}(x, y')) \rightarrow y = y') \wedge && \text{at most one successor of } x \text{ in copy } c \\ & (\bigwedge_{\gamma' \neq \gamma} \neg \phi_{\gamma'}^c(x)) && \text{no other label for } x \end{aligned}$$

At this point, we remind the reader that safety constraints are not required to be defined by guarded formulas, as they are regular properties of finite words. However, the look-around and jumping formulas must be guarded, and it is indeed the case in the transition above.

Finally, note that \mathcal{T}' satisfies the requirement that on infinite sequences of configurations $(q_0, i_0) \dots$, for all $k \geq 0$, i_{k+1} is the unique successor of i_k by the jumping formula. Indeed, if a sequence of configurations of \mathcal{T}' is infinite, it implies that all safety constraints are satisfied, and they precisely make sure that there is no branching. ◀

As a corollary of Lemmas 6.3 and 6.2, we obtain the converse direction of Theorem 4.8:

► **Corollary 6.4.** *Any MSOT_g -definable function f is deterministic regular.*

7 Conclusion

In this paper, we have shown that the class of deterministic regular functions is characterized by computational models such as deterministic two-way transducers, deterministic two-way transducers with *finite* (regular) look-aheads, Büchi SST, by the logical formalism of *guarded* MSO-transductions, and by finite compositions of sequential functions and `map-copy-reverse`. The transformations between those models are effective. We have also shown that it is closed under composition, by extending to infinite words the known composition closure of deterministic two-way transducers, yet with new proof techniques. It is also conjectured that the class of deterministic regular functions is equal to the class of *continuous* regular functions (for the Cantor topology). It is already known that it includes the continuous letter-to-letter rational functions [22] and the strictly larger class of continuous rational functions [9]. We believe that the new characterizations proved in this paper, will be helpful towards solving this open and seemingly difficult problem. All this, together with the fact that deterministic regular functions are computable, unlike regular functions, shows the robustness of this class.

References

- 1 Alfred V. Aho, John E. Hopcroft, and Jeffrey D. Ullman. A general theory of translation. *Mathematical Systems Theory*, 3(3):193–221, 1969.
- 2 Rajeev Alur and Pavol Cerný. Expressiveness of streaming string transducers. In *IARCS Annual Conference on Foundations of Software Technology and Theoretical Computer Science, FSTTCS 2010*, volume 8 of *LIPICs*, pages 1–12. Schloss Dagstuhl, 2010.
- 3 Rajeev Alur, Emmanuel Filiot, and Ashutosh Trivedi. Regular transformations of infinite strings. In *Proceedings of the 27th Annual IEEE Symposium on Logic in Computer Science, LICS 2012*, pages 65–74. IEEE Computer Society, 2012.
- 4 Rajeev Alur, Adam Freilich, and Mukund Raghothaman. Regular combinators for string transformations. In *Proceedings of the Joint Meeting of the Twenty-Third EACSL Annual Conference on Computer Science Logic (CSL) and the Twenty-Ninth Annual ACM/IEEE Symposium on Logic in Computer Science (LICS)*, page 9. ACM, 2014.
- 5 Nicolas Baudru and Pierre-Alain Reynier. From two-way transducers to regular function expressions. In *International Conference on Developments in Language Theory*, pages 96–108. Springer, 2018.
- 6 Mikołaj Bojańczyk and Rafał Stefański. Single-use automata and transducers for infinite alphabets. In *47th International Colloquium on Automata, Languages, and Programming (ICALP 2020)*. Schloss Dagstuhl-Leibniz-Zentrum für Informatik, 2020.
- 7 Mikołaj Bojańczyk. Polyregular Functions, 2018. URL: <https://arxiv.org/abs/1810.08760>, doi:10.48550/ARXIV.1810.08760.
- 8 J. R. Büchi. Weak second-order arithmetic and finite automata. *Zeitschrift für Mathematische Logik und Grundlagen der Mathematik*, 6(1–6):66–92, 1960.

- 9 Olivier Carton and Gaëtan Douéneau-Tabot. Continuous rational functions are deterministic regular. In *47th International Symposium on Mathematical Foundations of Computer Science, MFCS 2022*, 2022.
- 10 Michal P. Chytil and Vojtěch Jákl. Serial composition of 2-way finite-state transducers and simple programs on strings. In *4th International Colloquium on Automata, Languages, and Programming, ICALP 1977*, pages 135–147. Springer, 1977.
- 11 Thomas Colcombet. A combinatorial theorem for trees. In *34th International Colloquium on Automata, Languages, and Programming, ICALP 2007*, 2007.
- 12 Bruno Courcelle. Monadic second-order definable graph transductions: A survey. *Theor. Comput. Sci.*, 126:53–75, 1994.
- 13 Bruno Courcelle and Joost Engelfriet. *Graph structure and monadic second-order logic: a language-theoretic approach*, volume 138. Cambridge University Press, 2012.
- 14 Luc Dartois, Emmanuel Filiot, and Nathan Lhote. Logics for word transductions with synthesis. In *Proceedings of the 33rd Annual ACM/IEEE Symposium on Logic in Computer Science*, pages 295–304. ACM, 2018.
- 15 Luc Dartois, Paulin Fournier, Ismaël Jecker, and Nathan Lhote. On reversible transducers. In *44th International Colloquium on Automata, Languages, and Programming, ICALP 2017*, volume 80 of *LIPICs*, pages 113:1–113:12. Schloss Dagstuhl, 2017.
- 16 Luc Dartois, Ismaël Jecker, and Pierre-Alain Reynier. Aperiodic string transducers. *Int. J. Found. Comput. Sci.*, 29(5):801–824, 2018.
- 17 Vrunda Dave, Emmanuel Filiot, Shankara Narayanan Krishna, and Nathan Lhote. Synthesis of computable regular functions of infinite words. In *31st International Conference on Concurrency Theory (CONCUR 2020)*. Schloss Dagstuhl-Leibniz-Zentrum für Informatik, 2020.
- 18 Vrunda Dave, Emmanuel Filiot, Shankara Narayanan Krishna, and Nathan Lhote. Synthesis of computable regular functions of infinite words. *Log. Methods Comput. Sci.*, 18(2), 2022.
- 19 Vrunda Dave, Paul Gastin, and Shankara Narayanan Krishna. Regular transducer expressions for regular transformations. In *Proceedings of the 33rd Annual ACM/IEEE Symposium on Logic in Computer Science*, pages 315–324. ACM, 2018.
- 20 C. C. Elgot. Decision problems of finite automata design and related arithmetics. In *Transactions of the American Mathematical Society*, 98(1):21–51, 1961.
- 21 Joost Engelfriet and Hendrik Jan Hooeboom. MSO definable string transductions and two-way finite-state transducers. *ACM Transactions on Computational Logic (TOCL)*, 2(2):216–254, 2001.
- 22 Emmanuel Filiot and Sarah Winter. Synthesizing computable functions from rational specifications over infinite words. In *41st IARCS Annual Conference on Foundations of Software Technology and Theoretical Computer Science, FSTTCS 2021, December 15-17, 2021, Virtual Conference*. Schloss Dagstuhl - Leibniz-Zentrum für Informatik, 2021.
- 23 Erich Grädel. On the restraining power of guards. *J. Symb. Log.*, 64(4):1719–1742, 1999.
- 24 Eitan M Gurari. The equivalence problem for deterministic two-way sequential transducers is decidable. *SIAM Journal on Computing*, 11(3):448–452, 1982.
- 25 Dominique Perrin and Jean-Éric Pin. *Infinite words: automata, semigroups, logic and games*. Academic Press, 2004.
- 26 J. C. Shepherdson. The reduction of two-way automata to one-way automata. *IBM Journal of Research and Development*, 3(2):198–200, 1959. doi:10.1147/rd.32.0198.
- 27 Imre Simon. Factorization forests of finite height. *Theor. Comput. Sci.*, 72(1):65–94, 1990. doi:10.1016/0304-3975(90)90047-L.
- 28 Wolfgang Thomas. Languages, automata, and logic. In *Handbook of formal languages*, pages 389–455. Springer, 1997.
- 29 Boris Avraamovich Trakhtenbrot. Finite automata and logic of monadic predicates (in Russian). *Dokl. Akad. Nauk SSSR*, 140:326–329, 1961.

A Decomposition: proof of Theorem 3.6

In this section, we show that a function is deterministic regular if and only if it can be (effectively) written as a composition of sequential and map-copy-reverse functions. The right-to-left implication is clear, since deterministic regular functions are closed under composition (Theorem 3.1) and the sequential and map-copy-reverse functions are deterministic regular. It remains to show how a deterministic regular function can be decomposed using these basic functions, and this is the purpose of the current Appendix A.

A.1 A class of functions closed under composition

We first introduce a class of functions \mathcal{C} which is closed under composition and goes both from finite words to finite words and infinite words to infinite words (i.e. of type $(\Sigma^* \rightarrow \Gamma^*) \cup (\Sigma^\omega \rightarrow \Gamma^\omega)$). Our goal is to show that any deterministic regular function can be computed as the restriction of a function of \mathcal{C} to infinite words. However, in the proof we sometimes need to apply these functions to either finite or infinite words. Indeed, we shall build a “map” operation working on finite or infinite factors of a given word, and for which there is no way to “decide” at runtime if the current factor is finite or infinite.

Recall that one-way transducers and sequential functions over infinite words have been presented in Definition 3.4. We generalize this definition in order to be able compute *with the same machine* both over finite and infinite words.

► **Definition A.1** (Sequential functions of finite and infinite words). A deterministic one-way transducer over finite and infinite words is a tuple $(\Sigma, \Gamma, Q, q_0, F_*, F_\omega, \delta, \lambda)$ such that:

- $(\Sigma, \Gamma, Q, q_0, F_\omega, \delta, \lambda)$ is a one-way deterministic transducer over infinite words;
- $(\Sigma, \Gamma, Q, q_0, F_*, \delta, \lambda)$ is a one-way deterministic transducer over finite words, that is $F_* : Q \rightarrow \Gamma^*$ is a final output function. The output over a finite input defined over finite words by concatenating the output produced along a run and adding $F_*(q)$ (if defined, otherwise the output is undefined) where q is the last state of the run.

Such a machine describes a function of type $(\Sigma^* \rightarrow \Gamma^*) \cup (\Sigma^\omega \rightarrow \Gamma^\omega)$. The class of (partial) functions computed by one-way deterministic transducers over finite and infinite words is called sequential functions of finite and infinite words.

► **Remark A.2.** It is essential to have the *same* transducer that defines *both* the function over finite words and the function over infinite words.

► **Definition A.3.** The class \mathcal{C} of functions of type $(\Sigma^* \rightarrow \Gamma^*) \cup (\Sigma^\omega \rightarrow \Gamma^\omega)$ is the closure under composition of the following functions:

- sequential functions over finite and infinite words;
- for any fresh symbol $| \notin \Sigma$ the function map-copy-reverse : $((\Sigma \uplus \{| \})^* \rightarrow (\Sigma \uplus \{| \})^*) \cup ((\Sigma \uplus \{| \})^\omega \rightarrow (\Sigma \uplus \{| \})^\omega)$ defined for $u_i \in \Sigma^*$ by:
 - $u_1 | \cdots | u_n \mapsto u_1 | \widetilde{u_1} | \cdots | u_n | \widetilde{u_n}$ when the input is finite;
 - $u_1 | \cdots | u_i | \cdots \mapsto u_1 | \widetilde{u_1} | \cdots | u_i | \widetilde{u_i} | \cdots$ if the infinite input contains infinitely many $|$;
 - $u_1 | \cdots | u_n | u \mapsto u_1 | \widetilde{u_1} | \cdots | u_n | \widetilde{u_n} | u$ if $u \in \Sigma^\omega$

► **Remark A.4.** If the context is not clear, we shall say that map-copy-reverse “has separator $|$ ” to mean that the symbol $|$ is used to separate the factors.

Let us now describe some properties of this class \mathcal{C} .

► **Example A.5.** The (total) function map-copy : $(\Sigma \uplus \{| \})^\infty \rightarrow (\Sigma \uplus \{| \})^\infty$ is defined in a similar way as map-copy-reverse from Definition A.3, except that each copy mirror factor

\tilde{u}_i is replaced by a simple copy of u_i . This function `map-copy` belongs to \mathcal{C} . Indeed, we apply `map-copy-reverse` twice, which outputs a word of shape $u_1|\widehat{u}_1|\widehat{u}_1|u_1|u_2 \cdots$. It is easy to remove the useless pieces using a sequential function.

► **Remark A.6.** One can also define the function `map-reverse` where each factor is only reversed but not copied before. However, this function cannot be defined on infinite words with finitely many $|$ symbols (and not even extended to a continuous function with total domain).

Finally, we show that the class \mathcal{C} is closed under a “map” operation, that applies a given function to the factors of a word delimited by a specific symbol. We give in Lemma A.7 a more precise statement, that enables us to apply different functions on the first factors.

► **Lemma A.7.** *Let $f_1, f_2, \dots, f_n : \Sigma^\infty \rightarrow \Gamma^\infty \in \mathcal{C}$ and $|$ be a fresh symbol. One can effectively build in \mathcal{C} a function $[f_1|f_2| \cdots |f_n] : (\Sigma \uplus \{| \})^\infty \rightarrow (\Gamma \uplus \{| \})^\infty$ such that:*

$$[f_1|f_2| \cdots |f_n](u_1|u_2 \cdots) = f_1(u_1)|f_2(u_2)| \cdots |f_n(u_n)|f_n(u_{n+1})|f_n(u_{n+2}) \cdots$$

whenever $u_1 \in \text{Dom}(f_1), u_2 \in \text{Dom}(f_2), \dots$

► **Remark A.8.** Several elements are left implicit in the formulation of Lemma A.7:

- if there are $k \leq n$ factors in the input, then $[f_1| \cdots |f_n]$ only applies f_1, \dots, f_k ;
- the last factor (if it exists) can be infinite;
- if the input is infinite, we must have $f_1(u_1)|f_2(u_2)|f_3(u_3) \cdots \in (\Gamma \uplus \{| \})^\omega$ for the output to be defined.

Proof. We only treat the case $n = 1$, which corresponds to the classical “map” operation. The other cases can be treated in a similar way, using sequential functions to drop specific marks on the n first pieces. Let $f := f_1$. We show the result by induction on the construction of f . If f is a sequential function then we build a sequential function $[f|]$ described by a one-way transducer similar to that of f does, except if a $|$ is seen, in which case it produces the (finite) final output of the transducer in the current state, and goes back to the initial state to pursue its computation. If $f = g \circ h$ the result is clear by induction hypothesis. If f is `map-copy-reverse` with separator $\#$ (necessarily $\# \neq |$), we apply the sequential function that turns each $|$ into $|\#$. Then we apply `map-copy-reverse` with separator $\#$ on the whole input. We conclude by applying a sequential function that removes the $||$ factor each times it sees one, and in this case replaces the next $\#$ by a $|$. ◀

A.2 Forward Ramseyan splits

Now, we show how to decompose a deterministic regular function as a function of \mathcal{C} . Following the decomposition results for regular [7] or polyregular [6] functions over finite words, our first goal is to split the input using a structure that is similar to Simon’s factorization forests [27]. Indeed, the runs of a two-way transducer behave in a simple way on such splits. We present in Definition A.9 a weakened version of factorization forests, named *forward Ramseyan splits* and introduced by Colcombet in [11]. We shall recall Colcombet’s main result in Theorem A.12: such splits can be computed by a sequential function.

If Σ is an alphabet, we consider an infinite number of fresh symbols $|_1, |_2, \dots \notin \Sigma$. For all $k \geq 0$, we define the alphabet $\Delta_k := \{|_1, \dots, |_k\}$.

► **Definition A.9** (Forward Ramseyan split [11]). *Let $\mu : \Sigma^* \rightarrow M$ be a morphism into a finite monoid and $k \geq 0$. Let $u \in \Sigma^\infty$. We say that a word $\mathfrak{s} \in (\Sigma \uplus \Delta_k)^\infty$ is a forward Ramseyan μ -split over u of height $k \geq 0$ if it can be defined by induction as follows:*

- either $k = 0$ and $\mathfrak{s} = u = a \in \Sigma$ or $\mathfrak{s} = u = \varepsilon$;
- or $\mathfrak{s} = \mathfrak{s}_1|_k \cdots |_k \mathfrak{s}_n$ where $u = u_1 \cdots u_n$, for all $1 \leq i \leq n$, \mathfrak{s}_i is a μ -split of height $k-1$ of $u_i \in \Sigma^\infty \setminus \{\varepsilon\}$, and for all $1 \leq i, j < n$ $\mu(u_i)\mu(u_j) = \mu(u_i)$ (note that $u_i, u_j \in \Sigma^+$);
- or $\mathfrak{s} = \mathfrak{s}_1|_k \cdots |_k \mathfrak{s}_i|_k \cdots$ where $u = u_1 \cdots u_i \cdots \in \Sigma^\omega$, for all $1 \leq i$, \mathfrak{s}_i is a μ -split of height $k-1$ of $u_i \in \Sigma^+$, and for all $1 \leq i, j$, $\mu(u_i)\mu(u_j) = \mu(u_i)$.

► **Remark A.10.** In particular the condition $\mu(u_i)\mu(u_j) = \mu(u_i)$ implies that $\mu(u_i)$ is an idempotent. Furthermore, it means that the $\mu(u_i)$ are \mathcal{L} -equivalent in the sense of Greene's relations (see e.g. [11]). In Simon's usual factorization forests (also known as Ramseyan μ -splits), the condition is stronger: $\mu(u_i) = \mu(u_i)^2 = \mu(u_j)$ (i.e. the idempotents are equal).

► **Remark A.11.** In the second case, there is no assumption on the value $\mu(u_n)$, even if $u_n \in A^+$. In particular, if $n = 2$ there is no assumption on $\mu(u_2)$.

From now on, the morphism μ will always be implicitly fixed, and we denote by $\text{FRS}_k(u)$ the set of μ -splits of height at most $k \geq 0$ over the word $u \in \Sigma^\infty$.

► **Theorem A.12** ([11, Theorem 1]). *Let $\mu : \Sigma^* \rightarrow M$ be a morphism into a finite monoid. There exists a bound N and a sequential function $\text{split} : \Sigma^\omega \rightarrow (\Sigma \cup \Delta_k)^\omega$ such that for all $u \in \Sigma^\omega$, $\text{split}(u) \in \text{FRS}_N(u)$. The construction is effective.*

A.3 Transition monoid of a two-way transducer

The goal of this section is to recall the well-known notion of *transition morphism* μ of a two-way transducer (see e.g. [19]) and to relate it to forward Ramseyan μ -splits. In the rest of Appendix A, we consider a fixed deterministic two-way transducer $\mathcal{T} = (\Sigma, \Gamma, Q, q_0, F, \delta, \lambda)$. We let $\overleftarrow{Q} := \{\overleftarrow{q} : q \in Q\}$ and $\overrightarrow{Q} := \{\overrightarrow{q} : q \in Q\}$ be two disjoint copies of Q . To simplify the notations, we assume without losing generalities that $\vdash \in \Sigma$.

Recall that the transition function δ has type $Q \times \Sigma \rightarrow Q \times \{\leftarrow, \triangleright\}$. We extend the transition function to $\delta : \overrightarrow{Q} \cup \overleftarrow{Q} \times \Sigma^* \rightarrow \overrightarrow{Q} \cup \overleftarrow{Q}$ and similarly $\overrightarrow{Q} \cup \overleftarrow{Q} \times \Sigma^* \rightarrow \Gamma^*$. Intuitively, $\delta(\overleftarrow{q}, u) = \overrightarrow{p}$ and $\lambda(\overleftarrow{q}, u) = v$ means that the longest run over u that starts in the rightmost position of u will eventually leave u “on the right” in state p , and the concatenation of its output is v . We assume that $\delta(_, \varepsilon)$ is the identity function and that $\lambda(_, \varepsilon) = \varepsilon$. Finally, we also extend δ to infinite words $u \in \Sigma^\omega$ by defining $\delta(\overrightarrow{q}, u) := \overleftarrow{p}$ if the longest run leaves u “on the left” and $\delta(\overrightarrow{q}, u) := \omega$ if this run is infinite and visits arbitrary large positions. Note that $\delta(\overleftarrow{q}, u)$ would not make sense. The function λ is extended accordingly.

The following result is folklore about two-way transducers (over finite words, but it does not change anything since we deal with transitions on finite words here).

► **Proposition A.13** (Transition morphism, see e.g. [19]). *One can effectively build a finite monoid M and a morphism $\mu : \Sigma^* \rightarrow M$, called the transition morphism of \mathcal{T} , such that for all $u \in \Sigma^*$ and $\overline{q} \in \overrightarrow{Q} \cup \overleftarrow{Q}$, $\delta(\overline{q}, u)$ only depends on \overline{q} and $\mu(u)$.*

From now on, $\mu : \Sigma^* \rightarrow M$ is assumed to be the transition morphism of \mathcal{T} . Now, we show that along a forward Ramseyan μ -split built, the runs of \mathcal{T} can be described in a rather simple way. This result is inspired by analog results for factorization forests over finite words (see e.g. [7, Lemma 6.8]), but the current result is weaker due to the fact that our μ -splits are weaker than factorization forests (see Remark A.10). The runs ρ_1, ρ_2, \dots mentioned in Lemma A.14 are depicted in Figure 2.

► **Lemma A.14** (Runs and forward Ramseyan splits). *Let $k \geq 1$, $u = u_1 u_2 \cdots \in \Sigma^\infty$ and $\mathfrak{s} = \mathfrak{s}_1|_k \mathfrak{s}_2 \cdots \in \text{FRS}_k(u)$ be a μ -split following the factorization u_1, u_2, \dots . Assume that*

$\delta(\vec{q}, u_1) = \vec{p}$. Let ρ be the longest (finite or infinite) run of \mathcal{T} along u that starts in configuration $(q, 1)$. Then ρ can be factored under the form $\rho = \rho_1 \rightarrow \rho_2 \rightarrow \dots$ where:

1. for all $i \geq 1$ such that u_i is defined, ρ_i starts in the first configuration of ρ that visits u_i ;
2. for all $i \geq 2$, ρ_i begins with a configuration of the form $(p, _)$ (i.e. it starts in \vec{p});
3. for all $i \geq 2$ such that u_{i+1} is defined, ρ_i only visits the positions of u_i and u_{i-1} (it cannot go back to u_{i-2}).

Proof. We have $\delta(\vec{q}, u_1) = \vec{p}$. For all $i \geq 2$ such that u_i is defined, we must have finite words $u_1, \dots, u_{i-1} \in \Sigma^+$ and $\mu(u_1)\mu(u_2)\cdots\mu(u_{i-1}) = \mu(u_1)$, therefore $\delta(\vec{q}, u_1u_2\cdots u_{i-1}) = \delta(\vec{q}, u_1) = \vec{p}$. This means that the factor u_i is visited by ρ , and furthermore that this visit starts in state p , giving Items 1 and 2 by defining ρ_i accordingly. For Item 3, let $i \geq 3$ (for $i = 2$ the result is obvious) be such that u_{i+1} is defined, we show that ρ_i only visits u_i and u_{i-1} . First, observe that this run does not visit u_{i+1} by construction of ρ_{i+1} . Let us consider the state r seen in the last visit of the first position of u_{i-1} in ρ_{i-1} . Since $\mu(u_{i-1}u_i) = \mu(u_{i-1})$, we have $\delta(\vec{r}, u_{i-1}u_i) = \delta(\vec{r}, u_{i-1}) = \vec{p}$ (the last equality follows from Item 2, because it describes the beginning of ρ_i). This means that when starting from r in the first position of u_{i-1} , \mathcal{T} will execute the end of ρ_{i-1} , then ρ_i , and it will eventually leave $u_{i-1}u_i$ “by the right”. Hence the run ρ_i stays in $u_{i-1}u_i$, until it goes to u_{i+1} in state p (and this is by construction the beginning of ρ_{i+1}). ◀

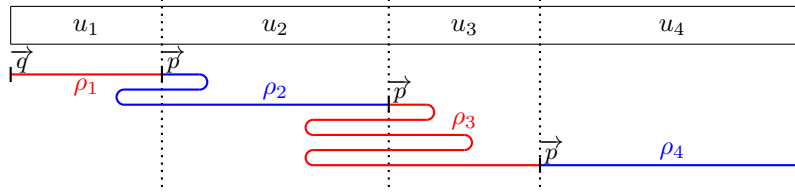

■ **Figure 2** Shape of a run ρ in Lemma A.14 (i.e. when $\mu(u_i)\mu(u_j) = \mu(u_i)$ for all i, j).

► **Remark A.15.** If u_{n+1} is not defined (i.e. the split was of shape $\mathfrak{s}_1|_k \cdots |_k \mathfrak{s}_n$) with $u_n \in \Sigma^\infty$, there is no reason why ρ_n should visit only u_{n-1} and u_n . Indeed, we have no information on $\mu(u_n)$ (even if it is defined), hence we cannot describe the behavior of \mathcal{T} within u_n . As a consequence, the last ρ_n (if it exists) cannot be controlled, and Lemma A.14 does not imply that $\delta(\vec{q}, u) = \omega$ if $u \in A^\omega$, nor $\delta(\vec{q}, u) = \vec{p}$ if $u \in A^+$.

► **Remark A.16.** Observe that in Figure 2, the run ρ_2 visits 3 times the first position of u_2 , whereas ρ_3 visits 5 times the first position of u_3 . In the case of Simon’s usual factorization forests (i.e. $\mu(u_1) = \mu(u_2) = \dots$) such a difference ($3 \neq 5$) cannot occur due to the fact that all factors have the same idempotent image.

Recall that Theorem 3.3 states that any regular function over finite words can be written as the restriction of a function of \mathcal{C} to finite words. Using this result, we claim in Lemma A.17 that the runs of \mathcal{T} that start on the right of a finite word can be simulated by a function of \mathcal{C} . We even replace the input word u by a μ -split $\mathfrak{s} \in \text{FRS}_k(u)$ (this is not necessary here, but it will be simpler to handle the more precise \mathfrak{s} in the rest of the proof).

► **Lemma A.17.** For all $k \geq 0$, one can effectively build a function $\overleftarrow{\text{run}}_k : (\Sigma \cup \Delta_k \cup \overleftarrow{Q})^* \rightarrow (\Sigma \cup \Delta_k \cup \Gamma \cup \overleftarrow{Q})^* \in \mathcal{C}$ such that for all $u \in \Sigma^+$, $\mathfrak{s} \in \text{FRS}_k(u)$ and $q \in Q$:

- if $\delta(\overleftarrow{q}, u) = \vec{p}$ and $\lambda(u \overleftarrow{q}) = v$ then $\overleftarrow{\text{run}}_k(\mathfrak{s} \overleftarrow{q}) = v \mathfrak{s} \vec{p}$;
- if $\delta(\overleftarrow{q}, u) = \vec{p}$ and $\lambda(\overleftarrow{q}, u) = v$ then $\overleftarrow{\text{run}}_k(\mathfrak{s} \overleftarrow{q}) = v \overleftarrow{p} \mathfrak{s}$.

Proof. Such a function (from finite words to finite words) can be computed by a two-way transducer that ignores the symbols of Δ_k . The result follows from Theorem 3.3. ◀

A.4 Main inductive proof

The heart of the proof is to show Lemma A.18 by induction on $k \geq 0$. It is roughly an analogue of Lemma A.17, but for the runs that start on the left of a finite or infinite word. Due to the fact that words can be infinite “on the right” but not “on the left”, there is a fundamental dissymmetry between the two aforementioned lemmas.

► **Lemma A.18.** *For all $k \geq 0$, one can effectively build a function $\overrightarrow{\text{run}}_k \in \mathcal{C}$ such that for all $q \in Q$, $u \in \Sigma^\infty$ and $\mathfrak{s} \in \text{FRS}_k(u)$:*

- *if $\delta(\overrightarrow{q}, u) = \overleftarrow{q}$ and $\lambda(\overrightarrow{q}, u) = v \in \Gamma^*$ then $\overrightarrow{\text{run}}_k(\overrightarrow{q}\mathfrak{s}) = v\overleftarrow{q}\mathfrak{s}$;*
- *if $\delta(\overrightarrow{q}, u) = \omega$ and $\lambda(\overrightarrow{q}, u) = v \in \Gamma^\omega$ then $\overrightarrow{\text{run}}_k(\overrightarrow{q}\mathfrak{s}) = v$;*
- *if $u \in \Sigma^+$, $\delta(\overrightarrow{q}, u) = \overrightarrow{q}$ and $\lambda(\overrightarrow{q}, u) = v \in \Gamma^*$ then $\overrightarrow{\text{run}}_k(\overrightarrow{q}\mathfrak{s}) = v\mathfrak{s}\overrightarrow{q}$.*

► **Remark A.19.** If we do not fall in one of the three cases (e.g. $\delta(\overrightarrow{q}, u) = \omega$ but $\lambda(\overrightarrow{q}, u) \in \Gamma^*$), the value of $\overrightarrow{\text{run}}_k$ does not matter (it may even be undefined).

Now, let us explain why Theorem 3.6 immediately follows from this result.

Proof of Theorem 3.6. By Theorem A.12, one can effectively build a function $\text{split} : \Sigma^\omega \rightarrow (\Sigma \cup \Delta_k)^\omega$ such that for all $u \in \Sigma^\omega$, $\text{split}(u) \in \text{FRS}_N(u)$. We postcompose split with the function that adds the letter \overrightarrow{q}_0 in the beginning of its input, and then with $\overrightarrow{\text{run}}_N$. This composition produces the same output as \mathcal{T} whenever the input has an accepting run whose output is infinite. However, it may be defined on inputs that are not in the domain of \mathcal{T} . But recall that this domain L is a Büchi deterministic language by Proposition 2.11. Therefore, it is sufficient to precompose our construction by the restriction of the identity function to L (which is a sequential function over infinite words). ◀

The rest of Appendix A.4 is devoted to the proof of Lemma A.18. We show this result by induction on $k \geq 0$. For $k = 0$, necessarily $u = \mathfrak{s} = a$ or $u = \mathfrak{s} = \varepsilon$ and the result follows by building a sequential function that hardcodes the functions δ and λ .

Now, assume that the function $\overrightarrow{\text{run}}_k$ in \mathcal{C} is built for some $k \geq 0$. We describe how to build the function $\overrightarrow{\text{run}}_{k+1}$ in \mathcal{C} . Let $u \in A^\infty$ and $\mathfrak{s} \in \text{FRS}_{k+1}(u)$. Without loss of generalities (up to first applying a sequential function turning $|_{k+1}$ into $|$), we assume that $\overrightarrow{q}\mathfrak{s}$ is of shape $\overrightarrow{q}\mathfrak{s}_1|\mathfrak{s}_2|\cdots$ where $\mathfrak{s}_i \in \text{FRS}_k(u_i)$, $u_i \in A^\infty$ and $u = u_1u_2\cdots$.

1. We first apply the function $[\overrightarrow{\text{run}}_k | \text{id} |]$ (where id stands for the identity function) built from Lemma A.7, which outputs the following (with $v_1 := \lambda(\overrightarrow{q}, u_1)$):
 - if $\delta(\overrightarrow{q}, u_1) = \omega$ (necessarily $u = u_1 \in \Sigma^\omega$) and $v \in \Gamma^\omega$, then v_1 (nothing left to do);
 - if $\delta(\overrightarrow{q}, u_1) = \overleftarrow{p}_1$, then $v_1\overleftarrow{p}_1\mathfrak{s}_1|\mathfrak{s}_2\cdots$ (nothing left to do);
 - if $\delta(\overrightarrow{q}, u_1) = \overrightarrow{p}$ (necessarily $u_1 \in \Sigma^+$), then $v_1\mathfrak{s}_1\overrightarrow{p}|\mathfrak{s}_2\cdots$.
2. We then apply a sequential function that checks if a \overrightarrow{p} occurs, removes the \overrightarrow{p} and replaces each letter $|$ by $|\overrightarrow{p}$, thus it produces:
 - if $\delta(\overrightarrow{q}, u_1) = \omega$ and $v_1 \in \Gamma^\omega$, then v (nothing left to do);
 - if $\delta(\overrightarrow{q}, u_1) = \overleftarrow{p}_1$, then $v_1\overleftarrow{p}_1\mathfrak{s}_1|\mathfrak{s}_2\cdots$ (nothing left to do);
 - if $\delta(\overrightarrow{q}, u_1) = \overrightarrow{p}$, then $v_1\mathfrak{s}_1|\overrightarrow{p}\mathfrak{s}_2|\overrightarrow{p}\mathfrak{s}_3|\overrightarrow{p}\cdots$. In this case, following the notations of Lemma A.14, then v_1 is the output produced along ρ_1 , and for all $i \geq 2$ ρ_i starts in state p . Now, the idea is to simulate *in parallel, using a “map”* (and this is the key idea of this proof) all the runs ρ_i for $i \geq 2$ since all of them begin in state p .
3. We thus want to apply $\overrightarrow{\text{run}}_k(\overrightarrow{p}\mathfrak{s}_i)$ on all the appropriate factors. For this, we first write a $\#$ symbol before each \overrightarrow{p} (this operation will enable to leave the factors without \overrightarrow{p} unchanged). We build $\overrightarrow{\text{try-run}} := [\text{id} \# \overrightarrow{\text{run}}_k \#]$ (recall that if it does not meet a $\#$, this

function will just behave as the identity function id). Then we apply apply the function $\overleftarrow{\text{try-run}}$ on the whole input:

- the word is not modified if there was no letter \overrightarrow{p} (first cases above);
 - if the input was $v_1\mathfrak{s}_1|\overrightarrow{p}\mathfrak{s}_2|\overrightarrow{p}\mathfrak{s}_3|\overrightarrow{p}\cdots$, we obtain a word of shape $v_1\mathfrak{s}_1|w_2|w_3|\cdots$. Let us describe formally the w_i for $i \geq 2$, depending on the runs ρ_i of Lemma A.14:
 - if u_{i+1} is defined, two cases occur:
 - * either ρ_i never visits the last position of u_{i-1} , which means that it leaves u_i “directly by the right”, and in state p by Lemma A.14. In this case we have $w_i = v_i\mathfrak{s}_i\overrightarrow{p}$ where v_i is the output produced along the whole ρ_i ;
 - * or ρ_i visits the last position of u_{i-1} , and the first visit of this position is done in state $p_i \in Q$, then $w_i = v_i\overleftarrow{p}_i\mathfrak{s}_i$ where $v_i \in \Gamma^*$ is output of \mathcal{T} along ρ_i from its beginning to this first visit;
 - else if $u_n \in \Sigma^\infty$ is the last factor, three cases can occur which produce either $w_n = v_n\mathfrak{s}_n\overrightarrow{p}$ (similar to the first case above) or $w_n = v_n\overleftarrow{p}_n\mathfrak{s}_i$ (similar to the second case) or $w_n = v_n \in \Gamma^\omega$ (ρ_n visits arbitrarily large positions of $u_n \in \Sigma^\omega$)
4. Then, we apply a sequential function that replaces each subword \overrightarrow{s} by $|$ (in order to remove the \overrightarrow{p} in the factors, since the corresponding ρ_i have been fully simulated).
5. Now, our goal is to simulate the next part of the runs ρ_i that were not completed, i.e. deal with the factors of shape $w_i = v_i\overleftarrow{p}_i\mathfrak{s}_i$. In this case, we need to compute $\overleftarrow{\text{run}}_k(\mathfrak{s}_{i-1}\overleftarrow{p}_i)$. We first build a function that copies the \mathfrak{s}_{i-1} in the next factor, if it contains some \overleftarrow{s} .

▷ **Claim A.20.** Let $\#$ be a fresh symbol. We can effectively build a function of \mathcal{C} that takes as input the word built so far and turns each factor w_i of shape $v_i\overleftarrow{p}_i\mathfrak{s}_i$ for $i \geq 2$ into $v_i p_i \# \mathfrak{s}_{i-1} \overleftarrow{p}_i \# \mathfrak{s}_i$, and leaves the other factors unchanged.

Proof. Since all factors have shape either $v_i\overleftarrow{p}_i\mathfrak{s}_i$, or $v_i\mathfrak{s}_i$ or $v_n\mathfrak{s}_n\overrightarrow{p}$ or $v_n \in \Gamma^\omega$, we can first apply a sequential function that adds a $\#$ symbol right before reach \mathfrak{s}_i . We then apply **map-copy** with separator $\#$, giving factors of shape $\#\mathfrak{s}_{i-1}|v_i(\overleftarrow{p}_i?)\#\mathfrak{s}_{i-1}|v_i(\overleftarrow{p}_i?)\#$. We then apply a sequential function that uses the first \mathfrak{s}_{i-1} for the previous factor, then outputs v_i , then $p_i\#\mathfrak{s}_i$ if there is a \overleftarrow{p}_i , ignores the next v_i and ends with \overleftarrow{p}_i . It is easy to see that this function behaves as expected if v_i or \mathfrak{s}_{i-1} is infinite. ◀

Finally, we apply the function described in Claim A.20 to the whole input.

6. It remains to apply $\overleftarrow{\text{run}}_k(\mathfrak{s}_{i-1}\overleftarrow{p}_i)$ on the appropriate factors. For this, we build $\overleftarrow{\text{try-run}} := [\text{id} \# \overleftarrow{\text{run}}_k \# \text{id} \#]$ (recall that if it does not meet a $\#$, this function will just behave as the identity function id) and then we apply the function $\overleftarrow{\text{try-run}}$ on the whole word:
- the factors that do not contain $\#$ are not modified (i.e. the factors where there was previously no $\overleftarrow{s} \in \overleftarrow{Q}$, plus the first one that may contain a \overleftarrow{s});
 - otherwise, each factor of shape $v_i p_i \# \mathfrak{s}_{i-1} \overleftarrow{p}_i \# \mathfrak{s}_i$ for $i \geq 2$ is now turned into:
 - either $v_i p_i \# v'_i \mathfrak{s}_{i-1} \overrightarrow{p}_i \# \mathfrak{s}_i$. It means that after its stay in u_{i-1} , ρ_i goes back to u_i in state p'_i , and that the output of \mathcal{T} along this portion of ρ_i in u_{i-1} is v'_i . In this case we want to concatenate v_i and v'_i ;
 - or $v_n p_n \# v'_n \overleftarrow{p}_n \mathfrak{s}_{n-1} \# \mathfrak{s}_n$. In this case, it means that ρ_n will visit u_{n-2} . According to Lemma A.14, this is only possible if $u_n \in \Sigma^\omega$ was the last factor. In this case the μ -split cannot help us controlling ρ_n , but this very particular case can occur only once in the whole process and will be treated in Item 10.
7. Now, let us remove the $\#$ and the useless copies of factors.

▷ Claim A.21. One can effectively build in \mathcal{C} a function `normalize` over the alphabet $\Sigma \cup \Gamma \cup Q \cup \overleftarrow{Q} \cup \overrightarrow{Q} \cup \{\#\}$ that behaves as follows:

- if its input does not contain $\#$, it behaves as the identity function;
- if its input has shape $v_i p_i \# v'_i \overleftarrow{s}_{i-1} \overrightarrow{p}_i \# \overrightarrow{s}_i$, it is mapped to $v_i v'_i \overrightarrow{p}_i \overrightarrow{s}_i$;
- if its input has shape $v_n p_n \# v'_n \overleftarrow{p}'_n \overleftarrow{s}_{n-1} \# \overrightarrow{s}_n$, it is mapped to $v_n p_n \overrightarrow{s}_n$

Proof. We first replace the second $\#$ (if it exists) by a $|$ and then apply a `map-copy` with separator $|$. Thus if the input had the second (resp. the third) shape it is now $v_i p_i \# v'_i \overleftarrow{s}_{i-1} \overrightarrow{p}_i | v_i p_i \# v'_i \overleftarrow{s}_{i-1} \overrightarrow{p}_i | \overrightarrow{s}_i \cdots$ (resp. $v_n p_n \# v'_n \overleftarrow{p}'_n \overleftarrow{s}_{n-1} | v_n p_n \# v'_n \overleftarrow{p}'_n \overleftarrow{s}_{n-1} | \overrightarrow{s}_n \cdots$). We finally apply a sequential function that outputs what it sees until a factor $s\#$ with $s \in Q$. In this case it reads the next factor between $\#$ and $|$ (without writing) to determine whether the input has the second or the third shape, and then it behaves accordingly on the last piece. This process leaves unchanged the (finite or infinite) words without $\#$. ◀

We then apply the function `[normalize |]` to our whole input. Observe that the last case of Claim A.21, we have undone the computation of $\overleftarrow{run}_k(\overleftarrow{s}_{i-1} \overleftarrow{p}_i)$ and the state p_i no longer has an over-arrow: it is somehow “frozen” (but recall that this situation can occur only for the last factor) and the rest of ρ_i will be simulated in Item 10.

8. By iterating $|Q|$ times the steps described in Items 3–7, one can simulate the runs ρ_i for $i \geq 2$ (except possibly the last one, cf. above). Indeed, these runs visit at most $|Q|$ times the first position of their respective u_i . As a result, we obtain an output that has one of the following shapes (where $v_1 := \lambda(\overrightarrow{q} u_1)$):
 - if $\delta(\overrightarrow{q}, u_1) = \omega$ and $v_1 \in \Gamma^\omega$, then v_1 (nothing left to do);
 - if $\delta(\overrightarrow{q}, u_1) = \overleftarrow{p}_1$, then $v_1 \overleftarrow{p}_1 \overrightarrow{s}_1 | \overrightarrow{s}_2 \cdots$ (nothing left to do);
 - if $\delta(\overrightarrow{q}, u_1) = \overrightarrow{p}$ (necessarily $u_1 \in A^+$), then two main cases possible cases occur:
 - no state was “frozen” (i.e. each ρ_i has been entirely simulated), and we get a word of shape $v_1 \overrightarrow{s}_1 | v_2 \overrightarrow{s}_2 | \cdots$ (possibly ending with a $v_i \in \Gamma^\omega$ or with a \overrightarrow{r} if the input was finite), where each v_i is exactly the output of \mathcal{T} along ρ_i of Lemma A.14. In this case it remains to regroup the v_i (and the \overrightarrow{s}_i if the input is finite);
 - or a state $s \in Q$ was “frozen” at some point (in the last factor) and we obtain a word of shape $v_1 \overrightarrow{s}_1 | \cdots | v_n \overrightarrow{s}_n$, where the v_i for $i < n$ are the output of \mathcal{T} along ρ_i , and v_n is the output along ρ_n until some visit of the last position of $u_{n-1} \in \Sigma^+$, which is done in state. In this case, we still have some output to produce.
9. Now, we claim that we can apply a function of \mathcal{C} so that the result is:
 - if $\delta(\overrightarrow{q}, u_1) = \omega$ and $v_1 := \lambda(\overrightarrow{q} u_1) \in \Gamma^\omega$, then v_1 (nothing to do);
 - if $\delta(\overrightarrow{q}, u_1) = \overleftarrow{p}_1$ and $v_1 := \lambda(\overrightarrow{q} u_1) \in \Gamma^*$, then $v_1 \overleftarrow{p}_1 \overrightarrow{s}_1 | \overrightarrow{s}_2 \cdots$ (nothing to do);
 - else if $\delta(\overrightarrow{q}, u_1) = \overrightarrow{p}$:
 - either no state was frozen during the process and we have either $v \in \Gamma^\omega$ (infinite input) or $v \overrightarrow{s}_1 | \cdots | \overrightarrow{s}_n \overrightarrow{s}$ (finite input) where $v := \lambda(\overrightarrow{q} u)$ (nothing to do);
 - or a state was frozen and we obtain $v \# \overrightarrow{s}_1 | \cdots | \overrightarrow{s}_{n-1} \overleftarrow{s} \overrightarrow{s}_n$ where $u = u_1 \cdots u_n$ with $u_n \in \Sigma^\infty$ and v is the output produced along the run ρ of Lemma A.14 until some visit in the last position of u_{n-1} , which is done in state $s \in Q$.

To create such a function of \mathcal{C} , we first add a $\#$ before any s , \overleftarrow{s} or \overrightarrow{s} (if it exists). We then apply `[map-copy # id #]` and use the first copy to produce the $v_1 v_2 \cdots v_n$ (with a final $\#$ if required) and the second one for the $\overrightarrow{s}_1 | \cdots | \overrightarrow{s}_{n-1}$. Finally we add the $\overleftarrow{s} \overrightarrow{s}_n$ or $\overrightarrow{s}_n \overrightarrow{s}$. Observe that the construction can be extended in a correct way if there are no s , \overleftarrow{s} nor \overrightarrow{s} : the input was infinite and we only produce the v_i .

10. Finally, let us explain briefly how to deal with the last case of Item 9, that is when we have $v\#\mathfrak{s}_1|\cdots|\mathfrak{s}_{n-1}|\overleftarrow{\mathfrak{s}}\mathfrak{s}_n$ with $u_n \in \omega^\infty$. We first transform the $|\overleftarrow{\mathfrak{s}}$ into $\overleftarrow{\mathfrak{s}}\#$. Then we apply the function $[\text{id}\#\overleftarrow{\text{run}}_{k+1}\#\text{id}\#]$ in order to simulate a run on the prefix (beware that we need $\overleftarrow{\text{run}}_{k+1}$ and not $\overleftarrow{\text{run}}_k$ here). The result either gives an output and a state \overleftarrow{t} on the left or \overrightarrow{t} on the right. If there is a $\overrightarrow{t}\#$, we replace it by $\#\overrightarrow{t}$ and then apply $[\text{id}\#\text{id}\#\overrightarrow{\text{run}}_k\#]$ to simulate a run on the suffix. Then we regroup the outputs, in a manner similar to Item 9. Since the first position of u_n is visited at most $|Q|$ times, we can simulate the whole run ρ by iterating these operations $|Q|$ times.

B Guarded MSO-transductions

B.1 MSOT_g with total order, and proof of Proposition 4.9

In the definition of MSOT and MSOT_g of Sections 4, it is not required to define the total order \leq of the output structure. We consider here MSO-transductions where the total order is required to be defined, instead of the successor. While this does not change the expressiveness of MSOT, as the successor is expressible from the order and vice-versa, the picture is different with the guarded fragment. We prove that this modification allows one to define functions which are not deterministic regular.

In this section, we write MSOT_g[S] instead of MSOT_g to emphasize the fact that only successor is defined. We denote MSOT_g[\leq] the class of guarded MSOT with order, defined exactly as MSOT_g[S] except that instead of having formulas for successors, there are formulas $\phi_{\leq}^{c,d}(x,y)$ for the order, and any copies c,d . The semantics is as follows. Let $T \in \text{MSOT}_g[\leq]$, over input alphabet Σ and output alphabet Γ . On input $u \in \Sigma^\omega$, T defines an output structure that we denote $T(u)$, over the signature $\{\leq(x,y), (\gamma(x))_{\gamma \in \Gamma}\}$. We then denote by $T(u)|_S$ the structure over signature $\{S(x,y), (\gamma(x))_{\gamma \in \Gamma}\}$ obtained from $T(u)$ by interpreting S has the one-step successor of the interpretation of \leq in $T(u)$. Note that at this point, the structure $T(u)|_S$ might not correspond to a word structure, it is just *some* structure over $\{S(x,y), (\gamma(x))_{\gamma \in \Gamma}\}$. As for MSOT_g[S], we define the semantics of T over word structures only:

$$\llbracket T \rrbracket = \{(u, v) \in \Sigma^\omega \times \Gamma^\omega \mid T(u)|_S \text{ is isomorphic to } G_v\}$$

► **Example B.1.** Let $\Sigma = \Gamma = \{a, b\}$ and $\text{er}_b : \Sigma^* \rightarrow \Sigma^*$ the (erasing) morphism defined by $\text{er}_b(a) = a$ and $\text{er}_b(b) = \varepsilon$. We define a function $h : \Sigma^\omega \rightarrow \Gamma^\omega$ on inputs of the form bub^ω , for $u \in \{a, b\}^*$, by $h(bub^\omega) = b\text{er}_b(u)b^\omega$. The function h is not continuous (and so not deterministic regular): $\lim_{n \rightarrow \infty} h(b^n ab^\omega) = bab^\omega \neq h(\lim_{n \rightarrow \infty} b^n ab^\omega) = h(b^\omega) = b^\omega$. We show that it is definable by a 1-copy MSOT_g[\leq]. An example of output structure on input $bbabaab^\omega$ is given below (we depict only the successor predicate and not the order):

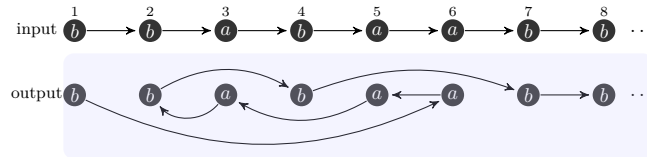

To define the formulas, we use the guarded formula $\text{first}(x) = \exists g \forall y \leq x \leq g \cdot y = x$ which holds true if x is the first input position. Note that its negation is equivalent to the guarded formula $\exists y \leq x \cdot y \neq x$. Then, the first output element is defined by $\phi_{\text{fst}}(x) = \text{first}(x) \wedge b(x)$, which holds true if x is the first input element *and* it is labeled b . If the first element is

not labelled b , then the latter formula is not satisfied, and by definition of the semantics of MSOT_g , the output structure is empty. So, it is not isomorphic to any infinite word structure and therefore the input word is not in the domain. The label formulas preserve the labels: $\phi_\sigma(x) = \sigma(x)$ for all $\sigma \in \{a, b\}$.

Let us define the order formula $\phi_{\leq}(x, y)$. If x is the first input node, then it is smaller than any y . If x is the second node, then it is smaller than any b which appears later. If x is labelled a , then it is smaller than any b but the first one, and to any other a that appears to its left:

$$\begin{aligned} \phi_{\leq}(x, y) &= (b(x) \wedge b(y)) \rightarrow x \leq y \wedge \\ &\quad (b(x) \wedge a(y)) \rightarrow \text{first}(x) \wedge \\ &\quad a(x) \rightarrow (b(y) \wedge \neg \text{first}(x)) \vee (a(y) \wedge y \leq x) \end{aligned}$$

Note that all the formulas above are guarded. We do not explicitly write them in guarded form, but it suffices to use $\text{max}(x, y)$ as guard.

This proves Proposition 4.9.

C Removal of finite look-ahead

In the remainder this section let $\mathcal{T} = (\Sigma, \Gamma, Q, q_0, F, \delta, \lambda)$ be a 2-dT^{FLA} . Wlog., we assume that only transitions moving to the right use non-trivial look-ahead languages and transition going to the left use the trivial look-ahead language Σ^* (aka. no look-ahead).

This can be achieved by replacing every transition that moves to the left using some non-trivial look-ahead by a transition going right (with this look-ahead) and two transitions moving left using no look-ahead. A convenient side effect of this construction is that for a state either only right or only left transitions are enabled.

Let L_1, \dots, L_n be the regular look-ahead languages that occur in δ . Wlog., we assume that these look-ahead languages can be accepted using the same DFA with different final states. Formally, let $\mathcal{A} = (\Sigma, Q_{\mathcal{A}}, q_0^{\mathcal{A}}, F_{\mathcal{A}}, \delta_{\mathcal{A}})$ be a DFA and $c : Q_{\mathcal{A}} \rightarrow \mathcal{P}(\{1, \dots, n\})$ be a (multi-)coloring of its states. Let $F_i = \{q \in Q_{\mathcal{A}} \mid c(q) = i\}$ for all $1 \leq i \leq n$, and let $\mathcal{A}_i = (A, Q_{\mathcal{A}}, q_0^{\mathcal{A}}, F_{\mathcal{A}}, F_i, \delta_{\mathcal{A}})$. We assume that $L(\mathcal{A}_i) = L_i$. We refer to \mathcal{A} as *look-ahead automaton*. We extend its states by a designated sink state q_{Σ^*} with color 0 to model the trivial look-ahead language Σ^* (aka. no look-ahead). Let C be the set of colors $\{0, 1, \dots, n\}$. See Figure 3 for an example.

C.1 Look-ahead trees

We introduce some notation.

► **Definition C.1** (look-ahead information). *A look-ahead information is a tuple of the form (p, c) , where $p \in Q_{\mathcal{A}}$, and $c \in C$. The intended meaning of such a tuple is that the look-ahead automaton is currently in state p and we want to reach a state with color c .*

We say that a look-ahead information (p, c) has succeeded if $c \in c(p)$.

Given a look-ahead information (p, c) and a letter $\sigma \in \Sigma$, we define $\text{up}((p, c), \sigma) = (\delta_{\mathcal{A}}(p, \sigma), c)$ if (p, c) has not succeeded, otherwise $\text{up}((p, c), \sigma) = (p, c)$ (because once we know if a look-ahead information has succeeded, we want to freeze its status).

Let I denote the set of all look-ahead information. Given a subset $M \subseteq I$ and a letter $\sigma \in \Sigma$, we define $\text{up}(M, \sigma) = \{\text{up}(i, \sigma) \mid i \in M\}$.

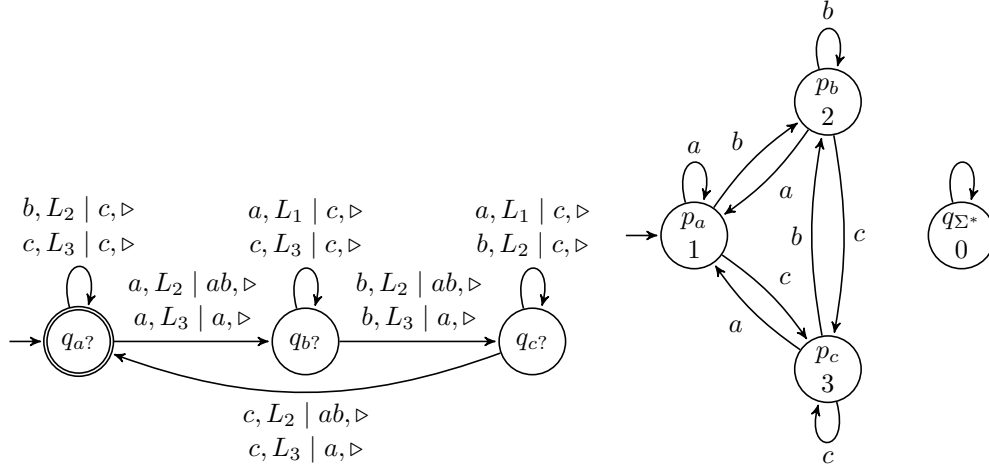

■ **Figure 3** On the left-hand side is a deterministic two-way transducer with finite look-aheads, on the right side is the corresponding look-ahead automaton.

We introduce the concept of a look-ahead trees which we inductively define. Look-ahead trees are trees whose nodes have labels from $Q \times I$, i.e. they store a state of the two-way transducer and a set of look-ahead information. A visualization is given in Figures 4 and 6.

► **Definition C.2** (look-ahead tree). *This set of single-node trees are look-ahead trees: $\{(q, \{(q_{\Sigma^*}, 0)\}) \mid q \in Q\}$.*

Given a look-ahead tree t and a letter $\sigma \in \Sigma$, applying the following operations ($t_1 = \text{up}(t, \sigma)$) then $t_2 = \text{del}_{\text{success}}(t_1)$ then $t_3 = \text{del}_{\text{fail}}(t_2)$ and finally $t' = \text{merge}(t_3)$ defined below yields a new look-ahead tree t' .

Update

The first step of the update process is to update all look-ahead information wrt. the letter σ . Therefore, we re-label every node. A label of the form (q, M) is replaced by $(q, \text{up}(M, \sigma))$.

We say that a nodes with label (q, M) has succeeded if all its look-ahead information stored in M have succeeded. A path of in the tree is called successful if all its nodes have succeeded.

The second step of the update process is to add new nodes to the tree. For a state q , we collect the set of \triangleright -transitions that are potentially enabled with the letter σ . Let $S_q = \{i \mid \delta(q, \sigma, L_i) \neq \perp\}$.

For a leaf with label (q, M) we add the following nodes as its children if $S_q \neq \emptyset$. For all $i \in S_q$, we add a child with label $(q', \{(q_0^A, i)\})$ if $\delta(q, \sigma, L_i) = (q', \triangleright)$.

Otherwise (if $S_q = \emptyset$), we add a child with label “fail”.

We refer to this process as $\text{up}(\cdot, \sigma)$.

Delete

The purpose of the delete step is two-fold.

On the one hand, we want to remove a path from the root to a leaf if it is successful as this indicates the path stores info about the accepting run (we have seen witnesses for the look-aheads on this path). On the other hand, we want to remove paths of which we know that they do not store info about an accepting run.

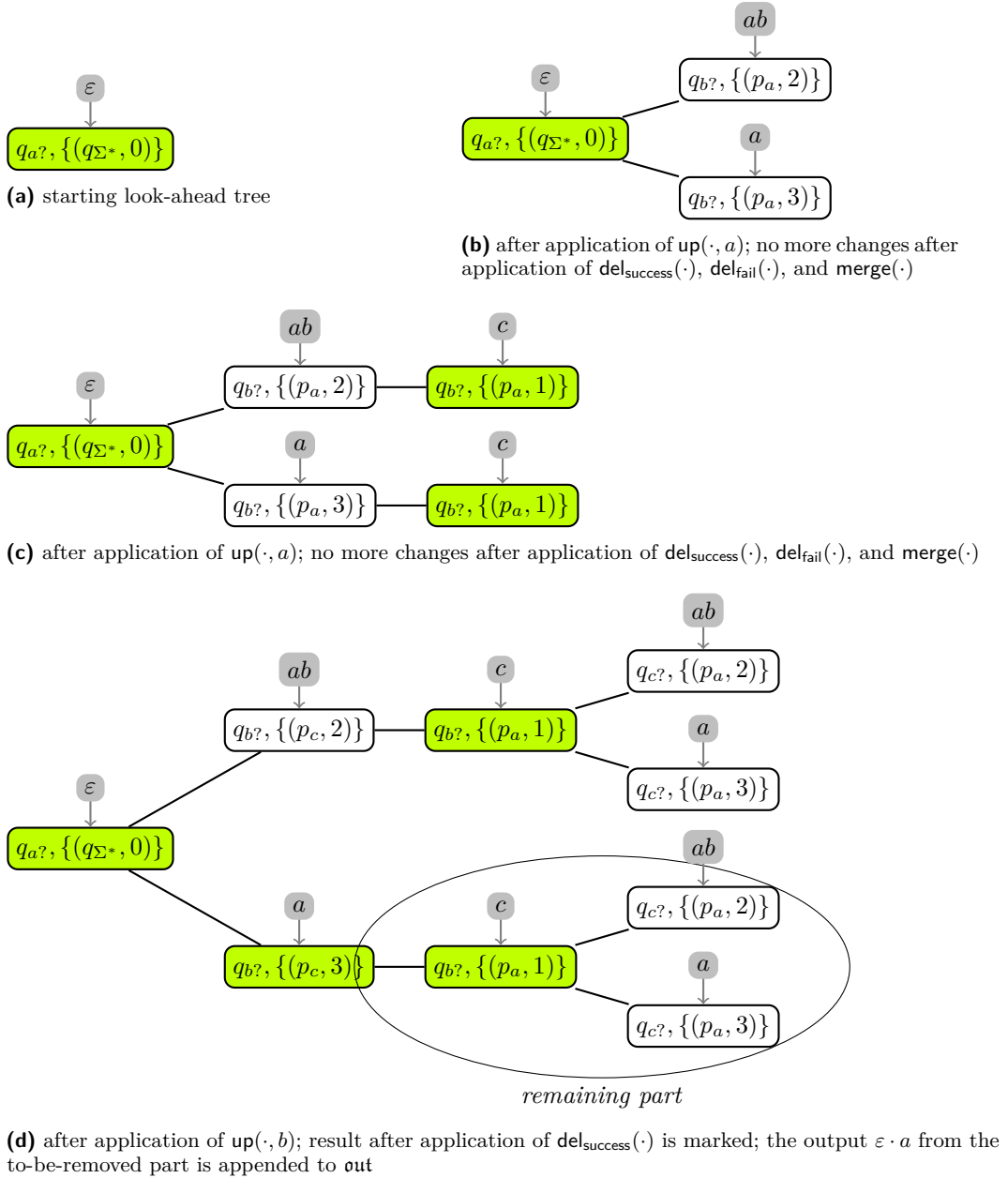

■ **Figure 4** Overview of how to construct look-ahead trees based on the transducer given in Figure 3. The Figures 4a–4c, 4e, 4g, 4i, and 4j depict look-ahead trees, the Figures 4d, 4f, and 4h depict intermediate construction steps. Nodes that are drawn with lime background have succeeded. Nodes drawn with grey background do not belong to the tree; they visualize registers that are associated to the nodes of the tree. The second part of this figure can be found on Page 29.

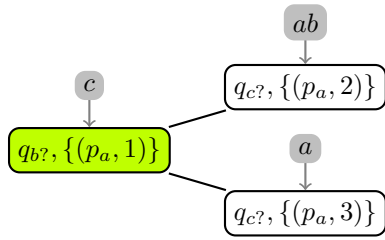

(e) after application of $\text{del}_{\text{success}}(\cdot)$; no more changes after application of $\text{del}_{\text{fail}}(\cdot)$ and $\text{merge}(\cdot)$

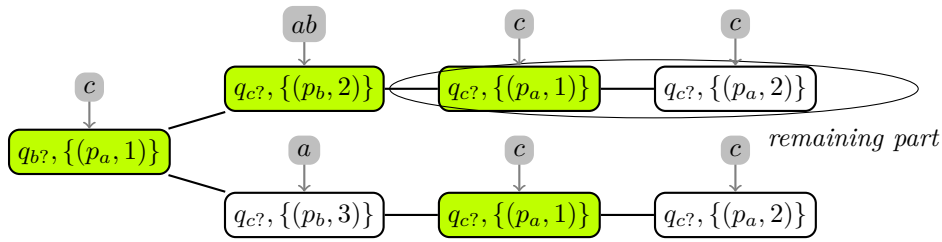

(f) after application of $\text{up}(\cdot, a)$, $\text{del}_{\text{success}}(\cdot)$, $\text{del}_{\text{fail}}(\cdot)$, $\text{merge}(\cdot)$ and $\text{up}(\cdot, b)$; result after application of $\text{del}_{\text{success}}(\cdot)$ is marked; the output $c \cdot ab$ from the to-be-removed part is appended to out

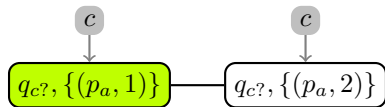

(g) after application of $\text{del}_{\text{success}}(\cdot)$; no more changes after application of $\text{del}_{\text{fail}}(\cdot)$ and $\text{merge}(\cdot)$

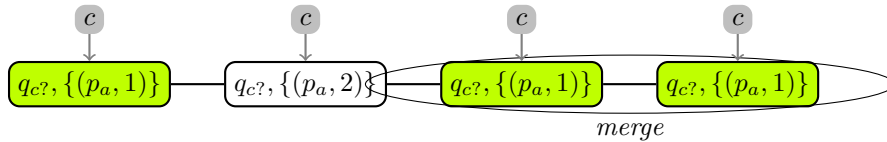

(h) after application of $\text{up}(\cdot, a)$, $\text{del}_{\text{success}}(\cdot)$, $\text{del}_{\text{fail}}(\cdot)$, $\text{merge}(\cdot)$, $\text{up}(\cdot, a)$, $\text{del}_{\text{success}}(\cdot)$, and $\text{del}_{\text{fail}}(\cdot)$; nodes that will be affected by $\text{merge}(\cdot)$ are marked

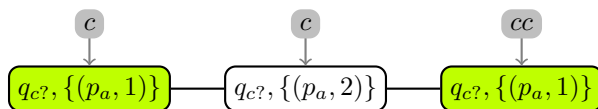

(i) after application of $\text{merge}(\cdot)$

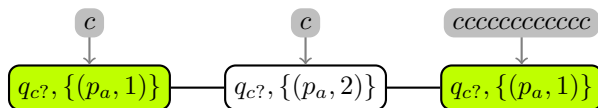

(j) after 10x application of $\text{up}(\cdot, a)$, $\text{del}_{\text{success}}(\cdot)$, $\text{del}_{\text{fail}}(\cdot)$ and $\text{merge}(\cdot)$

■ **Figure 4** Overview of how to construct look-ahead trees based on the transducer given in Figure 3. The Figures 4a–4c, 4e, 4g, 4i, and 4j depict look-ahead trees, the Figures 4d, 4f, and 4h depict intermediate construction steps. Nodes that are drawn with lime background have succeeded. Nodes drawn with grey background do not belong to the tree; they visualize registers that are associated to the nodes of the tree. The first part of this figure can be found on Page 28.

After the delete step, the look-ahead tree only contains nodes that store info about runs where some look-ahead still has to be verified.

As the first step, if the tree contains a node n which is not the root node r and the path from r to n is successful, and n has no children that have succeeded, then n becomes the new root node. Note that the assumption of disjointness for the look-aheads ensures that there is at most one such path.

We refer to this process as $\text{del}_{\text{success}}(\cdot)$.

As the second step, we remove nodes that do not store info about the accepting run. Therefore, the following steps are done:

- If a leaf is labeled “fail”, we delete this leaf and all its ancestors until the ancestor has at least two children. This indicates that this run of the two-way transducer has failed.
- If two paths from the root to a leaf describe the same situation (to be explained) we can delete them both. More concretely, given a path $\pi = n_1 n_2 \cdots n_i$ from the root to leaf such that the label of the node n_j is (q_j, M_j) for all $1 \leq j \leq i$. We denote by $\text{summary}(\pi)$ the set $\bigcup_{j=1}^i M_j$. It summarizes the status of the look-aheads that have to hold on this path. Let π_1 and π_2 be two paths from the root to two leaves such that the leaf labels are (q, M) and (q, M') , respectively, and $\text{summary}(\pi_1) = \text{summary}(\pi_2)$. By construction, these paths describe different runs of the two-way transducer, but they have the same look-ahead status. That means that both of these runs must either fail or succeed. It is not possible that both runs will succeed as this contradicts the fact the two-way transducer is deterministic. Hence, both of these runs will fail and we can remove their representation from the look-ahead tree. To do so, whenever there are two paths whose leaves store the same state of the two-way transducer and their look-ahead summary is equal, we delete this leaf and all its ancestors until the ancestor has at least two children.

We refer to this process as $\text{del}_{\text{fail}}(\cdot)$.

Merge

Finally, if the tree contains a linear branch segment of length at least 3 meaning that there are nodes n_1, n_2, \dots, n_j such that $j > 3$ and n_{i+1} is the child of n_i and n_i has no other children for $1 \leq i < j$, then this branch is merged as follows: The nodes n_3, \dots, n_{j-1} are removed, and the look-ahead information from the deleted nodes is pushed to n_j . Let $M_3, \dots, M_{j-1} \subseteq I$ be their sets of look-ahead information, then we replace the look-ahead information M_j of node n_j by $\bigcup_{i=3}^{j-1} M_i$. Note that after applying a merge, another linear branch segment might have been created, so the merge operation must be repeated until no changes occur.

We refer to this process as $\text{merge}(\cdot)$.

► **Lemma C.3.** *The set of look-ahead trees is finite.*

Proof. This follows directly from the inductive definition. The set of look-ahead summaries is finite, and linear branch segments are bounded in height. Hence, the set of look-ahead trees is finite. ◀

C.2 Construction of a Büchi deterministic SST

Now that we have defined look-ahead trees, we design an SST (that has no look-ahead) that simulates the run(s) of the deterministic two-way transducer with finite look-ahead.

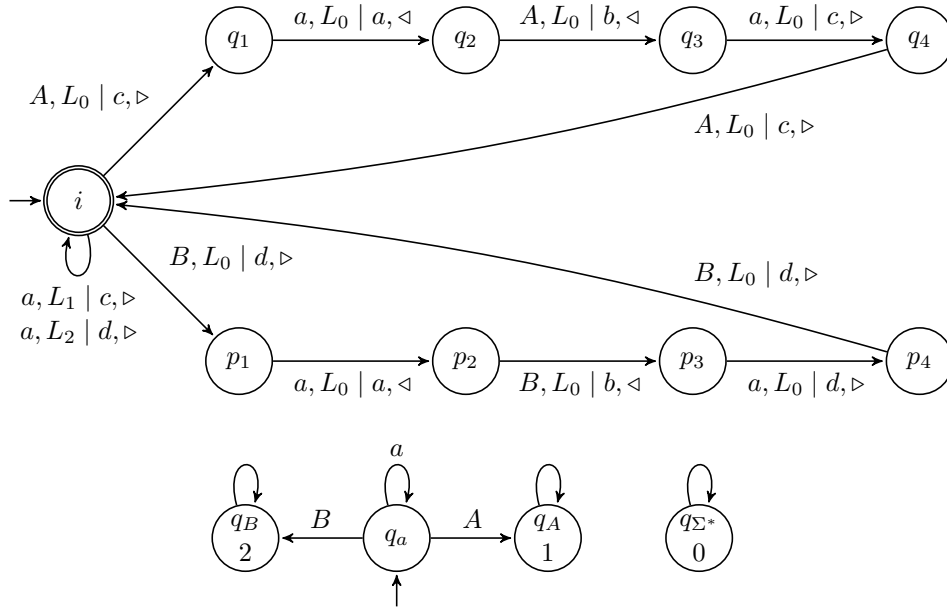

(a) Top: a deterministic two-way transducer with finite look-ahead. Bottom: the corresponding look-ahead automaton.

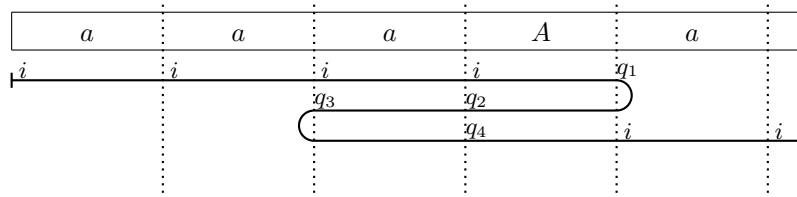

(b) Run of the transducer on the input $aaaAa \dots \in \Sigma^\omega$. Recall that the transducer always reads the symbol to the right, even when it moves to the left.

■ **Figure 5** A deterministic two-way transducer with finite look-ahead and a corresponding run.

The main difficulty is that in order to simulate the run of the two-way transducer the streaming string transducer does not have a priori access to the information which look-ahead succeeds. Hence, the SST must follow all possible runs and verify whether the assumed look-aheads are indeed enabled. For each simulated transition of the transducer, this might take an unbounded amount of time. Thus, it is not possible to store the followed runs in the state space of the SST until it clear which run is the right one.

In the section above, we introduced look-ahead trees. In the following we give a construction that allows us to store an abstract representation of the followed runs using look-ahead trees.

Our goal is to design a BSST \mathcal{S} , given an input word $u \in \Sigma^\omega$, that on a prefix u' of u maintains the (abstract) information which left-to-right runs on u' are possible and which right-to-right runs are possible. Furthermore, the output of these runs must be stored in appropriate registers, so that it can be used to build the output of the SST as soon as it is clear which of these (partial) runs are part of the (overall) run that the transducer takes.

Now, we describe the states of the SST, how a run is represented by a state, and which registers of the SST contain the output of the run and how to update the designated output register **out**.

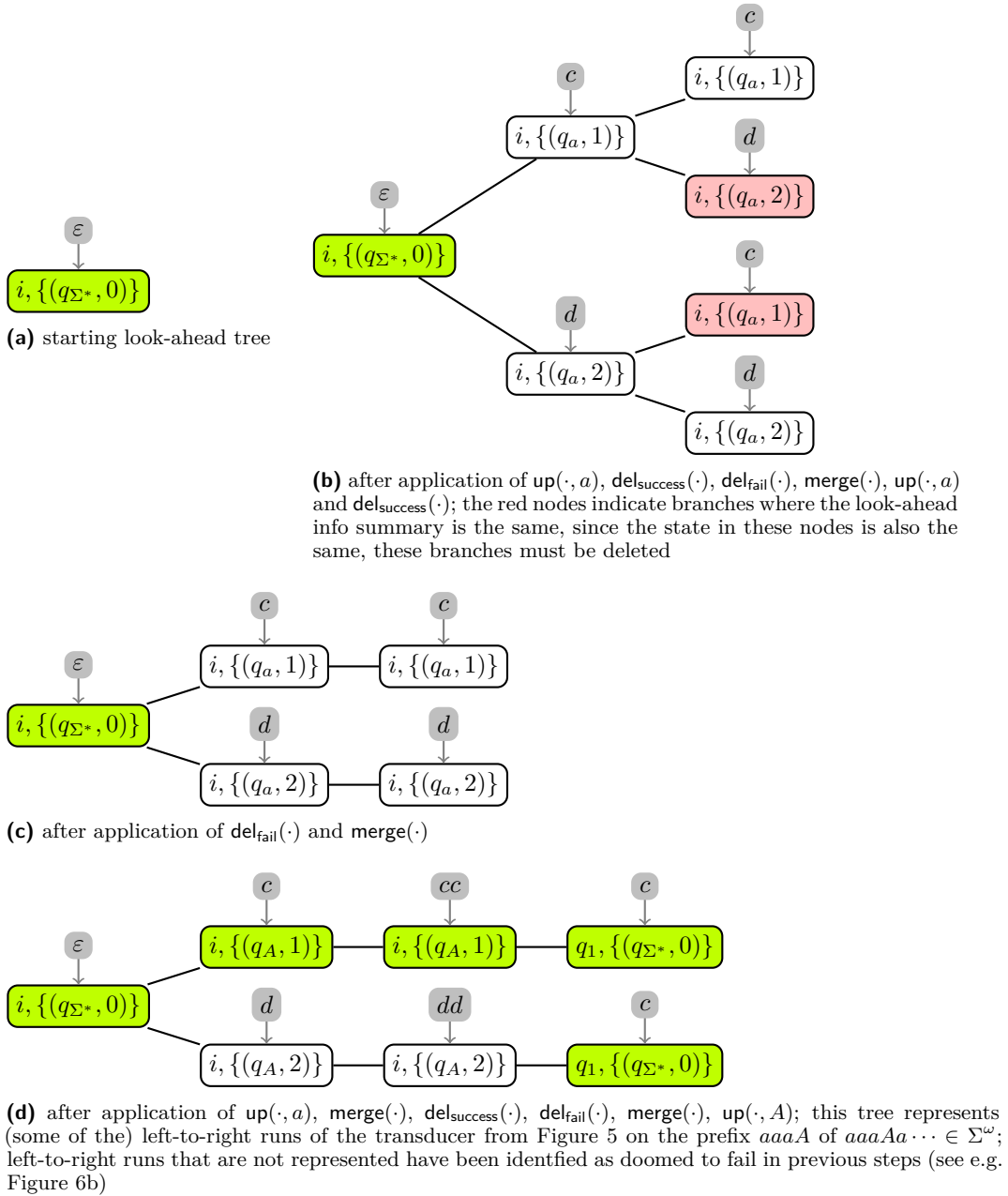

■ **Figure 6** Overview of how to represent left-to-right runs and right-to-right runs using look-ahead trees based on the transducer given in Figure 5 on the input $aaaAa \dots \in \Sigma^\omega$. The Figures 6a, 6c, 6e, 6f, and 6h represent objects that are stored in the state space of the SST that is constructed for the the transducer given in Figure 5. The Figures 6b, 6d, and 6g represent intermediate construction steps to determine a new state of the SST. All gray nodes in these figures represent registers and their contents. The second part of the figure can be found on Page 33.

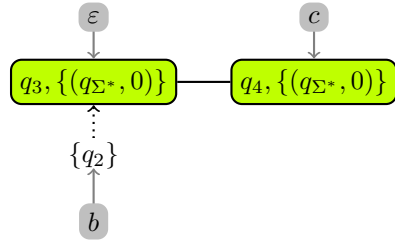

(e) This look-ahead tree and associated set represent a right-to-right from q_2 to q_3 of the transducer from Figure 5 on the prefix aaa of $aaaAa \dots \in \Sigma^\omega$.

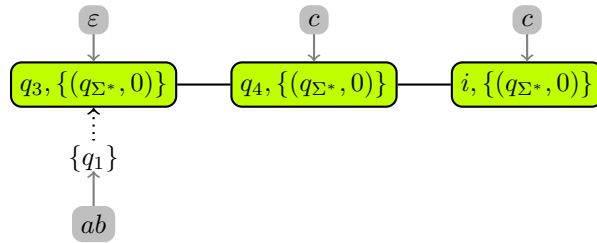

(f) This look-ahead tree and associated set represent a right-to-right from q_1 to q_4 of the transducer from Figure 5 on the prefix $aaaA$ of $aaaAa \dots \in \Sigma^\omega$.

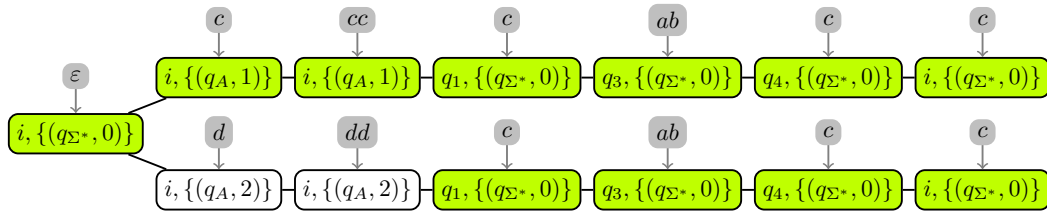

(g) The left-to-right runs represented in Figure 6d and the right-to-right run represented in Figure 6f can be connected. This shows the resulting representation.

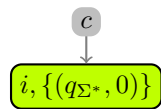

(h) The result of applying the operations $\text{del}_{\text{success}}(\cdot)$, $\text{del}_{\text{fail}}(\cdot)$ and $\text{merge}(\cdot)$ to the tree in Figure 6g. The output $\epsilon \cdot c \cdot cc \cdot c \cdot ab \cdot c$ from the removed part has been added to the register out.

■ **Figure 6** Overview of how to represent left-to-right runs and right-to-right runs using look-ahead trees based on the transducer given in Figure 5 on the input $aaaAa \dots \in \Sigma^\omega$. The Figures 6a, 6c, 6e, 6f, and 6h represent objects that are stored in the state space of the SST that is constructed for the the transducer given in Figure 5. The Figures 6b, 6d, and 6g represent intermediate construction steps to determine a new state of the SST. All gray nodes in these figures represent registers and their contents. The first part of the figure can be found on Page 32.

A visualization of these steps is given in Figure 6.

Basically, for a prefix $u' \in \Sigma^*$ of $u \in \Sigma^\omega$, we want to represent all of its left-to-right and left-to-left runs and their store outputs on u' .

We state more precisely what a left-to-right and a right-to-right run is. Recall that by assumption in a configuration (q, i) of \mathcal{T} on u either only transitions moving right are enabled or one transition moving left (because there is no look-ahead to be verified when moving left).

► **Definition C.4** (left-to-right run, right-to-right run). *On a prefix $u' \in \Sigma^*$ of $u \in \Sigma^\omega$, a left-to-right (resp. right-to-right) run from p to q is a run starting in $(p, 0)$ (resp. starting in $(p, |u'|)$) and ending in $(q, |u'|)$ such that in $(q, |u'|)$ only \triangleright -transitions are enabled and no position $> |u'|$ is visited in the run. Note that this definition enforces that right-to-right runs must take at least one transition.*

Let s_0 be the starting state of \mathcal{S} . We first describe the state of \mathcal{S} that is reached after reading a letter $\sigma \in \Sigma$ from s_0 and its associated runs on the prefix σ and register contents.

Then, we describe how to determine from the state reached at $u' \in A^*$ the state reached at $u'\sigma$ for some $\sigma \in \Sigma$ as well as its associated runs and register contents.

After reading a , let the register **out** hold ε . On the prefix $\sigma \in \Sigma$, we might have several left-to-right runs of the form $(q_0, 0)(q', 1)$ where $\delta(q_0^A, \sigma, L) = (q', \triangleright)$.

It is easy to see that these run are represented in the look-ahead tree $\text{up}((q_0, \{(q_{\Sigma^*}, 0)\}), \sigma)$ by following the path from the root to the corresponding leaf. To the root node of t we associate a register (say \mathfrak{r}) with content ε . To a leaf we associate a register with content $\lambda(\tau)$ if τ was the transition that enabled this move.

Then the output of a run $(q_0, 0)(q', 1)$ is given by $\llbracket \text{out} \rrbracket \llbracket \mathfrak{r} \rrbracket \llbracket \mathfrak{l} \rrbracket$ where \mathfrak{l} is the register that was added for the transition that lead to $(q', 1)$.

Formally, to determine the right-to-right runs on some prefix, we need to know one more input letter as a right-move from position i to $i - 1$ depends on the input letter i . So for ease of presentation, wlog., we assume that this piece of information is always given.

On the prefix $\sigma \in \Sigma$ (say the next letter is σ'), we might have right-to-right runs of the form $(q_1, 1)(q_2, 0) \cdots (q_n, 1)$ where $n \geq 3$ is an odd number, a right-move must be made in $(q_n, 1)$, and $\delta(q_i, \sigma') = (q_{i+1}, \triangleleft)$ for all odd $i \leq n$ and $\delta(q_i, \sigma, L_{j_i}) = (q_{i+1}, \triangleright)$ for all even $i \leq n$. Such a run is represented by a pair of a look-ahead tree and a set of states as follows: The look-ahead tree is $(q_n, \{\bigcup_{i=2, i \text{ even}}^{n-2} (q_0^A, j_i)\})$ and its associated state set is $\{q_1\}$. We associate a register (say \mathfrak{r}) to the root node of the tree with content ε and a register (say \mathfrak{s}) to q_1 that stores $\lambda(\tau_1)\lambda(\tau_2) \cdots \lambda(\tau_{n-1})$ where $\tau_1 \cdots \tau_{n-1}$ is the sequence of transitions taken in the run $(q_1, 1)(q_2, 0) \cdots (q_n, 1)$. Then its output is given by $\llbracket \mathfrak{s} \rrbracket \llbracket \mathfrak{r} \rrbracket$.

Now we describe the general step. Let $u' \in \Sigma^*$ be a non-empty prefix of $u \in \Sigma^\omega$, let s be the state of \mathcal{S} reached after reading u' , let the next input letter be a and the next but one input letter σ' .

The state s stores one look-ahead tree t and possibly several pairs $(t_1, M_1), \dots, (t_n, M_n) \in \text{LAT} \otimes \mathcal{P}(Q)$, where LAT is the set of look-ahead trees and $\mathcal{P}(Q)$ is the powerset of Q (the state set of the two-way transducer \mathcal{T}).

We assume following invariants about t, t_1, \dots, t_n . For ease of presentation, if π is a path in a tree let $\pi_{\mathfrak{R}}$ denote its associated sequence of registers $\mathfrak{r}_1 \cdots \mathfrak{r}_j$. We then use $\llbracket \pi_{\mathfrak{R}} \rrbracket$ to denote $\llbracket \mathfrak{r}_1 \rrbracket \cdots \llbracket \mathfrak{r}_j \rrbracket$.

► **Claim C.5.** In t , let π be a path from the root to a leaf with label of the form (q, X) . Then there exists a left-to-right of \mathcal{T} on u' from q_0 to q with output $\llbracket \text{out} \rrbracket \llbracket \pi_{\mathfrak{R}} \rrbracket$.

In (t_i, M_i) , let π be a path from the root to a leaf with label of the form (q, X) , and let $p \in M_i$ and \mathfrak{r} be the register associated to $p \in M_i$. Then there exists a right-to-right of \mathcal{T} on u' from p to q with output $\llbracket \mathfrak{r} \rrbracket \llbracket \pi_{\mathfrak{R}} \rrbracket$.

▷ **Claim C.6.** If $u \in \text{Dom}(\mathcal{T})$ the output $\mathcal{T}(v)$ can be written as $\llbracket \text{out} \rrbracket v$ for some $v \in \Gamma^\omega$ and there exists a path π from the root to a leaf in t such that $\llbracket \pi_{\mathfrak{R}} \rrbracket \sqsubseteq v$.

Note that Claims C.5 and C.6 are also valid for the state reached on a prefix $\sigma \in \Sigma$.

To determine the next state of \mathcal{S} , we construct

$$\tilde{t} = \text{up}(t, \sigma), \text{ and } \tilde{t}_i = \text{up}(t_i, \sigma)$$

for all $1 \leq i \leq n$. To each of the newly inserted leaves we associate a register that holds the output of the transition that was used to construct this leaf.

Clearly, if π is a path from the root to a leaf in t and π' is a path from the root to a leaf in \tilde{t} such that $\pi \sqsubseteq \pi'$: If π represents a left-to-right run of \mathcal{T} on u' from q_0 to q with output $\llbracket \text{out} \rrbracket \llbracket \pi_{\mathfrak{R}} \rrbracket$, then π' represents a left-to-right run of \mathcal{T} on $u'a$ from q_0 to q' with output $\llbracket \text{out} \rrbracket \llbracket \pi'_{\mathfrak{R}} \rrbracket = \llbracket \text{out} \rrbracket \llbracket \pi_{\mathfrak{R}} \rrbracket \llbracket \mathfrak{r} \rrbracket$ where \mathfrak{r} is the register associated to the leaf introduced for the transition $\delta(q, \sigma, L) = (q', \triangleright)$.

For the trees $\tilde{t}_1, \dots, \tilde{t}_n$ we update the associated sets M_1, \dots, M_n . Let \tilde{M}_i be the set that contains q if there is a state $p \in M_i$ and a transition $\delta(p, \sigma') = (q, \triangleleft)$. Furthermore, let \mathfrak{r} be the register associated to $p \in M_i$, we associate to $q \in \tilde{M}_i$ a register \mathfrak{s} and let $\mathfrak{s} \mapsto v\mathfrak{r}$ where v is output of the transition $\delta(p, \sigma') = (q, \triangleleft)$.

If the set \tilde{M}_i is empty, then we remove the pair $(\tilde{t}_i, \tilde{M}_i)$, because this indicates that it is not possible to extend the right-to-right runs of \mathcal{T} on u' represented by (t_i, M_i) to right-to-right runs of \mathcal{T} on $u'\sigma$.

It is easy to see that if $p \in M_i$ (with associated register \mathfrak{r}) and $q \in \tilde{M}_i$ (with associated register $\tilde{\mathfrak{r}}$) and $\delta(p, \sigma') = (q, \triangleleft)$ with output o , and π is a path from the root to a leaf with label of the form (p', X) in t_i and π' is a path from the root to a leaf with label of the form (q', X') in \tilde{t}_i and $\pi' \sqsubseteq \pi$ and $\delta(p', \sigma, L) = (q', \triangleright)$ with output o' : Then if π represents a right-to-right run of \mathcal{T} on u' from p to q with output $\llbracket r \rrbracket \llbracket \pi_{\mathfrak{R}} \rrbracket$, then π' represents a right-to-right run of \mathcal{T} on $u'\sigma$ from p' to q' with output $\llbracket \tilde{\mathfrak{r}} \rrbracket \llbracket \pi'_{\mathfrak{R}} \rrbracket = o \llbracket r \rrbracket \llbracket \pi_{\mathfrak{R}} \rrbracket o'$.

We now check if there is $(\tilde{t}_i, \tilde{M}_i)$ and $(\tilde{t}_j, \tilde{M}_j)$ such that these have to be combined in order to (eventually) represent proper right-to-right runs.

This is the case if the following situation occurs. There is a leaf with label (q, X) in \tilde{t}_i and in configuration $(q, |u'\sigma|)$ there is no right move enabled and there is $q \in \tilde{M}_j$. We make the following changes:

- We change $(\tilde{t}_i, \tilde{M}_i)$ such that in \tilde{t}_i the leaf with label (q, X) gets (a copy of) \tilde{t}_j as a subtree (i.e. we connect this leaf to the root of (a copy of) \tilde{t}_j). The content of the register associated to the (copy of) \tilde{t}_j , say \mathfrak{r} , is updated $\mathfrak{r} \mapsto \mathfrak{s}\mathfrak{r}$ where \mathfrak{s} is the register associated to $q \in \tilde{M}_j$.
- From the set M'_j the entry q is deleted as we have connected the runs beginning in q to the runs ending in q . If the set \tilde{M}_j is empty after removing a state, the pair $(\tilde{t}_j, \tilde{M}_j)$ is no longer necessary and can be deleted.

These combination steps must be repeated until there are no more pairs that can be combined. Let $(\hat{t}_1, \hat{M}_1), \dots, (\hat{t}_m, \hat{M}_m)$ be the pairs that remain after these steps. It is not difficult to see that these pairs are representations of right-to-right runs of \mathcal{T} on $u'\sigma$. Furthermore note that there are possibly some right-to-right runs of \mathcal{T} on $u'\sigma$ that only visit the last letter σ . These runs are not represented by $(\hat{t}_1, \hat{M}_1), \dots, (\hat{t}_m, \hat{M}_m)$ as these represent runs

that already existed and could be extended. We have described for the prefix σ how to get representations of right-to-right runs that visit only one letter.

Finally, it might be possible to combine runs represented by \tilde{t} and runs represented by the pairs.

This is the case if there is a leaf with label (q, X) in \tilde{t} and in configuration $(q, |u'\sigma|)$ there is no right move enabled and there is $q \in M$ for some pair (\bar{t}, M) . The combination is done in the same way as described above. Again, these combination steps must be repeated until \tilde{t} can no longer be extended. Let us denote by \hat{t} the final result. It is easy to see that \hat{t} is a representation of left-to-right runs of \mathcal{T} on $u'a$.

There are three operations left to do.

From all trees, we remove those parts that represent successful run prefixes.

We distinguish whether we work on the tree \hat{t} that is a representation of left-to-right runs, or on some tree \bar{t} from a pair (\bar{t}, M) that is a representation of right-to-right runs.

We consider the former case. We construct $\text{del}_{\text{success}}(\hat{t})$. If a path segment π of \hat{t} has been removed in this operation (aka. a new root was chosen), then it is easy to see that $\llbracket \text{out} \rrbracket \llbracket \pi_{\mathfrak{R}} \rrbracket \sqsubseteq \mathcal{T}(u)$ if $u \in \text{Dom}(\mathcal{T})$. We update out accordingly, let $\text{out} \mapsto \text{out } \mathfrak{r}_1 \cdots \mathfrak{r}_j$ where $\mathfrak{r}_1 \cdots \mathfrak{r}_j$ is the register sequence associated to the removed path π .

We consider the latter case. We also construct $\text{del}_{\text{success}}(\bar{t})$ for some (\bar{t}, M) . The removed part of \bar{t} models a partial run on which all look-aheads have been verified (aka. witnesses have been seen). Hence, the look-ahead information is no longer required, we just need to remember the output of this partial run. The output of this partial run is obtained by concatenating the output of the registers that are associated to the removed path. We push the output of removed path to the new root node. In the paragraph below we perform a similar operation for which we give a bit more formal details.

From all trees, we remove those parts that represent runs that fail. This is done by applying the operations $\text{del}_{\text{fail}}(\cdot)$.

Finally, to obtain proper look-ahead trees, we apply the operation $\text{merge}(\cdot)$ to every tree. Recall that a linear branch segment is merged by pushing all the look-ahead information to the last node. We need to do the same for the associated output. Hence, let $n_1 \cdots n_j$ be the sequence of nodes that is merged such that n_1 and n_j are kept, and let $\mathfrak{r}_1 \cdots \mathfrak{r}_j$ be the associated register sequence, then we make the update $\mathfrak{r}_j \mapsto \mathfrak{r}_2 \mathfrak{r}_3 \cdots \mathfrak{r}_{j-1} \mathfrak{r}_j$.

Now, we have defined a look-ahead tree t' and a set $\{(t'_1, M'_1), \dots, (t'_k, M'_k)\}$ of pairs of a look-ahead trees and a state set as well as register associations to every tree node resp. set entry and how to update them. The next transition taken by \mathcal{S} updates the registers as described and the reached state stores t' and $\{(t'_1, M'_1), \dots, (t'_k, M'_k)\}$. Note that the invariants Claims C.5 and C.6 remain valid as outlined in the construction.

C.3 Correctness proof

Before we prove our main technical lemma about the construction, we argue that the number of pieces of information to be stored in a state of \mathcal{S} is bounded as well as the number of used registers.

Recall that LAT is the finite set of look-ahead information trees. The information stored in a state is an element of $\text{LAT} \times \mathcal{P}(\text{LAT} \times \mathcal{P}(Q_A))$. Let $(t, \{(t_1, M_1), \dots, (t_n, M_n)\})$ be a state. The number of registers needed to store information relevant to this state is bounded by $b_1 + b_2$, where b_1 is the number of nodes in the trees t, t_1, \dots, t_n and b_2 is $|M_1| + \dots + |M_n|$.

► **Lemma C.7.** *Let $u \in \Sigma^\omega$, for $i \geq 1$, let u_i denote the prefix of u of length i . Let LR_i denote the set of left-to-right runs of \mathcal{T} on u_i , let RR_i denote the set of right-to-right runs*

of \mathcal{T} on u_i .

If $u \in \text{Dom}(\mathcal{T})$, let ρ_u denote the accepting run of \mathcal{T} on u . The sequence ρ_u can be factorized such that we have factors that describe a left-to-right run on u_i and possibly factors that describe right-to-right runs on u_i . Let $LR_i^{\text{acc}} \subseteq LR_i$ and $RR_i^{\text{acc}} \subseteq RR_i$ denote these sets of runs. The former set is a singleton.

Let c_i be the configuration (current state and register contents) of \mathcal{S} after reading u_i , let s_i be the state of \mathcal{S} . The following properties hold.

1. The state s_i represents a subset of LR_i and RR_i .
2. If $\rho \in LR_i \cup RR_i$ is represented, then for its associated sequence of registers π holds that $\llbracket \pi \rrbracket = \text{out}(\rho)$ in c_i .
3. If $u \in \text{Dom}(\mathcal{T})$, then s_i represents a superset of LR_i^{acc} and RR_i^{acc} .
4. If $u \in \text{Dom}(\mathcal{T})$, then $\llbracket \text{out} \rrbracket \sqsubseteq \mathcal{T}(u)$ in c_i .

Proof. It is easy to see, that Items 1 and 2 are a direct consequence of Claim C.5 and Items 3 and 4 are a direct consequence of Claim C.6.

We proof the statement of Claims C.5 and C.6 by induction over the length of the considered prefixes.

For the induction base, the considered prefix is a letter $\sigma \in \Sigma$. We have explicitly given the reached state on $\sigma \in \Sigma$ and the register content $\llbracket \text{out} \rrbracket$. Clearly Claims C.5 and C.6 holds.

For the induction step, let the claims be true for a prefix of length $i \geq 1$, we show that it remains true for a prefix of length $i + 1$. We have shown in the above construction that the claims remain valid when constructing the successor state and register updates. \blacktriangleleft

► Lemma C.8. *Let $u \in \Sigma^\omega$, if $u \in \text{Dom}(\mathcal{T})$, then the register **out** is updated infinitely often (by appending a non-empty word) in the run of \mathcal{S} on u .*

Proof. First, we note that if $u \in \text{Dom}(\mathcal{T})$, then $\mathcal{T}(u)$ is infinite.

To show the desired statement, we revisit the construction of \mathcal{S} . Recall that the register content of **out** is updated (by appending output) whenever the application of the operation $\text{del}_{\text{success}}(\cdot)$ removes a successful non-empty path π from the tree that represents the left-to-right runs of \mathcal{T} on the current prefix of the input word. Such a successful path can only exist again and again if the accepting run of \mathcal{T} on u is represented. This is guaranteed by Item 3 of Lemma C.7. The output that is appended is the content of the sequence of the registers associated to π . By Item 4 of Lemma C.7 we know that we build $\mathcal{T}(u)$ this way. Since $\mathcal{T}(u)$ is infinite, infinitely many of these removed paths must have a corresponding sequence of registers whose content forms a non-empty word.

It is left to show, that infinitely often $\text{del}_{\text{success}}(\cdot)$ removes a successful path. Let t_i denote the look-ahead tree representing the possible left-to-right runs after processing an infix of length $i \geq 1$. Note that when computing the tree t_{i+1} from t_i , the only operation that can change the *number* of look-ahead information in a node is the operation $\text{merge}(\cdot)$. But by definition, this operation never changes the number of look-ahead information stored in the root and in its children. Furthermore, note that all look-ahead information belonging to the accepting run eventually succeed (as this is the definition of the run being accepting). Hence, as the accepting run is represented, updating the look-ahead information in the root and in the child corresponding to the accepting run will eventually result in these nodes having succeeded. Then they are removed by the operation $\text{del}_{\text{success}}(\cdot)$. \blacktriangleleft

It remains to define the Büchi acceptance condition of \mathcal{S} . Essentially, \mathcal{S} keeps track of the run(s) of \mathcal{T} on the input. Whenever the register **out** is updated, another segment of the accepting run of \mathcal{S} has been determined. This run segment is then no longer stored in

the state space of \mathcal{S} . We need to change the SST such that whenever a run segment of the accepting run is removed, the SST visits a final state iff the run segment has seen a final state. Note that this information is not directly recoverable from the stored abstraction but is easily added to the abstraction.

► **Lemma C.9.** *Let $u \in \Sigma^\omega$. The BSST \mathcal{S} has an accepting run on u iff $u \in \text{Dom}(\mathcal{T})$.*

Proof. This is a direct consequence of the above definition of the Büchi acceptance condition which mimics the Büchi acceptance condition of the two-way transducer. ◀

► **Lemma C.10.** *The BSST \mathcal{S} is bounded copy.*

Proof. Let $\mathcal{S} = (\Sigma, \Gamma, Q_{\mathcal{S}}, q_0^{\mathcal{S}}, \delta_{\mathcal{S}}, \mathfrak{R}, \text{out}, \lambda')$. Our goal is to show that \mathcal{S} is 1-bounded, i.e. for all $u \in \Sigma^\omega$ and $i \leq j$ such that $\lambda_i^u \circ \dots \circ \lambda_j^u$ is defined, this substitution is 1-bounded. A substitution τ is 1-bounded if for all $\mathfrak{r}, \mathfrak{s} \in \mathfrak{R}$, \mathfrak{r} occurs at most once in $\tau(\mathfrak{s})$. Instead of a formal proof, we give an intuitive justification of this claim.

First of all, we note that the only reason why the constructed BSST is not copyless, is because of register updates that are made for registers associated to elements in M in pairs of the form (t, M) which are used to represent right-to-right runs on prefixes.

Recall that the tree t from a pair (t, M) stores information about the transitions of right-to-right runs that move right, and the set M simply stores states from which a right-to-right run is possible. Also recall that transitions that move to the left do not use look-ahead. This is the reason why we do not have a tree structure to represent a subsequent series of left-moves because no look-ahead has to be verified. Hence, no intermediate information must be kept.

So, recall that if \mathcal{S} reaches a state s_i on the prefix $u[1:i] \in \Sigma^*$ of the input $u \in \Sigma^\omega$ that contains a pair (t, M) such that $p \in M$ then this means there is a right-to-right run of the transducer on $u[1:i]$ that begins in p .

If in the next step \mathcal{S} reaches a state s_{i+1} on the the prefix $u[1:i+1] \in \Sigma^*$ that contains a pair (t', M') which is the result of updating the pair (t, M) and there is $p_1, p_2 \in M'$, because there are transitions $(p_1, \sigma) \mapsto (p, \triangleleft)$ and $(p_2, \sigma) \mapsto (p, \triangleleft)$ then this means there is a right-to-right run of the transducer on $u[1:i+1]$ that begins in p_1 resp. p_2 .

Recall that the register that stores output related to $p \in M$ for the pair (t, M) , say $\text{out}_p^{(t, M)}$, is used to define the registers that store output related to $p_1, p_2 \in M'$ for the pair (t', M') , say $\text{out}_{p_1}^{(t', M')}$ and $\text{out}_{p_2}^{(t', M')}$.

The key to prove that every substitution is 1-bounded is that in the end either only the right-to-right run of the transducer on $u[1:i+1]$ that begins in p_1 or the run that begins in p_2 can be relevant for the accepting run of the transducer because the transducer is deterministic. So, going forward, the registers $\text{out}_{p_1}^{(t', M')}$, $\text{out}_{p_2}^{(t', M')}$ will never contribute to the same register. ◀

We need one last auxiliary lemma before we can proof Theorem 5.2. Namely, that we do not need the Büchi acceptance condition.

► **Lemma C.11.** *For every BSST \mathcal{T}_1 there exists an equivalent BSST \mathcal{T}_2 such that all its states are final.*

Proof. The BSST \mathcal{T}_1 can easily be changed such that all of its states are final states. Therefore, in \mathcal{T}_2 , we need to introduce a new register, say \mathfrak{r} , whenever \mathcal{T}_1 would update the designated output register out , the output is appended to \mathfrak{r} instead. Whenever \mathcal{T}_1 would visit a final state the register content in \mathfrak{r} is appended to out and \mathfrak{r} is cleared.

To see that $\llbracket \mathcal{T}_1 \rrbracket = \llbracket \mathcal{T}_2 \rrbracket$, it suffices to realize the following: If an input word $u \in \Sigma^\omega$ is in the domain of $\llbracket \mathcal{T}_1 \rrbracket$, then in the infinite run of \mathcal{T}_1 on u

- \mathcal{T}_1 infinitely often visits a final state, and
- the length of the content in **out** tends towards infinity.

Hence, in the infinite run of \mathcal{T}_2 on u the register **out** is infinitely often updated and the length of the content tends to infinity. If an input word $u \in \Sigma^\omega$ is not in the domain of $\llbracket \mathcal{T}_1 \rrbracket$, then either the run visits final states only finitely often, or the length of the content in **out** does not tend towards infinity. In the first case, the register **out** is only finitely many times updated in the run of \mathcal{T}_2 on u , so length of the content in **out** does not tend towards infinity (meaning the run is rejecting). In the second case, the length of the content in **out** does not tend towards infinity anyway. ◀

Finally, we are ready to give the proof of look-ahead removal theorem.

Proof of Theorem 5.2. It is a direct consequence of Item 4 of Lemma C.7 and Lemmas C.8 and C.9 that $\llbracket \mathcal{T} \rrbracket = \llbracket \mathcal{S} \rrbracket$, i.e. the deterministic two-way transducer with finite look-ahead and the deterministic Büchi SST recognize the same function.

Since the deterministic SST is bounded copy as shown in Lemma C.10 an equivalent deterministic two-way transducer can be constructed as shown in [9, Theorem 3.7] (recall that we re-stated this in Theorem 2.9). As already noted in Remark 2.10, the cited result makes the assumption that the bounded copy SST only has final states (which we can guarantee using Lemma C.10. By construction, all states of the resulting deterministic two-way transducer are final states. ◀

C.4 Extension with safety constraints

We add safety constraints to deterministic two-way transducers with finite look-ahead. It is a 2-dT^{FLA} \mathcal{T} with an additional mapping S from any transition t to a regular language of finite words $S(t)$. If \mathcal{T} triggers transition t at input position i on a word $u \in \Sigma^\omega$, then it must additionally make sure that $u[i:j] \in S(t)$ holds for all $j \geq i$, otherwise the run dies. We show that while safety constraints are properties of infinite suffixes, they do not add extra computational power to 2-dT^{FLA} .

A *deterministic two-way transducer with finite look-ahead and safety constraints* ($2\text{-dT}_S^{\text{FLA}}$) is a tuple $\mathcal{T}' = (\Sigma, \Gamma, Q, q_0, F, \delta, \lambda, S)$ such that $\mathcal{T} = (\Sigma, \Gamma, Q, q_0, F, \delta, \lambda)$ is a 2-dT^{FLA} , called the underlying 2-dT^{FLA} of \mathcal{T}' , and $S : \delta \rightarrow \mathcal{R}^*(\Sigma)$ maps any transition to a regular language of *finite* words, called a *safety constraint*. The semantics is defined as follows: on an input $u \in \Sigma^\omega$, \mathcal{T}' moves from a configuration (q, i) to a configuration (q, j) , following a transition t , if (i) \mathcal{T} moves from (q, i) to (q, j) by transition t , and (ii) $u[i:k] \in S(t)$ for all $k \geq i$. It should be clear that due to this extra constraint, we have the following property about the functions $f_{\mathcal{T}}$ and $f_{\mathcal{T}'}$ recognized by \mathcal{T} and \mathcal{T}' respectively: $\text{dom}(f_{\mathcal{T}'}) \subseteq \text{dom}(f_{\mathcal{T}})$ and they both coincide on $\text{dom}(f_{\mathcal{T}'})$. Transitions are denoted $p \xrightarrow{\sigma, L|w, C} q$, whenever $t = (p, \sigma, L, q) \in \delta$ and $S(t) = C$. Also, note that if for all transitions t , $S(t) = \Sigma^*$, then \mathcal{T}' is obviously equivalent to its underlying 2-dT^{FLA} \mathcal{T} .

► **Lemma C.12.** *A function is computed by a $2\text{-dT}_S^{\text{FLA}}$ iff it is computed by a 2-dT .*

Proof. The proof is a slight extension of the proof of Theorem 5.2. Hence, we only describe the changes. We integrate the verification of the safety constraints into the translation from the transducer to an equivalent SST. Therefore, we extend the nodes of look-ahead trees to also store information about the safety constraints. Assume that the safety languages are

given by deterministic finite automata, say the safety language C_i is given by the DFA \mathcal{C}_i . Whenever a new node in a look-ahead tree is created based on a transition t with safety constraint $S(t) = C_i$ for some i , then the node stores the initial state of \mathcal{C}_i . Whenever a look-ahead tree is updated based on a letter $\sigma \in \Sigma$ (denoted as $\text{up}(\cdot, \sigma)$), then every stored state from a safety automaton is also updated according to σ . If a state indicates that a safety constraint has been violated, the node is considered as failed and branches with the failed node can be removed from the tree. When nodes of a tree are merged, their the safety information is also merged. \blacktriangleleft

C.5 Extension with finite look-around

We consider here two-way transducers with the ability to test a finite prefix from the current position (look-ahead), and to test the prefix up to the current position (look-behind). Both are combined into a *look-around*, which is a regular language of pointed words, where only one position is pointed, which corresponds to the current position. Formally, for an alphabet Σ , we let $\dot{\Sigma} = \{\dot{\sigma} \mid \sigma \in \Sigma\}$. A *pointed word* is a finite word in $\Sigma^* \dot{\Sigma} \Sigma^*$. A *finite look-around* is regular language of pointed words.

A *deterministic two-way transducer with finite look-around* is a tuple of the form $\mathcal{T} = (\Sigma, \Gamma, Q, q_0, F, \delta, \lambda)$ defined as a 2-dT^{FLA} but the type of δ is $Q \times (\Sigma \uplus \{\vdash\}) \times \mathcal{LAR}^*(\Sigma) \rightarrow Q \times \{\triangleright, \triangleleft\}$ where $\mathcal{LAR}^*(\Sigma)$ is the set of finite look-arounds over Σ . As for 2-dT^{FLA} , it is required that: (i) $\text{dom}(\delta)$ is finite, (ii) all the look-arounds occurring on transitions with same source state and same input symbol are disjoint. As for 2-dT^{FLA} , to ensure determinism, when several look-arounds are successful, only transition with look-around having length-minimal witness is picked (it is unique by disjointness). If no look-around succeeds, the computation fails. More precisely, in a configuration (q, i) on an input word u , if $u[i] = \sigma$, then the run follows the transition $\delta(q, \sigma, L)$ such that L has minimal j in the set $\{j \mid \exists L' \cdot \delta(q, \sigma, L')$ is defined and $u[:i-1] \dot{\sigma} u[i+1:j] \in L'\}$.

Likewise, we further extend this model to deterministic two-way transducers with finite look-around and safety constraints ($2\text{-dT}_S^{\text{FLAR}}$). Our goal is now to show that 2-dT are as expressive as $2\text{-dT}_S^{\text{FLAR}}$.

► **Lemma C.13.** *A function is computed by a $2\text{-dT}_S^{\text{FLAR}}$ iff it is computed by a 2-dT .*

Proof. Intuitively, any look-around can be decomposed into a finite union of look-behind and look-ahead. We use this observation to prove that any $\mathcal{T} \in 2\text{-dT}_S^{\text{FLAR}}$ can be decomposed into:

- a 1-dT which annotates the input with look-behind information (the set of states reached by the look-around automata on the prefix so far)
- a $2\text{-dT}_S^{\text{FLA}}$ which simulates \mathcal{T} on the annotated input

In more formal details, let $\mathcal{T} \in 2\text{-dT}_S^{\text{FLAR}}$ over an input alphabet Σ . Let us assume that any look-around L is given by a DFA \mathcal{A}_L with set of states Q_L and set of final states F_L . Given a state $q \in Q_L$, we denote by Right_L^q the set of words in Σ^* , accepted by \mathcal{A}_L where the initial state is replaced by q . Symmetrically, let Left_L^q be the set of words in Σ^* , accepted by \mathcal{A}_L where the set of final states is replaced by $\{q\}$. Clearly:

$$L = \bigcup_{q \in Q_L, \sigma \in \Sigma} \bigcup_{p \in Q_L \cdot \delta_L(q, \sigma) = p} \text{Left}_L^q \dot{\sigma} \text{Right}_L^p$$

We now describe the first function \mathbf{t} which tags the input with look-behind information. Let \mathcal{L} be the set of all look-around occurring on the transitions of T . Let $Q = \biguplus_{L \in \mathcal{L}} Q_L$. The

first function is defined by $\mathbf{t} : \Sigma^\omega \rightarrow (\Sigma \times 2^Q)^\omega$ which given a word $u \in \Sigma^\omega$ and a position i , replaces $u[i]$ by $(u[i], P)$ where P are all the states reached by the look-around automata over input $u[:i-1]$. In particular, the first letter is tagged with the set of initial states of the look-around automata.

The second function, to be composed with \mathbf{t} , is realized by a $2\text{-dT}_S^{\text{FLA}}$ M which simulates \mathcal{T} but only uses look-ahead, thanks to the annotation of its inputs. In particular, consider a transition of \mathcal{T} of the form $x \xrightarrow{\sigma, L|v, L_{\text{saf}e}} (y, d)$ where x, y are states of \mathcal{T} , $\sigma \in \Sigma$, L is a look-around, $L_{\text{saf}e}$ is a safety constraint, $v \in \Gamma^*$ is an output word, and d a direction. For any $P \subseteq Q$, we create in M the transitions $x \xrightarrow{(\sigma, P), \text{Right}^q, L_{\text{saf}e}|v} (y, d)$ for all $q \in Q_L$ such that there exists $p \in P$ such that $\delta_L(\sigma, p) = q$. We also have to ensure disjointness. Consider two transitions of M the form

$$\begin{array}{l} p \xrightarrow{(\sigma, P), \text{Right}^{q_1} | v_1, L_{\text{s}f_1}} p_1 \\ p \xrightarrow{(\sigma, P), \text{Right}^{q_2} | v_2, L_{\text{s}f_2}} p_2 \end{array}$$

It could be the case that Right^{q_1} and Right^{q_2} are not disjoint. In that case, we replace those two transitions as follows (taking an arbitrary order between q_1 and q_2):

$$\begin{array}{l} p \xrightarrow{(\sigma, P), \text{Right}^{q_1} \setminus \text{Right}^{q_2} | v_1, L_{\text{s}f_1}} p_1 \\ p \xrightarrow{(\sigma, P), \text{Right}^{q_2} | v_2, L_{\text{s}f_2}} p_2 \end{array}$$

We apply this rewriting on all transitions until the disjointness condition is met. It is correct for the following reason. Assuming M runs on a word annotated with the function \mathbf{t} , then since the look-around of \mathcal{T} are disjoint, when q_1 and q_2 are states of two different look-around automata, only one look-ahead Right^{q_1} or Right^{q_2} succeeds, otherwise it would contradict disjointness. If q_1 and q_2 are states of the same look-around automaton, only one of the two look-ahead can succeed by determinism of this look-around automaton (otherwise, there would be two different runs of the look-around automaton on the same pointed word, one going through q_1 , the other through q_2).

Finally, note that the tagging function \mathbf{t} can be realized by a 1-dT all states of which are final. So, we have proved that \mathcal{T} can be defined as a composition of a $2\text{-dT}_S^{\text{FLA}}$ and such an 1-dT . Since $2\text{-dT}_S^{\text{FLA}} = 2\text{-dT}$ by Lemma C.12, and 2-dT are closed under pre-composition with 1-dT all states of which are final, by Theorem 3.11 of [9], we get the desired result. \blacktriangleleft

C.6 Closure under composition: proof of Theorem 3.1

Proof of Theorem 3.1. Let $\mathcal{T}_1, \mathcal{T}_2$ denote two 2-dT . Our goal is to construct a deterministic two-way transducer *with look-around* that recognizes $\mathcal{T}_2 \circ \mathcal{T}_1$. Then, we use Lemma C.13 to obtain a deterministic two-way transducer.

The idea is to do a product construction. The behavior of \mathcal{T} is determined by the combined behaviors of \mathcal{T}_1 and \mathcal{T}_2 . At each step, given an input letter $\sigma \in \Sigma$, \mathcal{T} simulates a matching transition $t_1 \in \delta_1$, then simulates an end-to-end run ρ_2 of \mathcal{T}_2 on the production $\lambda_1(t_1) \in \Gamma^*$, and then produces the corresponding output $\text{out}(\rho_2)$.

We assume that \mathcal{T} is in a state such that the component of \mathcal{T}_1 resp. \mathcal{T}_2 is in state $p \in Q_1$ resp. $q \in Q_2$.

If \mathcal{T}_2 is moving forward, then we need to advance the run of \mathcal{T}_1 . We can use the determinism of \mathcal{T}_1 to update the component of \mathcal{T}_1 according to $t_1 := (p, \sigma) \mapsto (p', d) \in \delta_1$, and we simulate \mathcal{T}_2 entering $\lambda_1(t_1) \in \Sigma^*$ from the left. Hence, \mathcal{T} contains a transition of the

form $((q, p), \sigma) \mapsto ((q', p'), d)$, where q' is the target state of the end-to-end run ρ_2 on output $\lambda_1(t_1) \in \Sigma^*$ starting from the left in q . The output of the transition is $\text{out}(\rho_2)$.

If \mathcal{T}_2 is moving backward, then we need to rewind in the run of \mathcal{T}_1 . However, \mathcal{T}_1 is not co-deterministic, so at this point we need to make use of the look-around feature.

Assume that for each transition $t := (p', \sigma) \mapsto (p, d) \in \delta_1$ we have a look-around L_t that holds in a configuration (p, i) of \mathcal{T}_1 if it can be reached from (p', i') via application of the transition t . We explain below how to construct such look-arounds.

Hence, the look-around L_{t_1} is enabled if the previously used transition was some $t_1 := (p', \sigma) \mapsto (p, d) \in \delta_1$. The 2-dT \mathcal{T} simulates \mathcal{T}_2 entering $\lambda_1(t_1) \in \Gamma^*$ from the right. Thus, \mathcal{T} contains a transition of the form $((q, p), \sigma) \mapsto ((q', p'), d)$, where q' is the target state of the end-to-end run ρ_2 on the production $\lambda_1(t_1) \in \Gamma^*$ starting from the right in q . The output of the transition is $\text{out}(\rho_2)$.

Regarding the acceptance component of \mathcal{T} , it suffices to combine the Büchi conditions of \mathcal{T}_1 and \mathcal{T}_2 .

Now we explain how to obtain the desired look-arounds using deterministic two-way automata. We then use the fact that deterministic two-way automata have the same expressive power as deterministic one-way automata (aka. both models recognize regular languages) and the translation is effective [26].

First, recall that a look-around is a regular language of finite pointed words; and when a look-around is evaluated in the computation of a deterministic two-way transducer with look-around, then the pointed letter is located at the position that the two-way transducer currently reads. Hence, if the two-way transducer \mathcal{T}_1 has reached some configuration (p, i) and we want to determine the predecessor configuration of \mathcal{T}_1 using a two-way automaton on the input where position i has the pointed letter, then the automaton can simply go to the beginning of the word, then simulate the run of \mathcal{T}_1 until it reaches the pointed letter in state p and remember the transition that was taken to arrive there.

Note that such a two-way automaton only must visit the finite prefix of the input that the two-way transducer has visited so far. Thus, it is clear that we indeed define a *finite* look-around. Furthermore, it is easy to see that the look-arounds to be verified when the transducer \mathcal{T}_1 is in a state p at position i (to determine the successor configuration of (p, i)) are all pair-wise disjoint, because if not it would imply that two different runs would lead to the same configuration (p, i) which is a contradiction as \mathcal{T}_1 is deterministic. ◀

D Logic-transducer correspondence: proof of Theorem 4.8

D.1 Structure of the proof

The proof goes through several intermediate models. We give here an overview of the chain of (effective) model transformations that is used to prove the logical characterization. We start from an MSOT_g \mathcal{T}_0 .

1. first, \mathcal{T}_0 is converted into a jumping MSO_g -transducer \mathcal{T}_1 , by Lemma 6.3.
2. \mathcal{T}_1 is converted into a walking MSO_g -transducer \mathcal{T}_2 , by Lemma D.1
3. \mathcal{T}_2 is converted into the composition $\mathcal{T}_3 \circ \mathcal{U}_1$ of a 2-dT $_5^{\text{FLAR}}$ \mathcal{T}_3 (an extension of 2-dT with look-around and safety constraints, as defined in Section C.5), and a 1-dT \mathcal{U}_1 all states of which are final (see Lemma D.2).
4. \mathcal{T}_3 is then converted into a composition $\mathcal{T}_4 \circ \mathcal{U}_2$ of a 2-dT $_5^{\text{FLA}}$ \mathcal{T}_4 and a 1-dT \mathcal{U}_2 all state of which are final (see Lemma C.13). It shows how to transform look-arounds into look-aheads.

5. \mathcal{T}_4 is converted into a 2-dT \mathcal{T}_5 , by Lemma C.12, whose proof is an extension with safety constraints of the look-ahead removal construction of Theorem 5.2
6. it yields that \mathcal{T}_0 is equivalent to $\mathcal{T}_5 \circ \mathcal{U}_2 \circ \mathcal{U}_1$ where \mathcal{T}_4 is a 2-dT and $\mathcal{U}_1, \mathcal{U}_2$ are 1-dT all states of which are final. Theorem 3.11 of [9] shows that deterministic regular functions are effectively closed under precomposition with functions defined by 1-dT all states of which are final (actually, the result is slightly more general). Therefore, \mathcal{T}_0 is equivalent to a 2-dT \mathcal{T}_6
7. finally, \mathcal{T}_6 is converted into a MSOT_g \mathcal{T}_7 equivalent to \mathcal{T}_0 , by Lemma 6.1, closing the chain of transformations.

D.2 Proof of Lemma 6.1

Proof. Let $\mathcal{T} = (\Sigma, \Gamma, Q, q_0, F, \delta, \lambda)$ be a 2-dT recognizing f . By Remark 2.10, we can assume that $Q = F$. Wlog we also assume that $Q = \{1, \dots, n\}$ for some $n \in \mathbb{N}$, and $q_0 = 1$. We also assume that $|\lambda(q, \sigma)| \leq 1$ for all $q \in Q$ and $\sigma \in \Sigma$, and $|\lambda(q, \vdash)| = 0$. If \mathcal{T} produces more than one symbol at once, then they can be produced in several steps by doing a series of U-turns. Similarly, the second assumption can be ensured by forcing the transducer to make some U-turns and producing what it was supposed to produce on \vdash , but on the 2nd symbol instead.

We define an MSOT_g $\mathcal{M} = (k, (\phi_S^{c,d})_{c,d}, (\phi_\gamma)_\gamma, \phi_{\text{fst}}^{c_0})$ such that $\llbracket \mathcal{M} \rrbracket = f$. It takes exactly n copies of the input, i.e. $k = n$. Intuitively, each copy corresponds to a state of \mathcal{T} . The successor relation from a copy p to a copy q summarizes sequences of non-producing transitions starting in state p , and followed by exactly one transition to q , producing some symbol. The label predicates are defined by considering precisely this last symbol.

Formally, let $q = \delta(\vdash, q_0)$. Then, we let $c_0 = q$ and $\phi_{\text{fst}}^{c_0}(x) = \text{first}(x)$. Then, given two states p, q , we let $\text{Run}^{p,q}(x, y)$ the binary predicate which expresses the existence of a finite run of \mathcal{T} , which starts at position x in state p (it reads the label of x), ends in state q after reading position y , produces no output symbols except at the very last transition. It is standard to show that this predicate is MSO-definable over finite words, based on the correspondence between regular languages of finite words and MSO. Then, we let $\Phi_S^{p,q}(x, y) = \exists \mathbf{g} \cdot x \leq \mathbf{g} \wedge y \leq \mathbf{g} \wedge \text{Run}^{p,q,\mathbf{g}}(x, y)$ where $\text{Run}^{p,q,\mathbf{g}}(x, y)$ is exactly $\text{Run}^{p,q}(x, y)$ where all quantifiers are guarded by \mathbf{g} (so that $\text{Run}^{p,q,\mathbf{g}}(x, y)$ is interpreted over a *finite* prefix of the input).

Finally, the label predicates are defined similarly: $\phi_\gamma^p(x)$ expresses that there exists a finite run from the initial position in state q_0 to position x and state q , such that the last transition produces the symbol γ . As before, this can be expressed by a guarded formulas. ◀

D.3 Proof of Lemma 6.2

Given a MSO_g -transducer \mathcal{T} , our goal is to construct an equivalent deterministic two-way transducer with look-around and safety constraints \mathcal{T}' (an extension of deterministic two-way transducers ($2\text{-dT}_5^{\text{FLAR}}$, defined in Appendix C), and conclude by Lemma C.13, which states that this extension is equivalent to 2-dT. There are two main differences with $2\text{-dT}_5^{\text{FLAR}}$: (i) jumping MSO_g -transducers jump while $2\text{-dT}_5^{\text{FLAR}}$ walk, and (ii) safety constraints in jumping MSO_g -transducers are properties of all finite prefixes starting in the first input position and that include the current position, while safety constraints in $2\text{-dT}_5^{\text{FLAR}}$ are properties of all finite prefixes starting in the current position.

We decompose the proof into two lemmas which respectively address those two difficulties. Lemma D.1 below states that any jumping MSO_g -transducer is equivalent to a *walking* MSO_g -transducer, that is a MSO_g -transducer such that $\phi_{\text{mv}}(x, y) \Rightarrow S(x, y) \vee S(y, x)$ holds, for any jumping formula $\phi_{\text{mv}}(x, y)$ occurring on its transition. Then, Lemma D.2 below states that any walking MSO_g -transducer defines a deterministic regular function. The combination of the two lemmas give the proof of Lemma 6.2.

► **Lemma D.1.** *Any jumping MSO_g -transducer is equivalent to a walking MSO_g -transducer.*

Proof. Let \mathcal{T} be a jumping MSO_g -transducer. The transformation of \mathcal{T} into a walking transducer \mathcal{T}' is standard and follows the same line as [21, 13]. Thanks to Büchi's-Elgot-Trakhtenbrot's theorem, any jumping formula $\phi_{\text{mv}}(x, y)$ of \mathcal{T} is converted into a DFA $A_{\phi_{\text{mv}}}$ over finite words with two pointed positions x and y , i.e., words over the alphabet $\Sigma \times 2^{\{x, y\}}$ in which x and y occurs exactly once. In particular, we have $L(A_{\phi_{\text{mv}}}) = \{(\sigma_1, s_1) \dots (\sigma_n, s_n) \mid \exists 1 \leq i, j \leq n \cdot \sigma_1 \dots \sigma_n \models \phi_{\text{mv}}(i, j) \text{ and } \forall 1 \leq k \leq n, i = k \leftrightarrow x \in s_k, j = k \leftrightarrow y \in s_k\}$. When \mathcal{T} triggers a transition

$$p \xrightarrow{\phi_{\text{la}}(x) \mid w, \phi_{\text{mv}}(x, y), \phi_{\text{sf}}(x)} q$$

instead \mathcal{T}' moves to a sub-transducer $\mathcal{T}_{\phi_{\text{mv}}}$ which simulates the move of the DFA $A_{\phi_{\text{mv}}}$ (and produces ε all the time). We explain the simulation of $A_{\phi_{\text{mv}}}$ in the case where $x < y$. $\mathcal{T}_{\phi_{\text{mv}}}$ starts at current position x , and uses some look-around (actually a look-behind) to determine the state reached by $A_{\phi_{\text{mv}}}$ on the prefix so far, with its last position pointed by x , i.e., the state reached by $A_{\phi_{\text{mv}}}$ on input $(\sigma_1, \emptyset) \dots (\sigma_{k-1}, \emptyset)(\sigma_k, \{x\})$, where $\sigma_1 \dots \sigma_k$ is the input prefix up to the reading head position. It then starts to simulate $A_{\phi_{\text{mv}}}$ in the state determined by the look-around. Then, for any subsequent transition, $\mathcal{T}_{\phi_{\text{mv}}}$ uses finite look-ahead to determine whether the current position, call it y , satisfies $\phi_{\text{mv}}(x, y)$ or whether it should continue the simulation of $A_{\phi_{\text{mv}}}$. To do so, it checks with look-aheads, if there exists a finite word $v = (\sigma_1, \{y\})(\sigma_2, \emptyset) \dots (\sigma_n, \emptyset)$ such that $\sigma_1 \dots \sigma_n$ is a prefix of the current infinite suffix (the one starting at the current position), such that the run of $A_{\phi_{\text{mv}}}$ can be continued to an accepting run on v . If the finite look-ahead succeeds, then $\mathcal{T}_{\phi_{\text{mv}}}$ knows that $\phi_{\text{mv}}(x, y)$ holds and that the current position is y , and it gives back the control to \mathcal{T}' . Note that $\mathcal{T}_{\phi_{\text{mv}}}$ does not need to check that y is unique. Indeed, the assumption in the definition of jumping MSO_g -transducers guarantees that if at some point two positions y satisfy $\phi_{\text{mv}}(x, y)$, then there cannot be an infinite run of \mathcal{T} on the input word, and so no infinite run of \mathcal{T}' as well. ◀

► **Lemma D.2.** *Any walking MSO_g -transducer \mathcal{T} defines a deterministic regular function.*

Proof. Let \mathcal{T} be a jumping MSO_g -transducer. We express \mathcal{T} as the composition of a deterministic regular function f_{sf} defined by a 1-dT \mathcal{T}_{sf} which annotates the input with information useful to check safety constraints, and a walking MSO_g -transducer \mathcal{T}' such that the safety constraints are MSO -formulas $\psi_{\text{sf}}(x)$ restricted to positions larger than x . So, in addition to upper-guard, quantified variables are also restricted to range over positions larger than x . Note that \mathcal{T}' is nothing but a 2-dT $^{\text{FLAR}}$, whose look-around and safety constraints are defined by MSO_g -formulas.

We now proceed to the definition of f_{sf} and the construction of \mathcal{T}' . Intuitively, all formulas $\phi_{\text{sf}}(x)$ are converted into DFA and the function f_{sf} annotates the input with some states reached by those DFA on the prefix so far. This information can then be exploited to have safety constraints that talk only about the prefixes starting in the current position.

More precisely, any formula $\phi_{\text{sf}}(x)$ occurring on some transition of \mathcal{T} is converted into a DFA $A_{\phi_{\text{sf}}}$ over finite pointed words. We assume that all the DFA have disjoint sets of states, and let Q be their union. Then, the function $f_{\text{sf}} : \Sigma^\omega \rightarrow (\Sigma \times 2^Q)^\omega$ annotates the input word as follows: over an input $u \in \Sigma^\omega$, for any position i , $f_{\text{sf}}(u)[i] = (u[i], P)$ where $P \subseteq Q$ is the set of states reached by all the DFAs over the prefix $u[:i]$ in which $u[i]$ is pointed. So, $f_{\text{sf}}(u)[i]$ contains the states of the DFAs right after they have “selected” position i . Note that each set P contains at most one state per DFA $A_{\phi_{\text{sf}}}$, because they are deterministic. It is easily seen that the function f_{sf} can be realized by an 1-dT, which simulates all the DFAs in parallel.

Then, \mathcal{T}' runs on input words over alphabet $\Sigma \times 2^Q$, and exploits the information given by f_{sf} as follows: for each transition $t = p \xrightarrow{\phi_{\text{la}}(x)|w, \phi_{\text{mv}}(x,y), \phi_{\text{sf}}(x)} q$ of \mathcal{T} and each subset $P \subseteq Q$, we create the transition t_P of \mathcal{T}'

$$t_P = p \xrightarrow{\phi_{\text{la}}^P(x)|w, \phi_{\text{mv}}^P(x,y), \phi_{\text{sf}}^P(x)} q$$

where:

- $\phi_{\text{la}}^P(x)$ is the conjunction of $\bigvee_{\sigma \in \Sigma} (\sigma, P)(x)$ (to check that the second input label component is P), and of the formula $\phi_{\text{la}}(x)$ in which any occurrence of a predicate $\sigma(y)$, for all $\sigma \in \Sigma$, is replaced by $\bigvee_{R \subseteq Q} (a, R)(y)$.
- $\phi_{\text{mv}}^P(x, y)$ is $\phi_{\text{mv}}(x, y)$ where the label predicates are modified as before
- $\phi_{\text{sf}}^P(x)$ is \perp if P contains more than one state of $A_{\phi_{\text{sf}}}$, or none. If P contains exactly one state s of $A_{\phi_{\text{sf}}}$, then $\phi_{\text{sf}}^P(x)$ expresses the existence of a finite prefix on which there exists an accepting run of $A_{\phi_{\text{sf}}}$ starting at position $x + 1$ in state s .

Note that the safety constraints now only talks about the prefixes starting at the current position.

We also need to make sure that the look-arounds on transitions with same source state are disjoint, i.e. they are not mutually satisfiable. Consider two transitions:

$$\begin{array}{l} p \xrightarrow{\phi_{\text{la}}^P(x)|w_1, \phi_{\text{mv}}^P(x,y), \phi_{\text{sf}}^P(x)} q \\ p \xrightarrow{\psi_{\text{la}}^R(x)|w', \psi_{\text{mv}}^R(x,y), \psi_{\text{sf}}^R(x)} q' \end{array}$$

We know by definition of \mathcal{T}' , that $\phi_{\text{la}}(x)$ and $\psi_{\text{la}}(x)$ are disjoint, by definition of \mathcal{T} . This disjointness transfers to the modified formulas $\phi_{\text{la}}^P(x)$ and $\psi_{\text{la}}^R(x)$, for any sets $P, R \subseteq Q$, because the models of $\phi_{\text{la}}^P(x)$ (resp. of $\psi_{\text{la}}^R(x)$), when projected on alphabet Σ , are exactly the models of $\phi_{\text{la}}(x)$ (resp. $\psi_{\text{la}}(x)$).

Finally, by Lemma C.13, we know that \mathcal{T}' is effectively equivalent to some 2-dT, hence it defines a deterministic regular function. Note that \mathcal{T}_{sf} is a 1-dT all states of which are final. Composing such transducers with deterministic regular functions is known to yield deterministic regular functions only, by Theorem 3.11 of [9]. ◀

Final arguments for the proof of Lemma 6.2 The statement of Lemma 6.2 is a direct consequence of Lemma D.1 which transforms any jumping MSO_g -transducer into a walking MSO_g -transducer, of Lemma D.2, which proves that the latter defines deterministic regular functions.