

Dual-Material 3D-Printed PaCoMe-Like Fingers for Flexible Biolaboratory Automation

Henning Zwirnmann, Dennis Knobbe, Utku Culha and Sami Haddadin

Abstract—Robotic automation in life science research is a paradigm that has gained increasing relevance in recent years. Current solutions in this area often have limited scope, such as pick-and-place tasks for a specific object. Thus, each new process requires a separate toolset, which prevents the realization of more complex workflows and reduces the acceptance of robotic automation tools. Here, we present a novel finger system for a parallel gripper for biolaboratory automation that can handle a wide range of liquid containers. This flexibility is enabled by developing the fingers as a dual-extrusion 3D print. The coating with a soft material from the second extruder in one seamless print and the fingertip design are key features to enhance grasping capabilities. By employing a passive compliant mechanism that was previously presented in a finger called “PaCoMe”, a simple actuation system and a low weight are maintained. The ability to resist chemicals and high temperatures and the integration with a tool exchange system make the fingers usable for daily laboratory use and complex workflows. We present their task suitability in several experiments showing the wide range of vessels that can be handled as well as their tolerance against displacements and grasp stability.

I. INTRODUCTION

Not least due to the still ongoing COVID-19 pandemic, research in biological laboratories (biolabs) has recently gained scale and medial attention [1]. In pursuing this endeavor, researchers often prefer manual task execution over automation approaches despite the advantages the latter can bring e.g. in terms of reproducibility and efficiency [2]. They do not deploy robotic laboratory helpers due to their high costs, low flexibility or ineptitude for the tasks in question [3]. If a team decides to use a robot despite these obstacles, the most common devices are liquid handling machines [4]. What is often neglected is generic and efficient robotic execution of the preceding and subsequent steps, i.e., handling liquid containers and transporting them between different stations in the laboratory.

A typical process that involves the handling of many different containers is PCR preparation [5]: A sample is cultured in either a flask or a Petri dish, from which it is transferred to a PCR vial to extract its DNA. To this end, specific reagents are added that are stored in cryogenic tubes. The DNA is then pipetted into a 96-well plate and supplemented with ultrapure water, which is often present in 1 L bottles. The variety of containers in this common process shows that it is inefficient and more prone to errors to use a separate gripping tool for each vessel. Instead, it makes sense to rely on one gripper to handle all containers, as is the natural case for a human.

All authors are with the Chair of Robotics and Systems Intelligence, Munich Institute of Robotics and Machine Intelligence, Technical University of Munich, 80797 Munich, Germany. Corresponding author: henning.zwirnmann@tum.de

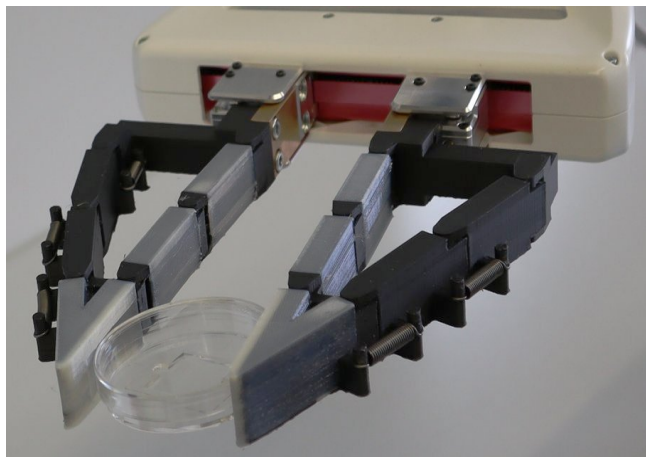

Fig. 1. Fingers developed by the authors holding Petri Dish.

While there is a wide range of end effectors for handling different items with a robotic arm, they do not meet many biolab-specific requirements. Birglen has presented underactuated fingers called “PaCoMe” (*Passive Cord Mechanism*) for a 1-degree-of-freedom parallel gripper that can grasp a variety of containers using either a pinch or a power grasp [6]. Designed for use in industrial applications, these fingers are not suitable for handling specific biolab labware such as Petri dishes with a loose lid on top. Tlegenov et al. presented a three-fingered underactuated gripper that is also 3D-printable [7]. Although this design might facilitate grasping a Petri dish, wider items such as 96-well plates or glass bottles cannot be picked up this way.

Grippers made of inherently soft materials are based on a different design philosophy [8]. Especially those using the Fin Ray Effect and commercialized in several products by Festo lend themselves to flexible employment in various scenarios [9]. This gripper type adapts its shape dynamically to the object in question in an engulfing grasp and can thus carry relatively heavy items. However, especially for the items described in Section II-A that are picked up with a pinch grasp from the top, the contact area is very small. This limits the weight that can be transported, rendering this type of gripper unsuitable for intended use.

A third variant of conceivable end effectors are anthropomorphic hands. Today, they are capable of adapting to a variety of shapes, such as in [10]. This flexibility comes at the cost of high electromechanical complexity with several actuators that lead to high weight, a complicated control system, and potentially high costs. Because of these drawbacks, we did not consider them for usage in our biolab. However, we acknowledge that future developments in this area can lead to a solution that also fulfills the requirements.

In lab-specific robotic systems, researchers often make

use of 1-degree-of-freedom grasping tools: Liquid handling workstations, e.g. Beckman Coulter Biomek Cell Workstation [11], typically come with standard parallel grippers that can reliably move rectangular containers such as 96-well plates inside the device. Although this is a simple design approach, it limits the range of equipment that can be handled to the necessary minimum. The same applies to the Mobile Robotic Chemist, for which the authors used a simple parallel gripper to handle their labware [12]. Fleischer et al. described a dual-arm robot that performs different transport and manipulation tasks in the laboratory [13]. They equipped a parallel gripper with different fingers that depend on the main tasks of the arms. Although this approach allows for more flexibility, the range of tools is still limited to two finger pairs at the same time, and it requires the availability of two robotic arms.

To address the shortcomings of the solutions presented regarding robotic biolab automation, we have developed a novel finger system for a parallel gripper. By designing it as a seamless 3D print for a dual extrusion printer, its properties could be tested and adjusted as part of a rapid prototyping process. The fine-tuned tip can handle a wide range of laboratory containers while providing good force transmission for sensitive and intelligent manipulation tasks. Employing a soft filament using the second extruder is an essential innovation that improves grasping stability, thus combining the advantages of hard and flexible materials. Underactuation as a passive mechanism allows heavy objects to be transported while maintaining a simple actuation system and a lightweight design. Eventually, the integration with a tool exchange system and resistance to high temperatures and chemicals allow for the application of the system in complex biolaboratory workflows.

The remainder of the paper is organized as follows: We first deduce a taxonomy of common biolab liquid containers with respect to their handling requirements (Section II-A). After defining further properties that a gripper must satisfy (Section II-B), we discuss the extent to which the solutions presented above and our approach meet these requirements in Section II-C. In Section III we present the design of the fingers and the fabrication steps. The application of our fingers is validated in Section IV by presenting the results of several qualitative and quantitative experiments. Finally, we show limitations of our solution and provide an outlook in Section V.

II. REQUIREMENT ANALYSIS

A. Taxonomy of Biolaboratory Containers

To define the necessary requirements that a gripper must meet, we initially compiled a list of liquid containers that are regularly used in a biolab. We categorized them in a hierarchy based on their grasping-related properties (cf. Fig. 2): The first separation we make is based on their weight, thus differentiating between light items that can be precisely placed using a pinch grasp (up to 300 g with liquid), and heavy equipment transported using a power grasp (up to 1500 g with liquid). The latter category consists of bottles that are heavy, owing to both their material and the amount of liquid contained. For pinch grasps, we differentiate further by the width and diameter, respectively, of the items in question: Different types of tubes are the thinnest containers that are handled. In particular, medium-sized vessels span Petri dishes. Cell culture flasks and 96-well plates with widths greater than 8 cm are the widest items that need to be handled. For further manipulation, we eventually differentiate by the closing mechanism of a vessel: Centrifuge and cryotubes, cell culture flasks and many heavy bottles are closed with a screw cap. PCR tubes as well as other bottles come with a snap cap. Petri dishes have a loose lid on top, whereas well plates are either open or eventually sealed with foil. The last row in the taxonomy shows exemplary containers that can also be seen in Fig. 3.

We note here that this taxonomy might not be comprehensive: Special biolab tasks could require different containers or variants of the ones listed here. Especially for commercially available liquids, the variety of bottles is to be estimated high. However, particularly for the pinch grasp scenario, our taxonomy shows the vessels that are used for the most relevant biolab tasks (see e.g. [14] for cell culture, or overviews provided by plasticware suppliers¹) and moreover are produced in standardized dimensions (see e.g. [15] for 96-well plates).

B. Gripper Requirements

Based on the container taxonomy in Section II-A we can deduce the requirements for a biolab gripper: It must be able to perform precise placement of light containers with varying sizes and shapes, as well as stable transport of heavier ones. We require that a gripper can grasp at least a standard 96-well plate with a top width of 83 mm [15]. At the other end

¹e.g. <https://www.thermofisher.com/de/de/home/life-science/lab-plasticware-supplies.html>, last accessed 9 September 2022

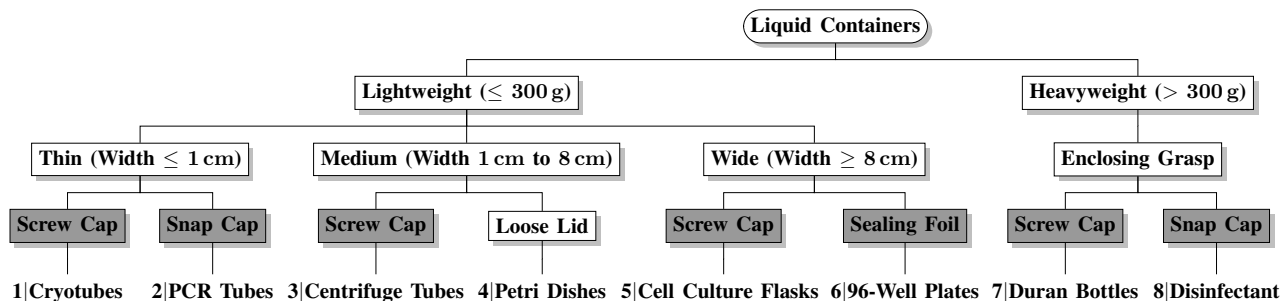

Fig. 2. Requirement-based taxonomy of biolab liquid containers (see Fig. 3 for numbers). Opening and closing lids with grey background can be done using other devices.



Fig. 3. Variety of biolab liquid containers with numbers according to Fig. 2.

of the scale, it should be able to perform stable grasps of thin containers, such as PCR and cryotubes that measure down to 6 mm in diameter. Of the four different closing mechanisms listed, the gripper is only required to handle the loose lid. Devices to open screw caps are readily available on the market because of their omnipresence [16]. The same applies to sealing 96-well plates, which has very different requirements that can be met by special sealing devices. Snap caps can be found in different varieties (Fig. 6), and fixtures in the laboratory in suitable positions can be used to open them.

In addition to being able to transport and manipulate the containers in question, we have identified additional demands that a gripper must fulfill in order to be usable as a versatile and productive robotic biolab tool:

Simple actuation system: As presented in Section I, solutions for robotic biolab automation today mainly employ a standard 1-degree-of-freedom parallel gripper. To keep complexity and associated costs low, we require that a gripper use a simple actuation system.

Fast and cheap fabrication: Due to changing requirements in a biolab, e.g. due to slight design differences between different labware vendors, a gripper should be flexible in terms of its design. One solution is to design it as a 3D print; thus, it can be redesigned and refabricated in a short amount of time and at low cost.

Usable in complex workflows: In order for a robotic system to act as a productive and versatile helper in the biolab, it needs to be able to use different tools in one workflow, e.g. by handling a pipette after provisioning a container. Although the optimal solution would be one tool to handle all tasks, an exchange system that allows the robot to switch tools is currently an alternative approach.

Can be sterilized and disinfected: Biolab equipment is often in direct contact with biologically active materials, e.g. cells, and can thus be contaminated. For sterilization, labware is inserted into an autoclave that creates pressurized steam at 121 °C. Therefore, to be reusable, a gripper must be able to withstand this treatment for 30 min to 60 min [14]. Disinfection additionally occurs with ethanol or isopropyl alcohol, which a gripper also has to resist.

Can be used for force-sensitive robotic manipulation tasks: Complex robotic workflows often necessitate integrating force feedback from the environment into task execution. To realize these workflows, we hence require good force transmission and a lightweight design of the gripper.

TABLE I. Requirement fulfillment of the state of the art and our solution (“S”).

| Requirement | [6] | [7] | [9] | [10] | [12] | [13] | S |
|---|-----|-----|-----|------|------|------|---|
| 1: Precision grasping | ✓ | ✓ | | ✓ | ✓ | ✓ | ✓ |
| 2: Heavy containers | ✓ | | ✓ | ✓ | | | ✓ |
| 3: Grasps wide and narrow containers | ✓ | | ✓ | ✓ | | ✓ | ✓ |
| 4: Tip suitability for different shapes | | ✓ | | ✓ | | | ✓ |
| 5: Simple actuation system | ✓ | ✓ | ✓ | | ✓ | ✓ | ✓ |
| 6: Fast and cheap fabrication | ✓ | ✓ | ✓ | | ✓ | ✓ | ✓ |
| 7: Allows multi-tool workflows | | | | ✓ | | ✓ | ✓ |
| 8: Temperature and chemical resistant | | | | | | ✓ | ✓ |
| 9: Force sensitive and lightweight | | ✓ | | | ✓ | ✓ | ✓ |

C. Requirement Fulfillment

We conclude the analysis of the requirements by matching the state of the art described in Section I with the requirements that are met by each solution as described in the publication in question. The results are summarized in Table I. We acknowledge that some of the requirements can be implemented with little effort, e.g. by using an appropriate filament.

III. FINGER DESIGN AND FABRICATION

A. Passive Compliant Mechanism

To meet the requirements of a simple actuation system and flexibility for both precise grasping and transporting heavy items, we decided to base our design on a passive compliant mechanism for a 1-degree-of-freedom parallel gripper. This choice allows following the way humans use different types of grasps for different containers: Light vessels, such as tubes, Petri dishes, or well plates, are placed at a specific location, e.g. in a device or on a rack, using a pinch grasp. For heavy containers, humans often resort to an enclosing power grasp where the contact area and thus grasping forces are increased.

Birglen’s “PaCoMe“-fingers [6] use one actuator at the base and three springs as passive elements and can thus perform pinch and power grasps. Based on this underactuated design, we also implemented our fingers with three springs. In contrast to the author, we placed the spring near the base at the inside to be able to use tension springs here as well as for the other links, while on the outside we would have needed to insert compression springs. Moreover, unlike Birglen’s, our fingers remain stiff when pushed against the outside of the outer links, thus granting good force transmission. Through this design, requirements 1, 2, 5, and 9 are satisfied. We provide a drawing of a finger in Fig. 4 and an overview of the measurements and other characteristics in Table II. We note that we accept the wide dimensions of this design to achieve flexibility for different grasps, while its miniaturization can be a desirable feature for future developments.

B. Fabrication as 3D Print

Our gripper was developed completely in SolidWorks (Dassault Systèmes, France), sliced in Cura 5.0 (Ultimaker, The Netherlands), and finally printed with an Ultimaker 3 Extended dual extrusion filament printer. We use heat-resistant PLA (CHRONOS PLAtch, OLYMPfila, Germany) as main material as it can resist temperatures of up to 125 °C after post-tempering. Thus, we satisfy the requirement that the gripper should be resistant to temperature and alcohol.

Arnitel ID 2045 (DSM, The Netherlands) is used for the second extruder to print certain features of the fingers

TABLE II. Finger characteristics

| Feature | Size |
|--|--------------------------|
| Length of inside links l_i | 3.5 cm |
| Length of outside links l_o | 3.4 cm |
| Joint length l_j | 0.8 cm |
| Tip length l_t | 4.7 cm |
| Finger length from base to tip l_{tot} | 16.5 cm |
| Finger height h | 2 cm |
| Link width w_l | 1 cm |
| Base width w_b | 6.45 cm |
| Outside springs rest length $l_{s,o}$ | 2.40 cm |
| Spring constant outside springs | 12.56 N cm ⁻¹ |
| Inside spring rest length $l_{s,i}$ | 1.79 cm |
| Spring constant of inside spring | 44.97 N cm ⁻¹ |
| Soft material layer width at tip inside | 3.1 mm |
| Soft material layer width around links | 0.7 mm |
| Weight (with springs) | 50 g |
| Weight (with springs and latch bolt) | 98 g |
| Price per print (without springs and latch bolt) | ≈ 3 € |

with a soft material (see Section III-C). This thermoplastic copolyester (TPC) has Shore hardness D 34 and is resistant to heat and chemicals in comparison to other common 3D-printable materials, e.g. NinjaTek Cheetah (Fenner Drives, Inc., USA).

As an alternative to dual-extrusion printing, we designed a mold into which a finger made of plain PLA is inserted and that is then filled with silicone (Mold Star 15 SLOW, Smooth-On, Inc., USA; Shore hardness A 15) to create a sleeve around the tip. We found this unfavorable because of too high friction and low durability. Because of the manual labor involved and the consequent lack of reproducibility, we eventually decided to adopt the dual-extrusion printing approach.

The fabrication in one print limits the amount of necessary post-processing to a minimum: Apart from removing print artifacts such as the brim and freeing the joints in case the parts stick together, only the springs and the latch bolt to mount the fingers to the gripper need to be attached. Thus, requirement 6 (fast and cheap fabrication) is met. We used this rapid prototyping approach to optimize the design of, among others, the joints and the fingertip as described in the following section.

C. Joint and Fingertip Design

To allow for a rotation of the six joints, fitting gap distances between their inner and outer parts (see Fig. 5a) were determined. In addition, stoppers were added to the appropriate sides of the joints to prevent overstretching.

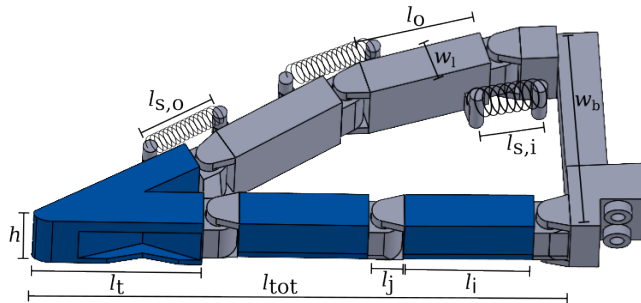

Fig. 4. Drawing of a right finger. Grey: Printed with PLA. Blue: Printed with Arnitel ID 2045.

A close-up image of the fingertip is shown in Fig. 5b. To accommodate the multitude of shapes in the pinch scenario (cf. Fig. 2), we designed it with a prismatic cutout. This feature enables the simultaneous grasp of a Petri dish and its lid, which is often wider than the container itself and lies loosely on top. Additionally, we slightly rounded the first centimeter of the tip so containers are “guided” into the opening. This feature is crucial because the maximum opening width of the gripper that we use is 83 mm, i.e. equal to the width of a 96-well plate.

To further enhance the grasping capabilities of the fingers, we use Arnitel ID 2045 (cf. Section III-B) as soft printing material for the tip and the two inside links. This feature mimics properties of human skin, which is also soft. Thus, the fingers adapt better to the shape of an object, shocks at the moment of grasping are dampened, and the friction between the fingers and containers is increased. By relying on a form closure, the stability of the dual-material print is guaranteed. These design considerations are crucial to satisfy requirements 3 and 4.

D. Robotic Arm and Tool Exchange System

We use a Franka Emika Research robotic arm to validate our solution and carry out the experiments described in Section IV. To this end, we mount our finger system to the Franka Emika Hand, a standard two-finger parallel gripper with one actuator. In order to enable the robot to exchange fingers autonomously, we employ the tool exchange system that has been described in [17]: It consists of a latch bolt that is mounted to the finger base and its counterpart that is fixed to the gripper side of the robotic arm. Fig. 5c shows the finger holder that is mounted to the wall and holds a finger while not in use. To pick up a finger, the robot moves the jaw against the latch bolt (1). With sufficient force, the bolt slips into place and a spring in the jaw secures it. To place the finger down again, the jaw is first moved against the two hooks on the right (2) that loosen the spring and release the finger. The latter is then placed again between the two bars (3), as seen in the picture. Thus, the robotic system can also employ other tools and perform complex workflows (requirement 7).

IV. EXPERIMENTAL RESULTS

A. Static Grasping Capabilities

Various static grasping scenarios are shown in Figs. 1 and 6. One can see that, depending on the container in question and the equipment it is used with, the orientations of the gripper and the fingers vary.

We note that we can indeed grasp and lift all containers listed. Depending on the container and the equipment it is used with, this happens in different orientations. For some containers, in particular for vials where many are handled in the same process, we make use of 3D-printed storage racks with suitable distances between the single containers.

B. Container Displacement Tolerance

To test the tolerance of our fingers with respect to small displacements of a container during grasping, we measured the maximum distance that the latter may have from an ideal position while still ensuring a stable grasp. This occurred along all three base frame dimensions for the various grasp types shown in Fig. 6. x points along the edge of the

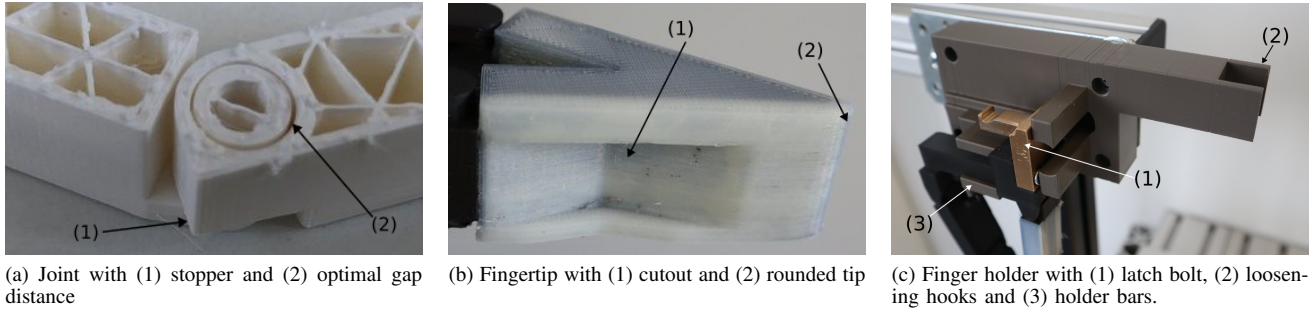

Fig. 5. 3D-printed features of the finger system

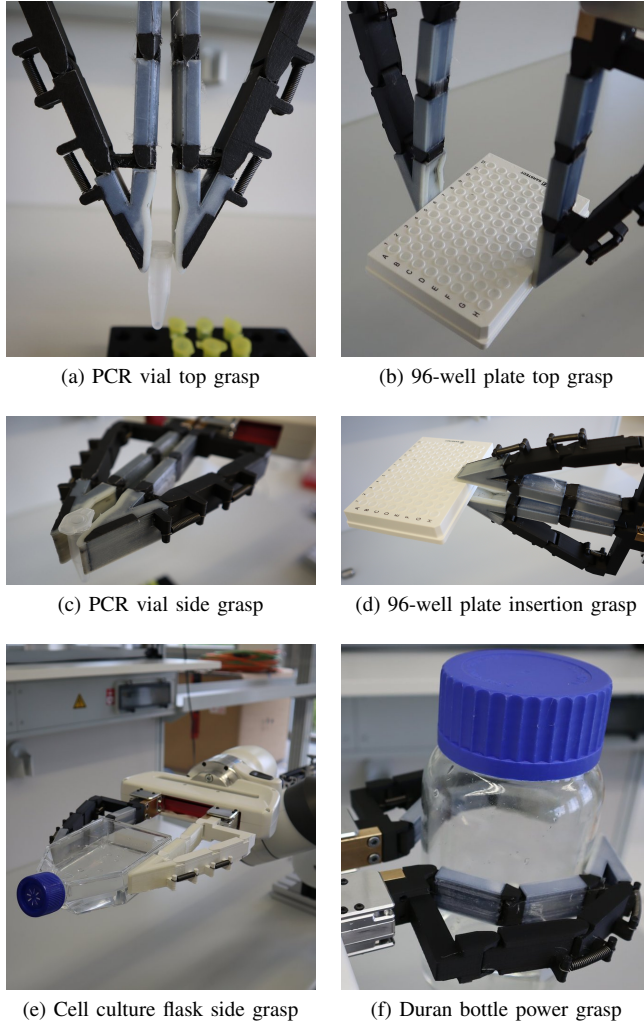

Fig. 6. Grasping scenarios

table, y along its depth, and z to the top (cf. Fig. 9a). The gripper opening is thus facing the y direction, or (negative) z direction for the top grasp.

For displacements below 1 cm the measurement accuracy is 0.1 cm while above it is 0.5 cm. The results are shown in Fig. 7. In general we note that the tolerance is low in cases where the object size is close to the maximum opening width of the gripper (e.g. 96-well plates) or for flat containers (e.g. Petri dishes). For PCR vials and centrifuge tubes, the limits are moreover determined by the storage rack (cf. Fig. 3).

C. Force Robustness

To measure the stability of a grasp, we attached a force gauge with 25 N maximum force (FK 25, Sauter GmbH, Germany) to each container with a wire. We then pulled the gauge and noted down for the two directions perpendicular to the finger base, i.e. y and z except for the 96-well plate insertion grasp, at what force the container was wrested. The results are shown in Fig. 7b. The errors are estimated 1 N for forces below 10 N, and 10 % otherwise. One can see that the grasps with a large contact area, such as power grasps and for Petri dishes, are generally more stable.

D. Acceleration and Collision Test and Repeatability

Finally, we simulated a collision event that may occur in the lab in a similar fashion. As data sources we make use of the libfranka API that provides access to the end effector z coordinate z_{EE} , the finger width of the gripper w_f and the force acting on the end effector in z -direction F_z . Additionally, we attached an inertial measurement unit (IMU) to the lid of the Petri dish used in the experiment. Thus, we access its absolute acceleration a_{xy} in the x - y plane at 100 Hz. The setup is shown in Fig. 9a.

In Fig. 8 we show time series of these quantities for a transport scenario of the dish: Initially, it is picked up from the table, as is visible from the low z position of the end effector (row a) and the finger width that decreases during grasping (row b). From the plot in row c we can see that there are no sudden accelerations in the x - y plane during pickup that could lead to liquid spilling. Next, we moved the Petri dish in all directions at speeds up to 0.4 m s^{-1} , while the grasp remained stable. The dish is then guided against an obstacle from the top with forces up to 20 N in negative z direction while still grasped, as visible in row d. Eventually, it is returned to the table, from which it can be picked up again. The same experiment was repeated 20 times without human intervention. Thus we can show that the tip design facilitates a stable grasp of the Petri dish because the cutout guides the latter into a stable position and thus compensates for inaccuracies, e.g. due to the collision.

E. Benchmark against Standard Parallel Fingers

As a direct comparison, we benchmark our fingers against the standard parallel fingers that come together with the Franka Hand gripper². As described in Section I, comparable solutions are often used for biolab automation.

Fig. 8e shows the force $F_{z,F}$ for the collision experiment described in Section IV-D using these fingers. Although this

²See <https://www.franka.de/ecosystem/>, last accessed 2 September 2022

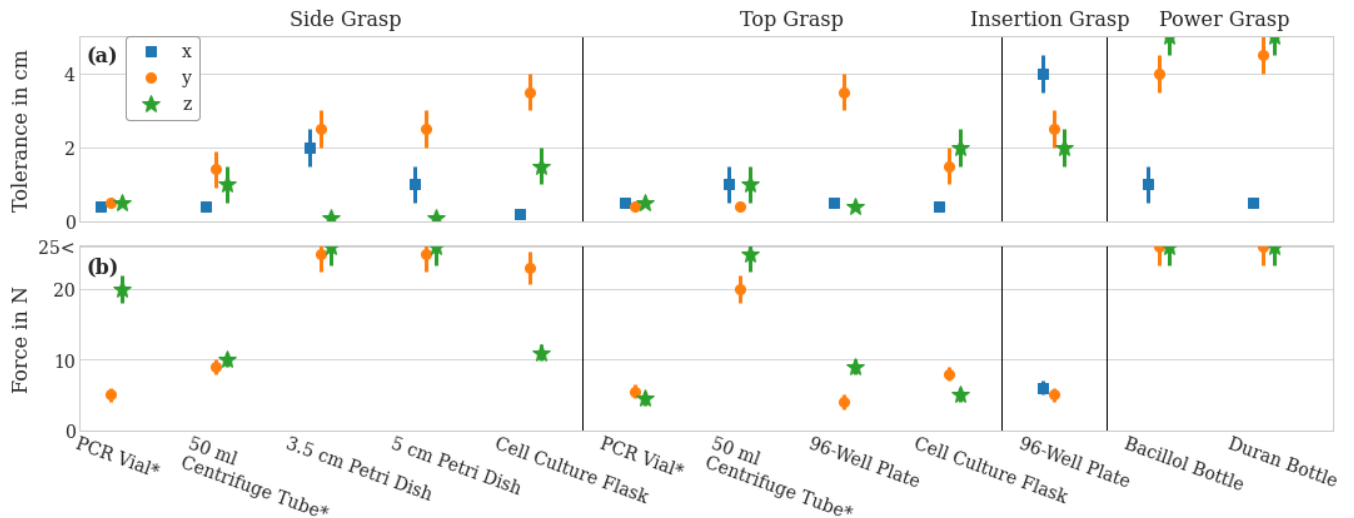

Fig. 7. Quantitative finger characteristics validation experiments. See Fig. 3 for containers and Fig. 6 for grasp types. (a) Maximum displacement tolerance. Values for items with * depend on storage rack dimensions. (b) Force robustness.

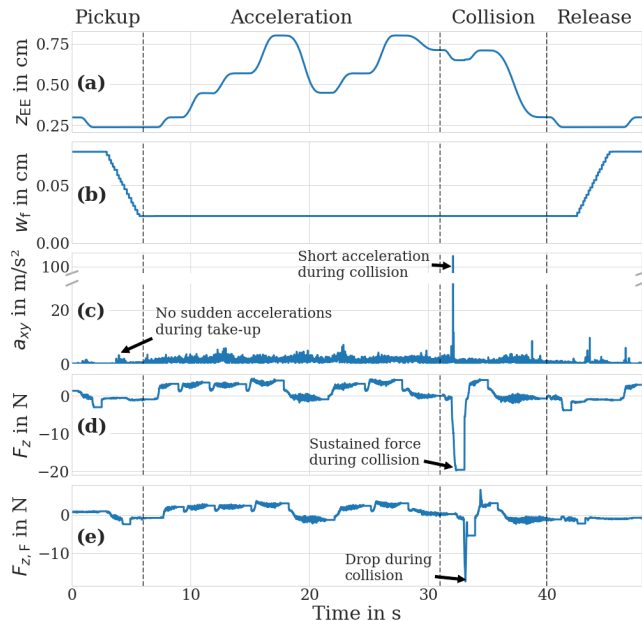

Fig. 8. Time series plots for collision experiment. (a) End effector z position. (b) Finger width. (c) Acceleration in x - y plane. (d) Force on end effector in z direction. (e) Force on end effector with simple parallel fingers in z direction.

system can grasp the Petri dish by pressing the lid against the vessel (cf. Fig 9b), the grasp is not stable: During the collision the dish is dropped, as the abrupt decrease of force after $t \approx 33$ s shows. This implies that our fingertip configuration indeed provides additional grasp stability.

In addition to the quantitative comparison, this simple finger system cannot satisfy some qualitative requirements. This applies especially to the items that can be grasped: Neither a Petri dish with a more rigid lid that cannot be pressed against the vessel, a heavy container that needs an enclosing grasp to be lifted, nor a wide container such as a 96-well plate can be handled with this configuration.

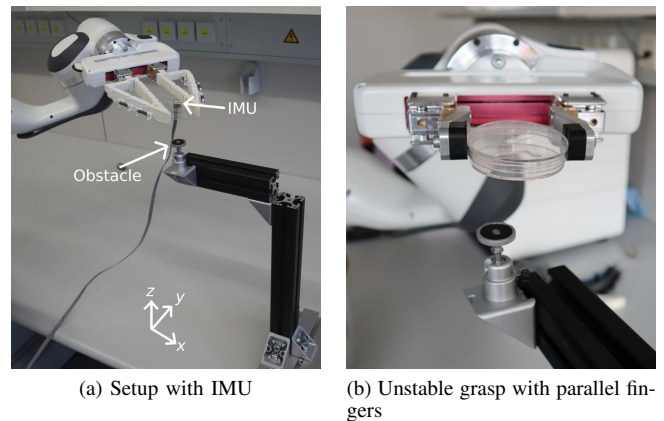

Fig. 9. Collision experiment setup

V. CONCLUSIONS

We presented an enhanced finger system for a parallel gripper for robotic biolab automation and validated its grasping capabilities. In the future, we intend to integrate the fingers into typical laboratory workflows to validate their functioning and features in actual experimental settings. This can occur as part of the Intelligent Robotic Lab Assistants, as presented in [17], where two arms are mounted on a gantry system. For better integration, special focus should be placed on the kinematic structure of the fingers, i.e. the miniaturization of their dimensions, to make them compatible with more delicate grasping processes. The long-term durability of the print under continuous exposure to forces during lifting, combined with strains from the sterilization process, must be validated. Complementing the hardware solution proposed so far with software tools that report failed grasping attempts or reduce sloshing will yield valuable feedback that can be integrated into the control loop.

ACKNOWLEDGMENT

We gratefully acknowledge the funding of this work by the Alfred Krupp von Bohlen and Halbach Foundation. We gratefully acknowledge the funding of this work by

the Deutsche Forschungsgemeinschaft through the Gottfried Wilhelm Leibniz Programme (award to Sami Haddadin; grant no. HA7372/3-1). The authors acknowledge the financial support by the Bavarian State Ministry for Economic Affairs, Regional Development and Energy (StMWi) for the Lighthouse Initiative KI.FABRIK, (Phase 1: Infrastructure as well as the research and development program under grant no. DIK0249). Please note that S. Haddadin has a potential conflict of interest as shareholder of Franka Emika GmbH.

- [17] D. Knobbe, H. Zwirrmann, M. Eckhoff, and S. Haddadin, "Core processes in intelligent robotic lab assistants: Flexible liquid handling," *IEEE/RSJ International Conference on Intelligent Robots and Systems (IROS)*, pp. 2335–2342, 2022. [Online]. Available: <https://ieeexplore.ieee.org/document/9981636>

REFERENCES

- [1] J. Nowakowska, J. Sobocińska, M. Lewicki, Żaneta Lemańska, and P. Rzymiski, "When Science Goes Viral: The Research Response during Three Months of the COVID-19 Outbreak," *Biomedicine & Pharmacotherapy*, vol. 129, p. 110451, 9 2020. [Online]. Available: <https://linkinghub.elsevier.com/retrieve/pii/S0753332220306442>
- [2] I. Holland and J. A. Davies, "Automation in the Life Science Research Laboratory," *Frontiers in Bioengineering and Biotechnology*, vol. 8, 11 2020. [Online]. Available: <https://www.frontiersin.org/articles/10.3389/fbioe.2020.571777/full>
- [3] K. Thurow, "System Concepts for Robots in Life Science Applications," *Applied Sciences*, vol. 12, p. 3257, 3 2022. [Online]. Available: <https://www.mdpi.com/2076-3417/12/7/3257>
- [4] F. Kong, L. Yuan, Y. F. Zheng, and W. Chen, "Automatic Liquid Handling for Life Science," *Journal of Laboratory Automation*, vol. 17, pp. 169–185, 6 2012. [Online]. Available: <http://journals.sagepub.com/doi/10.1177/2211068211435302>
- [5] K. M. Elkins, "Dna extraction," pp. 39–52, 1 2013. [Online]. Available: <https://linkinghub.elsevier.com/retrieve/pii/B9780123945853000043>
- [6] L. Birglen, "Enhancing versatility and safety of industrial grippers with adaptive robotic fingers," *IEEE/RSJ International Conference on Intelligent Robots and Systems (IROS)*, pp. 2911–2916, 2015. [Online]. Available: <http://ieeexplore.ieee.org/document/7353778/>
- [7] Y. Tlegenov, K. Telegenov, and A. Shintemirov, "An open-source 3d printed underactuated robotic gripper," *2014 IEEE/ASME 10th International Conference on Mechatronic and Embedded Systems and Applications (MESA)*, pp. 1–6. [Online]. Available: <http://ieeexplore.ieee.org/document/6935605/>
- [8] J. Shintake, V. Cacucciolo, D. Floreano, and H. Shea, "Soft Robotic Grippers," *Advanced Materials*, vol. 30, p. 1707035, 7 2018. [Online]. Available: <https://onlinelibrary.wiley.com/doi/10.1002/adma.201707035>
- [9] W. Crooks, G. Vukasin, M. O'Sullivan, W. Messner, and C. Rogers, "Fin Ray® Effect Inspired Soft Robotic Gripper: From the RoboSoft Grand Challenge toward Optimization," *Frontiers in Robotics and AI*, vol. 3, p. 70, 11 2016. [Online]. Available: <http://journal.frontiersin.org/article/10.3389/frobt.2016.00070/full>
- [10] H. Park and D. Kim, "An Open-Source Anthropomorphic Robot Hand System: HRI Hand," *HardwareX*, vol. 7, p. e00100, 4 2020. [Online]. Available: <https://linkinghub.elsevier.com/retrieve/pii/S2468067220300092>
- [11] R. Lehmann, J. Severitt, T. Roddelkopf, S. Junginger, and K. Thurow, "Biomek Cell Workstation: A Variable System for Automated Cell Cultivation," *SLAS Technology*, vol. 21, pp. 439–450, 6 2016. [Online]. Available: <https://linkinghub.elsevier.com/retrieve/pii/S2472630322014066>
- [12] B. Burger *et al.*, "A Mobile Robotic Chemist," *Nature*, vol. 583, pp. 237–241, 7 2020. [Online]. Available: <http://www.nature.com/articles/s41586-020-2442-2>
- [13] H. Fleischer *et al.*, "Application of a Dual-Arm Robot in Complex Sample Preparation and Measurement Processes," *SLAS Technology*, vol. 21, pp. 671–681, 10 2016. [Online]. Available: <https://linkinghub.elsevier.com/retrieve/pii/S2472630322014315>
- [14] A. Lavrentieva, "Essentials in Cell Culture," pp. 23–48, 2018. [Online]. Available: https://link.springer.com/chapter/10.1007/978-3-319-74854-2_2
- [15] ANSI / SLAS, "ANSI SLAS 1-2004 (R2012) - Footprint Dimensions for Microplates," 2011. [Online]. Available: https://www.slas.org/SLAS/assets/File/public/standards/ANSI_SLAS_3-2004.BottomOutsideFlangeDimensions.pdf
- [16] J. W. Jaeger *et al.*, "Automated Device for Uncapping Multiple-Size Bioanalytical Sample Tubes Designed to Reduce Technician Strain and Increase Productivity," *SLAS technology*, vol. 26, pp. 320–326, 6 2021. [Online]. Available: <https://www.sciencedirect.com/science/article/pii/S2472630322011062#bib15>