

Recursive deep learning framework for forecasting the decadal world economic outlook

TIANYI WANG¹, RODNEY BEARD², JOHN HAWKINS³, AND ROHITASH CHANDRA.¹ (SM, IEEE)

¹Transitional Artificial Intelligence Research Group, School of Mathematics and Statistics, UNSW Sydney, Australia

²Centre for Artificial Intelligence and Innovation, Pingala Institute, Nausori, Fiji

³Centre for Artificial Intelligence and Innovation, Pingala Institute, Sydney, Australia

Corresponding author: R. Chandra (e-mail: rohitash.chandra@unsw.edu.au)

arXiv:2301.10874v2 [cs.LG] 1 Oct 2024

ABSTRACT

The gross domestic product (GDP) is the most widely used indicator in macroeconomics and the main tool for measuring a country's economic output. Due to the diversity and complexity of the world economy, a wide range of models have been used, but there are challenges in making decadal GDP forecasts given unexpected changes such as emergence of catastrophic world events including pandemics and wars. Deep learning models are well suited for modelling temporal sequences and time series forecasting. In this paper, we develop a deep learning framework to forecast the GDP growth rate of the world economy over a decade. We use the *Penn World Table* as the data source featuring 13 countries prior to the COVID-19 pandemic, such as Australia, China, India, and the United States. We present a recursive deep learning framework to predict the GDP growth rate in the next ten years. We test prominent deep learning models and compare their results with traditional econometric models for selected developed and developing countries. Our decadal forecasts reveal that that most of the developed countries would experience economic growth slowdown, stagnation and even recession within five years (2020-2024). Furthermore, our model forecasts show that only China, France, and India would experience stable GDP growth.

INDEX TERMS GDP; Deep Learning; World Economy Forecasting; LSTM, Recurrent Neural Networks, Convolutional Neural Networks

I. INTRODUCTION

Economists and policymakers rely on a wide range of macroeconomic indicators to guide decisions and social policies that impact the economies of the world [1]. Among macroeconomic indicators, the gross domestic product (GDP) is the most widely used. The GDP is a measure of the market value of all the final goods and services produced in a specific time period in a country [2]. The GDP is seen as a powerful statistical indicator of national development and progress [3] and is often used as a means to measure the economic health of a country. The GDP is also correlated with the employment rate [4], [5] which can also give an indication of trade and investment opportunities [6]. *Expectations* are a key element of macroeconomic theories that refers to forecasts and viewpoints of experts about economic indicators such as sales, income, taxes, and future prices [7], [8]. Macroeconomic forecasts can also be expected to

have an influence on how individuals anticipate the economy will evolve. It is precise because GDP is closely related to other macroeconomic indicators such as stock prices and the unemployment rate [9] that it is regarded as the "core" metric to measure the development and growth of a country. Accurate forecasting of GDP is critical for economic policy in order to minimise errors in decision-making [10]. Furthermore, GDP forecasts routinely tend to fail to capture drastic economic trends [11], which are likely to be more critical for effective policy responses. International economic and financial organizations typically publish forecast reports for governments and corporations. The International Monetary Fund (IMF) publishes quarterly reports about their views on the world's economic development [12] that include views on GDP that can influence the domestic and foreign policy of a country [13], [14].

GDP forecasting often requires the use of exogenous

variables (features) such as oil and stock prices that can be collected more frequently than quarterly GDP data [15]. GDP forecasting has necessitated the use of domain specific modelling techniques that merge data across timescales, including *bridge equations* or *dynamic factor models* [16]–[19]. These models are generally linear equations composed over a series of lagged and differences of exogenous and autoregressive variables [20]. They fit within the broader family of traditional time series models defined by the autoregressive integrated moving average (ARIMA) [21] and vector autoregressive (VAR) methodologies [22]. The weakness of these approaches is the restriction to linear relationships, which has been a necessary compromise in the absence of large data sets. However, these approaches have consistently failed to identify crucial changes in the economy [11], [19]. It remains an open research question to determine the best forecasting methodology for a given economic purpose. Machine learning models have the ability to better capture nonlinearity and adapt to noisy data, and hence have drawn the attention of econometricians [23], [24].

Deep learning provides a set of machine learning models that have demonstrated to overcome some of the limitations of statistical and econometric models [25], [26]. These techniques have achieved widespread adoption in areas such as image recognition, recommender systems, time series forecasting, and autonomous driving [27]. Recurrent Neural Networks (RNNs) are deep learning models designed to process arbitrarily long sequences of data [28] which has made them prominent for natural language processing (NLP) [29]–[31], bioinformatics [32], and time series forecasting [33]. The Long Short-Term Memory (LSTM) network is an advanced RNN designed to identify long-term dependencies in sequences [34]. Since the development of LSTM networks, further advancements have been made. The Bi-directional LSTM (BD-LSTM) was developed for exploiting information across an entire sequence in order to improve NLP models [35]; however, it also can be used for time series forecasting by processing the preceding sequence in both directions [33], [36]. The Encoder-Decoder LSTM (ED-LSTM) is another variant that learns to encode a variable-length sequence into a fixed-length vector representation and to decode a given fixed-length vector [37], widely used in pattern recognition [38] and time series forecasting [33]. Convolutional neural networks (CNNs) [39] are deep learning models developed specifically for image processing which have shown very promising results in time series prediction [33], such as stock price prediction [40]. We note that although they have potential, CNNs have not been extensively applied in macroeconomic forecasting [41].

Machine learning models have been very promising in forecasting competitions, typically through the involvement of sophisticated ensemble learning methods [42], [43]. In addition, econometricians have identified important roles for machine learning models in GDP forecasting [44], [45], with deep learning models for forecasting the GDP growth rate using a multivariate approach [46]–[48]. Zhang et al. [47]

combined LSTM and hidden Markov models (HMMs) to use consumer price index (CPI) [49] to forecast China's GDP before the COVID-19 pandemic. Based on import and export data, Sokolov-Mladenovic et al. [48] forecasted the GDP of European Union countries using simple neural networks and extreme learning machine models. Mourougane [50] made a monthly forecast of Canada's GDP based on hard indicators related to quantifiable indicators (industrial production, unemployment, etc.) and soft indicators that are less tangible community characteristics and values [51] (confidence index, exchange rate, etc.). Longo et al. [52] used the ensemble method based on the LSTM to forecast the GDP of the United States and provided insights about the contribution of different features (economic indicators) during COVID-19. The economic indicators included 141 variables taken from the Federal Reserve Economic Data (FRED) database.

Long-term (decadal prediction) is important for policy-making, since many countries plan their economy and investments for decades ahead of time. An example is China, which had planned and invested in Africa since the 1990s [53]. The International Monetary Fund and the World Bank have a decadal ahead forecast which is taken as an input in policy-making, considering factors such as climate change, population growth/decline and energy supply [13], [54]. Time series forecasting employs two major strategies, which include *direct* and *recursive* strategies [55]–[57]; although direct strategy can be used for multi-step time series prediction, the recursive strategy is more useful when the prediction horizon spans longer time. Hence, it would be more appropriate to use a mix of direct and recursive strategies in decadal forecasting. Moreover, there is a gap in decadal forecasting methods using deep learning with multivariate analysis of economic indicators. We would need to forecast the economic indicators using a recursive deep learning strategy, in order to forecast the decadal GDP growth rate. We find that most of the studies in the literature focused on developed countries for GDP forecasting, and only a few studies forecast developing countries. This could be because developed countries have better access and complete data about economic indicators, which are more helpful for forecasting. It is a challenge to develop deep learning models given limited and missing data about economic indicators. There is a growing interest in utilizing appropriate deep learning models for GDP forecasting when compared to traditional econometric models.

In this paper, we use deep learning models that include LSTM-based models and CNNs for decadal GDP growth rate forecasting of major world economies. We focus on large economies around the world, including developing and developed countries. We present a recursive deep learning framework where the direct strategy is used for model development and the recursive strategy is used for the decadal forecast. We use data from the past few decades to forecast the future decade. We also investigate the data partitioning strategy that is best for model training and development. We further compare the performance of deep learning models with traditional time series forecasting models (ARIMA and

VAR) for different countries. Our data includes periods of smooth development, rapid development, and periods of financial crisis in the training set, in order to better prepare the test set and forecast data. We first use a direct strategy to evaluate the respective deep learning models and then use the best model for the recursive strategy, where we estimate the economic indicators to forecast the decadal GDP growth rate. Our data features GDP along with economic indicators prior to 2019 that excludes the COVID-19 pandemic, and we forecast the decadal world economic outlook for 2020 - 2030.

The rest of the paper is organised as follows. Section 2 provides a review of the literature and Section 3 presents the methodology where we evaluate deep learning models and present a recursive deep learning framework for the world economic outlook. In Section 4, we present the results and Section 5 summarizes the results and discusses promising future developments. Section 6 concludes the paper by highlighting major results.

II. RELATED WORK

A. ECONOMETRIC MODELS FOR TIME SERIES FORECASTING

The ARIMA model is a prominent statistical model for time series analysis and forecasting macroeconomic trends. A number of studies in the literature have utilized it for economic forecasting, such as the prediction of Singapore's quarterly GDP based on monthly external trade [58] and the Irish Consumer Price Index (CPI) [59], and the decadal Egyptian GDP [60]. Sims [22] introduced the VAR model in 1980 for macroeconomic modelling and forecasting in order to deal with endogeneity issues that plagued macroeconomic forecasting models. Freeman and Williams [61] used a VAR model to analyze indicator variables that relate to policy and the economy, and reported that the VAR model was better at capturing policy endogeneity when compared to structural equation models [62]. A decade later, Robertson et al. [63] used the VAR model to predict United States GDP using six economic indicators and found that imposing imprecise prior constraints on VAR led to more accurate predictions. Salisu et al. [64] analyzed how the oil uncertainty stock affected the GDP of 33 countries using a global VAR. Iorio et al. [65] compared France and Germany's unemployment and GDP growth rate using a VAR model. ARIMA and VAR models remain widely applied in a range of econometrics and finance applications [66], [67].

Other approaches to time series prediction include machine learning models such as support vector regression (SVR). Müller et al. [68] used SVR for time series forecasting using benchmark problems. Lau et al. [69] implemented SVR for Sunspot time series forecasting with better results than the radial basis function network in relatively long-term prediction. In the financial time series forecasting domain, Lu et al. [70] combined independent component analysis with the SVR model and improved the accuracy further. Although a wide range of applications of time series forecasting using

SVR has been presented [71], [72], our study focus on deep learning models.

Researchers in the past have combined statistical models with deep learning models for improving their performance. Tseng et al. [73] modelled the production value of Taiwan's machinery industry using seasonal time series data of soft drink factories by combining seasonal ARIMA and multilayer perception [74] that achieved better results than standalone models. Choi [75] presented an ARIMA-LSTM model for stock price correlation coefficient prediction, where the ARIMA model processed linear correlation in the data and passed the residual to the LSTM model. Ouhamme et al. [76] proposed a VAR-LSTM hybrid model where the assumed linearity and the LSTM model catered for nonlinear data.

B. DEEP LEARNING MODELS FOR TIME SERIES FORECASTING

Deep learning methods learn from raw data to understand structures and patterns for prediction [77], [78]. Deep learning has been applied across multiple domains such as speech recognition, visual object recognition, genomics [79]–[81], and time series forecasting [33].

Among deep learning models, the LSTM model is most prominent for time series forecasting and has a wide range of applications, including macroeconomics, stock price, and COVID-19 infection. Karevan et al. [82] forecasted weather for cities in Belgium and the Netherlands using a transductive LSTM where the cost function was altered to differently weigh the data for improving the accuracy of the prediction. Smalter et al. [83] used an LSTM model to forecast macroeconomic indicators and extended the model into the ED-LSTM architecture. They used these models to predict the unemployment rate and compared them with a VAR model, where the LSTM and ED-LSTM were better than the traditional models. Siami-Namin et al. [84] used stock market data from 1985 to 2018 to compare ARIMA, LSTM and BD-LSTM models. Chandra et al. [33] presented a deep learning framework for predicting novel COVID-19 cases in India, where the univariate ED-LSTM model provided the best performance and provided forecasts two months in advance.

The CNN model can also be used for time series-related problems. Selvin et al. [85] employed a CNN model to predict the stock prices of companies such as Infosys, Tata, and Cipla and reported that CNN was better than the LSTM model. Piao et al. [86] predicted housing price using a CNN model with variable selection. Livieris et al. [87] used CNN-LSTM hybrid model to predict the prices and price trends for gold markets.

III. METHODOLOGY

A. DATA

The Group of Seven (G7) is an inter-governmental political forum of seven developed countries consisting of Canada, France, Germany, Italy, Japan, the United Kingdom, and

the United States. These countries exert significant influence over global geo-political affairs that impact the world economy [88], [89]. On the other hand, BRICS refers to the five major emerging economies and developing countries, including Brazil, Russia, India, China and South Africa. These developing countries occupy an indispensable position in the future development of the world [90].

We select thirteen countries by combining Australia with the G7 and BRICS. This set includes developed and developing countries and covers a significant proportion of the global economy. We use the Penn World Table (PWT) version 10.0¹ dataset [91] to extract a time series dataset of economic indicators for each of these countries. The PWT 10.0 database contains information on relative levels of income, output, input and productivity. It covers 183 countries between 1950 and 2019. We extracted data from 1980 to 2019 in order to maximize the number of countries with complete coverage. The exception is Russia, for which there was data only for the period from 1991-2019.

We choose a subset of the available variables from PWT (economic indicators) to use in our models for predicting the GDP growth rate. This includes GDP, net population, consumer price index (CPI), employment rate, the share of labor compensation in GDP at current national prices, exchange rate, GDP per-capita at current purchasing power parity (CGDPo), and price levels that refer to the perspectives of macroeconomics (production, expenditure, and trade), finance, and human resources². Our model will predict the GDP rate using a predefined window of the previous GDP rates along with economic indicators. We also supplement the PWT data by a price index that can show whether inflation is present, in order to help us better predict economic development and economic crises [47], [48], [50], [52]. We transform data into a year-on-year ratio in order to predict the GDP growth rate.

The year-on-year ratio R formula is:

$$R = \frac{Data_n - Data_{n-1}}{Data_{n-1}} \quad (1)$$

where n represents the year.

We transform all of the variables(features) in the PWT data using a year-on-year ratio. We apply a min-max scaling operation to remove the inter-variable scale differences and ensure all values reside between zero and one.

1) Data Processing

In the deep learning models, in order to develop multivariate and multistep-ahead prediction models, we need to reconstruct the original time series data with input-output pairs for training the model. This is done typically using a sliding-window approach, and hence also known as windowing. Suppose our original time series data is given by

$$[x_1, x_2, \dots, x_N; y_1, y_2, \dots, y_N]$$

where N is the length of data. Next, we introduce the definition of time window T . The reconstructed data D consists of multiple data windows

$$[T_1, T_2, \dots, T_{N-m}]$$

Each data window can be regarded as a sample (instance) of the data used for model training. We need to determine the input step size m and output step size n first. In a time window, we have m -step input X to represent the m -th exogenous series in T and n -step output Y , as the n -th target series of T . Therefore, the first time window is as follows.

$$\begin{aligned} X_1 &= [x_1, x_2, \dots, x_m] \\ Y_1 &= [y_{m+1}, y_{m+2}, \dots, y_{m+n}] \end{aligned} \quad (2)$$

Next, using the same method, we can reconstruct the remaining data until x_N is included in the latest time window, so we can write its universal formula below.

$$\begin{aligned} X_i &= [x_i, x_{i+1}, \dots, x_{i+m}] \\ Y_i &= [y_{i+m+1}, y_{i+m+2}, \dots, y_{i+m+n}] \end{aligned} \quad (3)$$

B. ECONOMETRIC MODELS

1) ARIMA model

The ARIMA model by Box and Jenkins [21] has been prominent for nearly half a century in time series forecasting. It is a combination of three components, autoregressive model (AR), integrated average (I) and moving average model (MA). ARIMA models have three parameters to represent the three parts in this model respectively, written as $ARIMA(p, d, q)$. $AR(p)$ represents the past value used for prediction, and p can be determined by the partial autocorrelation function. $I(d)$ refers to the times of differences to ensure the data is stable. We use the Augmented Dickey-Fuller (ADF) test to help us to find d . $MA(q)$ expresses the current data and errors in the past q values, which can be found by analyzing the autocorrelation function. We define the ARIMA model by

$$\begin{aligned} w_t &= \Delta^d y_t \\ w_t &= \phi_1 w_{t-1} + \dots + \phi_p w_{t-p} \\ &+ \varepsilon_t \\ &- \theta_1 \varepsilon_{t-1} - \dots - \theta_q \varepsilon_{t-q} \end{aligned} \quad (4)$$

where ϕ and θ are the coefficients of values w and errors ε , respectively.

2) VAR model

The VAR model has been traditionally used to explain the relationship with exogenous variables (features) in the data [22]. The model combines the lagged endogenous variables with the exogenous variables to explain the endogenous variable (target) which extends the regression model to multivariate time series.

$$Y_t = BX_t + A_1 Y_{t-1} + \dots + A_p Y_{t-p} + u_t \quad (5)$$

¹<https://www.rug.nl/ggdc/productivity/pwt/?lang=en>PWT 10.0

²[urlhttps://data-planet.libguides.com/PennWorldTables](https://data-planet.libguides.com/PennWorldTables)

where X is the exogenous variable, Y is the endogenous variable, u is the error term, A and B are the coefficients.

$$AIC = -2\ln(L) + 2k \quad (6)$$

The Akaike Information Criterion (AIC) [92] is typically used in the VAR model for determining model hyperparameters, such as determining the best lag, where L is the maximum likelihood, and k is the number of parameters.

C. DEEP LEARNING MODELS

1) LSTM model

RNNs feature a recurrent (context) layer h that acts as a memory for preserving state information for output y during the processing of a sequence of data, $x = (x_1, \dots, x_t)$. The hidden layer h_t stores the previous hidden result to update the weight w_{hh} to process the x_t in next time step and output y_t , as shown in Figure 1 and given by

$$\begin{aligned} y_t &= f_1(h_t w_{hy} + b_y) \\ h_t &= f_2(x_t w_{xh} + h_{t-1} w_{hh} + b_h) \end{aligned} \quad (7)$$

where w is the weight in different layers, f_1 and f_2 are the activation function, and b is the bias.

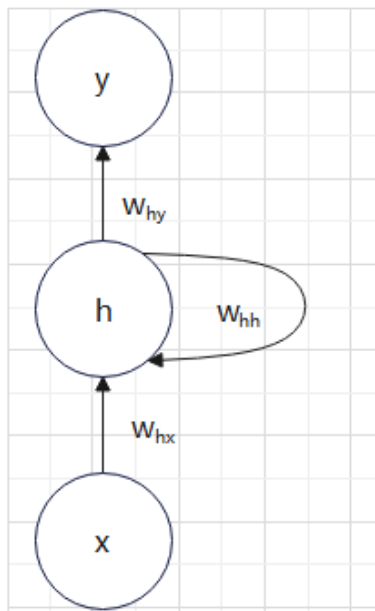

FIGURE 1: RNN structure showing information from input x to output y via the state and hidden layers h .

Conventional RNNs faced limitations in training due to vanishing gradients in long sequences; hence, Hochreiter and Schmidhuber [34] designed an LSTM network which introduced memory cells and gates that enable them to have better performance in processing the long-term dependencies in sequences. Figure 2) presents the LSTM network where the context layer is leveraged by memory cells.

BD-LSTM is a variant with two types of LSTM cells that process the input sequence data in two directions, from

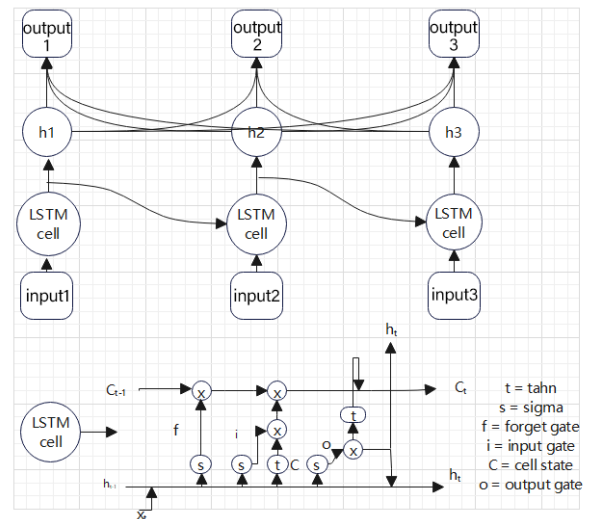

FIGURE 2: LSTM network with memory cell for handling long-term dependencies.

the start to the end, and from the end backwards. This bi-directionality allows the model to build up two separate hidden state representations of the input sequence as shown in Figure 3.

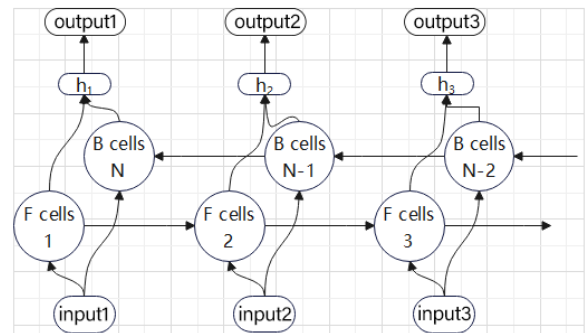

FIGURE 3: BD-LSTM model showing the forward direction LSTM cells F cells and backward direction LSTM cells B cells.

The encoder-decoder architecture (ED-LSTM) proposed by Sutskever et al. [93] features two types of cells to process the data, the encoder processes the input series data x_1, \dots, x_t with T length, then transfer the summary of past series data to the cell state c_t , in the encoder system. There are T LSTM cells to recursive T time until getting the summaries of all the series data and transfer the result into cell state c_T , c_T is also the initial input to the decoder system (i.e., $c_T = c'_0$). This helps the LSTM cells in the decoder system to output y_1, \dots, y'_t , and each time of update, the previous output would be used as input in the current step as shown in Figure 4.

The ED-LSTM estimates the conditional probability of the output sequence y_1, \dots, y'_t given the input sequence x_1, \dots, x_t (i.e., $p(y_1, \dots, y'_t | x_1, \dots, x_t)$).

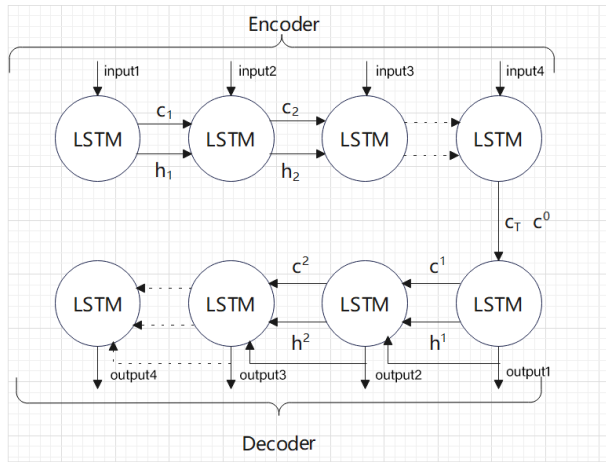

FIGURE 4: ED-LSTM architecture showing the Encoder and the Decoder modules.

2) CNN

LeCun introduced CNN [94] with inspiration from research on the visual cortex of the mammalian biological brain. CNN consists of an input, convolution, pooling, fully connected and output layer. The convolutional and pooling layers can be placed multiple times as a combination depending on the application. The architectural setting requirement for different applications has enabled the design of specific CNN architectures such as VGG-Net [95] and Alex-Net [96] for complex computer vision tasks. The convolutional layer extracts features of the input through the convolution operation, that are then filtered by the pooling layer. Finally, information is passed to the fully connected layer, which is typically a simple neural network. Although the CNN has been prominent for computer vision and image processing tasks; it also has been applied for time series prediction [33], [85], [86], and hence we use it as a model for comparison.

D. DIRECT AND RECURSIVE DEEP LEARNING FRAMEWORK FOR DECADAL WORLD ECONOMY OUTLOOK

We apply two strategies for forecasting, which include direct and recursive, as illustrated in Figure 5. We use the direct strategy for model development and model evaluation for multistep time series prediction. We then use the recursive strategy for decadal forecasting based on the model developed using the direct strategy. Therefore, our framework is direct and recursive, as it uses the prediction as input to the model to make future (decadal) predictions.

We note that in the direct strategy, the model only predicts the GDP growth rate, whereas, in the recursive strategy, the model first predicts the features (economic indicators) which are then used to predict the decadal GDP growth rate. The advantage of the recursive strategy is that we can optimize the length of time step required for the deep learning model within a reasonable range, and not have the longer prediction window limit our data partitioning. We can use the optimal

short-range forecast model to pursue prediction accuracy, and then use a recursive strategy to achieve our long-term forecast goal. The PWT training data set covers the period 1980-2010, Table 1 indicates that the test data set covers the period 2011-2019. We provide GDP growth rate prediction for the period 2020-2030 which lies outside the same data with a view for later validation and for comparison with other forecasting models.

In the direct strategy, we use a fixed window of historical economic indicators from the PWT database. We process the data before training the respective econometric and deep learning models. Our data processing features four steps including i. transform data into year-over-year ratio, ii. min-max scaler processing, iii. data reconstruction using windowing, and iv. data shuffling for creating training and test sets. We convert the data to year-on-year ratios and normalize them to remove the effects of variable ranges. We reconstruct the data to train the respective deep learning models including the CNN, LSTM, ED-LSTM and BD-LSTM. We shuffle the data to create a training and test set while preserving temporal dependence for a short time window, i.e. 4 years in the past to forecast 3 years in the future. We use 5 input features (economic indicators) to predict the GDP rate. We treat different countries as different datasets. After the data has been processed, we train the model and then compare the accuracy and average ranking of the models on the test data set. We further compare the performance of deep learning models on the test data set with econometric models (ARIMA and VAR). We then select the model with the best forecasting accuracy from these models as the model for the recursive strategy.

In the recursive strategy (Figure 5), we use the best model and data partitioning strategy evaluated in the direct strategy phase of model training. Our model features the selected economic indicators as input for a timeframe (M time steps) with multiple output units (N time steps) for prediction (multi-to-multi architecture). We apply a recursive procedure where the predictions are fed back into the model as input, since N does not cover the decade and we need to predict all the economic indicators for the entire decade. We then obtain a dataset of economic indicators (2020-2030) and we used this to predict the decade-ahead GDP growth-rate for each of the selected countries and provide independent analysis.

1) Training and test data

We use a shuffling strategy for processing the dataset, where we take 1980-2010 period as the training data and the 2011-2019 period as the test data set. In the shuffling strategy, we implement data reconstruction and apply windowing and then apply shuffling to randomly order the data windows to avoid any bias. In the case of Russia, its train data set begins in 1991 but still ends in 2010. The Russian test data set share the same period with other countries as shown in Table 1. Before importing the data into the deep learning model, we need to transform the training set and test set to a structure suitable for time series forecasting.

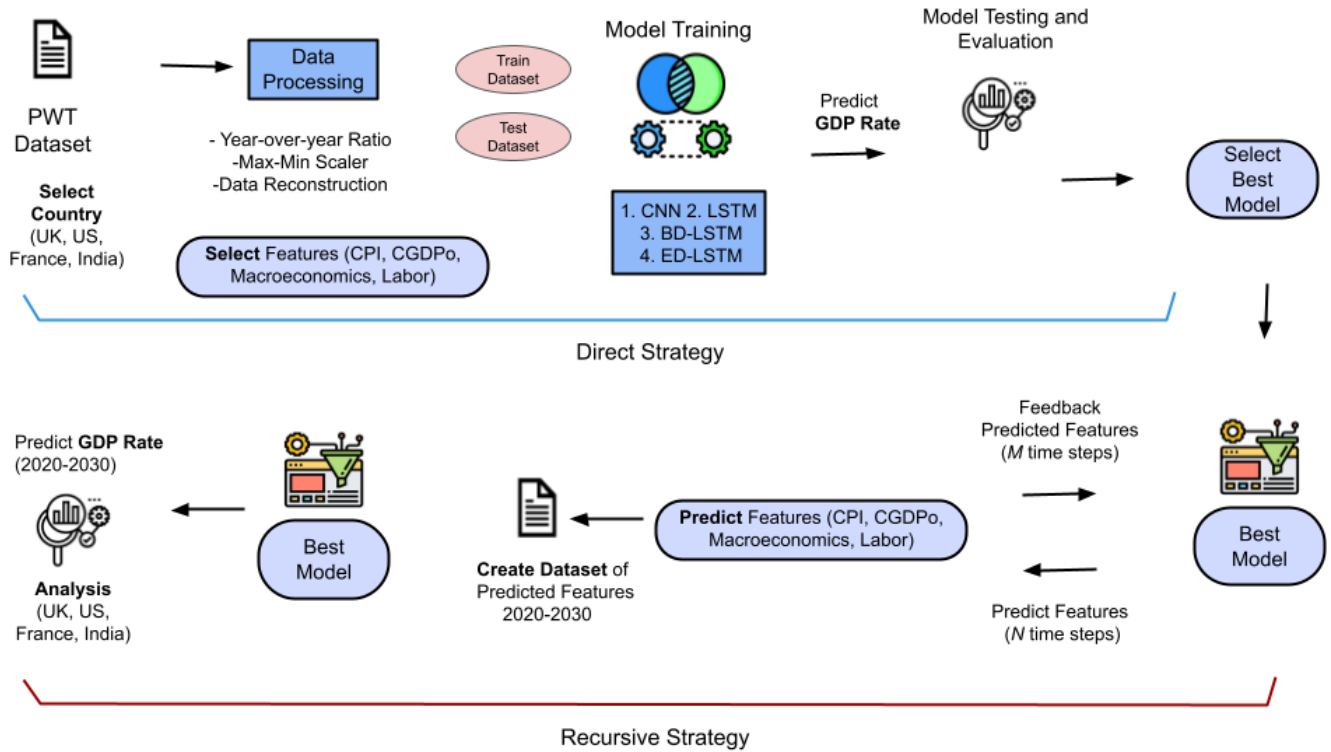

FIGURE 5: Deep learning-based framework to predict decadal GDP growth rate using the direct and the recursive strategy. The model only predicts the GDP growth rate in the direct strategy using data from 1980-2010, and model testing is done for data from 2011-2019. In the recursive strategy, the model first predicts the features (economic indicators) for the decade ahead (2020-2030), which are then used to predict the decadal GDP growth rate (2020-2030).

TABLE 1: the period of train and test data set

	Train Data set	Test Data set
Russia	1991-2010	2011-2019
Others	1980-2010	2011-2019

$$X_i = [x_i, x_{i+1}, \dots, x_{i+m}] \quad (8)$$

$$Y_i = [y_{i+m+1}, y_{i+m+2}, \dots, y_{i+m+n}]$$

$$T_i = [X_i; Y_i]$$

$$D_{shuffled} = [T_3, T_8, T_5 \dots, T_2]$$

We use a data structure of 5 inputs as multivariate features considering 4-time steps (years) for 3-step ahead prediction (i.e. 3 prediction horizons). We shuffle the data set which considers time windows in the reconstructed data set as given in Equation (8). We note that the order and length inside the time window does not change, i.e. our data window features the past 4 years of data with 5 features to predict the next 3 years which does not change when shuffled. Note that although we use this data processing setting to demonstrate our framework in Figure 5, other values can be used to create the training and the test dataset, i.e. the time steps (years) and the number of features, number of steps-ahead for prediction.

IV. RESULTS

A. TECHNICAL SET-UP

Our experiments first use the direct strategy to evaluate the model, using the data from 13 countries in the PWT dataset and select the best model according to prediction accuracy. Afterwards, we use the best-performing model to forecast the GDP growth rate for the next ten years, where we need a recursive strategy to predict features (economic indicators) in order to predict decadal GDP growth rate.

We ran trial experiments and reviewed the literature for the hyperparameters in the respective deep learning models that include the maximum training epochs, number of hidden neurons, and learning rate parameters (alpha and beta values) for the optimization algorithm (Adam optimizer [97]). We use a maximum of 500 epochs with a batch size of 64 in the training data for the respective deep learning models, and rectifier linear activation units (Relu) in their hidden and output layers. We use adaptive moment estimation (Adam) optimizer [97] for training the respective deep learning models (LSTM, BD-LSTM, ED-LSTM, and CNN). The LSTM-based deep learning models feature five input units that use 4 recursive time steps (years) and provide 3-step-ahead (year) predictions using 3 output units.

In the VAR model, after the stationarity and co-integration test, we use the AIC as the error measure to help us determine the number of lags in the time series data. Table 2 gives

the detail of the hyperparameter of ARIMA and VAR. We use root mean squared error (RMSE) as the main prediction accuracy measure:

$$RMSE = \sqrt{\frac{1}{N} \sum_{i=1}^N (y_i - \hat{y}_i)^2} \quad (9)$$

where N represents the amount of samples, y_i is the real value and \hat{y}_i is the predicted value.

TABLE 2: The details for the parameters of the VAR and ARIMA models.

Country	ARIMA	VAR lags
Japan	(4, 2, 3)	3
Germany	(2, 0, 2)	1
America	(2, 0, 2)	1
British	(5, 0, 3)	1
Canada	(1, 2, 3)	1
France	(0, 1, 1)	1
Italy	(0, 1, 1)	1
Australia	(0, 2, 2)	4
China	(1, 0, 0)	1
India	(0, 3, 3)	1
South Africa	(2, 0, 3)	1
Brazil	(4, 2, 2)	1
Russia	(0, 1, 1)	1

We report the mean of RMSE, and 95% confidence intervals, for 30 independent experiment runs (with random model initialization of weights and biases) for the train/test datasets. We also report the RMSE at each prediction step, given by the year (prediction horizon) for the respective deep learning models. We present results in two groups, i.e. based on developed and developing countries. Figures 6 to 14 show the performance across 3-step prediction in 8 developed countries, which are Australia, Canada, France, Germany, Japan, United Kingdom and the United States. Figures 17 to 22 represent the performance in the 5 developing countries; i.e. Brazil, China, India, Russia and South Africa.

B. RESULTS: DEVELOPED COUNTRIES

Developed countries have a more stable economic environment due to their sound financial and social security systems. The inflation, employment rate and other major economic indicators do not vary substantially year-over-year. As for the GDP, the economic structure of developed countries is generally stable and gradually changing, so GDP does not have large fluctuations. As the most important group of countries in the world economy, they rarely encounter economic difficulties, except for financial crises [98] and pandemics such as COVID-19 [99].

In Figure 6 Panel (a) for the case of Australia (Table 3), we see that the deep learning models produce better accuracy (RMSE) than the traditional models (ARIMA and VAR) both

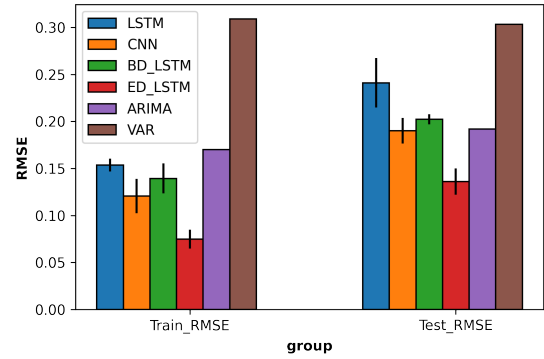

(a) RMSE mean across 3-step prediction horizon

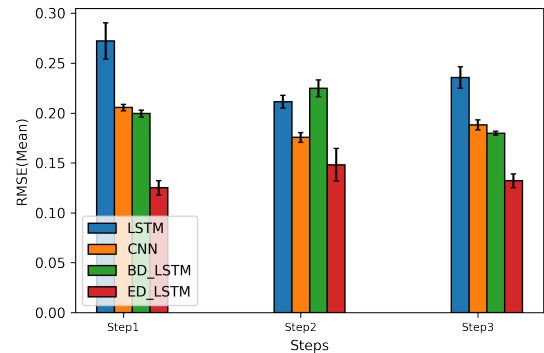

(b) RMSE of each prediction horizon

FIGURE 6: Australia: performance evaluation of respective methods (RMSE mean and 95% confidence intervals as error bar).

on the training data and test datasets. The traditional time series models provide more consistent performance across the two sets. The results of the ED-LSTM model appear consistently superior to all other models, while the prediction capabilities of CNN and ARIMA are approximately equivalent. We find that BD-LSTM is only slightly behind the former two models. The LSTM model ranks fifth, but with the largest variance, meaning that these models are the most unstable. Note that the traditional models do not feature step-ahead predictions in Table 3, and for the rest of the countries hereon. Figure 6 Panel (b) shows ED-LSTM provides the best accuracy.

We present the results for Canada in Figure 7 and Table 4, where the VAR model provides the best performance for the test dataset, exceeding its own training set results. The other four models have relatively similar results, with the ED-LSTM exhibiting slightly better performance than CNN. We find that CNN ranks second among the deep learning models. The RMSE of LSTM is the worst of these models, and its variance is substantially large, indicating that the model is extremely volatile. Panel (b) in Figure 7 demonstrates that ED-LSTM, BD-LSTM and CNN are

TABLE 3: Australia: Prediction accuracy showing RMSE mean and 95 % confidence interval (\pm).

	ARIMA	VAR	LSTM	BD-LSTM	ED-LSTM	CNN
Train	0.1699	0.3088	0.1537 \pm 0.0048	0.1393 \pm 0.0056	0.0748 \pm 0.0035	0.1207 \pm 0.0.006
Test	0.1919	0.3032	0.241 \pm 0.0187	0.2022 \pm 0.0019	0.1359 \pm 0.0048	0.1901 \pm 0.0049
Step1			0.2721 \pm 0.0065	0.1994 \pm 0.0013	0.1251 \pm 0.0026	0.2054 \pm 0.0012
Step2			0.2112 \pm 0.0022	0.2247 \pm 0.0028	0.1481 \pm 0.0051	0.1755 \pm 0.0016
Step3			0.2355 \pm 0.0036	0.1798 \pm 0.0007	0.1321 \pm 0.0023	0.188 \pm 0.0017

TABLE 4: Canada: Prediction accuracy showing RMSE mean and 95 % confidence interval (\pm).

	ARIMA	VAR	LSTM	BD-LSTM	ED-LSTM	CNN
Train	0.1873	0.2260	0.1658 \pm 0.0081	0.1553 \pm 0.0057	0.1642 \pm 0.0040	0.1671 \pm 0.0.009
Test	0.2630	0.1277	0.4422 \pm 0.06	0.2624 \pm 0.012	0.2345 \pm 0.0037	0.2507 \pm 0.0065
Step1			0.4733 \pm 0.0188	0.2884 \pm 0.0024	0.2938 \pm 0.0013	0.2937 \pm 0.0027
Step2			0.3562 \pm 0.0188	0.2481 \pm 0.0002	0.2319 \pm 0.0018	0.2381 \pm 0.0004
Step3			0.4817 \pm 0.0345	0.2485 \pm 0.0049	0.1573 \pm 0.0026	0.2133 \pm 0.0011

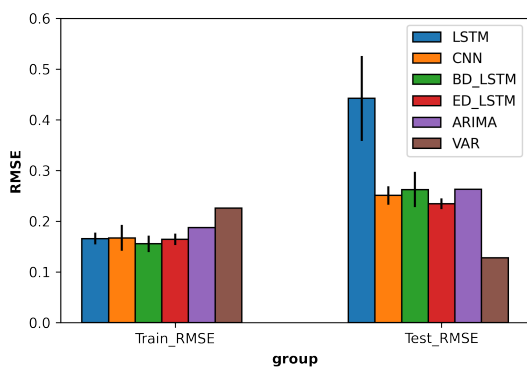

(a) RMSE mean across 3-step prediction horizon

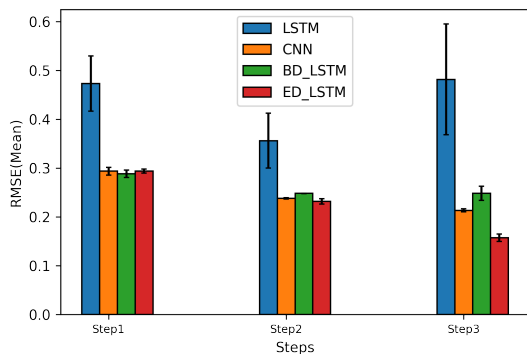

(b) RMSE of each prediction horizon

FIGURE 7: Canada: performance evaluation of respective methods (RMSE mean and 95% confidence intervals as error bar).

approximately equivalent at the first step of prediction, but as the number of steps increases the ED-LSTM demonstrates improved performance. We compare the first-step prediction plot of the ED-LSTM with VAR in Figure 8 with actual GDP.

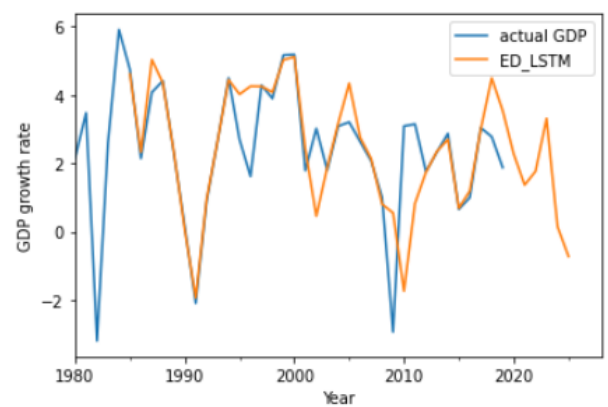

(a) Best ED-LSTM model

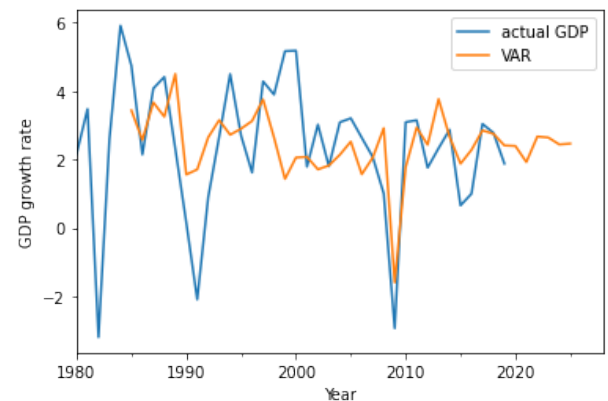

(b) VAR model

FIGURE 8: Canada: prediction plots showing the performance of the respective models.

TABLE 5: France: Prediction accuracy showing RMSE mean and 95 % confidence interval (\pm).

	ARIMA	VAR	LSTM	BD-LSTM	ED-LSTM	CNN
Train	0.2034	0.2138	0.1144 \pm 0.0087	0.0954 \pm 0.0102	0.1035 \pm 0.0055	0.0979 \pm 0.0.0042
Test	0.2723	0.1793	0.242 \pm 0.0051	0.2477 \pm 0.0098	0.1901 \pm 0.0049	0.1738 \pm 0.0124
Step1			0.2433 \pm 0.0062	0.1686 \pm 0.0013	0.2055 \pm 0.0022	0.1679 \pm 0.0004
Step2			0.2325 \pm 0.0032	0.2824 \pm 0.0015	0.2224 \pm 0.0052	0.2149 \pm 0.0017
Step3			0.2483 \pm 0.0098	0.2748 \pm 0.0067	0.1273 \pm 0.0010	0.1442 \pm 0.0012

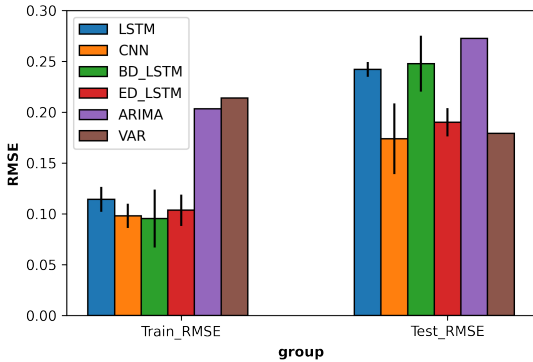

(a) RMSE mean across 3-step prediction horizon

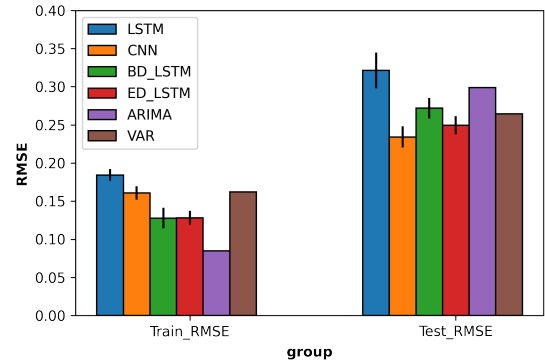

(a) RMSE mean across 3-step prediction horizon

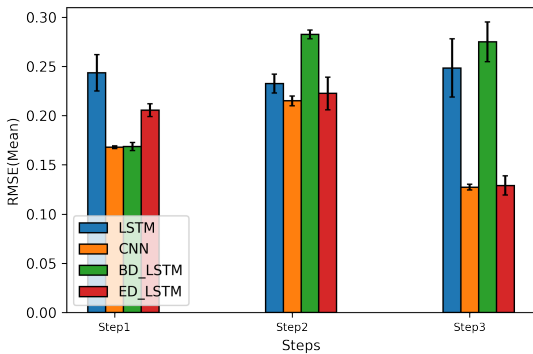

(b) RMSE of each prediction horizon

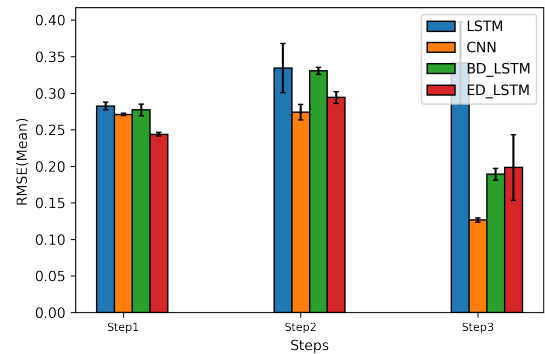

(b) RMSE of each prediction horizon

FIGURE 9: France: performance evaluation of respective methods (RMSE mean and 95% confidence interval as error bar)

Figure 9 presents the results for forecasting French GDP (Table 5), where we find that the ARIMA model is worse than all the models, while the VAR model occupies the first position. Among the four deep learning models, CNN has a better mean RMSE but slightly higher variance than the ED-LSTM for the test dataset.

Figure 10 presents the prediction performance for Germany (Table 6), where Panel (a) shows that the CNN and ED-LSTM models outperform traditional time series models. We find that CNN ranks first, while ED-LSTM and VAR are in the second and third positions for the test dataset, respectively.

We present the results for Italy in Figure 11 and Table

FIGURE 10: Germany: performance evaluation of respective methods (RMSE mean and 95% confidence intervals as error bar).

7, where the CNN and ED-LSTM models provide the best performance for both training and test datasets. In addition, they appear more stable than the other deep learning models. Figure 11 Panel (b) indicates that the ED-LSTM model has stable and strong performance across all three steps.

We present the results for Japan in Figure 12 and Table 8, where CNN and ED-LSTM models provide superior prediction performance overall. The CNN model has slightly lower errors in the test data, and the other models have significantly higher errors in both training and test data. Looking at Figure 12 Panel (b), we observe that as the number of steps increases the CNN and ED-LSTM models maintain consistent performance, while the other deep learning models deteriorate.

TABLE 6: Germany: Prediction accuracy showing RMSE mean and 95 % confidence interval (\pm).

	ARIMA	VAR	LSTM	BD-LSTM	ED-LSTM	CNN
Train	0.0847	0.1620	0.1843 \pm 0.0056	0.1277 \pm 0.0047	0.1281 \pm 0.0032	0.1607 \pm 0.0.032
Test	0.2987	0.2644	0.3215 \pm 0.016	0.2719 \pm 0.0048	0.2495 \pm 0.0042	0.2342 \pm 0.0050
Step1			0.2825 \pm 0.0018	0.2771 \pm 0.003	0.2437 \pm 0.0008	0.2709 \pm 0.0018
Step2			0.3344 \pm 0.0112	0.3306 \pm 0.0017	0.2941 \pm 0.003	0.2741 \pm 0.0036
Step3			0.3413 \pm 0.0187	0.1891 \pm 0.0027	0.1983 \pm 0.015	0.1266 \pm 0.001

TABLE 7: Italy: RMSE mean and 95 % confidence interval (\pm).

	ARIMA	VAR	LSTM	BD-LSTM	ED-LSTM	CNN
Train	0.2069	0.3095	0.1506 \pm 0.0055	0.1245 \pm 0.0081	0.1098 \pm 0.0037	0.1191 \pm 0.0.045
Test	0.2544	0.5767	0.2656 \pm 0.0223	0.2531 \pm 0.0080	0.1956 \pm 0.0017	0.2348 \pm 0.0025
Step1			0.2863 \pm 0.0023	0.2538 \pm 0.0006	0.1938 \pm 0.0023	0.1988 \pm 0.0006
Step2			0.2705 \pm 0.0054	0.291 \pm 0.002	0.2001 \pm 0.031	0.21 \pm 0.0107
Step3			0.2371 \pm 0.0023	0.1988 \pm 0.0024	0.1919 \pm 0.0052	0.2856 \pm 0.033

TABLE 8: Japan: RMSE mean and 95 % confidence interval (\pm).

	ARIMA	VAR	LSTM	BD-LSTM	ED-LSTM	CNN
Train	0.2554	0.1466	0.1561 \pm 0.0066	0.1375 \pm 0.0075	0.1312 \pm 0.0031	0.1125 \pm 0.0.0021
Test	0.3014	0.3626	0.3483 \pm 0.0253	0.5448 \pm 0.0087	0.2151 \pm 0.0009	0.2086 \pm 0.0022
Step1			0.2516 \pm 0.0009	0.2592 \pm 0.0022	0.2308 \pm 0.0019	0.1778 \pm 0.0006
Step2			0.354 \pm 0.0017	0.3966 \pm 0.0122	0.2221 \pm 0.021	0.2374 \pm 0.0018
Step3			0.4143 \pm 0.0272	0.8145 \pm 0.0382	0.1899 \pm 0.0043	0.206 \pm 0.006

TABLE 9: United Kingdom: RMSE mean and 95 % confidence interval (\pm).

	ARIMA	VAR	LSTM	BD-LSTM	ED-LSTM	CNN
Train	0.1821	0.1291	0.1767 \pm 0.0081	0.1302 \pm 0.0062	0.1132 \pm 0.0036	0.1219 \pm 0.0.0064
Test	0.3035	0.2614	0.3714 \pm 0.00843	0.199 \pm 0.0028	0.1803 \pm 0.0069	0.2143 \pm 0.011
Step1			0.3697 \pm 0.009	0.2154 \pm 0.0015	0.2046 \pm 0.0018	0.2146 \pm 0.0013
Step2			0.3772 \pm 0.0025	0.2397 \pm 0.0013	0.1886 \pm 0.015	0.2484 \pm 0.041
Step3			0.3652 \pm 0.0162	0.122 \pm 0.0033	0.1411 \pm 0.0048	0.1731 \pm 0.0037

We present the results for the United Kingdom in Figure 13 and Table 9. In 13 Panel (a), apart from the LSTM, the deep learning models perform better than traditional time series models on the test data. The ED-LSTM appears to provide the best performance; however, its variance upper bound exceeds the mean performance of the BD-LSTM model.

We present the results for the United States in Figure 14 and Table 10, where Panel (a) indicates that the two traditional time series models rank first and last, the VAR model has the best performance among these 6 models while ARIMA performs worst. Among the deep learning models, the CNN and ED-LSTM perform better than the BD-LSTM and LSTM, although BD-LSTM has the least variance. In the first 3 steps, although the four models perform similarly in the first two steps, as the number of steps increases, the prediction accuracy of LSTM and BD-LSTM gradually degrades. The ED-LSTM model performance is consistently stable, while the CNN improves as the forecast horizon increases. Figure 15 presents prediction plots of the United States GDP using ED-LSTM and VAR and compares them

with actual the GDP.

Figure 16 provides a summary of the prediction results of developed countries. We observe that CNN and ED-LSTM are far better than other models for the test dataset. BD-LSTM and two traditional models have similar results, while LSTM's results are obviously worse than other models. In each step, the deep learning models have very different trends in pairs, as the number of steps increases, CNN and ED-LSTM perform better and better, proving that CNN and ED-LSTM have the ability to achieve long-term prediction, while LSTM and BD-LSTM are completely opposite, and the increase in the number of steps directly leads to an increase in RMSE, indicating that their predictive ability for multistep-ahead prediction is relatively weak.

1) Results: Developing Countries

This section presents the forecast results for developing countries that are typically defined by countries that are still exploring the path of national development [100], which at times result in irregularities in their economic cycles [101].

TABLE 10: United States: Prediction accuracy showing RMSE mean and 95 % confidence interval (\pm).

	ARIMA	VAR	LSTM	BD-LSTM	ED-LSTM	CNN
Train	0.3263	0.1544	0.1221 \pm 0.0149	0.1359 \pm 0.0106	0.109 \pm 0.0034	0.1354 \pm 0.0099
Test	0.3435	0.0863	0.2875 \pm 0.0159	0.2056 \pm 0.0021	0.1615 \pm 0.0075	0.1828 \pm 0.0095
Step1			0.1421 \pm 0.004	0.1581 \pm 0.0035	0.1835 \pm 0.0014	0.2347 \pm 0.0003
Step2			0.1592 \pm 0.0073	0.1768 \pm 0.043	0.1349 \pm 0.0026	0.1798 \pm 0.0004
Step3			0.4475 \pm 0.0193	0.2646 \pm 0.007	0.1608 \pm 0.0088	0.1135 \pm 0.0008

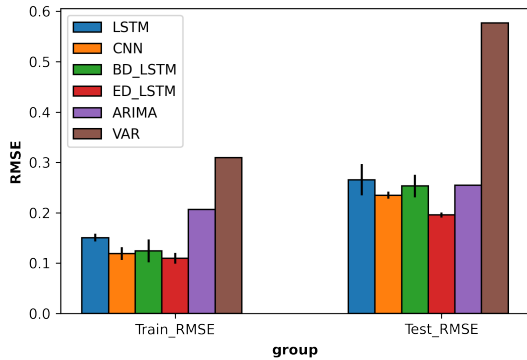

(a) RMSE mean across 3-step prediction horizon

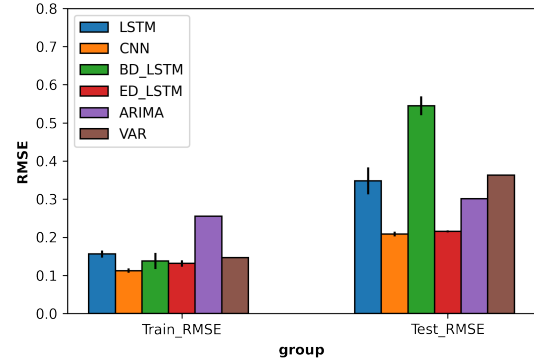

(a) RMSE across 3-step prediction horizon

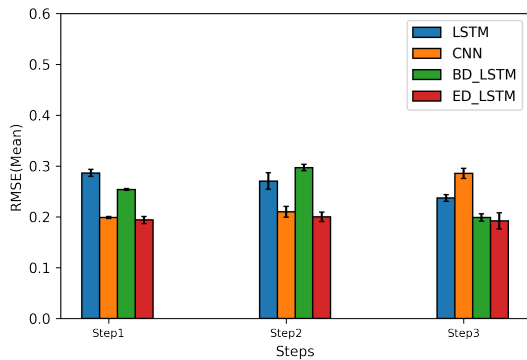

(b) RMSE of each prediction horizon

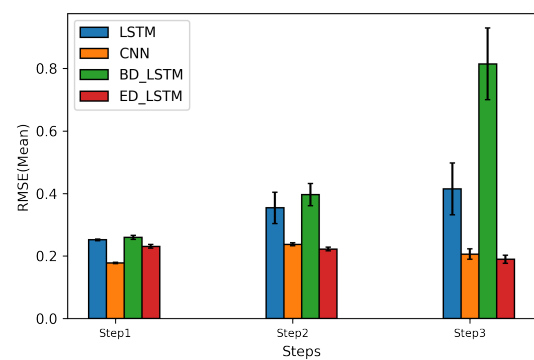

(b) RMSE of each prediction horizon

FIGURE 11: Italy: performance evaluation of respective methods (RMSE mean and 95% confidence intervals as error bar).

FIGURE 12: Japan: performance evaluation of respective methods (RMSE mean and 95% confidence intervals as error bar).

At times they have no stable trends, a high probability of abnormal rises or falls, and the transparency and credibility of their data are often questioned, making forecasting more difficult [102]. In addition, the lack of historical data for Russia due to the collapse of the Soviet Union in 1991 has undoubtedly added to the difficulty of model fitting and forecasting.

We present the results for Brazil in Figure 17 and Table 11. We observe that only ED-LSTM is better than the traditional time series models for the test dataset, and LSTM remains the worst-performing deep learning model. Examining the step-by-step predictions, we see that the RMSE of ED-LSTM deteriorates in the second step, but remains the best model for

every step.

We present the results for China in Figure 18 and Table 12, where we observe that except for LSTM, the other three deep learning models are significantly better than the traditional time series models. The RMSE of LSTM is only slightly worse than ARIMA, and also much better than VAR for the test dataset. Among the top three deep learning models, ED-LSTM ranks first, but the confidence interval (error bar) remains stable when compared with CNN and BD-LSTM.

We present the results for India in Figure 19 and Table 13, where we observe that the mean RMSE of all the deep learning models are in a similar range for the test dataset, outperforming the ARIMA but worse than the VAR. Figure

TABLE 11: Brazil: Prediction accuracy showing RMSE mean and 95 % confidence interval (\pm).

	ARIMA	VAR	LSTM	BD-LSTM	ED-LSTM	CNN
Train	0.1507	0.2169	0.1689 \pm 0.0064	0.1747 \pm 0.0055	0.1169 \pm 0.0061	0.1434 \pm 0.0.004
Test	0.3097	0.2549	0.3645 \pm 0.082	0.3344 \pm 0.0014	0.2203 \pm 0.0011	0.3303 \pm 0.0028
Step1			0.2988 \pm 0.005	0.3402 \pm 0.005	0.1979 \pm 0.005	0.2901 \pm 0.002
Step2			0.4137 \pm 0.0106	0.3367 \pm 0.004	0.2647 \pm 0.004	0.412 \pm 0.006
Step3			0.371 \pm 0.0142	0.3259 \pm 0.006	0.1894 \pm 0.006	0.2694 \pm 0.0131

TABLE 12: China: Prediction accuracy showing RMSE mean and 95 % confidence interval (\pm).

	ARIMA	VAR	LSTM	BD-LSTM	ED-LSTM	CNN
Train	0.1808	0.2394	0.1825 \pm 0.0066	0.0937 \pm 0.0032	0.0567 \pm 0.0018	0.1846 \pm 0.0.004
Test	0.2536	0.3656	0.2879 \pm 0.0024	0.1792 \pm 0.0045	0.1262 \pm 0.0073	0.1662 \pm 0.0028
Step1			0.3783 \pm 0.038	0.1701 \pm 0.0023	0.1123 \pm 0.006	0.118 \pm 0.0032
Step2			0.2977 \pm 0.0045	0.2146 \pm 0.0006	0.1198 \pm 0.0024	0.1177 \pm 0.0028
Step3			0.1294 \pm 0.0003	0.146 \pm 0.0017	0.1442 \pm 0.0012	0.2343 \pm 0.0054

TABLE 13: India: Prediction accuracy showing RMSE mean and 95 % confidence interval (\pm).

	ARIMA	VAR	LSTM	BD-LSTM	ED-LSTM	CNN
Train	0.0982	0.2032	0.1842 \pm 0.0124	0.1465 \pm 0.006	0.1197 \pm 0.0041	0.1823 \pm 0.0.0033
Test	0.3008	0.2019	0.2604 \pm 0.02164	0.2394 \pm 0.0072	0.2398 \pm 0.0081	0.2366 \pm 0.0013
Step1			0.1587 \pm 0.019	0.2475 \pm 0.0017	0.2206 \pm 0.0033	0.1923 \pm 0.007
Step2			0.1961 \pm 0.0023	0.2784 \pm 0.003	0.2745 \pm 0.0047	0.209 \pm 0.0128
Step3			0.369 \pm 0.027	0.1821 \pm 0.0005	0.2197 \pm 0.0015	0.2927 \pm 0.0063

20 presents the prediction plots of the best models and compares them with the actual GDP growth rate.

We present the results for Russia in Figure 21 and Table 14, where the CNN and ED-LSTM models outperform all others for the test 14, with the ED-LSTM exhibiting a slight advantage.

We further present the results for South Africa in Figure 22 and Table 15, where we find a similar trend when compared to the results for India. The ARIMA model, by contrast, ranks last and in the case of the deep learning models, we find that CNN and ED-LSTM maintain consistently good performance in the test dataset, ranking first and second for the deep learning models.

As in the previous section, Figure 23 shows that CNN and ED-LSTM provide better overall performance than traditional time series models for the test dataset. Looking at the individual prediction horizon (time step), ED-LSTM and CNN significantly outperform the other two models at every step, and the former is the first rank in every step. It is worth noting that for India and South Africa, the VAR performance is best according to the mean RMSE, but from the prediction curves, the VAR performance is not as good as the optimal deep learning models.

C. RECURSIVE DEEP LEARNING FRAMEWORK: RESULTS

The results in general show that both for the case of developed or developing countries (Table 17), ED-LSTM ranks first; hence, we use ED-LSTM to predict the next decade's

GDP growth rate. We use the PWT data and extend it recursively to forecast decadal growth rate. We begin the recursive strategy by forecasting features in the dataset until the features are long enough for us to forecast the GDP growth rate for the next decade.

As can be seen from Table 16, the prediction results for the features perform well and the RMSE of the test set is equivalent to the training set. Although we used GDP growth rate as the target in the *direct strategy* to train and select the optimal model, the results in Table 16 tell us that the ED-LSTM model performs well even if the target is replaced with other features in the data set. This also indicates that we can use *recursive strategy*, i.e., we can predict the features (economic indicators) first and then the GDP growth rate, which demonstrates the feasibility of our recursive strategy. Figures 24 25 26 27 28 29 30 31 32 33 34 35 36 represent the real value from 1980 to 2019 and the prediction from 2020 to 2031, the predictions include the mean of the forecast over 30 experiment runs of model training and the 95% confidence interval (CI) of the results which are shown in the black line with red shade. We observe that the 95% confidence interval in each plot is narrow, demonstrating that the results of these 30 experiments did not exhibit large variations in predictions.

D. COMPARISON WITH INSTITUTIONAL FORECASTS

In this section, we compare the results predicted in the previous section with other studies in the literature. We compare our forecast of total GDP with the forecast based on the

TABLE 14: Russia: Prediction accuracy showing RMSE mean and 95 % confidence interval (\pm).

	ARIMA	VAR	LSTM	BD-LSTM	ED-LSTM	CNN
Train	0.1348	0.3371	0.1599 \pm 0.0072	0.1535 \pm 0.0004	0.1437 \pm 0.002	0.1704 \pm 0.0049
Test	0.3029	0.3227	0.2892 \pm 0.0095	0.3211 \pm 0.0016	0.2265 \pm 0.0055	0.2453 \pm 0.0031
Step1			0.2543 \pm 0.0023	0.2896 \pm 0.002	0.2218 \pm 0.0038	0.211 \pm 0.0036
Step2			0.2945 \pm 0.0036	0.3269 \pm 0.079	0.2293 \pm 0.0032	0.3009 \pm 0.0053
Step3			0.315 \pm 0.0095	0.3436 \pm 0.0118	0.2274 \pm 0.0073	0.2115 \pm 0.0105

TABLE 15: South Africa: Prediction accuracy showing RMSE mean and 95 % confidence interval (\pm).

	ARIMA	VAR	LSTM	BD-LSTM	ED-LSTM	CNN
Train	0.1487	0.2093	0.1725 \pm 0.0068	0.0895 \pm 0.0053	0.1018 \pm 0.0041	0.1512 \pm 0.0022
Test	0.2569	0.1456	0.2031 \pm 0.0173	0.2317 \pm 0.0211	0.1901 \pm 0.002	0.1831 \pm 0.0023
Step1			0.1638 \pm 0.0037	0.209 \pm 0.0023	0.1876 \pm 0.0015	0.2324 \pm 0.021
Step2			0.2046 \pm 0.0027	0.2195 \pm 0.003	0.2179 \pm 0.0029	0.1932 \pm 0.0014
Step3			0.2335 \pm 0.07	0.263 \pm 0.005	0.1595 \pm 0.0052	0.0952 \pm 0.0045

TABLE 16: RMSE for feature prediction in recursive strategy in some countries (CSH represents the share in GDP per-capita, where C represents household consumption, I refers to the gross capital formation and G is government consumption).

Country	Feature	Train-RMSE	Test-RMSE
Australia	Net population growth	0.0432	0.0769
	CPI	0.0528	0.1128
	Employment rate	0.1595	0.1759
Brazil	CSH-C	0.1765	0.1254
	CSH-I	0.2128	0.1728
	CSH-G	0.1784	0.1292

TABLE 17: Ranking of different models for respective datasets (country) according to the RMSE.

Country	ARIMA	VAR	LSTM	BD-LSTM	ED-LSTM	CNN
Australia	3	6	5	4	1	2
Brazil	3	2	6	5	1	4
Canada	5	1	6	4	2	3
China	4	6	5	3	1	2
France	6	2	4	5	3	1
Germany	5	3	6	4	2	1
India	6	1	5	3	4	2
Italy	3	6	5	4	1	2
Japan	3	5	4	6	2	1
Russia	4	6	3	5	1	2
South Africa	6	1	5	4	3	2
United Kingdom	5	4	6	2	1	3
United States	6	1	5	4	2	3
Avg-Rank	4.53	3.38	5	4.07	1.84	2
Mode-Rank	3 and 6	6	5	4	1	2

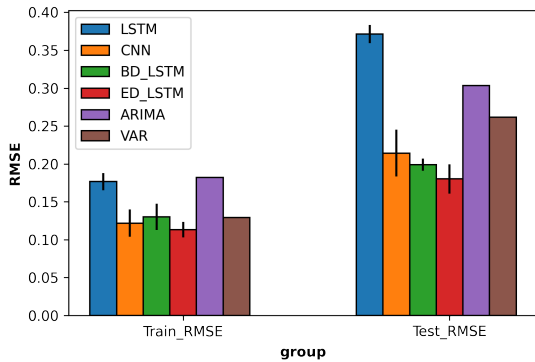

(a) RMSE mean across 3-step prediction horizon

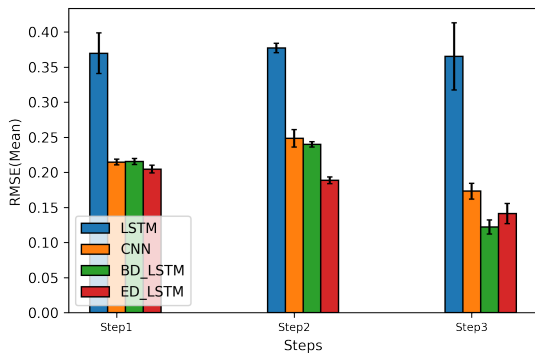

(b) RMSE of each prediction horizon

FIGURE 13: United Kingdom: performance evaluation of respective methods (RMSE mean and 95% confidence intervals as error bar).

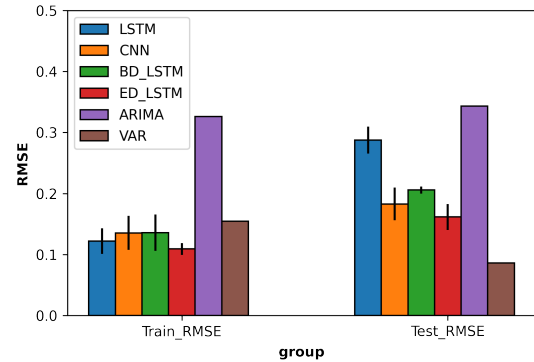

(a) RMSE mean across 3-step prediction horizon

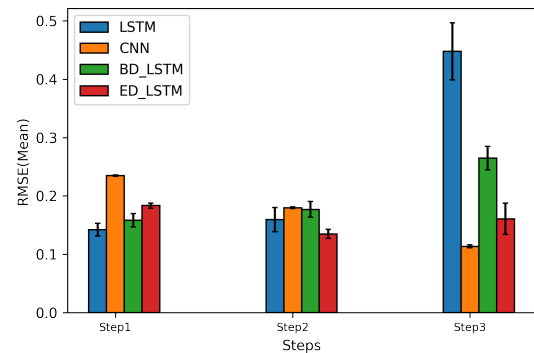

(b) RMSE of each prediction horizon

FIGURE 14: United States: performance evaluation of respective methods (RMSE mean and 95% confidence interval as error bar).

Lowy Institute for the Asian countries and the United States in Table 18 [103].

We can see that aside from China and India, our forecasts are similar to the Lowy Institute forecast [103]. The Lowy Institute forecast for China's GDP is lower than our expectations, while India's is the opposite. We recognize that changing circumstances in China mean that it is unlikely that it will continue to grow at the same rate. India may benefit from a more stable birthrate and a shift of manufacturing from the Chinese industry due to US trade disputes. The changing geopolitical circumstances are issues that we need to consider in our future work.

V. DISCUSSION

In our experiments, we first evaluated our framework using the direct strategy. We selected the data from 13 countries in the Penn World Table from 1980 to 2019 for selected developed and developing countries, respectively. Our results indicated that both for developed countries and developing countries, ED-LSTM provided the overall best results. The CNN and ED-LSTM models also provided the best performance overall with average and mode rank (Table 17).

The ARIMA model slightly lagged behind the performance of the VAR in the ranking, illustrating the importance of the exogenous variables in this task. Figure 37 presents a summary showing the mean RMSE of 13 countries using the respective models, where CNN and ED-LSTM provide the best performance on the test datasets.

Based on the model evaluation, we chose ED-LSTM for the recursive strategy as the prediction model for decadal forecasts. The GDP forecast shows that except for France, the rest of the developed countries (i.e. Australia, Canada, Germany, Italy, Japan, United Kingdom, and the United States) will experience economic growth slowdown or even recession in the first five years of the next decade. These countries will gradually return to normal and improve afterwards. Among developing countries, our model suggests that Brazil, Russia and South Africa will be impacted by the economic crisis in the future, and their economic development will stagnate in the near term. However, China and India which are the two fastest-growing developing countries will maintain a development speed higher than 4% (Figure 27-30). The Centre for Economics and Business Research [104] forecasted that India will become a 10 trillion dollar

TABLE 18: Comparison of our model with the Lowy Institute forecasts for 2030 (2017 constant Purchase Parity Power (PPP)).

Country	Forecast	Lowy	Diff
Australia	1.875	1.819	-0.56
China	30.934	24.28	-6.7
India	4.884	5.812	0.93
Japan	5.514	5.327	-0.193
Russia	1.524	1.724	0.2
United States	24.889	24.226	-0.663

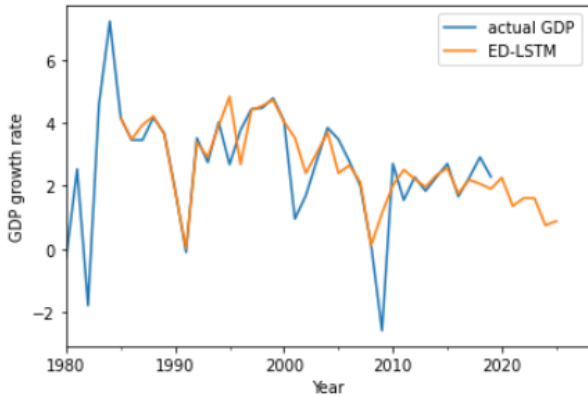

(a) Best ED-LSTM model

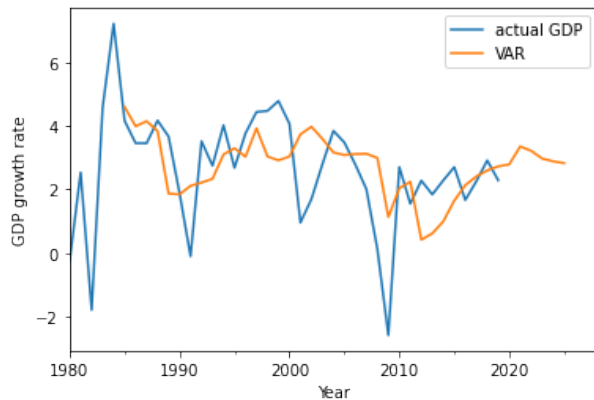

(b) VAR model

FIGURE 15: United States: prediction plot using selected models comparing with actual GDP.

GDP by 2035 and Morgan Stanley forecasted that Indian GDP will reach 11 trillion by 2032 [105]. Due to the impacts of COVID-19 and the Russia-Ukraine war, these forecasts are being rapidly adjusted by the respective organizations, including the International Monetary Fund and the World Bank.

There are certain limitations of our study due to the timeline featured in the datasets, since the data collected during the COVID-19 pandemic has not been included in the modelling process. The timeline considered was due to the Penn World Table dataset that did not feature data after 2019 when retrieved in June 2022 for our experiments. The

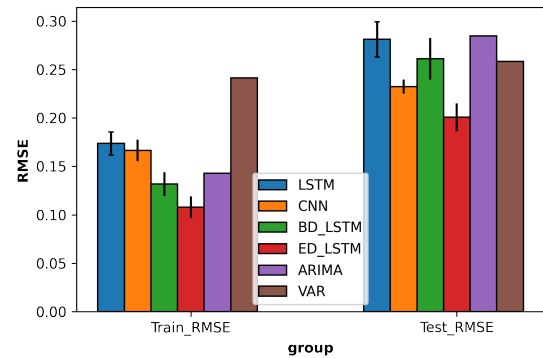

(a) Mean RMSE across 3-steps of developed countries

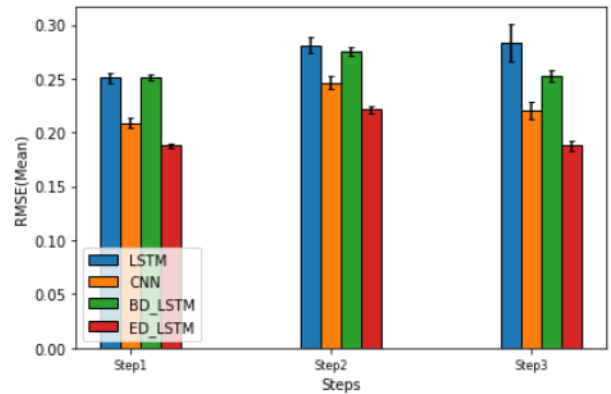

(b) RMSE of each prediction horizon

FIGURE 16: Developed countries: performance evaluation of respective methods (RMSE mean and 95% confidence intervals as error bar).

world economy in recent years has experienced significant turbulence due to COVID-19, international trade disputes, and the Russia-Ukraine war [106]. It is well known that a country's economy cannot grow stably and infinitely, it is limited by its own political and social conditions [107]. In our GDP forecast of China, the total GDP reached an incredible value after steady growth. However, in reality, the GDP growth rate of China slowed down in recent years due to the housing crisis [108], trade disputes with the United States [109], and COVID-19 [110]. The Chinese policy has also shifted from high-speed growth to high-quality growth [111]. These factors are difficult to be captured by our framework

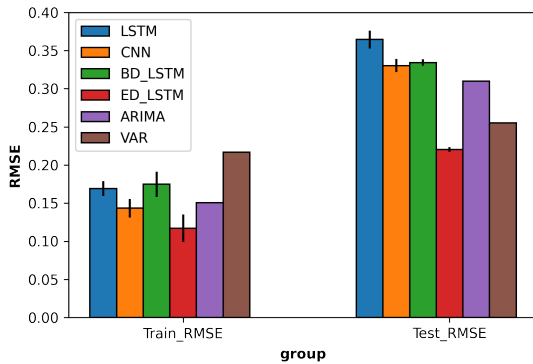

(a) RMSE mean across 3-step prediction horizon

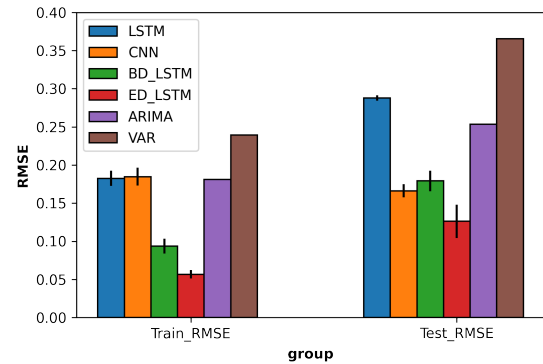

(a) RMSE mean across 3-step prediction horizon

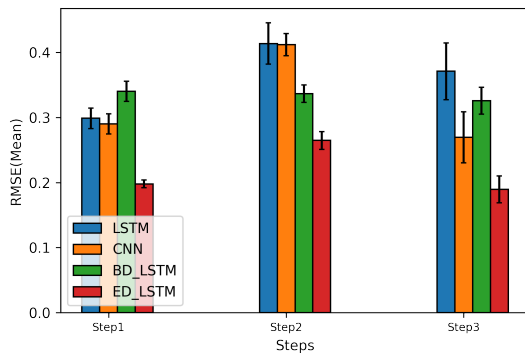

(b) RMSE of each prediction horizon

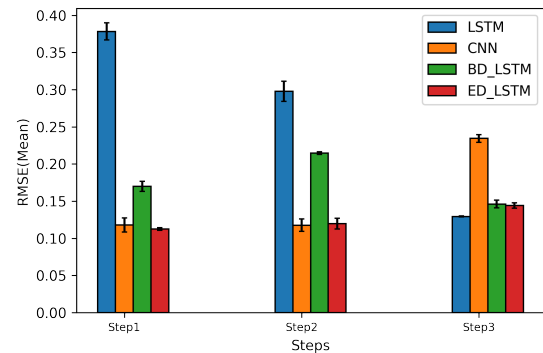

(b) RMSE of each prediction horizon

FIGURE 17: Brazil: performance evaluation of respective methods (RMSE mean and 95% confidence intervals as error bar)

given the lack of data; hence, this is also a major limitation.

Although we defined train and test sets using the time period given by the years, the shuffling strategy can be used to create train/test split from the entire time period, i.e. 1980-2019. If this is done, the true strength of the shuffling strategy can be utilized since both the train/test set would have data from different decades, and this would avoid biases in different trends of growth in different decades for the respective countries. Note that ultimately, we would need to develop a model using a direct strategy approach where such biases are minimized.

Future work can consider additional considerations for improving our framework. Firstly, we can incorporate robust uncertainty quantification in model development using Bayesian deep learning model [112], [113]. Uncertainty quantification in model predictions can provide better insights into extreme situations that will affect the economy, such as COVID-19, and trade disputes. In addition, we need to consider the relationship between economic volume and economic growth rate [114], [115]. We need data from 2020-2024 that features COVID-19 which needs to be used to train the model so that we can have model predictions for 2025-

FIGURE 18: China: performance evaluation of respective methods (RMSE mean and 95% confidence intervals as error bar).

2035. Currently, most institutional forecasts are pointing to a possibility of a recession beginning in the second half of 2023 for France. We provide open-source code for our framework that can be updated as more data is available to make future decadal forecasts.

VI. CONCLUSION

We proposed a deep learning framework for predicting the decadal GDP growth rate that included a direct strategy and a recursive strategy. We presented a novel framework that combined direct and recursive deep learning models for multistep ahead prediction. The goal of the direct strategy was to evaluate which deep learning model was best suited to be used in the recursive strategy. In the part of the direct strategy, our experiment selected 13 countries and nearly 40 years of data in the macroeconomic data set Penn World Table. We found that shuffled training data effectively avoided the overfitting of the model. We compared the performance of traditional time series models (ARIMA, and VAR) with deep learning models (CNN, LSTM, BD-LSTM and ED-LSTM) and found that ED-LSTM is the best-performing model. Hence, we later used ED-LSTM as the model for the recur-

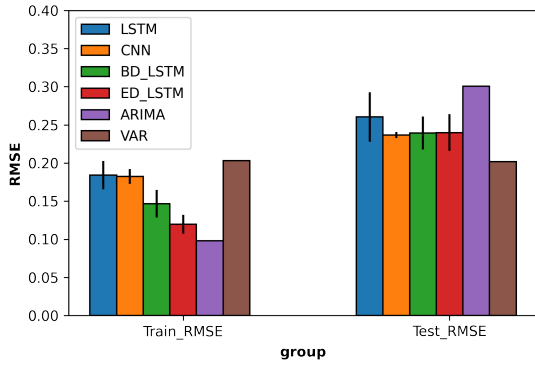

(a) RMSE mean across 3-step prediction horizon

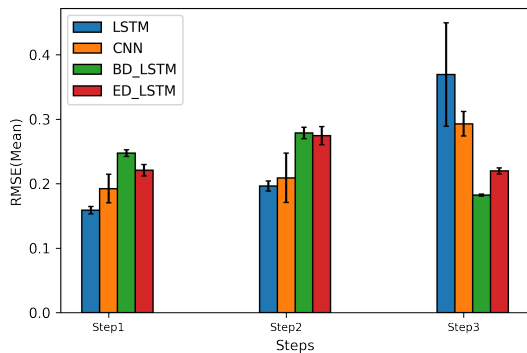

(b) RMSE of each prediction horizon

FIGURE 19: India: performance evaluation of respective methods (RMSE mean and 95% confidence intervals as error bar).

sive strategy to predict the decadal GDP growth rate of the selected developed and developing countries. The challenge has been in the prediction of decadal (long-term) forecasts, since we need to first estimate the economic indicators in order to forecast the GDP growth rate. This is challenging given that we have limited data, i.e. we only considered the last four decades of data on a yearly basis (less than 40 data points).

Our proposed framework provided accurate forecasts that compare well with institutional forecasts from the literature. A further challenge that econometric methods face compared with deep learning methods is forecast accuracy. Our results show that in the next ten years, most countries will experience an economic slowdown in terms of the GDP growth rate – negative growth in the first five years, and will return to normal in the later years. Our model only predicts China, France and India to stabilize their GDP growth rate over the next decade. We note that this is based on data till 2019 and the model needs to be trained with the latest data to get the latest decadal forecasts.

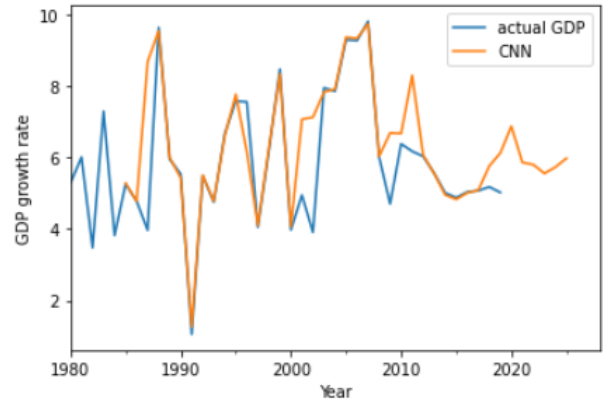

(a) CNN model

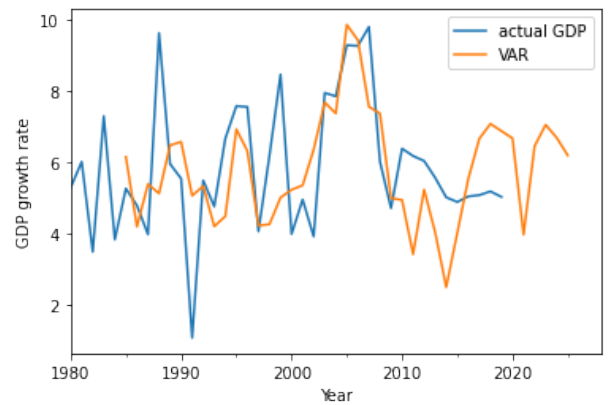

(b) VAR model

FIGURE 20: India: prediction plots of selected models comparing with actual GDP growth rate.

CODE AND DATA

We provide open source code and data for further work ³

³<https://github.com/sydney-machine-learning/deeplearning-decadalworlddeconomy>.

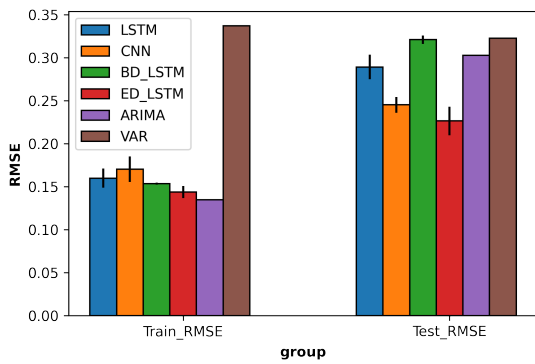

(a) RMSE mean across 3-step prediction horizon

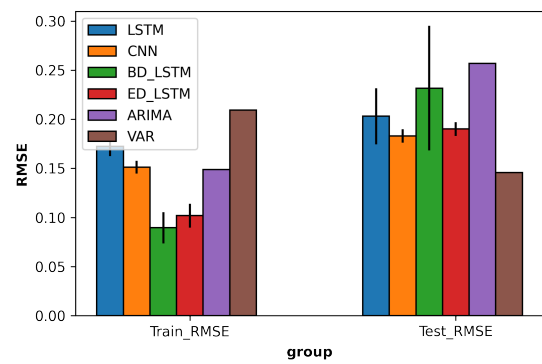

(a) RMSE mean across 3-step prediction horizon

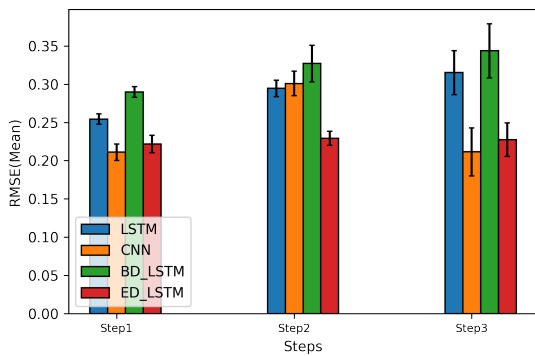

(b) RMSE of each prediction horizon

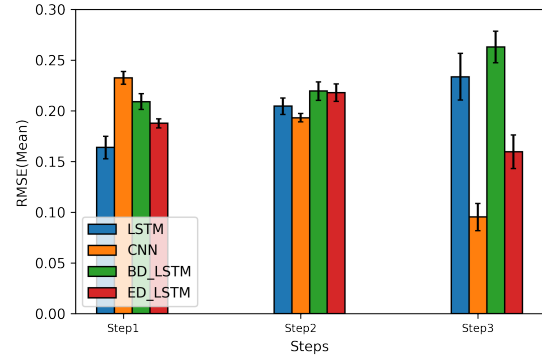

(b) RMSE of each prediction horizon

FIGURE 21: Russia: performance evaluation of respective methods (RMSE mean and 95% confidence intervals as error bar).

FIGURE 22: South Africa: performance evaluation of respective methods (RMSE mean and 95% confidence interval as error bar)

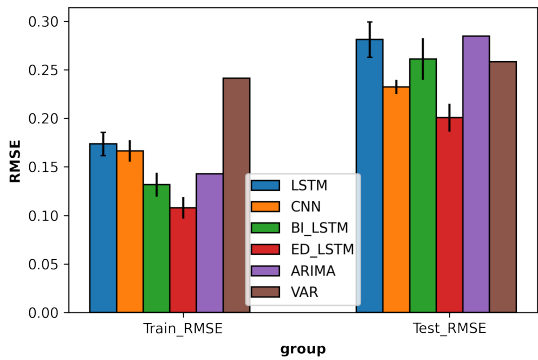

(a) Mean RMSE across 3-steps for developing countries

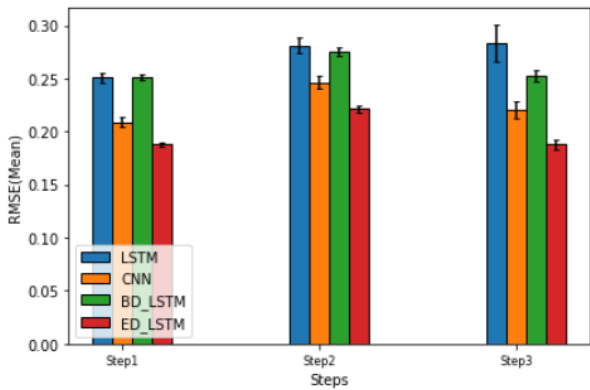

(b) RMSE of each prediction horizon

FIGURE 23: Developing countries: performance evaluation of respective methods (RMSE mean and 95% confidence intervals as error bar).

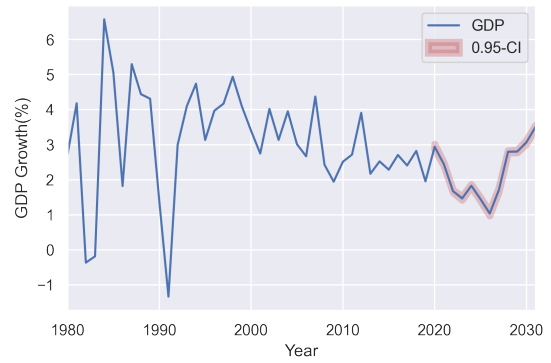

(a) Australia GDP with the model prediction (mean) and uncertainty (95% CI).

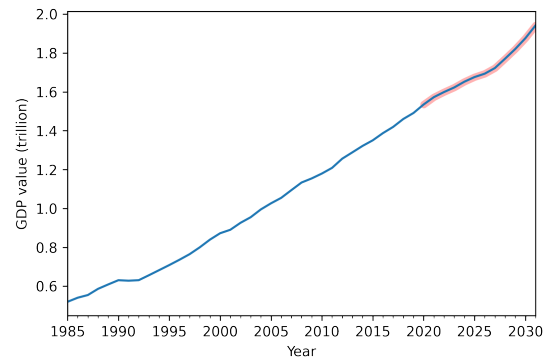

(b) Australia GDP with the model prediction (mean) and uncertainty (95% CI).

FIGURE 24: Australia actual value and recursive multivariate ED-LSTM model prediction for next decade (2020-2031).

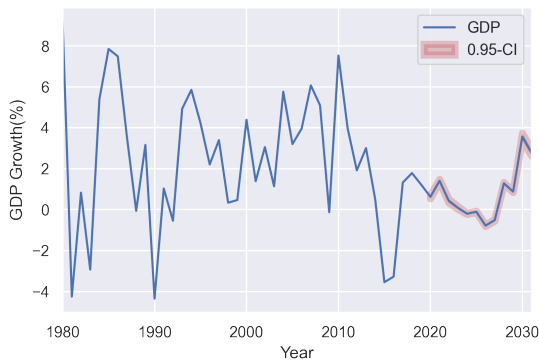

(a) Brazil GDP with the model prediction (mean) and uncertainty (95% CI).

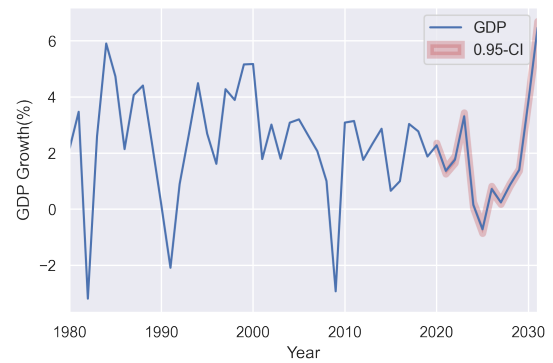

(a) Canada GDP with the model prediction (mean) and uncertainty (95% CI).

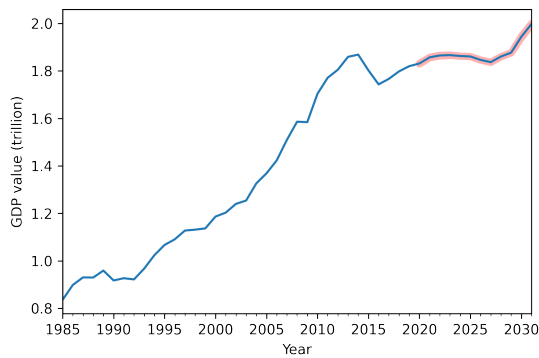

(b) Brazil GDP with the model prediction (mean) and uncertainty (95% CI).

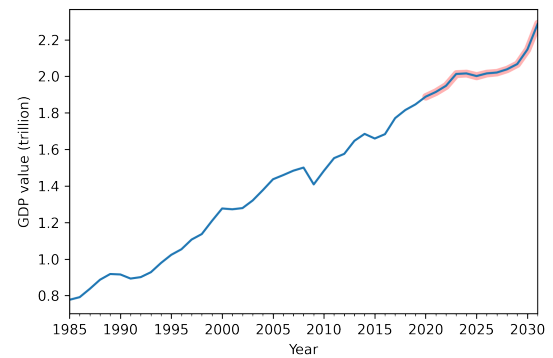

(b) Canada GDP with the model prediction (mean) and uncertainty (95% CI).

FIGURE 25: Brazil actual value and recursive multivariate ED-LSTM model prediction for next decade (2020-2031).

FIGURE 26: Canada: actual value and recursive multivariate ED-LSTM model prediction for next decade (2020-2031).

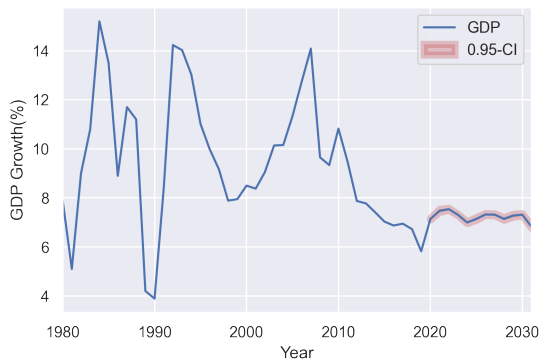

(a) China GDP with the model prediction (mean) and uncertainty (95% CI).

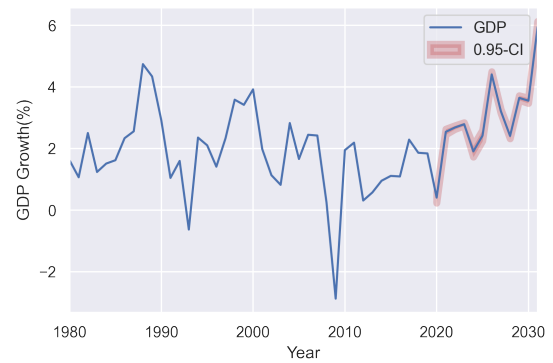

(a) France GDP with the model prediction (mean) and uncertainty (95% CI).

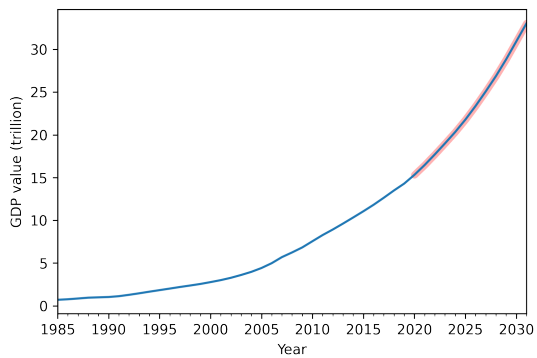

(b) China GDP with the model prediction (mean) and uncertainty (95% CI).

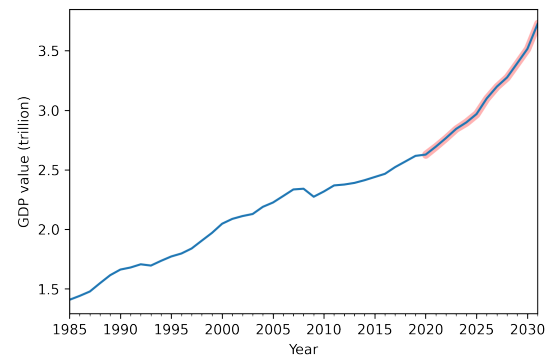

(b) France GDP with the model prediction (mean) and uncertainty (95% CI).

FIGURE 27: China: actual value and recursive multivariate ED-LSTM model prediction for next decade (2020-2031).

FIGURE 28: France: actual value and recursive multivariate ED-LSTM model prediction for next decade (2020-2031).

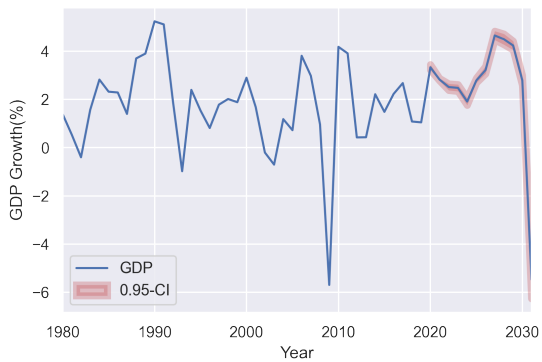

(a) Germany GDP with the model prediction (mean) and uncertainty (95% CI).

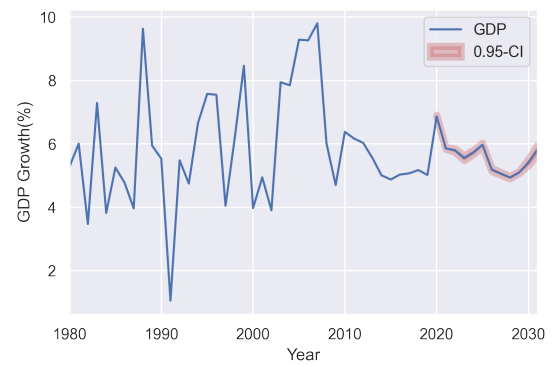

(a) India GDP with the model prediction (mean) and uncertainty (95% CI).

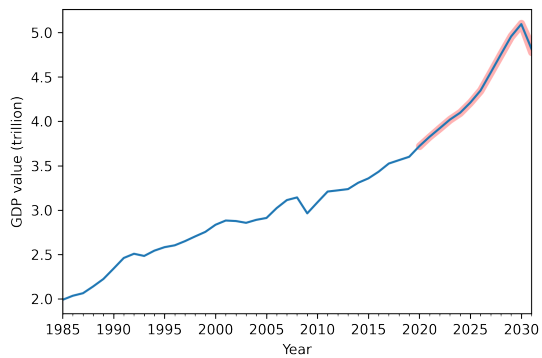

(b) Germany GDP with the model prediction (mean) and uncertainty (95% CI).

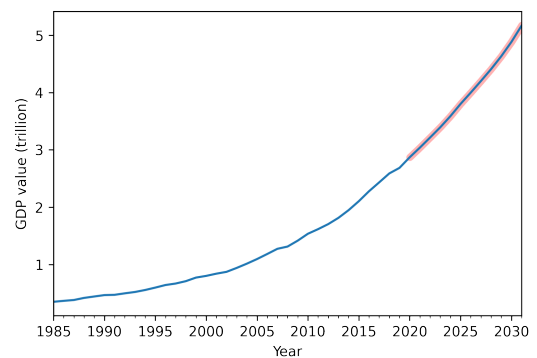

(b) India GDP with the model prediction (mean) and uncertainty (95% CI).

FIGURE 29: Germany: actual value and recursive multivariate ED-LSTM model prediction for next decade (2020-2031).

FIGURE 30: India: actual value and recursive multivariate ED-LSTM model prediction for next decade (2020-2031).

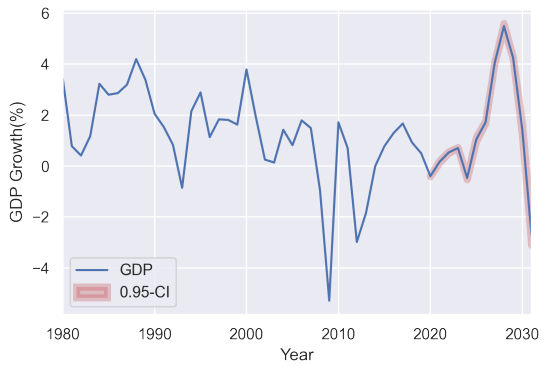

(a) Italy GDP with model prediction (mean) and uncertainty (95% CI).

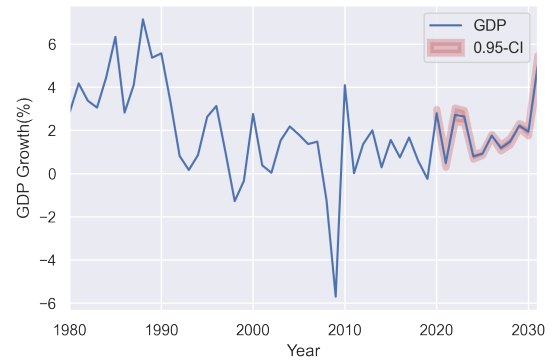

(a) Japan GDP with the model prediction (mean) and uncertainty (95% CI).

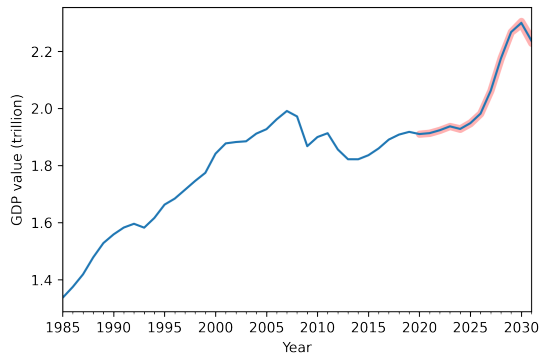

(b) Italy GDP with model prediction (mean) and uncertainty (95% CI).

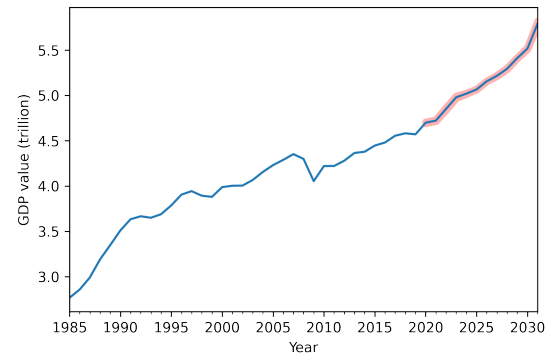

(b) Japan GDP with the model prediction (mean) and uncertainty (95% CI).

FIGURE 31: Italy actual value and recursive multivariate ED-LSTM model prediction for next decade (2020-2031).

FIGURE 32: Japan: actual value and recursive multivariate ED-LSTM model prediction for next decade (2020-2031).

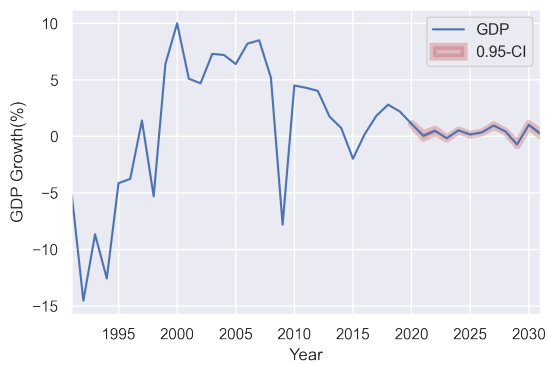

(a) Russia GDP with the model prediction (mean) and uncertainty (95% CI).

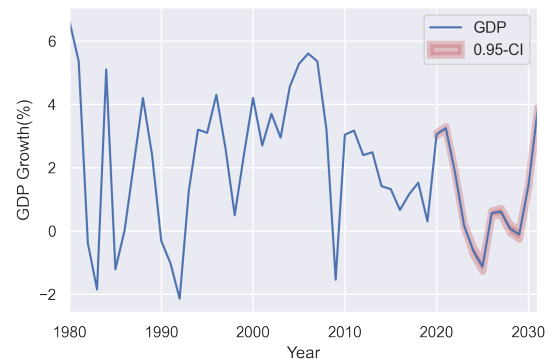

(a) South Africa with the model prediction (mean) and uncertainty (95% CI).

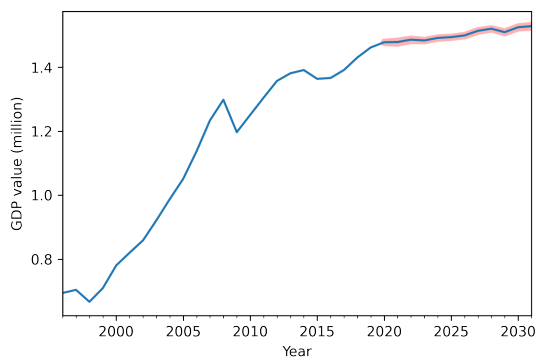

(b) Russia GDP with the model prediction (mean) and uncertainty (95% CI).

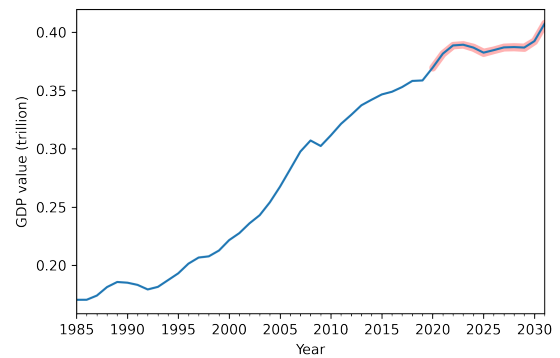

(b) South Africa GDP with the model prediction (mean) and uncertainty (95% CI).

FIGURE 33: Russia: actual value and recursive multivariate ED-LSTM model prediction for next decade (2020-2031).

FIGURE 34: South Africa: actual value and recursive multivariate ED-LSTM model prediction for next decade (2020-2031).

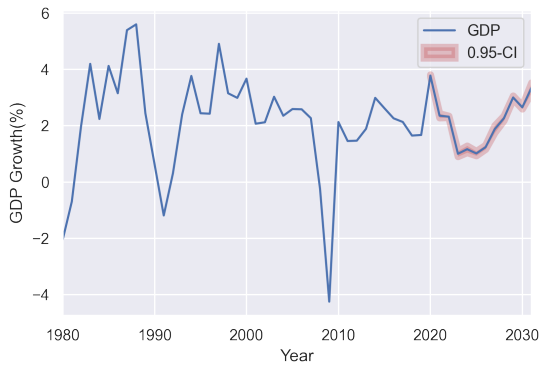

(a) United Kingdom GDP with the model prediction (mean) and uncertainty (95% CI).

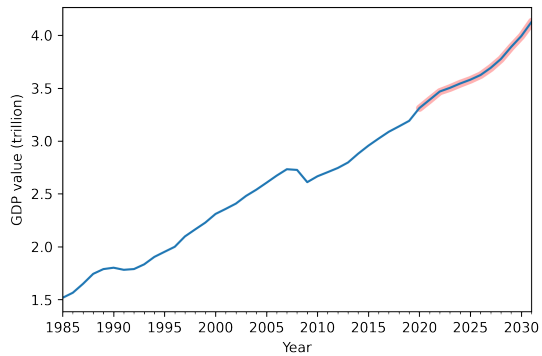

(b) United Kingdom GDP with model prediction (mean) and uncertainty (95% CI).

FIGURE 35: United Kingdom: actual value and recursive multivariate ED-LSTM model prediction for next decade (2020-2031).

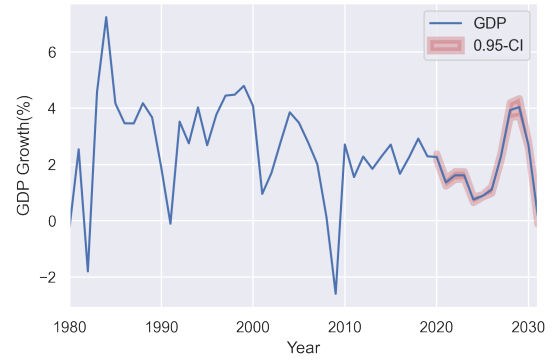

(a) United States GDP with the model prediction (mean) and uncertainty (95% CI).

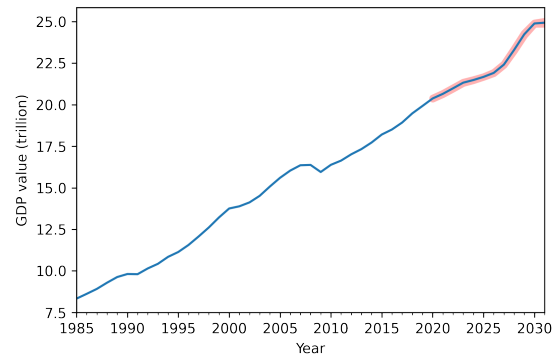

(b) United States GDP with the model prediction (mean) and uncertainty (95% CI).

FIGURE 36: United States: actual value and recursive multivariate ED-LSTM model prediction for next decade (2020-2031).

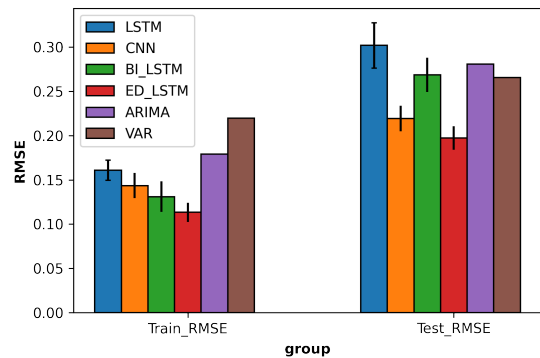

FIGURE 37: The mean RMSE of 13 countries using 6 models.

REFERENCES

- [1] W. J. Jansen and J. M. de Winter, "Combining model-based near-term GDP forecasts and judgmental forecasts: A real-time exercise for the G7 countries," *Oxford Bulletin of Economics and Statistics*, vol. 80, no. 6, pp. 1213–1242, 2018.
- [2] T. Callen, "Gross domestic product: An economy's all," International Monetary Fund: Washington, DC, USA, 2012.
- [3] P. Lepenies, *The power of a single number: a political history of GDP*. Columbia University Press, 2016.
- [4] K. A. Akkemik, "The response of employment to gdp growth in turkey: an econometric estimation," *Applied Econometrics and International Development*, vol. 7, no. 1, 2007.
- [5] L. Vladašić, A. Živković, and N. Pantić, "Macroeconomic analysis of GDP and employment in EU countries," *Ekonomika*, vol. 66, no. 1, pp. 65–76, 2020.
- [6] G. Bekaert, C. R. Harvey, C. Lundblad, and S. Siegel, "Global growth opportunities and market integration," *The Journal of Finance*, vol. 62, no. 3, pp. 1081–1137, 2007.
- [7] G. W. Evans and S. Honkapohja, "Learning and expectations in macroeconomics," in *Learning and Expectations in Macroeconomics*. Princeton University Press, 2012.
- [8] E. Casey, "Do macroeconomic forecasters use macroeconomics to forecast?" *International Journal of Forecasting*, vol. 36, no. 4, pp. 1439–1453, 2020.
- [9] D. Giannone, L. Reichlin, and D. Small, "Nowcasting: The real-time informational content of macroeconomic data," *Journal of monetary economics*, vol. 55, no. 4, pp. 665–676, 2008.
- [10] J. Lyhagen, S. Ekberg, and R. Eidstedt, "Beating the var: Improving swedish gdp forecasts using error and intercept corrections," *Journal of Forecasting*, vol. 34, no. 5, pp. 354–363, 2015.
- [11] R. Ewing, D. Gruen, and J. Hawkins, "Forecasting the macro economy," *Economic Roundup*, no. 2, pp. 11–25, June 2005. [Online]. Available: https://ideas.repec.org/a/tsy/journal/journal_tsy_er_2005_2_1.html
- [12] IMF, "World economic outlook," International Monetary Fund, 2022.
- [13] J. R. Vreeland, *The IMF and economic development*. Cambridge University Press, 2003.
- [14] P. M. Garboden, "Sources and types of big data for macroeconomic forecasting," in *Macroeconomic Forecasting in the Era of Big Data*. Springer, 2020, pp. 3–23.
- [15] W. B. Nicholson, D. S. Matteson, and J. Bien, "Varx-l: Structured regularization for large vector autoregressions with exogenous variables," *International Journal of Forecasting*, vol. 33, no. 3, pp. 627–651, 2017.
- [16] M. Marcellino and C. Schumacher, "Factor midas for nowcasting and forecasting with ragged-edge data: A model comparison for german gdp," *Oxford Bulletin of Economics and Statistics*, vol. 72, no. 4, pp. 518–550, 2010.
- [17] M. Feldkircher, F. Huber, J. Schreiner, M. Tirpák, P. Tóth, and J. Wörz, "Bridging the information gap: small-scale nowcasting models of gdp growth for selected cese countries," *Focus on European economic integration*, pp. 56–75, 06 2015.
- [18] J. Garnitz, R. Lehmann, and K. Wohlrabe, "Forecasting gdp all over the world using leading indicators based on comprehensive survey data," *Applied Economics*, vol. 51, no. 54, pp. 5802–5816, 2019. [Online]. Available: <https://doi.org/10.1080/00036846.2019.1624915>
- [19] P. Ollivaud, P.-A. Pionnier, E. Rusticelli, C. Schwellnus, and S.-H. Koh, "Forecasting gdp during and after the great recession," no. 1313, 2016. [Online]. Available: <https://www.oecd-ilibrary.org/content/paper/5jl2jj4mw40-en>
- [20] D. C. Montgomery, E. A. Peck, and G. G. Vining, *Introduction to linear regression analysis*. John Wiley & Sons, 2021.
- [21] G. E. Box, G. M. Jenkins, G. C. Reinsel, and G. M. Ljung, *Time series analysis: forecasting and control*. John Wiley & Sons, 2015.
- [22] C. A. Sims, "Macroeconomics and reality," *Econometrica: journal of the Econometric Society*, pp. 1–48, 1980.
- [23] S. Athey, "The impact of machine learning on economics," in *The economics of artificial intelligence: An agenda*. University of Chicago Press, 2018, pp. 507–547.
- [24] S. Athey and G. W. Imbens, "Machine learning methods that economists should know about," *Annual Review of Economics*, vol. 11, pp. 685–725, 2019.
- [25] J. Yoon, "Forecasting of real GDP growth using machine learning models: Gradient boosting and random forest approach," *Computational Economics*, vol. 57, no. 1, pp. 247–265, 2021.
- [26] L. Deng, "Artificial intelligence in the rising wave of deep learning: The historical path and future outlook [perspectives]," *IEEE Signal Processing Magazine*, vol. 35, pp. 180–177, 2018.
- [27] Y. LeCun, Y. Bengio, and G. Hinton, "Deep learning," *Nature*, vol. 521, no. 7553, pp. 436–444, 2015.
- [28] J. L. Elman, "Finding structure in time," *Cognitive Science*, vol. 14, no. 2, pp. 179–211, 1990. [Online]. Available: <https://www.sciencedirect.com/science/article/pii/036402139090002E>
- [29] R. Chandra and A. Krishna, "Covid-19 sentiment analysis via deep learning during the rise of novel cases," *PLoS One*, vol. 16, no. 8, p. e0255615, 2021.
- [30] S. Sun, C. Luo, and J. Chen, "A review of natural language processing techniques for opinion mining systems," *Information fusion*, vol. 36, pp. 10–25, 2017.
- [31] R. Chandra and R. Saini, "Biden vs trump: Modeling us general elections using bert language model," *IEEE Access*, vol. 9, pp. 128 494–128 505, 2021.
- [32] J. Hawkins and M. Bodén, "The applicability of recurrent neural networks for biological sequence analysis," *IEEE/ACM Transactions on Computational Biology and Bioinformatics*, vol. 2, no. 3, pp. 243–253, 2005.
- [33] R. Chandra, S. Goyal, and R. Gupta, "Evaluation of deep learning models for multi-step ahead time series prediction," *IEEE Access*, vol. 9, pp. 83 105–83 123, 2021.
- [34] S. Hochreiter and J. Schmidhuber, "Long short-term memory," *Neural computation*, vol. 9, no. 8, pp. 1735–1780, 1997.
- [35] A. Graves, S. Fernández, and J. Schmidhuber, "Bidirectional lstm networks for improved phoneme classification and recognition," in *International conference on artificial neural networks*. Springer, 2005, pp. 799–804.
- [36] A. B. Said, A. Erradi, H. A. Aly, and A. Mohamed, "Predicting covid-19 cases using bidirectional lstm on multivariate time series," *Environmental Science and Pollution Research*, vol. 28, no. 40, pp. 56 043–56 052, 2021.
- [37] K. Cho, B. Van Merriënboer, C. Gulcehre, D. Bahdanau, F. Bougares, H. Schwenk, and Y. Bengio, "Learning phrase representations using rnn encoder-decoder for statistical machine translation," *arXiv preprint arXiv:1406.1078*, 2014.
- [38] S. H. Park, B. Kim, C. M. Kang, C. C. Chung, and J. W. Choi, "Sequence-to-sequence prediction of vehicle trajectory via lstm encoder-decoder architecture," in *2018 IEEE Intelligent Vehicles Symposium (IV)*. IEEE, 2018, pp. 1672–1678.
- [39] L. Alzubaidi, J. Zhang, A. J. Humaidi, A. Al-Dujaili, Y. Duan, O. Al-Shamma, J. Santamaría, M. A. Fadhel, M. Al-Amidie, and L. Farhan, "Review of deep learning: Concepts, cnn architectures, challenges, applications, future directions," *Journal of big Data*, vol. 8, no. 1, pp. 1–74, 2021.
- [40] J.-F. Chen, W.-L. Chen, C.-P. Huang, S.-H. Huang, and A.-P. Chen, "Financial time-series data analysis using deep convolutional neural networks," in *2016 7th International conference on cloud computing and big data (CCBD)*. IEEE, 2016, pp. 87–92.
- [41] K. Maehashi and M. Shintani, "Macroeconomic forecasting using factor models and machine learning: an application to japan," *Journal of the Japanese and International Economies*, vol. 58, p. 101104, 2020.
- [42] S. Makridakis, E. Spiliotis, and V. Assimakopoulos, "Statistical and machine learning forecasting methods: Concerns and ways forward," *PloS one*, vol. 13, no. 3, p. e0194889, 2018.
- [43] M. Gilliland, "The value added by machine learning approaches in forecasting," *International Journal of Forecasting*, vol. 36, no. 1, pp. 161–166, 2020.
- [44] F. Bianchi, S. C. Ludvigson, and S. Ma, "Belief distortions and macroeconomic fluctuations," *American Economic Review*, vol. 112, no. 7, pp. 2269–2315, 2022.
- [45] P. Goulet Coulombe, M. Leroux, D. Stevanovic, and S. Surprenant, "How is machine learning useful for macroeconomic forecasting?" *Journal of Applied Econometrics*, vol. 37, no. 5, pp. 920–964, 2022.
- [46] S. Sa'adah and M. S. Wibowo, "Prediction of gross domestic product (gdp) in indonesia using deep learning algorithm," in *2020 3rd International Seminar on Research of Information Technology and Intelligent Systems (ISRITI)*. IEEE, 2020, pp. 32–36.
- [47] J. Zhang, J. Wen, and Z. Yang, "China's gdp forecasting using long short term memory recurrent neural network and hidden markov model," *PloS one*, vol. 17, no. 6, p. e0269529, 2022.
- [48] S. Sokolov-Mladenović, M. Milovančević, I. Mladenović, and M. Alizmir, "Economic growth forecasting by artificial neural network with

- extreme learning machine based on trade, import and export parameters,” *Computers in Human Behavior*, vol. 65, pp. 43–45, 2016.
- [49] M. F. Bryan and S. G. Cecchetti, “The consumer price index as a measure of inflation,” 1993.
- [50] A. Mourougane, “Forecasting monthly gdp for canada,” 2006.
- [51] S. Petrova and D. Marinova, “Using ‘soft’ and ‘hard’ social impact indicators to understand societal change caused by mining: a western australia case study,” *Impact Assessment and Project Appraisal*, vol. 33, no. 1, pp. 16–27, 2015.
- [52] L. Longo, M. Riccaboni, and A. Rungi, “A neural network ensemble approach for gdp forecasting,” *Journal of Economic Dynamics and Control*, vol. 134, p. 104278, 2022.
- [53] W. Kidane and W. Zhu, “China-Africa investment treaties: Old rules, new challenges,” *Fordham Int’l LJ*, vol. 37, p. 1035, 2013.
- [54] A. Paloni and M. Zanardi, *The IMF, World Bank and policy reform*. Routledge, 2012.
- [55] M. P. Clements and D. F. Hendry, “Multi-step estimation for forecasting,” *Oxford Bulletin of Economics and Statistics*, vol. 58, no. 4, pp. 657–684, 1996.
- [56] L. R. Klein, *essay on the theory of economic prediction*, 1971.
- [57] M. Marcellino, J. H. Stock, and M. W. Watson, “A comparison of direct and iterated multistep ar methods for forecasting macroeconomic time series,” *Journal of econometrics*, vol. 135, no. 1–2, pp. 499–526, 2006.
- [58] T. Abeysinghe, “Forecasting singapore’s quarterly gdp with monthly external trade,” *International Journal of Forecasting*, vol. 14, no. 4, pp. 505–513, 1998.
- [59] A. Meyler, G. Kenny, and T. Quinn, “Forecasting irish inflation using arima models,” 1998.
- [60] M. R. Abonazel and A. I. Abd-Elfтах, “Forecasting egyptian gdp using arima models,” *Reports on Economics and Finance*, vol. 5, no. 1, pp. 35–47, 2019.
- [61] J. R. Freeman, J. T. Williams, and T.-m. Lin, “Vector autoregression and the study of politics,” *American Journal of Political Science*, pp. 842–877, 1989.
- [62] J. J. Hox and T. M. Bechger, “An introduction to structural equation modeling,” 1998.
- [63] J. C. Robertson and E. W. Tallman, “Vector autoregressions: forecasting and reality,” *Economic Review-Federal Reserve Bank of Atlanta*, vol. 84, no. 1, p. 4, 1999.
- [64] A. A. Salisu, R. Gupta, and A. Olaniran, “The effect of oil uncertainty shock on real gdp of 33 countries: a global var approach,” *Applied Economics Letters*, pp. 1–6, 2021.
- [65] F. D. Iorio and U. Triacca, “A comparison between var processes jointly modeling gdp and unemployment rate in france and germany,” *Statistical Methods & Applications*, vol. 31, no. 3, pp. 617–635, 2022.
- [66] V. Hryhorkiv, L. Buiak, A. Verstiak, M. Hryhorkiv, O. Verstiak, and K. Tokarieva, “Forecasting financial time series using combined arima-ann algorithm,” in *2020 10th International Conference on Advanced Computer Information Technologies (ACIT)*. IEEE, 2020, pp. 455–458.
- [67] H. d’Albis, E. Boubtane, and D. Coulibaly, “Macroeconomic evidence suggests that asylum seekers are not a “burden” for western european countries,” *Science advances*, vol. 4, no. 6, p. eaaq0883, 2018.
- [68] K.-R. Müller, A. J. Smola, G. Rätsch, B. Schölkopf, J. Kohlmorgen, and V. Vapnik, “Predicting time series with support vector machines,” in *International conference on artificial neural networks*. Springer, 1997, pp. 999–1004.
- [69] K. Lau and Q. Wu, “Local prediction of non-linear time series using support vector regression,” *Pattern recognition*, vol. 41, no. 5, pp. 1539–1547, 2008.
- [70] C.-J. Lu, T.-S. Lee, and C.-C. Chiu, “Financial time series forecasting using independent component analysis and support vector regression,” *Decision support systems*, vol. 47, no. 2, pp. 115–125, 2009.
- [71] N. I. Sapankevych and R. Sankar, “Time series prediction using support vector machines: a survey,” *IEEE computational intelligence magazine*, vol. 4, no. 2, pp. 24–38, 2009.
- [72] S. Amiri, D. Von Rosen, and S. Zwanzig, “The svm approach for box-jenkins models,” *REVSTAT-Statistical journal*, vol. 7, no. 1, pp. 23–36, 2009.
- [73] F.-M. Tseng, H.-C. Yu, and G.-H. Tzeng, “Combining neural network model with seasonal time series arima model,” *Technological forecasting and social change*, vol. 69, no. 1, pp. 71–87, 2002.
- [74] J. Li, J.-h. Cheng, J.-y. Shi, and F. Huang, “Brief introduction of back propagation (bp) neural network algorithm and its improvement,” in *Advances in computer science and information engineering*. Springer, 2012, pp. 553–558.
- [75] H. K. Choi, “Stock price correlation coefficient prediction with arima-lstm hybrid model,” *arXiv preprint arXiv:1808.01560*, 2018.
- [76] S. Ouhame and Y. Hadi, “Multivariate workload prediction using vector autoregressive and stacked lstm models,” in *Proceedings of the New Challenges in Data Sciences: Acts of the Second Conference of the Moroccan Classification Society*, 2019, pp. 1–7.
- [77] I. Goodfellow, Y. Bengio, and A. Courville, *Deep learning*. MIT press, 2016.
- [78] J. Patterson and A. Gibson, *Deep learning: A practitioner’s approach*. O’Reilly Media, Inc., 2017.
- [79] H. Jelodar, Y. Wang, R. Orji, and S. Huang, “Deep sentiment classification and topic discovery on novel coronavirus or covid-19 online discussions: Nlp using lstm recurrent neural network approach,” *IEEE Journal of Biomedical and Health Informatics*, vol. 24, no. 10, pp. 2733–2742, 2020.
- [80] C. F. Cadieu, H. Hong, D. L. Yamins, N. Pinto, D. Ardila, E. A. Solomon, N. J. Majaj, and J. J. DiCarlo, “Deep neural networks rival the representation of primate it cortex for core visual object recognition,” *PLoS computational biology*, vol. 10, no. 12, p. e1003963, 2014.
- [81] G. Eraslan, Ž. Avsec, J. Gagneur, and F. J. Theis, “Deep learning: new computational modelling techniques for genomics,” *Nature Reviews Genetics*, vol. 20, no. 7, pp. 389–403, 2019.
- [82] Z. Karevan and J. A. Suykens, “Transductive lstm for time-series prediction: An application to weather forecasting,” *Neural Networks*, vol. 125, pp. 1–9, 2020.
- [83] A. Smalter Hall and T. R. Cook, “Macroeconomic indicator forecasting with deep neural networks,” *Federal Reserve Bank of Kansas City Working Paper*, no. 17-11, 2017.
- [84] S. Siami-Namini, N. Tavakoli, and A. S. Namin, “The performance of lstm and bilstm in forecasting time series,” in *2019 IEEE International Conference on Big Data (Big Data)*. IEEE, 2019, pp. 3285–3292.
- [85] S. Selvin, R. Vinayakumar, E. Gopalakrishnan, V. K. Menon, and K. Soman, “Stock price prediction using lstm, rnn and cnn-sliding window model,” in *2017 international conference on advances in computing, communications and informatics (icacci)*. IEEE, 2017, pp. 1643–1647.
- [86] Y. Piao, A. Chen, and Z. Shang, “Housing price prediction based on cnn,” in *2019 9th international conference on information science and technology (ICIST)*. IEEE, 2019, pp. 491–495.
- [87] I. E. Livieris, E. Pintelas, and P. Pintelas, “A cnn-lstm model for gold price time-series forecasting,” *Neural computing and applications*, vol. 32, no. 23, pp. 17 351–17 360, 2020.
- [88] K. M. Vu, “Sources of growth in the world economy: a comparison of G7 and E7 economies,” in *Measuring economic growth and productivity*. Elsevier, 2020, pp. 55–74.
- [89] D. W. Jorgenson and K. M. Vu, “The emergence of the new economic order: Growth in the G7 and the G20,” *Journal of Policy Modeling*, vol. 35, no. 3, pp. 389–399, 2013.
- [90] J. O’neill et al., “Building better global economic bricks,” 2001.
- [91] R. C. Feenstra, R. Inklaar, and M. P. Timmer, “The next generation of the penn world table,” *American economic review*, vol. 105, no. 10, pp. 3150–82, 2015.
- [92] H. Bozdogan, “Model selection and akaike’s information criterion (aic): The general theory and its analytical extensions,” *Psychometrika*, vol. 52, no. 3, pp. 345–370, 1987.
- [93] I. Sutskever, O. Vinyals, and Q. V. Le, “Sequence to sequence learning with neural networks,” *Advances in neural information processing systems*, vol. 27, 2014.
- [94] Y. LeCun, Y. Bengio et al., “Convolutional networks for images, speech, and time series,” *The handbook of brain theory and neural networks*, vol. 3361, no. 10, p. 1995, 1995.
- [95] M. S. Majib, M. M. Rahman, T. S. Sazzad, N. I. Khan, and S. K. Dey, “Vgg-senet: A vgg net-based deep learning framework for brain tumor detection on mri images,” *IEEE Access*, vol. 9, pp. 116 942–116 952, 2021.
- [96] H.-C. Chen, A. M. Widodo, A. Wisnujati, M. Rahaman, J. C.-W. Lin, L. Chen, and C.-E. Weng, “Alexnet convolutional neural network for disease detection and classification of tomato leaf,” *Electronics*, vol. 11, no. 6, p. 951, 2022.
- [97] D. P. Kingma and J. Ba, “Adam: A method for stochastic optimization,” *arXiv preprint arXiv:1412.6980*, 2014.

- [98] M. Edey, "The global financial crisis and its effects," *Economic Papers: A journal of applied economics and policy*, vol. 28, no. 3, pp. 186–195, 2009.
- [99] M. Izzeldin, Y. G. Muradoğlu, V. Pappas, and S. Sivaprasad, "The impact of COVID-19 on G7 stock markets volatility: Evidence from a ST-HAR model," *International Review of Financial Analysis*, vol. 74, p. 101671, 2021.
- [100] J. Hudson and P. Jones, "International trade in 'quality goods': signalling problems for developing countries," *Journal of international Development*, vol. 15, no. 8, pp. 999–1013, 2003.
- [101] M. Bussmann, H. Scheuthle, and G. Schneider, "Trade liberalization and political instability in developing countries," in *Programming for Peace*. Springer, 2006, pp. 49–70.
- [102] Y. Feng, "Political freedom, political instability, and policy uncertainty: A study of political institutions and private investment in developing countries," *International Studies Quarterly*, vol. 45, no. 2, pp. 271–294, 2001.
- [103] Lowyinstitute, "Gdp forecast 2030," <https://power.lowyinstitute.org/data/future-resources/economic-size-2030/gdp-2030/>.
- [104] C. for Economics and B. Research, "India to become 10-trillion economy by 2035: Cebr," <https://economictimes.indiatimes.com/news/economy/policy/india-to-become-10-trillion-economy-by-2035-cebr/articleshow/96526283.cms>.
- [105] M. Stanley, "India to be 3rd largest economy by 2027," <https://www.fortuneindia.com/macro/india-to-be-3rd-largest-economy-by-2027-morgan-stanley/110332#:~:text=As%20India's%20economy%20grows%20manifold,by%202032%2C%20the%20economist%20said>.
- [106] P. K. Ozili and T. Arun, "Spillover of covid-19: impact on the global economy," in *Managing Inflation and Supply Chain Disruptions in the Global Economy*. IGI Global, 2023, pp. 41–61.
- [107] T. Modis, "Long-term gdp forecasts and the prospects for growth," *Technological Forecasting and Social Change*, vol. 80, no. 8, pp. 1557–1562, 2013.
- [108] S. Jiang, J. Miao, and Y. Zhang, "China's housing bubble, infrastructure investment, and economic growth," *International Economic Review*, vol. 63, no. 3, pp. 1189–1237, 2022.
- [109] P. D. Fajgelbaum and A. K. Khandelwal, "The economic impacts of the us–china trade war," *Annual Review of Economics*, vol. 14, pp. 205–228, 2022.
- [110] Z. Habibi, H. Habibi, and M. A. Mohammadi, "The potential impact of covid-19 on the chinese gdp, trade, and economy," *Economies*, vol. 10, no. 4, p. 73, 2022.
- [111] C. Ding, C. Liu, C. Zheng, and F. Li, "Digital economy, technological innovation and high-quality economic development: Based on spatial effect and mediation effect," *Sustainability*, vol. 14, no. 1, p. 216, 2022.
- [112] R. Neal, "Bayesian learning via stochastic dynamics," *Advances in neural information processing systems*, vol. 5, 1992.
- [113] R. Chandra and A. Kapoor, "Bayesian neural multi-source transfer learning," *Neurocomputing*, vol. 378, pp. 54–64, 2020.
- [114] W. A. Lewis, *Theory of economic growth*. Routledge, 2013.
- [115] H. K. Çalışkan, "Technological change and economic growth," *Procedia-Social and Behavioral Sciences*, vol. 195, pp. 649–654, 2015.

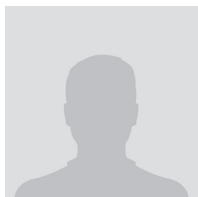

TIANYI WANG graduated from Masters in Statistics from UNSW Sydney and has strong interests in machine learning, financial forecasting and deep learning.



RODNEY BEARD graduated with a PhD in 2005 from the University of Queensland. He has a background in economics and is currently a researcher at the Pingala Institute. He has taught a variety of subjects at higher education institutions in Australia, Canada, France, UK, China and Fiji. His research focuses on computational methods in economics and finance, mathematical modelling, and machine learning.



JOHN HAWKINS is the Chief Scientist at Playground XYZ and a researcher at the Pingala Institute. He received his PhD from the University of Queensland for work on bioinformatics applications of neural networks. He has worked for 20 years researching and building machine learning systems in academia and industry. He develops open-source Python packages for data science productivity. He is the author of the book 'Getting Data Science Done' and his research projects span natural language processing, machine reasoning, time series forecasting, and explainability of model predictions.



ROHITASH CHANDRA is a Senior Lecturer in Data Science at the UNSW School of Mathematics and Statistics and IEEE Senior Member. He leads a program of research encircling methodologies and applications of artificial intelligence. Dr Chandra has used language models for analysis of translations of religious-philosophical texts. Dr Chandra used machine learning and remote sensing for mineral exploration and is currently focusing on critical metals and climate extremes, such as high category cyclones, stream flow and flooding events. Dr Chandra has been listed in Stanford's list of top 2 % scientists since 2020.

...