

# Recursive deep learning framework for forecasting the decadal world economic outlook

Tianyi Wang<sup>a</sup>, Rodney Beard<sup>b</sup>, John Hawkins<sup>b</sup>, Rohitash Chandra<sup>\*,a</sup>

<sup>a</sup>*Transitional Artificial Intelligence Research Group, School of Mathematics and Statistics, UNSW Sydney, Australia*

<sup>b</sup>*Transitional Artificial Intelligence Research Group, Sydney, Australia*

---

## Abstract

Gross domestic product (GDP) is the most widely used indicator in macroeconomics and the main tool for measuring a country's economic output. Due to the diversity and complexity of the world economy, a wide range of models have been used, but there are challenges in making decadal GDP forecasts given unexpected changes such as pandemics and wars. Deep learning models are well suited for modeling temporal sequences have been applied for time series forecasting. In this paper, we develop a deep learning framework to forecast the GDP growth rate of the world economy over a decade. We use Penn World Table as the source of our data, taking data from 1980 to 2019, across 13 countries, such as Australia, China, India, the United States and so on. We test multiple deep learning models, LSTM, BD-LSTM, ED-LSTM and CNN, and compared their results with the traditional time series model (ARIMA,VAR). Our results indicate that ED-LSTM is the best performing model. We present a recursive deep learning framework to predict the GDP growth rate in the next ten years. We predict that most countries will experience economic growth slowdown, stagnation or even recession within five years; only China, France and India are predicted to experience stable, or increasing, GDP growth.

*Key words:* Deep learning, GDP, growth rate, time series forecasting, world economy outlook

---

## 1. Introduction

Economists and policy makers rely on a wide range of macroeconomic indicators to guide decisions and social policies that impact the economies of the world [57]. Among macroeconomic indicators, gross domestic product (GDP) is the most widely used and well-known. It is a measure of the market value of all the final goods and services produced in a specific time period in a country [16]. The GDP is seen as a powerful statistical indicator of national development and progress [67] and often used as means to measure the economic health of a country. The GDP also links with employment rate [3] and gives an indication of the trade and investment opportunities [9]. Expectations are a key element of macroeconomic theories. Expectations refers to the forecasts or views that decision makers hold about future prices or inputs economics[34, 17]. Macroeconomic forecasts can also be expected to have an influence on how individuals anticipate the economy will evolve. It is precisely because GDP is closely related to many other macroeconomic indicators such as stock prices and the unemployment rate [43] that it is regarded as the "core" metric to measure the development and growth of a country. The forecasting of GDP is critical for economic policy since inaccurate

forecasts can lead to errors in decision-making[74]. Furthermore, forecasts routinely tend to fail to capture large changes [35], which are likely to be more critical for effective policy responses. Some international economic and financial organizations will publish some forecast reports unscheduled for government or corporate or even personal reference, as an example, IMF, as an international monetary fund, publishes reports every few months to provide their views on the world's economic development in the coming months or years, and some of these reports[54] will include views on GDP, which will influence countries' domestic or foreign policies [111]. For a recent overview of macroeconomic forecasting see [41]

GDP forecasting often requires the use of exogenous variables and in the machine learning context, these would be referred to as features such as oil and stock prices that can be collected more frequently than quarterly GDP data [87]. GDP forecasting has necessitated the use of domain specific modelling techniques that merge data across timescales including *bridge equations* or *dynamic factor models*[78, 38, 42, 88]. These models are generally linear equations composed over a series of lagged and difference of exogenous and auto-regressive variables[82]. They fit within the broader family of traditional time series models defined by the auto-regressive integrated moving average (ARIMA)[11] and vector auto-regression (VAR) methodologies [103]. The weakness of these approaches is the restriction to linear relationships, which has been a necessary compromise in the absence of large data sets. How-

---

\*Corresponding author

*Email address:* rohitash.chandra@unsw.edu.au (Rohitash Chandra )

ever, as these approaches have consistently failed to identify crucial changes in the economic climate [35, 88] and it remains an open research question to determine the best forecasting methodology for a given economic purpose. Machine learning methods with their emphasis on capturing non-linearity and emphasizing predictive performance have drawn the attention of econometricians [6, 7].

Deep learning provides a set of machine learning methods that have emerged in recent decades and shown to overcome previous limitations of statistical and econometric models [113, 27]. These techniques have been widely used in many fields, achieving widespread adoption in the image recognition, intelligent recommendation, and autonomous driving, etc [65]. Recurrent neural networks (RNNs) are deep learning methods designed to process arbitrarily long sequences of data [32]. They have been used for natural language processing [20, 108, 21], bioinformatics [49], and time series forecasting [18]. The LSTM model is an advanced RNN designed to identify long range dependencies in sequences [50]. The bidirectional LSTM (BD-LSTM) was developed for exploiting information across an entire sequence [47] to improve language processing models; however, it also can be used for time series forecasting [98, 18] by processing the preceding sequence in both directions. The encoder-decoder LSTM (ED-LSTM) is another variant of LSTM, it had a new architecture that learns to encode a variable-length sequence into a fixed-length vector representation and to decode a given fixed-length vector [24], widely used in pattern recognition scenarios [92] and also time series forecasting [18]. Unlike LSTM which is a variant of RNNs, convolutional neural networks (CNNs) [4] are deep learning methods which are mostly prominent in image processing, but have shown very promising results in time series prediction [18], such as stock price prediction [23]. We note that CNNs have not been extensively applied in macroeconomic forecasting [75], although they have a lot of potential.

Machine learning models have been very promising in forecasting competitions, typically through involvement of sophisticated ensemble learning methods [77, 44]. In addition, econometricians have identified important roles for machine learning models in GDP forecasting [10, 46], with deep learning models for forecasting the GDP growth rate with using a multivariate approach [97, 114, 105]. Zhang et al. [114] combined LSTM and hidden Markov models (HMMs) to use consumer price index (CPI) to forecast China's GDP before the COVID-19 pandemic. Based on import and export data, Sokolov-Mladenovic et al. [105] forecasted the GDP of European Union countries using simple neural networks and extreme learning machine models. Mourougane [83] made a monthly forecast of Canada's GDP based on hard indicators related to quantifiable indicators (industrial production, unemployment, etc.) and soft indicators which is a less tangible community characteristics and values [94] (confidence index, exchange rate, etc.). Longo et al. [71] used the ensemble method based on the LSTM to forecast the GDP of the United

States and provided insights about the contribution of different features (economic indicators) during COVID-19. The economic indicators typically used for GDP forecasting include 141 variables taken from the FRED database (US Federal reserve Database), see also [43].

Time series forecasting employs two major strategies, which include direct and recursive strategies [26, 63, 79]; although direct strategy can be used for multi-step time series prediction, the recursive strategy is more useful when the prediction horizon spans longer time. Hence, it would be more appropriate to use a mix of direct and recursive strategies in decadal forecasting. Moreover, there is a gap in decadal forecasting methods using deep learning with multivariate analysis about the economic indicators. We would need to forecast the economic indicators using a recursive deep learning strategy, in order to forecast the decadal GDP growth rate. We find that most of the papers focus on developed countries for GDP forecasting and only a few papers are forecasts for developing countries. This could be because developed countries have better access and complete data about economic indicators, which are more helpful for forecasting. It is a challenge to develop deep learning models given limited and missing data about the economic indicators to achieve good forecasting performance. In the presence of novel deep learning models, there is growing interest within the machine learning literature as to what model is most appropriate for GDP forecasting when compared to traditional econometric models such as ARIMA, and VAR.

In this paper, we use deep learning models that include LSTM-based models and CNNs for GDP growth rate forecasting of major world economies. We focus on large economies around the world that includes developing and developed countries and use data from the past few decades to forecast the future decade. We present a recursive deep learning framework where the direct strategy is used for model development and recursive strategy is used for decadal forecast. We also investigate what sort of data partitioning strategy is best for model training and development. We further compare the performance of deep learning models with traditional time series forecasting models (ARIMA and VAR) for different countries. Our data includes periods of smooth development, rapid development, and periods of financial crisis in the training set, in order to better prepare the test set and forecast data. We first use a direct strategy to evaluate the respective deep learning models and then use the best model for the recursive strategy where we estimate the economic indicators first, in order to forecast the decadal GDP growth rate. Our data features GDP along with economic indicators prior to 2019 and we forecast a decadal world economy outlook for 2020 - 2030.

The rest of the paper is organised as follows. Section 2 provides a review of the literature and Section 3 presents methodology where we evaluate deep learning models and present a recursive deep learning framework for the world economic outlook. In Section 4, we present and discuss

the results. Section 5 summarizes findings and discusses promising future developments. Section 6 concludes the paper.

## 2. Literature Review

### 2.1. Econometric models for time series forecasting

ARIMA and VAR are two of the more common statistical models in time series analysis and applied for forecasting in macro-economics. ARIMA models have been used to predict Singapore's quarterly GDP based on monthly external trade[1]. A modified ARIMA model was used to predict Irish CPI by introducing an objective penalty function methods to focus on the forecast error out-of-sample rather than 'goodness of fit' [80]. Sims [103] introduced the VAR model in economics in 1980 for macroeconomic modelling and forecasting in order to deal with endogeneity issues. Freeman and Williams[40] used a VAR model to analyze indicator variables that relate to policy and the economy. They compared their model to structural equation models[51] and found a VAR is better at capturing policy endogeneity. A decade later, Robertson et al. [96] relied on a VAR model to predict United States GDP using six economic indicators and found that imposing imprecise prior constraints on VAR can lead to more accurate predictions. Abonazel et al. [2] used ARIMA model to predict Egyptian GDP in next decade from 2019, and Salisu et al. [99] analysed how the oil uncertainty stock affect 33 countries' GDP and the influence between the countries using a global VAR. Iorio et al. [55] compared France and Germany's unemployment rate and GDP growth rate in the future basic on a VAR model. ARIMA and VAR models remain widely applied in a range of econometrics and finance applications [52, 29].

Müller et al.[84] proposed support vector regression (SVR) for time series and demonstrated improved the performance on benchmark time series problems. Lau et al.[64] implemented SVR as a local predictor to forecast Sunspot time series with better results than radial basis function and least square local predictor in relatively long-term prediction. In the financial time series forecasting domain, Lu et al.[73] introduced independent component analysis to combine with SVR model and improved the accuracy further. A wide range of applications related to time series prediction using SVR has been presented[100, 5].

Researchers in the past have combined traditional models with deep learning models for improving their performance. Tseng et al.[110] modeled the production value of Taiwan's machinery industry using seasonal time series data of soft drink factories by combining seasonal ARIMA and multi-layer perception [69], this combination achieved better results than standalone models. Choi and Hyeong Kyu [25] presented ARIMA-LSTM model for stock price correlation coefficient prediction where the ARIMA processed the linear correlation in the data and passed the

residual to the LSTM model. Ouhamme et al.[90] proposed a VAR-LSTM hybrid model where VAR considered linear information of the data and then the LSTM model catered for the non-linear data.

### 2.2. Deep learning models for time series forecasting

Deep learning methods learn from raw data to understand structures and patterns for prediction [45, 93]. Deep learning has been applied across multiple domains such as speech recognition, visual object recognition and genomics [58, 14, 33], including time series forecasting [18].

Among deep learning models, LSTM is often used for time series forecasting and has a wide range of applications, including weather, macroeconomics, stock prices, and the number of cases of COVID-19. In 2020, Karevan et al. [61] used an LSTM model to predict the weather for cities in Belgium and the Netherlands, and convert it into a transductive LSTM by changing the cost function of LSTM, which changes the way it weights the data and improves the accuracy of the prediction in this experiment. Smalter et al. [104] used an LSTM model to forecast macro-economic indicators and extended the model into the Encoder-Decoder (ED-LSTM) architecture. They used these models to predict unemployment rate and compared with a VAR model, the result showed that LSTM and its derivative ED-LSTM is better than the traditional models. Siami-Namin et al.[102] used stock market data from 1985 to 2018 to compare ARIMA, LSTM and BD-LSTM, They found that compared to ARIMA, the accuracy of LSTM has improved by 30%. In the case of BD-LSTM, they found that the training speed was slower than the LSTM model, as the BD-LSTM needs to obtain additional batches in order to achieve the equilibrium. They hypothesized that this shows that the BD-LSTM has extracted for additional features of the data that unidirectional LSTMs cannot extract. Chandra et al. [18] proposed an LSTM framework for predicting new COVID-19 cases in India in a single day. By comparing with LSTM and BD-LSTM, they found that the univariate random-split ED-LSTM performed best in this experiment, and used it made forecasts two months in advance.

The CNN model can also be used for time series related problems. Selvin et al. [101] implemented a CNN to predict the stock prices of Infosys, TCS and Cipla. When compared to the RNN and LSTM, CNN was the best model for predicting stock price since the CNN model only relies on current information and has an advantage when dealing with data that is not too cyclical. Piao et al. [95] predicted the housing prices using a CNN model, and used a CNN for variable selection. Livieris et al. [70] proposed the CNN-LSTM model to predict the prices and price trend for gold markets. CNN-LSTM is a traditional LSTM model that adds multiple additional convolutional layers, which effectively improves the prediction accuracy of the model.

### 3. Methodology

#### 3.1. Data

The Group of Seven (G7) is an inter-governmental political forum consisting seven developed countries Canada, France, Germany, Italy, Japan, the United Kingdom and the United States. These countries exert significant influence over global geo-political affairs that impact the world economy[112, 60]. BRICS refers to the five major emerging economies and developing countries, including Brazil, Russia, India, China and South Africa. The BRICS countries occupy 27% of the world’s land area, 43% of the population and 24% of the GDP[8, 85]. These developing countries occupy an indispensable position in the future development of the world[89].

We select thirteen countries by combining Australia with the group of seven (G7) and BRICS. This set includes developed and developing countries, and covers a significant proportion of the global economy. We use the Penn World Table version 10.0<sup>1</sup>[37] to extract a time series dataset of economic indicators for each of these countries. The PWT 10.0 database contains information on relative levels of income, output, input and productivity, covering 183 countries between 1950 and 2019. We chose to extract data for the period from 1980 to 2019, to maximise the number of countries with complete coverage. The exception is Russia, for which there is only data for the period from 1991-2019.

We chose a subset of the available variables to use in our models for predicting GDP growth rate. This included GDP, net population, CPI, employment rate, share of labour compensation in GDP at current national prices, exchange rate, gross domestic product per capital (CGDPo), and price-levels that refer to the perspectives of macroeconomics (production, expenditure, and trade), finance, and human resources, supplemented by a price index that can show whether inflation is present, to help us better predict economic development and economic crises [114, 105, 83, 71]. We transform data into year-on-year ratio in order to predict GDP growth rate.

The year-on-year ratio  $R$  formula is:

$$R = \frac{Data_n - Data_{n-1}}{Data_{n-1}} \quad (1)$$

where  $n$  represents  $n$ th year

Once all of the variables are transformed into year-on-year ratio, we apply a min-max scaling operation to remove the inter-variable scale differences and ensure all values reside between zero and one..

##### 3.1.1. Data Processing

In the traditional time series models (ARIMA and VAR), we simply divide the data into training and test

sets by time and proportion. In the deep learning models, in order to develop multivariate and multi-step prediction model, we need to reconstruct the original data.

Suppose our original data structure is

$$[x_1, x_2, \dots, x_N; y_1, y_2, \dots, y_N]$$

where  $N$  is the length of data. Next, we introduce the definition of time window  $T$ . The reconstructed data  $D$  consists of multiple data windows

$$[T_1, T_2, \dots, T_{N-m}]$$

. Each data window can be regarded as the data used for model training. We need to determine the input step size  $m$  and output step size  $n$  first. In a time window, we have  $m$ -step input  $X$  to represent  $m$ -th exogenous series in  $T$  and  $n$ -step output  $Y$  as the  $n$ -th target series of  $T$ , then the example of the first time window is as follows.

$$\begin{aligned} X_1 &= [x_1, x_2, \dots, x_m] \\ Y_1 &= [y_{m+1}, y_{m+2}, \dots, y_{m+n}] \end{aligned} \quad (2)$$

Next, using the same method, we can reconstruct the remaining data until  $x_N$  is included in the latest time window, so we can write its universal formula below.

$$\begin{aligned} X_i &= [x_i, x_{i+1}, \dots, x_{i+m}] \\ Y_i &= [y_{i+m+1}, y_{i+m+2}, \dots, y_{i+m+n}] \end{aligned} \quad (3)$$

#### 3.2. Econometric models

##### 3.2.1. ARIMA model

The ARIMA model has been prominent for nearly half a century in time series forecasting after being introduced by Box and Jenkins [11]. It is a combination of three components, auto-regressive model ( $AR$ ), integrated average ( $I$ ) and moving average model ( $MA$ ). ARIMA models have three parameters to represent the three part in this model respectively, written as  $ARIMA(p, d, q)$ .  $AR(p)$  represents the past value which is used to predict,  $p$  could be determined by PACF (partial auto-correlation function).  $I(d)$  is the times of differences to ensure the data stable, we use the ADF (augmented Dickey-Fuller test) to help us to find  $d$ .  $MA(q)$  expresses the current data and errors in the past  $q$  values, which is found by by analysing the ACF (auto-correlation function).

The ARIMA model is given by

$$\begin{aligned} w_t &= \Delta^d y_t \\ w_t &= \phi_1 w_{t-1} + \dots + \phi_p w_{t-p} + \varepsilon_t - \theta_1 \varepsilon_{t-1} - \dots - \theta_q \varepsilon_{t-q} \end{aligned} \quad (4)$$

where  $\phi$  and  $\theta$  are the coefficients of values  $w$  and errors  $\varepsilon$ .

##### 3.2.2. VAR model

The VAR model introduced by Sims [103] has been used to explain the relationship with exogenous variables (fea-

<sup>1</sup><https://www.rug.nl/ggdc/productivity/pwt/?lang=en>PWT 10.0

tures) in the data. The model combines the lagged endogenous variables with the exogenous variables to explain the endogenous variable (target) which extends the regression model to multivariate time series.

$$Y_t = BX_t + A_1Y_{t-1} + \dots + A_pY_{t-p} + u_t \quad (5)$$

where  $X$  is the exogenous variable,  $Y$  is the endogenous variable,  $u$  is the error term,  $A$  and  $B$  are the coefficients.

$$AIC = -2\ln(L) + 2k \quad (6)$$

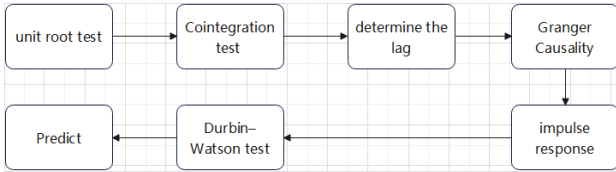

Figure 1: The process of using VAR.

The Akaike Information Criterion(AIC) [12] is typically used in VAR model for determining model hyper-parameters, such as determining the best lag, where  $L$  is the maximum likelihood,  $k$  is the number of parameters.

### 3.3. Deep learning models

#### 3.3.1. LSTM model

A recurrent neural network (RNN) is a prominent deep learning model that can be used to model time series data [24]. RNNs feature a recurrent (context) layer  $h$  to cater for memory for preserving state information for output  $y$  during processing of a sequence data  $x = (x_1, \dots, x_t)$ . The hidden layer  $h_t$  stores the previous hidden result to update the weight  $w_{hh}$  to process the  $x_t$  in next time step and output  $y_t$ , as shown in Figure 2 and given by

$$\begin{aligned} y_t &= f_1(h_t w_{hy} + b_y) \\ h_t &= f_2(x_t w_{hx} + h_{t-1} w_{hh} + b_h) \end{aligned} \quad (7)$$

where  $w$  is the weight in different layers,  $f_1$  and  $f_2$  are the activation function, and  $b$  is the bias.

Conventional RNNs faced limitations in training due to vanishing gradients in long sequences; hence, Hochreiter and Schmidhuber [50] designed LSTM network which introduce memory cells and gates that enable them to have better performance in processing the long-term dependencies in sequences. Figure 3) presents the LSTM network, the recurrent context layer is leveraged by memory cells.

BD-LSTM is a variant with two types of LSTM cells and process the input sequence data in two direction, from the start to the end, and from the end backwards. This bi-directionality allows the model to build up two separate hidden state representations of the input sequence. The structure is shown in Figure 4.

The ED-LSTM is another variant of LSTM with encoder-decoder architecture proposed by Sutskever et al.

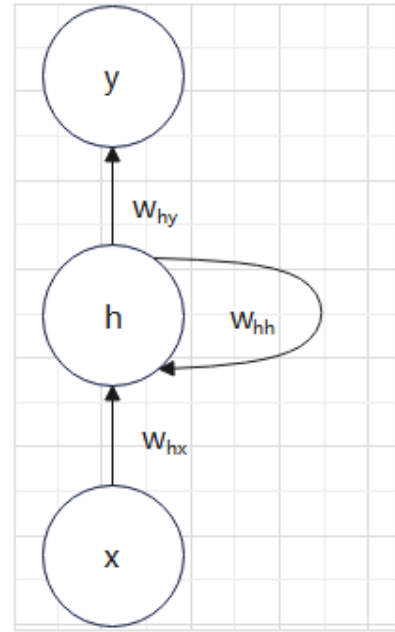

Figure 2: RNN structure showing information from input  $x$  to output  $y$  via the state and hidden layers  $h$ .

[109] that features two types of new cells to process the data, the encoder processes the input series data  $x_1, \dots, x_t$  with  $T$  length, then transfer the summary of past series data to the cell state  $c_t$ , in the encoder system. There are  $T$  LSTM cells to recursive  $T$  time until getting the summaries of all the series data and transfer the result in to cell state  $c_T$ ,  $c_T$  is also the initial input to the decoder system (i.e.,  $c_T = c'_0$ ). This helps the LSTM cells in decoder system to output  $y_1, \dots, y'_t$ , and each time of update, the previous output would be used as input in current step. ED-LSTM structure is shown in Figure 5.

Basically, this architecture estimates the conditional probability of the output sequence  $y_1, \dots, y'_t$  given the input sequence  $x_1, \dots, x_t$  (i.e.,  $p(y_1, \dots, y'_t | x_1, \dots, x_t)$ ).

#### 3.3.2. CNN

Inspired by research on the visual cortex of the mammalian biological brain, Yann Le Cun introduced CNN [66]. CNN consists of input layer, convolution layer, pooling layer, fully connected layer and output layer. The convolutional and pooling layers can be placed multiple times as a combination before the output layer depending on the requirements of the application. These components have been used to design multiple CNN architectures such as VGG-Net[76] and Alex-Net[22] for complex computer vision tasks. The convolutional layer extracts features of the input through the convolution operation, that are then filtered by the pooling layer. Finally, information is passed to the fully connected layer which is essentially a simple neural network. The CNN has been prominent for computer vision and image processing tasks, in recent years, it

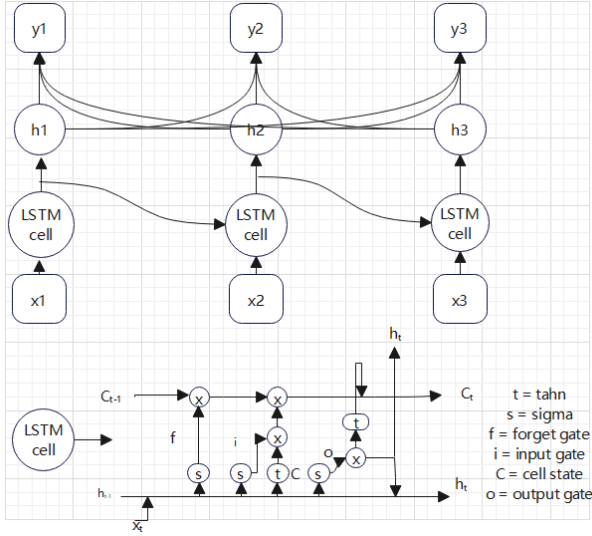

Figure 3: LSTM network with the LSTM memory cell for handling long-term dependencies.

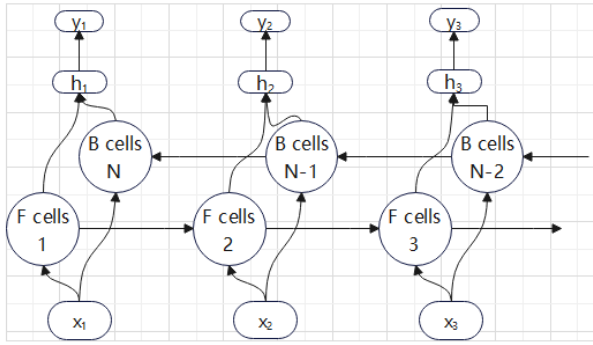

Figure 4: BD-LSTM structure with forward direction LSTM cells *F cells* and backward direction LSTM cells *B cells*.

also has been applied for time series prediction [101, 95, 18] and hence we use it as a model for comparison.

### 3.4. Direct and recursive deep learning framework for decadal world economy outlook

We apply two strategies for forecasting, direct and recursive, both of which are illustrated in Figure 6, The direct strategy is used for model development and model evaluation, and the recursive strategy is used for decadal forecasting.

In the direct strategy, we use a fixed window of historical economic indicators from the PWT database (as discussed in Section 3.1.) We process the data before evaluating the respective econometric and deep learning models given in Section 3.2 and 3.3, respectively. There are four steps (transform into year-on-year ratio, min-max scale, data reconstruction, and data shuffled) in the data processing, we convert the data to year-on-year ratios and normalise them to remove the effects of variable ranges. We reconstruct the data to fit the deep learning model. We shuffle the data to create a training and test rest while preserving

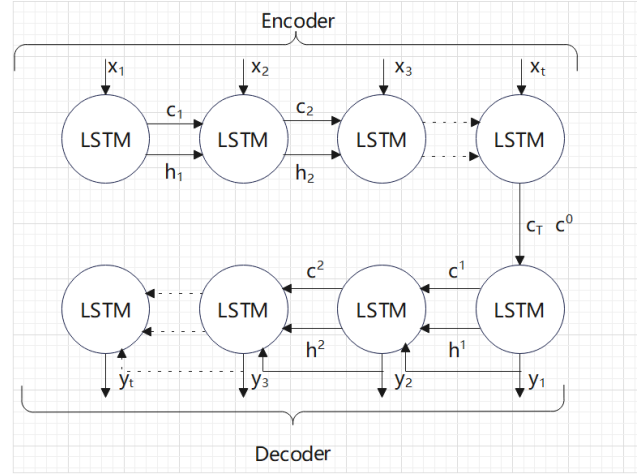

Figure 5: ED-LSTM structure: The Encoder module is used to summarize sequence information, and the Decoder module is used to output.

temporal dependence for a short time window, i.e 4 years in the past to forecast 3 years in the future. After the data has been processed, we train the model and then compare the accuracy and average ranking of the models on the test data set to assess how good the model is and which data partitioning strategy is most suitable for model training and development. We further compare the performance of deep learning models on the test data set with econometric models (ARIMA and VAR) and select the model with the best forecasting accuracy from these models as the model for the recursive strategy.

In the recursive strategy shown in Figure 6, we will use the optimal model and data partitioning evaluated in the direct strategy. First we need to train the model, and to ensure consistency here we use the same training set as in the direct strategy for training. The second step is to use the data to make forecasts. Unlike the direct strategy where the GDP growth rate is the target, this step target is features, but the independent variables used are still the same. Our model features multivariate input and one output (multi-to-one), so we can only predict one feature at a time, and we will predict all features in Step 2.3 and Step 2.4. When we finish this two steps to forecast and then determine whether the length of the current features is enough for us to predict the decadal GDP growth rate in Step 2.5. If the answer is no, then we go back to the beginning of Step 2.3 and continue to predict the new features. However, if the answer is yes, then we make the final prediction, i.e. the decadal GDP growth rate.

We note that in the direct strategy, the model only predicts the GDP growth rate, whereas in the recursive strategy, the model first predicts the features (economic indicators) which are then used to predict the decadal GDP growth rate. The advantage of the recursive strategy is that we can optimise the length of time step required for the deep learning model within a reasonable range, and not have the longer prediction window limit our data par-

tioning. We can use the optimal short ranger forecast model to pursue prediction accuracy, and then use a recursive strategy to achieve our long term forecast goal.

### 3.4.1. Training and test data

We take 1980-2010 data as the train data set with shuffling. The test data set is the rest of the data which between 2011 and 2019 after shuffling. In the case of Russia, its train data set begins at 1991 but still end at 2010, its test data set share the same period with other countries as shown in Table 1. Before importing the data into the deep learning model, we need to transform the training set and test set to a structure suitable for time series forecasting. Here we use a structure of 5 inputs and 3 outputs and shuffle it. The shuffled data set considers time windows in the reconstructed data set as given in Equation (??), the order and length inside the time window does not change (eg. past 4 years of input to the model to predict next 3 years).

Table 1: the period of train and test data set

|        | Train Data set | Test Data set |
|--------|----------------|---------------|
| Russia | 1991-2010      | 2011-2019     |
| Others | 1980-2010      | 2011-2019     |

$$X_i = [x_i, x_{i+1}, \dots, x_{i+m}] \quad (8)$$

$$Y_i = [y_{i+m+1}, y_{i+m+2}, \dots, y_{i+m+n}]$$

$$T_i = [X_i; Y_i]$$

$$D_{shuffled} = [T_3, T_8, T_5 \dots, T_2]$$

## 4. Results

### 4.1. Technical set-up

Our experiments first use direct strategy to evaluate the model, use the data of 13 countries in Penn-World data to compare the results and select the best model according to prediction accuracy. Then, in the second part, we will use this best-performing model to forecast the GDP growth rate of these 13 countries for the next ten years where we need recursive strategy to predict features (economic indicators) in order to predict decadal GDP growth rate.

Table 2 shows the details for the topology of the respective deep learning models in terms of input, hidden and output layers. We run 30 times experiments [18] for 500 epochs with batch-size of 64 in the training data in the deep learning models, and rectifier linear activation units (Relu) in hidden and output layers. We use adaptive moment estimation (Adam) optimiser [62] for training the deep learning models (LSTM, BD-LSTM, ED-LSTM and CNN).

In the VAR model, after the data pass the stationarity and co-integration test, we use AIC as the measurement to help us choose the best lag, and for the three parameters

Table 2: the details for the topology of the respective deep learning models in terms of input

|         | input | layers | output | comment             |
|---------|-------|--------|--------|---------------------|
| LSTM    | 5     | 1      | 10     | Hidden neurons = 10 |
| BD-LSTM | 5     | 1      | 10     | Hidden neurons = 10 |
| ED-LSTM | 5     | 3      | 10     | Hidden neurons = 10 |
| CNN     | 5     | 4      | 10     | pool size = 2       |

of ARIMA, AR(p), I(d) and MA(q). Table gives the detail of the hyper-parameter of ARIMA and VAR.

We use root mean squared error(RMSE) as the main prediction accuracy measure:

$$RMSE = \sqrt{\frac{1}{N} \sum_{i=1}^N (y_i - \hat{y}_i)^2} \quad (9)$$

where  $N$  represents the amount of samples,  $y_i$  is the real value and  $\hat{y}_i$  is the predicted value.

Table 3: the details for the parameters of the traditional time series model

| Country      | ARIMA     | VAR lags |
|--------------|-----------|----------|
| Japan        | (4, 2, 3) | 3        |
| Germany      | (2, 0, 2) | 1        |
| America      | (2, 0, 2) | 1        |
| British      | (5, 0, 3) | 1        |
| Canada       | (1, 2, 3) | 1        |
| France       | (0, 1, 1) | 1        |
| Italy        | (0, 1, 1) | 1        |
| Australia    | (0, 2, 2) | 4        |
| China        | (1, 0, 0) | 1        |
| India        | (0, 3, 3) | 1        |
| South Africa | (2, 0, 3) | 1        |
| Brazil       | (4, 2, 2) | 1        |
| Russia       | (0, 1, 1) | 1        |

We report the mean of RMSE, and 95% confidence interval, for 30 independent experiment runs (with random initialisation of weights and biases) in each country from the train/test datasets. We also report the RMSE at each prediction step given by year (prediction horizon) for the neural network models. We present results in two parts, according to whether it is a developed or developing country.

Figures 8 to 15 shows the performance across 10-steps prediction in 8 developed countries, which is Australia, Canada, France, Germany, Japan, United Kingdom and United States. Figures 17 to 21 represent the performance in the 5 developing countries, Brazil, China, India, Russia and South Africa.

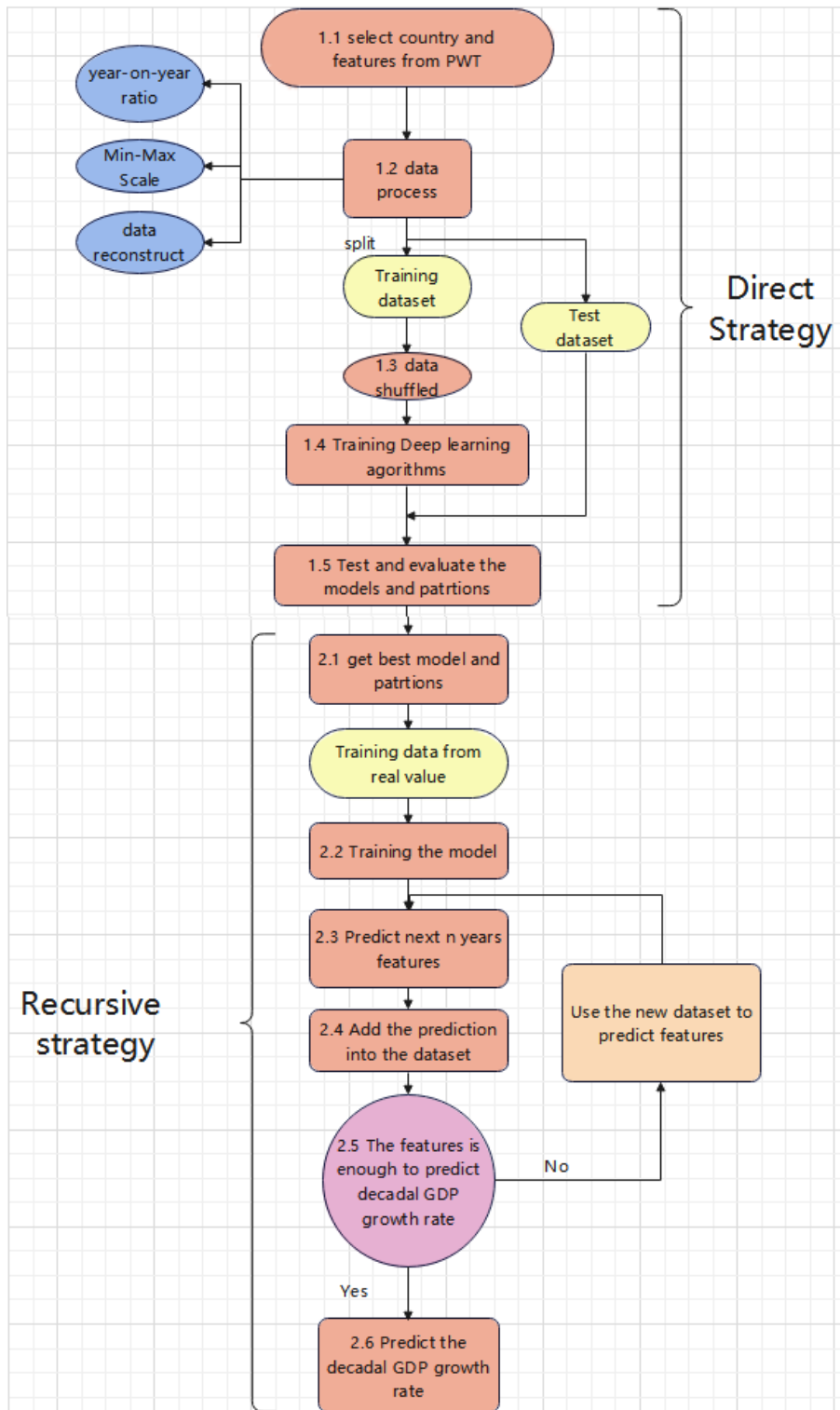

Figure 6: Deep learning-based framework to predict decadal GDP growth rate using the direct and the recursive strategy. The model only predicts the GDP growth rate in direct strategy, and in the recursive strategy, the model first predicts the features (economic indicators) which are then used to predict the decadal GDP growth rate.



#### 4.2. Results: Shuffled Data

Shuffled data allows the model to avoid over-fitting compared to the original training set. In developed countries, the difference between the two data sets is only reflected in the RMSE of the training set, and there is not much difference in the test set, but in developing countries, the role of shuffled data is highlighted, which effectively avoids the model over-fitting. This contrast can be seen from Figure 7.

As we can see from above Figure 7, compared with China, the gap between raw data and shuffled data in Japan is relatively small. This may be due to the economic trend of developed countries being more stable than that of developing countries. So even if the model fits the first half of the training set better than the second half, the performance of the model on the test set is preserved. However, in developing countries, due to greater variability in their year on year economic performance, if the model is trained in the order of years, it is likely to over-fit the older period, greatly affecting its performance on the test set.

#### 4.3. Results: Developed Countries

Developed countries have a more stable economic environment due to their sound financial and social security systems. The inflation, employment rate and other major economic indicators do not vary substantially year on year. As for GDP, the economic structure of developed countries is generally stable and gradually changing, so GDP does not have large fluctuations. As the most important group of countries in the world economy, they rarely encounter economic difficulties, except for financial crises [31] and pandemics such as COVID-19 [56]. Due to globalization, financial crises in developed countries are cyclical and structural, and hence, predictable.

The results of all models for Australia are shown in Figure 8 where in Panel (a) we see that the the deep learning models produce lower RMSE than the traditional models on the training data, but this performance does not transfer to the test data. The traditional time series models, by comparison, provide more consistent performance across the two sets. The results of ED-LSTM model appear consistently superior to all other models, while the prediction capabilities of CNN and ARIMA are approximately equivalent, and BD-LSTM is only slightly behind the former two models. The LSTM model ranks fifth, and it has the largest variance, meaning that these models are the most unstable. Next, we observe the step-by-step RMSE of Figure 8 Panel (b), ED-LSTM performs consistently well, and CNN has exhibits stable performance. In the other two models, the LSTM is only slightly stronger than the BD-LSTM in the second step, while it lags significantly behind the others in other steps, resulting in the worst ranking among these deep learning models.

We present the results for Canada in Figure 9. The VAR model provides the best performance overall on the test

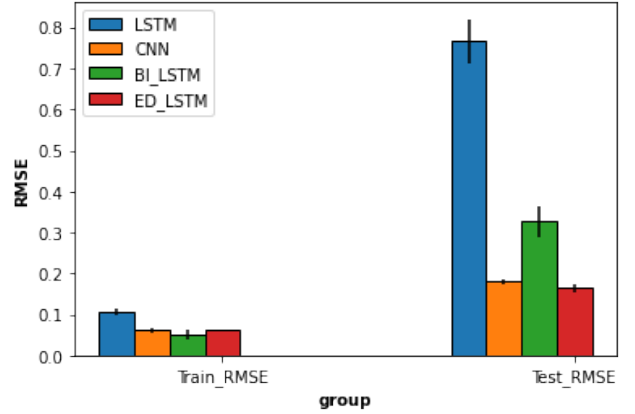

(a) Japan unshuffled train set.

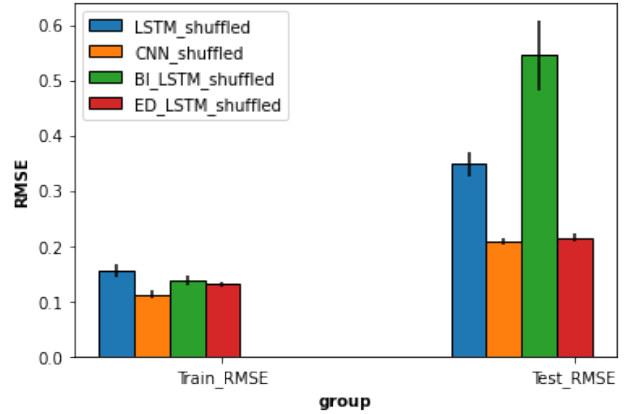

(b) Japan shuffled train set.

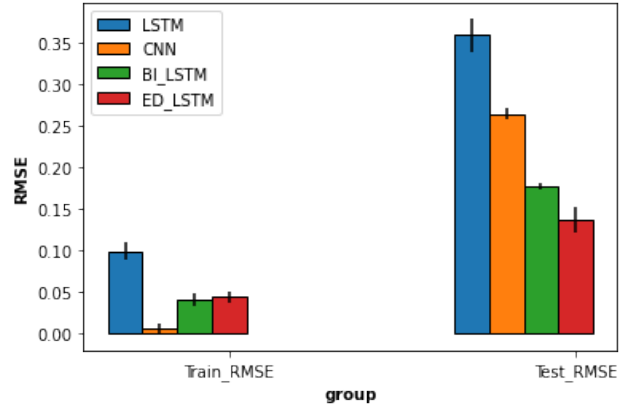

(c) China unshuffled train set.

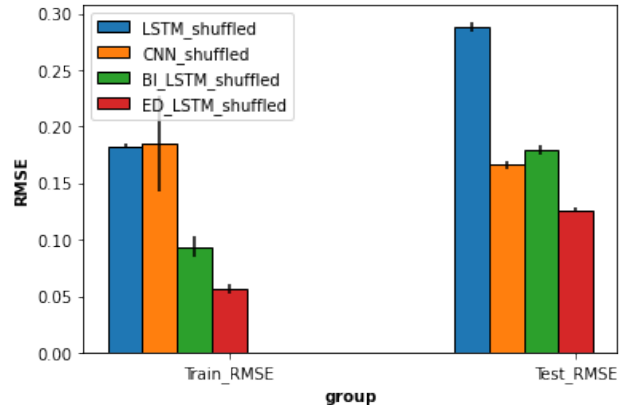

(d) China shuffled train set.

Figure 7: Results showing RMSE for China (developing) and Japan (developed) between shuffled and unshuffled train set.

Table 4: Australia reporting RMSE mean and 95 % confidence interval ( $\pm$ ).

|       | ARIMA  | VAR    | LSTM                | BD-LSTM             | ED-LSTM             | CNN                  |
|-------|--------|--------|---------------------|---------------------|---------------------|----------------------|
| Train | 0.1699 | 0.3088 | 0.1537 $\pm$ 0.0048 | 0.1393 $\pm$ 0.0056 | 0.0748 $\pm$ 0.0035 | 0.1207 $\pm$ 0.0.006 |
| Test  | 0.1919 | 0.3032 | 0.241 $\pm$ 0.0187  | 0.2022 $\pm$ 0.0019 | 0.1359 $\pm$ 0.0048 | 0.1901 $\pm$ 0.0049  |
| Step1 |        |        | 0.2721 $\pm$ 0.0065 | 0.1994 $\pm$ 0.0013 | 0.1251 $\pm$ 0.0026 | 0.2054 $\pm$ 0.0012  |
| Step2 |        |        | 0.2112 $\pm$ 0.0022 | 0.2247 $\pm$ 0.0028 | 0.1481 $\pm$ 0.0051 | 0.1755 $\pm$ 0.0016  |
| Step3 |        |        | 0.2355 $\pm$ 0.0036 | 0.1798 $\pm$ 0.0007 | 0.1321 $\pm$ 0.0023 | 0.188 $\pm$ 0.0017   |

Table 5: Canada reporting RMSE mean and 95 % confidence interval ( $\pm$ ).

|       | ARIMA  | VAR    | LSTM                | BD-LSTM             | ED-LSTM             | CNN                  |
|-------|--------|--------|---------------------|---------------------|---------------------|----------------------|
| Train | 0.1873 | 0.2260 | 0.1658 $\pm$ 0.0081 | 0.1553 $\pm$ 0.0057 | 0.1642 $\pm$ 0.0040 | 0.1671 $\pm$ 0.0.009 |
| Test  | 0.2630 | 0.1277 | 0.4422 $\pm$ 0.06   | 0.2624 $\pm$ 0.012  | 0.2345 $\pm$ 0.0037 | 0.2507 $\pm$ 0.0065  |
| Step1 |        |        | 0.4733 $\pm$ 0.0188 | 0.2884 $\pm$ 0.0024 | 0.2938 $\pm$ 0.0013 | 0.2937 $\pm$ 0.0027  |
| Step2 |        |        | 0.3562 $\pm$ 0.0188 | 0.2481 $\pm$ 0.0002 | 0.2319 $\pm$ 0.0018 | 0.2381 $\pm$ 0.0004  |
| Step3 |        |        | 0.4817 $\pm$ 0.0345 | 0.2485 $\pm$ 0.0049 | 0.1573 $\pm$ 0.0026 | 0.2133 $\pm$ 0.0011  |

set, exceeding its own training set results. The other four models have relatively similar results, with the ED-LSTM exhibiting slightly stronger performance. CNN ranks second among the deep learning models. The RMSE of simple LSTM is the worst of these models, and its variance is extremely large, indicating that the model is extremely volatile. Panel (b) in Figure 9 demonstrates that ED-LSTM, BD-LSTM and CNN are approximately equivalent at the first step of prediction, but as the number of steps increases the ED-LSTM demonstrates improved performance. The simple LSTM is consistently the worst model in all steps. Comparing the ED-LSTM prediction curves with the VAR curves - Panel (c) and (d) in Figure 9, we see that the VAR model performs well on the test set, but does not appear to capture as much of the year on year variability as the ED-LSTM model.

Figure 10 presents the results for forecasting French GDP where we find that the traditional time series model (ARIMA) is worse than all the models, while the VAR model occupies the first position. Among the four deep learning models, CNN has lower mean RMSE but higher variance, making the ED-LSTM a more reliable choice. When we look at performance across the individual steps, we see that it is only in the third and final set of predictions that the performance of the models is heavily differentiated, where the RMSE of CNN and ED-LSTM is less than half of the other two models.

Figure 11 presents the prediction performance for Germany, Panel (a) shows that the CNN and ED-LSTM models outperform traditional time series models. We find that CNN ranks first, while ED-LSTM and VAR are at the second and the third positions, respectively. When we consider the RMSE at each step of the deep learning predictions, we find a similar outcome to the results for France. The four models only show a gap in the third step. The RMSE for all models other than LSTM at the third step is much lower than the values in the first two steps. The ED-LSTM and BD-LSTM are similar, but the

BD-LSTM appears more stable.

We present the results for Italy in Figure 12 where the CNN and ED-LSTM models provide the best performance on both training and test data. In addition they appear more stable than the other deep learning models. Figure 12 Panel (b) indicates that the ED-LSTM model has stable and strong performance across all the three steps.

we present the results for Japan in Figure 13 where CNN and ED-LSTM models provide superior prediction performance overall. The CNN model has slightly lower error on the test data and the other models have significantly higher error in both training and test data. Looking at Figure 13(b), we observe that as the number of steps increases the CNN and ED-LSTM models maintain consistent performance (their RMSE remains stable a approx 0.2) while the other deep learning models deteriorate.

We present the results for the United Kingdom (UK) in Figure 14 Panel (a) where aside from the LSTM, the deep learning models perform better than traditional time series models on the test data. The ED-LSTM appears to provide the best means performance; however, its variance upper bound exceeds the mean performance of the BD-LSTM model. In Figure 14 Panel (b), we observe that the prediction accuracy of LSTM is consistently poor, while the other three deep learning models maintain a similar trend, with a slight increase in the second step and a decline in the third step. In the third step, the prediction accuracy of BD-LSTM surpassed the top-ranked ED-LSTM in the previous two steps.

We present the results for United States in Figure 15 where Panel (a) indicates that the two traditional time series models rank at first and the last, VAR model has the best performance among these 6 models while ARIMA performs worst. Among the deep learning models, the CNN and ED-LSTM perform better than the BD-LSTM and LSTM, although BD-LSTM has the least variance. Through the 3 steps RMSE, although the four models perform similar in the first two steps, they are not in the same

Table 6: France reporting RMSE mean and 95 % confidence interval ( $\pm$ ).

|       | ARIMA  | VAR    | LSTM                | BD-LSTM             | ED-LSTM             | CNN                   |
|-------|--------|--------|---------------------|---------------------|---------------------|-----------------------|
| Train | 0.2034 | 0.2138 | 0.1144 $\pm$ 0.0087 | 0.0954 $\pm$ 0.0102 | 0.1035 $\pm$ 0.0055 | 0.0979 $\pm$ 0.0.0042 |
| Test  | 0.2723 | 0.1793 | 0.242 $\pm$ 0.0051  | 0.2477 $\pm$ 0.0098 | 0.1901 $\pm$ 0.0049 | 0.1738 $\pm$ 0.0124   |
| Step1 |        |        | 0.2433 $\pm$ 0.0062 | 0.1686 $\pm$ 0.0013 | 0.2055 $\pm$ 0.0022 | 0.1679 $\pm$ 0.0004   |
| Step2 |        |        | 0.2325 $\pm$ 0.0032 | 0.2824 $\pm$ 0.0015 | 0.2224 $\pm$ 0.0052 | 0.2149 $\pm$ 0.0017   |
| Step3 |        |        | 0.2483 $\pm$ 0.0098 | 0.2748 $\pm$ 0.0067 | 0.1273 $\pm$ 0.0010 | 0.1442 $\pm$ 0.0012   |

Table 7: Germany reporting RMSE mean and 95 % confidence interval ( $\pm$ ).

|       | ARIMA  | VAR    | LSTM                | BD-LSTM             | ED-LSTM             | CNN                  |
|-------|--------|--------|---------------------|---------------------|---------------------|----------------------|
| Train | 0.0847 | 0.1620 | 0.1843 $\pm$ 0.0056 | 0.1277 $\pm$ 0.0047 | 0.1281 $\pm$ 0.0032 | 0.1607 $\pm$ 0.0.032 |
| Test  | 0.2987 | 0.2644 | 0.3215 $\pm$ 0.016  | 0.2719 $\pm$ 0.0048 | 0.2495 $\pm$ 0.0042 | 0.2342 $\pm$ 0.0050  |
| Step1 |        |        | 0.2825 $\pm$ 0.0018 | 0.2771 $\pm$ 0.003  | 0.2437 $\pm$ 0.0008 | 0.2709 $\pm$ 0.0018  |
| Step2 |        |        | 0.3344 $\pm$ 0.0112 | 0.3306 $\pm$ 0.0017 | 0.2941 $\pm$ 0.003  | 0.2741 $\pm$ 0.0036  |
| Step3 |        |        | 0.3413 $\pm$ 0.0187 | 0.1891 $\pm$ 0.0027 | 0.1983 $\pm$ 0.015  | 0.1266 $\pm$ 0.001   |

Table 8: Italy reporting RMSE mean and 95 % confidence interval ( $\pm$ ).

|       | ARIMA  | VAR    | LSTM                | BD-LSTM             | ED-LSTM             | CNN                  |
|-------|--------|--------|---------------------|---------------------|---------------------|----------------------|
| Train | 0.2069 | 0.3095 | 0.1506 $\pm$ 0.0055 | 0.1245 $\pm$ 0.0081 | 0.1098 $\pm$ 0.0037 | 0.1191 $\pm$ 0.0.045 |
| Test  | 0.2544 | 0.5767 | 0.2656 $\pm$ 0.0223 | 0.2531 $\pm$ 0.0080 | 0.1956 $\pm$ 0.0017 | 0.2348 $\pm$ 0.0025  |
| Step1 |        |        | 0.2863 $\pm$ 0.0023 | 0.2538 $\pm$ 0.0006 | 0.1938 $\pm$ 0.0023 | 0.1988 $\pm$ 0.0006  |
| Step2 |        |        | 0.2705 $\pm$ 0.0054 | 0.291 $\pm$ 0.002   | 0.2001 $\pm$ 0.031  | 0.21 $\pm$ 0.0107    |
| Step3 |        |        | 0.2371 $\pm$ 0.0023 | 0.1988 $\pm$ 0.0024 | 0.1919 $\pm$ 0.0052 | 0.2856 $\pm$ 0.033   |

Table 9: Japan reporting RMSE mean and 95 % confidence interval ( $\pm$ ).

|       | ARIMA  | VAR    | LSTM                | BD-LSTM             | ED-LSTM             | CNN                   |
|-------|--------|--------|---------------------|---------------------|---------------------|-----------------------|
| Train | 0.2554 | 0.1466 | 0.1561 $\pm$ 0.0066 | 0.1375 $\pm$ 0.0075 | 0.1312 $\pm$ 0.0031 | 0.1125 $\pm$ 0.0.0021 |
| Test  | 0.3014 | 0.3626 | 0.3483 $\pm$ 0.0253 | 0.5448 $\pm$ 0.0087 | 0.2151 $\pm$ 0.0009 | 0.2086 $\pm$ 0.0022   |
| Step1 |        |        | 0.2516 $\pm$ 0.0009 | 0.2592 $\pm$ 0.0022 | 0.2308 $\pm$ 0.0019 | 0.1778 $\pm$ 0.0006   |
| Step2 |        |        | 0.354 $\pm$ 0.0017  | 0.3966 $\pm$ 0.0122 | 0.2221 $\pm$ 0.021  | 0.2374 $\pm$ 0.0018   |
| Step3 |        |        | 0.4143 $\pm$ 0.0272 | 0.8145 $\pm$ 0.0382 | 0.1899 $\pm$ 0.0043 | 0.206 $\pm$ 0.006     |

Table 10: United Kingdom reporting RMSE mean and 95 % confidence interval ( $\pm$ ).

|       | ARIMA  | VAR    | LSTM                 | BD-LSTM             | ED-LSTM             | CNN                   |
|-------|--------|--------|----------------------|---------------------|---------------------|-----------------------|
| Train | 0.1821 | 0.1291 | 0.1767 $\pm$ 0.0081  | 0.1302 $\pm$ 0.0062 | 0.1132 $\pm$ 0.0036 | 0.1219 $\pm$ 0.0.0064 |
| Test  | 0.3035 | 0.2614 | 0.3714 $\pm$ 0.00843 | 0.199 $\pm$ 0.0028  | 0.1803 $\pm$ 0.0069 | 0.2143 $\pm$ 0.011    |
| Step1 |        |        | 0.3697 $\pm$ 0.009   | 0.2154 $\pm$ 0.0015 | 0.2046 $\pm$ 0.0018 | 0.2146 $\pm$ 0.0013   |
| Step2 |        |        | 0.3772 $\pm$ 0.0025  | 0.2397 $\pm$ 0.0013 | 0.1886 $\pm$ 0.015  | 0.2484 $\pm$ 0.041    |
| Step3 |        |        | 0.3652 $\pm$ 0.0162  | 0.122 $\pm$ 0.0033  | 0.1411 $\pm$ 0.0048 | 0.1731 $\pm$ 0.0037   |

Table 11: United States reporting RMSE mean and 95 % confidence interval ( $\pm$ ).

|       | ARIMA  | VAR    | LSTM                | BD-LSTM             | ED-LSTM             | CNN                   |
|-------|--------|--------|---------------------|---------------------|---------------------|-----------------------|
| Train | 0.3263 | 0.1544 | 0.1221 $\pm$ 0.0149 | 0.1359 $\pm$ 0.0106 | 0.109 $\pm$ 0.0034  | 0.1354 $\pm$ 0.0.0099 |
| Test  | 0.3435 | 0.0863 | 0.2875 $\pm$ 0.0159 | 0.2056 $\pm$ 0.0021 | 0.1615 $\pm$ 0.0075 | 0.1828 $\pm$ 0.0095   |
| Step1 |        |        | 0.1421 $\pm$ 0.004  | 0.1581 $\pm$ 0.0035 | 0.1835 $\pm$ 0.0014 | 0.2347 $\pm$ 0.0003   |
| Step2 |        |        | 0.1592 $\pm$ 0.0073 | 0.1768 $\pm$ 0.043  | 0.1349 $\pm$ 0.0026 | 0.1798 $\pm$ 0.0004   |
| Step3 |        |        | 0.4475 $\pm$ 0.0193 | 0.2646 $\pm$ 0.007  | 0.1608 $\pm$ 0.0088 | 0.1135 $\pm$ 0.0008   |

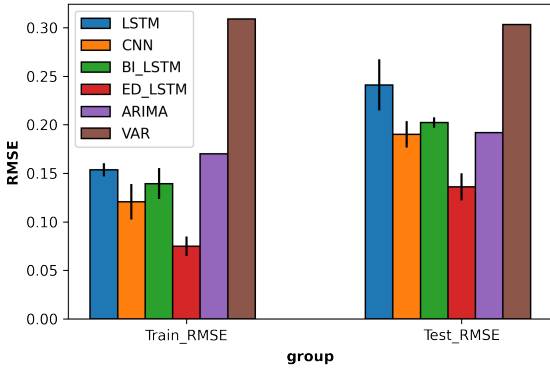

(a) RMSE across 3 step prediction horizon

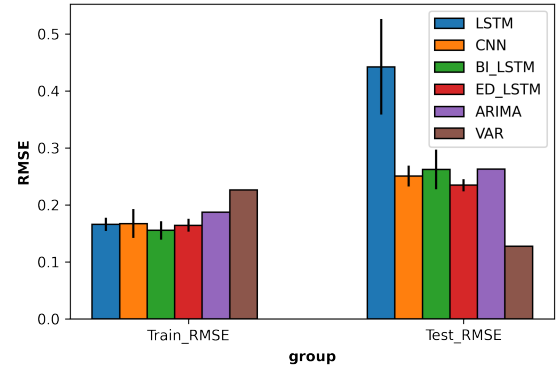

(a) RMSE across 3 step prediction horizon

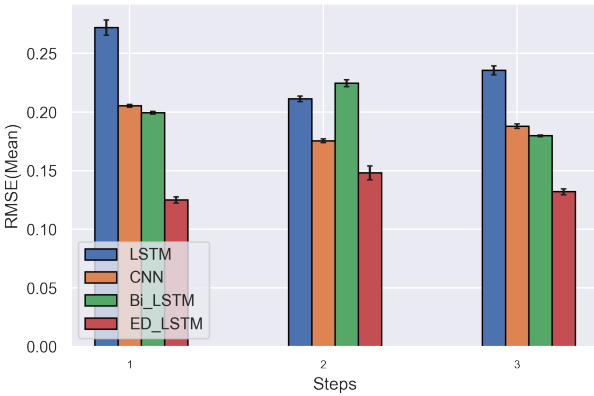

(b) 3 steps prediction

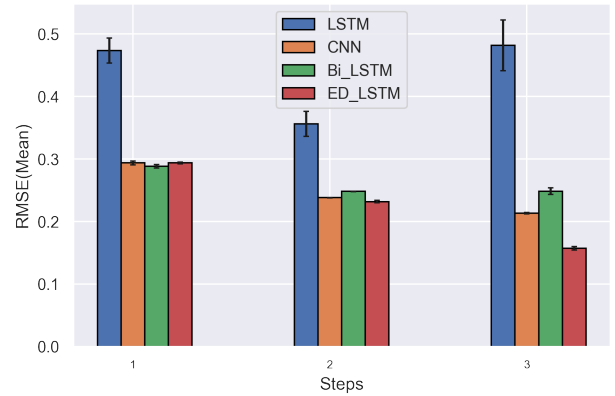

(b) 3 steps prediction

Figure 8: Australia time series: performance evaluation of respective methods (RMSE mean and 95% confidence interval as error bar)

trend, as the number of steps increases, the prediction accuracy of LSTM and BD-LSTM gradually degrades. The ED-LSTM's performance is consistently stable, while the CNN improves as the forecast horizon increases. We further compare Figure 15 - Panels (c) and (d) and find that such as the case of Canada, the performance of VAR on the test set is similar to that of the best deep learning model, and is more inclined to predict the general trend.

Figure 16 is a summary of the prediction results of developed countries. We observe that CNN and ED-LSTM are far better than other models. BD-LSTM and two traditional models have similar results, while LSTM's results are obviously worse than other models. Take each step separately to check, the deep learning models have very different trends in pairs, as the number of steps increases, CNN and ED-LSTM perform better and better, proving that CNN and ED-LSTM have the ability to achieve long-term prediction, while LSTM and BD-LSTM are completely opposite, and the increase in the number of steps directly leads to an increase in RMSE, indicating that their predictive ability for multi-step prediction is relatively weak.

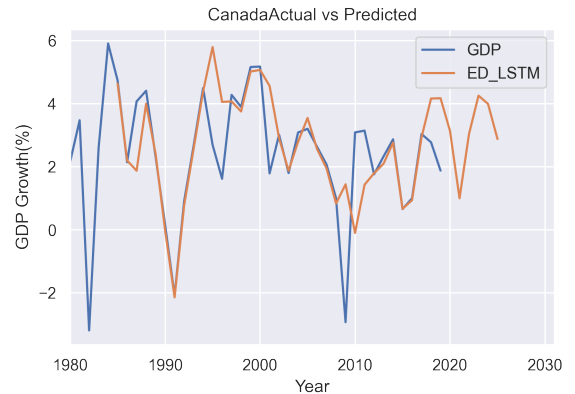

(c) Best ED-LSTM

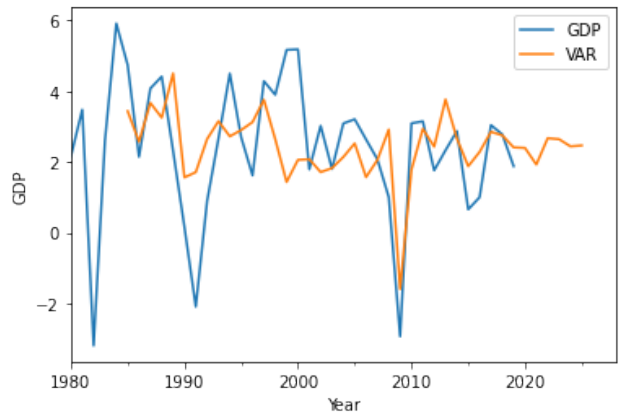

(d) VAR

12 Figure 9: Canada time series: performance evaluation of respective methods (RMSE mean and 95% confidence interval as error bar).

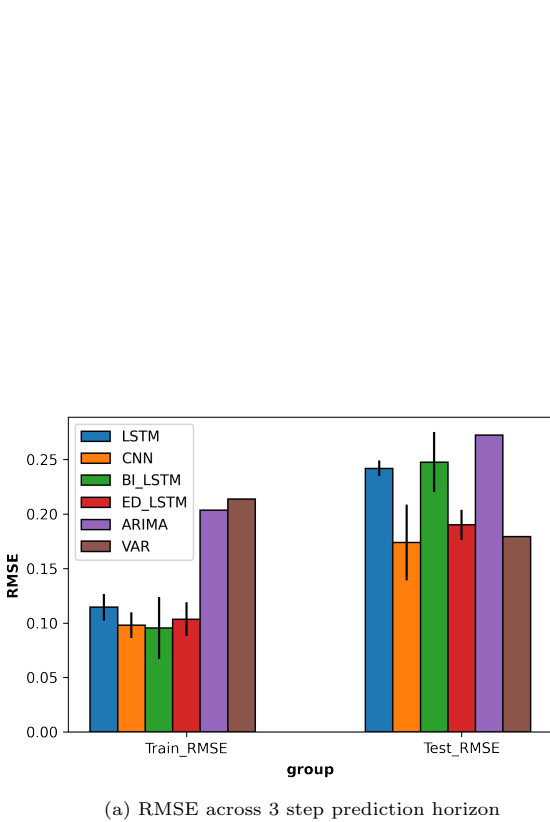
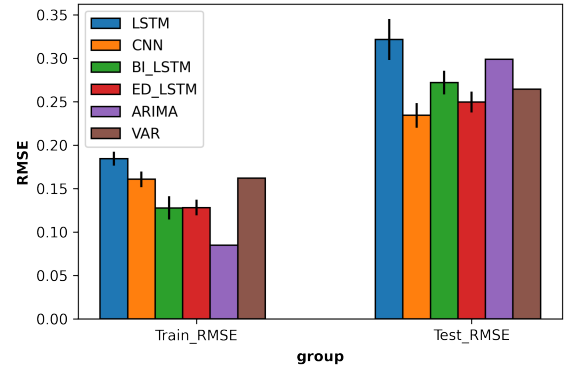
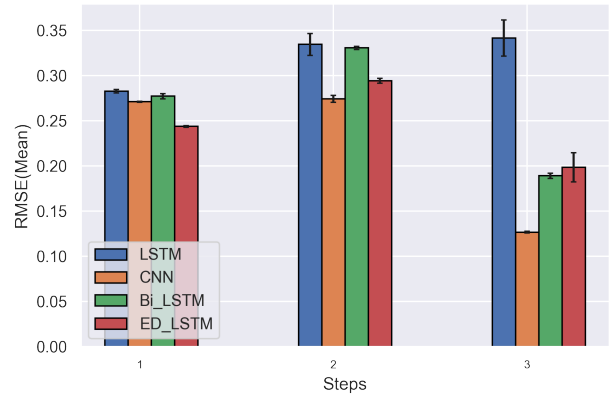

Figure 10: France time series: performance evaluation of respective methods (RMSE mean and 95% confidence interval as error bar)



(a) RMSE across 3 step prediction horizon



(b) 3 steps prediction

Figure 11: Germany time series: performance evaluation of respective methods (RMSE mean and 95% confidence interval as error bar).

#### 4.3.1. Results: Developing Countries

This section presents the forecast results for developing countries. These countries are characterised by the fact that they have not yet established sound financial and social security systems and are still exploring the path of national development [53], resulting in irregularities in their economic cycles [13]. At times they have no stable trends, a high probability of abnormal rises or falls, and the transparency and credibility of their data are often questioned, making forecasting more difficult [39]. In addition, the lack of historical data for Russia due to the collapse of the Soviet Union in 1991 has undoubtedly added to the difficulty of model fitting and forecasting.

We present the results for Brazil in Figure 17 where in Panel (a) we observe that only ED-LSTM is better than the traditional time series statistical models. LSTM remains the worst performing deep learning model. Examining the step-by-step predictions we see that the RMSE of ED-LSTM has a certain amount of increase in the second step, but it is still the best at each step.

We present the results for China in Figure 18 where we observe that except for LSTM, the other three deep learning models are significantly better than the traditional time series models. The RMSE of LSTM is only

Table 12: Brazil reporting RMSE mean and 95 % confidence interval ( $\pm$ ).

|       | ARIMA  | VAR    | LSTM                | BD-LSTM             | ED-LSTM             | CNN                  |
|-------|--------|--------|---------------------|---------------------|---------------------|----------------------|
| Train | 0.1507 | 0.2169 | 0.1689 $\pm$ 0.0064 | 0.1747 $\pm$ 0.0055 | 0.1169 $\pm$ 0.0061 | 0.1434 $\pm$ 0.0.004 |
| Test  | 0.3097 | 0.2549 | 0.3645 $\pm$ 0.082  | 0.3344 $\pm$ 0.0014 | 0.2203 $\pm$ 0.0011 | 0.3303 $\pm$ 0.0028  |
| Step1 |        |        | 0.2988 $\pm$ 0.005  | 0.3402 $\pm$ 0.005  | 0.1979 $\pm$ 0.005  | 0.2901 $\pm$ 0.002   |
| Step2 |        |        | 0.4137 $\pm$ 0.0106 | 0.3367 $\pm$ 0.004  | 0.2647 $\pm$ 0.004  | 0.412 $\pm$ 0.006    |
| Step3 |        |        | 0.371 $\pm$ 0.0142  | 0.3259 $\pm$ 0.006  | 0.1894 $\pm$ 0.006  | 0.2694 $\pm$ 0.0131  |

Table 13: China reporting RMSE mean and 95 % confidence interval ( $\pm$ ).

|       | ARIMA  | VAR    | LSTM                | BD-LSTM             | ED-LSTM             | CNN                  |
|-------|--------|--------|---------------------|---------------------|---------------------|----------------------|
| Train | 0.1808 | 0.2394 | 0.1825 $\pm$ 0.0066 | 0.0937 $\pm$ 0.0032 | 0.0567 $\pm$ 0.0018 | 0.1846 $\pm$ 0.0.004 |
| Test  | 0.2536 | 0.3656 | 0.2879 $\pm$ 0.0024 | 0.1792 $\pm$ 0.0045 | 0.1262 $\pm$ 0.0073 | 0.1662 $\pm$ 0.0028  |
| Step1 |        |        | 0.3783 $\pm$ 0.038  | 0.1701 $\pm$ 0.0023 | 0.1123 $\pm$ 0.006  | 0.118 $\pm$ 0.0032   |
| Step2 |        |        | 0.2977 $\pm$ 0.0045 | 0.2146 $\pm$ 0.0006 | 0.1198 $\pm$ 0.0024 | 0.1177 $\pm$ 0.0028  |
| Step3 |        |        | 0.1294 $\pm$ 0.0003 | 0.146 $\pm$ 0.0017  | 0.1442 $\pm$ 0.0012 | 0.2343 $\pm$ 0.0054  |

slightly larger than that of ARIMA, and its prediction results are also much better than VAR’s predictions. Among the top three deep learning models, ED-LSTM ranks first, but the stability is worse than the other two, CNN and BD-LSTM are ranked second and third. In Figure 18 Panel (b), only the ED-LSTM remained stable in each step. The CNN performed on par with the ED-LSTM in the first two steps, but the prediction results in the third step were worse than all other models.

We present the results for India in Figure 19 where we observe that the mean RMSE of all the deep learning models are in similar range, outperforming the ARIMA but worse than the VAR. In Panel (b), BD-LSTM and ED-LSTM do not fluctuate much at each step, while LSTM and CNNs prediction accuracy gradually deteriorates as the number of steps increases. Comparing the prediction curves of CNN and VAR, plots (C) and (d), we can see that although the mean RMSE of VAR is superior, the deep learning model appears to have better captured the structure of the trend.

We present the results for Russia in Figure 20 where the CNN and ED-LSTM models outperform all others with the ED-LSTM exhibiting a slight advantage. In Figure 14 Panel (b), we observe that the prediction accuracy of LSTM and BD-LSTM declines with the increase of the number of steps, while ED-LSTM remains stable. Although the RMSE of the CNN in the first and third steps is slightly smaller than that of ED-LSTM, in the second step, its error is much higher making it an unstable choice.

We further present the results for South Africa in Figure 21. We see similar trend when compared to the results for India, where VAR is the best performing model in terms of RMSE, out-performing all the deep learning models. The ARIMA model, by contrast, ranks last and in case of the deep learning models, we find that CNN and ED-LSTM maintained consistently good performance, ranking first and second for deep learning models. Figure 21 Panel (b) shows that it is the third prediction step in which the CNN

and ED-LSTM models exhibit superior performance. The comparison of the prediction curves of VAR and CNN is also very similar to that shown in India, the best CNN model captures the time series trend better than the VAR model.

As in the previous section, Figure 22 shows that CNN and ED-LSTM provide better overall performance than traditional time series models. Looking at the individual prediction time steps, ED-LSTM and CNN significantly outperform the other two models at every step, and the former is the first rank in every step. It is worth noting that for India and South Africa, the VAR performance was best according to the average RMSE, but from the prediction curves, the VAR performance was not as good as the optimal deep learning models.

#### 4.4. Recursive deep learning framework: results

According to the results of the evaluation, whether in developed or developing countries, or in the overall average ranking Table 18, ED-LSTM ranks first, so we use ED-LSTM to predict next decade’s GDP growth rate. We use the Penn-World data and extend it recursively to forecast. We start the recursive strategy by forecasting features in the data-set until the features are long enough for us to forecast the GDP growth rate for the next decade. We selected the predicted RMSE for a number of countries features in the recursive process to demonstrate the reliability of the predictions .

As can be seen from the Table 17, the prediction results for the features perform well and the RMSE of the test set is equivalent to the training set. Although we used GDP growth rate as the target in Direct Strategy to train and select the optimal model, the good results in Table 17 tell us that the ED-LSTM still performs well even if the target is replaced with other features in the data set, which also indicates that we can use Recursive Strategy, i.e., we can predict the features first and then the GDP growth rate. This demonstrates the feasibility of our recursive strategy.

Table 14: India reporting RMSE mean and 95 % confidence interval ( $\pm$ ).

|       | ARIMA  | VAR    | LSTM                 | BD-LSTM             | ED-LSTM             | CNN                   |
|-------|--------|--------|----------------------|---------------------|---------------------|-----------------------|
| Train | 0.0982 | 0.2032 | 0.1842 $\pm$ 0.0124  | 0.1465 $\pm$ 0.006  | 0.1197 $\pm$ 0.0041 | 0.1823 $\pm$ 0.0.0033 |
| Test  | 0.3008 | 0.2019 | 0.2604 $\pm$ 0.02164 | 0.2394 $\pm$ 0.0072 | 0.2398 $\pm$ 0.0081 | 0.2366 $\pm$ 0.0013   |
| Step1 |        |        | 0.1587 $\pm$ 0.019   | 0.2475 $\pm$ 0.0017 | 0.2206 $\pm$ 0.0033 | 0.1923 $\pm$ 0.007    |
| Step2 |        |        | 0.1961 $\pm$ 0.0023  | 0.2784 $\pm$ 0.003  | 0.2745 $\pm$ 0.0047 | 0.209 $\pm$ 0.0128    |
| Step3 |        |        | 0.369 $\pm$ 0.027    | 0.1821 $\pm$ 0.0005 | 0.2197 $\pm$ 0.0015 | 0.2927 $\pm$ 0.0063   |

Table 15: Russia reporting RMSE mean and 95 % confidence interval ( $\pm$ ).

|       | ARIMA  | VAR    | LSTM                | BD-LSTM             | ED-LSTM             | CNN                   |
|-------|--------|--------|---------------------|---------------------|---------------------|-----------------------|
| Train | 0.1348 | 0.3371 | 0.1599 $\pm$ 0.0072 | 0.1535 $\pm$ 0.0004 | 0.1437 $\pm$ 0.002  | 0.1704 $\pm$ 0.0.0049 |
| Test  | 0.3029 | 0.3227 | 0.2892 $\pm$ 0.0095 | 0.3211 $\pm$ 0.0016 | 0.2265 $\pm$ 0.0055 | 0.2453 $\pm$ 0.0031   |
| Step1 |        |        | 0.2543 $\pm$ 0.0023 | 0.2896 $\pm$ 0.002  | 0.2218 $\pm$ 0.0038 | 0.211 $\pm$ 0.0036    |
| Step2 |        |        | 0.2945 $\pm$ 0.0036 | 0.3269 $\pm$ 0.079  | 0.2293 $\pm$ 0.0032 | 0.3009 $\pm$ 0.0053   |
| Step3 |        |        | 0.315 $\pm$ 0.0095  | 0.3436 $\pm$ 0.0118 | 0.2274 $\pm$ 0.0073 | 0.2115 $\pm$ 0.0105   |

Table 16: South Africa reporting RMSE mean and 95 % confidence interval ( $\pm$ ).

|       | ARIMA  | VAR    | LSTM                | BD-LSTM             | ED-LSTM             | CNN                   |
|-------|--------|--------|---------------------|---------------------|---------------------|-----------------------|
| Train | 0.1487 | 0.2093 | 0.1725 $\pm$ 0.0068 | 0.0895 $\pm$ 0.0053 | 0.1018 $\pm$ 0.0041 | 0.1512 $\pm$ 0.0.0022 |
| Test  | 0.2569 | 0.1456 | 0.2031 $\pm$ 0.0173 | 0.2317 $\pm$ 0.0211 | 0.1901 $\pm$ 0.002  | 0.1831 $\pm$ 0.0023   |
| Step1 |        |        | 0.1638 $\pm$ 0.0037 | 0.209 $\pm$ 0.0023  | 0.1876 $\pm$ 0.0015 | 0.2324 $\pm$ 0.021    |
| Step2 |        |        | 0.2046 $\pm$ 0.0027 | 0.2195 $\pm$ 0.003  | 0.2179 $\pm$ 0.0029 | 0.1932 $\pm$ 0.0014   |
| Step3 |        |        | 0.2335 $\pm$ 0.07   | 0.263 $\pm$ 0.005   | 0.1595 $\pm$ 0.0052 | 0.0952 $\pm$ 0.0045   |

Table 17: RMSE for feature prediction in recursive strategy in some countries.(csh is the share in CGDPo, c represents household consumption, i is gross capital formation and g is government consumption)

| Country   | Feature               | train-RMSE | test-RMSE |
|-----------|-----------------------|------------|-----------|
| Australia | net population growth | 0.0432     | 0.0769    |
|           | CPI                   | 0.0528     | 0.1128    |
|           | employment rate       | 0.1595     | 0.1759    |
| Brazil    | csh-c                 | 0.1765     | 0.1254    |
|           | csh-i                 | 0.2128     | 0.1728    |
|           | csh-g                 | 0.1784     | 0.1292    |

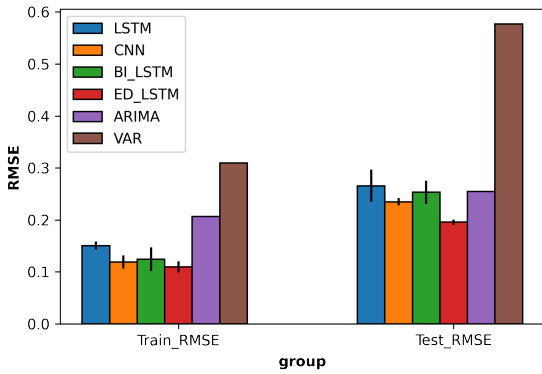

(a) RMSE across 3 step prediction horizon

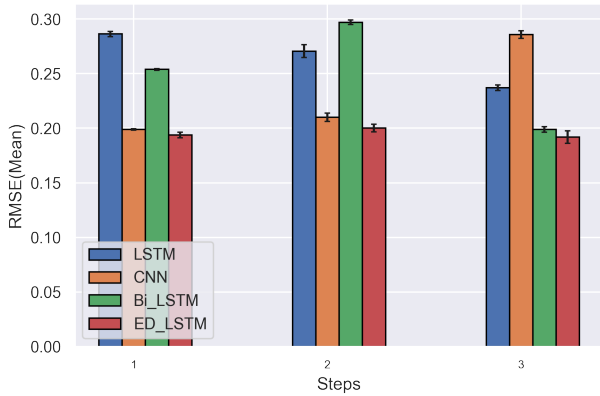

(b) 3 steps prediction

Figure 12: Italy time series: performance evaluation of respective methods (RMSE mean and 95% confidence interval as error bar)

Figures 23 24 25 26 27 28 29 30 31 32 33 34 35 represent the real value from 1980 to 2019 and the prediction from 2020 to 2031, the predictions include the mean of the forecast over 30 experiment runs and the 95% confidence interval of the results which are shown in the blue line with red shade. We see that the 95% Confidence Interval in each plots are narrow, demonstrating that the results of these 30 experiments did exhibit large variation.

#### 4.5. Comparison with institutional forecasts

In this section, the results predicted in the previous section are compared with those of a number of other studies. We first use the lowy institution data and compare the result with our results from the previous section, We compare our forecast of total GDP with a forecast based on the Lowy data in the Asian countries and the United States in Table19 [72].

We can see that aside from China and India, our forecasts are similar to the Lowy Institute forecast [72]. The Lowy Institute forecast for China's GDP is lower than our expectations, while India's is the opposite. We recognise that changing circumstances in China mean that it is unlikely that it will continue to grow at the same rate. While India may benefit from a more stable birthrate and a shift

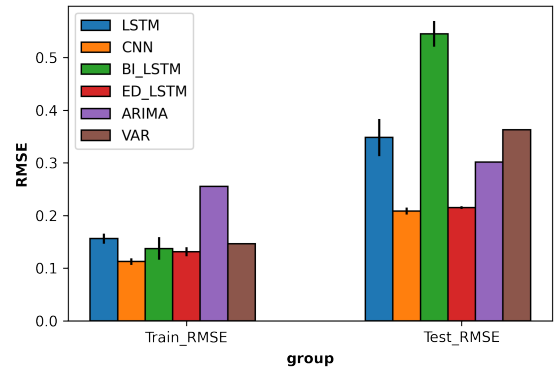

(a) RMSE across 3 step prediction horizon

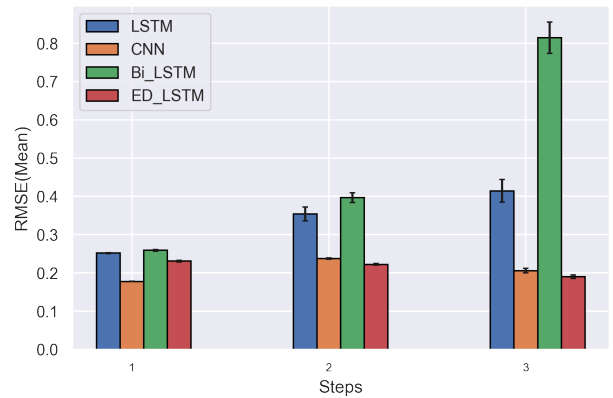

(b) 3 steps prediction

Figure 13: Japan time series: performance evaluation of respective methods (RMSE mean and 95% confidence interval as error bar)



Table 18: Ranking of different models for respective data-sets (country) according to the RMSE.

| Country        | ARIMA | VAR  | LSTM | BD-LSTM | ED-LSTM | CNN |
|----------------|-------|------|------|---------|---------|-----|
| Australia      | 3     | 6    | 5    | 4       | 1       | 2   |
| Brazil         | 3     | 2    | 6    | 5       | 1       | 4   |
| Canada         | 5     | 1    | 6    | 4       | 2       | 3   |
| China          | 4     | 6    | 5    | 3       | 1       | 2   |
| France         | 6     | 2    | 4    | 5       | 3       | 1   |
| Germany        | 5     | 3    | 6    | 4       | 2       | 1   |
| India          | 6     | 1    | 5    | 3       | 4       | 2   |
| Italy          | 3     | 6    | 5    | 4       | 1       | 2   |
| Japan          | 3     | 5    | 4    | 6       | 2       | 1   |
| Russia         | 4     | 6    | 3    | 5       | 1       | 2   |
| South Africa   | 6     | 1    | 5    | 4       | 3       | 2   |
| United Kingdom | 5     | 4    | 6    | 2       | 1       | 3   |
| United States  | 6     | 1    | 5    | 4       | 2       | 3   |
| Avg-Rank       | 4.53  | 3.38 | 5    | 4.07    | 1.84    | 2   |

Table 19: The forecast result and the Lowy forecast of 2030 (2017 constant ppp).

| Country       | Forecast | Lowy   | Diff   |
|---------------|----------|--------|--------|
| Australia     | 1.875    | 1.819  | -0.56  |
| China         | 30.934   | 24.28  | -6.7   |
| India         | 4.884    | 5.812  | 0.93   |
| Japan         | 5.514    | 5.327  | -0.193 |
| Russia        | 1.524    | 1.724  | 0.2    |
| United States | 24.889   | 24.226 | -0.663 |

of Chinese industry. These changing geopolitical circumstances are issues that we need to consider in our future work.

## 5. Discussion

In our experiments, we first evaluated model using the direct strategy. We selected the data of 13 countries in Penn World Table from 1980 to 2019. These countries belong to the developed country group G7 and the developing country group BRICS respectively. In the comparison results, whether it is for developed countries or developing countries, ED-LSTM provided the overall best results. The CNN and VAR models also provided the best performance overall (Table 18). The ARIMA consistently lagged behind the performance of the VAR, illustrating the importance of the exogenous variables in this task.

According to the results of model evaluation, we choose ED-LSTM in the recursive strategy as the final prediction model. In the results (Figure 23 24 25 26 27 28 29 30 31 32 33 34 35), we observe that the forecast results of most countries appear reasonable. In the forecast results of developed countries, except for the forecast results of France, other countries, Australia, Canada, Germany, Italy, Japan, the United Kingdom and the United States will experience economic growth slowdown or even regression in the first five years of the next decade, which is in line with our cognition of the law of economic crisis [107],

and gradually returning to normal or improving in the following five years. Among developing countries, our model suggests that Brazil, Russia and South Africa will be impacted by the economic crisis in the future, and their economic development will stagnate in the near term. However, China and India, the two fastest-growing developing countries will maintain a development speed higher than 4% (Figure 26 29 ). In recent reports, it has been forecasted that India will become a 10 trillion dollar GDP by 2035 [30] by Centre for Economics and Business Research. Morgan Stanley forecasted that Indian GDP will reach 11 trillion by 2032 [106]. Due to the impacts of COVID-19 and Russia-Ukraine war, the forecasts are being rapidly adjusted by the respective organisations including International Monetary Fund and the World Bank.

In our experiments, there are also some limitations since due to the time constraints of the data set, we did not include the relevant data after 2020. The data collected since the COVID-19 pandemic has not been included in the modeling process. The world in recent years has experienced significant turbulence due to COVID-19 and secondary reasons, such unpredictable contingencies and the attendant political policies which present challenges to modelling [91].

Another problem is that it is difficult for the ED-LSTM model to consider the changes in the development speed when the economic scale develops to a certain stage. We know that a country's economy cannot grow stably and

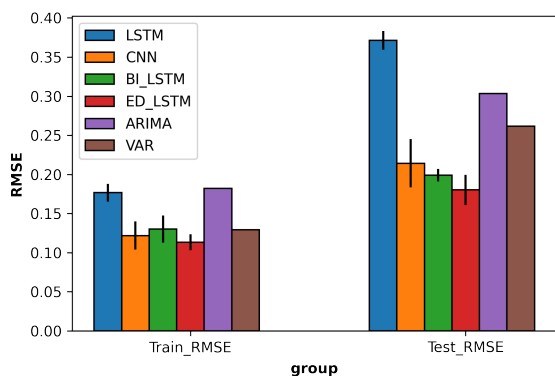

(a) RMSE across 3 step prediction horizon

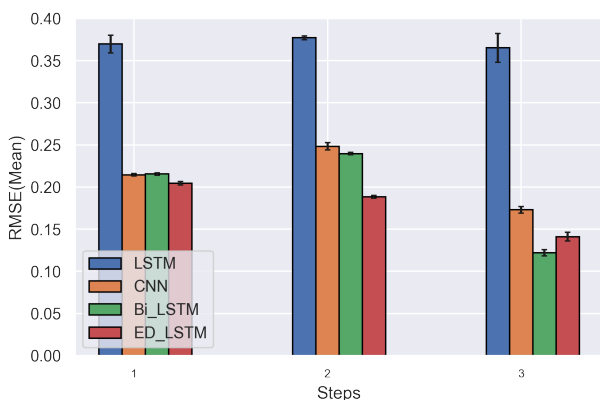

(b) 3 steps prediction

Figure 14: United Kingdom time series: performance evaluation of respective methods (RMSE mean and 95% confidence interval as error bar)

infinitely, it is always limited by its own national conditions, which is also the law of natural growth[81]. China is an example, since in the forecast, the total GDP of China reached an incredible value after steady growth. However, in reality, due to the huge economic volume, the GDP growth rate of China has slowed down in recent years due to housing crisis [59], trade disputes with USA [36], and COVID-19 [48]. The Chinese policy has also shifted from high-speed growth to high-quality growth [28].

Our future work will include multiple additional considerations. Firstly, we would incorporate robust uncertainty quantification in model construction. Hence, we need to introduce a Bayesian deep learning model[86, 19] to help us better predict some emerging extreme situations that will affect the economy, such as COVID-19, or the financial crisis. In addition, we need to further comprehensively consider the relationship between economic volume and economic growth rate[68, 15], which may need to take into account land area, total population, and differences between developing and developed countries to help us model better. The second point is that after the update of Penn World Data, the data after 2020 was introduced. The economy in these years has been affected by COVID-

19, so we need to re-evaluate the model, train the model and forecast. The third point is to use interactive maps to display data, making the data more readable and easy to understand. We can also compare the accuracy of the test set with the prediction results of some international institutions, such as IMF and World Bank, to confirm our relative accuracy.

## 6. Conclusion

We proposed a deep learning framework for predicting decadal GDP growth rate, which includes two strategies, direct strategy and recursive strategy. In the part of the direct strategy, our experiment selected 13 countries and nearly 40 years of data in the macroeconomic data set Penn World Table. We introduced data shuffled when processing the data, effectively avoiding the over fitting of the model. By comparing the performance of traditional time series models ARIMA, VAR and deep learning models CNN, LSTM, BD-LSTM and ED-LSTM, we found that ED-LSTM is the best performing model in this experiment. According to the comparison results, combined with the recursive strategy we proposed, the ED-LSTM model was used to predict the next decadal GDP growth rate of 13 countries.

Our results show that in the next ten years, most countries will experience GDP growth rate slowdown or even negative growth in the first five years, a global economic crisis has affected many countries, and the affected countries will return to normal in the second five years. Only China, France and India are predicted to stabilize their GDP growth rate over the next decade. Our future work is to introduce post-COVID-19 economic data and epidemic uncertainty into modeling to better simulate and predict economic outcomes in times of geopolitical uncertainty.

## Code and Data

Code and data <sup>2</sup>

## References

- [1] Abeyasinghe, T., 1998. Forecasting singapore’s quarterly gdp with monthly external trade. *International Journal of Forecasting* 14, 505–513.
- [2] Abonazel, M.R., Abd-Elftah, A.I., 2019. Forecasting egyptian gdp using arima models. *Reports on Economics and Finance* 5, 35–47.
- [3] Akkemik, K.A., 2007. The response of employment to gdp growth in turkey: an econometric estimation. *Applied Econometrics and International Development* 7.
- [4] Alzubaidi, L., Zhang, J., Humaidi, A.J., Al-Dujaili, A., Duan, Y., Al-Shamma, O., Santamaría, J., Fadhel, M.A., Al-Amidie, M., Farhan, L., 2021. Review of deep learning: Concepts, cnn architectures, challenges, applications, future directions. *Journal of big Data* 8, 1–74.

<sup>2</sup><https://github.com/sydney-machine-learning/deeplearning-decadalworlddeconomy>

- [5] Amiri, S., Von Rosen, D., Zwanzig, S., 2009. The svm approach for box-jenkins models. *REVSTAT-Statistical journal* 7, 23–36.
- [6] Athey, S., 2018. The impact of machine learning on economics, in: *The economics of artificial intelligence: An agenda*. University of Chicago Press, pp. 507–547.
- [7] Athey, S., Imbens, G.W., 2019. Machine learning methods that economists should know about. *Annual Review of Economics* 11, 685–725.
- [8] Basu, T., Barik, D., Arokiasamy, P., 2013. Demographic determinants of economic growth in brics and selected developed countries, in: *XXVII IUSSP international population conference (IUSSP 2013)*, pp. 26–31.
- [9] Bekaert, G., Harvey, C.R., Lundblad, C., Siegel, S., 2007. Global growth opportunities and market integration. *The Journal of Finance* 62, 1081–1137.
- [10] Bianchi, F., Ludvigson, S.C., Ma, S., 2022. Belief distortions and macroeconomic fluctuations. *American Economic Review* 112, 2269–2315.
- [11] Box, G.E., Jenkins, G.M., Reinsel, G.C., Ljung, G.M., 2015. *Time series analysis: forecasting and control*. John Wiley & Sons.
- [12] Bozdogan, H., 1987. Model selection and akaike’s information criterion (aic): The general theory and its analytical extensions. *Psychometrika* 52, 345–370.
- [13] Bussmann, M., Scheuthle, H., Schneider, G., 2006. Trade liberalization and political instability in developing countries, in: *Programming for Peace*. Springer, pp. 49–70.
- [14] Cadieu, C.F., Hong, H., Yamins, D.L., Pinto, N., Ardila, D., Solomon, E.A., Majaj, N.J., DiCarlo, J.J., 2014. Deep neural networks rival the representation of primate it cortex for core visual object recognition. *PLoS computational biology* 10, e1003963.
- [15] Çalışkan, H.K., 2015. Technological change and economic growth. *Procedia-Social and Behavioral Sciences* 195, 649–654.
- [16] Callen, T., 2012. Gross domestic product: An economy’s all. *International Monetary Fund: Washington, DC, USA*.
- [17] Casey, E., 2020. Do macroeconomic forecasters use macroeconomics to forecast? *International Journal of Forecasting* 36, 1439–1453.
- [18] Chandra, R., Goyal, S., Gupta, R., 2021. Evaluation of deep learning models for multi-step ahead time series prediction. *IEEE Access* 9, 83105–83123.
- [19] Chandra, R., Kapoor, A., 2020. Bayesian neural multi-source transfer learning. *Neurocomputing* 378, 54–64.
- [20] Chandra, R., Krishna, A., 2021. Covid-19 sentiment analysis via deep learning during the rise of novel cases. *PLoS One* 16, e0255615.
- [21] Chandra, R., Saini, R., 2021. Biden vs trump: Modeling us general elections using bert language model. *IEEE Access* 9, 128494–128505.
- [22] Chen, H.C., Widodo, A.M., Wisnujati, A., Rahaman, M., Lin, J.C.W., Chen, L., Weng, C.E., 2022. Alexnet convolutional neural network for disease detection and classification of tomato leaf. *Electronics* 11, 951.
- [23] Chen, J.F., Chen, W.L., Huang, C.P., Huang, S.H., Chen, A.P., 2016. Financial time-series data analysis using deep convolutional neural networks, in: *2016 7th International conference on cloud computing and big data (CCBD)*, IEEE. pp. 87–92.
- [24] Cho, K., Van Merriënboer, B., Gulcehre, C., Bahdanau, D., Bougares, F., Schwenk, H., Bengio, Y., 2014. Learning phrase representations using rnn encoder-decoder for statistical machine translation. *arXiv preprint arXiv:1406.1078*.
- [25] Choi, H.K., 2018. Stock price correlation coefficient prediction with arima-lstm hybrid model. *arXiv preprint arXiv:1808.01560*.
- [26] Clements, M.P., Hendry, D.F., 1996. Multi-step estimation for forecasting. *Oxford Bulletin of Economics and Statistics* 58, 657–684.
- [27] Deng, L., 2018. Artificial intelligence in the rising wave of deep learning: The historical path and future outlook [perspectives]. *IEEE Signal Processing Magazine* 35, 180–177.
- [28] Ding, C., Liu, C., Zheng, C., Li, F., 2022. Digital economy, technological innovation and high-quality economic development: Based on spatial effect and mediation effect. *Sustainability* 14, 216.
- [29] d’Albis, H., Boubtane, E., Coulibaly, D., 2018. Macroeconomic evidence suggests that asylum seekers are not a “burden” for western european countries. *Science advances* 4, eaaq0883.
- [30] for Economics, C., Research, B., . India to become 10-trillion economy by 2035: Cebr. <https://economictimes.indiatimes.com/news/economy/policy/india-to-become-10-trillion-economy-by-2035-cebr/articleshow/96526283.cms>.
- [31] Edey, M., 2009. The global financial crisis and its effects. *Economic Papers: A journal of applied economics and policy* 28, 186–195.
- [32] Elman, J.L., 1990. Finding structure in time. *Cognitive Science* 14, 179–211. URL: <https://www.sciencedirect.com/science/article/pii/036402139090002E>, doi:[https://doi.org/10.1016/0364-0213\(90\)90002-E](https://doi.org/10.1016/0364-0213(90)90002-E).
- [33] Eraslan, G., Avsec, Ž., Gagneur, J., Theis, F.J., 2019. Deep learning: new computational modelling techniques for genomics. *Nature Reviews Genetics* 20, 389–403.
- [34] Evans, G.W., Honkapohja, S., 2012. Learning and expectations in macroeconomics, in: *Learning and Expectations in Macroeconomics*. Princeton University Press.
- [35] Ewing, R., Gruen, D., Hawkins, J., 2005. Forecasting the macro economy. *Economic Roundup*, 11–25 URL: [https://ideas.repec.org/a/tsy/journal/journal\\_tsy\\_er\\_2005\\_2\\_1.html](https://ideas.repec.org/a/tsy/journal/journal_tsy_er_2005_2_1.html).
- [36] Fajgelbaum, P.D., Khandelwal, A.K., 2022. The economic impacts of the us–china trade war. *Annual Review of Economics* 14, 205–228.
- [37] Feenstra, R.C., Inklaar, R., Timmer, M.P., 2015. The next generation of the penn world table. *American economic review* 105, 3150–82.
- [38] Feldkircher, M., Huber, F., Schreiner, J., Tirpák, M., Tóth, P., Wörz, J., 2015. Bridging the information gap: small-scale nowcasting models of gdp growth for selected cese countries. *Focus on European economic integration*, 56–75.
- [39] Feng, Y., 2001. Political freedom, political instability, and policy uncertainty: A study of political institutions and private investment in developing countries. *International Studies Quarterly* 45, 271–294.
- [40] Freeman, J.R., Williams, J.T., Lin, T.m., 1989. Vector autoregression and the study of politics. *American Journal of Political Science*, 842–877.
- [41] Garboden, P.M., 2020. Sources and types of big data for macroeconomic forecasting, in: *Macroeconomic Forecasting in the Era of Big Data*. Springer, pp. 3–23.
- [42] Garnitz, J., Lehmann, R., Wohlrabe, K., 2019. Forecasting gdp all over the world using leading indicators based on comprehensive survey data. *Applied Economics* 51, 5802–5816. URL: <https://doi.org/10.1080/00036846.2019.1624915>, doi:10.1080/00036846.2019.1624915, arXiv:<https://doi.org/10.1080/00036846.2019.1624915>.
- [43] Giannone, D., Reichlin, L., Small, D., 2008. Nowcasting: The real-time informational content of macroeconomic data. *Journal of monetary economics* 55, 665–676.
- [44] Gilliland, M., 2020. The value added by machine learning approaches in forecasting. *International Journal of Forecasting* 36, 161–166.
- [45] Goodfellow, I., Bengio, Y., Courville, A., 2016. *Deep learning*. MIT press.
- [46] Goulet Coulombe, P., Leroux, M., Stevanovic, D., Surprenant, S., 2022. How is machine learning useful for macroeconomic forecasting? *Journal of Applied Econometrics* 37, 920–964.
- [47] Graves, A., Fernández, S., Schmidhuber, J., 2005. Bidirectional lstm networks for improved phoneme classification and recognition, in: *International conference on artificial neural*

- networks, Springer. pp. 799–804.
- [48] Habibi, Z., Habibi, H., Mohammadi, M.A., 2022. The potential impact of covid-19 on the chinese gdp, trade, and economy. *Economies* 10, 73.
- [49] Hawkins, J., Bodén, M., 2005. The applicability of recurrent neural networks for biological sequence analysis. *IEEE/ACM Transactions on Computational Biology and Bioinformatics* 2, 243–253.
- [50] Hochreiter, S., Schmidhuber, J., 1997. Long short-term memory. *Neural computation* 9, 1735–1780.
- [51] Hox, J.J., Bechger, T.M., 1998. An introduction to structural equation modeling .
- [52] Hryhorkiv, V., Buiak, L., Verstiak, A., Hryhorkiv, M., Verstiak, O., Tokarieva, K., 2020. Forecasting financial time series using combined arima-ann algorithm, in: 2020 10th International Conference on Advanced Computer Information Technologies (ACIT), IEEE. pp. 455–458.
- [53] Hudson, J., Jones, P., 2003. International trade in ‘quality goods’: signalling problems for developing countries. *Journal of international Development* 15, 999–1013.
- [54] IMF, 2022. World economic outlook. International Monetary Fund .
- [55] Iorio, F.D., Triacca, U., 2022. A comparison between var processes jointly modeling gdp and unemployment rate in france and germany. *Statistical Methods & Applications* 31, 617–635.
- [56] Izzeldin, M., Muradoğlu, Y.G., Pappas, V., Sivaprasad, S., 2021. The impact of COVID-19 on G7 stock markets volatility: Evidence from a ST-HAR model. *International Review of Financial Analysis* 74, 101671.
- [57] Jansen, W.J., de Winter, J.M., 2018. Combining model-based near-term GDP forecasts and judgmental forecasts: A real-time exercise for the G7 countries. *Oxford Bulletin of Economics and Statistics* 80, 1213–1242.
- [58] Jelodar, H., Wang, Y., Orji, R., Huang, S., 2020. Deep sentiment classification and topic discovery on novel coronavirus or covid-19 online discussions: Nlp using lstm recurrent neural network approach. *IEEE Journal of Biomedical and Health Informatics* 24, 2733–2742.
- [59] Jiang, S., Miao, J., Zhang, Y., 2022. China’s housing bubble, infrastructure investment, and economic growth. *International Economic Review* 63, 1189–1237.
- [60] Jorgenson, D.W., Vu, K.M., 2013. The emergence of the new economic order: Growth in the G7 and the G20. *Journal of Policy Modeling* 35, 389–399.
- [61] Karevan, Z., Suykens, J.A., 2020. Transductive lstm for time-series prediction: An application to weather forecasting. *Neural Networks* 125, 1–9.
- [62] Kingma, D.P., Ba, J., 2014. Adam: A method for stochastic optimization. *arXiv preprint arXiv:1412.6980* .
- [63] Klein, L.R., 1971. essay on the theory of economic prediction.
- [64] Lau, K., Wu, Q., 2008. Local prediction of non-linear time series using support vector regression. *Pattern recognition* 41, 1539–1547.
- [65] LeCun, Y., Bengio, Y., Hinton, G., 2015. Deep learning. *nature* 521, 436–444.
- [66] LeCun, Y., Bengio, Y., et al., 1995. Convolutional networks for images, speech, and time series. *The handbook of brain theory and neural networks* 3361, 1995.
- [67] Lepenies, P., 2016. The power of a single number: a political history of GDP. Columbia University Press.
- [68] Lewis, W.A., 2013. Theory of economic growth. Routledge.
- [69] Li, J., Cheng, J.h., Shi, J.y., Huang, F., 2012. Brief introduction of back propagation (bp) neural network algorithm and its improvement, in: *Advances in computer science and information engineering*. Springer, pp. 553–558.
- [70] Livieris, I.E., Pintelas, E., Pintelas, P., 2020. A cnn-lstm model for gold price time-series forecasting. *Neural computing and applications* 32, 17351–17360.
- [71] Longo, L., Riccaboni, M., Rungi, A., 2022. A neural network ensemble approach for gdp forecasting. *Journal of Economic Dynamics and Control* 134, 104278.
- [72] Lowyinstitute, . Gdp forecast 2030. <https://power.lowyinstitute.org/data/future-resources/economic-size-2030/gdp-2030/>.
- [73] Lu, C.J., Lee, T.S., Chiu, C.C., 2009. Financial time series forecasting using independent component analysis and support vector regression. *Decision support systems* 47, 115–125.
- [74] Lyhagen, J., Ekberg, S., Eidestedt, R., 2015. Beating the var: Improving swedish gdp forecasts using error and intercept corrections. *Journal of Forecasting* 34, 354–363.
- [75] Maehashi, K., Shintani, M., 2020. Macroeconomic forecasting using factor models and machine learning: an application to japan. *Journal of the Japanese and International Economies* 58, 101104.
- [76] Majib, M.S., Rahman, M.M., Sazzad, T.S., Khan, N.I., Dey, S.K., 2021. Vgg-scnet: A vgg net-based deep learning framework for brain tumor detection on mri images. *IEEE Access* 9, 116942–116952.
- [77] Makridakis, S., Spiliotis, E., Assimakopoulos, V., 2018. Statistical and machine learning forecasting methods: Concerns and ways forward. *PLoS one* 13, e0194889.
- [78] Marcellino, M., Schumacher, C., 2010. Factor midas for nowcasting and forecasting with ragged-edge data: A model comparison for german gdp. *Oxford Bulletin of Economics and Statistics* 72, 518–550.
- [79] Marcellino, M., Stock, J.H., Watson, M.W., 2006. A comparison of direct and iterated multistep ar methods for forecasting macroeconomic time series. *Journal of econometrics* 135, 499–526.
- [80] Meyler, A., Kenny, G., Quinn, T., 1998. Forecasting irish inflation using arima models .
- [81] Modis, T., 2013. Long-term gdp forecasts and the prospects for growth. *Technological Forecasting and Social Change* 80, 1557–1562.
- [82] Montgomery, D.C., Peck, E.A., Vining, G.G., 2021. Introduction to linear regression analysis. John Wiley & Sons.
- [83] Mourougane, A., 2006. Forecasting monthly gdp for canada .
- [84] Müller, K.R., Smola, A.J., Rätsch, G., Schölkopf, B., Kohlmorgen, J., Vapnik, V., 1997. Predicting time series with support vector machines, in: *International conference on artificial neural networks*, Springer. pp. 999–1004.
- [85] Nayyar, D., 2016. Brics, developing countries and global governance. *Third World Quarterly* 37, 575–591.
- [86] Neal, R., 1992. Bayesian learning via stochastic dynamics. *Advances in neural information processing systems* 5.
- [87] Nicholson, W.B., Matteson, D.S., Bien, J., 2017. Structured regularization for large vector autoregressions with exogenous variables. *International Journal of Forecasting* 33, 627–651.
- [88] Ollivaud, P., Pionnier, P.A., Rusticelli, E., Schweltnus, C., Koh, S.H., 2016. Forecasting gdp during and after the great recession URL: <https://www.oecd-ilibrary.org/content/paper/5j1v2jj4mw40-en>, doi:<https://doi.org/https://doi.org/10.1787/5j1v2jj4mw40-en>.
- [89] O’neill, J., et al., 2001. Building better global economic brics .
- [90] Ouham, S., Hadi, Y., 2019. Multivariate workload prediction using vector autoregressive and stacked lstm models, in: *Proceedings of the New Challenges in Data Sciences: Acts of the Second Conference of the Moroccan Classification Society*, pp. 1–7.
- [91] Ozili, P.K., Arun, T., 2023. Spillover of covid-19: impact on the global economy, in: *Managing Inflation and Supply Chain Disruptions in the Global Economy*. IGI Global, pp. 41–61.
- [92] Park, S.H., Kim, B., Kang, C.M., Chung, C.C., Choi, J.W., 2018. Sequence-to-sequence prediction of vehicle trajectory via lstm encoder-decoder architecture, in: *2018 IEEE Intelligent Vehicles Symposium (IV)*, IEEE. pp. 1672–1678.
- [93] Patterson, J., Gibson, A., 2017. Deep learning: A practitioner’s approach. ” O’Reilly Media, Inc.”.
- [94] Petrova, S., Marinova, D., 2015. Using ‘soft’and ‘hard’social impact indicators to understand societal change caused by

mining: a western australia case study. Impact Assessment and Project Appraisal 33, 16–27.

[95] Piao, Y., Chen, A., Shang, Z., 2019. Housing price prediction based on cnn, in: 2019 9th international conference on information science and technology (ICIST), IEEE. pp. 491–495.

[96] Robertson, J.C., Tallman, E.W., 1999. Vector autoregressions: forecasting and reality. Economic Review-Federal Reserve Bank of Atlanta 84, 4.

[97] Sa'adah, S., Wibowo, M.S., 2020. Prediction of gross domestic product (gdp) in indonesia using deep learning algorithm, in: 2020 3rd International Seminar on Research of Information Technology and Intelligent Systems (ISRITI), IEEE. pp. 32–36.

[98] Said, A.B., Erradi, A., Aly, H.A., Mohamed, A., 2021. Predicting covid-19 cases using bidirectional lstm on multivariate time series. Environmental Science and Pollution Research 28, 56043–56052.

[99] Salisu, A.A., Gupta, R., Olaniran, A., 2021. The effect of oil uncertainty shock on real gdp of 33 countries: a global var approach. Applied Economics Letters , 1–6.

[100] Sapankevych, N.I., Sankar, R., 2009. Time series prediction using support vector machines: a survey. IEEE computational intelligence magazine 4, 24–38.

[101] Selvin, S., Vinayakumar, R., Gopalakrishnan, E., Menon, V.K., Soman, K., 2017. Stock price prediction using lstm, rnn and cnn-sliding window model, in: 2017 international conference on advances in computing, communications and informatics (icacci), IEEE. pp. 1643–1647.

[102] Siami-Namini, S., Tavakoli, N., Namin, A.S., 2019. The performance of lstm and bilstm in forecasting time series, in: 2019 IEEE International Conference on Big Data (Big Data), IEEE. pp. 3285–3292.

[103] Sims, C.A., 1980. Macroeconomics and reality. Econometrica: journal of the Econometric Society , 1–48.

[104] Smalter Hall, A., Cook, T.R., 2017. Macroeconomic indicator forecasting with deep neural networks. Federal Reserve Bank of Kansas City Working Paper .

[105] Sokolov-Mladenović, S., Milovančević, M., Mladenović, I., Alizmir, M., 2016. Economic growth forecasting by artificial neural network with extreme learning machine based on trade, import and export parameters. Computers in Human Behavior 65, 43–45.

[106] Stanley, M., . India to be 3rd largest economy by 2027. <https://www.fortuneindia.com/macro/india-to-be-3rd-largest-economy-by-2027-morgan-stanley/110332#:~:text=As%20India's%20economy%20grows%20manifold,by%202032%2C%20the%20economist%20said.>

[107] Stiglitz, J.E., 2009. The current economic crisis and lessons for economic theory. Eastern Economic Journal 35, 281–296.

[108] Sun, S., Luo, C., Chen, J., 2017. A review of natural language processing techniques for opinion mining systems. Information fusion 36, 10–25.

[109] Sutskever, I., Vinyals, O., Le, Q.V., 2014. Sequence to sequence learning with neural networks. Advances in neural information processing systems 27.

[110] Tseng, F.M., Yu, H.C., Tzeng, G.H., 2002. Combining neural network model with seasonal time series arima model. Technological forecasting and social change 69, 71–87.

[111] Vreeland, J.R., 2003. The IMF and economic development. Cambridge University Press.

[112] Vu, K.M., 2020. Sources of growth in the world economy: a comparison of G7 and E7 economies, in: Measuring economic growth and productivity. Elsevier, pp. 55–74.

[113] Yoon, J., 2021. Forecasting of real GDP growth using machine learning models: Gradient boosting and random forest approach. Computational Economics 57, 247–265.

[114] Zhang, J., Wen, J., Yang, Z., 2022. China's gdp forecasting using long short term memory recurrent neural network and hidden markov model. PloS one 17, e0269529.

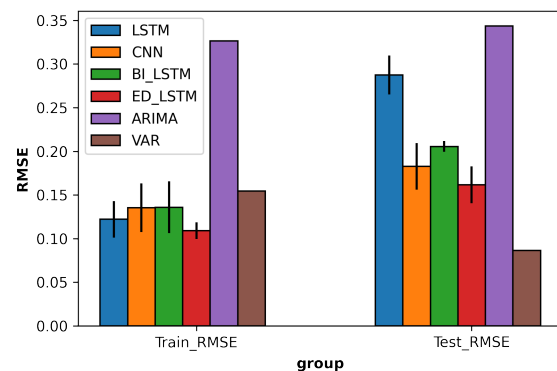

(a) RMSE across 3 step prediction horizon

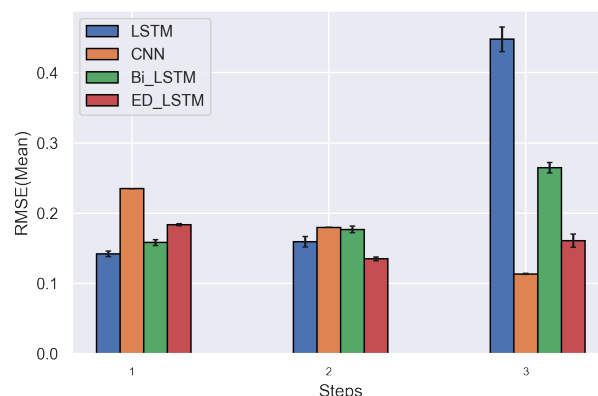

(b) 3 steps prediction

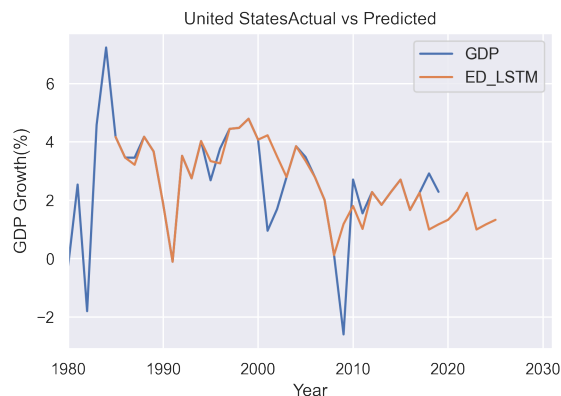

(c) Best ED-LSTM

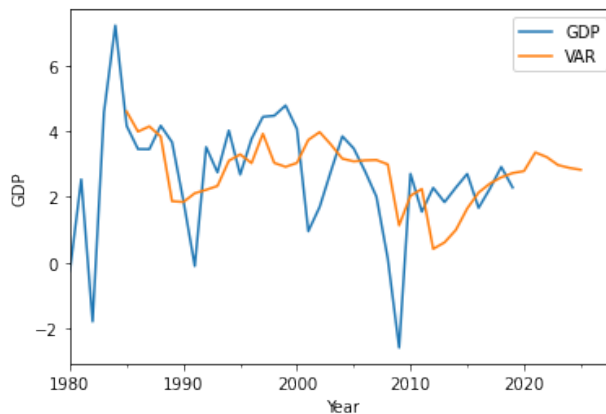

(d) VAR

21 Figure 15: United States time series: performance evaluation of respective methods (RMSE mean and 95% confidence interval as error bar)

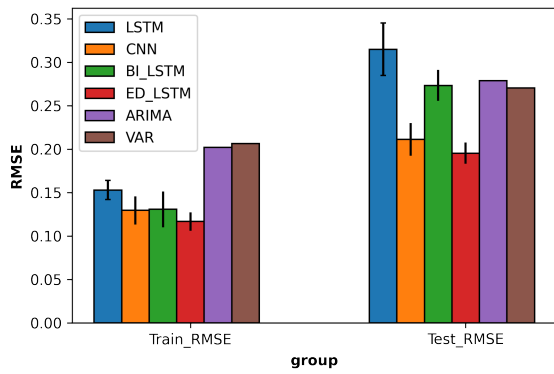

(a) Mean RMSE of whole developed countries

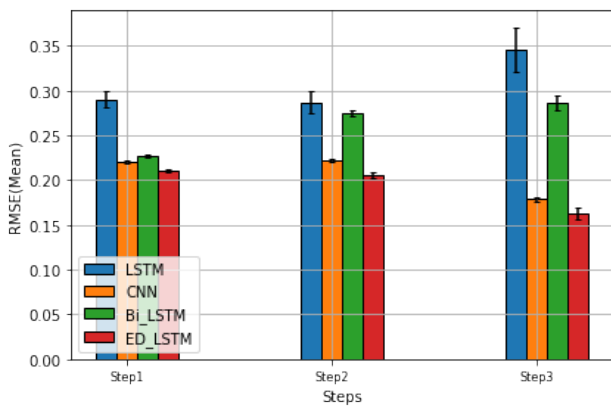

(b) 3steps prediction

Figure 16: Developed Country time series: performance evaluation of respective methods (RMSE mean and 95% confidence interval as error bar)

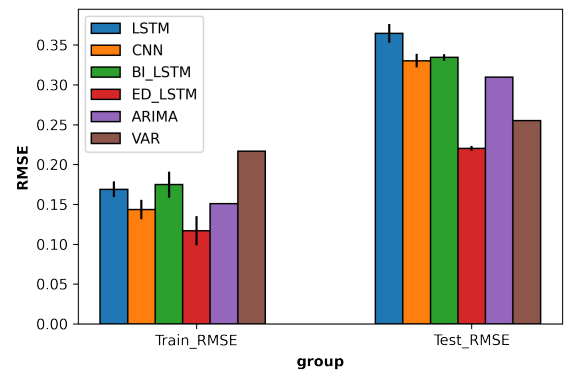

(a) RMSE across 3 step prediction horizon

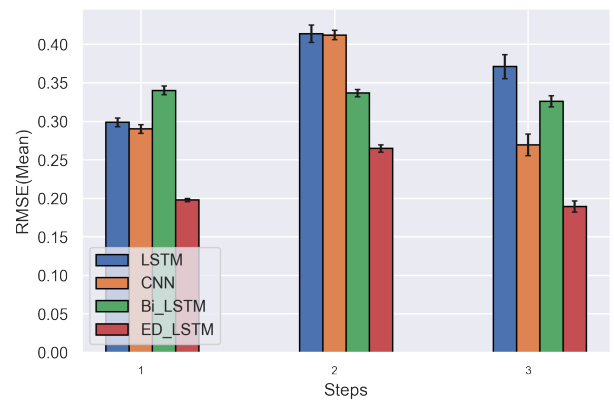

(b) 3 steps prediction

Figure 17: Brazil time series: performance evaluation of respective methods (RMSE mean and 95% confidence interval as error bar)

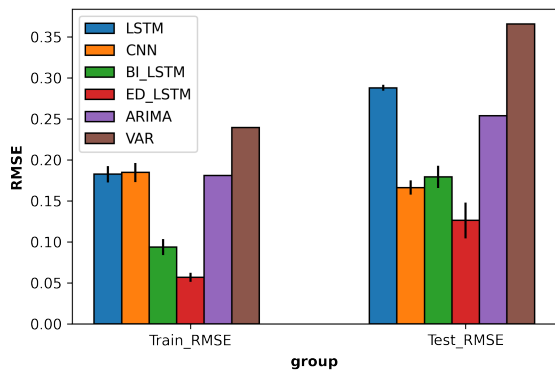

(a) RMSE across 3 step prediction horizon

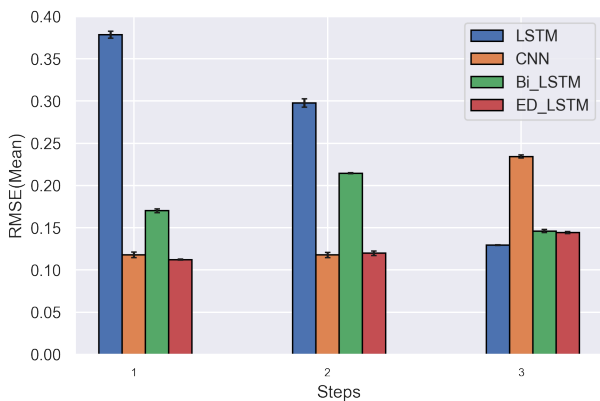

(b) 3 steps prediction

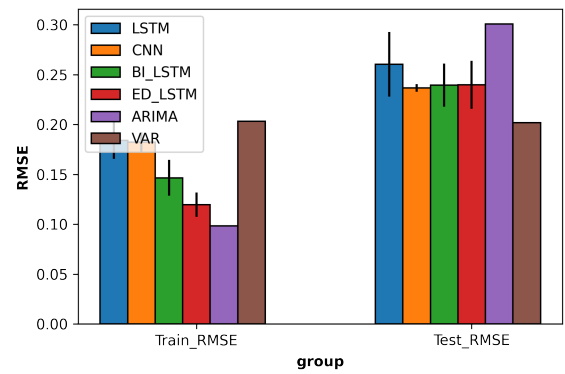

(a) RMSE across 3 step prediction horizon

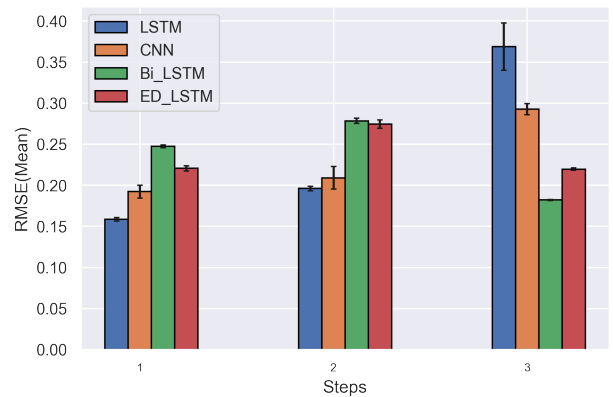

(b) 3 steps prediction

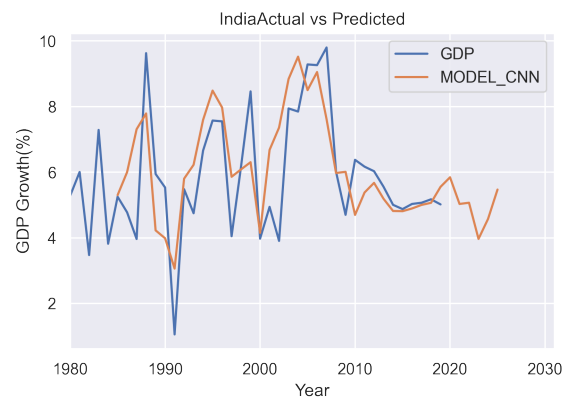

(c) Best CNN

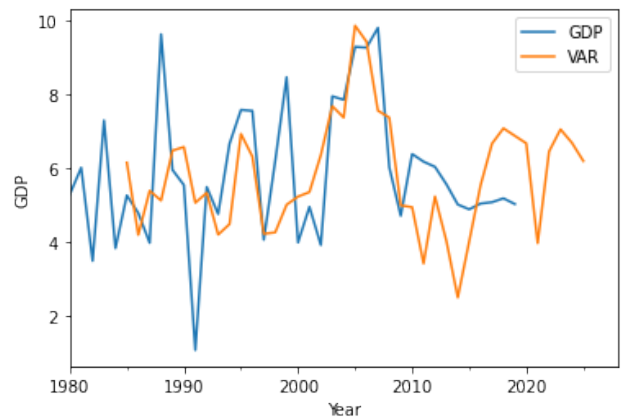

(d) VAR

Figure 18: China time series: performance evaluation of respective methods (RMSE mean and 95% confidence interval as error bar)

Figure 19: India time series: performance evaluation of respective methods (RMSE mean and 95% confidence interval as error bar)

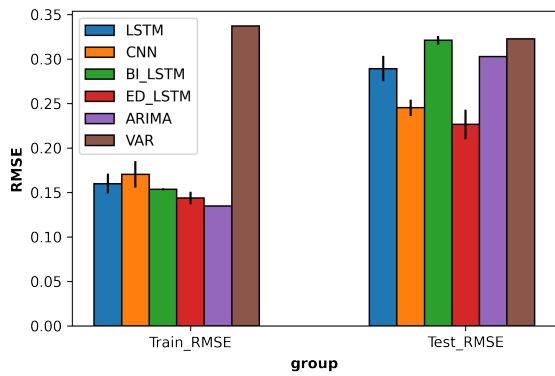

(a) RMSE across 3 step prediction horizon

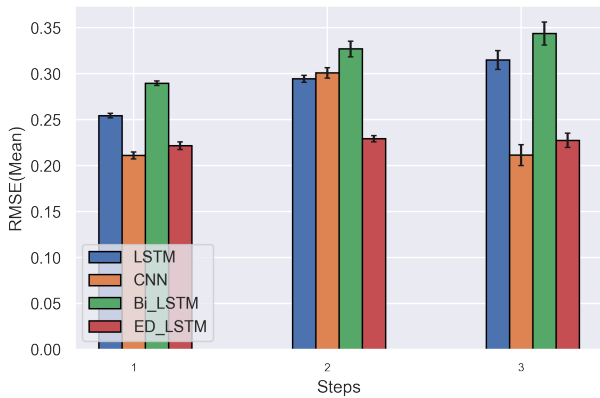

(b) 3 steps prediction

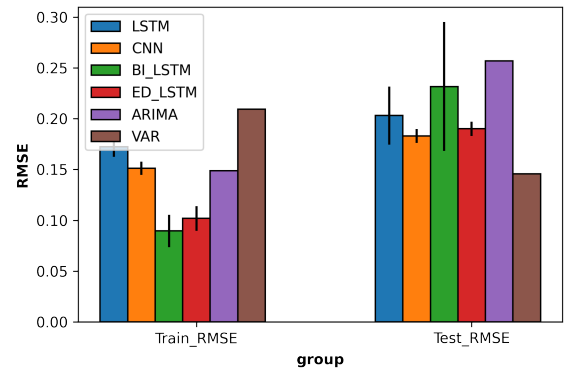

(a) RMSE across 3 step prediction horizon

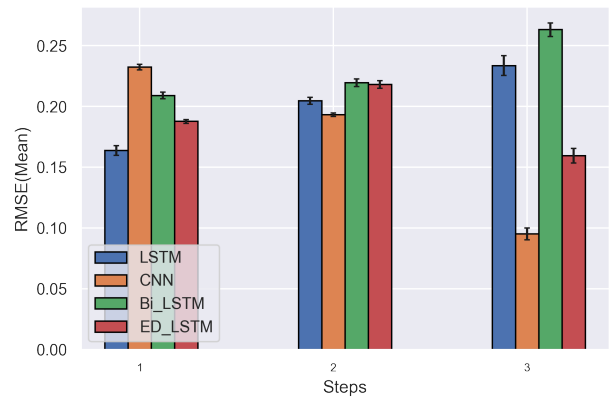

(b) 3 steps prediction

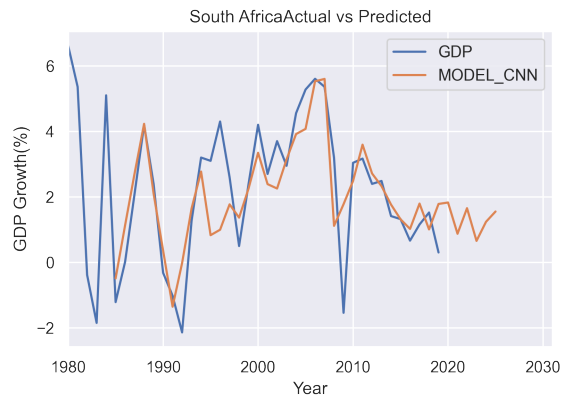

(c) Best CNN

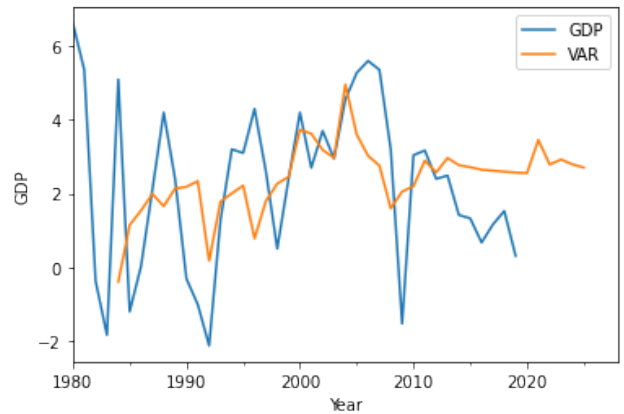

(d) VAR

Figure 20: Russia time series: performance evaluation of respective methods (RMSE mean and 95% confidence interval as error bar)

24 Figure 21: South Africa time series: performance evaluation of respective methods (RMSE mean and 95% confidence interval as error bar)



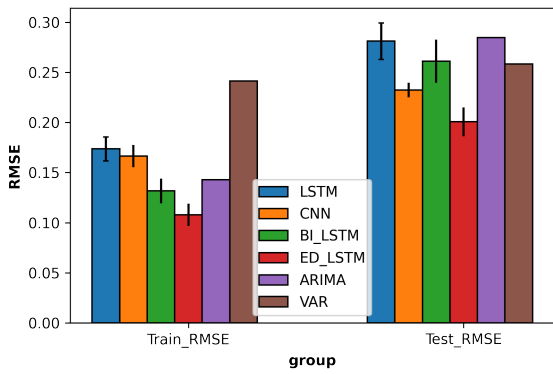

(a) Mean RMSE of whole Developing countries

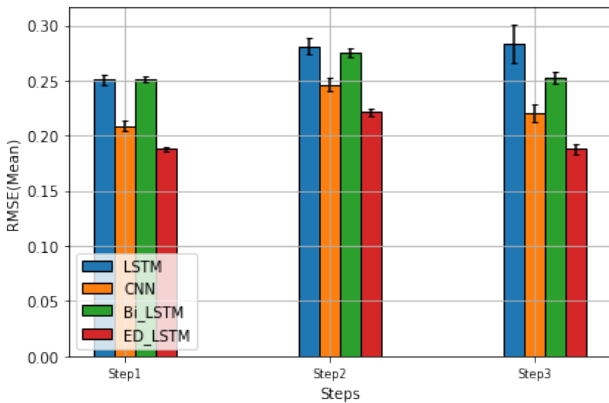

(b) 3steps prediction

Figure 22: Developing Country time series: performance evaluation of respective methods (RMSE mean and 95% confidence interval as error bar)

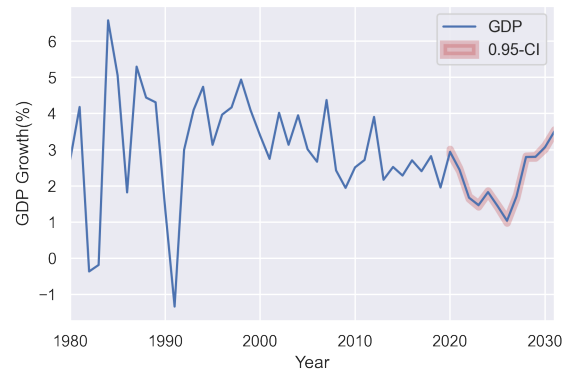

(a) Australia GDP with model prediction (mean) and uncertainty (95% CI).

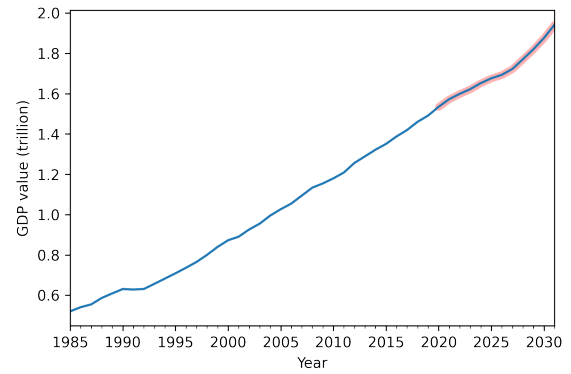

(b) Australia GDP with model prediction (mean) and uncertainty (95% CI).

Figure 23: Australia actual value and recursive multivariate ED-LSTM model prediction for next decade (2020-2031).

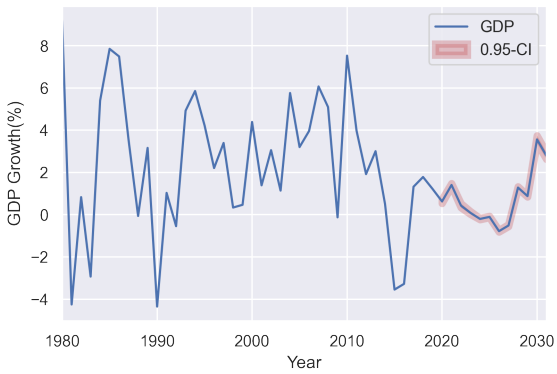

(a) Brazil GDP with model prediction (mean) and uncertainty (95% CI).

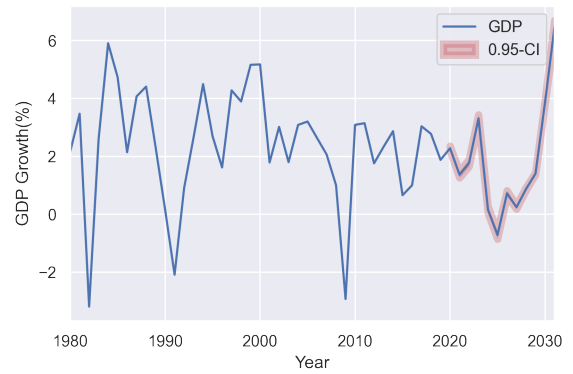

(a) Canada GDP with model prediction (mean) and uncertainty (95% CI).

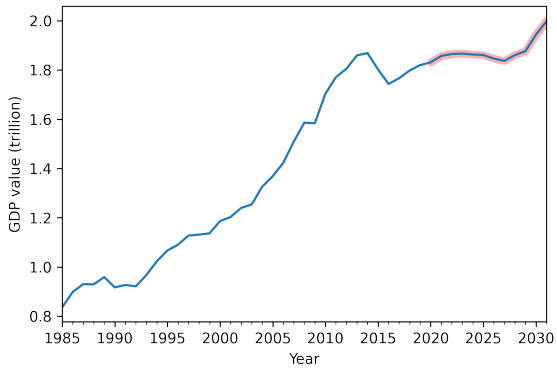

(b) Brazil GDP with model prediction (mean) and uncertainty (95% CI).

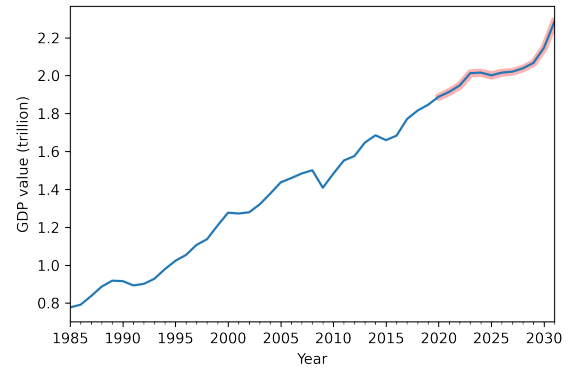

(b) Canada GDP with model prediction (mean) and uncertainty (95% CI).

Figure 24: Brazil actual value and recursive multivariate ED-LSTM model prediction for next decade (2020-2031).

Figure 25: Canada actual value and recursive multivariate ED-LSTM model prediction for next decade (2020-2031).

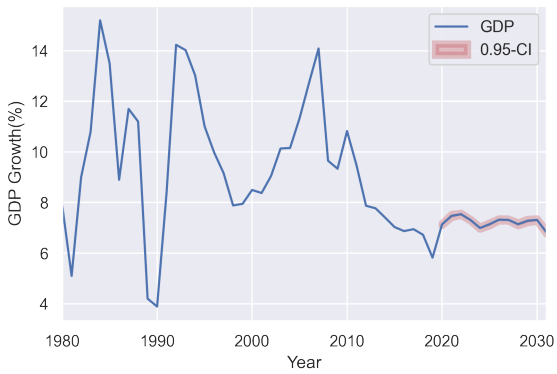

(a) China GDP with model prediction (mean) and uncertainty (95% CI).

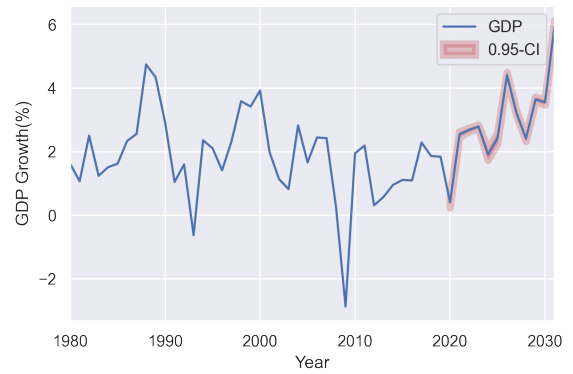

(a) France GDP with model prediction (mean) and uncertainty (95% CI).

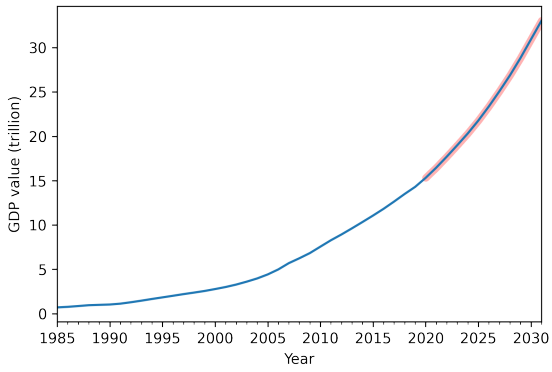

(b) China GDP with model prediction (mean) and uncertainty (95% CI).

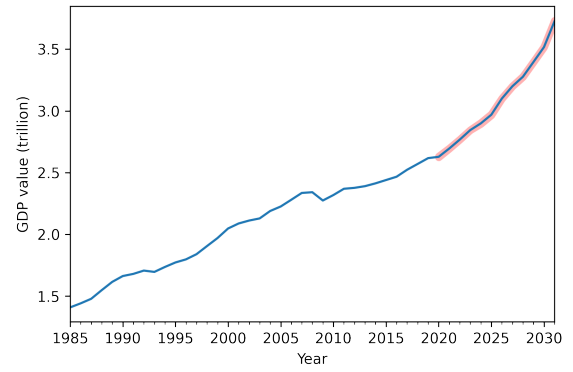

(b) France GDP with model prediction (mean) and uncertainty (95% CI).

Figure 26: China actual value and recursive multivariate ED-LSTM model prediction for next decade (2020-2031).

Figure 27: France actual value and recursive multivariate ED-LSTM model prediction for next decade (2020-2031).

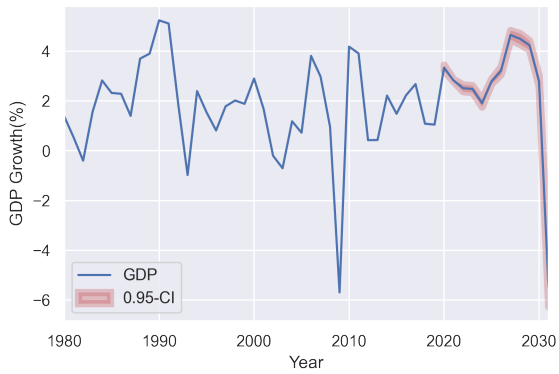

(a) Germany GDP with model prediction (mean) and uncertainty (95% CI).

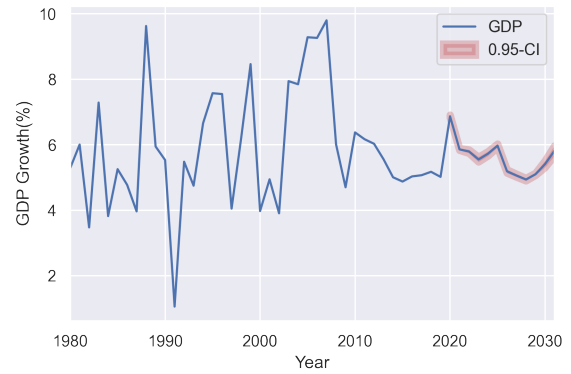

(a) India GDP with model prediction (mean) and uncertainty (95% CI).

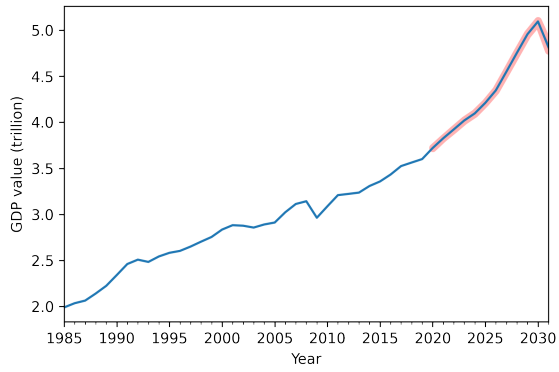

(b) Germany GDP with model prediction (mean) and uncertainty (95% CI).

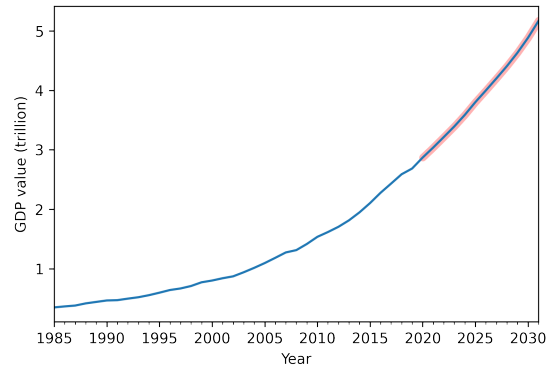

(b) India GDP with model prediction (mean) and uncertainty (95% CI).

Figure 28: Germany actual value and recursive multivariate ED-LSTM model prediction for next decade (2020-2031).

Figure 29: India actual value and recursive multivariate ED-LSTM model prediction for next decade (2020-2031).

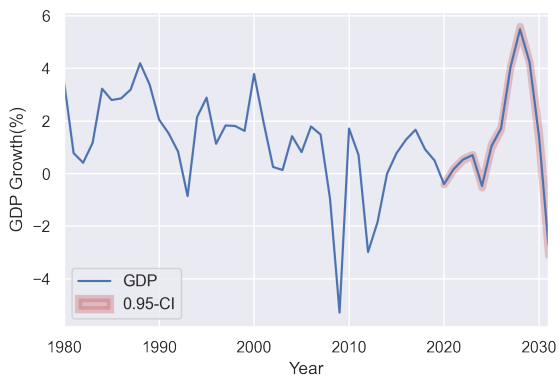

(a) Italy GDP with model prediction (mean) and uncertainty (95% CI).

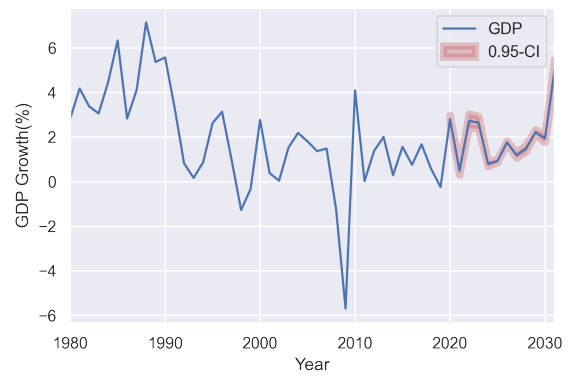

(a) Japan GDP with model prediction (mean) and uncertainty (95% CI).

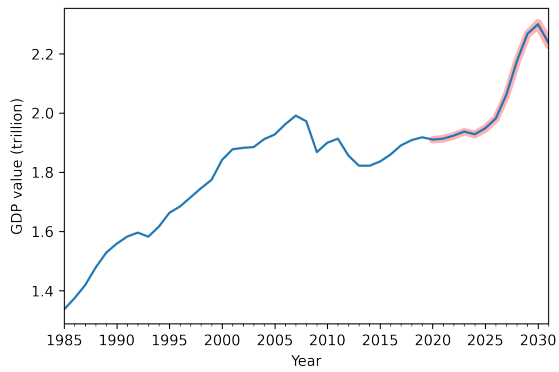

(b) Italy GDP with model prediction (mean) and uncertainty (95% CI).

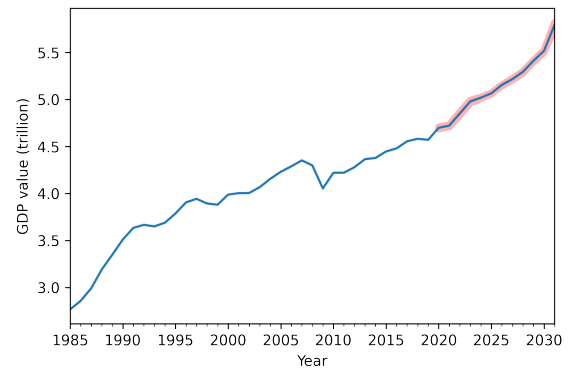

(b) Japan GDP with model prediction (mean) and uncertainty (95% CI).

Figure 30: Italy actual value and recursive multivariate ED-LSTM model prediction for next decade (2020-2031).

Figure 31: Japan actual value and recursive multivariate ED-LSTM model prediction for next decade (2020-2031).

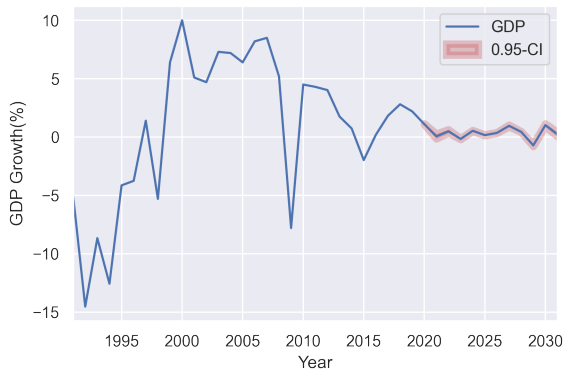

(a) Russia GDP with model prediction (mean) and uncertainty (95% CI).

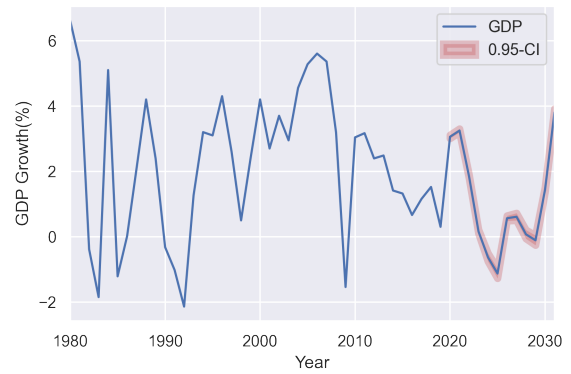

(a) South Africa with model prediction (mean) and uncertainty (95% CI).

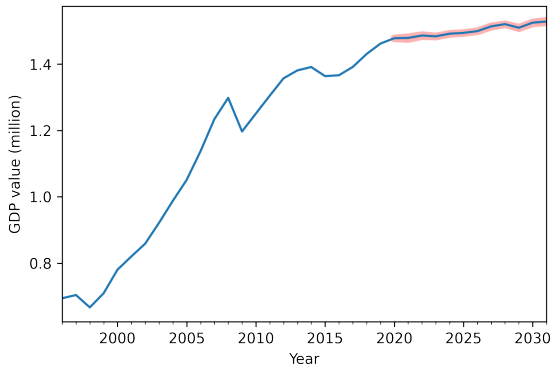

(b) Russia GDP with model prediction (mean) and uncertainty (95% CI).

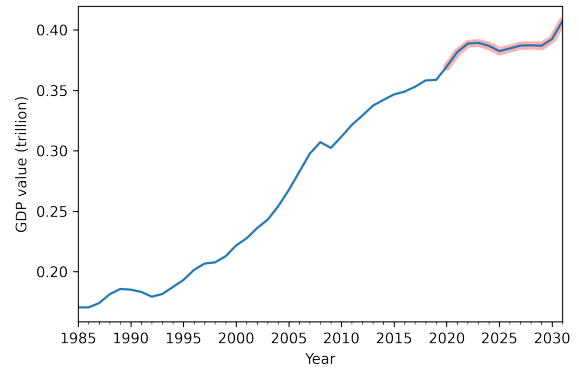

(b) South Africa GDP with model prediction (mean) and uncertainty (95% CI).

Figure 32: Russia actual value and recursive multivariate ED-LSTM model prediction for next decade (2020-2031).

Figure 33: South Africa actual value and recursive multivariate ED-LSTM model prediction for next decade (2020-2031).

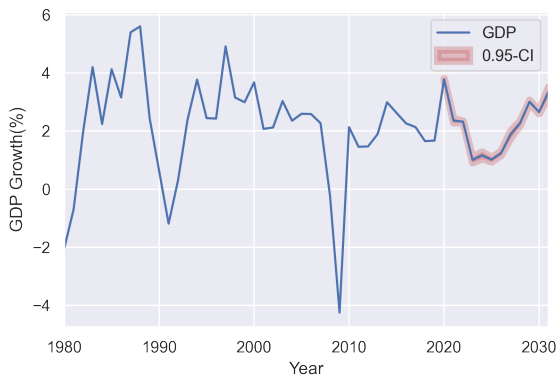

(a) United Kingdom GDP with model prediction (mean) and uncertainty (95% CI).

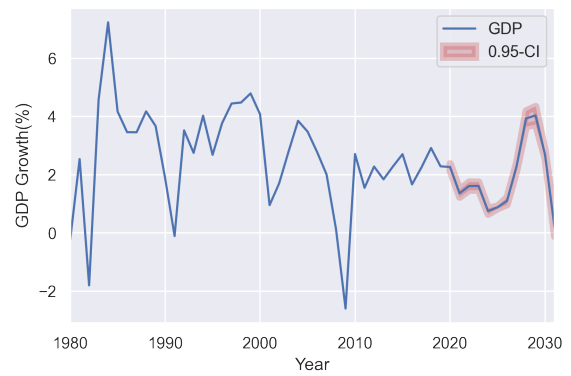

(a) United States GDP with model prediction (mean) and uncertainty (95% CI).

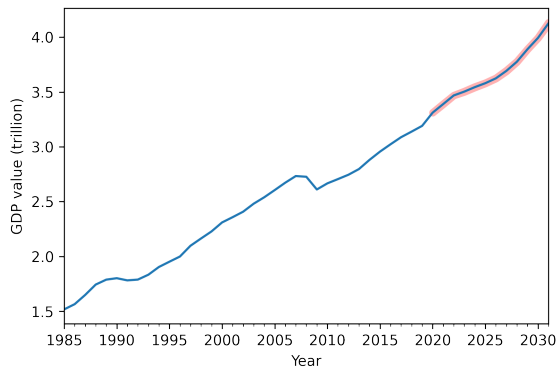

(b) United Kingdom GDP with model prediction (mean) and uncertainty (95% CI).

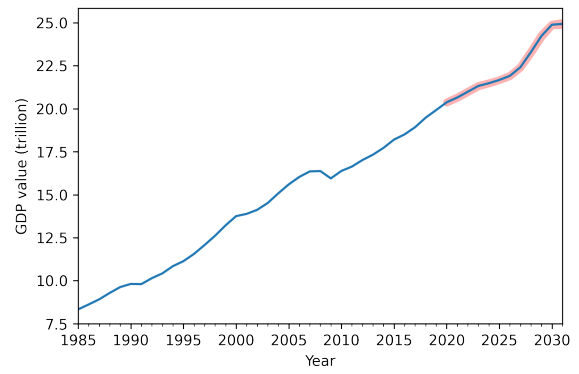

(b) United States GDP with model prediction (mean) and uncertainty (95% CI).

Figure 34: United Kingdom actual value and recursive multivariate ED-LSTM model prediction for next decade (2020-2031).

Figure 35: United States actual value and recursive multivariate ED-LSTM model prediction for next decade (2020-2031).