

# Computing Adequately Permissive Assumptions for Synthesis

Ashwani Anand<sup>1</sup>, Kaushik Mallik<sup>2</sup>, Satya Prakash Nayak<sup>1</sup>, and  
Anne-Kathrin Schmuck<sup>1</sup>

<sup>1</sup> Max Planck Institute for Software Systems, Kaiserslautern, Germany  
{ashwani, sanayak, akschmuck}@mpi-sws.org

<sup>2</sup> Institute of Science and Technology Austria, Klosterneuburg, Austria  
kaushik.mallik@ist.ac.at

**Abstract.** We solve the problem of automatically computing a new class of environment assumptions in two-player turn-based finite graph games which characterize an “adequate cooperation” needed from the environment to allow the system player to win. Given an  $\omega$ -regular winning condition  $\Phi$  for the system player, we compute an  $\omega$ -regular assumption  $\Psi$  for the environment player, such that (i) every environment strategy compliant with  $\Psi$  allows the system to fulfill  $\Phi$  (sufficiency), (ii)  $\Psi$  can be fulfilled by the environment for every strategy of the system (implementability), and (iii)  $\Psi$  does not prevent any cooperative strategy choice (permissiveness).

For parity games, which are canonical representations of  $\omega$ -regular games, we present a polynomial-time algorithm for the symbolic computation of *adequately permissive assumptions* and show that our algorithm runs faster and produces better assumptions than existing approaches—both theoretically and empirically. To the best of our knowledge, for  $\omega$ -regular games, we provide the first algorithm to compute sufficient and implementable environment assumptions that are also *permissive*.

**Keywords:** Synthesis · Two-player Games · Parity Games · Buchi Games · co-Buchi Games · Symbolic Algorithms.

## 1 Introduction

Two-player  $\omega$ -regular games on finite graphs are the core algorithmic components in many important problems of computer science and cyber-physical system design. Examples include the synthesis of programs which react to environment inputs, modal  $\mu$ -calculus model checking, correct-by-design controller synthesis for cyber-physical systems, and supervisory control of autonomous systems.

These problems can be ultimately reduced to an abstract two-player game between an *environment player* and a *system player*, respectively capturing the external unpredictable influences and the system under design, while the game captures the non-trivial interplay between these two parts. A *solution of the*

*game* is a set of decisions the system player needs to make to satisfy a given  $\omega$ -regular temporal property over the states of the game, which is then used to design the sought system or its controller.

Traditionally, two-player games over graphs are solved in a zero-sum fashion, i.e., assuming that the environment will behave arbitrarily and possibly adversarially. Although this approach results in robust system designs, it usually makes the environment too powerful to allow an implementation for the system to exist. However in reality, many of the outlined application areas actually account for some cooperation of system components, especially if they are co-designed. In this scenario it is useful to understand how the environment (i.e., other processes) needs to cooperate to allow for an implementation to exist. This can be formalized by environment assumptions, which are  $\omega$ -regular temporal properties that restrict the moves of the environment player in a synthesis game. Such assumptions can then be used as additional specifications in other components' synthesis problems to enforce the necessary cooperation (possibly in addition to other local requirements) or can be used to verify existing implementations.

For the reasons outlined above, the automatic computation of assumptions has received significant attention in the reactive synthesis community. It has been used in two-player games [8,6], both in the context of monolithic system design [11,20] as well as distributed system design [19,13].

All these works emphasize two desired properties of assumptions. They should be (i) *sufficient*, i.e., enable the system player to win if the environment obeys its assumption and (ii) *implementable*, i.e., prevent the system player to falsify the assumption and thereby vacuously win the game by not even respecting the original specification. In this paper, we claim that there is an important third property—termed *permissiveness*—which is needed when computed assumptions are used for distributed synthesis. An assumption is *permissive* if it retains all cooperatively winning plays in the game. This notion is crucial in the setting of distributed synthesis, as here assumptions are generated *before* the implementation of every component is fixed. Therefore, assumptions need to retain *all* feasible ways of cooperation to allow for a distributed implementation to be discovered in a decentralized manner.

While the class of assumptions considered in this paper is motivated by their use for distributed synthesis, this paper focuses only on their formalization and computation, i.e., given a two-player game over a finite graph and an  $\omega$ -regular winning condition  $\Phi$  for the system player, we automatically compute an *adequately permissive  $\omega$ -regular assumption*  $\Psi$  for the environment player that formalizes the above intuition by being (i) sufficient, (ii) implementable, and (iii) permissive. The main observation that we exploit is that such *adequately permissive assumptions* (APA for short) can be constructed from three simple templates which can be directly extracted from a cooperative synthesis game leading to a polynomial-time algorithm for their computation. By observing page constraints, we postpone the very interesting but largely orthogonal problem of contract-based distributed synthesis using APAs to future work.

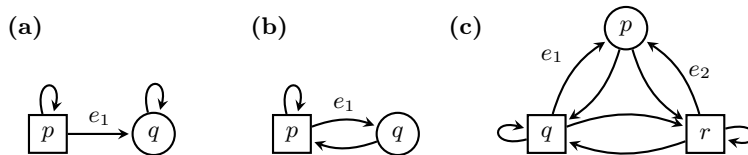

**Fig. 1:** Game graphs with environment (squares) and system (circles) vertices.

To appreciate the simplicity of the assumption templates we use, consider the game graphs depicted in Fig. 1 where the system and the environment player control the circle and square vertices, respectively. Given the specification  $\Phi = \diamond\Box\{p\}$  (which requires the play to eventually only see vertex  $p$ ), the system player can win the game in Fig. 1 (a) by requiring the environment to fully disable edge  $e_1$ . This introduces the first template type—a *safety template*—on  $e_1$ . On the other hand, the game in Fig. 1 (b) only requires that  $e_1$  is taken finitely often. This is captured by our second template type—a *co-liveness template*—on  $e_1$ . Finally, consider the game in Fig. 1 (c) with the specification  $\Phi = \Box\Diamond\{p\}$ , i.e. vertex  $p$  should be seen infinitely often. Here, the system player wins if whenever the source vertices of edges  $e_1$  and  $e_2$  are seen infinitely often, also one of these edges is taken infinitely often. This is captured by our third template type—a *live group template*—on the edge-group  $\{e_1, e_2\}$ .

**Contribution.** The main contribution of this paper is to show that APAs can always be composed from the three outlined assumption templates and can be computed in polynomial time.

Using a set of benchmark examples taken from SYNTCOMP [2] and a prototype implementation of our algorithm in our new tool SIMPA, we empirically show that our algorithm is both faster and produces more desirable solutions than existing approaches. In addition, we apply SIMPA to the well known 2-client arbiter synthesis benchmark from [22], which is known to only allow for an implementation of the arbiter if the clients’ moves are suitably restricted. We show that applying SIMPA to the unconstrained arbiter synthesis problem yields assumptions on the clients which are less restrictive but conceptually similar to the ones typically used in the literature.

**Related Work.** The problem of automatically computing environment assumptions for synthesis was already addressed by Chatterjee et al. [8]. However, their class of assumptions does in general not allow to construct *permissive* assumptions. Further, computing their assumptions is an NP-hard problem, while our algorithm computes APAs in  $\mathcal{O}(n^4)$ -time for a parity game with  $n$  vertices. The difference in the complexity arises because Chatterjee et al. require minimality of the assumptions. On the other hand, we trade minimality for permissiveness which allows us to utilize cooperative games, which are easier to solve.

When considering cooperative solutions of non-zero-sum games, related works either fix strategies for both players [7,14], assume a particularly rational behavior of the environment [4] or restrict themselves to safety assumptions [19]. In contrast, we do not make any assumption on how the environment chooses its strategy. Finally, in the context of specification-repair in zero-sum games multiple

automated methods for repairing environment models exist, e.g. [23,15,16,21,8]. Unfortunately, all of these methods fail to provide permissive repairs. A recent work by Cavezza et al. [6] computes a minimally restrictive set of assumptions but only for GR(1) specifications, which are a strict subclass of the problem considered in our work. To the best of our knowledge, we propose the first fully automated algorithm for computing *permissive* assumptions for general  $\omega$ -regular games.

## 2 Preliminaries

**Notation.** We use  $\mathbb{N}$  to denote the set of natural numbers including zero. Given two natural numbers  $a, b \in \mathbb{N}$  with  $a < b$ , we use  $[a; b]$  to denote the set  $\{n \in \mathbb{N} \mid a \leq n \leq b\}$ . For any given set  $[a; b]$ , we write  $i \in_{\text{even}} [a; b]$  and  $i \in_{\text{odd}} [a; b]$  as short hand for  $i \in [a; b] \cap \{0, 2, 4, \dots\}$  and  $i \in [a; b] \cap \{1, 3, 5, \dots\}$  respectively. Given two sets  $A$  and  $B$ , a relation  $R \subseteq A \times B$ , and an element  $a \in A$ , we write  $R(a)$  to denote the set  $\{b \in B \mid (a, b) \in R\}$ .

**Languages.** Let  $\Sigma$  be a finite alphabet. The notations  $\Sigma^*$  and  $\Sigma^\omega$  denote the set of finite and infinite words over  $\Sigma$ , respectively, and  $\Sigma^\infty$  is equal to  $\Sigma^* \cup \Sigma^\omega$ . For any word  $w \in \Sigma^\infty$ ,  $w_i$  denotes the  $i$ -th symbol in  $w$ . Given two words  $u \in \Sigma^*$  and  $v \in \Sigma^\infty$ , the concatenation of  $u$  and  $v$  is written as the word  $uv$ .

**Game graphs.** A *game graph* is a tuple  $G = (V, V^0, V^1, E)$  where  $(V, E)$  is a finite directed graph with *vertices*  $V$  and *edges*  $E$ , and  $V^0, V^1 \subseteq V$  form a partition of  $V$  (i.e.  $V^0 \cap V^1 = \emptyset$  and  $V^0 \cup V^1 = V$ ). Without loss of generality, we assume that for every  $v \in V$  there exists  $v' \in V$  s.t.  $(v, v') \in E$ . For the purpose of this paper, the *system* and the *environment* players will be denoted by *Player 0* and *Player 1*, respectively. A *play* originating at a vertex  $v_0$  is a finite or infinite sequence of vertices  $\rho = v_0 v_1 \dots \in V^\infty$ . A *play prefix*  $\mathbf{p} = v_0 v_1 \dots v_k$  is a finite play.

**Winning conditions.** Given a game graph  $G$ , we consider winning conditions specified using a formula  $\Phi$  in *linear temporal logic* (LTL) over the vertex set  $V$ , that is, we consider LTL formulas whose atomic propositions are sets of vertices  $V$ . In this case the set of desired infinite plays is given by the semantics of  $\Phi$  over  $G$ , which is an  $\omega$ -regular language  $\mathcal{L}(\Phi) \subseteq V^\omega$ . Every game graph with an arbitrary  $\omega$ -regular set of desired infinite plays can be reduced to a game graph (possibly with an extended set of vertices) with an LTL winning condition, as above. The standard definitions of  $\omega$ -regular languages and LTL are omitted for brevity and can be found in standard textbooks [3].

**Games and strategies.** A *two-player (turn-based) game* is a pair  $\mathcal{G} = (G, \Phi)$  where  $G$  is a game graph and  $\Phi$  is a *winning condition* over  $G$ . A strategy of *Player*  $i$ ,  $i \in \{0, 1\}$ , is a partial function  $\pi^i: V^* V^i \rightarrow V$  such that for every  $\mathbf{pv} \in V^* V^i$  for which  $\pi$  is defined, it holds that  $\pi^i(\mathbf{pv}) \in E(v)$ . Given a strategy  $\pi^i$ , we say that the play  $\rho = v_0 v_1 \dots$  is *compliant* with  $\pi^i$  if  $v_{k-1} \in V^i$  implies  $v_k = \pi^i(v_0 \dots v_{k-1})$  for all  $k \in \text{dom}(\rho)$  and,  $\rho$  is a finite play  $\mathbf{p}$  only if  $\pi^i(\mathbf{p})$  is undefined. We refer to a play compliant with  $\pi^i$  and a play compliant with

both  $\pi^0$  and  $\pi^1$  as a  $\pi^i$ -play and a  $\pi^0\pi^1$ -play, respectively. We collect all plays compliant with  $\pi^i$ , and compliant with both  $\pi^0$  and  $\pi^1$  in the sets  $\mathcal{L}(\pi^i)$  and  $\mathcal{L}(\pi^0\pi^1)$ , respectively.

**Winning.** Given a game  $\mathcal{G} = (G, \Phi)$ , a strategy  $\pi^i$  is (surely) *winning for Player  $i$*  if  $\mathcal{L}(\pi^i) \subseteq \mathcal{L}(\Phi)$ , i.e., a *Player 0* strategy  $\pi^0$  is winning if for every *Player 1* strategy  $\pi^1$  it holds that  $\mathcal{L}(\pi^0\pi^1) \subseteq \mathcal{L}(\Phi)$ . Similarly, a fixed strategy profile  $(\pi^0, \pi^1)$  is *cooperatively winning* if  $\mathcal{L}(\pi^0\pi^1) \subseteq \mathcal{L}(\Phi)$ . We say that a vertex  $v \in V$  is *winning for Player  $i$*  (resp. *cooperatively winning*) if there exists a winning strategy  $\pi^i$  (resp. a cooperatively winning strategy profile  $(\pi^0, \pi^1)$ ) s.t.  $\pi^i(v)$  is defined. We collect all winning vertices of *Player  $i$*  in the *Player  $i$  winning region*  $\langle\langle i \rangle\rangle\Phi \subseteq V$  and all cooperatively winning vertices in the *cooperative winning region*  $\langle\langle 0, 1 \rangle\rangle\Phi$ . We note that  $\langle\langle i \rangle\rangle\Phi \subseteq \langle\langle 0, 1 \rangle\rangle\Phi$  for both  $i \in \{0, 1\}$ .

### 3 Adequately Permissive Assumptions for Synthesis

Given a two-player game  $\mathcal{G}$ , the goal of this paper is to compute assumptions on *Player 1* (i.e., the environment), such that both players cooperate *just enough* to fulfill  $\Phi$  while retaining all possible cooperative strategy choices. Towards a formalization of this intuition, we define winning under assumptions.

**Definition 1.** Let  $\mathcal{G} = ((V, V^0, V^1, E), \Phi)$  be a game and  $\Psi$  be an LTL formula over  $V$ . Then a *Player 0* strategy  $\pi^0$  is winning in  $\mathcal{G}$  under assumption  $\Psi$ , if for every *Player 1* strategy  $\pi^1$  s.t.  $\mathcal{L}(\pi^1) \subseteq \mathcal{L}(\Psi)$  it holds that  $\mathcal{L}(\pi^0\pi^1) \subseteq \mathcal{L}(\Phi)$ . We denote by  $\langle\langle 0 \rangle\rangle_{\Psi}\Phi$  the set of vertices from which such a *Player 0* strategy exists.

We see that the assumption  $\Psi$  introduced in Def. 1 *weakens* the strategy choices of the environment player (*Player 1*). We call assumptions *sufficient* if this weakening is strong enough to allow *Player 0* to win from every vertex in the cooperative winning region.

**Definition 2.** An assumption  $\Psi$  is sufficient for  $(G, \Phi)$  if  $\langle\langle 0 \rangle\rangle_{\Psi}\Phi \supseteq \langle\langle 0, 1 \rangle\rangle\Phi$ .

Unfortunately, sufficient assumptions can be abused to change the given synthesis problem in an unintended way. Consider for instance the game in Fig. 2 (left) with  $\Phi = \Box\Diamond\{v_0\}$  and  $\Psi = \Box\Diamond e_1$ . Here, there is no strategy  $\pi^1$  for *Player 1* such that  $\mathcal{L}(\pi^1) \subseteq \mathcal{L}(\Psi)$  as the system can always falsify the assumption by simply not choosing  $e_1$  infinitely often in  $v_1$ . Therefore, any *Player 0* strategy is winning under assumption even if  $\Phi$  is violated. The assumption  $\Psi$ , however, is trivially sufficient, as  $\langle\langle 0 \rangle\rangle_{\Psi}\Phi = V$ . In order to prevent sufficient assumptions to be falsifiable and thereby enabling vacuous winning, we define the notion of *implementability*, which ensures that  $\Psi$  solely restricts *Player 1* moves.

**Definition 3.** An assumption  $\Psi$  is implementable for  $(G, \Phi)$  if  $\langle\langle 1 \rangle\rangle\Psi = V$ .

An assumption which is sufficient and implementable ensures that the cooperative winning region of the original game coincides with the winning region under that assumption, i.e.,  $\langle\langle 0 \rangle\rangle_{\Psi}\Phi = \langle\langle 0, 1 \rangle\rangle\Phi$ . However, it does not yet ensure that all cooperative strategy choices of both players are retained, which is ensured by the notion of *permissiveness*.

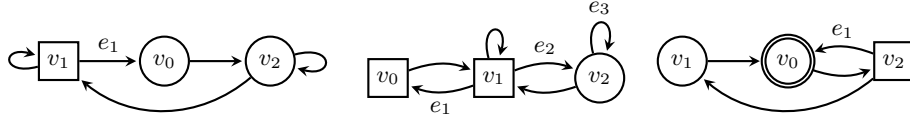

**Fig. 2:** Two-player games with *Player 1* (squares) and *Player 0* (circles) vertices.

**Definition 4.** An assumption  $\Psi$  is permissive for  $(G, \Phi)$  if  $\mathcal{L}(\Phi) \subseteq \mathcal{L}(\Psi)$ .

This notion of permissiveness is motivated by the intended use of assumptions for compositional synthesis. In the simplest scenario of two interacting processes, two synthesis tasks—one for each process—are considered in parallel. Here, generated assumptions in one synthesis task are used as additional specifications in the other synthesis problem. Therefore, permissiveness is crucial to not “skip” over possible cooperative solutions—each synthesis task needs to keep all allowed strategy choices for both players intact to allow for compositional reasoning. This scenario is illustrated in the following example to motivate the considered class of assumptions. Formalizing assumption-based compositional synthesis in general is however out of the scope of this paper.

*Example 1.* Consider the (non-zero-sum) two-player game in Fig. 2 (middle) with two different specifications for both players, namely  $\Phi_0 = \diamond\Box\{v_1, v_2\}$  and  $\Phi_1 = \diamond\Box\{v_1\}$ . Now consider two candidate assumptions  $\Psi_0 = \diamond\Box\neg e_1$  and  $\Psi'_0 = (\Box\diamond v_1 \implies \Box\diamond e_2)$  on *Player 1*. Notice that both assumptions are sufficient and implementable for  $(G, \Phi_0)$ . However,  $\Psi'_0$  does not allow the play  $\{v_1\}^\omega$  and hence is not permissive whereas  $\Psi_0$  is permissive for  $(G, \Phi_0)$ . As a consequence, there is no way *Player 1* can satisfy both her objective  $\Phi_1$  and the assumption  $\Psi'_0$  even if *Player 0* cooperates, since  $\mathcal{L}(\Phi_1) \cap \mathcal{L}(\Psi'_0) = \emptyset$ . However, under the assumption  $\Psi_0$  on *Player 1* and assumption  $\Psi_1 = \diamond\Box\neg e_3$  on *Player 0* (which is sufficient and implementable for  $(G, \Phi_1)$  if we interchange the vertices of the players), they can satisfy both their own objectives and the assumptions on themselves. Therefore, they can collectively satisfy both their objectives.

*Remark 1.* We remark that for Ex. 1, the algorithm in [9] outputs  $\Psi'_0$  as the desired assumption for game  $(G, \Phi_0)$  and their used assumption formalism is not rich enough to capture assumption  $\Psi_0$ . This shows that the assumption type we are interested in is not computable by the algorithm from [9].

**Definition 5.** An assumption  $\Psi$  is called adequately permissive (an APA for short) for  $(G, \Phi)$  if it is sufficient, implementable and permissive.

### 3.1 Discussion on Definition 1

We first note some simple but interesting consequences of Def. 1. First, we have *anti-monotonicity*, i.e, if assumption  $\Psi_1$  is stronger than assumption  $\Psi_2$  (in terms of play inclusion), and  $\pi^0$  is winning under  $\Psi_2$ , then it is also winning under  $\Psi_1$ . As a direct consequence of this observation, we also have *conjunctivity*, i.e., if  $\pi^0$  is winning under  $\Psi_1$  and  $\pi^0$  is winning under  $\Psi_2$ , then  $\pi^0$  is winning under

$\Psi_1 \wedge \Psi_2$ . Interestingly, however, Def. 1 does not allow for *disjunctivity*, i.e., if  $\pi^0$  is winning under  $\Psi_1$  and  $\pi^0$  is winning under  $\Psi_2$ , then it need *not* be winning under  $\Psi_1 \vee \Psi_2$ . This last observation is illustrated by the following example.

*Example 2.* Consider the game graph in Fig. 3 with the specification  $\Phi = \diamond\Box\{a\}$  (which requires the play to eventually only see vertex  $a$ ). Then consider the assumptions  $\Psi_1 = \neg e_0\mathcal{U}X e_1$  (when edge  $e_0$  is taken for the first time, the next edge should be  $e_1$ ) and  $\Psi_2 = e_0\mathcal{U}X e_2$  (when edge  $e_0$  is taken for the first time, the next edge should be  $e_2$ ). Notice that there is only one *Player 1* strategy  $\pi^1$ , i.e., the one that never uses edge  $e_0$ , satisfying either assumption. So, any play compliant with  $\pi^1$  eventually only visits vertex  $a$ , and hence, is winning. Therefore, any *Player 0* strategy is winning under either assumption. In particular, consider the strategy  $\pi^0$  that only uses edge  $e_1$ . Then  $\pi^0$  is winning under assumption  $\Psi_i$  for each  $i$ . However,  $\pi^0$  is not winning under  $\Psi := \Psi_1 \vee \Psi_2 \equiv \mathbf{true}$ . To see this, note that assumption  $\Psi$  can be satisfied by any *Player 1* strategy, in particular, the strategy  $\tilde{\pi}^1$  that always uses  $e_0$  from state  $a$ . It is easy to see that the combination of  $\tilde{\pi}^1$  with  $\pi^0$  yields the play  $(abc)^\omega$  that satisfies  $\Psi$  but not  $\Phi$ . Hence,  $\pi^0$  is not winning under assumption  $\Psi := \Psi_1 \vee \Psi_2$ .

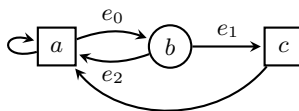

**Fig. 3:** Example game graph illustrating non-disjunctivity of winning under assumption, as explained in Ex. 2.

In addition, we want to remark that Def. 1 slightly differs from the typical linear-time synthesis setting, where winning under assumption would be naturally defined in terms of plays instead of strategies. We therefore want to briefly discuss this setting and give some intuition why it coincides with our definition of winning for the special type of assumptions we compute.

We start by giving an alternative formulation of Def. 1 in terms of plays.

**Definition 6.** Let  $\mathcal{G} = ((V, V^0, V^1, E), \Phi)$  be a game and  $\Psi$  be an LTL formula over  $V$ . Then a *Player 0* strategy  $\pi^0$  is winning in  $\mathcal{G}$  under assumption  $\Psi$ , if every play  $\rho \in \mathcal{L}(\pi^0)$  either fails to satisfy the assumption  $\Psi$  or satisfies the specification  $\Phi$ .

It is easy to observe that a strategy  $\pi^0$  that is winning under assumption by Def. 6 is also winning under assumption by Def. 1. However, the other direction is not true in general, as shown by the following example.

*Example 3.* Consider the same game as in Example 2, i.e., the game in Fig. 3 with specification  $\Phi = \diamond\Box\{a\}$ . Also, consider the assumption  $\Psi_1 = \neg e_0\mathcal{U}X e_1$  as in Example 2. Then by the same arguments as before, the strategy  $\pi^0$ , which only uses edge  $e_1$ , is winning under  $\Psi_1$  by Def. 1. However, note that the play

$(abc)^\omega$  is compliant with  $\pi^0$  and satisfies  $\Psi_1$  but does not satisfy  $\Phi$ . Hence,  $\pi^0$  is not winning under  $\Psi_1$  by Def. 6.

Interestingly, the class of assumptions we compute in this paper does not allow for examples of the sort presented above. Intuitively, this is due to the fact that these assumptions are *implementable* by *Player 1* and realized by a combination of very local templates. These assumptions can therefore be enforced by only restricting the moves of *Player 1*. This implies that for any play  $\rho$  that complies with the assumption and  $\pi^0$ , there does exist a strategy  $\pi^1$  satisfying the assumption, which results in  $\rho$ . Hence, any strategy  $\pi^0$  which is winning under assumption for by Def. 1 is also winning under assumption by Def. 6. The complete proof of the equivalence between the two definitions for our class of assumption can be found in Appendix F as it requires the results of the next sections.

We conclude this subsection by noting that the choice of our formulation of ‘winning under assumption’ is inspired by distributed synthesis. Here, the environment agents might be unknown to the system. Our definition allows us to naturally argue that the strategy  $\pi^0$  of *Player 0* (System) is winning for *any* strategy  $\pi^1$  that *Player 1* (Environment) may choose to satisfy the assumption.

## 4 Computing Adequately Permissive Assumptions (APA)

In this section, we present our algorithm to compute *adequately permissive assumptions* (APA for short) for *parity games*, which are canonical representations of  $\omega$ -regular games. For a gradual exposition of the topic, we first present algorithms for simpler winning conditions, namely safety (Sec. 4.2), Büchi (Sec. 4.3), and Co-Büchi (Sec. 4.4), which are used as building blocks while presenting the algorithm for parity games (Sec. 4.5). We first introduce some preliminaries.

### 4.1 Preliminaries

We use symbolic fixpoint algorithms expressed in the  $\mu$ -calculus [18] to compute the winning regions and to generate assumptions in simple post-processing steps. **Set Transformers.** Let  $G = (V, V^0, V^1, E)$  be a game graph,  $U \subseteq V$  be a subset of vertices, and  $a \in \{0, 1\}$  be the player index. Then we define two types of predecessor operators:

$$\text{pre}_G(U) = \{v \in V \mid \exists u \in U. (v, u) \in E\} \quad (1)$$

$$\text{cpre}_G^a(U) = \{v \in V^a \mid v \in \text{pre}_G(U)\} \cup \{v \in V^{1-a} \mid \forall (v, u) \in E. u \in U\} \quad (2)$$

$$\text{cpre}_G^{a,1}(U) = \text{cpre}_G^a(U) \cup U \quad (3)$$

$$\text{cpre}_G^{a,i}(U) = \text{cpre}_G^a(\text{cpre}_G^{a,i-1}(U)) \cup \text{cpre}_G^{a,i-1}(U) \text{ with } i \geq 1 \quad (4)$$

The predecessor operator  $\text{pre}_G(U)$  computes the set of vertices with at least one successor in  $U$ . The controllable predecessor operators  $\text{cpre}_G^a(U)$  and  $\text{cpre}_G^{a,i}(U)$  compute the set of vertices from which *Player a* can force visiting  $U$  in *at most*



one and  $i$  steps respectively. In the following, we introduce the attractor operator  $\text{attr}_G^a(U)$  that computes the set of vertices from which *Player a* can force at least a single visit to  $U$  in *finitely many but nonzero*<sup>3</sup> steps:

$$\text{attr}_G^a(U) = \left( \bigcup_{i \geq 1} \text{cpre}^{a,i}(U) \right) \setminus U \quad (5)$$

When clear from the context, we drop the subscript  $G$  from these operators.

**Fixpoint Algorithms in the  $\mu$ -calculus.**  $\mu$ -calculus [18] offers a succinct representation of symbolic algorithms (i.e., algorithms manipulating sets of vertices instead of individual vertices) over a game graph  $G$ . The formulas of the  $\mu$ -calculus, interpreted over a 2-player game graph  $G$ , are given by the grammar

$$\phi := p \mid X \mid \phi \cup \phi \mid \phi \cap \phi \mid \text{pre}(\phi) \mid \mu X. \phi \mid \nu X. \phi$$

where  $p$  ranges over subsets of  $V$ ,  $X$  ranges over a set of formal variables,  $\text{pre}$  ranges over monotone set transformers in  $\{\text{pre}, \text{cpre}^a, \text{attr}^a\}$ , and  $\mu$  and  $\nu$  denote, respectively, the least and the greatest fixed point of the functional defined as  $X \mapsto \phi(X)$ . Since the operations  $\cup, \cap$ , and the set transformers  $\text{pre}$  are all monotonic, the fixed points are guaranteed to exist, due to the Knaster-Tarski Theorem [5]. We omit the (standard) semantics of formulas (see [18]).

A  $\mu$ -calculus formula evaluates to a set of vertices over  $G$ , and the set can be computed by induction over the structure of the formula, where the fixed points are evaluated by iteration. The reader may note that  $\text{pre}$  and  $\text{cpre}$  can be computed in time polynomial in number of vertices, and since the game graph is finite,  $\text{attr}$  is also computable in polynomial time.

## 4.2 Safety Games

A safety game is a game  $\mathcal{G} = (G, \Phi)$  with  $\Phi := \Box U$  for some  $U \subseteq V$ , and a play fulfills  $\Phi$  if it never leaves  $U$ . APAs for safety games disallow every *Player 1* move that leaves the cooperative winning region in  $G$  w.r.t.  $\text{Safety}(U)$ . This is formalized in the following theorem<sup>4</sup>.

**Theorem 1.** *Let  $\mathcal{G} = (G, \Box U)$  be a safety game,  $Z^* = \nu Y. U \cap \text{pre}(Y)$ , and  $S = \{(u, v) \in E \mid (u \in V^1 \cap Z^*) \wedge (v \notin Z^*)\}$ . Then  $Z^* = \langle\langle 0, 1 \rangle\rangle \Box U$  and<sup>5</sup>*

$$\Psi_{\text{UNSAFE}}(S) := \Box \bigwedge_{e \in S} \neg e, \quad (6)$$

is an APA for the game  $\mathcal{G}$ . We denote by  $\text{UNSAFEA}(G, U)$  the algorithm computing  $S$  as above, which runs in time  $\mathcal{O}(n^2)$ , where  $n = |V|$ .

We call the LTL formula in (6) a *safety template* and assumptions that solely use this template *safety assumptions*.

<sup>3</sup> In existing literature, usually  $U \subseteq \text{attr}^a(U)$ , i.e.,  $\text{attr}^a(U)$  contains vertices from which  $U$  is visited in zero steps. We exclude  $U$  from  $\text{attr}^a(U)$  for a minor technical reason.

<sup>4</sup> All proofs can be found in the appendix.

<sup>5</sup> We use  $e = (u, v)$  in LTL formulas as a syntactic sugar for  $u \wedge \bigcirc v$ , where  $\bigcirc$  is the LTL *next* operator. A set of edges  $E' = \{e_i\}_{i \in [0;k]}$ , when used as atomic proposition, is a syntactic sugar for  $\bigvee_{i \in [0;k]} e_i$ .

### 4.3 Live Group Assumptions for Büchi Games

**Büchi games.** A Büchi game is a game  $\mathcal{G} = (G, \Phi)$  where  $\Phi = \Box\Diamond U$  for some  $U \subseteq V$ . Intuitively, a play is winning for a Büchi game if it visits the vertex set  $U$  infinitely often. We first recall that the cooperative winning region  $\llbracket 0, 1 \rrbracket \Box\Diamond U$  can be computed by a two-nested symbolic fixpoint algorithm [10]

$$\text{BÜCHI}(G, U) := \nu Y. \mu X. (U \cap \text{pre}(Y)) \cup (\text{pre}(X)). \quad (7)$$

**Live group templates.** Given the standard algorithm in (7), the set  $X^i$  computed in the  $i$ -th iteration of the fixpoint variable  $X$  in the last iteration of  $Y$  actually carries a lot of information to construct a very useful assumption for the Büchi game  $\mathcal{G}$ . To see this, recall that  $X^i$  contains all vertices which have an edge to vertices which can reach  $U$  in at most  $i - 1$  steps [10, sec. 3.2]. Hence, for all *Player 1* vertices in  $X^i \setminus X^{i-1}$  we need to assume that *Player 1* always eventually makes progress towards  $U$  by moving to  $X^i$ . This can be formalized by a so called live group template.

**Definition 7.** Let  $G = (V, E)$  be a game graph. Then a live group  $H = \{e_j\}_{j \geq 0}$  is a set of edges  $e_j = (s_j, t_j)$  with source vertices  $\text{src}(H) := \{s_j\}_{j \geq 0}$ . Given a set of live groups  $H^\ell = \{H_i\}_{i \geq 0}$  we define a live group template as

$$\Psi_{\text{LIVE}}(H^\ell) := \bigwedge_{i \geq 0} \Box\Diamond \text{src}(H_i) \implies \Box\Diamond H_i. \quad (8)$$

The live group template says that if some vertex from the source of a live group is visited infinitely often, then some edge from this group should be taken infinitely often. We will use this template to give the assumptions for Büchi games.

*Remark 2.* We note that Chatterjee et al. [8] used *live edges* in their environment assumptions. Live edges are singleton live groups and are thereby less expressive. In particular, there are instances of Büchi games, where there is no permissive live edge assumption but there is a permissive live group assumption<sup>6</sup>. E.g., in Fig. 1 (c) the live edge assumption  $\Box\Diamond e_1 \wedge \Box\Diamond e_2$  is sufficient but not permissive, whereas the live group assumption  $\Box\Diamond \text{src}(H) \implies \Box\Diamond H$  with  $H = \{e_1, e_2\}$  is an APA.

In the context of the fixpoint computation of (7), we can construct live groups  $H^\ell = \{H_i\}_{i \geq 0}$  where each  $H_i$  contains all edges of *Player 1* which originate in  $X^i \setminus X^{i-1}$  and end in  $X^{i-1}$ . Then the live group assumption in (8) precisely captures the intuition that, in order to visit  $U$  infinitely often, *Player 1* should take edges in  $H_i$  infinitely often if vertices in  $\text{src}(H_i)$  are seen infinitely often. Unfortunately, it turns out that this live group assumption is not *permissive*. The reason is that it restricts *Player 1* also on those vertices from which he will anyway go towards  $U$ . For example, consider the game in Fig. 2 (right). Here defining live groups through computations of (10), will mark  $e_1$  as a live group,

<sup>6</sup> i.e., assumptions that use live group templates

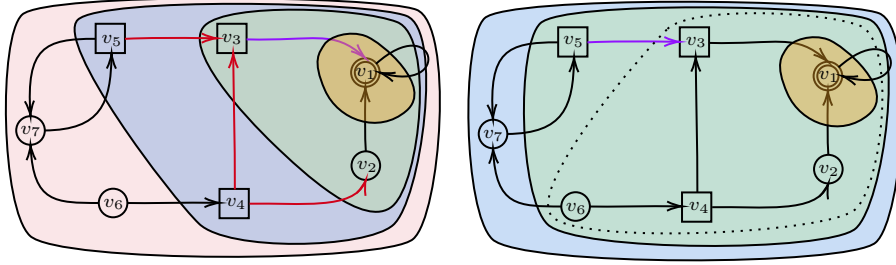

**Fig. 4:** Computation of  $\mu X. U \cup \text{pre}(X)$  (left) and  $\mu X. U \cup \text{tpre}(X)$  (right). Each colored region describes one iteration over  $X$ . The dotted region on the right is added by the  $\text{attr}$  part of  $\text{tpre}$ , and this allows only the vertex  $v_5$  to be in  $\text{front}(\{v_1\})$ . Each set of the same colored edges defines a live transition group.

but then  $(v_2 v_1 v_0)^\omega$  will be in  $\mathcal{L}(\Phi)$  but not in the language of the assumption. Here the permissive assumption would be  $\Psi = \text{TRUE}$ .

**Accelerated fixpoint computation.** In order to compute a permissive live group assumption, we use a slightly modified fixpoint algorithm which computes the same set  $Z^*$  but allows us to extract *permissive* assumptions directly from the fixpoint computations. Towards this goal, we introduce the *together predecessor operator*.

$$\text{tpre}_G(U) = \text{attr}_G^0(U) \cup \text{cpre}_G^1(\text{attr}_G^0(U) \cup U). \quad (9)$$

Intuitively,  $\text{tpre}$  adds all vertices from which *Player 0* does not need any cooperation to reach  $U$  in every iteration of the fixpoint computation. The interesting observation we make is that substituting the inner  $\text{pre}$  operator in (7) by  $\text{tpre}$  does not change the computed set but only accelerates the computation. This is formalized in the next proposition and visualized in Fig. 4.

**Proposition 1.** *Let  $\mathcal{G} = (G, \square \diamond U)$  be a Büchi game and*

$$\text{TBÜCHI}(G, U) = \nu Y. \mu X. (U \cap \text{pre}(Y)) \cup (\text{tpre}(X)). \quad (10)$$

*Then  $\text{TBÜCHI}(G, U) = \text{BÜCHI}(G, U) = \langle\langle 0, 1 \rangle\rangle \square \diamond U$ .*

Prop. 1 follows from the correctness proof of (7) by using the observation that for all  $U \subseteq V$  we have  $\mu X. U \cup \text{pre}(X) = \mu X. U \cup \text{tpre}(X)$  which is proven in the Appendix, Lem. 1.

**Computing live group assumptions.** Intuitively, the operator  $\text{tpre}_G$  computes the union of (i) the set of vertices from which *Player 0* can reach  $U$  in a finite number of steps with no cooperation from *Player 1* and (ii) the set of *Player 1* vertices from which *Player 0* can reach  $U$  with at most *one-time* cooperation from *Player 1*. Looking at Fig. 4, case (i) is indicated by the dotted line, while case (ii) corresponds to the last added *Player 1* vertex (e.g.,  $v_5$ ). Hence, we need to capture the cooperation needed by *Player 1* only from the vertices

added last, which we call the *frontier* of  $U$  in  $G$  and are formalized as follows:

$$\text{front}(U) := \text{tpre}_G(U) \setminus \text{attr}_G^0(U). \quad (11)$$

It is easy to see that, indeed  $\text{front}(U) \subseteq V^1$ , as whenever  $v \in \text{front}(U) \cap V^0$ , then it would have been the case that  $v \in \text{attr}_G^0(U)$  via (10).

Defining live groups based on frontiers instead of all elements in  $X^i$  indeed yields the desired permissive assumption for Büchi games. By observing that we additionally need to ensure that *Player* 1 never leaves the cooperative winning region by a simple safety assumption, we get the following result, which is the main contribution of this section and is proved in the appendix.

**Theorem 2.** *Let  $\mathcal{G} = (G = (V, E), \Phi = \square\Diamond U)$  be a Büchi game with  $Z^* = \text{TBÜCHI}(G, U)$  and  $H^\ell = \{H_i\}_{i \geq 0}$  s.t.*

$$\emptyset \neq H_i := (\text{front}(X^i) \times (X^{i+1} \setminus \text{front}(X^i))) \cap E, \quad (12)$$

where  $X^i$  is the set computed in the  $i$ -th iteration of the computation over  $X$  and in the last iteration of the computation over  $Y$  in  $\text{TBÜCHI}$ . Then  $\Psi = \Psi_{\text{UNSAFE}}(S) \wedge \Psi_{\text{LIVE}}(H^\ell)$  is an APA for  $\mathcal{G}$ , where  $S = \text{UNSAFEA}(G, U)$ . We write  $\text{LIVEA}(G, U)$  to denote the algorithm to construct live groups  $H^\ell$  as above, which runs in time  $\mathcal{O}(n^3)$ , where  $n = |V|$ .

In fact, there is a faster algorithm that runs in time linear in the size of the graph for computation of APAs for Büchi games, which we present in Appendix C.1. We chose to present the mu-calculus based algorithm here, because it provides more insights into the nature of live groups.

#### 4.4 Co-Liveness Assumptions in Co-Büchi Games

A co-Büchi game is the *dual* of a Büchi game, where a winning play should visit a designated set of vertices only finitely many times. Formally, a co-Büchi game is a tuple  $\mathcal{G} = (G, \Phi)$  where  $\Phi = \Diamond\square U$  for some  $U \subseteq V$ . The standard symbolic algorithm to compute the cooperative winning region is as follows:

$$\text{CoBÜCHI}(G, U) := \mu X. \nu Y. (U \cap \text{pre}(Y)) \cup (\text{pre}(X)). \quad (13)$$

As before, the sets  $X^i$  obtained in the  $i$ -th computation of  $X$  during the evaluation of (13) carry essential information for constructing assumptions. Intuitively,  $X^1$  gives precisely the set of vertices from which the play can stay in  $U$  with *Player* 1's cooperation and we would like an assumption to capture the fact that we do not want *Player* 1 to go further away from  $X^1$  infinitely often. This observation is naturally described by so called co-liveness templates.

**Definition 8.** *Let  $G = (V, E)$  be a game graph and  $D \subseteq V \times V$  a set of edges. Then a co-liveness template over  $G$  w.r.t.  $D$  is defined by the LTL formula*

$$\Psi_{\text{COLIVE}}(D) := \Diamond\square \bigwedge_{e \in D} \neg e. \quad (14)$$

The assumptions employing co-liveness templates will be called co-liveness assumptions. With this, we can state the main result of this section.

**Theorem 3.** *Let  $\mathcal{G} = (G = (V, E), \diamond \square U)$ ,  $Z^* = \text{CoBüCHI}(G, U)$  and*

$$D = \left( [(X^1 \cap V^1) \times (Z^* \setminus X^1)] \cup \left[ \bigcup_{i>1} (X^i \cap V^1) \times (Z^* \setminus X^{i-1}) \right] \right) \cap E, \quad (15)$$

where  $X^i$  is the set computed in the  $i$ -th iteration of fixpoint variable  $X$  in  $\text{CoBüCHI}$ . Then  $\Psi = \Psi_{\text{UNSAFE}}(S) \wedge \Psi_{\text{COLIVE}}(D)$  is an APA for  $\mathcal{G}$ , where  $S = \text{UNSAFEA}(G, U)$ . We write  $\text{COLIVEA}(G, U)$  to denote the algorithm constructing co-live edges  $D$  as above which runs in time  $\mathcal{O}(n^3)$ , where  $n = |V|$ .

We observe that  $X_1$  is a subset of  $U$  such that if a play reaches  $X^1$ , *Player 0* and *Player 1* can cooperatively keep the play in  $X^1$ . To do so, we ensure via the definition of  $D$  in (15) that *Player 1* can only leave  $X^1$  finitely often. Moreover, with the other co-live edges in  $D$ , we ensure that *Player 1* can only go away from  $X^1$  finitely often, and hence if *Player 0* plays their strategy to reach  $X^1$  and then stay there, the play will be winning. The permissiveness of the assumption comes from the observation that if co-liveness is violated, then *Player 1* takes a co-live edge infinitely often, and hence leaves  $X^1$  infinitely often, implying leaving  $U$  infinitely often. We refer the reader to the Appendix D for a formal proof of Theorem 3.

In the context of (13) the set

$$D = \left( [(X^1 \cap V^1) \times (Z^* \setminus X^1)] \cup \left[ \bigcup_{i>1} (X^i \cap V^1) \times (Z^* \setminus X^{i-1}) \right] \right) \cap E, \quad (16)$$

results in the desired co-live assumptions. We argued that this defines the adequately permissive assumption for co-Büchi games. However, utilizing the observation from Section 4.3 we can equivalently use the accelerated fixed-point algorithm resulting from replacing the pre-operator over  $X$  in (13) by the `tpre` operator. This again only accelerates the computation, as formalized in the following proposition and visualized in Fig. 5.

**Proposition 2.** *Let  $\mathcal{G} = (G, \diamond \square U)$  be a co-Büchi game and*

$$\text{TCoBüCHI}(G, U) = \mu X. \nu Y. (U \cap \text{pre}(Y)) \cup (\text{tpre}(X)). \quad (17)$$

Then  $\text{TCoBüCHI}(G, U) = \text{CoBüCHI}(G, U) = \langle\langle 0, 1 \rangle\rangle \diamond \square U$ .

When using the accelerated fixed-point algorithm, we can again restrict attention to *Player 1* vertices in the frontier of  $X^i$  for the construction of assumptions. In section 4.3, for Büchi game  $\text{Büchi}(U)$ , we introduced live groups to take the play towards  $U$ , whenever *Player 1* can. But for co-Büchi games, we need to restrict *Player 1* from going away from the region  $U_{\text{good}}$  where the play stays in  $U$ . This requires co-liveness assumption only over frontiers of  $X^i$ s, since any other vertex of *Player 1* added in  $X^{i+1}$  is added in the `attr0` part of `tpre`, and hence can not go away from  $U_{\text{good}}$  anyway. With this, we have the following main result of this section, for which we provide the proof in Appendix D.1.

**Theorem 4.** Let  $\mathcal{G} = (G = (V, E), \Phi = \diamond \square U)$  be a co-Büchi game with  $Z^* = \text{TCOBÜCHI}(G, U)$  and

$$D = \left( \bigcup_{i>1} (X^1 \cap V^1) \times (Z^* \setminus X^1) \cup \text{front}(X^i) \times (\text{front}(X^i) \cup Z^* \setminus X^{i+1}) \right) \cap E, \quad (18)$$

where  $X^i$  is the set computed in the  $i$ -th iteration of fixpoint variable  $X$ . Then  $\Psi = \Psi_{\text{UNSAFE}}(S) \wedge \Psi_{\text{COLIVE}}(D)$  is an APA for  $\mathcal{G}$ , where  $S = \text{UNSAFEA}(G, U)$ . Moreover,  $D$  can be constructed in time  $\mathcal{O}(n^3)$ , where  $n$  is the number of vertices.

In fact, there is again a faster algorithm that runs in time linear in size of the graph for computation of APAs for co-Büchi games, which we present in the Appendix D.2. We chose to present this version for the same reasons as for the Büchi games.

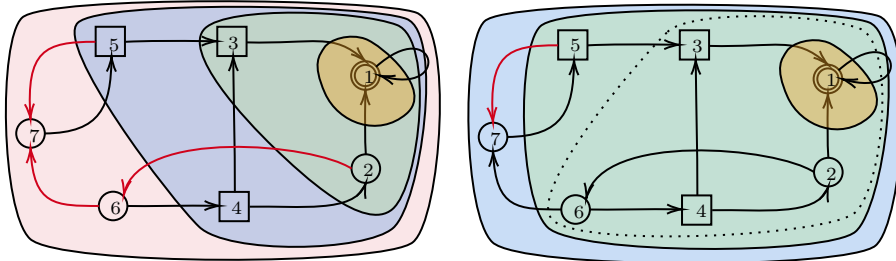

**Fig. 5:** Left picture describes co-Büchi computation with `pre`, and the right with `tpre`. Each colored region describes how  $X$  grows after every iteration, and the dotted region on the right is added by the `attr` part of `tpre`. The edges in `red` describe the co-live edges in both cases. Again `pre` computation would give assumptions on *Player 0* vertices, while that with `tpre` only gives assumptions on *Player 1*'s vertices.

#### 4.5 APA Assumptions for Parity Games

**Parity games.** Let  $G = (V, V^0, V^1, E)$  be a game graph, and  $C = \{C_0, \dots, C_k\}$  be a set of subsets of vertices which form a partition of  $V$ . Then the game  $\mathcal{G} = (G, \Phi)$  is called a *parity game* if

$$\Phi = \text{Parity}(C) := \bigvee_{i \in \text{odd}[0;k]} \square \diamond C_i \implies \bigvee_{j \in \text{even}[i+1;k]} \square \diamond C_j. \quad (19)$$

The set  $C$  is called the *priority set* and a vertex  $v$  in the set  $C_i$ , for  $i \in [1; k]$ , is said to have *priority*  $i$ . An infinite play  $\rho$  is winning for  $\Phi = \text{Parity}(C)$  if the highest priority appearing infinitely often along  $\rho$  is even.

**Conditional live group templates.** As seen in the previous sections, for games with simple winning conditions which require visiting a fixed set of edges infinitely often or only finitely often, a single assumption (conjoined with a simple safety assumption) suffices to characterize APAs, as there is just one way to win. However, in general parity games, there are usually multiple ways of winning: for example, in parity games with priorities  $\{0, 1, 2\}$ , a play will be winning if either (i) it only infinitely often sees vertices of priority 0, or (ii) it sees priority 1 infinitely often but also sees priority 2 infinitely often. Intuitively, winning option (i) requires the use of co-liveness assumptions as in Sec. 4.4. However, winning option (ii) actually requires the live group assumptions discussed in Sec. 4.3 to be *conditional* on whether certain states with priority 1 have actually been visited infinitely often. This is formalized by generalizing live group templates to *conditional live group templates*.

**Definition 9.** Let  $G = (V, V^0, V^1, E)$  be a game graph. Then a conditional live group over  $G$  is a pair  $(R, H^\ell)$ , where  $R \subseteq V$  and  $H^\ell$  is a live group. Given a set of conditional live groups  $\mathcal{H}^\ell$  we define a conditional live group template as the LTL formula

$$\Psi_{\text{COND}}(\mathcal{H}^\ell) := \bigwedge_{(R, H^\ell) \in \mathcal{H}^\ell} (\Box \Diamond R \implies \Psi_{\text{LIVE}}(H^\ell)). \quad (20)$$

Again, the assumptions employing conditional live group templates will be called conditional live group assumptions. With the generalization of live group assumptions to *conditional* live group assumptions, we actually have all the ingredients to define an APA for parity games as a conjunction

$$\Psi = \Psi_{\text{UNSAFE}}(S) \wedge \Psi_{\text{COLIVE}}(D) \wedge \Psi_{\text{COND}}(\mathcal{H}^\ell) \quad (21)$$

of a safety, a co-liveness, and a conditional live group assumptions. Intuitively, we use (i) a safety assumption to prevent *Player* 1 to leave the cooperative winning region, (ii) a co-live assumption for each winning option that requires seeing a particular *odd* priority only finitely often, and (iii) a conditional live group assumption for each winning option that requires seeing an *even* priority infinitely often if certain *odd* priority have been seen infinitely often. The remainder of this section gives an algorithm (Alg. 1) to compute the actual safety, co-live and conditional live group sets  $S$ ,  $D$  and  $\mathcal{H}^\ell$ , respectively, and proves that the resulting assumption  $\Psi$  (as in (21)) is actually an APA for the parity game  $\mathcal{G}$ .

**Computing APAs.** The computation of unsafe, co-live, and conditional live group sets  $S$ ,  $D$ , and  $\mathcal{H}^\ell$  to make  $\Psi$  in (21) an APA is formalized in Alg. 1. Alg. 1 utilizes the standard fixpoint algorithm  $\text{PARITY}(G, C)$  [12] to compute the cooperative winning region for a parity game  $\mathcal{G}$ , defined as

$$\text{PARITY}(G, C) := \tau X_d \cdots \nu X_2 \mu X_1 \nu X_0 \cdot \bigcup_{i \in [0, d]} (C_i \cap \text{pre}(X_i)), \quad (22)$$

where  $\tau$  is  $\nu$  if  $d$  is even, and  $\mu$  otherwise. In addition, Alg. 1 involves the algorithms UNSAFE (Thm. 1), LIVE (Thm. 2), and COLIVE (Thm. 3) to compute safety, live group, and co-liveness assumptions in an iterative manner.

**Algorithm 1** PARITYASSUMPTION

---

**Input:**  $G = (V, E)$ ,  $C : V \rightarrow \{0, 1, \dots\}$   
**Output:**  $\Psi$

- 1:  $Z^* \leftarrow \text{PARITY}(G, C)$
- 2:  $S \leftarrow \text{UNSAFEA}(G, Z^*)$
- 3:  $G \leftarrow G|_{Z^*}$ ,  $C \leftarrow C|_{Z^*}$
- 4:  $(D, \mathcal{H}^\ell) \leftarrow \text{COMPUTESSETS}((G, C), \emptyset, \emptyset)$
- 5: **return**  $S, D, \mathcal{H}^\ell$

6: **procedure** COMPUTESSETS( $(G, C), D, \mathcal{H}^\ell$ )

- 7:  $d \leftarrow \max\{i \mid C_i \neq \emptyset\}$
- 8: **if**  $d$  is odd **then**
- 9:  $W_{-d} \leftarrow \text{PARITY}(G|_{V \setminus C_d}, C)$
- 10:  $D \leftarrow D \cup \text{COLIVEA}(G, W_{-d})$
- 11: **else**
- 12:  $W_d \leftarrow \text{BÜCHI}(G, C_d)$ ,  $W_{-d} \leftarrow V \setminus W_d$
- 13: **for all** odd  $i \in [0; d]$  **do**
- 14:  $\mathcal{H}^\ell \leftarrow \mathcal{H}^\ell \cup (W_d \cap C_i, \text{LIVEA}(G|_{W_d}, C_{i+1} \cup C_{i+3} \dots \cup C_d))$
- 15: **if**  $d > 0$  **then**
- 16:  $G \leftarrow G|_{W_{-d}}$ ,  $C_0 \leftarrow C_0 \cup C_d$ ,  $C_d \leftarrow \emptyset$
- 17:  $\text{COMPUTESSETS}((G, C), D, \mathcal{H}^\ell)$
- 18: **else**
- 19: **return**  $(D, \mathcal{H}^\ell)$

---

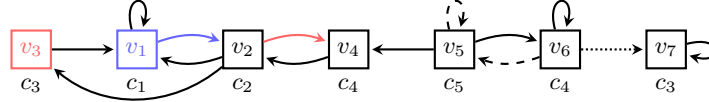

**Fig. 6:** A parity game, where a vertex with priority  $i$  has label  $c_i$ . The dotted edges are the unsafe edges, the dashed edges are the co-live edges, and every similarly colored vertex-edge pair forms a conditional live group.

In addition,  $G|_U := (U, U^0, U^1, E')$  s.t.  $U^0 := V^0 \cap U$ ,  $U^1 := V^1 \cap U$ , and  $E' := E \cap (U \times U)$  denotes the restriction of a game graph  $G := (V, V^0, V^1, E)$  to a subset of its vertices  $U \subseteq V$ . Further,  $C|_U$  denotes the restriction of the priority set  $C$  from  $V$  to  $U \subseteq V$ .

We illustrate the steps of Alg. 1 by an example depicted in Fig. 6. In line 1, we begin with computing the cooperative winning region  $Z^*$  of the entire game, to find that from vertex  $v_7$ , there is no way of satisfying the parity condition even with *Player 1*'s cooperation, i.e.,  $Z^* = \{v_1, \dots, v_6\}$ . So we mark the edge from  $v_6$  to  $v_7$  to be a safety-assumption edge, restrict the game to  $G = G|_{Z^*}$  and run COMPUTESSETS on the new game.

In the new restricted game  $G$  the highest priority is  $d = 5$ , which is odd, hence we execute lines 9-10. Now a play would be winning only if eventually the play does not see  $v_5$  any more. Hence, in step 9, we find the region  $W_{-5} = \{v_1, \dots, v_4, v_6\}$  of the restricted graph  $G|_{V \setminus C_5}$  (only containing nodes  $v_i$  with priority  $C(v_i) < 5$ ) from where we can satisfy the parity condition without seeing  $v_5$ . We then make sure that we do not leave  $W_{-5}$  to visit  $v_5$  in the game  $G$  infinitely often by executing COLIVEA( $G, W_{-5}$ ) in line 10. This puts a co-liveness assumption on the edges  $(v_5, v_5)$  and  $(v_6, v_5)$ .



Once we restrict a play from visiting  $v_5$  infinitely often, we only need to focus on satisfying parity without visiting  $v_5$  within  $W_{-5}$ . This observation allows us to further restrict our computation to the game  $\mathcal{G} = \mathcal{G}|_{W_{-5}}$  in line 16, where we also update the priorities to only range from 0 to 4. In our example this step does not change anything. We then re-execute COMPUTESETS on this game.

In the restricted graph, the highest priority is 4 which is even, hence we execute lines 12-14. One way of winning in this game is to visit  $C_4$  infinitely often, so we compute the respective cooperative winning region  $W_4$  in line 12. In our example we have  $W_4 = W_{-5} = \{v_1, \dots, v_4, v_6\}$ . Now, to ensure that from the vertices from which we can cooperatively see 4, we actually win, we have to make sure that every time a lower odd priority vertex is visited infinitely often, a higher priority is also visited. This can be ensured by conditional live group fairness as computed in line 14. For every odd priority  $i < 4$ , (i.e. for  $i = 1$  and  $i = 3$ ) we have to make sure that either 2 or 4 (if  $i = 1$ ) or 4 (if  $i = 3$ ) is visited infinitely often. The resulting live groups  $\mathcal{H}_i^\ell = (R_i, H_i^\ell)$  collect all vertices in  $W_4$  with priority  $i$  in  $R_i$  and all live groups allowing to see even priorities  $j$  with  $i < j \leq 4$  in  $H_i^\ell$ , where the latter is computed using the fixed-point algorithm LIVEA to compute live groups. The resulting live groups for  $i = 1$  (blue) and  $i = 3$  (red) are depicted in Fig. 6 and given by  $(\{v_1\}, \{(v_1, v_2)\})$  and  $(\{v_3\}, \{(v_2, v_4)\}, \{(v_1, v_2)\})$ , respectively.

At this point we have  $W_{-4} = \emptyset$ . With this the game graph computed in line 16 becomes empty, and the algorithm eventually terminates after iteratively removing all priorities from  $C$  after COMPUTESETS has been run (without any computations, as  $\mathcal{G}$  is empty) for priorities 3, 2 and 1. In a different game graph, the reasoning done for priorities 5 and 4 above can also repeat for lower priorities if there are other parts of the game graph not contained in  $W_4$ , from where the game can be won by seeing priority 2 infinitely often. The main insight into the correctness of the outlined algorithm is that all computed assumptions can be conjoined to obtain an APA for the original parity game.

**Main result.** With Alg. 1 in place, we can now state the main result of this section, and in particular, of the entire paper, proven in Appendix E.

**Theorem 5.** *Let  $\mathcal{G} = (G = (V, E), \text{Parity}(C))$  be a parity game such that  $(S, D, \mathcal{H}^\ell) = \text{PARITYASSUMPTION}(G, C)$ . Then  $\Psi = \Psi_{\text{UNSAFE}}(S) \wedge \Psi_{\text{COLIVE}}(D) \wedge \Psi_{\text{COND}}(\mathcal{H}^\ell)$  is an APA for  $\mathcal{G}$ . Moreover, Algo. 1 terminates in time  $\mathcal{O}(n^4)$ , where  $n = |V|$ .*

## 5 Experimental Evaluation

We have developed a C++-based prototype tool SIMPA<sup>7</sup> computing **S**ufficient, **I**mplementable and **P**ermissive **A**ssumptions for Büchi, co-Büchi, and parity games. We first compare SIMPA against the closest related tool GIST [9] in Sec. 5.1. We then show that SIMPA gives small and meaningful assumptions for the well-known 2-client arbiter synthesis problem from [22] in Sec. 5.2.

<sup>7</sup> Repository URL: <https://gitlab.mpi-sws.org/kmallik/simpa>

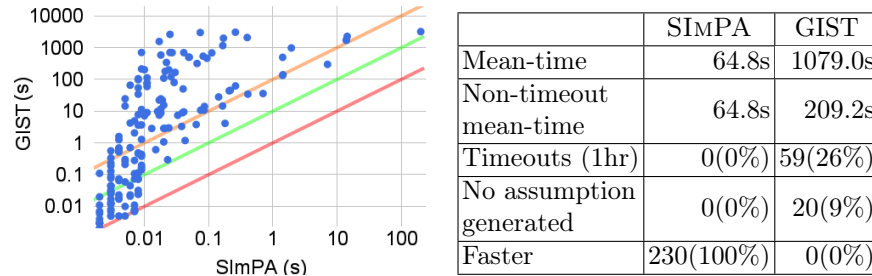

**Fig. 7:** Running times of SIMPA vs GIST (in seconds, log-scale) **Table 1:** Summary of the experimental results

### 5.1 Performance Evaluation

We compare the effectiveness of our tool against a re-implementation of the closest related tool called GIST [9], which is not available anymore from the authors<sup>8</sup>. GIST originally computes assumptions only enabling a particular initial vertex to become winning for *Player* 0. However, for the experiments, we run GIST until one of the cooperatively winning vertices is not winning anymore. Since GIST starts with a maximal assumption and keeps making it smaller until a fixed initial vertex is not winning anymore, our modification makes GIST faster as the modified termination condition is satisfied earlier. As our tool does not depend on any fixed initial vertex and the dependency on the initial vertex makes GIST slower, this modification allows a fair comparison.

We compared the performance and the quality of the assumptions computed by SIMPA and GIST on a set of parity games collected from the SYNTCOMP benchmark suite [2]. For computing assumptions using both SIMPA and GIST, we set a timeout of one hour. All the experiments were performed on a computer equipped with Intel(R) Core(TM) i5-10600T CPU @ 2.40GHz and 32 GiB RAM.

We provide all details of the experimental results in Table G in the appendix and summarize them in Table 1. In addition, Fig. 7 shows a scatter plot, where every instance of the benchmarks is depicted as a point, where the X and the Y coordinates represent the running time for SIMPA and GIST (in seconds), respectively. We see that SIMPA is computationally much faster than GIST in every instance (all dots lie above the lower red line) – most times by one (above the middle green line) and many times even two (above the upper orange line) orders of magnitude.

Moreover, in some experiments, GIST fails to compute a sufficient assumption (in the sense of Def. 2), whereas our algorithm successfully computes an APA (given in the row labeled ‘no assumption generated’ in Table 1 and marked using ‘\*’ next to the computation times in Table G). This is not surprising, as the class of assumptions used by GIST are only unsafe edges and live edges (i.e., singleton live groups) which are not expressive enough to provide sufficient

<sup>8</sup> The link provided in the paper is broken, and the authors informed us that the implementation is not available.

assumptions for all parity games (see Fig. 1(b) for a simple example where there is no sufficient assumption that can be expressed using live edges). Furthermore, we note that in all cases where the assumptions computed by GIST are actually APAs, SIMPA computes the same assumptions orders or magnitudes faster.

## 5.2 2-Client Arbiter Example

We consider the 2-client arbiter example from [22]. In this example, clients  $i \in \{1, 2\}$  (*Player 1*) can request or free a shared resource by setting the input variables  $r_i$  to true or false, and the arbiter (*Player 0*) can set the output variables  $g_i$  to true or false to grant or withdraw the shared resource to/from client  $i$ . The game graph for this example is implicitly given as part of the specification (as this is a GR(1) synthesis problem, see [22] for details). We depict a relevant part of this game graph schematically in Fig. 8. Here, rectangles and circles represent *Player 1* and *Player 0* vertices, respectively, and the double-lined vertices have priority 2 (are Büchi vertices), while all other vertices have priority 1. The labels of the *Player 0* states indicate the current status of the request and grant bits, and in addition, remember if a request is currently *pending*, i.e.,  $F_i = \overline{g_i} S(r_i \wedge \overline{g_i})$ , where  $S$  denotes the LTL operator “since”. Labels of *Player 1* vertices additionally remember the last move chosen by *Player 0*. We see that all vertices with no pending requests have priority 2. It is known that there does not exist a winning strategy in this game for *Player 0* if the moves of the clients (*Player 1*) are unconstrained.

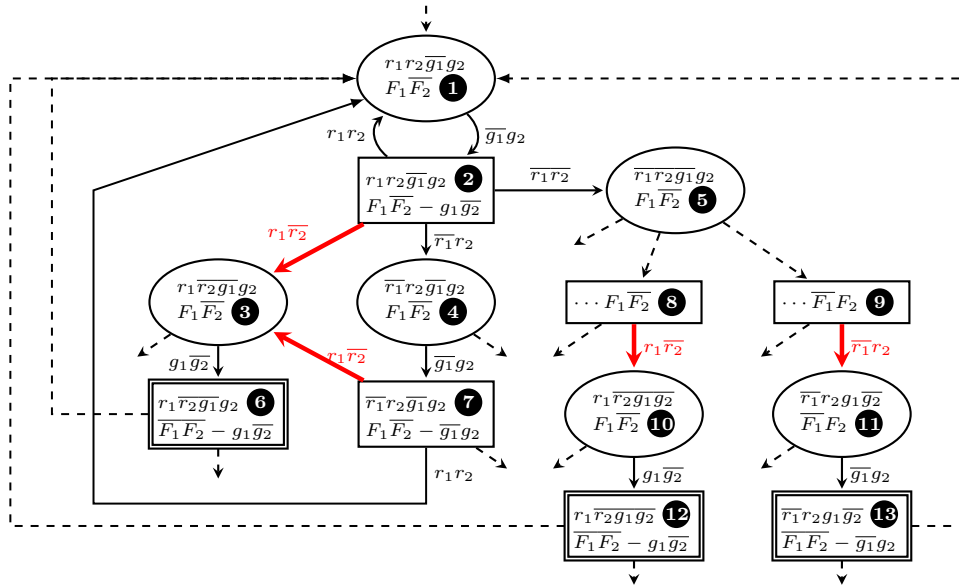

Fig. 8: Illustration of a relevant part of the game graph for the 2-client arbiter.

Running SIMPA on this example yields only live group assumptions (as this is a Büchi game and all vertices are cooperatively winning) which were computed

in 0.01 seconds. The edges of one live group are indicated schematically by thick red arrows in Fig. 8. We see that this live group ensures that the play eventually moves to vertices where the *Player 0* can force a visit to a Büchi vertex. In [22], the assumption used to restrict the clients' behavior in order to render the synthesis problem realizable is given by

$$\tilde{\Psi} = \bigwedge_i (\bar{r}_i \wedge \square((r_i \neq g_i) \Rightarrow (r_i = \bigcirc r_i)) \wedge \square((r_i \wedge g_i) \Rightarrow \diamond \bar{r}_i)).$$

We see that our live group assumptions are similar but more permissive. For example when we persistently see states with label  $r_1 \bar{g}_1$  and  $r_2 g_2$  (e.g., cycling through states **1** and **2** in Fig. 8) we enforce that *eventually* the edge labeled  $r_1 \bar{r}_2$  needs to be taken. On the other hand, the second and third condition in  $\tilde{\Psi}$  (which are triggered by  $r_1 \bar{g}_1$  and  $r_2 g_2$ , respectively) enforces that no other outgoing transition is allowed from state **2** except for the one labeled with  $r_1 \bar{r}_2$ , which is strictly more restrictive.

We have also run GIST on this example. It took 6.44 seconds to compute live edge assumptions for unrestricted initial conditions, which is two orders of magnitude slower than SIMPA. Further, in order to see **6** infinitely often GIST returns the live edges **2** – **3** and **7** – **1**. This assumption is not permissive, as there exist winning plays that do not use either of these edges infinitely often. It turns out that an APA for this example will unavoidably require live groups – singleton live edges, as computed by GIST, will not suffice.

**Acknowledgements** S. P. Nayak and A.-K. Schmuck are partially supported by the DFG project 389792660 TRR 248–CPEC. A. Anand and A.-K. Schmuck are partially supported by the DFG project SCHM 3541/1-1. K. Mallik is supported by the ERC project ERC-2020-AdG 101020093.

## References

1. Automata, Logics, and Infinite Games. Springer Berlin, Heidelberg, 10.1007/3-540-36387-4
2. The reactive synthesis competition. <http://www.syntcomp.org>
3. Baier, C., Katoen, J.P.: Principles of model checking. MIT press (2008)
4. Brenguier, R., Raskin, J.F., Sankur, O.: Assume-admissible synthesis. Acta Informatica (2017)
5. Bronislaw Knaster, A.T.: Un théorème sur les fonctions d'ensembles. Annales de la Société polonaise de mathématique **6** (1928)
6. Cavezza, D.G., Alrajeh, D., György, A.: Minimal assumptions refinement for realizable specifications. In: Formal Methods in Software Engineering (2020)
7. Chatterjee, K., Henzinger, T.A.: Assume-guarantee synthesis. In: TACAS (2007)
8. Chatterjee, K., Henzinger, T.A., Jobstmann, B.: Environment assumptions for synthesis. In: CONCUR (2008)
9. Chatterjee, K., Henzinger, T.A., Jobstmann, B., Radhakrishna, A.: Gist: A solver for probabilistic games. In: CAV (2010)
10. Chatterjee, K., Henzinger, T.A., Piterman, N.: Algorithms for büchi games (2008), <https://arxiv.org/abs/0805.2620>
11. Chatterjee, K., Horn, F., Löding, C.: Obliging games. In: International Conference on Concurrency Theory. pp. 284–296. Springer (2010)
12. Emerson, E., Jutla, C.: Tree automata,  $\mu$ -calculus and determinacy. In: FOCS (1991)
13. Finkbeiner, B., Metzger, N., Moses, Y.: Information flow guided synthesis. In: Proceedings of 34th International Conference on Computer Aided Verification (CAV 22) (2022)
14. Fisman, D., Kupferman, O., Lustig, Y.: Rational synthesis. In: TACAS (2010)
15. Gaaloul, K., Menghi, C., Nejati, S., Briand, L., Parache, Y.I.: Combining genetic programming and model checking to generate environment assumptions. TSE (2021)
16. Gaaloul, K., Menghi, C., Nejati, S., Briand, L.C., Wolfe, D.: Mining assumptions for software components using machine learning. In: ESEC/FSE (2020)
17. King, V., Kupferman, O., Vardi, M.Y.: On the complexity of parity word automata. In: Foundations of Software Science and Computation Structures. pp. 276–286. Springer Berlin Heidelberg (2001)
18. Kozen, D.: Results on the propositional  $\mu$ -calculus. In: ICALP. Springer (1982)
19. Majumdar, R., Mallik, K., Schmuck, A.K., Zufferey, D.: Assume-guarantee distributed synthesis. IEEE TCAD (2020)
20. Majumdar, R., Piterman, N., Schmuck, A.K.: Environmentally-friendly gr (1) synthesis. In: International Conference on Tools and Algorithms for the Construction and Analysis of Systems. pp. 229–246. Springer (2019)
21. Maoz, S., Ringert, J.O., Shalom, R.: Symbolic repairs for GR(1) specifications. In: ICSE (2019)
22. Piterman, N., Pnueli, A., Sa'ar, Y.: Synthesis of reactive(1) designs. In: Proceedings of the 7th International Conference on Verification, Model Checking, and Abstract Interpretation. p. 364–380. VMCAI'06, Springer-Verlag, Berlin, Heidelberg (2006)
23. Schmelter, D., Greenyer, J., Holtmann, J.: Toward learning realizable scenario-based, formal requirements specifications. In: REW (2017)

## A APA assumptions for safety games

For the convenience of the reader, we restate Thm. 1 here.

**Theorem 1.** *Let  $\mathcal{G} = (G, \Box U)$  be a safety game,  $Z^* = \nu Y.U \cap \text{pre}(Y)$ , and  $S = \{(u, v) \in E \mid (u \in V^1 \cap Z^*) \wedge (v \notin Z^*)\}$ . Then  $Z^* = \langle\langle 0, 1 \rangle\rangle \Box U$  and<sup>9</sup>*

$$\Psi_{\text{UNSAFE}}(S) := \Box \bigwedge_{e \in S} \neg e, \quad (6)$$

is an APA for the game  $\mathcal{G}$ . We denote by  $\text{UNSAFEA}(G, U)$  the algorithm computing  $S$  as above, which runs in time  $\mathcal{O}(n^2)$ , where  $n = |V|$ .

*Proof.* We refer the reader to [1, chapter 2] for the proof of  $Z^* = \langle\langle 0, 1 \rangle\rangle \Box U$ , and we show below that  $\Psi_{\text{UNSAFE}}(S)$  is a APA assumption for safety games by proving sufficiency, implementability and permissiveness below.

► **(ii) Implementability:** It is easy to observe that  $\Psi_{\text{UNSAFE}}(S)$  is implementable by *Player 1*, if he does not take the edges in  $S$  ever.

► **(ii) Sufficiency:** For sufficiency of the assumption, consider the strategy  $\pi^0$  for *Player 0*: at a vertex  $v \in Z^*$ , plays the transition that keeps the play in  $Z^*$ , and for other vertices, plays arbitrarily. The strategy is well-defined, since if at  $v \in Z^*$ , there is no such transition,  $v$  would not be in  $Z^*$ , by definition.

Let  $v_0 \in Z^* = \langle\langle 0, 1 \rangle\rangle \Box U$ . Let  $\pi^1$  be an arbitrary strategy of *Player 1* such that  $\mathcal{L}(\pi^1) \subseteq \mathcal{L}(\Psi_{\text{UNSAFE}}(S))$ , and  $\rho = v_0 v_1 \dots$  be an arbitrary  $\pi^0 \pi^1$ -play. Then  $\rho \in \mathcal{L}(\Psi_{\text{UNSAFE}}(S))$ .

Now, suppose  $\rho \notin \mathcal{L}(\Box U)$ , i.e.  $v_i \notin U$  for some  $i$ . WLOG assume that  $i$  is the least such index, that is, for all  $j < i$ ,  $v_j \in U$ . Then by definition of  $S$ ,  $(v_{i-1}, v_i) \in S$ , which is a contradiction. Hence,  $\rho \in \mathcal{L}(\Box U)$ .

► **(ii) Permissiveness:** Now for the permissiveness, let  $\rho \in \mathcal{L}(\Box U)$ . Suppose that  $\rho \notin \mathcal{L}(\Psi_{\text{UNSAFE}}(S))$ . Then some edge  $(v, v') \in S$  is taken in  $\rho$ . Then after reaching  $v'$ ,  $\rho$  still satisfies the safety condition. Hence, by Prop. 1,  $v' \in Z^*$ , but then  $(v, v') \notin S$ , which is a contradiction. Hence,  $\rho \in \mathcal{L}(\Psi_{\text{UNSAFE}}(S))$ .

► **Complexity analysis.** The fixpoint computation takes time  $\mathcal{O}(n^2)$  and then computing  $S$  takes another  $\mathcal{O}(n^2)$ .

## B tpre accelerates the $\mu$ -fixpoint computation

In sec. 4.3, we mentioned that Prop. 1 follows from the correctness proof of (7) (given in [10]) due to the following Lemma, which we prove here.

**Lemma 1.** *For  $U \subseteq V$ ,  $\mu X. U \cup \text{pre}(X) = \mu X. U \cup \text{tpre}(X)$ .*

*Proof.* Let  $\mu X. U \cup \text{pre}(X)$  gives the following computation of  $X$ , which we refer to as the *pre computation*,

<sup>9</sup> We use  $e = (u, v)$  in LTL formulas as a syntactic sugar for  $u \wedge \bigcirc v$ , where  $\bigcirc$  is the LTL *next* operator. A set of edges  $E' = \{e_i\}_{i \in [0; k]}$ , when used as atomic proposition, is a syntactic sugar for  $\bigvee_{i \in [0; k]} e_i$ .

$$\begin{array}{ccccccc}
 X_0 & \subseteq & X_1 & \subseteq & \cdots & X_k & = & X_{k+1} \\
 \parallel & & \parallel & & & \parallel & & \parallel \\
 \emptyset & & U \cup \text{pre}(X_0) & & \cdots & X_{k-1} \cup \text{pre}(X_{k-1}) & & X_k \cup \text{pre}(X_k)
 \end{array}$$

and similarly let  $\mu X. U \cup \text{tpre}(X)$  gives the following computation of  $X$ , which we refer to as the *tpre computation*,

$$\begin{array}{ccccccc}
 X_0^\dagger & \subseteq & X_1^\dagger & \subseteq & \cdots & X_l^\dagger & = & X_{l+1}^\dagger \\
 \parallel & & \parallel & & & \parallel & & \parallel \\
 \emptyset & & U \cup \text{tpre}(X_0^\dagger) & & \cdots & X_{l-1}^\dagger \cup \text{tpre}(X_{l-1}^\dagger) & & X_l^\dagger \cup \text{tpre}(X_l^\dagger)
 \end{array}$$

We first observe that  $\text{tpre}$  of a set contains the  $\text{pre}$  of the set.

*Claim.* For  $U \subseteq V$ ,  $\text{pre}(U) \subseteq \text{tpre}(U)$ .

*Proof.* We know  $\text{cpre}^0(U) \subseteq \text{attr}^0(U)$  by the definition of  $\text{attr}$ , and  $\text{cpre}^1(U) \subseteq \text{cpre}^1(\text{attr}^0(U) \cup U)$  by the monotonicity of  $\text{cpre}^0$ . Then  $\text{pre}(U) = \text{cpre}^0(U) \cup \text{cpre}^1(U) \subseteq \text{attr}^0(U) \cup \text{cpre}^1(\text{attr}^0(U) \cup U) = \text{tpre}(U)$ .  $\triangleleft$

Now we show that every vertex that appears in the  $i$ -th iteration of the  $\text{pre}$  computation, also appears in the  $i$ -th iteration of  $\text{tpre}$  computation.

*Claim.*  $\forall i \in \mathbb{N}, X_i \subseteq X_i^\dagger$ .

*Proof.* We prove the claim by induction on  $i$ . For the base case, when  $i = 0$ , the statement is trivially true. For induction hypothesis (IH), assume that the statement holds for some  $i \in \mathbb{N}$ .

$$X_{i+1}^\dagger = \text{tpre}(X_i^\dagger) \cup X_i^\dagger \tag{23}$$

$$\supseteq \text{tpre}(X_i) \cup X_i, \quad \text{by IH and monotonicity of tpre} \tag{24}$$

$$\supseteq \text{pre}(X_i) \cup X_i, \quad \text{by the claim above} \tag{25}$$

$$= X_{i+1}, \tag{26}$$

Hence, by induction, the statement holds for any  $i \in \mathbb{N}$ .  $\triangleleft$

The claim show one direction of the lemma, that is  $\mu X. U \cup \text{pre}(X) \subseteq \mu X. U \cup \text{tpre}(X)$ . Both the claims above also give that  $l \leq k$ , where  $l$  and  $k$  are the terminating step of  $\text{tpre}$  and  $\text{pre}$  computations respectively. For the other direction, we show that every vertex that appears in the  $i$ -th iteration of  $\text{tpre}$  computation also eventually appears in the  $\text{pre}$  computation.

*Claim.*  $\forall i \in \mathbb{N}, \exists j \geq i$  such that  $X_i^\dagger \subseteq X_j$ .

*Proof.* We again prove the claim by induction on  $i$ . For base case, again the statement holds trivially with  $j = 0$ . Then for induction hypothesis (IH), assume that the statement holds for some  $i \in \mathbb{N}$ , with some  $j \geq i$ , that is  $X_i^{\dagger} \subseteq X_j$ .

Let  $v \in X_{i+1}^{\dagger} \setminus X_i^{\dagger}$  be an arbitrary vertex. Then  $v \in \text{attr}^0(X_i^{\dagger})$  or  $v \in \text{cpre}^1(\text{attr}^0(X_i^{\dagger}) \cup X_i^{\dagger})$ .

In the earlier case, when  $v \in \text{attr}^0(X_i^{\dagger})$ , we have

$$v \in \text{cpre}^{0,t}(X_i^{\dagger}), \quad \text{for some } p \in \mathbb{N} \quad (27)$$

$$\subseteq \text{cpre}^{0,p}(X_i^{\dagger}), \quad \text{by IH} \quad (28)$$

$$\subseteq \text{pre}^{0,p}(X_i^{\dagger}), \quad (29)$$

$$\subseteq X_{p+i}. \quad (30)$$

Then since  $\text{attr}^0(X_i^{\dagger})$  terminates in at most  $|V| = n$  many iterations, that is  $\cup_{i \geq 1}^n \text{cpre}_G^{a,i}(X_i^{\dagger}) = \text{attr}^0(X_i^{\dagger})$ , we have that  $\text{attr}^0(X_i^{\dagger}) \subseteq X_{n+i}$ . While in the later case, when  $v \in \text{cpre}^1(\text{attr}^0(X_i^{\dagger}) \cup X_i^{\dagger})$ , we have

$$v \in \text{cpre}^1(\text{attr}^0(X_i^{\dagger}) \cup X_i^{\dagger}), \quad (31)$$

$$\subseteq \text{cpre}^1(X_{n+i} \cup X_j), \quad \text{by IH and discussion above} \quad (32)$$

$$\subseteq \text{pre}(X_{\max\{n+i,j\}}), \quad (33)$$

$$\subseteq X_{\max\{n+i,j\}+1}. \quad (34)$$

Since  $i \leq p+i \leq \max\{n+i,j\}+1$ ,  $v \in X_{\max\{n+i,j\}+1}$ . Then by induction, the claim holds true.  $\triangleleft$

This claim shows that  $X_k = X_k^{\dagger}$ , since  $l \leq k$  and  $X_k^{\dagger} = X_l^{\dagger}$ . Hence the lemma is proved.

## C APA assumptions for Büchi games

For the convenience of the reader, we restate Thm. 2 here.

**Theorem 2.** *Let  $\mathcal{G} = (G = (V, E), \Phi = \square \diamond U)$  be a Büchi game with  $Z^* = \text{TBÜCHI}(G, U)$  and  $H^\ell = \{H_i\}_{i \geq 0}$  s.t.*

$$\emptyset \neq H_i := (\text{front}(X^i) \times (X^{i+1} \setminus \text{front}(X^i))) \cap E, \quad (12)$$

where  $X^i$  is the set computed in the  $i$ -th iteration of the computation over  $X$  and in the last iteration of the computation over  $Y$  in TBÜCHI. Then  $\Psi = \Psi_{\text{UNSAFE}}(S) \wedge \Psi_{\text{LIVE}}(H^\ell)$  is an APA for  $\mathcal{G}$ , where  $S = \text{UNSAFEA}(G, U)$ . We write  $\text{LIVEA}(G, U)$  to denote the algorithm to construct live groups  $H^\ell$  as above, which runs in time  $\mathcal{O}(n^3)$ , where  $n = |V|$ .

*Proof.* Since  $\text{front}(X^i) \subseteq V^1$ , we observe that every vertex in  $Z^* \cap V^0$  is added to the least fixpoint computation of  $X$  in the  $\text{attr}^0$  part of  $\text{tpre}$ . Then  $V^0 \cap Z^*$  can be partitioned into sets  $V_1, V_2, \dots, V_p$ , where  $V_i = (X^i \setminus X^{i-1}) \cap V^0$ . With



this observation we prove sufficiency, implementability and permissiveness below and finally comment on the complexity of UNSAFEA.

► **Implementability:** Since the source of live groups is a subset of *Player 1*'s vertices, the assumption is easily implementable if *Player 1* plays one of these live group edges infinitely often, when the sources are visited infinitely often, and *Player 0* can not falsify it.

► **Sufficiency:** Consider the strategy  $\pi^0$  for *Player 0*: at a vertex  $v \in V_i$ , she plays the  $\text{attr}^0$  strategy to reach  $X^{i-1}$ , and for other vertices, she plays arbitrarily. We show that  $\pi^0$  is winning under assumption  $\Psi$  for all vertices in the cooperative winning region.

Let  $v_0 \in Z^* = \langle\langle 0, 1 \rangle\rangle \square \diamond U$  (from Prop. 1). Let  $\pi^1$  be an arbitrary strategy of *Player 1* such that  $\mathcal{L}(\pi^1) \subseteq \mathcal{L}(\Psi)$ , and  $\rho = v_0 v_1 \dots$  be an arbitrary  $\pi^0 \pi^1$ -play. Then  $\rho \in \mathcal{L}(\Psi)$ . It remains to show that  $\rho \in \mathcal{L}(\Phi)$ .

Suppose  $\rho \notin \mathcal{L}(\Phi)$ , i.e.  $\text{inf}(\rho) \cap U = \emptyset$ . Let  $Y$  saturate after  $k$  iterations, that is  $Y^{k-1} \supseteq Y^k = Y^{k+1}$ . Note that by standard fixed-point computations (see [10] for more details), we have

$$X^1 = (U \cap \text{tpre}(Y^k)) = (U \cap \text{tpre}(Z^*)). \quad (35)$$

Then  $\exists i \in [2, p]$ , such that  $\text{inf}(\rho) \cap X^i \neq \emptyset$  but  $\text{inf}(\rho) \cap X^j = \emptyset$ ,  $\forall j < i$ , since if there is no such  $i$ ,  $\text{inf}(\rho) \cap X^1 \neq \emptyset$ , and  $\text{inf}(\rho) \cap U \neq \emptyset$ , by eq. (35), contradicting our assumption.

By the definition of  $\pi^0$  and  $\text{attr}^0$ , every time  $\rho$  visits  $X^i \setminus \text{front}(X^{i-1})$ , it also eventually visits  $X^{i-1}$ . If  $\rho$  visits  $\text{front}(X^{i-1})$  infinitely often, by the definition of  $H^\ell$ , an edge  $(v, v') \in (\text{front}(X^{i-1}) \times (X^i \setminus \text{front}(X^{i-1}))) \cap E$  is taken infinitely often, where  $v' \in (X^i \setminus \text{front}(X^{i-1})) = \text{attr}^0(X^{i-1}) \cup X^{i-1}$ , and hence again  $X^{i-1}$  is visited infinitely often, contradicting our assumption. Hence,  $\rho \in \mathcal{L}(\Phi)$ , and  $v_0 \in \langle\langle 0 \rangle\rangle_\Psi \Phi$ .

► **Permissiveness:** Now for the permissiveness of the assumption, let  $\rho \in \mathcal{L}(\Phi)$ . Suppose that  $\rho \notin \mathcal{L}(\Psi)$ .

Case 1: If  $\rho \notin \mathcal{L}(\Psi_{\text{UNSAFE}}(S))$ , then some edge  $(v, v') \in S$  is taken in  $\rho$ . Then after reaching  $v'$ ,  $\rho$  still satisfies the Büchi condition. Hence, by Prop. 1,  $v' \in Z^*$ , but then  $(v, v') \notin S$ , which is a contradiction.

Case 2: If  $\rho \notin \mathcal{L}(\Psi_{\text{LIVE}}(H^\ell))$ , then  $\exists H_i \in H^\ell$ , such that  $\rho$  visits  $\text{src}(H_i) = \text{front}(X^i)$  infinitely often, but no edge in  $H_i$  is taken infinitely often. Then since the edges in  $H_i$  lead to  $(X^{i+1} \setminus \text{front}(X^i))$ , the play must stay in either  $\text{front}(X^i)$  or goes to  $X^j \setminus X^i$  for some  $j > i+1$ . In the first case, since  $U \cap Z^* \subseteq X^1$ ,  $\rho \notin \Phi$ , which would be a contradiction. On the other hand, in the second case, after going to  $X^j$ ,  $\rho$  has an edge going from some  $v \in Z^* \setminus X^{j-1}$  to some  $v' \in X^i$  (else  $U \cap Z^* \subseteq X^1 \subseteq X^i$  can not be reached). But then  $v$  would be added to  $X^{i+1}$ , which contradicts to the fact that  $j > i+1$ . In either case, we get a contradiction, so  $\rho \in \mathcal{L}(\Psi)$ .

► **Complexity analysis.** The computation of live groups takes  $\mathcal{O}(n^2)$  time to compute the inner least fixpoint variable  $X$  and there will be at most  $n$  such computations. While the inner fixpoint is being computed, in the last iteration of  $Y$ , with additive overhead of  $\mathcal{O}(n^2)$ , the live groups can be computed. Then the total computation time is  $\mathcal{O}(n^3)$ .

### C.1 Faster algorithm for Büchi games

---

**Algorithm 2** LIVEA
 

---

**Input:**  $G = (V = V^0 \cup V^1, E)$ , Büchi objective  $\Phi = \Box\Diamond I$ , for  $I \subseteq V$

**Output:** Assumption  $\Psi$  on *Player 1*

```

1:  $Z^* \leftarrow \text{BÜCHI}_{0,1}(G, I)$ 
2:  $(S^i, S^j) \leftarrow \text{UNSAFEA}(G, Z^*)$ 
3:  $G \leftarrow G|_{Z^*}, I \leftarrow I \cap Z^*$  ▷ All vertices are cooperatively Büchi winning
4:  $H^\ell \leftarrow \text{COMPUTELIVEGROUPS}((G, I), \emptyset)$ 
5: return  $(S, H^\ell)$ 

6: procedure COMPUTELIVEGROUPS( $(G, I), H^\ell$ )
7:    $U \leftarrow I$ 
8:   while  $U \neq V$  do
9:      $W_{attr} \leftarrow \text{attr}_G^0(G, U)$ 
10:     $U \leftarrow U \cup W_{attr}$ 
11:     $C \leftarrow \text{cpre}_G^1(U) \setminus U$ 
12:     $H^\ell \leftarrow H^\ell \cup \{(u, v) \in E \cap (C \times U)\}$ 
13:     $U \leftarrow U \cup C$ 
14:  return  $(H^\ell)$ 

```

---

**Theorem 6.** *Given a game graph  $G = (V = V^0 \cup V^1, E)$ , with Büchi winning condition  $\Phi = \Box\Diamond I$  for *Player 0*. Then Alg. 2 terminates in time  $\mathcal{O}(m+n)$ , and  $\Psi = \Psi_{\text{UNSAFE}}(S) \wedge \Psi_{\text{LIVE}}(H^\ell)$  is an adequately permissive assumption on *Player 1* from  $Z^*$ . Here,  $n = |V|$  and  $m = |E|$ .*

*Proof.* We first show that the algorithm terminates. We show that the procedure COMPUTELIVEGROUPS terminates. Since in step 3, the game graph is restricted to cooperative Büchi winning region  $Z^*$ , we need to show that in the procedure,  $U = V = Z^*$  eventually. Let  $U_l$  be the value of  $U$  after the  $l$ -th iteration of COMPUTELIVEGROUPS( $(G, I), \emptyset, \emptyset$ ), with  $U^0 = I$ . Since vertices are only added to  $U$  (and never removed) and there are only finitely many vertices,  $U_0 \subset U_1 \subset \dots \subset U_m = U_{m+1}$  for some  $m \in \mathbb{N}$ .

Since the other direction is trivial, we show that  $Z^* \subseteq U_m$ . Suppose this is not the case, i.e.  $v \in Z^* \setminus U_m$ . Since  $v \in Z^*$ , both players cooperatively can visit  $I$  from  $v$ . Then there is a finite path  $\mathbf{p} = v_0 v_1 \dots v_k$  for  $v_k \in I$  and  $v_0 = v$ . But since  $I = U_0 \subseteq U_m$ , but  $v \notin U_m$ ,  $\mathbf{p}$  enters  $U_m$  eventually. Let  $l$  be the highest index such that  $v_l \notin U_m$  but  $v_{l+1} \in U_m$ .

Then if  $v_l \in V^0$ , it would be added to  $U$  in step 10 of  $(m+1)$ -th iteration, i.e.  $U_m \neq U_{m+1}$ . Else if  $v_l \in V^1$ , it would be added to  $U$  in step 13 of  $(m+1)$ -th iteration since  $v_{l+1} \in U_m$ , i.e.  $U_m \neq U_{m+1}$ . In either case, we get a contradiction. Hence,  $v \in U_m$ , implying  $Z^* = U_m$ . Hence the procedure COMPUTELIVEGROUPS, and hence the Algo. 2, terminates.

We now show that the assumption obtained is adequately permissive.

► **Implementability:** We note that in step 11,  $C \subseteq V^1$ : since if  $v \in V^0 \cap C$ , then there is an edge from  $v$  to  $U$ , and hence  $v \in U$  already by steps 9 and 10. Then since the source of live groups (which are only added in step 12) is a subset of *Player 1*'s vertices, the assumption is easily implementable if *Player 1* plays one of these live group edges infinitely often, when the sources are visited infinitely often, and *Player 0* can not falsify it.

► **Sufficiency:** Again, let  $U_l$  and  $m$  be as defined earlier. Define  $X_l := U_l \setminus U_{l-1}$  for  $1 \leq l \leq m$ , and  $X_0 = U_0 = I$ . Then every vertex  $v \in Z^*$  is in  $X_l$  for some  $l \in [0; m]$ .

Consider the strategy  $\pi^0$  for *Player 0*: at a vertex  $v \in V_0 \cap X_l$ , she plays the  $\text{attr}^0$  strategy to reach  $U_{l-1}$ , and for other vertices, she plays arbitrarily. We show that  $\pi^0$  is winning under assumption  $\Psi$  for *Player 0* from all vertices in the cooperative winning region  $Z^*$ .

Let  $v_0 \in Z^* = \langle\langle 0, 1 \rangle\rangle \square \diamond I$  (from Step 1). Let  $\pi^1$  be an arbitrary strategy of *Player 1* such that  $\mathcal{L}(\pi^1) \subseteq \mathcal{L}(\Psi)$ , and  $\rho = v_0 v_1 \dots$  be an arbitrary  $\pi^0 \pi^1$ -play. Then  $\rho \in \mathcal{L}(\Psi)$ . It remains to show that  $\rho \in \mathcal{L}(\Phi)$ .

Suppose  $\rho \notin \mathcal{L}(\Phi)$ , i.e.  $\text{inf}(\rho) \cap I = \emptyset$ . Note that  $\rho$  never leaves  $Z^*$  due to safety assumption template. Then consider the set  $R$  of vertices which occur infinitely often in  $\rho$ . Let  $0 \leq k \leq m$  be the least index such that  $R \cap X_k \neq \emptyset$ . From the assumption,  $k > 0$ . Let  $v \in R \cap X_k$ .

If  $v \in V^0$ , by the definition of  $\pi^0$ , every time  $\rho$  reaches  $v$ , it must reach  $U_{k-1}$ , contradicting the minimality of  $k$ . Else if  $v \in V^1$ , then by the definition of  $H^\ell$ , infinitely often reaching  $v$  implies infinitely often reaching  $\text{attr}_0(U_{k-1})$ . But again the play visits  $U_{k-1}$  by arguments above, giving the contradiction.

In any case, we get a contradiction, implying that the assumption is wrong. Hence,  $\rho \in \mathcal{L}(\Phi)$ , and  $v_0 \in \langle\langle 0 \rangle\rangle_\Psi \Phi$ .

► **Permissiveness:** Now for the permissiveness of the assumption, let  $\rho \in \mathcal{L}(\Phi)$ . Suppose that  $\rho \notin \mathcal{L}(\Psi)$ .

Case 1: If  $\rho \notin \mathcal{L}(\Psi_{\text{UNSAFE}}(S))$ , then some edge  $(v, v') \in S$  is taken in  $\rho$ . Then after reaching  $v'$ ,  $\rho$  still satisfies the Büchi condition. Hence,  $v' \in Z^* = \langle\langle 0, 1 \rangle\rangle \square \diamond I$ , but then  $(v, v') \notin S$ , which is a contradiction.

Case 2: If  $\rho \notin \mathcal{L}(\Psi_{\text{LIVE}}(H^\ell))$ , then  $\exists H_i \in H^\ell$ , such that  $\rho$  visits  $\text{src}(H_i) = C_l$  (for the value of  $C$  after  $l$ -th iteration) infinitely often, but no edge in  $H_i$  is taken infinitely often. Then since the edges in  $H_i$  lead to  $\text{attr}^0(U_{l-1})$ , the play must stay in either  $C_l$  or goes to  $U^k \setminus U^l$  for some  $k > l + 1$ . In the first case, since  $I \cap Z^* \subseteq U^0$ ,  $\rho \notin \Phi$ , which would be a contradiction. On the other hand, in the second case, after going to  $U^k \setminus U^l$ ,  $\rho$  has an edge going from some  $v \in Z^* \setminus U^{k-1}$  to some  $v' \in U^l$  (else  $I \cap Z^* \subseteq U^0 \subseteq U^l$  can not be reached). But then  $v$  would be added to  $U^{k+1}$ , which contradicts to the fact that  $k > l + 1$ . In either case, we get a contradiction, so  $\rho \in \mathcal{L}(\Psi)$ .

► **Complexity analysis.** The computation of cooperative winning region can be done in time linear in size of the game graph, i.e.  $\mathcal{O}(m + n)$ . The procedure COMPUTELIVEGROUPS takes  $\mathcal{O}(m + n)$  time. Hence, resulting in time linear in number of edges in the game graph.

## D APA Assumptions for co-Büchi games

For the convenience of the reader, we restate Thm. 3 here.

**Theorem 3.** *Let  $\mathcal{G} = (G = (V, E), \diamond\Box U)$ ,  $Z^* = \text{CoBüchi}(G, U)$  and*

$$D = ( [(X^1 \cap V^1) \times (Z^* \setminus X^1)] \cup [\bigcup_{i>1} (X^i \cap V^1) \times (Z^* \setminus X^{i-1})] ) \cap E, \quad (15)$$

where  $X^i$  is the set computed in the  $i$ -th iteration of fixpoint variable  $X$  in  $\text{CoBüchi}$ . Then  $\Psi = \Psi_{\text{UNSAFE}}(S) \wedge \Psi_{\text{COLIVE}}(D)$  is an APA for  $\mathcal{G}$ , where  $S = \text{UNSAFEA}(G, U)$ . We write  $\text{COLIVEA}(G, U)$  to denote the algorithm constructing co-live edges  $D$  as above which runs in time  $\mathcal{O}(n^3)$ , where  $n = |V|$ .

*Proof.* We note that  $V^0 \cap Z^*$  can be partitioned into sets  $V_1, V_2, \dots, V_p$ , where  $V_i = (X^i \setminus X^{i-1}) \cap V^0$ . We say  $v \in Z^*$  has *rank*  $i$  if  $v \in X^i \setminus X^{i-1}$ .

► **Implementability:** We again observe that the sources of the co-live edges are *Player 1*'s vertices and by construction, each source has at least one alternative edge that is neither co-live nor unsafe. Hence, they can be easily implemented by *Player 1*, by taking the co-live edges only finitely often. We again prove sufficiency, implementability and permissiveness next and finally comment on the complexity of  $\text{COLIVEA}$ .

► **Sufficiency:** Consider the following strategy  $\pi^0$  for *Player 0*: at a vertex  $v \in V_1$ , she takes edge  $(v, v') \in E$  such that  $v' \in X^1$ , at a vertex  $v \in V_i$ , for  $i \in [2; p]$ , she plays the existing edge to reach  $X^{i-1}$ , and for all other vertices, she plays arbitrarily.

Let  $v_0 \in Z^* = \langle\langle 0, 1 \rangle\rangle \diamond\Box U$ , by correctness of the fixpoint (see [1, chapter 2]). Let  $\pi^1$  be an arbitrary strategy of *Player 1* such that  $\mathcal{L}(\pi^1) \subseteq \mathcal{L}(\Psi)$ , and  $\rho = v_0 v_1 \dots$  be an arbitrary  $\pi^0 \pi^1$ -play. Then  $\rho \in \mathcal{L}(\Psi)$ .

Since  $\rho \in \mathcal{L}(\Psi_{\text{UNSAFE}}(S))$ ,  $v_i \in Z^*$  for all  $i$ . Now suppose  $\rho \notin \mathcal{L}(\Phi)$ , i.e.  $\text{inf}(\rho) \cap (Z^* \setminus U) \neq \emptyset$ . Let  $u \in Z^* \setminus U$ . Then to reach  $u$  infinitely often some edge from  $D$  must be taken infinitely often in  $\rho$ , which contradicts the fact that  $\rho \in \mathcal{L}(\Psi)$ . Hence,  $\rho \in \mathcal{L}(\Phi)$ .

► **Permissiveness:** Let  $\rho = v_0 v_1 \dots$  such that  $v_0 \in Z^*$  and  $\rho \in \mathcal{L}(\Phi)$ . Suppose that  $\rho \notin \mathcal{L}(\Psi)$ .

Case 1: If  $\rho \notin \Psi_{\text{UNSAFE}}(S)$ . Then the same argument as in the Büchi case gives a contradiction.

Case 2: If  $\rho \notin \Psi_{\text{COLIVE}}(D)$ , that is  $\exists (u, v) \in D$ , such that  $\rho$  takes  $(u, v)$  infinitely often. By the definition of  $D$ ,  $v \in Z^* \setminus X^1$ , implying  $v \notin U$ , since if  $v \in U$  then it would have been in  $X^1$  (see [1]). Hence,  $\rho \notin \mathcal{L}(\Phi)$ , giving a contradiction. So  $\rho \in \mathcal{L}(\Psi)$ .

► **Complexity analysis.** Very similar to that for live group assumptions and therefore omitted.

### D.1 Accelerated fix-point algorithm for co-Büchi

We now prove the correctness of the accelerated fix-point algorithm.

**Theorem 4.** Let  $\mathcal{G} = (G = (V, E), \Phi = \diamond \square U)$  be a co-Büchi game with  $Z^* = \text{TCoBüchi}(G, U)$  and

$$D = \left( \bigcup_{i>1} \left( (X^1 \cap V^1) \times (Z^* \setminus X^1) \cup \text{front}(X^i) \times (\text{front}(X^i) \cup Z^* \setminus X^{i+1}) \right) \right) \cap E, \quad (18)$$

where  $X^i$  is the set computed in the  $i$ -th iteration of fixpoint variable  $X$ . Then  $\Psi = \Psi_{\text{UNSAFE}}(S) \wedge \Psi_{\text{COLIVE}}(D)$  is an APA for  $\mathcal{G}$ , where  $S = \text{UNSAFEA}(G, U)$ . Moreover,  $D$  can be constructed in time  $\mathcal{O}(n^3)$ , where  $n$  is the number of vertices.

*Proof.* Analogous to the Büchi case, every vertex in  $Z^* \cap V^0$  is added to the least fixpoint computation of  $X$  in the  $\text{attr}^0$  part of  $\text{tpre}$ , and  $V^0 \cap Z^*$  can be partitioned into sets  $V_1, V_2, \dots, V_p$ , where  $V_i = (X^i \setminus X^{i-1}) \cap V^0$ . We say  $v \in Z^*$  has rank  $i$  if  $v \in X^i \setminus X^{i-1}$ .

Consider the strategy  $\pi^0$  for *Player 0*: at a vertex  $v \in V_1$ , takes edge  $(v, v') \in E$  such that  $v' \in X^1$ , at a vertex  $v \in V_i$ , for  $i \in [2; p]$ , plays the  $\text{attr}^0$  strategy to reach  $X^{i-1}$ , and for other vertices, plays arbitrarily.

Let  $v_0 \in Z^* = \langle\langle 0, 1 \rangle\rangle U$ , by application of Prop. 2. Let  $\pi^1$  be an arbitrary strategy of *Player 1* such that  $\mathcal{L}(\pi^1) \subseteq \mathcal{L}(\Psi)$ , and  $\rho = v_0 v_1 \dots$  be an arbitrary  $\pi^0 \pi^1$ -play. Then  $\rho \in \mathcal{L}(\Psi)$ .

Since  $\rho \in \mathcal{L}(\Psi_{\text{UNSAFE}}(S))$ ,  $v_i \in Z^*$  for all  $i$ . Now suppose  $\rho \notin \mathcal{L}(\Phi)$ , i.e.  $\text{inf}(\rho) \cap (Z^* \setminus U) \neq \emptyset$ . Let  $u \in Z^* \setminus U$ . Then to reach  $u$  infinitely often some edge from  $D$  must be taken infinitely often in  $\rho$ , which contradicts the fact that  $\rho \in \mathcal{L}(\Psi)$ . Hence,  $\rho \in \mathcal{L}(\Phi)$ .

Now we show the permissiveness of the assumption. Let  $\rho = v_0 v_1 \dots$  such that  $v_0 \in Z^*$  and  $\rho \in \mathcal{L}(\Phi)$ . Suppose that  $\rho \notin \mathcal{L}(\Psi)$ .

Case 1: If  $\rho \notin \Psi_{\text{UNSAFE}}(S)$ . Then the same argument as in the Büchi case gives a contradiction.

Case 2: If  $\rho \notin \Psi_{\text{COLIVE}}(D)$ , that is  $\exists (u, v) \in D$ , such that  $\rho$  takes  $(u, v)$  infinitely often. By the definition of  $D$ ,  $v \in Z^* \setminus X^1$ , implying  $v \notin U$ , since if  $v \in U$  then it would have been in  $X^1$  (see [1]). Hence,  $\rho \notin \mathcal{L}(\Phi)$ , giving a contradiction. So  $\rho \in \mathcal{L}(\Psi)$ .

We again observe that the sources of the co-live edges are *Player 1*'s vertices and by construction, each source has at least one alternative edge that is neither co-live nor unsafe. Hence, they can be easily implemented by *Player 1*, by taking those edges only finitely often.

The complexity analysis is similar to that for live group assumptions.

## D.2 Faster algorithm for co-Büchi games

---

**Algorithm 3** COLIVEA
 

---

**Input:**  $G = (V = V^0 \cup V^1, E), I \subseteq V$ 
**Output:** Assumption  $\Psi$  on *Player 1*

```

1:  $Z^* \leftarrow \text{CoBüchi}_{0,1}(G, I)$ 
2:  $S \leftarrow \text{UNSAFEA}(G, Z^*)$ 
3:  $G \leftarrow G|_{Z^*}, I \leftarrow I \cap Z^*$  ▷ All vertices are cooperatively co-Büchi winning
4:  $D \leftarrow \text{COMPUTECOLIVE}((G, I), \emptyset)$ 
5: return  $(S, D)$ 

6: procedure COMPUTECOLIVE( $((G, I), D)$ )
7:    $U \leftarrow \text{SAFETY}_{0,1}(G, I)$  ▷  $U \subseteq I$ 
8:    $D \leftarrow (U \times V \setminus U) \cap E$ 
9:   while  $U \neq V$  do
10:     $W_{\text{attr}} \leftarrow \text{attr}_G^0(G, U)$ 
11:     $U \leftarrow U \cup W_{\text{attr}}$ 
12:     $C \leftarrow \text{cpre}_G^1(U) \setminus U$ 
13:     $D \leftarrow D \cup \{(u, v) \in E \cap (C \times V \setminus U)\}$ 
14:     $U \leftarrow U \cup C$ 
15:  return  $D$ 

```

---

**Theorem 7.** *Given a game graph  $G = (V = V^0 \cup V^1, E)$ , with co-Büchi objective  $\Phi = \diamond \square I$  for *Player i*. Then Alg. 3 terminates in time  $\mathcal{O}(m + n)$ , and  $\Psi = \Psi_{\text{UNSAFE}}(S) \wedge \Psi_{\text{COLIVE}}(D)$  is an adequately permissive assumption on *Player 1* from  $Z^*$ . Here,  $n = |V|$  and  $m = |E|$ .*

*Proof.* We first show that the algorithm terminates. We show that the procedure COMPUTECOLIVE terminates when all the vertices of the game graph are cooperatively winning for the co-Büchi objective  $\Phi = \diamond \square I$ , since we restrict the graph to the cooperative winning region in step 3. We claim that  $U = V = Z^*$ , eventually.

Let  $U_l$  be the value of the variable  $U$  after  $l$ -th iteration of the while loop, with  $U_0 = \text{SAFETY}_{0,1}(G, I)$ . Since vertices are only added in  $U$ ,  $U_0 \subset U_1 \subset \dots \subset U_m = U_{m+1}$  for some  $m \in \mathbb{N}$ . Suppose  $V \not\subseteq U_m$ , then there exists  $v \in V \setminus U_m$ . Since  $v \in Z^*$ , there is a  $\rho = vv_1v_2 \dots$  from  $v$  to  $U_0$  and stays there forever. Then consider the largest index  $l$  such that  $v_l \notin U_m$ , but  $v_{l+1} \in U_m$ . Note that this index exists because  $U_0 \subseteq U_m$ .

Then if  $v_l \in V^0$ , it would be added to  $U$  in step 11 of  $(m + 1)$ -th iteration, i.e.  $U_m \neq U_{m+1}$ . Else if  $v_l \in V^1$ , it would be added to  $U$  in step 14 of  $(m + 1)$ -th iteration since  $v_{l+1} \in U_m$ , i.e.  $U_m \neq U_{m+1}$ . In either case, we get a contradiction. Hence,  $v \in U_m$ , implying  $Z^* = U_m$ . Hence the procedure COMPUTECOLIVE, and hence the Algo. 3, terminates.

Now we show that  $\Psi$  is an adequately permissive assumption. Again, let  $U_l$  and  $m$  be as defined earlier. Define  $X_l := U_l \setminus U_{l-1}$  for  $1 \leq l \leq m$ , and  $X_0 = U_0 = I$ . Then every vertex  $v \in Z^*$  is in  $X_l$  for some  $l \in [0; m]$ .

We again prove sufficiency, implementability and permissiveness separately and finally comment on the complexity of COLIVEA.

► **Implementability:** We again observe that the sources of the co-live edges in  $D$  are *Player 1*'s vertices and by construction, each source has at least one alternative edge that is neither co-live nor unsafe. Hence, they can be easily implemented by *Player 1*, by taking those edges only finitely often.

► **Sufficiency:** Consider the following strategy  $\pi^0$  for *Player 0*: at a vertex  $v \in X_0 \cap V^0$ , she takes edge  $(v, v') \in E$  such that  $v' \in X_0$ , at a vertex  $v \in X_l \cap V^0$ , for  $l \in [2; m]$ , she plays the  $\text{attr}^0$  strategy to reach  $U_{l-1}$ , and for all other vertices, she plays arbitrarily.

Let  $v_0 \in Z^* = \langle\langle 0, 1 \rangle\rangle \diamond \square I$  (from Step 1). Let  $\pi^1$  be an arbitrary strategy of *Player 1* such that  $\mathcal{L}(\pi^1) \subseteq \mathcal{L}(\Psi)$ , and  $\rho = v_0 v_1 \dots$  be an arbitrary  $\pi^i \pi^1$ -play. Then  $\rho \in \mathcal{L}(\Psi)$ . It remains to show that  $\rho \in \mathcal{L}(\Phi)$ .

Since  $\rho \in \mathcal{L}(\Psi_{\text{UNSAFE}}(S))$  and by definition of  $\pi^i$ ,  $v_i \in Z^*$  for all  $i$ . Now suppose  $\rho \notin \mathcal{L}(\Phi)$ , i.e.  $\text{inf}(\rho) \cap (Z^* \setminus I) \neq \emptyset$ . Let  $u \in Z^* \setminus I$ . Then to reach  $u$  infinitely often some edge from  $D$  must be taken infinitely often in  $\rho$ , since  $\pi^i$  makes the play go towards  $I$ . But this contradicts the fact that  $\rho \in \mathcal{L}(\Psi)$ . Hence,  $\rho \in \mathcal{L}(\Phi)$ .

► **Permissiveness:** Let  $\rho = v_0 v_1 \dots$  such that  $v_0 \in Z^*$  and  $\rho \in \mathcal{L}(\Phi)$ . Suppose that  $\rho \notin \mathcal{L}(\Psi)$ .

Case 1: If  $\rho \notin \Psi_{\text{UNSAFE}}(S)$ . Then the same argument as in the Büchi case gives a contradiction.

Case 2: If  $\rho \notin \Psi_{\text{COLIVE}}(D)$ , that is  $\exists (u, v) \in D$ , such that  $\rho$  takes  $(u, v)$  infinitely often. By the definition of  $D$ ,  $v \in Z^* \setminus U_0$ , implying  $v \notin I$ , since if  $v \in I$  then it would have been in  $U_0$ . Hence,  $\rho \notin \mathcal{L}(\Phi)$ , giving a contradiction. So  $\rho \in \mathcal{L}(\Psi)$ .

► **Complexity analysis.** Very similar to that for Büchi objectives and therefore omitted.

## E APA ssumption for parity games

For the convenience of the reader, we restate Thm. 5 here.

**Theorem 5.** *Let  $\mathcal{G} = (G = (V, E), \text{Parity}(C))$  be a parity game such that  $(S, D, \mathcal{H}^\ell) = \text{PARITYASSUMPTION}(G, C)$ . Then  $\Psi = \Psi_{\text{UNSAFE}}(S) \wedge \Psi_{\text{COLIVE}}(D) \wedge \Psi_{\text{COND}}(\mathcal{H}^\ell)$  is an APA for  $\mathcal{G}$ . Moreover, Algo. 1 terminates in time  $\mathcal{O}(n^4)$ , where  $n = |V|$ .*

*Proof.* We prove sufficiency, implementability and permissiveness below and then analyze the complexity of Alg. 1.

► **Implementability:** We note that the assumption is implementable by the implementability of safety, liveness and co-liveness assumptions: if for a conditional live group, the corresponding vertex set is reached infinitely often, and also the sources of live groups are visited infinitely often, *Player 1* can choose the live

group edges, since they are controlled by *Player 1*. Moreover, there won't be any conflict due to the conditional live groups as there can be no unsafe or co-live edge that is included in a conditional live group by construction.

► **Sufficiency:** We give a strategy for *Player 0* depending on the parity of the highest priority  $d$  occurring in the game and show that it is winning under assumption  $\Psi$  for all vertices in the cooperative winning region  $Z^* = \text{PARITY}(G, C)$ . The strategy uses finite memory and the winning strategies for *Player 1* in sub-games with Büchi (Thm. 2) and co-Büchi (Thm. 3) objectives.

By  $Büchi(G, U)$ , we denote the game  $(G, \square \diamond U)$ , and by  $co\text{-}Büchi(G, U)$ , we denote the game  $(G, \diamond \square U)$ . We also use the definitions of  $d$ ,  $W_d$  and  $W_{-d}$ , as in the Algo. 1. Consider the following strategy  $\pi^0$  of *Player 0*:

▷  $d$  is **odd**: If the play is in  $V \setminus W_{-d}$ , then *Player 0* plays the  $co\text{-}Büchi(G, W_{-d})$  winning strategy to eventually end up in  $W_{-d}$ . If the play is in  $W_{-d} \cap Z^*$ , *Player 0* plays the recursive winning strategy for  $(G|_{W_{-d}}, \text{Parity}(C))$ . Otherwise, she plays arbitrarily.

▷  $d$  is **even**: If the play is in  $W_d$ , *Player 0* switches its strategy among  $Büchi(G, W_d), Büchi(G, W_d \cup W_{d-2}), \dots, Büchi(G, W_d \cup W_{d-2} \cup \dots \cup W_2)$  winning strategies, i.e., for each vertex, she first uses the first strategy in the above sequence, then when that vertex is repeated, she uses the second strategy for the next move, and keeps switching to the next strategies for every move from the same vertex. If the play is in  $V \setminus W_d \cap Z^*$ , then she plays the recursive winning strategy for  $(G|_{W_{-d}}, \text{Parity}(C))$ , where  $C$  is modified again as in line 16. Otherwise, she plays arbitrarily.

We prove by induction, on the highest occurring priority  $d$ , that the above constructed strategy  $\pi^0$  for *Player 0* ensures satisfying the parity objective on the original game graph if the assumption  $\Psi$  is satisfied. For the base case, when  $d = 0$ , the constructed strategy is trivially winning, because the only existing color is even. Now let the strategy be winning for  $d - 1 \geq 0$ .

Let  $v_0 \in Z^* = \text{PARITY}(G, C)$ . Let  $\pi^1$  be an arbitrary strategy of *Player 1* such that  $\mathcal{L}(\pi^1) \subseteq \mathcal{L}(\Psi)$ , and  $\rho = v_0 v_1 \dots$  be an arbitrary  $\pi^0 \pi^1$ -play. Then  $\rho \in \mathcal{L}(\Psi)$ . We need to show that  $\rho$  is winning, i.e.,  $\rho \in \mathcal{L}(\Phi)$ . Note that by the safety assumption and by the construction of  $\pi^0$ ,  $\rho$  stays in the vertex set  $Z^*$ .

Case 1: If  $d$  is odd, then since at vertices in  $V \setminus W_{-d}$ , *Player 0* plays to eventually stay in  $W_{-d}$ , the play can not stay in  $W_{-d}$  without violating  $\Psi_{\text{COLIVE}}(D)$ . And if  $\rho$  eventually stays in  $W_{-d}$ , then by the induction hypothesis, it is winning, since  $W_{-d} \cap C_d = \emptyset$ .

Case 2: If  $d$  is even, then if the play stays in  $W_d$  eventually, and if the play visits vertices of an odd priority  $i$  infinitely often, then  $\pi^1$  satisfies  $\text{LIVEA}(G, C_{i+1} \cup C_{i+2} \cup \dots \cup C_d)$  by the conditional live group assumption. Note that *Player 0* plays the  $Büchi(G, C_{i+1} \cup C_{i+2} \cup \dots \cup C_d)$  winning strategy for infinitely many moves from every vertex occurring in  $\rho$ . Since  $\pi^1$  satisfies  $\text{LIVEA}(G, C_{i+1} \cup C_{i+2} \cup \dots \cup C_d)$ , after these moves as well, the play visits  $(C_{i+1} \cup C_{i+2} \cup \dots \cup C_d)$ . Hence the play will visit vertices of an even color  $> i$  infinitely often, implying that  $\rho$  is winning. Else if  $\rho$  stays in  $V \setminus W_d$  eventually, then it is winning by induc-



tion hypothesis. This gives the sufficiency of the assumptions computed by the algorithm.

► **Permissiveness:** Now for the permissiveness of the assumption, let  $\rho \in \mathcal{L}(\Phi)$ . We prove the claim by contradiction and suppose that  $\rho \notin \mathcal{L}(\Psi)$ .

Case 1: If  $\rho \notin \Psi_{\text{UNSAFE}}(S)$ . Then some edge  $(v, v') \in S$  is taken in  $\rho$ . Then after reaching  $v'$ ,  $\rho$  still satisfies the parity objective. Hence,  $v' \in Z^*$ , but then  $(v, v') \notin S$ , which is a contradiction.

Case 2: If  $\rho \notin \Psi_{\text{COND}}(\mathcal{H}^\ell)$ . Then for some even  $j$  and odd  $i < j$ ,  $\rho$  visits  $W_j \cap C_i$  infinitely often but does not satisfy the live transition group assumption  $\text{LIVEA}(G', C_{i+1} \cup C_{i+2} \cdots \cup C_j)$ , where  $G' = G|_{W_j}$ . Due to the construction of the set  $W_j$ , it is easy to see that once  $\rho$  visits  $W_j$ , it can never visit  $V \setminus W_j$ . Hence, eventually  $\rho$  stays in the game  $\mathcal{G}'$  and visits  $C_i$  infinitely often. Since  $\rho \in \mathcal{L}(\Phi)$ , it also visits some vertices of some even priority  $> i$  infinitely often, and hence, it satisfies  $\Box\Diamond(C_{i+1} \cup C_{i+3} \cdots \cup C_j)$  in  $G'$ . Since  $\text{LIVEA}(G', C_{i+1} \cup C_{i+3} \cdots \cup C_j)$  is a permissive assumption for  $(G', \Box\Diamond(C_{i+1} \cup C_{i+3} \cdots \cup C_j))$ , the play  $\rho$  must satisfy  $\text{LIVEA}(G', C_{i+1} \cup C_{i+3} \cdots \cup C_j)$ , which contradicts the assumption.

Case 3: If  $\rho \notin \Psi_{\text{COLIVE}}(D)$ . Then for some odd  $i$  an edge  $(u, v) \in \text{COLIVEA}(G, W_{-i})$  is taken infinitely often. Then the vertex  $v \in V \setminus W_{-i}$  is visited infinitely often. Note that  $\rho$  can not be winning by visiting an even  $j > i$ , since otherwise  $v$  would have been in  $\text{BÜCHI}(G, C_j)$  as from  $v$  we can infinitely often see  $j$ , and hence would have been removed from  $\mathcal{G}$  for the next recursive step. Hence,  $\rho$  visits some even  $j < i$  infinitely often, i.e.  $i$  is not visited infinitely often. Then  $v$  would be in  $W_{-d}$ , which is a contradiction.

► **Complexity analysis.** We note that the cooperative parity game can be solved in time  $\mathcal{O}((n+m) \log d)$ , where  $n, m$  and  $d$  are the number of vertices, edges and priorities respectively: consider the graph where  $pz$  owns all the vertices, find the strongly connected components in time  $\mathcal{O}(n+m)$ , check which of these components have a cycle with highest priority even by reduction to even-cycle problem [17]. Then  $\text{COMPUTESSETS}$  takes time  $\mathcal{O}(n^2)$  for the even case, but is dominated by  $\mathcal{O}(n^3)$  time for the odd case. For every priority,  $\text{COMPUTESSETS}$  is called once, that is at most  $2n$  calls in total. Then the total running time of the algorithm is  $\mathcal{O}((n+m) \log d + 2n \cdot (n^3)) = \mathcal{O}(n^4)$ .

## F Equivalence of Def. 1 and Def. 6

We prove the following result stating the equivalence of between Def. 1 and Def. 6 for the class of assumptions we consider.

**Proposition 3.** *Given a parity game  $\mathcal{G}$ , let  $\Psi$  be an APA computed by Thm. 5. Then, a Player 0 strategy is winning under  $\Psi$  by Def. 1 if and only if it is winning under  $\Psi$  by Def. 6.*

*Proof.* Suppose a Player 0 strategy  $\pi^0$  is winning under assumption  $\Psi$  by Def. 6. Then every play  $\rho \in \mathcal{L}(\pi^0)$  either fails to satisfy the assumption  $\Psi$  or satisfies the specification  $\Phi$ . Hence,  $\mathcal{L}(\pi^0) \subseteq \mathcal{L}(\Phi) \cup \mathcal{L}(\neg\Psi)$ . Now, let  $\pi^1$  be a Player 1

strategy s.t.  $\mathcal{L}(\pi^1) \subseteq \mathcal{L}(\Psi)$ . Then,

$$\begin{aligned} \mathcal{L}(\pi^0 \pi^1) &= \mathcal{L}(\pi^0) \cap \mathcal{L}(\pi^1) \\ &\subseteq (\mathcal{L}(\Phi) \cup \mathcal{L}(\neg\Psi)) \cap \mathcal{L}(\Psi) \\ &= (\mathcal{L}(\Phi) \cap \mathcal{L}(\Psi)) \cup (\mathcal{L}(\neg\Psi) \cap \mathcal{L}(\Psi)) \\ &= \mathcal{L}(\Phi) \cap \mathcal{L}(\Psi) \\ &\subseteq \mathcal{L}(\Phi). \end{aligned}$$

Hence,  $\pi^0$  is also winning under assumption  $\Psi$  by Def. 1.

Now, for the other direction, suppose  $\pi^0$  is winning under assumption  $\Psi$  by Def. 1. Let  $\rho \in \mathcal{L}(\pi^0)$ . If  $\rho \notin \mathcal{L}(\Psi)$ , then we are done. Suppose  $\rho \in \mathcal{L}(\Psi)$ , then we have to show that  $\rho \in \mathcal{L}(\Phi)$ . We claim that there exists a *Player 1* strategy  $\pi^1$  such that  $\pi^1 \subseteq \mathcal{L}(\Psi)$  and  $\rho$  is compliant with it. Then, by Def. 1,  $\mathcal{L}(\pi^0 \pi^1) \subseteq \mathcal{L}(\Phi)$ . As  $\rho$  is compliant with both  $\pi^0$  and  $\pi^1$ ,  $\rho \in \mathcal{L}(\Phi)$ , and hence, we are done.

Now we only need to prove the claim. As  $\Psi$  is an implementable assumption, there exists a *Player 1* strategy  $\pi_*^1$  such that  $\mathcal{L}(\pi_*^1) \subseteq \mathcal{L}(\Psi)$  and by definition, the strategy is defined on all vertices. Let  $\rho = v_0 v_1 \dots$ . Now, let  $\pi^1$  be another *Player 1* strategy such that for every play prefix  $\mathbf{p} \in V^* V^1$ , it is defined as follows:

$$\pi^1(\mathbf{p}) = \begin{cases} v_k & \text{if } \mathbf{p} = v_0 v_1 \dots v_{k-1} \\ \pi_*^1(\mathbf{p}) & \text{otherwise.} \end{cases}$$

Then, clearly,  $\rho$  is compliant with  $\pi^1$ . Now, let  $\rho' \in \mathcal{L}(\pi^1)$ , then it is enough to show that  $\rho' \in \mathcal{L}(\Psi)$ . If  $\rho' = \rho \in \mathcal{L}(\Psi)$ , then we are done. Suppose not and let  $\mathbf{p}'$  be the maximal prefix of  $\rho'$  that is also a prefix of  $\rho$  (which can also be empty). By construction, the moves taken after the prefix  $\mathbf{p}'$  in  $\rho'$  are compliant with  $\pi_*^1$ . As the conditional live group templates and co-liveness templates are tail properties and are independent of prefixes,  $\rho'$  satisfies those templates of assumption  $\Psi$ . Furthermore, as  $\mathbf{p}'$  is a prefix of  $\rho \in \mathcal{L}(\Psi)$  and the moves taken after  $\mathbf{p}'$  in  $\rho'$  are compliant with  $\pi_*^1$ , the play  $\rho'$  can not contain any unsafe edges marked by assumption  $\Psi$ . Therefore,  $\rho' \in \mathcal{L}(\Psi)$ .

## G Complete table for experimental results

Name	Number of Vertices	Number of Edges	Number of Priorities	Computation time of SIMPA (in seconds)	Computation time of GIST (in seconds)
abcg arbiter	417	638	3	0.016	9.79
ActionConverter	134	200	3	0.003	0.005
amba decomposed arbiter 2	141	212	4	0.005	0.21 *
amba decomposed arbiter 3	741	1176	4	0.064	3.798 *
amba decomposed arbiter 4	2468	3950	4	0.703	35.911 *
amba decomposed arbiter 5	7273	11,576	4	7.095	297.975 *
amba decomposed arbiter	36,824	67,018	4	203.104	Timeout
amba decomposed decode	19	26	3	0.002	0.004
amba decomposed encode 10	78,313	117,676	3	11.882	Timeout
amba decomposed encode 11	156,184	234,506	3	45.455	Timeout

amba decomposed encode 12	311,879	468,072	3	181.623	Timeout
amba decomposed encode 13	623,222	935,110	3	732.713	Timeout
amba decomposed encode 14	1,245,861	1,869,092	3	2960.11	Timeout
amba decomposed encode 2	95	140	3	0.003	0.562
amba decomposed encode 3	264	402	3	0.005	14.5
amba decomposed encode 4	499	760	3	0.008	97.901
amba decomposed encode 5	1534	2342	3	0.025	2616.04
amba decomposed encode 6	2965	4500	3	0.06	Timeout
amba decomposed encode 7	5804	8770	3	0.168	Timeout
amba decomposed encode 8	11,459	17,264	3	0.534	Timeout
amba decomposed encode 9	39,354	59,214	3	3.296	Timeout
amba decomposed encode	292	476	3	0.006	4.23
amba decomposed lock 2	398	592	3	0.04	50.282
amba decomposed lock 3	1558	2336	3	0.074	2999.65
amba decomposed lock 4	6182	9280	3	0.608	Timeout
amba decomposed lock 5	24,646	36,992	3	9.563	Timeout
amba decomposed lock 6	98,438	147,712	3	158.854	Timeout
amba decomposed lock 7	393,478	590,336	3	2801.93	Timeout
amba decomposed lock	180	288	3	0.009	1.288
amba decomposed shift	44	64	3	0.006	0.021
amba decomposed tburst4	1061	1618	4	0.112	685.687
amba decomposed tincr	2082	3280	3	0.227	Timeout
amba decomposed tsingle	950	1450	4	0.094	464.176
arbiter	39	54	3	0.008	0.024
arbiter with buffer	84	132	3	0.003	0.032
arbiter with cancel	139	212	3	0.004	1.592
Button	12	16	3	0.007	0.007
detector	84	126	4	0.008	0.457
detector unreal	141	210	4	0.005	0.301 *
EnemyModule	20	28	3	0.005	0.005
EscalatorBidirectional	1622	2464	3	0.18	4.123
EscalatorCountingInit	99	148	3	0.006	0.045
EscalatorCounting	79	118	3	0.003	0.012
EscalatorNonCounting	21	30	3	0.002	0.003
EscalatorNonReactive	7	8	3	0.002	0.002
EscalatorSmart	1783	3008	5	0.146	Timeout
full arbiter 2	204	324	3	0.007	4.939
full arbiter 3	1403	2396	3	0.082	538.772
full arbiter 4	7444	12,764	3	3.171	Timeout
full arbiter 5	44,019	76,920	3	109.252	Timeout
full arbiter	774	1218	3	0.025	704.267
full arbiter unreal1	774	1218	3	0.041	697.743
full arbiter unreal2	774	1218	3	0.027	698.161
Gamemodule	143	214	3	0.008	0.032
Increment	12	16	3	0.002	0.002
KitchenTimerV0	20	28	3	0.002	0.002
KitchenTimerV1	80	124	3	0.003	0.03
KitchenTimerV2	731	1138	3	0.038	3.302
KitchenTimerV3	1583	2482	3	0.165	14.573
KitchenTimerV4	2272	3554	3	0.408	34.324
KitchenTimerV5	4111	6584	3	1.422	134.261
KitchenTimerV6	4099	6560	3	1.438	140.525
lilydemo01	104	148	3	0.003	0.045
lilydemo02	104	148	3	0.003	0.044
lilydemo03	211	312	3	0.005	24.546
lilydemo04	304	448	3	0.011	77.08
lilydemo05	293	436	3	0.011	59.884
lilydemo06	369	548	3	0.026	121.068
lilydemo07	78	108	3	0.004	1.26
lilydemo08	26	36	4	0.005	0.01
lilydemo09	47	66	4	0.006	0.023 *
lilydemo10	46	68	4	0.002	0.11
lilydemo11	65	100	3	0.007	0.108
lilydemo12	110	172	3	0.003	0.23
lilydemo13	11	14	3	0.007	0.011
lilydemo14	399	660	6	0.03	166.612
lilydemo15	133	206	3	0.008	0.48
lilydemo17	3102	5334	7	0.22	Timeout

lilydemo18	449	728	9	0.017	1566.9
lilydemo19	108	162	4	0.009	0.167 *
lilydemo20	1989	3252	4	0.4	Timeout
lilydemo21	4087	6824	3	0.428	Timeout
lilydemo22	373	556	3	0.02	109.443
lilydemo23	38	48	3	0.008	0.072
lilydemo24	263	406	4	0.008	54.354
load balancer	255	390	4	0.008	105.297
load balancer unreal1	328	506	4	0.01	202.229
load balancer unreal2	326	502	4	0.024	200.707
loadcomp2	387	614	4	0.024	2.974
loadcomp3	1556	2734	4	0.262	62.287
loadcomp4	3943	6968	4	1.94	979.018
loadcomp5	10,657	19,136	4	15.525	Timeout
loadfull2	331	552	4	0.043	1.187
loadfull3	1159	2030	4	0.143	28.051
loadfull4	3399	6084	4	1.421	496.464
loadfull5	6483	11,184	4	5.595	Timeout
ltl2dba01	101	152	4	0.011	9.012
ltl2dba02	489	758	4	0.011	74.949
ltl2dba03	135	200	4	0.006	65.785
ltl2dba04	165	260	4	0.007	0.28
ltl2dba05	361	560	4	0.01	7.105 *
ltl2dba06	329	496	4	0.009	703.712
ltl2dba07	4368	6656	4	0.399	2085.74 *
ltl2dba08	41,071	67,522	4	5.515	Timeout
ltl2dba09	75	120	4	0.004	0.023
ltl2dba10	77	118	4	0.003	0.026
ltl2dba11	21	30	4	0.002	0.003
ltl2dba12	81	120	4	0.003	0.335
ltl2dba13	151	222	4	0.009	0.198 *
ltl2dba14	97	144	4	0.004	0.065 *
ltl2dba15	39	60	4	0.002	0.007
ltl2dba16	75	114	4	0.003	0.025
ltl2dba17	663	1020	4	0.009	213.754
ltl2dba18	265	420	4	0.009	11.288
ltl2dba19	106	152	4	0.004	0.652 *
ltl2dba20	1078	1760	4	0.018	587.085
ltl2dba21	2197	3380	4	0.043	Timeout
ltl2dba22	21	30	4	0.008	0.025
ltl2dba23	51	78	4	0.008	0.073
ltl2dba24	19	26	4	0.002	0.011
ltl2dba25	104	158	4	0.004	0.074
ltl2dba26	148	236	4	0.003	0.19
ltl2dba27	21	30	4	0.005	0.059
ltl2dba alpha	63	96	4	0.003	0.128
ltl2dba beta	907	1454	4	0.022	341.418
ltl2dba C2	19	26	4	0.003	0.005
ltl2dba E	19	26	4	0.003	0.013
ltl2dba Q	46	68	4	0.003	0.077
ltl2dba R	19	26	4	0.002	0.003
ltl2dba theta	275	440	5	0.011	112.133
ltl2dba U1	61	92	4	0.009	0.142
ltl2dpa01	102	164	5	0.004	0.52
ltl2dpa02	87	138	4	0.007	0.073
ltl2dpa03	8135	14,280	6	2.481	Timeout
ltl2dpa04	40	56	4	0.004	0.017
ltl2dpa05	40	56	4	0.003	0.008
ltl2dpa06	70	100	4	0.003	0.044 *
ltl2dpa07	137	204	4	0.004	0.555
ltl2dpa08	71	112	4	0.003	0.089
ltl2dpa09	137	204	4	0.004	0.556
ltl2dpa10	996	1704	6	0.049	500.069
ltl2dpa11	174	268	4	0.015	0.612
ltl2dpa12	2544	4422	7	0.714	Timeout
ltl2dpa13	661	1118	5	0.066	317.768
ltl2dpa14	114	184	5	0.006	0.711
ltl2dpa15	121	194	4	0.004	0.696

ltl2dpa16	118	188	4	0.009	0.438
ltl2dpa17	82	128	4	0.008	0.115 *
ltl2dpa18	82	128	4	0.008	0.111 *
ltl2dpa19	841	1392	5	0.041	9.497 *
ltl2dpa20	340	560	4	0.008	34.289
ltl2dpa21	996	1704	6	0.05	500.785
ltl2dpa22	9351	16,128	6	4.603	Timeout
ltl2dpa23	443	676	4	0.019	22.212
ltl2dpa24	443	676	4	0.017	22.209
MusicAppFeedback	1584	2590	3	0.166	1159.62
MusicAppMotivating	2501	4118	3	0.261	3064.71
MusicAppSimple	344	562	3	0.018	11.77
OneCounterGuiA0	12,353	19,052	3	13.995	1720.65
OneCounterGuiA1	21,272	32,778	3	38.838	Timeout
OneCounterGuiA2	35,020	54,106	3	104.356	Timeout
OneCounterGuiA3	62,852	97,434	3	411.197	Timeout
OneCounterGuiA4	63,275	98,280	3	412.184	Timeout
OneCounterGuiA5	63,698	99,126	3	405.678	Timeout
OneCounterGuiA6	69,756	109,186	3	500.2	Timeout
OneCounterGuiA7	71,106	111,886	3	508.946	Timeout
OneCounterGuiA8	84,017	133,596	3	747.632	Timeout
OneCounterGuiA9	87,077	139,716	3	786.04	Timeout
OneCounterGui	12,353	19,052	3	13.862	1725.76
OneCounterInRangeA0	429	688	3	0.017	7.494
OneCounterInRangeA1	518	832	3	0.02	15.474
OneCounterInRangeA2	534	864	3	0.018	24.461
OneCounterInRangeA3	447	724	3	0.018	8.735
OneCounterInRange	429	688	3	0.033	7.41
OneCounter prioritized arbiter	87,077	139,716	3	805.637	Timeout
prioritized arbiter	125	196	4	0.009	0.38 *
prioritized arbiter unreal1	851	1412	4	0.075	10.748 *
prioritized arbiter unreal2	851	1412	4	0.085	10.739 *
prioritized arbiter unreal3	10,588	18,196	4	14.389	2273.01 *
RegManager	20	28	3	0.004	0.005
robot grid	3136	5408	3	0.091	Timeout
RotationCalculator	560	856	3	0.023	0.295
round robin arbiter	125	190	3	0.007	2.067
round robin arbiter unreal1	157	242	3	0.008	3.642
round robin arbiter unreal2	157	242	3	0.009	3.689
round robin arbiter unreal3	2087	3388	3	0.048	Timeout
SensorRegister	12	16	3	0.007	0.007
Sensor	7905	13,596	4	8.325	Timeout
simple arbiter	662	1184	3	0.039	8.903
simple arbiter unreal1	2178	3676	3	0.17	1985.03
simple arbiter unreal2	6703	11,846	3	1.408	Timeout
simple arbiter unreal3	45,260	80,600	3	201.107	3202.98
SliderDefault	751	1250	3	0.029	80.1
SPIReadClk	37	54	3	0.002	0.003
SPIReadSdi	178	284	3	0.008	0.477
SPIWriteClk	144	220	3	0.004	0.018
SPIWriteSdi	547	830	3	0.02	1.077
starve.ehoa	13	18	3	0.002	0.003
starve-smart.ehoa	17	22	3	0.002	0.02
test2.ehoa	176	280	4	0.008	7.772
TorcsAccelerating	21	30	3	0.007	0.008
TorcsGearing	27	38	3	0.002	0.006
TorcsSimple	85	130	3	0.003	0.017
TorcsSteeringSimple	189	306	3	0.005	0.263
TorcsSteeringSmart	404	628	3	0.013	2.859
TwoCounters2	39,747	61,044	3	140.334	Timeout
TwoCounters3	30,511	46,672	3	78.866	Timeout
TwoCounters4	46,702	72,904	3	195.105	Timeout
TwoCountersInRangeA0	22,231	34,212	3	42.399	Timeout
TwoCountersInRangeA1	31,271	48,192	3	84.137	Timeout
TwoCountersInRangeA2	44,750	69,000	3	179.063	Timeout
TwoCountersInRangeA3	45,122	69,744	3	185.008	Timeout
TwoCountersInRangeA4	45,494	70,488	3	183.387	Timeout
TwoCountersInRangeA5	46,098	71,696	3	189.761	Timeout

TwoCountersInRangeA6	46,702	72,904	3	192.715	Timeout
TwoCountersInRangeM0	46,702	72,904	3	196.336	Timeout
TwoCountersInRangeM1	46,702	72,904	3	194.149	Timeout
TwoCountersInRangeM2	46,098	71,696	3	189.046	Timeout
TwoCountersInRangeM3	46,098	71,696	3	186.365	Timeout
TwoCountersInRangeM4	46,098	71,696	3	187.458	Timeout
TwoCountersInRangeM5	46,098	71,696	3	189.278	Timeout
TwoCountersInRange	22,231	34,212	3	42.468	Timeout
TwoCountersRefinedRefined	1933	3140	3	0.209	43.752
TwoCountersRefined	1961	3196	3	0.217	45.308
TwoCounters	1216	1970	3	0.086	14.067
UnderapproxDemo2	42	60	3	0.003	0.012
UnderapproxDemo	20	24	3	0.003	0.007
Zoo10	479	768	3	0.02	2.868
Zoo5	479	768	3	0.021	2.872