

Human-in-the-loop Embodied Intelligence with Interactive Simulation Environment for Surgical Robot Learning

Yonghao Long, Wang Wei, Tao Huang, Yuehao Wang and Qi Dou
The Chinese University of Hong Kong

Abstract—Surgical robot automation has attracted increasing research interest over the past decade, expecting its huge potential to benefit surgeons, nurses and patients. Recently, the learning paradigm of embodied AI has demonstrated promising ability to learn good control policies for various complex tasks, where embodied AI simulators play an essential role to facilitate relevant researchers. However, existing open-sourced simulators for surgical robot are still not sufficiently supporting human interactions through physical input devices, which further limits effective investigations on how human demonstrations would affect policy learning. In this paper, we study human-in-the-loop embodied intelligence with a new interactive simulation platform for surgical robot learning. Specifically, we establish our platform based on our previously released SurRoL simulator with several new features co-developed to allow high-quality human interaction via an input device. With these, we further propose to collect human demonstrations and imitate the action patterns to achieve more effective policy learning. We showcase the improvement of our simulation environment with the designed new features and tasks, and validate state-of-the-art reinforcement learning algorithms using the interactive environment. Promising results are obtained, with which we hope to pave the way for future research on surgical embodied intelligence. Our platform is released and will be continuously updated in the website: <https://med-air.github.io/SurRoL/>

I. INTRODUCTION

Surgical robotics has developed rapidly in the past decade and transformed minimally invasive surgery in practice [1]. Recently, surgical task automation [2] has received increasing attention from researchers as it is promising to reduce burden of surgeons and improve operational efficiency [3]. However, it still remains a distant dream with challenges from complex surgical scenes and skillful surgical actions. Conventional solutions typically rely on heuristic planning methods while struggle to yield scalable control policies. To date, successful stories on surgical task automation is still in its infancy [4].

Embodied intelligence [5] hypothesizes to directly learn various skills based on interactions between robots and the environment, which has demonstrated remarkable capability on robot task automation [6]. In this context, simulators [7–9] serve as the essential infrastructure to provide a digital twin [10, 11] of the physical world, in order to facilitate collection of interactive data, training and testing of the agent. Reinforcement learning (RL) is typically used together with embodied AI, which can model the task execution as Markov

This project was supported by Hong Kong Research Grants Council TRS Project No.T42-409/18-R, Multi-Scale Medical Robotics Center InnoHK under grant 8312051, and a Research Fund from Cornerstone Robotics Ltd.

Y. Long, Wang Wei, Tao Huang, Yuehao Wang, and Q. Dou are with the Department of Computer Science and Engineering, The Chinese University of Hong Kong. Q. Dou is also with the T Stone Robotics Institute, CUHK.

Corresponding author: Qi Dou (qidou@cuhk.edu.hk).

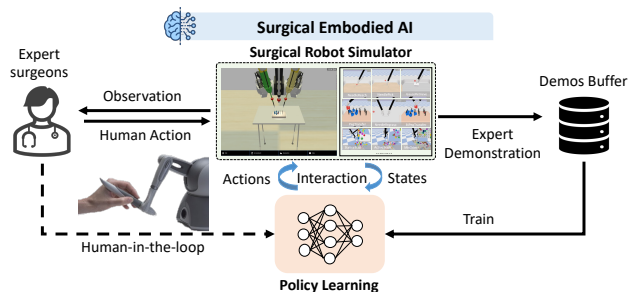

Fig. 1. Illustration for the concept of surgical embodied intelligence with human-in-the-loop demonstrations for robot learning.

decision process and optimize the policy learning through robot-environment interactions in the simulator. Despite visible efforts that have been made on embodied intelligence in general [7, 8, 12], surgical embodied intelligence, which should be supported by well-developed and domain-specific simulation environments, has been largely unexplored so far.

Specifically, early works [13, 14] focusing on simulation of surgical robot and its relevant tasks (such as peg transfer) were concentrated on realistic virtual environment creation, rather than serving for AI purposes as desired nowadays. Recent simulators increasingly aim at bridging embodied intelligence, in particular reinforcement learning, to surgical robots for developing advanced methods for task automation. Richter *et al.* proposed dVRL [15], the first open-sourced reinforcement learning environment for surgical robotics, and showed that the learned policies can be deployed to the dVRK platform. However, it has not included an interface for physical input device, therefore could not support manual inputs through intuitive interactions. This further restricts the functionality on collecting human demonstration data to study machine learning algorithms. Tagliabue *et al.* developed UnityFlexML [16] for effective RL policy learning on tasks involving soft-tissue manipulations. It includes a small number of sheet-like virtual assets to date, which may limit the diversity of surgical tasks or scenarios that can be investigated. Very recently, Munawar *et al.* released a comprehensive simulation platform AMBF [17] which supports interactive human inputs, therefore it can collect data to train and test control mechanisms for surgical robot. However, AMBF is not yet sufficiently supporting algorithmic libraries to facilitate people to explore reinforcement learning methods using massive human demonstrations.

In parallel with the current defect in simulators, a key unsolved technical pursuit of surgical robot learning is how to pursue a higher level of autonomy [18, 19]. The solution to this problem needs to note that most existing surgical robots

still use a human-centered manner (i.e. teleoperation) [2, 20]. In other words, AI developments should incorporate human into the loop in order to make use of expert’s knowledge for promoting cognitive ability to learn complex surgical skills [21]. However, achieving human-in-the-loop surgical embodied intelligence involves many challenges. First is how to establish an accurate and intuitive action mapping mechanism between human input device and surgical robot, which should be standardized and compatible for machine learning. Second is how to build realistic physical simulation accompanied with high-fidelity scene visualisation to provide immersive feedback from the virtual environment upon human interactions. Third is how to understand the effect of human demonstrations on RL policy learning for task automation in the context of surgical embodied AI.

To address above challenges, we propose to investigate human-in-the-loop embodied intelligence with an interactive simulator dedicated for surgical robot learning, with the concept illustrated in Fig. 1. A human (usually expected an expert surgeon) can manipulate virtual objects via a physical input device, and in turn perceive visual feedback on such interactions in the simulator. The human demonstrations can be saved to a database which is used for control policy learning. Besides, the robot can also explore the environment by itself through the typical trial-and-errors (i.e. action-state pairs). To achieve these, we develop the platform based on our existing open-source simulator SurRoL [22], i.e., a RL-centered and dVRK compatible surgical robot simulator. The proposed new version highlights the introduction of natural human interaction which is achieved by an interface of haptic input devices for two hands. Importantly, a set of new features are co-developed to establish the realistic human interaction: 1) standardized interface which supports human interaction through physical input device and policy learning, 2) realistic physical simulation with fine-grained modeling of collision properties and proportional derivative (PD) control, 3) high-fidelity rendering with vivid phong shading, spotlight modeling and shadow projection for human perception. On top of these, we further use collected human demonstration data to train RL policies for surgical task automation, and compare its performance with previous code-generated demonstration data. Promising results are achieved in terms of efficiency for control policy learning. Finally, four new surgical training tasks (i.e., *PickAndPlace*, *PegBoard*, *NeedleRings*, *MatchBoard*) are added into the simulator which can support skill training of practitioners. These tasks are too complex to have direct code-generated trajectories for machine learning, which can be potentially addressed using our proposed human-in-the-loop embodied AI paradigm. More demos and continuous updates are in the website: <https://med-air.github.io/SurRoL/>

II. RELATED WORK

A. Embodied AI for Robots with Interactive Simulators

Embodied AI aims to learn complex skills through interaction with the environment, instead of directly learning from well-prepared datasets counting video, audio, image

and text. Its rapid progress promotes the development of simulators for embodied AI [5]. Several simulators with noticeable contributions from embodied AI community all incorporate interaction as an important feature. Xiang *et al.* proposed SAPIEN [9], which enables robotic interaction tasks with a realistic and physics-rich simulated environment. Kiana *et al.* proposed ManipulaTHOR [23] to facilitate research on visual object manipulation using a robotic arm. Recently, the embodied AI with human interaction is gaining more and more attention. Li *et al.* proposed iGibson [8] to simulate multiple household tasks which allows VR-based human-environment interaction. Gan *et al.* proposed ThreeDworld [24] for interactive multi-modal physical simulation which supports human interaction through VR devices. Fu *et al.* proposed RFUniverse [25], a physics-based action-centric environment for learning household tasks, which also provides VR interface for human input. Some studies [7, 26] show that with human data involved, the intelligent algorithms tend to demonstrate better performance. Although promising results were observed on general robot learning tasks, they are not applicable for surgical robot learning due to various domain gaps, for example, VR-based manual input cannot satisfy required precision for surgical robot tasks. Still, there are few dedicated attempts on surgical domain due to major challenges on developing open-source surgical robot simulators which support high-quality human interactions.

B. Learning-based Surgical Task Automation

Previous researches on surgical sub-tasks automation are focusing on designing sophisticated task-specific controllers. For example, Sen *et al.* [27] proposes to use sequential convex optimization-based methods to automate suturing. Automatic endoscope manipulation is investigated using methods of visual servoing [28, 29] and cognitive guidance system [30, 31]. However, these methods require substantial specific expertise and suffer from poor generalization capabilities which cannot be widely transferred to different tasks. Instead, learning-based methods, which can learn how to perform the tasks from collected data, demonstrate advantages compared to those traditional methods in terms of task generalization and execution performance [32]. The typical technique is RL [33], which learns the task from scratch through robot-environment interactions in a virtual environment. However, it suffers from large exploration burden and may not even get off the ground. Recent works propose to leverage demonstrations for RL [22, 34] which show promising performance on learning efficiency and success rate of task automation. Promising as it is, this kind of methods generate demonstrations using hand-crafted or code-generated trajectories, while it is not easy or feasible for complex surgical tasks [35] in practice. Therefore, incorporating human demonstrations to the learning paradigm is vital.

III. METHODS

A. Simulation Platform Development as Infrastructure

Our overall system consists of three main components: 1) human interaction device, 2) intelligent policy learning,

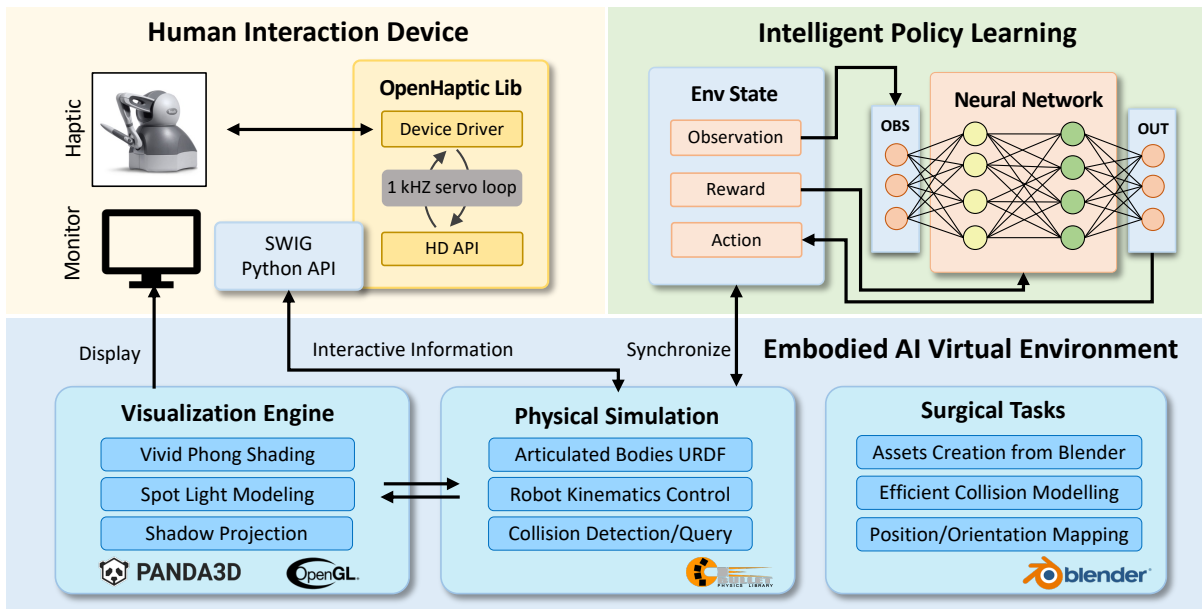

Fig. 2. The proposed platform of human-in-the-loop surgical embodied intelligence with interactive simulation environment for surgical robot learning.

and 3) surgical embodied AI virtual environment, see Fig. 2. First, we create assets of surgical tasks with the help of the powerful 3D modeling tool Blender, and then generate relevant collision models and URDF description models at the same time for physical modeling in the simulation environment. Once surgical tasks are imported to the simulator, the human can conduct surgical action via a manual interaction device, and the interaction information is streamed to the virtual environment for physical simulation. In the meanwhile, the video frames are produced using the visualization engine of the simulator, which will be displayed on the monitor for human perception and next-step interaction. The human actions can be recorded for RL policy learning, and the policy can also interact with the virtual environment by itself, to finally form the diagram of human-in-the-loop surgical robot learning with an interactive simulation environment.

B. Kinematics Mapping and Control with Input Device

To incorporate human control of surgical robots in the simulator, the first and essential step is to develop a manipulation system with an interaction input device. We use Touch [36] (3D Systems Inc.) physical devices to simulate two master arms of the robot to tele-operate Patient Side Manipulators (PSMs) and the Endoscopic Camera Manipulator (ECM).

1) *Kinematics mapping from input device to virtual robot:* To enable smooth control between the physical input device and surgical robots in the simulator, we map the current action of the end-effector instead of pose or joint angle from input device to the simulator, as it is more intuitive and compatible with the policy action from RL algorithms, which can also facilitate the recording of human demonstrations. In specific, for each simulation step k , we first retrieve the end-effector's position and joint angle of current step $p(k) = \{x(k), y(k), z(k), yaw(k)/pitch(k)\}$ and its previous step $p(k-1)$ from haptic (as shown in Fig. 3).

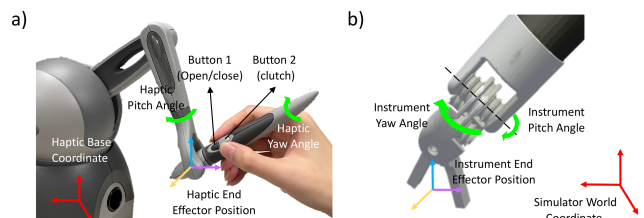

Fig. 3. Kinematics mapping between the (a) physical input device and (b) instrument end-effector in the simulator.

Then, we calculate the current action as $p(k) - p(k-1) = \{d_x, d_y, d_z, d_{yaw}/d_{pitch}\}$, where d_x, d_y, d_z determine the position incremental in the Cartesian space, d_{yaw}/d_{pitch} determines the orientation movement in a top-down or vertical space setting. When Button 1 (shown in Fig. 3) is pressed, the angle of instrument jaw $j(k)$ decreases a constant value for each step until it is closed ($j(k) < 0$), while it is released, the $j(k)$ increases until it is fully open. When Button 2 is pressed, all actions are set to 0 to simulate the clutch mechanism of the control, which is usually used to adjust the master workspace during the operation. All movement action will be multiplied by scaling vectors (corresponding to the tool movement scale), which will then be added to the current state of the surgical instrument to yield the target pose.

2) *Instrumental end-effector control:* After the action mapping, we realize the surgical robot control with inverse kinematic (IK) and a PD controller. Specifically, given the target pose of the surgical instrument end-effector, the target joint angles of the surgical robot are calculated using the IK based on Denavit-Hartenberg (DH) parameters (listed in Table I, with θ_i and d_i consistent with dVRK [2]). As the PSMs and ECM are 6 Degree-of-freedom (DOF) and 4 DOF with a remote center of motion (RCM), the analytical solutions for both of them exist. Given the target and current

TABLE I
DH FOR IK-BASED HAPTIC MANIPULATION

| PSM | | | | |
|-----|-----------|----------------|-------------|---------------|
| i | a_{i-1} | α_{i-1} | d_i | θ_i |
| 1 | 0.0 | $\pi/2$ | 0.0 | $q_1 + \pi/2$ |
| 2 | 0.0 | $-\pi/2$ | 0.0 | $q_2 - \pi/2$ |
| 3 | 0.0 | $\pi/2$ | $q_3 - l_1$ | 0.0 |
| 4 | 0.0 | 0.0 | l_2 | q_4 |
| 5 | 0.0 | $-\pi/2$ | 0.0 | $q_5 - \pi/2$ |
| 6 | l_3 | $-\pi/2$ | 0.0 | $q_6 - \pi/2$ |
| ECM | | | | |
| 1 | 0.0 | $\pi/2$ | 0.0 | $q_1 + \pi/2$ |
| 2 | 0.0 | $-\pi/2$ | 0.0 | $q_2 - \pi/2$ |
| 3 | 0.0 | $\pi/2$ | $q_3 - l_1$ | 0.0 |
| 4 | 0.0 | 0.0 | l_2 | q_4 |

pose of the instrument, we enable the realistic and smooth movement control of the robot using position and velocity PD control. The error is designed as:

$$e = K_p * (p_{\text{target}} - p_{\text{current}}) + K_d * (v_{\text{target}} - v_{\text{current}}), \quad (1)$$

And the discrete control system is formulated as:

$$\Delta u(t_k) = (K_p + \frac{K_d}{\Delta t}) e(t_k) - (K_p + \frac{2K_d}{\Delta t}) e(t_{k-1}) + \frac{K_d}{\Delta t} e(t_{k-2}), \quad (2)$$

where $\Delta u(t_k) = u(t_k) - u(t_{k-1})$ represents the system output action, K_p and K_d stand for proportional and integral gains, and Δt is the time interval. To maximize the efficiency of high-frequent controlling communication between haptic and simulator, we leverage SWIG to directly warp the HD API of OpenHaptics (original Haptic SDK which is implemented using C/C++) into python to bridge the haptic device with our python-based environment.

C. Realistic Physical Interaction Simulation

Introducing human interactions into the simulator will also introduce some unexpected actions (e.g., sudden movement and destructive behavior). In this regard, we need to further optimize the physical simulation and interaction based on SurRoL for a realistic manipulation experience.

Firstly, to enable realistic simulation of different objects including the surgical instruments, all their articulated bodies are modeled following the real-world ratio using Blender. The contact and inertia attributes (e.g. stiffness and mass) in objects' URDF files are carefully tuned to maximize the similarity to the real-world counterparts. Besides, given that most object assets in surgical tasks are more complicated than a single convex hull or primitive (e.g., boxes, cylinders, and spheres) [17], convex decomposition by V-HACD [37] and collision primitive compound are applied to the meshes to get collision geometry in objects' URDF files for more precise collision detection. However, when there are some destructive behaviors from humans, such as pushing or grasping objects with a very large motion, the inter-penetration problem could happen between surgical instruments and objects, which hurts realism. Besides, the sudden movement of the tool from one place to another place can not be achieved in real surgical robots. Therefore, designing the controller with constraints on force and velocity is of vital importance. Specifically, based on position and velocity PD

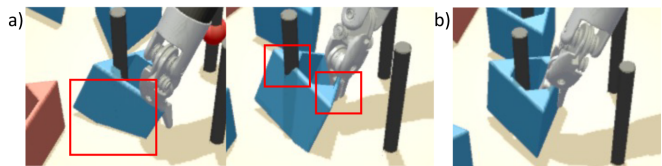

Fig. 4. The example results (a) before and (b) after optimizing physical modeling in *PegTransfer* task (from SurRoL). It shows our proposed method can prevent the inter-penetration problem under unexpected movement, yielding a more realistic interaction between human manipulation and simulator.

control mode, we impose constraints on the output of joint motors when controlling PSMs and ECM. During the step simulation, the underlying designed control algorithms will calculate motor actions under the maximum motor force and velocity limitation to reach the target position. In addition, joint constraints are also utilized in the interaction between grippers and objects for more stable and realistic grasping. An example comparison of before and after optimization of the physical simulation is illustrated in Fig. 4.

D. High-fidelity Surgical Scene Rendering

To develop an authentic human interaction in the simulator, providing the rendered scene with high visual realism is of extreme importance as it is the direct and the only feedback for human perception. In this regard, based on our previously developed simulator, we propose a novel rendering framework to generate realistic scenes which can further improve the visualization results of the simulation. In specific, we adopt the phong shading [38] model in the scene to simulate the lighting reflection and diffusion of the whole virtual environment. Compared to the traditional rendering pipeline [39] using texture, normal maps and specular maps to control the realism of the scene, our adopted method is more similar to the physics of the real world. Moreover, the traditional way of simulating lighting sources is using directional light or ambient models, which are not consistent with the endoscope lighting source that adopts fiber optic guided external light. To simulate this kind of lighting condition, the spotlight model is leveraged, which can achieve a realistic simulation of surgical robot endoscope lighting. In addition, shadow mapping is enabled to simulate the light occlusion and visualize the projected shadow. Last but not least, the previous rendering engine will produce images with an obvious aliasing effect which can affect the human perceptual experience to a large degree. As a result, we enable the anti-aliasing in the rendering pipeline for a more natural visualization. The comparison of the visualization results is shown in Fig. 5, which demonstrates the proposed method can generate more realistic images in terms of lighting, shadow, reflection and fidelity.

The overall rendering pipeline is realized by harvesting the power of OpenGL and the flexible third-party implemented rendering library Panda3D [40], which is a python-based mature rendering engine with realistic rendering results. In the meanwhile, generating such vivid images from the endoscope can largely facilitate the research on image-based

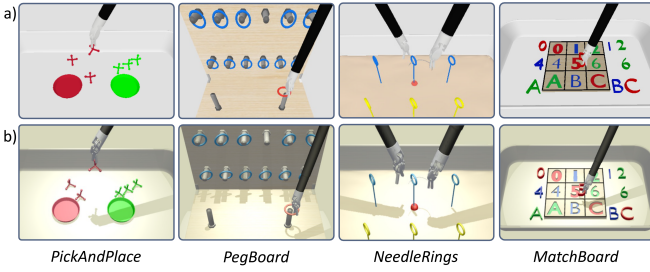

Fig. 5. The visualization results (a) using the original rendering engine from SurRoL, and results (b) using optimized engine for realistic rendering. Four tasks from left to right are *PickAndPlace*, *PegBoard*, *NeedleRings*, *MatchBoard*, respectively. Tasks are described in Sec. III-E.

perception algorithms, such as video features extraction, surgical scene segmentation and action recognition, bridging the gap between the virtual environment and the real world.

E. Surgical Tasks for Both Training and Automation

In the previous version of SurRoL simulator, we designed several surgical robot tasks (e.g., *NeedlePick*, *NeedleRegrasp* and *EcmReach*) to specifically evaluate the robot learning algorithms. Still, these tasks are not sufficient to fulfill the requirements of current and future comprehensive research on surgical training [41], where human interaction is a very important factor. To this end, we add four new tasks following the common curriculum tasks in robotic surgery simulation-based training [42–44], which are representative of the evaluation of both surgical training and task automation. Specifically, we add new tasks of *PickAndPlace*, *PegBoard*, *NeedleRings* and *MatchBoard* (see Fig. 5). In task *PickAndPlace*, the trainee needs to pick up the colored jacks and place them in the tray in the same color. The task will be considered as success only when all the colored jacks are placed on the corresponding trays. In task *PegBoard*, the trainee needs to pick up the ring from the vertical peg board and then place it on the peg from the horizontal board, which requires high proficiency in controlling the pose and orientation of the rings thus effective for trainees to practice their manipulation skills. In task *NeedleRings*, the trainee needs to hand off the needle using two robot arms to pass through the ring, which calls for trainees to master proficient two-handed needle manipulation skills in terms of precise position and orientation control. In task *MatchBoard*, the trainee needs to pick up a digit or alphabet block and place it on groove in the corresponding position, which further practices hand-eye coordination. These tasks are specifically designed and modeled which can be easily extended and applied for further research on surgical training and human-involved robot learning.

F. Surgical Skills Learning from Human Demonstrations

Traditional methods of learning from demonstration focus on exploiting data and knowledge from machine-generated script-based demonstrations, while they could suffer from heavy exploration burden, low success rate, even failures for complex surgical tasks [22]. On the other hand, the surgical procedures which contain delicate and skillful surgical operations by surgeons can not be simply modeled

using straight-forward actions, therefore it is not feasible to generate such humanoid demonstrations with script-based trajectory in the simulator. In this regard, we propose to learn from expert human demonstrations collected using the physical device, and study to what degree can the involvement of humans interactions could affect the learning process.

Specifically, we consider an RL agent interacts with our simulator formulated as a Markov Decision Process. The agent takes an action $a_k \in \mathcal{A}$ at state $s_k \in \mathcal{S}$ according to its policy $\pi : \mathcal{S} \rightarrow \mathcal{A}$ at each time step k . It then receives a reward signal r_k and transits to the successor state s_{k+1} , repeating policy execution until the episode ends, where each experience (s_k, a_k, r_k, s_{k+1}) is stored into a replay buffer \mathcal{D}_A . Meanwhile, the agent maintains another buffer that includes expert demonstrations given in advance. The goal of the agent is to find an optimal policy π^* that maximizes the expectation of discounted cumulative reward (a.k.a. return) with a discount factor $\gamma \in (0, 1]$. Many RL methods achieve this by estimating Q-value function $Q : \mathcal{S} \times \mathcal{A} \rightarrow \mathbb{R}$ that gives the expected return of action a_k at state s_k . We herein adopt deep deterministic policy gradient DDPG [45], a widely-used deep RL method in surgical robot learning [15, 46], to learn a Q-value function Q_θ with parameters θ by minimizing the squared Bellman error:

$$L_Q(\theta) = \mathbb{E}_{\mathcal{D}_A} \left[(r_k + \gamma Q_\theta(s_{k+1}, a_{k+1}) - Q_\theta(s_k, a_k))^2 \right], \quad (3)$$

To overcome the exploration burden, we follow the approach in [47] that utilizes state-action pairs from demonstrations to encourage the behavioral similarity between agent and expert. It realizes this by first pre-training the policy π_ϕ parameterized by ϕ with behavior cloning loss [48], and then minimizing the following objective at the online stage:

$$\mathcal{L}_\pi(\phi) = \mathbb{E}_{\mathcal{D}_A} [-Q_\theta(s_k, \pi_\phi(s_k))] + \mathbb{E}_{\mathcal{D}_E} [\|\pi_\phi(s_k) - a_k\|_2]. \quad (4)$$

We further adopt hindsight experience replay HER [49] as a sampling strategy for both buffers, which addresses the sparse reward issue for goal-conditioned environments. We build our implementation on top of OpenAI baselines [50] and use their hyper-parameter settings for fair comparison.

IV. EXPERIMENTAL RESULTS

A. Experimental Setup

In the experiment, we evaluate our proposed human-in-the-loop learning on task *NeedlePick* as a representative example. *NeedlePick* is an essential surgical training task, where the user needs to manipulate the robot arm to reach and pick up the needle on the tray, and then move it to a targeted location. It contains multiple interactions with the virtual environment thus relevant surgical skill is needed to successfully complete the task. Following the setting in SurRoL, the workspace is set to 10cm^2 , and the tolerance distance between the goal and current state is 0.5cm . Each episode is set to 150 timesteps. The environment will be reset if the user fails within the defined timesteps. The initial and goal conditions are randomly sampled every time the environment resets. We record 100 successful demonstrations from the script

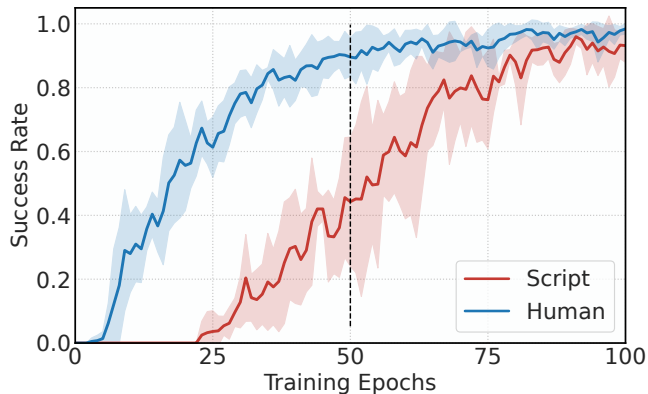

Fig. 6. The success rate learning curve for *NeedlePick* with a sliding window smooth. Results show that policy learned from human demonstrations consistently outperforms the policy learned from script demonstrations over four random seeds. The shaded region represents the standard deviation.

and the human separately. For a fair comparison, the average completion time steps of demonstrations are numerically close with around 109 steps for the script and 110 steps for the human. The average trajectory distance (*cm*) of human demonstrations is longer than the script (19.8 compared to 11.7), as the human tends to perform actions with slightly curvy trajectories and noises compared to the script. All demos are conducted by an engineering student with strong experience in controlling the da Vinci surgical robot in both the real world and the simulator. To systematically evaluate the learned RL policies, we opt for success rate, steps to complete (time cost), and economy of motion (trajectory distance) as the evaluation metrics, which have been commonly adopted to evaluate the surgeons’ skills in the robotic surgery simulation training [14, 43, 44], owing to their effectiveness of representing the level of surgical skills.

B. Efficient RL Training with Human Demonstrations

We compare the learning process and the performance under training steps of 50 epochs (not converged) and 100 epochs (fully converged). We train the policy using four seeds and plot the averaged success rates (see Fig. 6). We can observe that learning from human demonstration consistently outperform learning from scripted demonstrations in terms of the success rate over the training process. Specifically, the learning curves of learning from human demonstrations have smaller deviations than script, indicating the improvement in stability of policy learning. After training for 50 epochs, the averaged success rate of *NeedlePick* achieves $89.8 \pm 6.6\%$ when learning from the human, outperforming learning from the script ($43.2 \pm 21.9\%$ success rate) by more than 46% (as shown in Table II). The policy learned from human demonstration can also master a faster completion time with 39.8 ± 19.1 steps compared to 101.8 ± 27.1 , almost two times faster to finish the task. Moreover, we calculate the average economy of motion and find that the motion trajectories are around 20% shorter with $12.1 \pm 1.4\text{cm}$ for human demonstration and $15.0 \pm 2.5\text{cm}$ for script demonstration. After training converged (around 100 epochs), results demonstrate that learning from human demonstration consistently outperforms

TABLE II
THE EVALUATION RESULTS OF *NeedlePick* IN SIMULATOR.

| Types of Demo | 50 epochs | | 100 epochs | |
|--|----------------------|----------------------------|---------------------|---------------------------|
| | Script | Human | Script | Human |
| Success Rate / % (\uparrow) | 43.2 (± 21.9) | 89.8 (± 6.6) | 93.2 (± 6.9) | 99.0 (± 0.1) |
| Steps to Complete (\downarrow) | 101.8 (± 27.1) | 39.8 (± 19.1) | 24.0 (± 10.4) | 15.0 (± 5.5) |
| Economy of Motion / <i>cm</i> (\downarrow) | 15.0 (± 2.5) | 12.1 (± 1.4) | 13.5 (± 1.6) | 11.6 (± 1.1) |

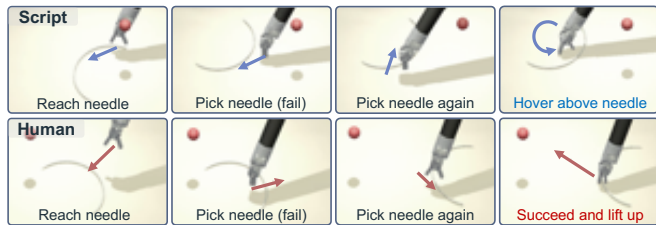

Fig. 7. An example case shows that the policy learned from human demonstrations can master skills of handling failure attempts and then complete the task, while learning from script demonstration cannot.

using script demonstration in terms of all evaluation metrics.

For deeper analysis, we carefully compare the differences between the human demonstration and script. We find that human behavioral patterns contain some biased actions. For example, the instrument mastered by the human sometimes moves in a biased direction when picking the needle, which will then be corrected by the human when approaching the desired location. To some degree, this kind of behavior will increase the sampled location in the whole workspace. We hypothesize that this can be interpreted as a resemble form of data augmentation on the demonstration data, where human demonstration can cover more diverse behavior patterns and offer richer information for RL agents. As a result, the RL policy can learn the task more quickly given better examples. The human demonstration can also alleviate the policy from over-fitting on a narrow workspace thus generating a more robust prediction and achieving better performance.

C. Human Skills Acquisition from Demonstrations

Apart from the above quantitative evaluation results, we further analyze whether there are human skills in the human demonstration that can be learned by the policy. We visualize all the cases in the format of videos, and compare the actions from policies that were learned from the human and the script. A distinct observation has been found as illustrated in Fig. 7. The first row shows a failure case of policy learned from the script, where the instrument first reaches the needle and tries to pick it up, but fails to grasp it. After failing on the first attempt, the policy seems to be confused by the situation and could not grasp the needle again in the following steps. Instead, when learning from human demonstrations, the policy can grasp the needle again and complete the task after failing on the first failure grasping trail. The same patterns can also be found across different cases, showing that policy indeed learns how to handle the failed attempt from the human demonstration thus contributing to performance improvement. We prove over the human demonstrations and observe that they contain around 30% of the samples with such missed behavior correction

skills. This could be a very important and interesting point for human-in-the-loop learning, as in surgical scenarios, the surgeons sometime will also conduct “missed” action but can quickly adapt and correct the action to prevent adverse events from happening. These skills are very useful and also essential to improve the final surgical outcomes. These evidences reveals the fact that involving humans in the loop of surgical robot learning can not only produce more diverse demonstration data to improve the performance of robot learning, but also can provide some human skills to boost the robustness of intelligent policy on surgical task automation.

V. CONCLUSION AND FUTURE WORK

In this paper, we propose an interactive simulation environment based on our existing SurRoL for human-in-the-loop embodied intelligence. New features are added for realistic human interaction, including haptic control mapping, physical simulation with higher realism, and surgical scene rendering with higher fidelity. Four new representative surgical training tasks are also co-developed, which are suitable for future research on human-in-the-loop surgical task learning. We initially conduct key experiments to validate the idea of including humans in embodied intelligence, the promising results prove the effectiveness of our proposed methods and pave the way for relevant research topics. We envisage extensive future works to explore how human factors can play a role and transform surgical robot learning through our provided open-source embodied AI platform for surgical robots.

REFERENCES

- [1] R. H. Taylor, N. Simaan, A. Menciassi, and G.-Z. Yang, “Surgical robotics and computer-integrated interventional medicine,” *Proceedings of the IEEE*, vol. 110, no. 7, pp. 823–834, 2022.
- [2] C. D’Ettorre, A. Mariani, A. Stilli, P. Valdastri, A. Deguet, P. Kazanzides, R. H. Taylor, G. S. Fischer, S. P. DiMaio, A. Menciassi, et al., “Accelerating surgical robotics research: Reviewing 10 years of research with the dvrk,” *arXiv preprint arXiv:2104.09869*, 2021.
- [3] G.-Z. Yang, J. Bellingham, P. E. Dupont, P. Fischer, L. Floridi, R. Full, N. Jacobstein, V. Kumar, M. McNutt, R. Merrifield, et al., “The grand challenges of science robotics,” *Science robotics*, vol. 3, no. 14, p. eaar7650, 2018.
- [4] L. Maier-Hein, M. Eisenmann, D. Sarikaya, K. März, T. Collins, A. Malpani, J. Fallert, H. Feussner, S. Giannarou, P. Mascagni, et al., “Surgical data science—from concepts toward clinical translation,” *Medical image analysis*, vol. 76, p. 102306, 2022.
- [5] J. Duan, S. Yu, H. L. Tan, H. Zhu, and C. Tan, “A survey of embodied ai: From simulators to research tasks,” *IEEE Transactions on Emerging Topics in Computational Intelligence*, 2022.
- [6] J. Ibarz, J. Tan, C. Finn, M. Kalakrishnan, P. Pastor, and S. Levine, “How to train your robot with deep reinforcement learning: lessons we have learned,” *The International Journal of Robotics Research*, vol. 40, no. 4-5, pp. 698–721, 2021.
- [7] R. Ramrakhya, E. Undersander, D. Batra, and A. Das, “Habitat-web: Learning embodied object-search strategies from human demonstrations at scale,” in *Proceedings of the IEEE/CVF Conference on Computer Vision and Pattern Recognition*, 2022, pp. 5173–5183.
- [8] C. Li, F. Xia, R. Martín-Martín, M. Lingelbach, S. Srivastava, B. Shen, K. Vainio, C. Gokmen, G. Dharan, T. Jain, et al., “igibson 2.0: Object-centric simulation for robot learning of everyday household tasks,” *arXiv preprint arXiv:2108.03272*, 2021.
- [9] F. Xiang, Y. Qin, K. Mo, Y. Xia, H. Zhu, F. Liu, M. Liu, H. Jiang, Y. Yuan, H. Wang, L. Yi, A. X. Chang, L. J. Guibas, and H. Su, “SAPIEN: A simulated part-based interactive environment,” in *The IEEE Conference on Computer Vision and Pattern Recognition (CVPR)*, June 2020.
- [10] S. Bonne, W. Panitch, K. Dharmarajan, K. Srinivas, J.-L. Kincade, T. Low, B. Knoth, C. Cowan, D. Fer, B. Thananjeyan, et al., “A digital twin framework for telesurgery in the presence of varying network quality of service,” in *2022 IEEE 18th International Conference on Automation Science and Engineering (CASE)*. IEEE, 2022, pp. 1325–1332.
- [11] H. Shu, R. Liang, Z. Li, A. Goodridge, X. Zhang, H. Ding, N. Naguru, M. Sahu, F. X. Creighton, R. H. Taylor, et al., “Twin-s: A digital twin for skull-base surgery,” *arXiv preprint arXiv:2211.11863*, 2022.
- [12] E. Kolve, R. Mottaghi, W. Han, E. VanderBilt, L. Weihs, A. Herrasti, D. Gordon, Y. Zhu, A. Gupta, and A. Farhadi, “AI2-THOR: An Interactive 3D Environment for Visual AI,” *arXiv*, 2017.
- [13] P. A. Kenney, M. F. Wszolek, J. J. Gould, J. A. Libertino, and A. Moizadeh, “Face, content, and construct validity of dv-trainer, a novel virtual reality simulator for robotic surgery,” *Urology*, vol. 73, no. 6, pp. 1288–1292, 2009.
- [14] G. Whittaker, A. Aydin, N. Raison, F. Kum, B. Challacombe, M. S. Khan, P. Dasgupta, and K. Ahmed, “Validation of the robotix mentor robotic surgery simulator,” *Journal of endourology*, vol. 30, no. 3, pp. 338–346, 2016.
- [15] F. Richter, R. K. Orosco, and M. C. Yip, “Open-sourced reinforcement learning environments for surgical robotics,” *arXiv preprint arXiv:1903.02090*, 2019.
- [16] E. Tagliabue, A. Pore, D. Dall’Alba, E. Magnabosco, M. Piccinelli, and P. Fiorini, “Soft tissue simulation environment to learn manipulation tasks in autonomous robotic surgery,” in *2020 IEEE/RSJ International Conference on Intelligent Robots and Systems (IROS)*. IEEE, 2020, pp. 3261–3266.
- [17] A. Munawar, J. Y. Wu, G. S. Fischer, R. H. Taylor, and P. Kazanzides, “Open simulation environment for learning and practice of robot-assisted surgical suturing,” *IEEE Robotics and Automation Letters*, vol. 7, no. 2, pp. 3843–3850, 2022.
- [18] G.-Z. Yang, J. Cambias, K. Cleary, E. Daimler, J. Drake, P. E. Dupont, N. Hata, P. Kazanzides, S. Martel, R. V. Patel, et al., “Medical robotics—regulatory, ethical, and legal considerations for increasing levels of autonomy,” p. eaam8638, 2017.
- [19] H. Saedi, J. D. Opfermann, M. Kam, S. Wei, S. Léonard, M. H. Hsieh, J. U. Kang, and A. Krieger, “Autonomous robotic laparoscopic surgery for intestinal anastomosis,” *Science Robotics*, vol. 7, no. 62, p. eabj2908, 2022.
- [20] D. Zhang, Y. Guo, J. Chen, J. Liu, and G.-Z. Yang, “A handheld master controller for robot-assisted microsurgery,” in *2019 IEEE/RSJ International Conference on Intelligent Robots and Systems (IROS)*. IEEE, 2019, pp. 394–400.
- [21] D. Zhang, Z. Wu, J. Chen, R. Zhu, A. Munawar, B. Xiao, Y. Guan, H. Su, W. Hong, Y. Guo, et al., “Human-robot shared control for surgical robot based on context-aware sim-to-real adaptation,” *arXiv preprint arXiv:2204.11116*, 2022.
- [22] J. Xu, B. Li, B. Lu, Y.-H. Liu, Q. Dou, and P.-A. Heng, “Surrol: An open-source reinforcement learning centered and dvrk compatible platform for surgical robot learning,” in *2021 IEEE/RSJ International Conference on Intelligent Robots and Systems (IROS)*. IEEE, 2021.
- [23] K. Ehsani, W. Han, A. Herrasti, E. VanderBilt, L. Weihs, E. Kolve, A. Kembhavi, and R. Mottaghi, “Manipulator: A framework for visual object manipulation,” *2021 IEEE/CVF Conference on Computer Vision and Pattern Recognition (CVPR)*, pp. 4495–4504, 2021.
- [24] C. Gan, J. Schwartz, S. Alter, M. Schrimpf, J. Traer, J. De Freitas, J. Kubilius, A. Bhandwadar, N. Haber, M. Sano, et al., “Threedworld: A platform for interactive multi-modal physical simulation,” *arXiv preprint arXiv:2007.04954*, 2020.
- [25] H. Fu, W. Xu, H. Xue, H. Yang, R. Ye, Y. Huang, Z. Xue, Y. Wang, and C. Lu, “Rfuniverse: A physics-based action-centric interactive environment for everyday household tasks,” *arXiv preprint arXiv:2202.00199*, 2022.
- [26] A. Mandlekar, D. Xu, J. Wong, S. Nasiriany, C. Wang, R. Kulkarni, L. Fei-Fei, S. Savarese, Y. Zhu, and R. Martín-Martín, “What matters in learning from offline human demonstrations for robot manipulation,” *arXiv preprint arXiv:2108.03298*, 2021.
- [27] S. Sen, A. Garg, D. V. Gealy, S. McKinley, Y. Jen, and K. Goldberg, “Automating multi-throw multilateral surgical suturing with a mechanical needle guide and sequential convex optimization,” in *2016 IEEE international conference on robotics and automation (ICRA)*. IEEE, 2016, pp. 4178–4185.
- [28] T. Osa, C. Staub, and A. Knoll, “Framework of automatic robot surgery system using visual servoing,” in *2010 IEEE/RSJ International Conference on Intelligent Robots and Systems (IROS)*. IEEE, 2010, pp. 1837–1842.

- [29] B. W. King, L. A. Reisner, A. K. Pandya, A. M. Composto, R. D. Ellis, and M. D. Klein. "Towards an autonomous robot for camera control during laparoscopic surgery," *Journal of laparoendoscopic & advanced surgical techniques*, vol. 23, no. 12, pp. 1027–1030, 2013.
- [30] I. Rivas-Blanco, C. J. Perez-del Pulgar, C. López-Casado, E. Bauzano, and V. F. Muñoz, "Transferring know-how for an autonomous camera robotic assistant," *Electronics*, vol. 8, no. 2, p. 224, 2019.
- [31] I. Rivas-Blanco, B. Estebanez, M. Cuevas-Rodríguez, E. Bauzano, and V. F. Muñoz, "Towards a cognitive camera robotic assistant," in *5th IEEE RAS/EMBS International Conference on Biomedical Robotics and Biomechanics*. IEEE, 2014, pp. 739–744.
- [32] T. P. Lillicrap, J. J. Hunt, A. Pritzel, N. Heess, T. Erez, Y. Tassa, D. Silver, and D. Wierstra, "Continuous control with deep reinforcement learning," in *International Conference on Learning Representations (ICLR)*, 2016.
- [33] M. Yip and N. Das, "Robot autonomy for surgery," in *The Encyclopedia of MEDICAL ROBOTICS: Volume 1 Minimally Invasive Surgical Robotics*. World Scientific, 2019, pp. 281–313.
- [34] M. Vecerik, T. Hester, J. Scholz, F. Wang, O. Pietquin, B. Piot, N. Heess, T. Rothörl, T. Lampe, and M. Riedmiller, "Leveraging demonstrations for deep reinforcement learning on robotics problems with sparse rewards," *arXiv preprint arXiv:1707.08817*, 2017.
- [35] B. Li, R. Wei, J. Xu, B. Lu, C. H. Yee, C. F. Ng, P.-A. Heng, Q. Dou, and Y.-H. Liu, "3d perception based imitation learning under limited demonstration for laparoscope control in robotic surgery," in *2022 International Conference on Robotics and Automation (ICRA)*. IEEE, 2022, pp. 7664–7670.
- [36] M. A. Arteaga, A. Gutiérrez-Giles, and J. Pliego-Jiménez, "The geomagic touch haptic device," in *Local Stability and Ultimate Boundedness in the Control of Robot Manipulators*. Springer, 2022, pp. 361–374.
- [37] K. Mamou, E. Lengyel, and A. Peters, "Volumetric hierarchical approximate convex decomposition," in *Game Engine Gems 3*. AK Peters, 2016, pp. 141–158.
- [38] G. Bishop and D. M. Weimer, "Fast phong shading," *ACM SIGGRAPH Computer Graphics*, vol. 20, no. 4, pp. 103–106, 1986.
- [39] H. Gouraud, "Continuous shading of curved surfaces," *IEEE transactions on computers*, vol. 100, no. 6, pp. 623–629, 1971.
- [40] M. Goslin and M. R. Mine, "The panda3d graphics engine," *Computer*, vol. 37, no. 10, pp. 112–114, 2004.
- [41] Y. Long, J. Cao, A. Deguet, R. H. Taylor, and Q. Dou, "Integrating artificial intelligence and augmented reality in robotic surgery: An initial dvrc study using a surgical education scenario," in *2022 International Symposium on Medical Robotics (ISMR)*, 2022, pp. 1–8.
- [42] D. Sanford, R. Ma, A. Ghoreifi, T. F. Haque, J. Nguyen, and A. J. Hung, "Association of suturing technical skill assessment scores between virtual reality simulation and live surgery," *Journal of Endourology*, no. ja, 2022.
- [43] C. Perrenot, M. Perez, N. Tran, J.-P. Jehl, J. Felblinger, L. Bresler, and J. Hubert, "The virtual reality simulator dv-trainer® is a valid assessment tool for robotic surgical skills," *Surgical endoscopy*, vol. 26, no. 9, pp. 2587–2593, 2012.
- [44] A. Cowan, J. Chen, S. Mingo, S. S. Reddy, R. Ma, S. Marshall, J. H. Nguyen, and A. J. Hung, "Virtual reality vs dry laboratory models: Comparing automated performance metrics and cognitive workload during robotic simulation training," *Journal of Endourology*, vol. 35, no. 10, pp. 1571–1576, 2021.
- [45] T. P. Lillicrap, J. J. Hunt, A. Pritzel, N. Heess, T. Erez, Y. Tassa, D. Silver, and D. Wierstra, "Continuous control with deep reinforcement learning," in *International Conference on Learning Representations (ICLR)*, 2016.
- [46] C. D’Ettorre, S. Zirino, N. N. Dei, A. Stilli, E. De Momi, and D. Stoyanov, "Learning intraoperative organ manipulation with context-based reinforcement learning," *International Journal of Computer Assisted Radiology and Surgery*, 2022.
- [47] V. G. Goecks, G. M. Gremillion, V. J. Lawhern, J. Valasek, and N. R. Waytowich, "Integrating behavior cloning and reinforcement learning for improved performance in dense and sparse reward environments," in *Proceedings of the 19th International Conference on Autonomous Agents and MultiAgent Systems*, 2020, pp. 465–473.
- [48] M. Bain and C. Sammut, "A framework for behavioural cloning," in *Machine Intelligence 15*, 1995, pp. 103–129.
- [49] M. Andrychowicz, F. Wolski, A. Ray, J. Schneider, R. Fong, P. Welinder, B. McGrew, J. Tobin, O. P. Abbeel, and W. Zaremba, "Hindsight experience replay," in *Neural Information Processing Systems (NeurIPS)*, 2017.
- [50] P. Dhariwal, C. Hesse, O. Klimov, A. Nichol, M. Plappert, A. Radford, J. Schulman, S. Sidor, Y. Wu, and P. Zhokhov, "Openai baselines," <https://github.com/openai/baselines>, 2017.