

TargetCall: Eliminating the Wasted Computation in Basecalling via Pre-Basecalling Filtering

Meryem Banu Cavlak¹ Gagandeep Singh¹ Mohammed Alser¹ Can Firtina¹ Joël Lindegger¹
Mohammad Sadrosadati¹ Nika Mansouri Ghiasi¹ Can Alkan² Onur Mutlu¹

¹ETH Zürich

²Bilkent University

Basecalling is an essential step in nanopore sequencing analysis where the raw signals of nanopore sequencers are converted into nucleotide sequences, i.e., reads. State-of-the-art basecallers employ complex deep learning models to achieve high basecalling accuracy. This makes basecalling computationally-inefficient and memory-hungry; bottlenecking the entire genome analysis pipeline. However, for many applications, the majority of reads do not match the reference genome of interest (i.e., target reference) and thus are discarded in later steps in the genomics pipeline, wasting the basecalling computation.

To overcome this issue, we propose TargetCall, the first pre-basecalling filter to eliminate the wasted computation in basecalling. TargetCall’s key idea is to discard reads that will not match the target reference (i.e., off-target reads) prior to basecalling. TargetCall consists of two main components: (1) LightCall, a lightweight neural network basecaller that produces noisy reads; and (2) Similarity Check, which labels each of these noisy reads as on-target or off-target by matching them to the target reference. TargetCall aims to filter out all off-target reads before basecalling. The highly-accurate but slow basecalling is performed only on the raw signals whose noisy reads are labeled as on-target.

Our thorough experimental evaluations using both real and simulated data show that TargetCall 1) improves the end-to-end basecalling performance of the state-of-the-art basecaller by $3.31\times$ while maintaining high (98.88%) sensitivity in keeping on-target reads, 2) maintains high accuracy in downstream analysis, 3) precisely filters out up to 94.71% of off-target reads, and 4) achieves better performance, throughput, sensitivity, precision, and generality compared to prior works. We open-source TargetCall to aid future research in pre-basecalling filtering at <https://github.com/CMU-SAFARI/TargetCall>

1. Introduction

Genome sequencing, which determines the nucleotide sequence of an organism’s genome, plays a pivotal role in enabling many medical and scientific advancements [1–5]. Modern sequencing technologies produce increasingly large amounts of genomic data at low cost [6]. Leveraging this genomic data requires new fast, efficient, and accurate analysis tools.

Current sequencing machines are unable to determine an organism’s genome as a single contiguous sequence [7]. Instead, they sequence fragments of a genome, called reads. The length of the reads depends on the sequencing technology, and significantly affects the performance and accuracy of genome analysis. The use of long reads can provide higher accuracy and performance on many genome analysis steps [8–13].

Nanopore sequencing technology is one of the most prominent and widely-used long read sequencing technologies, for example used by Oxford Nanopore Technologies (ONT) sequencers [6, 14–18]. Nanopore sequencing relies on measuring the change in the electrical current when a nucleic acid molecule (DNA or RNA) passes through a pore of nanometer size [19]. The measurement of the electrical current, called a raw signal,

is converted to a nucleotide sequence, called a read, with a step called basecalling [6, 7, 20–23]. Basecalling commonly uses computationally expensive deep neural network (DNN)-based architectures to achieve high basecalling accuracy [24–26], which makes basecalling a computational bottleneck for genome analysis that consumes up to 84.2% of total execution time in genome analysis pipeline [27]. However, the majority of this computation is wasted for genome sequencing applications that do not require the majority of the basecalled reads. For example, in SARS-CoV-2 genome assembly, 96% of the total runtime is spent on basecalling, even though $\geq 99\%$ of the basecalled reads are not required after basecalling because they are not coming from the reference genome that is targeted by the application [28]. Therefore, it is important to eliminate wasted computation in basecalling.

Our goal in this work is to eliminate the wasted computation in basecalling while maintaining high accuracy and applicability to a wide range of genome sequencing applications. To this end, we propose TargetCall, the first pre-basecalling filter. TargetCall is based on the key observation that typically the reason for discarding basecalled reads is that they do not match some target reference (e.g., a reference genome of interest) [28, 29]. We call these off-target reads. Our key idea is to filter out off-target reads before basecalling with a highly accurate and high-performance pre-basecalling filter to eliminate the wasted computation in basecalling of off-target reads.

Prior works in targeted sequencing [19, 28, 30, 31] propose adaptive sampling techniques to discard off-target reads during sequencing to better utilize sequencers. ONT devices can enable adaptive sampling with a feature, known as Read Until [30, 32]. ONT sequencers that support Read Until can selectively remove a read from the nanopore while the read is being sequenced. This requires a method to identify which reads are off-target for further downstream analysis to decide which reads to remove from the nanopore. The state-of-the-art adaptive sampling methods can be classified into three groups on their methodology to label the read. The first group converts the target reference into a reference raw signal and performs raw signal-level alignment [19, 28, 32]. The second group generates noisy sequence representations of the raw signal to compare them with the target reference [30, 33]. The third group of works utilize neural network classifiers to label the sequences [31, 34]. We provide a detailed background on different adaptive sampling approaches in Section 1 of the Supplementary Materials.

Even though the labelling techniques of the adaptive sampling works can be repurposed to label off-target reads for pre-basecalling filtering to reduce wasted computation in basecalling, the adaptive sampling problem is different than the pre-basecalling filtering problem. In adaptive sampling the reads should be labelled while they are being sequenced, which makes it necessary for the adaptive sampling methods to use only initial portions of the raw signal of a read to classify the read as off-

target or on-target. In contrast, a pre-basecalling filter can utilize the entire raw signal information to make the classification of a read as off-target or on-target since the decision is made after the read is fully sequenced. State-of-the-art adaptive sampling methods that do not utilize the entire raw signal information have at least one of the following three key limitations, preventing them to be used as *widely applicable* pre-basecalling filters. First, some have low (77.5%–90.40%) sensitivity (i.e., they falsely reject many on-target reads) [19, 30]. Second, some are limited to a target reference size smaller than ~ 100 Mbp, i.e., they cannot be applied to longer target references without degrading the performance or accuracy significantly, such as the human reference genome [19, 28, 30]. Third, some require re-training neural network based classifiers for each different application and target reference [31]. Therefore, we conclude that none of these works can be fully repurposed as *widely applicable* pre-basecalling filters as they either cannot be accurately applied to *all* target reference sizes or cannot be used as general purpose pre-basecalling filters without further re-training. TargetCall aims to overcome all these challenges by defining the pre-basecalling problem independent of the adaptive sampling problem by using the entire raw signal information to label the read as off-target or on-target.

TargetCall consists of two main components: 1) *LightCall*, a light-weight basecaller with a simple neural network model that outputs erroneous (i.e., noisy) reads with high performance; and 2) *Similarity Check* to compute the similarity of the noisy read to the target reference where the similarity is determined by conventional read mapping pipeline. LightCall’s model is $33.31\times$ smaller than the state-of-the-art basecaller, Bonito’s model [35], which improves the basecalling speed substantially with small (4.85%) reduction in basecalling accuracy. Although reducing the basecalling accuracy might cause LightCall to be not applicable to some of the downstream analyses that require high basecalling accuracy [36], it is sufficient for Similarity Check to perform pre-basecalling filtering. We use the state-of-the-art read mapper minimap2 [37] for Similarity Check. TargetCall overcomes all three limitations of prior methods. First, Similarity Check’s high sensitivity enables TargetCall’s sensitivity to be significantly higher than prior adaptive sampling approaches. Second, LightCall’s performance is independent of the target reference size, which enables TargetCall to be applicable to target reference sizes for which prior works were unapplicable. Third, unlike prior approaches that require re-training of the network for each application and target reference, LightCall does not need to be re-trained.

Key Results. We evaluate the performance and accuracy impact of TargetCall on the state-of-the-art basecaller Bonito [35], and compare TargetCall with two state-of-the-art adaptive sampling methods, UNCALLED [30] and Sigmap [19], repurposed as pre-basecalling filters. TargetCall 1) improves the end-to-end performance of basecalling by $3.31\times$ over Bonito, 2) precisely filters out 94.71% of the off-target reads, and 3) maintains high sensitivity in keeping on-target reads with 98.88% recall. We show that TargetCall provides near-perfect downstream analysis accuracy even after losing 1.12% of on-target reads. We demonstrate that TargetCall improves 1) performance by $1.46\times/9.76\times$, 2) throughput by $1124.03\times/42.08\times$, 3) sensitivity by $+3.09\%/+23.15\%$, and 4) precision by $+58.48\%/+62.31\%$ over prior works UNCALLED/Sigmap while requiring much less

peak memory (on average $5.76\times$) and maintaining scalability to longer target references.

This paper makes the following contributions:

- We introduce the problem of pre-basecalling filtering that aims to classify the nanopore raw signals utilizing the entire raw signal information.
- We introduce the first pre-basecalling filter that eliminates the wasted computation in basecalling by leveraging the fact that the majority of reads are discarded after basecalling.
- We propose LightCall, a light-weight neural network model that significantly increases the performance of basecalling with minor reductions in basecalling accuracy.
- TargetCall provides larger performance and accuracy benefits compared to the state-of-the-art adaptive sampling works for basecalling while being applicable to large target reference sizes as well.
- To aid research and reproducibility, we freely open source our implementation of TargetCall.

2. Methods

Our goal in this work is to eliminate the wasted computation in basecalling using an accurate pre-basecalling filtering technique. To this end, we propose TargetCall, that can perform pre-basecalling filtering in *all* genome sequencing applications accurately and efficiently without any additional overhead. To our knowledge, TargetCall is the first pre-basecalling filter that is applicable to a wide range of use cases and makes use of entire raw signal information to classify nanopore raw signals. TargetCall’s key idea is to quickly filter out off-target reads (i.e., reads that are dissimilar to the *target reference*.) before the basecalling step to eliminate the wasted computation in basecalling. We present the high level overview of TargetCall in Section 2.1, and explain its components in Sections 2.2 and 2.3.

2.1. High Level Overview

Figure 1 shows TargetCall’s workflow. First, TargetCall performs noisy basecalling on the raw signal using LightCall ①. The output sequence of LightCall is a highly accurate but erroneous compared to the reads basecalled using state-of-the-art basecallers. Second, Similarity Check compares the noisy read of LightCall to the target reference for labelling the read as an on-target or off-target read ②. TargetCall stops the analysis of off-target reads by removing them from the pipeline ③, whereas the analysis of the on-target reads continues with basecalling following the usual genomics pipeline to maintain basecalling accuracy ④.

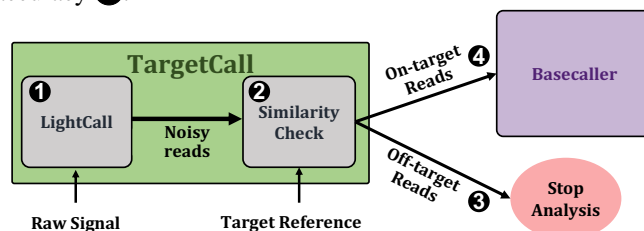

Figure 1: High-level overview of TargetCall.

The choice of the target reference depends on the specific genome sequencing application. The size of target reference is a major constraint in most prior works, limiting the generality of the prior approaches. We design TargetCall such that its runtime performance scales well with the size of the target reference so that it is applicable to any genome sequencing application. We

achieve our design goal because 1) the performance of LightCall is independent of the size of the target reference, and 2) the performance of Similarity Check module scales well with the increasing target reference size.

2.2. LightCall

LightCall, the first component of TargetCall, is a light-weight neural network based basecaller that produces noisy reads. Although LightCall is not designed to be as accurate as the state-of-the-art basecallers, its combination with Similarity Check is effective in determining if the read is an on-target read with respect to the target reference. We develop LightCall by modifying the state-of-the-art basecaller Bonito’s architecture in three ways: 1) reducing the channel sizes of convolution layers, 2) removing the skip connections, and 3) reducing the number of basic convolution blocks. Prior work [26] shows that Bonito’s model is over-provisioned, and we can maintain very high accuracy with reduced model sizes. Following prior work’s insight, we generate different neural network models by pruning the channel sizes of convolution and convolution blocks. The specific LightCall configurations tested are designed based on our intuition. We select the neural network architecture for LightCall that balances basecalling accuracy with the pre-basecalling filtering performance.

Figure 2 shows the architecture of LightCall. Each block consists of grouped 1-dimensional convolution and pointwise 1-dimensional convolution. The convolution operation is followed by batch normalization (Batch Norm) [38] and a rectified linear unit (ReLU) [39] activation function. The final output is passed through a connectionist temporal classification (CTC) [40] layer to produce the decoded sequence of nucleotides (A, C, G, T). CTC layer acts as the loss function by providing the correct alignment between the input and the output sequence. The CTC loss allows the model to handle the variable-length sequences by aligning the model’s output to the target sequence while ignoring the blank or padding symbols. Our LightCall architecture is composed of 18 convolution blocks containing ~ 292 thousand model parameters ($\sim 33.35\times$ lower parameters than Bonito).

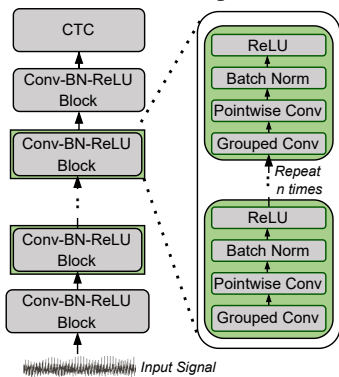

Figure 2: Overview of LightCall architecture.

Modern deep learning-based basecallers [20, 21, 26, 41–46] incorporate skip connections to help mitigate the vanishing gradient and saturation problems [47]. Removing skip connections has a higher impact on basecalling accuracy. However, adding skip connections introduces the following three issues for performance. First, skip connections increases the data lifetime. The layers whose activations are reused in subsequent layers must wait for this activation reuse (or buffer the activations in memory) before accepting new input and continuing to compute.

This leads to high resource and storage requirements due to data duplication. Second, skip connections introduce irregularity in neural network architecture as these connections span across non-adjacent layers. Third, skip connections require additional computation to adjust the channel size to match the channel size at the non-consecutive layer’s input. Therefore, we remove the skip connections as we can tolerate lower accuracy of LightCall to improve performance of TargetCall.

LightCall works by splitting a long read in raw signal format (e.g., millions of samples) into multiple smaller chunks (e.g., thousands of samples per chunk) and basecalling these chunks. The CTC layer assigns a probability for all possible labels (i.e., A, C, G, T) at each sequence position for a chunk. The label with the highest probability is selected as the final output for a sequence position. LightCall merges the outputs of each position to produce the basecalled chunk, and merges the basecalled chunks to output the basecalled read. Since LightCall’s algorithm is independent of the target reference, LightCall’s performance does not depend on the target reference length.

2.3. Similarity Check

After LightCall outputs the noisy read that approximately represents the raw signal, Similarity Check compares the noisy read to the target reference. For this task, we use a procedure common in many genome analysis, known as the sequence alignment. Sequence alignment computes the similarity between a read and a reference. We use the state-of-the-art read mapping tool that performs sequence alignment (i.e., minimap2 [37]) for Similarity Check. Similarity Check labels a read that is similar to the target reference, i.e., a read that maps to the target reference, as on-target. With the efficient index structure of minimap2, the performance of sequence alignment is almost independent of the length of the target reference genome, hence, TargetCall is scalable to large target reference genomes of Gbp (i.e., Giga base pair) length.

The accuracy of the computed sequence alignments is not high enough to represent the true alignment between the read and the target reference since the reads computed by LightCall are noisy. However, the labelling accuracy of Similarity Check for determining the on-target/off-target reads is high enough to provide sensitivity up to 99.45% in filtering reads. The minor inaccuracy of Similarity Check can be compensated with the high sequencing depth-of-coverage, the average number of reads that align to a genomic region, required for confident genome sequence analysis [48–51].

3. Evaluation

3.1. Evaluation Methodology

Evaluated Use Cases. To show the applicability of TargetCall, we evaluate it on use cases with varying target reference sizes without compromising accuracy. We describe three use cases we use to evaluate TargetCall: (1) Covid Detection, (2) Sepsis Detection, and (3) Viral Detection. All three use cases contain a significant fraction of off-target reads that are eliminated using TargetCall to show the benefits of pre-basecalling filtering.

Covid Detection. The first use case aims to accept reads coming from a small target reference. We choose SARS-CoV-2 detection as a sample biological application where the goal is to detect the reads coming from a SARS-CoV-2 reference genome (~ 30 Kbp) from a sample taken from a human, and filter out the human reads in the sample [28, 52].

Sepsis Detection. The second use case aims to filter reads when the target reference is large (~ 3 Gbp) to show TargetCall is applicable to use cases with large target references. We choose sepsis detection [29, 53, 54] as a sample biological application where the goal is to delete the human reads from a human sample. Since the bacteria that is causing the disease is unknown, we cannot search for reads coming from a specific bacterial target. Instead, we apply TargetCall to filter-out reads similar to the target reference.

Viral Detection. The third use case aims to filter reads when the target reference contains collection of reference genomes to show TargetCall can correctly filter reads when the sample and the target reference have a high variety of species. This is to test the specificity of TargetCall in filtering reads when the on-target and off-target reads resemble each other more compared to previous use cases. We choose disease-causing viral read detection as a sample biological application where the goal is to detect the viral reads from a metagenomic sample of bacterial & viral reads, and the target reference contains collection of viral reference genomes [55].

Evaluation System. We use NVIDIA TITAN V to train and evaluate LightCall and Bonito baseline. For our evaluations, we increase the batch size maximally such that entire GPU memory is occupied (Sections 3.2, 3.3, 3.4, 3.5). We use NVIDIA A100 to evaluate TargetCall against prior work. We evaluate UNCALLED and Sigmap on a high-end server (AMD EPYC 7742 CPU with 1TB DDR4 DRAM). For our evaluations, we optimize the number of threads (128) for UNCALLED/Sigmap and the batch size (128) for TargetCall such that all tools have the minimum execution time (Section 3.6). We use the state-of-the-art read mapper, minimap2 [37] for the Similarity Check module of TargetCall with -a and -x map-ont flags. The -a flag is used to compute sequence alignments and -x map-ont is used to configure minimap2 parameters for ONT data.

Training Setting. We use the publicly available ONT dataset [35] sequenced using MinION Flow Cell (R9.4.1) [56] for the training and validation. The neural network weights are updated using Adam [57] optimizer with a learning rate of $2e^{-3}$, a beta value of 0.999, a weight decay of 0.01, and an epsilon of $1e^{-8}$.

Baseline Techniques. We evaluate TargetCall’s performance and accuracy as a pre-basecalling filter by integrating it as a pre-basecalling filter to Bonito [35], which is one of the official basecalling tool developed by ONT. In Section 3.6, we evaluate two state-of-the-art, non-machine learning based adaptive sampling methods, UNCALLED [30] and Sigmap [19] repurposed as pre-basecalling filters to compare against TargetCall. We repurposed UNCALLED and Sigmap by using their classification methods to classify the reads as on-target/off-target before the basecalling step without any change in their implementations. We do not evaluate TargetCall against other adaptive sampling methods such as SquiggleNet [31] that cannot be trivially used as pre-basecalling filters.

LightCall Configurations Evaluated. To determine the final architecture of TargetCall, we test 5 different LightCall configurations. Table 1 lists the LightCall configurations evaluated.

Evaluated Datasets. We sampled 287,767 reads from prior work [20, 58, 59] and simulated 35,000 reads using DeepSimulator [60, 61] to evaluate TargetCall. We use four reference genomes to evaluate TargetCall on three different genome sequencing applications. The details of the exact read datasets and

Table 1: Different LightCall configurations.

Model Name	Basecalling Accuracy	Number of Parameters	Model Size (MB)
Bonito	94.60%	9,739K	37.14
$LC_{Main \times 2}$	90.91%	565K	2.16
LC_{Main}	89.75%	292K	1.11
$LC_{Main/2}$	86.83%	146K	0.55
$LC_{Main/4}$	80.82%	52K	0.19
$LC_{Main/8}$	70.42%	21K	0.07

reference genomes used to produce all our results can be found in Section 2 of the Supplementary Materials.

Evaluation Metrics. We evaluate TargetCall using four different metrics: 1) filtering accuracy, 2) end-to-end accuracy, 3) basecalling execution time, and 4) end-to-end execution time.

We evaluate the filtering accuracy of TargetCall by computing its precision and recall. We define precision as the number of reads that TargetCall correctly labels as on-target, divided by the total number of reads that TargetCall labels as on-target. We define recall as the number of reads that TargetCall correctly labels as on-target, divided by the overall number of on-target reads in the dataset. The ground truth on-target reads are determined by the conventional pipeline of basecalling with Bonito and read mapping. An ideal pre-basecalling filter should have 100% recall to maintain accuracy in the downstream analyses and 100% precision to provide maximum performance improvement possible.

For the end-to-end accuracy, we calculate the difference of relative abundances of species after 1) pre-basecalling filtering and 2) conventional basecalling. We compute how much relative abundances (RA) after pre-basecalling filtering is deviated from the true RAs. Equation (1) provides the calculation of the deviation in RAs where TC_RA_i is the RA of species i after TargetCall; and B_RA_i is the RA of species i after conventional basecalling with Bonito.

$$\sum_{\text{for each species } i} 100 * \frac{|TC_RA_i - B_RA_i|}{B_RA_i} \quad (1)$$

For the basecalling execution time, we compare the wall-clock time spent on pre-basecalling filtering followed by basecalling of the reads that are accepted by the filter and conventional basecalling. The index generation time of minimap2 is excluded from end-to-end execution time, as this is a one-time task per reference genome.

For the end-to-end execution time, we compare the wall-clock time spent on entire genome analysis pipeline of basecalling, read mapping and variant calling with and without the use of pre-basecalling filtering.

3.2. Filtering Accuracy

In Figures 3 and 4, we assess the precision and recall of TargetCall with different LightCall configurations for all use cases explained in Section 3.1, respectively. We make four key observations. First, TargetCall’s precision and recall is between 73.59%-96.03% and 42.57%-99.45% for different configurations of LightCall on average across all three use cases tested, respectively. Second, the precision and recall of TargetCall increases as the model complexity of LightCall increases. Third, increasing

the model complexity provides diminishing precision and recall improvements after the LC_{Main} 's model complexity. Fourth, models smaller than LC_{Main} are sufficient for use cases with small-to-medium target reference sizes, whereas more complex models are required for use cases with large target reference sizes. We conclude that LC_{Main*2} provides the highest precision and highest recall compared to other LightCall configurations.

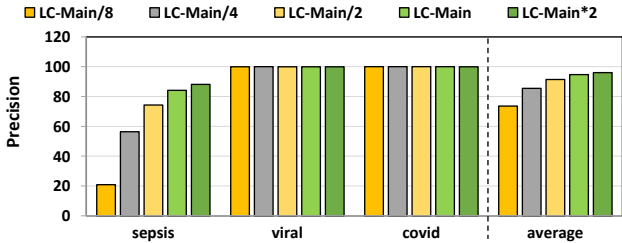

Figure 3: Precision for our evaluated use-cases while using TargetCall with different LightCall configurations.

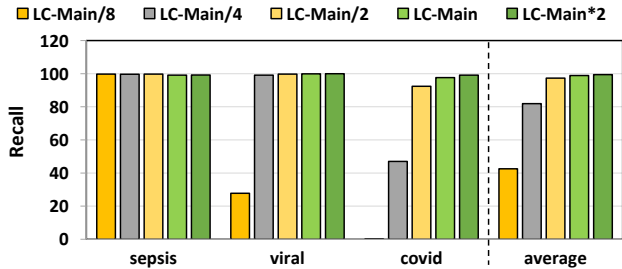

Figure 4: Recall for our evaluated use-cases while using TargetCall with different LightCall configurations.

3.3. End-to-End Accuracy

We evaluate the end-to-end accuracy of TargetCall in the viral detection use case. We use Equation (1) to calculate the average deviation in relative abundances as the end-to-end accuracy metric. Ideally, the deviation should be 0%, such that pre-basecalling filtering does not affect the end-to-end accuracy of the genome analysis pipeline at all.

Table 2 lists the average RA deviations calculated for each LightCall configuration. We make the following two key observations. First, the average RA deviations is negligible ($\leq 0.1\%$) for TargetCall configurations with recall higher than 98.5%. Second, TargetCall's minor inaccuracy is not biased towards any specific portion of the target reference since otherwise, the deviation of the relative abundances would be higher. Losing a small number of on-target reads randomly enables sequencing depth-of-coverage to compensate for the loss of reads. We conclude that TargetCall's high sensitivity enables accurate estimates for relative abundance calculations.

Table 2: L1 norm for different TargetCall configurations.

Model Name	Average RA Deviation
LC_{Main*2}	0.03%
LC_{Main}	0.08%
$LC_{Main/2}$	0.23%
$LC_{Main/4}$	0.91%
$LC_{Main/8}$	72.19%

3.4. Basecalling Execution Time

Figure 5 provides the total execution time of Bonito and Bonito with TargetCall. We make three key observations. First, TargetCall improves performance of Bonito by $2.13\times-3.31\times$. Second, both precision and model complexity of LightCall affect the performance of TargetCall, resulting in a non-linear relationship

between model complexity and performance. Precision affects the performance of the filter as lower precision results in higher number of falsely accepted reads to be basecalled using conventional basecallers. Model complexity affects the performance of the filter as lower model complexity results in higher LightCall performance with lower precision. Third, decreasing the model complexity increases the performance up to the point where read filtering accuracy is no longer sufficient to filter out reads correctly. This results in a significant number of reads being falsely accepted by the filter, reducing the performance of TargetCall significantly. We conclude that TargetCall significantly improves the execution time of basecalling.

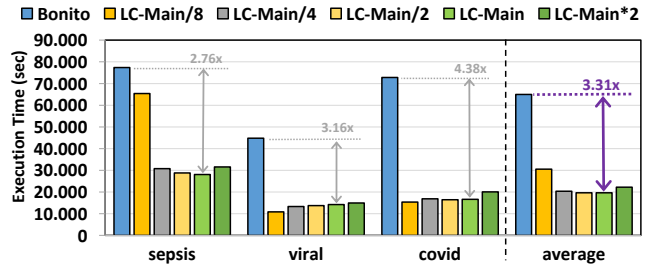

Figure 5: Basecalling execution time for our evaluated use-cases while using TargetCall with different LightCall configurations.

3.5. End-to-End Execution Time

Figure 6 provides the total time spent on genome analysis pipeline of basecalling, read mapping and variant calling with and without the use of pre-basecalling filtering. We used minimap2 [37] and DeepVariant [62] for read mapping and variant calling respectively. We make three key observations. First, TargetCall improves the performance of entire genome sequence analysis pipeline by $2.03\times-3.00\times$. Second, the choice of the variant caller affects the end-to-end performance improvement of TargetCall. Since we used a highly-accurate neural network based variant caller, the execution time of variant calling dominated read mapping (not shown). This reduces the end-to-end performance benefits of TargetCall, as the variant calling is performed only on the alignments of on-target reads (i.e., on reduced dataset) determined during relatively light-weight read mapping step. Third, similar to basecalling execution time, multiple factors affect the performance of TargetCall with different LightCall configurations, which results in non-linear relationship between the performance and model complexity of LightCall. We conclude that TargetCall significantly improves the end-to-end execution time of genome sequence analysis pipeline by providing up to $3.00\times$ speedup.

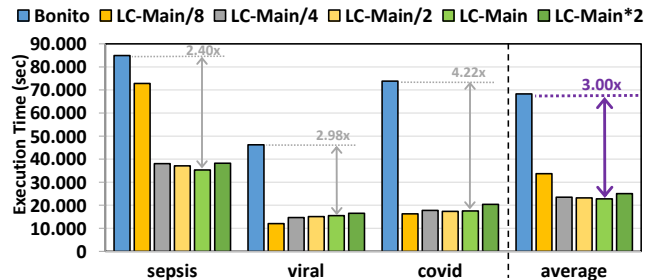

Figure 6: End-to-end execution time for our evaluated use-cases while using TargetCall with different LightCall configurations.

3.6. Comparison to Prior Work

We compare TargetCall with the best LightCall configuration (LC_{Main}) with two state-of-the-art adaptive sampling methods

UNCALLED and Sigmap. Section 3.1 of the Supplementary Materials explain the best model selection procedure. We use 2 different reference genomes for the sepsis use case as UNCALLED failed to generate the index structure for our default human reference genome (hg38) in a high end server with 1TB main memory. We evaluate only these two methods, as they can readily be repurposed as pre-basecalling filters. The other methods are either not open-sourced fully [33] or cannot be repurposed as pre-basecalling filters as is [31].

We compare the sensitivity (recall) of TargetCall with that of Sigmap and UNCALLED. The ground truth on-target reads are determined by the conventional pipeline. Figure 7 shows the recall of Sigmap, UNCALLED and TargetCall. We make two key observations. First, TargetCall provides significantly higher sensitivity, +3.09%/+23.15%, than UNCALLED/Sigmap on average. Second, TargetCall provides consistently higher sensitivity than both methods across all use cases except covid detection for which adaptive sampling methods are optimized. We further analyze the reason of UNCALLED’s and Sigmap’s relatively high sensitivity in sepsis use case with long reference genomes. We observe that UNCALLED/Sigmap achieves 40.59%/53.71% recall in finding the similarity of human reads in the sepsis dataset to human reference genome (chm13) whereas TargetCall achieves 96.21% recall for the same application. However, the use case filters out the reads that are similar to the target reference unlike other use cases that filters out the reads that are **not** similar to the target reference. Therefore, the low sensitivity of UNCALLED and Sigmap on large target reference genomes affect their precision on the sepsis use case as shown below, not their recall. We conclude that TargetCall improves the recall of prior works significantly across all pre-basecalling filtering applications.

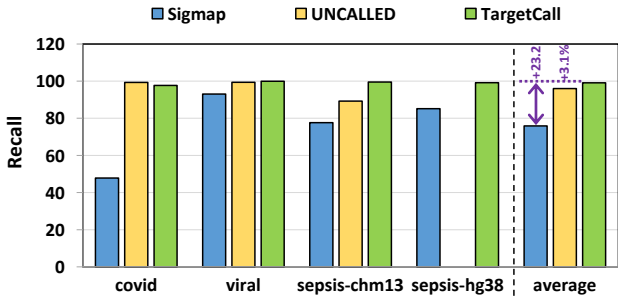

Figure 7: Sensitivity (Recall) of Sigmap, UNCALLED and TargetCall

We compare the precision of TargetCall with that of Sigmap and UNCALLED. Figure 8 shows the precision of Sigmap, UNCALLED and TargetCall. We make two key observations. First, TargetCall provides significantly higher precision, +58.48%/+62.31%, than UNCALLED/Sigmap on average. Second, TargetCall maintains high precision as the target reference size increases unlike prior methods. We conclude that TargetCall significantly achieves higher recall and precision in all use cases independent of the target reference size.

We compare the end-to-end execution time of TargetCall with that of Sigmap and UNCALLED, the results are shown in Figure 9. We make two key observations. First, we observe that TargetCall outperforms Sigmap by 9.76× and UNCALLED by 1.46×. TargetCall’s higher performance benefits come from its higher precision in filtering out off-target reads. Second, TargetCall’s performance improvements become more significant as the target reference size increases.

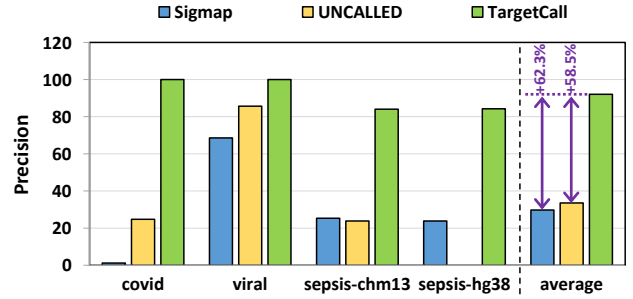

Figure 8: Precision of Sigmap, UNCALLED and TargetCall

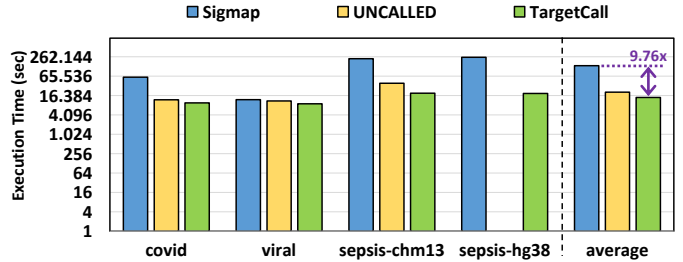

Figure 9: End-to-end execution time of Sigmap, UNCALLED, and TargetCall

We evaluate the throughput of TargetCall and compare it against with that of Sigmap and UNCALLED. We evaluate throughput as the base pairs tools process per second. We use uncalled pafstats for evaluating the throughput of UNCALLED and Sigmap, and bonito output for evaluating the throughput of LightCall. We only evaluate the throughput of LightCall component of TargetCall as it has significantly lower throughput than Similarity Check, and is the bottleneck of TargetCall. Figure 10 shows the throughput of Sigmap, UNCALLED and LightCall. We make three key observations. First, we observe that LightCall improves throughput of UNCALLED/Sigmap by 1124.03×/42.08×. Second, we observe that throughput of LightCall is consistently high unlike other tools (e.g., Sigmap) whose throughput reduce with target reference length. Third, LightCall’s high throughput does not reflect to its execution time. The reason of this discrepancy between LightCall’s throughput and execution time is likely because unlike Sigmap and UNCALLED, TargetCall processes the entire read before labelling it as on-target/off-target. We conclude that TargetCall’s benefits can be amplified by optimizing it further via integrating early filtering of reads that will match/not match to the target reference without processing the entire read.

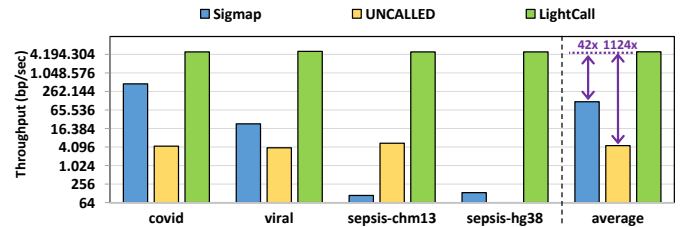

Figure 10: Throughput of Sigmap, UNCALLED, and LightCall

Overall, we conclude that TargetCall 1) significantly improves the end-to-end execution time of basecalling compared to prior methods by filtering out higher fraction of the off-target reads with its higher precision, 2) improves the sensitivity of prior methods in filtering reads, 3) has a consistently higher throughput than all prior works, and 4) can be accurately applied to target reference lengths that prior methods are unable to be applied

accurately while requiring much less (on average 5.76x, see Section 3.2 of Supplementary Materials) peak memory compared to prior works. We believe TargetCall can be used as a lightweight real-time sequence classification and filtering tool due to its high throughput if it is optimized to work with first few chunks of a read.

3.7. TargetCall Execution Time Breakdown

We analyzed the execution time breakdown of a pipeline that includes TargetCall as the pre-basecalling filter in Figure 11. We make four key observations. First, LightCall is the bottleneck of the new basecalling pipeline that includes pre-basecalling filtering by consuming 61.44% of the total execution time on average. Second, basecalling is still an important computational overhead for the pipeline by consuming 35.04% of the total execution time on average. Third, the computational overhead of basecalling increases with increased ratio of on-target reads in the dataset such as in the viral use case. Fourth, the Similarity Check component is consuming less than 3.4% of the total execution time on average, and does not bottleneck the pipeline that includes TargetCall as the pre-basecalling filter even when used in the expensive alignment mode.

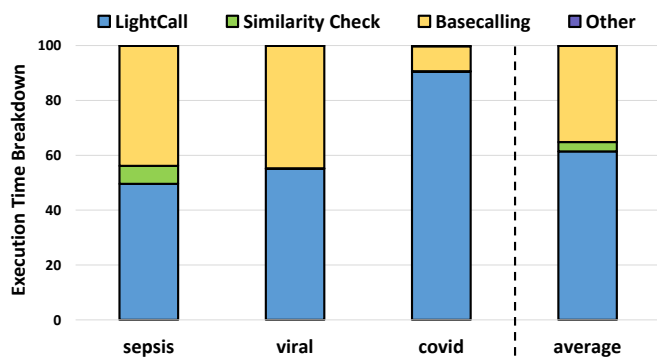

Figure 11: Execution Time Breakdown of TargetCall

4. Conclusion

We propose TargetCall, a pre-basecalling filtering mechanism for eliminating the wasted computation in basecalling. TargetCall performs light-weight basecalling to compute noisy reads using LightCall, and labels these noisy reads as on-target/off-target using Similarity Check. TargetCall eliminates the wasted computation in basecalling by performing basecalling only on the on-target reads. We evaluate TargetCall for three different genome sequence analysis use cases of pre-basecalling filtering with varying requirements: covid detection, sepsis detection, and viral detection. We show that TargetCall reduces the execution time of basecalling by filtering out majority of the off-target reads, and is more applicable compared to the state-of-the-art adaptive sampling methods. We hope that TargetCall inspires future work in pre-basecalling filtering and real-time sequence classification that accelerate other bioinformatics workloads and emerging applications with its high throughput and sensitivity. We explain future work and optimizations that can build upon TargetCall in Section 4 of the Supplementary Materials.

References

- [1] C. Alkan, J. M. Kidd, T. Marques-Bonet, G. Aksay, F. Antonacci, F. Hormozdiari, J. O. Kitzman, C. Baker, M. Malig, O. Mutlu, S. C. Sahinalp, R. A. Gibbs, and E. E. Eichler, "Personalized Copy Number and Segmental Duplication Maps Using Next-Generation Sequencing," *Nat Genet*, 2009.
- [2] E. A. Ashley, "Towards Precision Medicine," *Nature Reviews Genetics*, 2016.

- [3] L. Chin, J. N. Andersen, and P. A. Futreal, "Cancer Genomics: from Discovery Science to Personalized Medicine," *Nat Med*, 2011.
- [4] H. Ellegren, "Genome Sequencing and Population Genomics in Non-Model Organisms," *Trends in Ecology & Evolution*, 2014.
- [5] M. J. Alvarez-Cubero, M. Saiz, B. Martínez-García, S. M. Sayalero, C. Entrala, J. A. Lorente, and L. J. Martínez-Gonzalez, "Next Generation Sequencing: an Application in Forensic Sciences?" *Ann Hum Biol*, 2017.
- [6] Y. Wang, Y. Zhao, A. Bollas, Y. Wang, and K. F. Au, "Nanopore Sequencing Technology, Bioinformatics and Applications," *Nature Biotechnology*, 2021.
- [7] M. Alser, J. Rotman, D. Deshpande, K. Taraszka, H. Shi, P. I. Baykal, H. T. Yang, V. Xue, S. Knyazev, B. D. Singer, B. Balliu, D. Koslicki, P. Skums, A. Zelikovsky, C. Alkan, O. Mutlu, and S. Mangul, "Technology Dictates Algorithms: Recent Developments in Read Alignment," *Genome Biology*, 2021.
- [8] T. J. Treangen and S. L. Salzberg, "Repetitive DNA and Next-Generation Sequencing: Computational Challenges and Solutions," *Nat Rev Genet*, 2011.
- [9] C. Firtina and C. Alkan, "On Genomic Repeats and Reproducibility," *Bioinformatics*, 2016.
- [10] C. Alkan, S. Sajjadian, and E. E. Eichler, "Limitations of Next-Generation Genome Sequence Assembly," *Nat Methods*, 2010.
- [11] H. Lu, F. Giordano, and Z. Ning, "Oxford Nanopore MinION Sequencing and Genome Assembly," *Genomics Proteomics Bioinformatics*, 2016.
- [12] A. Magi, R. Semeraro, A. Mingrino, B. Giusti, and R. D'Aurizio, "Nanopore Sequencing Data Analysis: State of the Art, Applications and Challenges," *Brief Bioinform*, 2018.
- [13] C. Firtina, J. Park, M. Alser, J. S. Kim, D. S. Cali, T. Shahroodi, N. M. Ghiasi, G. Singh, K. Kanellopoulos, C. Alkan, and O. Mutlu, "BLEND: A Fast, Memory-Efficient, and Accurate Mechanism to Find Fuzzy Seed Matches in Genome Analysis," *bioRxiv*, 2022.
- [14] D. Branton, D. W. Deamer, A. Marziali, H. Bayley, S. A. Benner, T. Butler, M. Di Ventra, S. Garaj, A. Hibbs, X. Huang *et al.*, "The potential and challenges of nanopore sequencing," *Nature biotechnology*, 2008.
- [15] L. Gong, C.-H. Wong, J. Idol, C. Y. Ngan, and C.-L. Wei, "Ultra-Long Read Sequencing for Whole Genomic DNA Analysis," *JoVE*, 2019.
- [16] M. Jain, S. Koren, K. H. Miga, J. Quick, A. C. Rand, T. A. Sasani, J. R. Tyson, A. D. Beggs, A. T. Dilthey, I. T. Fiddes, S. Malla, H. Marriott, T. Nieto, J. O'Grady, H. E. Olsen, B. S. Pedersen, A. Rhie, H. Richardson, A. R. Quinlan, T. P. Snutch, L. Tee, B. Paten, A. M. Phillippy, J. T. Simpson, N. J. Loman, and M. Loose, "Nanopore Sequencing and Assembly of a Human Genome with Ultra-Long Reads," *Nature Biotechnology*, 2018.
- [17] G. A. Logsdon, M. R. Vollger, and E. E. Eichler, "Long-Read Human Genome Sequencing and its Applications," *Nature Reviews Genetics*, 2020.
- [18] S. L. Amarasinghe, S. Su, X. Dong, L. Zappia, M. E. Ritchie, and Q. Gouil, "Opportunities and Challenges in Long-Read Sequencing Data Analysis," *Genome biology*, 2020.
- [19] H. Zhang, H. Li, C. Jain, H. Cheng, K. F. Au, H. Li, and S. Aluru, "Real-Time Mapping of Nanopore Raw Signals," *Bioinformatics*, 2021.
- [20] R. R. Wick, L. M. Judd, and K. E. Holt, "Performance of Neural Network Basecalling Tools for Oxford Nanopore Sequencing," *Genome biology*, 2019.
- [21] M. Pages-Gallego and J. de Ridder, "Comprehensive and Standardized Benchmarking of Deep Learning Architectures for Basecalling Nanopore Sequencing Data," *bioRxiv*, 2022.
- [22] M. Alser, J. Lindegger, C. Firtina, N. Almadhoun, H. Mao, G. Singh, J. Gomez-Luna, and O. Mutlu, "From Molecules to Genomic Variations: Accelerating Genome Analysis via Intelligent Algorithms and Architectures," *Computational and Structural Biotechnology Journal*, 2022.
- [23] Wan, Yuk Kei and Hendra, Christopher and Pratanwanich, Ploy N and Göke, Jonathan, "Beyond Sequencing: Machine Learning Algorithms Extract Biology Hidden in Nanopore Signal Data," *Trends Genet*, 2021.

- [24] D. Senol Cali, J. S. Kim, S. Ghose, C. Alkan, and O. Mutlu, "Nanopore Sequencing Technology and Tools for Genome Assembly: Computational Analysis of the Current State, Bottlenecks and Future Directions," *Brief Bioinform*, 2019.
- [25] F. J. Rang, W. P. Kloosterman, and J. de Ridder, "From Squiggle to Basepair: Computational Approaches for Improving Nanopore Sequencing Read Accuracy," *Genome Biology*, 2018.
- [26] G. Singh *et al.*, "A Framework for Designing Efficient Deep Learning-Based Genomic Basecallers," *arXiv*, 2022.
- [27] R. Bowden, R. W. Davies, A. Heger, A. T. Pagnamenta, M. de Cesare, L. E. Oikkonen, D. Parkes, C. Freeman, F. Dhalla, S. Y. Patel, N. Popitsch, C. L. C. Ip, H. E. Roberts, S. Salatino, H. Lockstone, G. Lunter, J. C. Taylor, D. Buck, M. A. Simpson, and P. Donnelly, "Sequencing of Human Genomes with Nanopore Technology," *Nature Communications*, 2019.
- [28] T. Dunn, H. Sadasivan, J. Wadden, K. Goliya, K.-Y. Chen, D. Blaauw, R. Das, and S. Narayanasamy, "SquiggleFilter: An Accelerator for Portable Virus Detection," in *MICRO*, 2021.
- [29] S. Grumaz, P. Stevens, C. Grumaz, S. O. Decker, M. A. Weigand, S. Hofer, T. Brenner, A. von Haeseler, and K. Sohn, "Next-Generation Sequencing Diagnostics of Bacteremia in Septic Patients," *Genome Medicine*, 2016.
- [30] S. Kovaka, Y. Fan, B. Ni, W. Timp, and M. C. Schatz, "Targeted Nanopore Sequencing by Real-Time Mapping of Raw Electrical Signal with UNCALLED," *Nature Biotechnology*, 2021.
- [31] Y. Bao, J. Wadden, J. R. Erb-Downward, P. Ranjan, W. Zhou, T. L. McDonald, R. E. Mills, A. P. Boyle, R. P. Dickson, D. Blaauw, and J. D. Welch, "SquiggleNet: Real-Time, Direct Classification of Nanopore Signals," *Genome Biology*, 2021.
- [32] M. Loose, S. Malla, and M. Stout, "Real-Time Selective Sequencing Using Nanopore Technology," *Nature Methods*, 2016.
- [33] A. Payne, N. Holmes, T. Clarke, R. Munro, B. J. Debebe, and M. Loose, "Readfish Enables Targeted Nanopore Sequencing of Gigabase-Sized Genomes," *Nat Biotechnol*, 2020.
- [34] B. Noordijk, R. Nijland, V. J. Carrion, J. M. Raaijmakers, D. de Ridder, and C. de Lannoy, "baseLess: Lightweight Detection of Sequences in Raw MinION Data," *bioRxiv*, 2022.
- [35] "Bonito, <https://github.com/nanoporetech/bonito>."
- [36] D. Frei, E. Veekman, D. Grogg, I. Stoffel-Studer, A. Morishima, R. Shimizu-Inatsugi, S. Yates, K. K. Shimizu, J. E. Frey, B. Studer, and D. Copetti, "Ultralong Oxford Nanopore Reads Enable the Development of a Reference-Grade Perennial Ryegrass Genome Assembly," *Genome Biology and Evolution*, 2021.
- [37] H. Li, "Minimap2: Pairwise Alignment for Nucleotide Sequences," *Bioinformatics*, 2018.
- [38] S. Ioffe and C. Szegedy, "Batch Normalization: Accelerating Deep Network Training by Reducing Internal Covariate Shift," in *ICML*, 2015.
- [39] A. F. Agarap, "Deep Learning Using Rectified Linear Units (ReLU)," *arXiv*, 2018.
- [40] A. Graves, S. Fernández, F. Gomez, and J. Schmidhuber, "Connectionist Temporal Classification: Labelling Unsegmented Sequence Data with Recurrent Neural Networks," in *ICML*, 2006.
- [41] D. Neumann, A. S. Reddy, and A. Ben-Hur, "RODAN: A Fully Convolutional Architecture for Basecalling Nanopore RNA Sequencing Data," *BMC bioinformatics*, 2022.
- [42] H. Konishi, R. Yamaguchi, K. Yamaguchi, Y. Furukawa, and S. Imoto, "Halcyon: an Accurate Basecaller Exploiting an Encoder-Decoder Model with Monotonic Attention," *Bioinformatics*, 2021.
- [43] Z. Xu, Y. Mai, D. Liu, W. He, X. Lin, C. Xu, L. Zhang, X. Meng, J. Mafofo, W. A. Zaher *et al.*, "Fast-bonito: A Faster Deep Learning Based Basecaller for Nanopore Sequencing," *Artificial Intelligence in the Life Sciences*, 2021.
- [44] Q. Lou, S. C. Janga, and L. Jiang, "Helix: Algorithm/Architecture Co-design for Accelerating Nanopore Genome Base-calling," in *Proceedings of the ACM International Conference on Parallel Architectures and Compilation Techniques*, 2020.
- [45] P. Perešini, V. Boža, B. Brejová, and T. Vinař, "Nanopore Base Calling on the Edge," *Bioinformatics*, 2021.
- [46] Z. Zhang, C. Y. Park, C. L. Theesfeld, and O. G. Troyanskaya, "An Automated Framework for Efficiently Designing Deep Convolutional Neural Networks in Genomics," *Nature Machine Intelligence*, 2021.
- [47] A. V and A. G. Kiran, "Synthnet: A skip connected depthwise separable neural network for novel view synthesis of solid objects," *Results in Engineering*, 2022.
- [48] M. A. Quail, M. Smith, P. Coupland, T. D. Otto, S. R. Harris, T. R. Connor, A. Bertoni, H. P. Swerdlow, and Y. Gu, "A Tale of Three Next Generation Sequencing Platforms: Comparison of Ion Torrent, Pacific Biosciences and Illumina MiSeq Sequencers," *BMC Genomics*, 2012.
- [49] S. E. Levy and R. M. Myers, "Advancements in Next-Generation Sequencing," *Annu Rev Genomics Hum Genet*, 2016.
- [50] T. Hu, N. Chitnis, D. Monos, and A. Dinh, "Next-Generation Sequencing Technologies: An overview," *Hum Immunol*, 2021.
- [51] D. Sims, I. Sudbery, N. E. Ilott, A. Heger, and C. P. Ponting, "Sequencing Depth and Coverage: Key Considerations in Genomic Analyses," *Nature Reviews Genetics*, 2014.
- [52] J. L. Geoghegan, J. Douglas, X. Ren, M. Storey, J. Hadfield, O. K. Silander, N. E. Freed, L. Jelly, S. Jefferies, J. Sherwood, S. Paine, S. Huang, A. Sporle, M. G. Baker, D. R. Murdoch, A. J. Drummond, D. Welch, C. R. Simpson, N. French, E. C. Holmes, and J. de Ligt, "Use of Genomics to Track Coronavirus Disease Outbreaks, New Zealand," *Emerg Infect Dis*, 2021.
- [53] I. H. Celik, M. Hanna, F. E. Canpolat, and M. Pammi, "Diagnosis of Neonatal Sepsis: the Past, Present and Future," *Pediatric Research*, 2022.
- [54] K. Sands, M. J. Carvalho, E. Portal, K. Thomson, C. Dyer, C. Akpulu, R. Andrews, A. Ferreira, D. Gillespie, T. Hender, K. Hood, J. Mathias, R. Milton, M. Nieto, K. Taiyari, G. J. Chan, D. Bekele, S. Solomon, S. Basu, P. Chattopadhyay, S. Mukherjee, K. Iregbu, F. Modibbo, S. Uwaezuoke, R. Zahra, H. Shirazi, A. Muhammad, J.-B. Mazarati, A. Rucogoza, L. Gaju, S. Mehtar, A. N. H. Bulabula, A. Whitelaw, T. R. Walsh, and B. A. R. N. A. R. D. S. Group, "Characterization of Antimicrobial-Resistant Gram-Negative Bacteria That Cause Neonatal Sepsis in Seven Low- and Middle-Income Countries," *Nature Microbiology*, 2021.
- [55] J. L. Mokili, F. Rohwer, and B. E. Dutilh, "Metagenomics and Future Perspectives in Virus Discovery," *Current Opinion in Virology*, 2012.
- [56] "MinION Flow Cell (R9.4.1), <https://store.nanoporetech.com/flow-cell-r9-4-1.html>."
- [57] D. P. Kingma and J. Ba, "Adam: A Method for Stochastic Optimization," *arXiv*, 2014.
- [58] J. M. Zook, J. McDaniel, N. D. Olson, J. Wagner, H. Parikh, H. Heaton, S. A. Irvine, L. Trigg, R. Truty, C. Y. McLean, F. M. De La Vega, C. Xiao, S. Sherry, and M. Salit, "An Open Resource for Accurately Benchmarking Small Variant and Reference Calls," *Nat Biotechnol*, 2019.
- [59] "Brazil-UK Centre for Arbovirus Discovery, Diagnosis, Genomics and Epidemiology, <https://www.caddecentre.org>," 2020.
- [60] Y. Li, R. Han, C. Bi, M. Li, S. Wang, and X. Gao, "DeepSimulator: A Deep Simulator for Nanopore Sequencing," *Bioinformatics*, 2018.
- [61] Y. Li, S. Wang, C. Bi, Z. Qiu, M. Li, and X. Gao, "DeepSimulator1.5: A More Powerful, Quicker and Lighter Simulator for Nanopore Sequencing," *Bioinformatics*, 2020.
- [62] R. Poplin, P.-C. Chang, D. Alexander, S. Schwartz, T. Colthurst, A. Ku, D. Newburger, J. Dijamco, N. Nguyen, P. T. Afshar, S. S. Gross, L. Dorfman, C. Y. McLean, and M. A. DePristo, "A Universal SNP and Small-Indel Variant Caller Using Deep Neural Networks," *Nature Biotechnology*, 2018.