

How to Play Optimally for Regular Objectives?

Patricia Bouyer 

Université Paris-Saclay, CNRS, ENS Paris-Saclay,
Laboratoire Méthodes Formelles, 91190, Gif-sur-Yvette, France

Nathanaël Fijalkow 

CNRS, LaBRI and Université de Bordeaux, France
University of Warsaw, Poland

Mickael Randour 

F.R.S.-FNRS & UMONS – Université de Mons, Mons, Belgium

Pierre Vandenhove 

F.R.S.-FNRS & UMONS – Université de Mons, Mons, Belgium
Université Paris-Saclay, CNRS, ENS Paris-Saclay,
Laboratoire Méthodes Formelles, 91190, Gif-sur-Yvette, France

Abstract

This paper studies two-player zero-sum games played on graphs and makes contributions toward the following question: given an objective, how much memory is required to play optimally for that objective? We study regular objectives, where the goal of the first player is that eventually the sequence of colors along the play belongs to some regular language over finite words. We obtain different characterizations of the chromatic memory requirements for such objectives for both players, from which we derive complexity-theoretic statements: deciding whether there exist small memory structures sufficient to play optimally is NP-complete for both players. Some of our characterization results apply to a more general class of objectives: topologically closed and topologically open sets.

2012 ACM Subject Classification Theory of computation → Formal languages and automata theory

Keywords and phrases two-player games on graphs, strategy complexity, regular languages, finite-memory strategies, NP-completeness

Funding This work has been partially supported by the ANR Project MAVeriQ (ANR-20-CE25-0012). Mickael Randour is an F.R.S.-FNRS Research Associate and a member of the TRAIL Institute. Pierre Vandenhove is an F.R.S.-FNRS Research Fellow.

Acknowledgements We thank Antonio Casares and Igor Walukiewicz for valuable discussions about this article.

1 Introduction

Games on graphs is a fundamental model in theoretical computer science for modeling systems involving competing agents. Its applications include model-checking, program verification and synthesis, control theory, and reactive synthesis: in all cases, the system specification is turned into a winning objective for a player and the goal is to construct a winning strategy. Some central results in the field state that for some objectives, there exist memoryless optimal strategies, meaning not requiring any memory. For instance, the celebrated memoryless determinacy result for (infinite) parity games is a key ingredient in the modern proof of decidability of monadic second-order logic over infinite trees by Gurevich and Harrington [13].

Memory requirements. However for many objectives, some memory is required; a central question is therefore, stated informally:

Given an objective, how much memory is required to play optimally for this objective?

The first answers to this question, at the dawn of the study of games, were memory requirements for concrete objectives, such as Rabin objectives [21]. The work of Dziembowski, Jurdziński, and Walukiewicz [10] gave a computable characterization of memory requirements for the whole class of Muller objectives. This triggered the following long-term research objective: characterizing the memory requirements for ω -regular objectives.

Regular objectives. Many results have been obtained toward this research programme; we refer to the related works section in Section 3 for further details. The most pressing open question in that direction is regular objectives, meaning the special case of ω -regular objectives concerned with finite duration: in this setting, the objective is induced by a regular language over finite words and the goal of the first player is that *eventually* the sequence of colors along the play belongs to this language. We call these *regular reachability objectives*. The opponent’s objective is then to ensure that the sequence of colors *never* belongs to the language, describing *regular safety objectives*.

Chromatic memory. One of the many contributions of Kopczyński [17] in the study of memory for games on graphs is the notion of chromatic memory. In this model, the memory states are updated only using the sequence of colors seen along a play, and in particular do not depend on the graph itself (as opposed to chaotic memory, which may use information from the graph in its updates). Kopczyński conjectured [17] that for ω -regular objectives, chromatic and chaotic memory requirements coincide; unfortunately, this does not hold, as recently proved by Casares [7] (i.e., there are objectives for which the number of memory states required to play optimally in all arenas differs depending on the memory model). In our study, we will see another counterexample using regular objectives.

Contributions. We study the chromatic memory requirements of both regular reachability and regular safety objectives. For both cases, we give a combinatorial characterization of the memory structures that are sufficient to play optimally in all arenas (of any cardinality). As a by-product of the characterization we obtain complexity-theoretic statements: given as input a deterministic finite automaton representing the objective,

- deciding whether a memory structure suffices to play optimally in all arenas can be done in polynomial time;
- deciding the existence of a sufficient memory structure with a given number of states is NP-complete.

From our characterizations it also easily follows that for both regular reachability and safety objectives, chromatic and chaotic memory requirements do not coincide.

We also discuss when relevant the extension of our results to the more general class of topologically open and topologically closed objectives, which include respectively the regular reachability and regular safety objectives.

Implementation. For experimentation purposes, we have implemented algorithms which automatically build a memory structure with a minimal number of states, both for regular reachability and safety objectives. Our implementation uses SAT solvers provided by the Python package PySAT [14]. It can be found at <https://github.com/pvdhove/regularMemoryRequirements>.

Structure of the paper. All required definitions are provided in Section 2. Section 3 includes a technical overview of the results and proofs as well as an in-depth discussion of

related works. The characterizations for regular safety and reachability objectives are proved in Section 4 and Section 5. We show complexity-theoretic corollaries in Section 6.

2 Preliminaries

Let C be a non-empty alphabet of *colors*.

Arenas. We study zero-sum turn-based games on graphs with two players, called \mathcal{P}_1 and \mathcal{P}_2 . Players play on *arenas*, which are tuples $\mathcal{A} = (V, V_1, V_2, E)$ where V is a non-empty set of *vertices* such that $V = V_1 \uplus V_2$ (disjoint union) and $E \subseteq V \times C \times V$ is a *set of colored edges*. If $e = (v_1, c, v_2) \in E$, we write $\text{in}(e) = v_1$, $\text{col}(e) = c$, and $\text{out}(e) = v_2$. Vertices in V_1 are controlled by \mathcal{P}_1 and vertices in V_2 are controlled by \mathcal{P}_2 . An arena is *finite* if it has finitely many states and edges, and is *finitely branching* if for all $v \in V$, there are finitely many edges $e \in E$ such that $\text{in}(e) = v$. Unless otherwise specified, we consider arenas of any cardinality. An arena $\mathcal{A} = (V, V_1, V_2, E)$ is a *one-player arena of \mathcal{P}_1* (resp. *of \mathcal{P}_2*) if $V_2 = \emptyset$ (resp. $V_1 = \emptyset$).

A *history* on arena $\mathcal{A} = (V, V_1, V_2, E)$ is a finite sequence $\gamma = e_1 \dots e_n \in E^*$ such that for $i, 1 \leq i \leq n - 1$, we have $\text{out}(e_i) = \text{in}(e_{i+1})$. We write $\text{out}(\gamma)$ for $\text{out}(e_n)$. For convenience, we assume that for all $v \in V$, there is a distinct empty history λ_v such that $\text{out}(\lambda_v) = v$. For $i \in \{1, 2\}$, we write $\text{Hists}_i(\mathcal{A})$ for the set of histories γ on \mathcal{A} such that $\text{out}(\gamma) \in V_i$. A *play* on arena \mathcal{A} is an infinite sequence $\pi = e_1 e_2 \dots \in E^\omega$ such that for $i \geq 1$, $\text{out}(e_i) = \text{in}(e_{i+1})$; play π is *from v* if $\text{in}(e_1) = v$. If $\pi = e_1 e_2 \dots \in E^\omega$ is a play (resp. $\gamma = e_1 \dots e_n \in E^*$ is a history), we write $\text{col}^\omega(\pi)$ (resp. $\text{col}^*(\gamma)$) for the infinite sequence $\text{col}(e_1)\text{col}(e_2)\dots \in C^\omega$ (resp. the finite sequence $\text{col}(e_1)\dots\text{col}(e_n) \in C^*$).

Objectives. *Objectives* are subsets $W \subseteq C^\omega$. Given an objective W , we write $\overline{W} = C^\omega \setminus W$ for its complement. We focus on two types of objectives, both derived from a set $A \subseteq C^*$:

- the *general reachability objective derived from A* , denoted $\text{Reach}(A)$, is the objective $\bigcup_{w \in A} wC^\omega$ of infinite words that have (at least) one finite prefix in A .
- the *general safety objective derived from A* , denoted $\text{Safe}(A)$, is the objective $\overline{\bigcup_{w \in A} wC^\omega}$ of infinite words that have no finite prefix in A . We have $\text{Safe}(A) = \text{Reach}(A)$.

General reachability and safety objectives are respectively the *topologically open* and *topologically closed sets*, at the first level of the Borel hierarchy. When A is a regular language, we call $\text{Reach}(A)$ a *regular reachability objective* and $\text{Safe}(A)$ a *regular safety objective*. We call an objective *regular* if it is a regular reachability or a regular safety objective. Our characterizations apply to regular reachability and safety objectives, but we sometimes discuss when we may generalize our results to the general case. For computational complexity questions (Section 6), we restrict our focus to regular reachability and safety objectives so that an objective can be finitely represented as an automaton. The objectives that we consider are therefore both very simple in terms of their algebraic representation (using automata representing languages of finite words) and in terms of their topology (they are at the first level of the Borel hierarchy).

A *game* is a tuple $\mathcal{G} = (\mathcal{A}, W)$ where \mathcal{A} is an arena and W is an objective.

Automata. A *deterministic automaton* is a tuple $\mathcal{D} = (Q, C, q_{\text{init}}, \delta, F)$ where Q is a possibly infinite set of *states*, C is a non-empty *alphabet* (usually the set of colors), $q_{\text{init}} \in Q$ is an *initial state*, $\delta: Q \times C \rightarrow Q$ is a (complete, deterministic) *update function*, and $F \subseteq Q$ is a set of *final states*. All automata in this work are deterministic, so we sometimes omit the

word *deterministic*. Automaton \mathcal{D} is *finite* if Q is finite. We write $\delta^*: M \times C^* \rightarrow M$ for the natural extension of δ to sequences of colors. The *language recognized by \mathcal{D}* , denoted $\mathcal{L}(\mathcal{D})$, is the set of finite words $w \in C^*$ such that $\delta^*(q_{\text{init}}, w) \in F$. For $q_1, q_2 \in Q$, we write $\Pi_{q_1, q_2}^{\mathcal{D}}$ for the language of words $w \in C^*$ such that $\delta^*(q_1, w) = q_2$. We drop the superscript \mathcal{D} if the automaton considered is clear in the context. We denote the empty word by ε .

Continuations. For an objective $W \subseteq C^\omega$ and $w \in C^*$, we define the *winning continuations of w* as the set $w^{-1}W = \{w' \in C^\omega \mid ww' \in W\}$ (this set is sometimes called a *left quotient* of W in the literature). Given an objective $W \subseteq C^\omega$, its *prefix preorder* $\preceq_W \subseteq C^* \times C^*$ is defined as $w_1 \preceq_W w_2$ if $w_1^{-1}W \subseteq w_2^{-1}W$. Its *prefix equivalence* $\sim_W \subseteq C^* \times C^*$ is defined as $w_1 \sim_W w_2$ if $w_1^{-1}W = w_2^{-1}W$. We denote $\prec_W = \preceq_W \setminus \sim_W$. We drop the subscript W when there is no ambiguity on the objective. The prefix preorder is a relation that is preserved by reading colors.

► **Lemma 1.** *Let $W \subseteq C^\omega$ be an objective. If $w_1 \preceq w_2$, then for all $w \in C^*$, $w_1w \preceq w_2w$.*

Starting from a general reachability or safety objective $W \subseteq C^\omega$ derived from a set $A \in C^*$, we can associate to W its automaton \mathcal{D}_W that “classifies” the equivalence classes of \sim . Formally, $\mathcal{D}_W = (Q, C, q_{\text{init}}, \delta, F)$ where $Q = \{[w]_\sim \mid w \in C^*\}$ is the set of equivalence classes of \sim , $q_{\text{init}} = [\varepsilon]_\sim$, $\delta([w]_\sim, c) = [wc]_\sim$, and $F = \{q_{\text{fin}}\}$ where $q_{\text{fin}} = [w]_\sim$ for some $w \in A$ (the choice of w does not matter). The transition function δ is well-defined: $w_1 \sim w_2$ implies $w_1c \sim w_2c$ for all $c \in C$. Notice that the final state of such an automaton is always absorbing, i.e., for all $c \in C$, $\delta(q_{\text{fin}}, c) = q_{\text{fin}}$. This matches the intuition that once a word of A is seen and the reachability (resp. safety) game is won (resp. lost), it stays that way for the rest of the game.

We have that a general reachability (resp. safety) objective W is equal to $\text{Reach}(\mathcal{L}(\mathcal{D}_W))$ (resp. to $\text{Safe}(\mathcal{L}(\mathcal{D}_W))$) — in examples, we will sometimes start from an automaton to generate an objective. Using the well-known Myhill-Nerode theorem [20], we obtain that a general reachability or safety objective W is regular if and only if \sim has finitely many equivalence classes if and only if \mathcal{D}_W is finite.

When considering an automaton $\mathcal{D}_W = (Q, C, q_{\text{init}}, \delta, F)$, for $q \in Q$, we abusively write $q^{-1}W$ for the set $w^{-1}W$, where w is any finite word such that $\delta^*(q_{\text{init}}, w) = q$ (the choice of w does not matter). We extend \preceq to automaton states ($q_1 \preceq q_2$ if $q_1^{-1}W \subseteq q_2^{-1}W$).

Preorders. Let \preceq be a preorder on some set B . We say that two elements $b_1, b_2 \in B$ are *comparable for \preceq* if $b_1 \preceq b_2$ or $b_2 \preceq b_1$. A set $\Gamma \subseteq B$ is a *chain for \preceq* (resp. *antichain for \preceq*) if for all $b_1, b_2 \in \Gamma$, b_1 and b_2 are (resp. are not) comparable for \preceq . A preorder \preceq is *well-founded* if every chain for \preceq contains a minimal element for \preceq .

Memory structures. A (*chromatic*) *memory structure* is a tuple $\mathcal{M} = (M, m_{\text{init}}, \alpha_{\text{upd}})$ where M is a possibly infinite set of *states*, $m_{\text{init}} \in M$ is an *initial state*, and $\alpha_{\text{upd}}: M \times C \rightarrow M$ is a (deterministic, complete) *update function*. It is syntactically almost the same as a deterministic automaton, except that we do not specify final states. We recover notations α_{upd}^* and Π_{m_1, m_2} (for $m_1, m_2 \in M$) from automata. We let $\mathcal{M}_{\text{triv}} = (\{m_{\text{init}}\}, m_{\text{init}}, (m_{\text{init}}, c) \mapsto m_{\text{init}})$ denote the only memory structure with a single state. The *size* of a memory structure is its number of states.

Strategies. Let $\mathcal{A} = (V, V_1, V_2, E)$ be an arena and $i \in \{1, 2\}$. A *strategy of \mathcal{P}_i on \mathcal{A}* is a function $\sigma_i: \text{Hists}_i(\mathcal{A}) \rightarrow E$ such that for all $\gamma \in \text{Hists}_i(\mathcal{A})$, $\text{out}(\gamma) = \text{in}(\sigma_i(\gamma))$. Given a

strategy σ_i of \mathcal{P}_i , we say that a play $\pi = e_1 e_2 \dots$ is *consistent with σ_i* if for all finite prefixes $\gamma = e_1 \dots e_j$ of π such that $\text{out}(\gamma) \in V_i$, $\sigma_i(\gamma) = e_{j+1}$. For $v \in V$, we denote by $\text{Plays}(\mathcal{A}, v, \sigma_i)$ the set of plays on \mathcal{A} from v that are consistent with σ_i .

For $\mathcal{M} = (M, m_{\text{init}}, \alpha_{\text{upd}})$ a memory structure, a strategy σ_i of \mathcal{P}_i on arena \mathcal{A} is *based on (memory) \mathcal{M}* if there exists a function $\alpha_{\text{next}}: V_i \times M \rightarrow E$ such that for all $v \in V_i$, $\sigma_i(\lambda_v) = \alpha_{\text{next}}(v, m_{\text{init}})$, and for all non-empty histories $\gamma \in \text{Hists}_i(\mathcal{A})$, $\sigma_i(\gamma) = \alpha_{\text{next}}(\text{out}(\gamma), \alpha_{\text{upd}}^*(m_{\text{init}}, \text{col}^*(\gamma)))$. A strategy is *memoryless* if it is based on $\mathcal{M}_{\text{triv}}$. For conciseness, we sometimes abusively assume that a strategy of \mathcal{P}_i based on \mathcal{M} is a function $V_i \times M \rightarrow E$.

► **Remark 2.** This *chromatic* memory model only observes the sequence of *colors* seen, and not the precise edges that are taken during a play (i.e., the current memory state is determined by the word in C^* seen, not by the history in E^*). A memory structure observing the edges is sometimes called a *chaotic* memory [17] and, as was recently shown, may allow to play optimally with fewer memory states for some objectives [7]. However, this comes at the cost of needing to specialize the transition function of the memory structure for every arena — it does not provide an *arena-independent* memory structure [4]. The chaotic memory requirements of general safety objectives are characterized in [9] while, as far as we know, the chaotic memory requirements of general and regular reachability objectives are unknown. ◻

Optimality. Let $\mathcal{G} = (\mathcal{A} = (V, V_1, V_2, E), W)$ be a game, and $v \in V$. We say that a strategy σ_1 of \mathcal{P}_1 on \mathcal{A} is *winning from v for W* if for all $\pi \in \text{Plays}(\mathcal{A}, v, \sigma_1)$, $\text{col}^\omega(\pi) \in W$.

A strategy of \mathcal{P}_1 is *optimal for \mathcal{P}_1 in (\mathcal{A}, W)* if it is winning from all the states of \mathcal{A} from which \mathcal{P}_1 has a winning strategy. We often write *optimal for \mathcal{P}_1 in \mathcal{A}* if the objective W is clear from the context. We stress that this notion of optimality requires a *single* strategy to be winning from *all* the winning states (a property sometimes called *uniformity*).

Let \mathcal{M} be a memory structure and $W \subseteq C^\omega$ be an objective. We say that \mathcal{M} *suffices (to play optimally) for W (resp. in finite, finitely branching, one-player arenas)* if for all (resp. finite, finitely branching, one-player) arenas \mathcal{A} , \mathcal{P}_1 has an optimal strategy based on \mathcal{M} in game (\mathcal{A}, W) .

3 Technical overview

In this section, we start with a more in-depth discussion of the related literature. We then present our main contributions (characterization of the memory requirements of safety objectives, of reachability objectives, and the computational complexity of the related decision problems) while describing and illustrating the main concepts used in our results. Complete proofs for the three contributions are deferred respectively to Sections 4, 5, and 6.

Related works. To classify the existing literature on memory for games, we identify two axes. The first is whether they concern chaotic memory or chromatic memory. The second is how the class of objectives is defined: either in automata-theoretic terms, typically as a subclass of ω -regular languages, or in topological terms, referring to the natural topology over the set of infinite words.

The result of Dziembowski, Jurdziński, and Walukiewicz [10] applies to the whole class of Muller objectives, which specify the set of colors which appears infinitely many times. It shows that Zielonka trees [22] can be used to compute chaotic memory requirements in polynomial time. Recently, Casares [7] has shown that this characterization does not extend to chromatic memory: deciding whether there is a memory structure of size k

becomes NP-complete and equivalent to minimizing *transition-based Rabin automata*. In this direction, Casares, Colcombet and Lehtinen [8] showed that computing chaotic memory requirements for Muller objectives is equivalent to minimizing good-for-games automata. A result by Bouyer, Randour, and Vandenhove [6] provides a link between the chromatic memory requirements of all ω -regular objectives (not only Muller conditions) and their representation as *transition-based parity automata*, but with less tight bounds on the minimal memory structures.

Article [5] establishes the existence of finite-memory optimal strategies from topological properties of objectives. Although general reachability and safety objectives fit into their framework, there are major differences with our work: their framework is different (they study *concurrent* games that are not played *on graphs*), and their aim is to establish the existence of finite-memory optimal strategies for many objectives, but not to understand precisely the memory requirements of some class of objectives.

Regular objectives are also mentioned in [18], where the existence of finite-memory optimal strategies is shown for Boolean combinations of objectives involving regular objectives.

In another line of works, Gimbert and Zielonka [11] gave a characterization of all payoff functions (extending objectives to a quantitative setting) for which both players have memoryless optimal strategies, implying an important lifting result: the sufficiency of memoryless strategies in finite two-player arenas is implied by the existence of memoryless optimal strategies in both players' finite one-player arenas. Bouyer et al. [4] extended this to chromatic finite memory.

The work most related to the present paper is by Colcombet, Fijalkow, and Horn [9], which gives a characterization of chaotic memory requirements for general safety objectives. Their constructions strongly rely on the model of chaotic memory; indeed, as a corollary of our results, we will see that already for regular safety objectives, chromatic and chaotic memory requirements do not coincide. Our first step is to obtain a characterization of chromatic memory requirements for (general and regular) safety objectives.

Monotony and safety objectives. Let us fix an objective $W \subseteq C^\omega$. In order to play optimally for W , a memory structure \mathcal{M} needs to be able to distinguish between histories that are not comparable for \preceq_W : indeed, if two finite words $w_1, w_2 \in C^*$ are not comparable, we can construct an arena in which the opponent chooses between playing w_1 and playing w_2 , and then the correct choice has to be made between a continuation only winning after w_1 , and a continuation only winning after w_2 . This motivates the following definition, which we call *\mathcal{M} -strong-monotony*.

► **Definition 3** (*\mathcal{M} -strong-monotony*). *Let $W \subseteq C^\omega$ be an objective and $\mathcal{M} = (M, m_{\text{init}}, \alpha_{\text{upd}})$ be a memory structure. We say that W is \mathcal{M} -strongly-monotone if for all $w_1, w_2 \in C^*$, $\alpha_{\text{upd}}^*(m_{\text{init}}, w_1) = \alpha_{\text{upd}}^*(m_{\text{init}}, w_2)$ implies that w_1 and w_2 are comparable for \preceq_W .*

Notice also that W is \mathcal{M} -strongly-monotone if and only if \overline{W} is \mathcal{M} -strongly-monotone (as being comparable for \preceq_W is equivalent to being comparable for $\preceq_{\overline{W}} = \succeq_W$). Although stated differently, a property called *strong monotony* was introduced in [1] and coincides with our definition of $\mathcal{M}_{\text{triv}}$ -strong-monotony. We can therefore see our definition as a reformulation and a generalization to handle arbitrary memory structures, rather than only the “memoryless memory structure” $\mathcal{M}_{\text{triv}}$.

The discussion above implies that for a memory \mathcal{M} , \mathcal{M} -strong-monotony is necessary for \mathcal{M} to be sufficient to play optimally. Depending on the type of objective (regular or general), we specify a class of arenas in which \mathcal{M} -strong-monotony can already be shown to

be necessary. Intuitively, regularity allows to distinguish distinct objectives with ultimately periodic words, which can be encoded into a finite arena.

► **Lemma 4** (Necessity of \mathcal{M} -strong-monotony). *Let W be an objective and \mathcal{M} a memory structure.*

1. *If W is regular and \mathcal{M} suffices to play optimally for W in all finite one-player arenas, then W is \mathcal{M} -strongly-monotone.*
2. *In the general case, if \mathcal{M} suffices to play optimally for W in all finitely branching one-player arenas, then W is \mathcal{M} -strongly-monotone.*

In the case of general reachability or safety objectives, it is useful to reformulate the notion of \mathcal{M} -strongly-monotone objectives using chains. Given a general reachability or safety objective W , its automaton $\mathcal{D}_W = (Q, C, q_{\text{init}}, \delta, F)$, and a memory structure $\mathcal{M} = (M, m_{\text{init}}, \alpha_{\text{upd}})$, we can associate with each state $m \in M$ the set $\Gamma_m^W \subseteq Q$ of states of \mathcal{D}_W that can be reached “simultaneously”. Formally, for $m \in M$,

$$\Gamma_m^W = \{\delta^*(q_{\text{init}}, w) \in Q \mid w \in C^*, \alpha_{\text{upd}}^*(m_{\text{init}}, w) = m\}.$$

We drop the superscript W if there is no ambiguity. The following property follows from the definitions.

► **Lemma 5.** *Let W be a general reachability or safety objective and $\mathcal{M} = (M, m_{\text{init}}, \alpha_{\text{upd}})$ be a memory structure. Objective W is \mathcal{M} -strongly-monotone if and only if for all $m \in M$, the set Γ_m is a chain for \preceq_W .*

Our initial definition of \mathcal{M} -strong-monotony required that any two finite words reaching the same state of \mathcal{M} must be comparable; in this reformulation, we focus instead on the automaton of W and require that states of the automaton that can be reached along with the same state of \mathcal{M} are comparable.

Our first characterization states that for general safety objectives, \mathcal{M} -strong-monotony also implies that \mathcal{M} suffices to play optimally. We state two variants of the results: in the first one, we assume that the preorder \preceq induced by the objective is well-founded (which includes the regular case), and the result holds for all arenas; in the second one we make no such assumption, but the result holds only for finitely branching arenas. We will discuss why we do not have the result with none of these hypotheses in Remark 8.

► **Theorem 6** (Characterization for safety). *Let W be a general safety objective, and \mathcal{M} be a memory structure.*

1. *If \preceq_W is well-founded (in particular, if W is regular), then \mathcal{M} suffices to play optimally for W if and only if W is \mathcal{M} -strongly-monotone.*
2. *In the general case, \mathcal{M} suffices to play optimally for W in all finitely branching arenas if and only if W is \mathcal{M} -strongly-monotone.*

A corollary of this characterization, by comparing to the characterization for chaotic memory in [9], is that chromatic and chaotic memory requirements differ already for regular safety objectives. We provide an instructive example below. Note that this provides a new simple kind of counterexample to Kopczyński’s conjecture [17], which Casares [7] had already falsified with a Muller objective.

► **Example 7.** Let $C = \{a, b, c, d\}$. We consider the regular language of finite words that first have to see both a and b (in any order), and only then see both c and d (in any order). The finite automaton \mathcal{D} recognizing this language is depicted in Figure 1 (left). We write W for the induced regular safety objective: $W = \text{Safe}(\mathcal{L}(\mathcal{D}))$.

The main claim is that the chaotic memory requirements for W are 2 states, which is easily obtained from the existing characterization [9] (this is the size of a maximal antichain for \preceq), while the chromatic requirements for W are 3 states. We depict a memory structure \mathcal{M} with three states which makes W \mathcal{M} -strongly-monotone in Figure 1 (right). To check that W is indeed \mathcal{M} -strongly-monotone, we have to check that there is no pair of words $w_1, w_2 \in C^*$ such that w_1 and w_2 reach the same state of \mathcal{M} , but reach non-comparable states in \mathcal{D} . The only two pairs of non-comparable states in \mathcal{D} are q_a and q_b , and q_c and q_d (besides these, states are ordered for \preceq from right to left). We can check that for this choice of \mathcal{M} , $\Gamma_{m_1} = \{q_{\text{init}}, q_a\}$, $\Gamma_{m_2} = \{q_b, q_{ab}, q_d, q_{cd}\}$, $\Gamma_{m_3} = \{q_c, q_{ab}, q_c, q_{cd}\}$. As these are all chains for \preceq , we have that W is \mathcal{M} -strongly-monotone.

It is not possible to find a chromatic memory structure \mathcal{M} with *two* states which makes W \mathcal{M} -strongly-monotone (this can be checked by trying to assign transitions to two states while distinguishing non-comparable states, and observing that all cases fail). \lrcorner

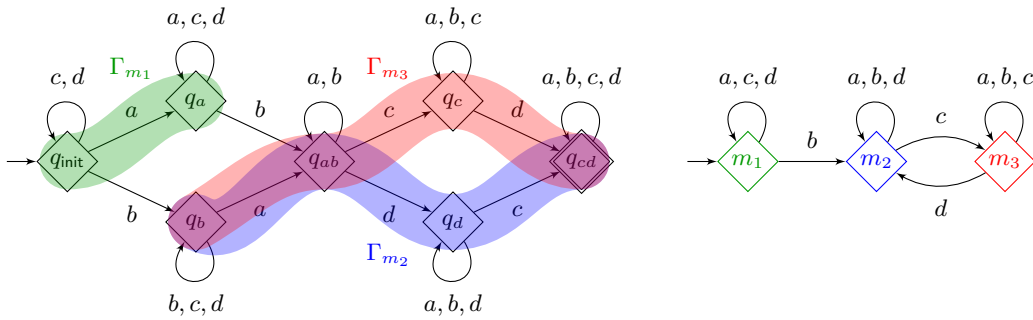

■ **Figure 1** Example 7: automaton \mathcal{D} (left) and a minimal memory structure \mathcal{M} (right) such that $\text{Reach}(\mathcal{L}(\mathcal{D}))$ and $\text{Safe}(\mathcal{L}(\mathcal{D}))$ are \mathcal{M} -strongly-monotone. In figures, diamonds are used to depict automaton states and memory states, and accepting states are depicted with a double border.

To conclude this section, we discuss why, with neither the well-foundedness hypothesis nor the finitely branching hypothesis from Theorem 6, we cannot expect such a characterization.

► **Remark 8.** If the prefix preorder of an objective W is not well-founded, then there is an infinite decreasing sequence of finite words $w_1 \succ w_2 \succ \dots$ in C^* . This means that for all $i \geq 1$, there is $w'_i \in C^\omega$ such that $w_i w'_i \in W$, but for $j > i$, $w_j w'_i \notin W$. We can then build the infinitely branching arena depicted in Figure 2 in which \mathcal{P}_2 first chooses a word w_j , and \mathcal{P}_1 can win by playing a word w'_i with $i \geq j$. This requires infinite memory, even if W is $\mathcal{M}_{\text{triv}}$ -strongly-monotone. \lrcorner

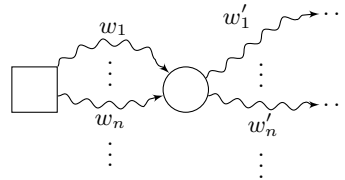

■ **Figure 2** Infinite branching arena in which \mathcal{P}_1 needs memory beyond the \mathcal{M} -strong-monotony property in Remark 8. In figures, circles (resp. squares) represent arena vertices controlled by \mathcal{P}_1 (resp. \mathcal{P}_2), i.e., in V_1 (resp. V_2). Squiggly arrows indicate a sequence of edges.

Capturing progress and reachability objectives. To play optimally for general and regular reachability objectives with a memory \mathcal{M} , \mathcal{M} -strong-monotony is necessary (Lemma 4) but

not enough: the following example shows that the memory structure must keep track of *progress*.

► **Example 9.** Let $C = \{a, b\}$. We consider the regular language $b^*a^+bC^*$ of words that have to see at least one a , followed by at least one b . This language is recognized by the finite automaton \mathcal{D} in Figure 3 (left). We write W for the induced regular reachability objective: $W = \text{Reach}(\mathcal{L}(\mathcal{D}))$.

In the arena in Figure 3 (center), \mathcal{P}_1 may win by starting a play with ab , but not without memory. The intuition is that playing a first makes some progress (it reaches an automaton state with more winning continuations), but is not sufficient to win, even if repeated. Therefore, in our memory structures, if a word makes some progress but without guaranteeing the win when repeated, we want the memory state to change upon reading that word. The memory structure in Figure 3 (right) is sufficient for W ; in particular, seeing the first a , which makes progress from q_{init} to q_a , changes the memory state. ◻

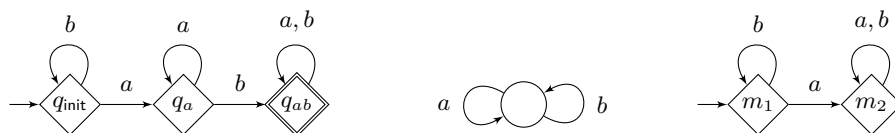

■ **Figure 3** Example 9: automaton \mathcal{D} (left), an arena requiring memory for $\text{Reach}(\mathcal{L}(\mathcal{D}))$ (center), and a minimal sufficient memory structure (right).

We formalize this intuition in the following definition, which is a generalization of the *progress-consistency* property [3].

► **Definition 10** (\mathcal{M} -progress-consistency). Let W be an objective and $\mathcal{M} = (M, m_{\text{init}}, \alpha_{\text{upd}})$ be a memory structure. We say that W is \mathcal{M} -progress-consistent if for all $m \in M$, for all $w_1 \in \Pi_{m_{\text{init}}, m}$, for all $w_2 \in \Pi_{m, m}$, if $w_1 \prec w_1 w_2$, then $w_1(w_2)^\omega \in W$.

Intuitively, this says that if it is possible to come back to the same memory state while reading a “word that makes progress” (i.e., that improves our situation by putting us in a position with more winning continuations), then repeating this word infinitely often from that point onward must be winning. The notion of $\mathcal{M}_{\text{triv}}$ -progress-consistency corresponds to the previous definition of *progress-consistency* [3].

The discussion above shows that \mathcal{M} -progress-consistency is necessary for a memory structure \mathcal{M} to be sufficient to play optimally. As for \mathcal{M} -strong-monotony, we distinguish the regular case from the general case.

► **Lemma 11** (Necessity of \mathcal{M} -progress-consistency). Let W be an objective and \mathcal{M} a memory structure.

1. If W is regular and \mathcal{M} suffices to play optimally for W in all finite one-player arenas, then W is \mathcal{M} -progress-consistent.
2. In the general case, if \mathcal{M} suffices to play optimally for W in all finitely branching one-player arenas, then W is \mathcal{M} -progress-consistent.

The following example should help the reader form the right intuition about \mathcal{M} -progress-consistency.

► **Example 12.** Let $C = \{a, b\}$. We consider the regular language of words containing $ababa$ as a subword, recognized by the finite automaton \mathcal{D} in Figure 4 (left). We consider the

memory structure \mathcal{M} remembering whether a or b was last seen, depicted in Figure 4 (right). The regular reachability objective $W = \text{Reach}(\mathcal{L}(\mathcal{D}))$ is \mathcal{M} -progress-consistent. Indeed, let us first consider $m = m_b$ in the definition of \mathcal{M} -progress-consistency. A finite word w_1 reaching m_b in \mathcal{M} necessarily reaches q_{init} , q_{ab} , or q_{abab} in Q (excluding the final state from the reasoning, as no progress is possible from it). After w_1 , words w_2 that both (i) make progress ($w_1 \prec w_1w_2$) and (ii) are a cycle on m_b necessarily see both a and b . Therefore, $w_1(w_2)^\omega$ is always a winning word. The same reasoning holds for $m = m_a$. Notice that the memory states from the memory structure do not carry enough information to ascertain when a word of the language has been seen (i.e., when the game is won).

The upcoming Theorem 14 implies that \mathcal{M} suffices to play optimally for \mathcal{P}_1 . ┘

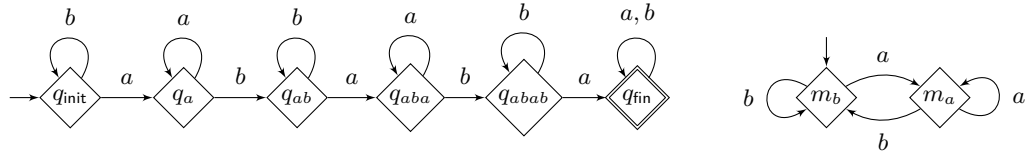

■ **Figure 4** Example 12: automaton \mathcal{D} (left) and memory structure \mathcal{M} (right).

This need to capture *progress* was not necessary to understand the memory requirements of safety objectives, which may be explained by the following reasoning.

► **Remark 13.** Unlike general reachability objectives, all general safety objectives are $\mathcal{M}_{\text{triv}}$ -progress-consistent. Here is a proof of this statement. Let $W \subseteq C^\omega$ be a general safety objective. Let $w_1, w_2 \in \prod_{m_{\text{init}}, m_{\text{init}}}^{\mathcal{M}_{\text{triv}}} = C^*$ be such that $w_1 \prec w_1w_2$. This implies that w_1w_2 , and therefore w_1 , have a non-empty set of winning continuations. Assume by contradiction that $w_1(w_2)^\omega \notin W$. As W is a general safety objective, there is a smallest $n \geq 1$ such that $w_1(w_2)^n$ has no winning continuation. Hence, $w_1(w_2)^{n-1}$ still has some winning continuations, so $w_1(w_2)^n \prec w_1(w_2)^{n-1}$. This is a contradiction, as $w_1 \prec w_1w_2$ implies that $w_1(w_2)^{n-1} \preceq w_1w_2(w_2)^{n-1} = w_1(w_2)^n$ by Lemma 1. This property is, at least intuitively, a reason hinting that the memory requirements of safety objectives are lower and easier to understand than those for their complement reachability objective. ┘

We have now discussed two necessary properties for a memory \mathcal{M} to be sufficient to play optimally for an objective. For regular reachability objectives, it appears that the conjunction of these two properties is also sufficient.

► **Theorem 14 (Characterization for reachability).** *Let W be a regular reachability objective and \mathcal{M} be a finite memory structure. Memory \mathcal{M} suffices to play optimally for W if and only if W is \mathcal{M} -strongly-monotone and \mathcal{M} -progress-consistent.*

► **Remark 15.** Unlike safety objectives, our characterization is only shown to hold for *regular* reachability objectives. We discuss in Section 5, Example 20 why our proof technique does not apply to general reachability objectives (even with \preceq well-founded and finite branching of the arenas). ┘

For objectives beyond reachability and safety, \mathcal{M} -strong-monotony and \mathcal{M} -progress-consistency may not imply the sufficiency of \mathcal{M} to play optimally. For instance, with $C = \{a, b\}$, let us consider the objective

$$W = \{w \in C^\omega \mid a \text{ and } b \text{ are both seen infinitely often}\},$$

which is ω -regular (it can be recognized by a *deterministic Büchi automaton* with two states), but is not a general reachability nor safety objective. Objective W is $\mathcal{M}_{\text{triv}}$ -strongly-monotone and $\mathcal{M}_{\text{triv}}$ -progress-consistent, but $\mathcal{M}_{\text{triv}}$ does not suffice to play optimally.

Lift for regular objectives. As a by-product of our results, we observe that for regular objectives, our characterizations deal with arbitrary arenas of any cardinality, but the properties used in the characterizations are already necessary in *finite one-player* arenas. This means that strategy-wise, to accomplish a regular objective, all the complexity already appears in finite graphs with no opponent. For the specific class of regular objectives that we study, this strengthens so-called *one-to-two-player lifts* from the literature [11, 4].

► **Theorem 16** (Finite-to-infinite, one-to-two-player lift). *Let W be a regular (reachability or safety) objective and \mathcal{M} be a finite memory structure. Memory \mathcal{M} suffices to play optimally for W (in all arenas) if and only if \mathcal{M} suffices to play optimally for W in finite one-player arenas.*

Proof. The implication from left-to-right holds as this is the same property quantified over fewer arenas. We argue the other implication for each case.

For regular safety objectives W , we showed that if \mathcal{M} suffices in finite one-player arenas, then W is \mathcal{M} -strongly-monotone (by Lemma 4 as W is regular), which implies that \mathcal{M} suffices in all arenas (by Theorem 6 as W is a safety condition with a well-founded preorder).

For regular reachability objectives W , we showed that if \mathcal{M} suffices in finite one-player arenas, then W is \mathcal{M} -strongly-monotone and \mathcal{M} -progress-consistent (by Lemmas 4 and 11 as W is regular), which implies that \mathcal{M} suffices in all arenas (by Theorem 14 as W is a regular reachability objective). ◀

On the complexity of finding small memory structures. We finally discuss the computational complexity of finding small memory structures for regular objectives. We formalize the question as two decision problems: given a regular reachability or safety objective, how much memory is required to play optimally for this objective?

MEMORY-SAFE

Input: A finite automaton \mathcal{D} inducing the regular safety objective $W = \text{Safe}(\mathcal{L}(\mathcal{D}))$ and an integer $k \in \mathbb{N}$.

Question: Does there exist a memory structure \mathcal{M} of size at most k which suffices to play optimally for W ?

MEMORY-REACH

Input: A finite automaton \mathcal{D} inducing the regular reachability objective $W = \text{Reach}(\mathcal{L}(\mathcal{D}))$ and an integer $k \in \mathbb{N}$.

Question: Does there exist a memory structure \mathcal{M} of size at most k which suffices to play optimally for W ?

It follows from our characterizations (Theorems 6 and 14) that the first problem is equivalent to asking whether there is a memory structure \mathcal{M} of size at most k such that $\text{Safe}(\mathcal{L}(\mathcal{D}))$ is \mathcal{M} -strongly-monotone, and the second problem whether there is a memory structure \mathcal{M} of size at most k such that $\text{Reach}(\mathcal{L}(\mathcal{D}))$ is \mathcal{M} -strongly-monotone and \mathcal{M} -progress-consistent.

► **Theorem 17** (Complexity of MEMORY-SAFE and MEMORY-REACH). *Both MEMORY-SAFE and MEMORY-REACH are NP-complete.*

For NP-hardness, we construct a reduction from the Hamiltonian cycle problem which works for both MEMORY-SAFE and MEMORY-REACH.

Our main insight is to reformulate the notion of \mathcal{M} -strong-monotony (NP-membership of MEMORY-SAFE follows from this reformulation). Let $W = \text{Safe}(\mathcal{L}(\mathcal{D}))$ be a regular objective

and $\mathcal{M} = (M, m_{\text{init}}, \alpha_{\text{upd}})$ be a memory structure. In Example 7, we have seen how to go from a memory structure \mathcal{M} such that W is \mathcal{M} -strongly-monotone to a covering of the states of \mathcal{D} by chains of states. We formulate exactly the requirements for such coverings in order to have a point of view equivalent to \mathcal{M} -strong-monotony. For $\Gamma \subseteq Q$ a set of states and $c \in C$, we define $\delta(\Gamma, c) = \{\delta(q, c) \mid q \in \Gamma\}$.

► **Definition 18** (Monotone decomposition). *Let $\mathcal{D} = (Q, C, q_{\text{init}}, \delta, F)$ be an automaton. We say that the sets $\Gamma_1, \dots, \Gamma_k \subseteq Q$ form a monotone decomposition of \mathcal{D} if*

- (a) $Q = \bigcup_{i=1}^k \Gamma_i$,
- (b) for all $c \in C$, for all $i \in \{1, \dots, k\}$, there is $j \in \{1, \dots, k\}$ such that $\delta(\Gamma_i, c) \subseteq \Gamma_j$, and
- (c) for all $i \in \{1, \dots, k\}$, Γ_i is a chain for \preceq .

Note that the sets Γ_i do not have to be disjoint (as was illustrated in Example 7). If we only consider requirements (a) and (b) of this definition, we recover the definition of an *admissible decomposition*, which can be used to quotient an automaton [12]. Here, we add the additional requirement (c) that each set of states is a chain for \preceq . Note that there always exists an admissible decomposition with just one set (by taking $\Gamma_1 = Q$), but finding a small *monotone* decomposition may not be so easy. This point of view in terms of monotone decompositions turns out to be equivalent to our initial point of view in terms of \mathcal{M} -strong-monotony in the following sense.

► **Lemma 19.** *Let \mathcal{D} be an automaton and W be equal to $\text{Safe}(\mathcal{L}(\mathcal{D}))$ or $\text{Reach}(\mathcal{L}(\mathcal{D}))$. Automaton \mathcal{D} admits a monotone decomposition with k sets if and only if W is \mathcal{M} -strongly-monotone for some memory structure \mathcal{M} of size k .*

It is instructive to reformulate the characterization of *chaotic* memory requirements from [9]: the original phrasing was that the number of memory states necessary and sufficient to play optimally for the safety objective W is the size of the largest antichain of \preceq_W . Using our terminology and Dilworth's theorem, it is equivalent to the smallest number of chains required to cover all states; that is, decompositions satisfying (a) and (c) in Definition 18, but not necessarily (b). Hence, it is smaller in general.

We have not discussed membership in NP of MEMORY-REACH, which is slightly more involved and is explained in Section 6, Lemma 22. We can reduce \mathcal{M} -progress-consistency to checking a polynomial number of emptiness queries of intersections of regular languages recognized by deterministic finite automata.

4 Characterization of the chromatic memory requirements of safety objectives

In this section, we prove the results about general safety objectives and \mathcal{M} -strong-monotony mentioned in Section 3, namely, Lemma 4 for the necessity of the condition and Theorem 6 for its sufficiency.

► **Lemma 4** (Necessity of \mathcal{M} -strong-monotony). *Let W be an objective and \mathcal{M} a memory structure.*

1. *If W is regular and \mathcal{M} suffices to play optimally for W in all finite one-player arenas, then W is \mathcal{M} -strongly-monotone.*
2. *In the general case, if \mathcal{M} suffices to play optimally for W in all finitely branching one-player arenas, then W is \mathcal{M} -strongly-monotone.*

Proof. Let $\mathcal{M} = (M, m_{\text{init}}, \alpha_{\text{upd}})$. We prove both items simultaneously, simply adding an observation in the regular case. We assume by contrapositive that W is not \mathcal{M} -strongly-monotone, i.e., there exist $w_1, w_2 \in C^*$ such that $\alpha_{\text{upd}}^*(m_{\text{init}}, w_1) = \alpha_{\text{upd}}^*(m_{\text{init}}, w_2)$, but w_1 and w_2 are not comparable for \preceq_W . This means that there exist $w'_1, w'_2 \in C^\omega$ such that $w'_1 \in w_1^{-1}W \setminus w_2^{-1}W$ and $w'_2 \in w_2^{-1}W \setminus w_1^{-1}W$, i.e., such that $w_1 w'_1 \in W$, $w_2 w'_1 \notin W$, $w_2 w'_2 \in W$, and $w_1 w'_2 \notin W$. In case W is regular, then $w_1^{-1}W$ and $w_2^{-1}W$ are ω -regular, so we may assume additionally that there exist $x_1, x_2 \in C^*$ and $y_1, y_2 \in C^+$ such that $w'_1 = x_1(y_1)^\omega$ and $w'_2 = x_2(y_2)^\omega$ are ultimately periodic words [19].

We build a one-player arena \mathcal{A} in which \mathcal{M} does not suffice to play optimally for \mathcal{P}_1 : arena \mathcal{A} is finitely branching in general, and can even be made finite when W is regular. In \mathcal{A} , there is a single vertex v in which a choice between two edges has to be made. This vertex v can be reached after seeing either w_1 or w_2 , and the choice has to be made between continuing with the word w'_1 or with the word w'_2 . We depict this arena in Figure 5.

An optimal strategy of \mathcal{P}_1 wins after seeing w_1 by continuing with w'_1 , and after seeing w_2 by continuing with w'_2 . However, a strategy based on \mathcal{M} will make the same choice after seeing both w_1 and w_2 since $\alpha_{\text{upd}}^*(m_{\text{init}}, w_1) = \alpha_{\text{upd}}^*(m_{\text{init}}, w_2)$, and can therefore not be optimal. \blacktriangleleft

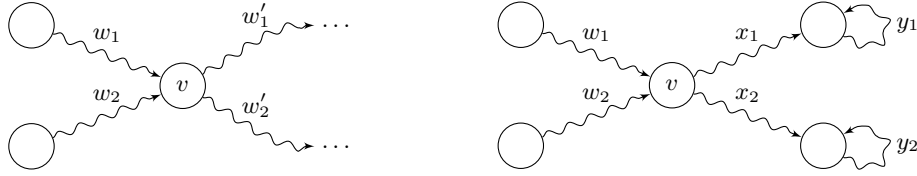

■ **Figure 5** Arena \mathcal{A} in which \mathcal{P}_1 cannot play optimally with a strategy based on \mathcal{M} , built in the proof of Lemma 4. The arena on the left is used in the general case, and the one on the right is used in the regular case.

► **Theorem 6** (Characterization for safety). *Let W be a general safety objective, and \mathcal{M} be a memory structure.*

1. *If \preceq_W is well-founded (in particular, if W is regular), then \mathcal{M} suffices to play optimally for W if and only if W is \mathcal{M} -strongly-monotone.*
2. *In the general case, \mathcal{M} suffices to play optimally for W in all finitely branching arenas if and only if W is \mathcal{M} -strongly-monotone.*

Proof. Let $\mathcal{D}_W = (Q, C, q_{\text{init}}, \delta, F)$ be the (possibly infinite) automaton of W , and let $\mathcal{M} = (M, m_{\text{init}}, \alpha_{\text{upd}})$ be a memory structure.

The necessity of \mathcal{M} -strong-monotony (in both cases) was proved in Lemma 4. We now prove the sufficiency of \mathcal{M} -strong-monotony. We assume that W is \mathcal{M} -strongly-monotone. We write w.l.o.g. $F = \{q_{\text{fin}}\}$. Let $\mathcal{A} = (V, V_1, V_2, E)$ be an arena. As per the hypotheses, we require that \preceq is well-founded or that \mathcal{A} is finitely branching.

For $v \in V$, $m \in M$, we define

$$Q_{v,m} = \{q \in \Gamma_m \mid \mathcal{P}_1 \text{ has a winning strategy for objective } q^{-1}W \text{ from } v\}.$$

Notice that $q_{\text{fin}} \notin Q_{v,m}$ for all v and m , as \mathcal{P}_1 cannot win for objective $q_{\text{fin}}^{-1}W = \emptyset$. We recall that notation Γ_m was defined in Section 3. The \mathcal{M} -strong-monotony hypothesis tells us that each Γ_m is a chain (Lemma 5), so each $Q_{v,m}$ is too.

We define a strategy $\sigma: V_1 \times M \rightarrow E$ of \mathcal{P}_1 based on memory \mathcal{M} . Let $v \in V_1$, $m \in M$. We distinguish three cases.

- If $Q_{v,m}$ is empty, then it means that the game has reached a situation where it cannot be won anymore, so $\sigma(v, m)$ is chosen arbitrarily.
- Otherwise, if $Q_{v,m}$ has a minimum $q_{v,m}$ for \preceq , then there is a strategy $\sigma_{v,m}$ winning for $q_{v,m}^{-1}W$ from v . We define $\sigma(v, m) = \sigma_{v,m}(\lambda_v)$ (we recall that λ_v is the empty history starting in v). Note that when $Q_{v,m}$ is non-empty, it always has a minimum if \preceq is well-founded.
- If $Q_{v,m}$ is not empty and has no minimum, we fall in this case under the hypothesis that \mathcal{A} is finitely branching. For $q \in Q_{v,m}$, let

$$E_{v,q} = \{\sigma'(\lambda_v) \in E \mid \sigma' \text{ is winning for } q^{-1}W \text{ from } v\}$$

be the set of outgoing edges of v that are taken immediately by at least one strategy winning for $q^{-1}W$ from v . We make three observations on sets $E_{v,q}$.

- For $q \in Q_{v,m}$, set $E_{v,q}$ is non-empty as \mathcal{P}_1 has a winning strategy for $q^{-1}W$ from v .
- For $q \in Q_{v,m}$, set $E_{v,q}$ is finite as v has finitely many outgoing edges.
- For $q, q' \in Q_{v,m}$, if $q \preceq q'$, then $E_{v,q} \subseteq E_{v,q'}$ as every strategy winning for $q^{-1}W$ is winning for $q'^{-1}W$.

As sets $E_{v,q}$ are non-empty, finite, and non-decreasing, this means that their intersection $\bigcap_{q \in Q_{v,m}} E_{v,q}$ is non-empty. Let $e \in \bigcap_{q \in Q_{v,m}} E_{v,q}$; we define $\sigma(v, m) = e$.

We have now defined σ ; we show that it is optimal. Let $v_0 \in V$ be such that \mathcal{P}_1 has a winning strategy for objective W from v_0 . Let $\pi = e_1 e_2 \dots \in E^\omega$ be a play consistent with σ from v_0 , and $w = \text{col}^\omega(\pi)$. We write $w = c_1 c_2 \dots$ and we show that $w \in W$. As W is a general safety objective, this amounts to showing that for every finite prefix $w_i = c_1 \dots c_i$ of w , $\delta^*(q_{\text{init}}, w_i) \neq q_{\text{fin}}$. For $i \geq 0$, let $q_i = \delta^*(q_{\text{init}}, w_i)$, $e_i = (v_{i-1}, c_i, v_i)$, and $m_i = \alpha_{\text{upd}}^*(m_{\text{init}}, w_i)$. We show by induction on i that for all $i \geq 0$, $q_i \in Q_{v_i, m_i}$. This suffices to prove the claim, as $q_{\text{fin}} \notin Q_{v_i, m_i}$ for $i \geq 0$.

For $i = 0$, we have $w_i = \varepsilon$, so $m_0 = \alpha_{\text{upd}}^*(m_{\text{init}}, w_i) = m_{\text{init}}$ and $q_0 = \delta^*(q_{\text{init}}, w_i) = q_{\text{init}}$. By definition, we have $q_{\text{init}} \in \Gamma_{m_{\text{init}}}$. As \mathcal{P}_1 has a winning strategy for $W = q_{\text{init}}^{-1}W$ from v_0 by hypothesis, we have that $q_0 \in Q_{v_0, m_0}$.

We now assume that $q_i \in Q_{v_i, m_i}$ for some $i \geq 0$. As $q_i \in \Gamma_{m_i}$, we have that $q_{i+1} = \delta(q_i, c_{i+1}) \in \Gamma_{\alpha_{\text{upd}}(m_i, c_{i+1})} = \Gamma_{m_{i+1}}$. To show that $q_{i+1} \in Q_{v_{i+1}, m_{i+1}}$, it is left to show that there is a winning strategy for $q_{i+1}^{-1}W$ from v_{i+1} . We know that Q_{v_i, m_i} is not empty, and we distinguish three cases.

- If $v_i \in V_2$, then since \mathcal{P}_1 has a strategy winning for $q_i^{-1}W$ from v_i , \mathcal{P}_1 must be able to win no matter the choice of \mathcal{P}_2 in v_i . Hence, \mathcal{P}_1 has a winning strategy from $\delta(q_i, c_{i+1})^{-1}W = q_{i+1}^{-1}W$ from v_{i+1} .
- If $v_i \in V_1$ and Q_{v_i, m_i} has a minimum q_{v_i, m_i} , then e_{i+1} is consistent with a strategy σ_{v_i, m_i} winning for $q_{v_i, m_i}^{-1}W$ from v . This strategy also wins for $q_i^{-1}W$, as $q_{v_i, m_i} \preceq q_i$. Thus, there must also be a strategy winning for $\delta(q_i, c_{i+1})^{-1}W = q_{i+1}^{-1}W$ from v_{i+1} .
- If $v_i \in V_1$ and Q_{v_i, m_i} has no minimum, then as $q_i \in Q_{v_i, m_i}$, there is in particular a winning strategy for $q_i^{-1}W$ from v_i that takes edge $\sigma(v_i, m_i) = (v_i, c_{i+1}, v_{i+1})$. Thus, \mathcal{P}_1 has a strategy winning for $\delta(q_i, c_{i+1})^{-1}W = q_{i+1}^{-1}W$ from v_{i+1} . ◀

In particular, we find that $\mathcal{M}_{\text{triv}}$ suffices (i.e., memoryless strategies suffice) for general safety objectives if and only if \preceq is a *total* preorder, which was already a corollary of [9].

5 Characterization of the chromatic memory requirements of regular reachability objectives

In this section, we prove Theorem 14 discussed in Section 3, which characterizes the memory requirements of regular reachability objectives. We start by proving the necessity of \mathcal{M} -progress-consistency, which was formulated in Lemma 11.

► **Lemma 11** (Necessity of \mathcal{M} -progress-consistency). *Let W be an objective and \mathcal{M} a memory structure.*

1. *If W is regular and \mathcal{M} suffices to play optimally for W in all finite one-player arenas, then W is \mathcal{M} -progress-consistent.*
2. *In the general case, if \mathcal{M} suffices to play optimally for W in all finitely branching one-player arenas, then W is \mathcal{M} -progress-consistent.*

Proof. Let $\mathcal{M} = (M, m_{\text{init}}, \alpha_{\text{upd}})$. We prove both items simultaneously. We assume by contrapositive that W is not \mathcal{M} -progress-consistent, i.e., there exist $m \in M$, $w_1 \in \Pi_{m_{\text{init}}, m}$, and $w_2 \in \Pi_{m, m}$ such that $w_1 \prec w_1 w_2$ but $w_1(w_2)^\omega \notin W$. As $w_1 \prec w_1 w_2$, there is $w' \in C^\omega$ such that $w_1 w' \notin W$ and $w_1 w_2 w' \in W$. In case W is regular, then $w_1^{-1} W$ and $(w_1 w_2)^{-1} W$ are ω -regular, so we may assume additionally that there exist $x \in C^*$ and $y \in C^+$ such that $w' = xy^\omega$ is an ultimately periodic word [19].

We build a one-player arena \mathcal{A} in which \mathcal{M} does not suffice to play optimally for \mathcal{P}_1 : arena \mathcal{A} is finitely branching in general, and can even be made finite when W is regular. In \mathcal{A} , there is a single vertex v in which a choice between two edges has to be made. This vertex can be reached after seeing w_1 , and the choice has to be made between looping on v with word w_2 , or continuing with word w' . We depict this arena in Figure 6.

An optimal strategy of \mathcal{P}_1 wins after seeing w_1 by continuing with $w_2 w'$, which produces the winning word $w_1 w_2 w'$. However, a strategy based on \mathcal{M} must always make the same choice in v after seeing w_1 since $\alpha_{\text{upd}}^*(m_{\text{init}}, w_1) = \alpha_{\text{upd}}^*(m_{\text{init}}, w_1(w_2)^n) = m$ for all $n \geq 0$. Hence, a strategy based on \mathcal{M} can only produce losing words $w_1 w'$ and $w_1(w_2)^\omega$. ◀



■ **Figure 6** Arena in which \mathcal{P}_1 cannot play optimally with a strategy based on \mathcal{M} obtained from the proof of Lemma 11. The arena on the left is used in the general case, and the one on the right is used in the regular case.

In order to prove the characterization, we start with extra preliminaries on the notion of trees induced by a strategy, and a classical way to define a notion of height for these trees.

Let \mathcal{D} be an automaton and $W = \text{Reach}(\mathcal{L}(\mathcal{D}))$ be the induced reachability objective. Let $\mathcal{A} = (V, V_1, V_2, E)$ be a (possibly infinite) arena. For $v \in V$ and σ a strategy of \mathcal{P}_1 on \mathcal{A} , we define $\mathcal{A}^{\sigma, v}$ to be the *tree induced by σ from v* , which contains all the histories from v consistent with σ . It can be built by induction:

- it contains as a root the empty history λ_v from v ;
- if γ is a history in $\mathcal{A}^{\sigma, v}$, then
 - if $\text{out}(\gamma) \in V_1$, γ has only one child which is $\gamma\sigma(\gamma)$;
 - if $\text{out}(\gamma) \in V_2$, γ has one child γe for each edge $e = (\text{out}(\gamma), c, v') \in E$.

We denote $\mathcal{A}_{|\mathcal{L}(\mathcal{D})}^{\sigma,v}$ for the subtree of $\mathcal{A}^{\sigma,v}$ in which nodes γ whose projection to colors are a word in $\mathcal{L}(\mathcal{D})$ are not prolonged. A tree is called *well-founded* if it has no infinite branch. Notice that σ is winning from v if and only if $\mathcal{A}_{|\mathcal{L}(\mathcal{D})}^{\sigma,v}$ is well-founded. In a well-founded tree, we can associate an ordinal *rank* to each node (a generalization of the *height* for finite trees). By induction, for a leaf γ of the tree, we define $\text{rank}(\gamma) = 0$, and for an internal node γ , we define $\text{rank}(\gamma) = \sup\{\text{rank}(\gamma') + 1 \mid \gamma' \text{ a child of } \gamma\}$. The rank of a tree is the rank of its root. More details on this notion of rank for well-founded relations can be found in [16, Appendix B].

The rank of a well-founded tree with finite branching is necessarily $< \omega$; we use greater ordinals only when the trees have infinite branching. The upcoming proof works on arenas with arbitrary branching, but for (infinite) arenas with finite branching, only finite trees with finite ranks are used.

We can now prove Theorem 14.

► **Theorem 14** (Characterization for reachability). *Let W be a regular reachability objective and \mathcal{M} be a finite memory structure. Memory \mathcal{M} suffices to play optimally for W if and only if W is \mathcal{M} -strongly-monotone and \mathcal{M} -progress-consistent.*

Proof. The necessity of the two conditions was proved respectively in Lemma 4 and Lemma 11.

We now prove the sufficiency of the two conditions. Let $\mathcal{D}_W = (Q, C, q_{\text{init}}, \delta, F)$ be the automaton of W (which is finite as W is regular), and $\mathcal{M} = (M, m_{\text{init}}, \alpha_{\text{upd}})$. We write w.l.o.g. $F = \{q_{\text{fin}}\}$. We assume that W is \mathcal{M} -strongly-monotone and \mathcal{M} -progress-consistent. Let $\mathcal{A} = (V, V_1, V_2, E)$ be a (possibly infinite) arena. We construct an optimal strategy based on memory \mathcal{M} , using the same idea as in the proof for safety objectives (Theorem 6): we once again consider a strategy based on memory \mathcal{M} making choices that are “locally optimal”, and deduce thanks to our hypotheses (\mathcal{M} -strong-monotony and \mathcal{M} -progress-consistency) that this strategy must be optimal.

For $v \in V$, $m \in M$, we define

$$q_{v,m} = \min_{\preceq} \{q \in \Gamma_m \mid \mathcal{P}_1 \text{ has a winning strategy for objective } q^{-1}W \text{ from } v\},$$

or we fix $q_{v,m} = q_{\text{fin}}$ if the set is empty (this is consistent as q_{fin} is the greatest state for \preceq , and all strategies are winning for objective $q_{\text{fin}}^{-1}W = C^\omega$). Notice that we rely on \mathcal{M} -strong-monotony and on regularity of W in this definition, as we are guaranteed that the min exists because Γ_m is a chain and because Q is finite. For $v \in V_1$, $m \in M$, we also fix a strategy $\sigma_{v,m}$ of \mathcal{P}_1 that is winning for $q_{v,m}^{-1}W$ from v . We make one additional requirement on $\sigma_{v,m}$: we assume that it is a strategy guaranteeing the *quickest win* from v for objective $q_{v,m}^{-1}W$. In other words, we take $\sigma_{v,m}$ such that the tree $\mathcal{A}_{|\mathcal{L}(\mathcal{D}_W)}^{\sigma_{v,m},v}$ has the least ordinal rank $\theta_{v,m}$ among all winning strategies.

We define a strategy $\sigma: V_1 \times M \rightarrow E$ of \mathcal{P}_1 based on memory \mathcal{M} : for $v \in V_1$, $m \in M$, we set $\sigma(v, m) = \sigma_{v,m}(\lambda_v)$.

Let $v_0 \in V$ be a vertex from which \mathcal{P}_1 has a winning strategy for objective W . We show that σ wins from v_0 . Let $\pi = (v_0, c_1, v_1)(v_1, c_2, v_2) \dots \in E^\omega$ be a play consistent with σ from v_0 , and $w = c_1 c_2 \dots \in C^\omega$. For $i \geq 0$, we fix $m_i = \alpha_{\text{upd}}^*(m_{\text{init}}, c_1 \dots c_i)$ and $q_i = \delta^*(q_{\text{init}}, c_1 \dots c_i)$. We show that $w \in W$, i.e., that there exists $i \geq 0$ such that $q_i = q_{\text{fin}}$. For brevity, we also write $q'_i = q_{v_i, m_i}$ and $\theta_i = \theta_{v_i, m_i}$.

As there are finitely many memory states and finitely many automaton states, we can find $m \in M$, $q, q' \in Q$, and an infinite increasing sequence of indices $(i_j)_{j \geq 0}$ such that for all $j \geq 0$, $m_{i_j} = m$, $q_{i_j} = q$, and $q'_{i_j} = q'$. We decompose w into infinitely many finite words

cut at every index i_j : for $j \geq 0$, let $w_j = c_{i_{j+1}} \dots c_{i_{j+1}}$. If $q = q_{\text{fin}}$, we are done, as w indeed reaches the final state of \mathcal{D} . We now assume by contradiction that $q \neq q_{\text{fin}}$. As q is reached infinitely many times and q_{fin} is absorbing, this implies that $q_i \neq q_{\text{fin}}$ for all $i \geq 0$. We prove a few properties about the various sequences that we have defined.

(a) We first show that

$$\forall i \geq 0, \forall j \geq i, q'_j \preceq \delta(q'_i, c_{i+1} \dots c_j). \quad (1)$$

To do so, we show that for all $i \geq 0$, $q'_{i+1} \preceq \delta(q'_i, c_{i+1})$, and Equation (1) then follows by induction. Let $i \geq 0$. As \mathcal{P}_1 has a winning strategy for $(q'_i)^{-1}W$ from v_i , and playing (v_i, c_{i+1}, v_{i+1}) is an action consistent with winning strategy σ_{v_i, m_i} , \mathcal{P}_1 also has a winning strategy for $\delta(q'_i, c_{i+1})^{-1}W$ from v_{i+1} . Moreover, as $q'_i \in \Gamma_{m_i}$, we have that $\delta(q'_i, c_{i+1}) \in \Gamma_{\alpha_{\text{upd}}(m_i, c_{i+1})} = \Gamma_{m_{i+1}}$. Hence, $q'_{i+1} \preceq \delta(q'_i, c_{i+1})$ as q'_{i+1} is defined as the minimum of a set in which $\delta(q'_i, c_{i+1})$ lies.

(b) We use this to show that the sequence $(q'_i)_{i \geq 0}$, which only depends on the arena vertices and the memory states visited, underapproximates the sequence $(q_i)_{i \geq 0}$, which corresponds to the actual automaton states visited by word w . Formally,

$$\forall i \geq 0, q'_i \preceq q_i. \quad (2)$$

We prove it by induction. For $i = 0$, we have $q_0 = q_{\text{init}}$, and by hypothesis, \mathcal{P}_1 has a winning strategy from v_0 for objective $W = q_{\text{init}}^{-1}W$. Moreover, $m_0 = m_{\text{init}}$ and $q_{\text{init}} \in \Gamma_{m_{\text{init}}}$, so by the definition of minimum, $q'_0 \preceq q_0$. We now assume that $q'_i \preceq q_i$ for some $i \geq 0$. By Equation (1), we know that $q'_{i+1} \preceq \delta(q'_i, c_{i+1})$. By Lemma 1, we have $\delta(q'_i, c_{i+1}) \preceq \delta(q_i, c_{i+1}) = q_{i+1}$. We conclude that $q'_{i+1} \preceq q_{i+1}$, which proves the claim. For all $i \geq 0$, as $q_i \neq q_{\text{fin}}$, we deduce moreover that $q'_i \neq q_{\text{fin}}$.

(c) We now prove that

$$\forall i \geq 0, q'_{i+1} = \delta(q'_i, c_{i+1}) \Rightarrow \theta_{i+1} < \theta_i. \quad (3)$$

Let $i \geq 0$ such that $q'_{i+1} = \delta(q'_i, c_{i+1})$. We know that the tree $\mathcal{A}_{|\mathcal{L}(\mathcal{D}_W)}^{\sigma_{v_i, m_i}, v_i}$ has rank θ_i . As $q'_i \neq q_{\text{fin}}$, $\theta_i \neq 0$. Hence, since playing (v_i, c_{i+1}, v_{i+1}) is consistent with strategy σ_{v_i, m_i} , it is possible to find a strategy that induces a tree from v_{i+1} for objective $\delta(q'_i, c_{i+1})^{-1}W$ of height strictly smaller than θ_i : we simply consider the strategy of the subtree of $\mathcal{A}_{|\mathcal{L}(\mathcal{D}_W)}^{\sigma_{v_i, m_i}, v_i}$ with root (v_i, c_{i+1}, v_{i+1}) . As $\delta(q'_i, c_{i+1}) = q'_{i+1}$ by hypothesis, we deduce that there is a strategy that wins for objective $(q'_{i+1})^{-1}W$ from v_{i+1} and whose tree has height $< \theta_i$. We conclude that $\theta_{i+1} < \theta_i$.

(d) We show a final property:

$$\forall i \geq i_0, q'_{i+1} = \delta(q'_i, c_{i+1}). \quad (4)$$

By Equation (1), the only other option, which we assume by contradiction, is that there is $k \geq i_0$ such that $q'_{k+1} \prec \delta(q'_k, c_{k+1})$. Let $j \geq 0$ such that $i_j \leq k < i_{j+1}$. We split w_j into two parts: $w_j^{(1)} = c_{i_{j+1}} \dots c_{k+1}$ and $w_j^{(2)} = c_{k+2} \dots c_{i_{j+1}}$. First, notice that $q'_{k+1} \prec \delta^*(q'_{i_j}, w_j^{(1)})$. Indeed, $q'_k \preceq \delta^*(q'_{i_j}, c_{i_{j+1}} \dots c_k)$ by Equation (1) and $q'_{k+1} \prec \delta(q'_k, c_{k+1})$ by hypothesis. Second, we have that $q'_{i_{j+1}} \preceq \delta^*(q'_{k+1}, w_j^{(2)})$ by Equation (1). We recall that $q'_{i_j} = q'_{i_{j+1}} = q'$. We deduce that

$$q'_{k+1} \prec \delta^*(q'_{i_j}, w_j^{(1)}) = \delta^*(q'_{i_{j+1}}, w_j^{(1)}) \preceq \delta^*(\delta^*(q'_{k+1}, w_j^{(2)}), w_j^{(1)}) = \delta^*(q'_{k+1}, w_j^{(2)} w_j^{(1)}).$$

We therefore have that $w_j^{(2)} w_j^{(1)}$ makes progress from q'_{k+1} . As $w_j = w_j^{(1)} w_j^{(2)}$ is a cycle on memory state m , we have that $w_j^{(2)} w_j^{(1)}$ must be a cycle on memory state $m_k = \alpha_{\text{upd}}^*(m, w_j^{(1)})$. By \mathcal{M} -progress-consistency, this means that $(w_j^{(2)} w_j^{(1)})^\omega \in (q'_{k+1})^{-1}W$, so $(w_j^{(1)} w_j^{(2)})^\omega = (w_j)^\omega \in (q'_{i_j})^{-1}W$. By Equation (2), this implies that $(w_j)^\omega \in q_{i_j}^{-1}W$. However, $\delta^*(q_{i_j}, w_j) = q_{i_j} \neq q_{\text{fin}}$, so repeating w_j from q_{i_j} cannot be winning. This is a contradiction, which means that Equation (4) holds.

We now use Equations (3) and (4) to deduce a contradiction with our initial hypothesis that $q \neq q_{\text{fin}}$. For every index $i \geq i_0$ onward, we have that $q'_{i+1} = \delta(q'_i, c_{i+1})$ (Equation (4)). By Equation (3), this means that the infinite ordinal sequence $(\theta_i)_{i \geq i_0}$ is decreasing, which is impossible. ◀

Our characterization applies to *regular* reachability objectives. We do not know whether a generalization to general reachability objectives (with well-founded preorder or in finitely branching arenas, as argued in Remark 8) holds. We provide an example showing that our proof technique fails for some general reachability objective with well-founded preorder.

► **Example 20.** Let $C = \mathbb{N}$. We define a general reachability objective

$$W = \{c_1 c_2 \dots \in C^\omega \mid \exists i < j, c_i \geq c_j\}$$

consisting of all the infinite sequences that are not increasing. We represent its (infinite) automaton \mathcal{D}_W in Figure 7. For preorder \preceq , we have that $q_{\text{init}} \prec q_i \prec q_{\text{fin}}$ for all $i \geq 0$, and $q_i \preceq q_j$ if and only if $i \leq j$. We observe that

- W is $\mathcal{M}_{\text{triv}}$ -strongly-monotone as preorder \preceq is total;
- W is $\mathcal{M}_{\text{triv}}$ -progress-consistent as repeating any color is immediately winning.

Moreover, \preceq is well-founded as every set of states of \mathcal{D}_W has a minimum, so Remark 8 does not apply. If Theorem 14 indeed extends to general reachability objectives with well-founded prefix preorder, then $\mathcal{M}_{\text{triv}}$ should suffice here (we leave the question open). Unfortunately, our proof technique for Theorem 14 does not work here. Let \mathcal{A} be the finitely branching arena in Figure 7. There is a winning strategy from every state. Referencing the vocabulary of the proof of Theorem 14, the strategy guaranteeing the quickest win from a state v_i is the strategy starting with $(v_i, i, v_{i+1})(v_{i+1}, i, v_{i+2})$, which wins in two moves. This means that strategy σ built in the proof of Theorem 14 plays (v_i, i, v_{i+1}) in v_i . But the infinite play generated by σ from v_0 then sees colors $0, 1, 2, 3, \dots$, which is not a winning word. ◻

6 Computational complexity of the chromatic memory requirements for regular objectives

The goal of this section is to prove Theorem 17, claiming that both MEMORY-SAFE and MEMORY-REACH are NP-complete.

Reformulation of \mathcal{M} -strong-monotony. We start by proving Lemma 19, which stated a reformulation of the \mathcal{M} -strong-monotony property as a *monotone decomposition* of automata (defined in Definition 18).

► **Lemma 19.** *Let \mathcal{D} be an automaton and W be equal to $\text{Safe}(\mathcal{L}(\mathcal{D}))$ or $\text{Reach}(\mathcal{L}(\mathcal{D}))$. Automaton \mathcal{D} admits a monotone decomposition with k sets if and only if W is \mathcal{M} -strongly-monotone for some memory structure \mathcal{M} of size k .*

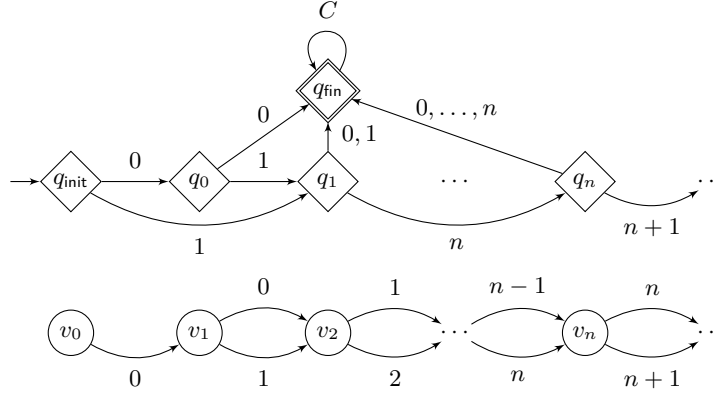

■ **Figure 7** Top: automaton \mathcal{D}_W where W is the *general* reachability objective from Example 20. In particular, transitions from q_{init} and q_0 to q_n with color n are not represented. Bottom: finitely branching arena in which our proof technique from Theorem 14 does not build an optimal strategy.

Proof. Let $\mathcal{D} = (Q, C, q_{\text{init}}, \delta, F)$. From a monotone decomposition $\Gamma_1, \dots, \Gamma_k$ of \mathcal{D} , we show how to build a memory structure $\mathcal{M} = (M, m_{\text{init}}, \alpha_{\text{upd}})$ of size k such that W is \mathcal{M} -strongly-monotone. We take

- $M = \{\Gamma_1, \dots, \Gamma_k\}$,
- m_{init} is any set Γ_i that contains q_{init} (which exists as $Q = \bigcup_{i=1}^k \Gamma_i$),
- for $\Gamma_i \in M$, $c \in C$, we define $\alpha_{\text{upd}}(\Gamma_i, c) = \Gamma_j$ for some j such that $\delta(\Gamma_i, c) \subseteq \Gamma_j$ (there may be multiple such j 's; any choice works).

We first show the following property about \mathcal{M} : for all $w \in C^*$, $\delta^*(q_{\text{init}}, w) \in \alpha_{\text{upd}}^*(m_{\text{init}}, w)$. We proceed by induction on the length of w . If $w = \varepsilon$ is the empty word, then $\delta^*(q_{\text{init}}, w) = q_{\text{init}} \in m_{\text{init}} = \alpha_{\text{upd}}^*(m_{\text{init}}, w)$ by definition of m_{init} . We now assume that $w = w'c$, with $c \in C$ and $\delta^*(q_{\text{init}}, w') \in \alpha_{\text{upd}}^*(m_{\text{init}}, w')$. Let $\Gamma_i = \alpha_{\text{upd}}^*(m_{\text{init}}, w')$ and $\Gamma_j = \alpha_{\text{upd}}^*(m_{\text{init}}, w'c)$. Then, $\delta^*(q_{\text{init}}, w'c) \in \delta(\Gamma_i, c)$. As $\delta(\Gamma_i, c) \subseteq \Gamma_j = \alpha_{\text{upd}}^*(m_{\text{init}}, w'c)$, we are done.

We now show that W is \mathcal{M} -strongly-monotone. Let $w_1, w_2 \in C^*$ be two finite words such that $\alpha_{\text{upd}}^*(m_{\text{init}}, w_1) = \alpha_{\text{upd}}^*(m_{\text{init}}, w_2)$. We set $\Gamma_i = \alpha_{\text{upd}}^*(m_{\text{init}}, w_1)$. We need to show that w_1 and w_2 are comparable for \preceq . Let $q_1 = \delta^*(q_{\text{init}}, w_1)$ and $q_2 = \delta^*(q_{\text{init}}, w_2)$. By the above property, we have that q_1 (resp. q_2) is in Γ_i . As Γ_i is a chain, we have that q_1 and q_2 are comparable for \preceq . Hence, w_1 and w_2 are too, which shows the desired implication.

Reciprocally, let $\mathcal{M} = (M, m_{\text{init}}, \alpha_{\text{upd}})$ be a memory structure such that W is \mathcal{M} -strongly-monotone. We show that sets $(\Gamma_m)_{m \in M}$ form a monotone decomposition of \mathcal{D} .

- As \mathcal{M} is a complete automaton, every (reachable) state q of \mathcal{D} has to be in a set Γ_m for some $m \in M$. Indeed, as there exists $w \in C^*$ such that $\delta^*(q_{\text{init}}, w) = q$, we can simply take $m = \alpha_{\text{upd}}^*(m_{\text{init}}, w)$.
- Let $c \in C$ and $m \in M$. Let $m' = \alpha_{\text{upd}}(m, c)$. We show that $\delta(\Gamma_m, c) \subseteq \Gamma_{m'}$. Let $q \in \Gamma_m$; we show that $\delta(q, c) \in \Gamma_{m'}$. As $q \in \Gamma_m$, there is $w \in C^*$ such that $\delta^*(q_{\text{init}}, w) = q$ and $\alpha_{\text{upd}}^*(m_{\text{init}}, w) = m$. Then, $\delta^*(q_{\text{init}}, wc) = \delta(q, c)$ and $\alpha_{\text{upd}}^*(m_{\text{init}}, wc) = m'$, so $\delta(q, c) \in \Gamma_{m'}$.
- For some $m \in M$, let $q_1, q_2 \in \Gamma_m$. We show that q_1 and q_2 are comparable for \preceq . There are words $w_1, w_2 \in C^*$ such that $\delta^*(q_{\text{init}}, w_1) = q_1$, $\delta^*(q_{\text{init}}, w_2) = q_2$, and $\alpha_{\text{upd}}^*(m_{\text{init}}, w_1) = \alpha_{\text{upd}}^*(m_{\text{init}}, w_2) = m$. As W is \mathcal{M} -strongly-monotone, w_1 and w_2 are comparable for \preceq , so that is also the case for q_1 and q_2 . This shows that all sets Γ_m are chains. ◀

Building on the previous lemma, we consider the following decision problem.

MONOTONY

Input: A finite automaton \mathcal{D} and an integer $k \in \mathbb{N}$.

Question: Is there a monotone decomposition of \mathcal{D} with at most k sets?

As we have just seen, this problem is equivalent to asking whether there is a memory structure \mathcal{M} of size at most k such that a regular objective W derived from \mathcal{D} is \mathcal{M} -strongly-monotone (Lemma 19), or whether there is a chromatic memory structure with $\leq k$ states that suffices to play optimally for $\text{Safe}(\mathcal{L}(\mathcal{D}))$ (Theorem 6). It is also related, though not equivalent, to the chromatic memory requirements of $\text{Reach}(\mathcal{L}(\mathcal{D}))$ (Theorem 14). We will show that the MONOTONY problem is NP-complete.

Membership in NP. We discuss here that the decision problems related to the properties used in our characterizations of chromatic memory requirements, \mathcal{M} -strong-monotony and \mathcal{M} -progress-consistency, are in NP. The idea is simply that, given a finite automaton \mathcal{D} and a memory structure \mathcal{M} , we can decide in polynomial time whether the objectives derived from \mathcal{D} are \mathcal{M} -strongly-monotone, and whether they are \mathcal{M} -progress-consistent.

► **Lemma 21.** *MEMORY-SAFE is in NP.*

Proof. We show that the MONOTONY problem belongs to NP, which is equivalent to our statement thanks to Lemma 19. Let $\mathcal{D} = (Q, C, q_{\text{init}}, \delta, F)$ be a finite automaton and $k \in \mathbb{N}$. Notice that if $k \geq |Q|$, the answer to the problem is always YES, as $(\{q\})_{q \in Q}$ is always a monotone decomposition. It is left to consider the case $k < |Q|$. A monotone decomposition with k sets of states of \mathcal{D} therefore has size polynomial in the inputs. We can verify that such sets indeed form a monotone decomposition in polynomial time, by checking each of the three requirements from the definition of monotone decomposition. This is clear for the first two requirements. For the third requirement, we comment on how to check in polynomial time that each set is a chain. One way to do it is to precompute, for every pair $q_1, q_2 \in Q$, whether $q_1 \preceq q_2$, $q_2 \preceq q_1$, or none of these. This amounts to solving language containment queries, which can be done in polynomial time for regular languages recognized by finite automata given as an input. Once all these relations have been precomputed, checking whether each set of the decomposition is a chain can be done quickly, as a chain is simply a set in which all pairs of elements are comparable. ◀

For regular reachability objectives, we express \mathcal{M} -progress-consistency in a way that makes decidability in polynomial time clear. This generalizes [3, Lemma 25] to handle memory structures and non-total prefix preorders.

► **Lemma 22.** *Let $\mathcal{D} = (Q, C, q_{\text{init}}, \delta, F)$ be a finite automaton, $W = \text{Reach}(\mathcal{L}(\mathcal{D}))$ be the derived regular reachability objective, and $\mathcal{M} = (M, m_{\text{init}}, \alpha_{\text{upd}})$ be a memory structure. We assume w.l.o.g. that \mathcal{D} has a single final state q_{fin} which is absorbing.*

Objective W is \mathcal{M} -progress-consistent if and only if

$$\forall m \in M, \forall q_1 \in Q, [(\Pi_{m_{\text{init}}, m} \cap \Pi_{q_{\text{init}}, q_1} \neq \emptyset) \Rightarrow (\forall q_2 \in Q \text{ s.t. } q_2 \neq q_{\text{fin}} \text{ and } q_1 \prec q_2, \Pi_{m, m} \cap \Pi_{q_1, q_2} \cap \Pi_{q_2, q_2} = \emptyset)].$$

This result reduces the search for words that witness “non- \mathcal{M} -progress-consistency” to a more constrained situation. In general, if a word $w \in \Pi_{m, m}$ witnesses that W is not \mathcal{M} -progress-consistent because it makes progress from a state q but does not win when repeated from q , then we may have to read w multiple times on the automaton before noticing that repeating it does not reach q_{fin} . However, in such a situation, we can actually find two states

$q_1 \prec q_2$ such that w is read from q_1 to q_2 and w is a cycle on q_2 — in other words, just by reading w twice on the right state, we can notice that w contradicts \mathcal{M} -progress-consistency.

Proof. The left-to-right implication can be shown by contrapositive. Negating the implication gives a $w_1 \in \Pi_{m_{\text{init}},m} \cap \Pi_{q_{\text{init}},q_1}$ and a $w_2 \in \Pi_{m,m} \cap \Pi_{q_1,q_2} \cap \Pi_{q_2,q_2}$ such that $w_1 \prec w_1w_2$ and $w_1(w_2)^\omega$ does not go through q_{fin} , so $w_1(w_2)^\omega \notin W$. This shows that W is not \mathcal{M} -progress-consistent.

For the right-to-left implication, we assume by contrapositive that W is not \mathcal{M} -progress-consistent: there exists $m \in M$, $w_1 \in \Pi_{m_{\text{init}},m}$, $w_2 \in \Pi_{m,m}$ such that $w_1 \prec w_1w_2$ and $w_1(w_2)^\omega \notin W$. For $i \geq 0$, let $q'_i = \delta^*(q_{\text{init}}, w_1(w_2)^i)$. We have $q'_0 \prec q'_1$ since $w_1 \prec w_1w_2$. By induction and by Lemma 1, the sequence $(q'_i)_{i \geq 0}$ is non-decreasing. As there are finitely many states, it therefore reaches a fixpoint, which cannot be q_{fin} as $w_1(w_2)^\omega \notin W$. We denote $q_2 = q'_j$ its fixpoint and $q_1 = q'_{j-1}$ the last state before reaching the fixpoint (in particular, $q_1 \prec q_2$, $\delta^*(q_1, w_2) = q_2$, and $\delta^*(q_2, w) = q_2$).

We have that $w_1(w_2)^{j-1} \in \Pi_{m_{\text{init}},m} \cap \Pi_{q_{\text{init}},q_1}$, $q_1 \prec q_2$, $q_2 \neq q_{\text{fin}}$, and $w_2 \in \Pi_{m,m} \cap \Pi_{q_1,q_2} \cap \Pi_{q_2,q_2}$, which shows that we do not have the implication from the statement. ◀

This condition is easy to check algorithmically, as it consists of checking emptiness and non-emptiness of intersections of regular languages for all memory states m and all pairs q_1, q_2 of comparable states of \mathcal{D} .

► **Corollary 23.** *MEMORY-REACH is in NP.*

Proof. Let $\mathcal{D} = (Q, C, q_{\text{init}}, \delta, F)$ be a finite automaton and $k \in \mathbb{N}$. If $k \geq |Q|$, then the answer to $\text{MEMORY-REACH}(\mathcal{D}, k)$ is always YES, as using \mathcal{D} as a memory structure (by omitting the final states of \mathcal{D}) always suffices to play optimally. Indeed, \mathcal{D} -strong-monotony and \mathcal{D} -progress-consistency of an objective induced by \mathcal{D} can be quickly checked (for \mathcal{D} -strong-monotony, by using \mathcal{D} as a memory structure, we always know precisely the current class of prefixes, which is even stronger than knowing a chain; for \mathcal{D} -progress-consistency, any progress necessarily changes the state as two words with distinct winning continuations cannot reach the same state). It is left to consider the case $k < |Q|$. A sufficient memory structure \mathcal{M} of size k then has size polynomial in the inputs. To check that it suffices to play optimally, we need to verify that W is \mathcal{M} -strongly-monotone and \mathcal{M} -progress-consistent. From memory \mathcal{M} , we can check that the sets Γ_m for each state m of \mathcal{M} form a monotone decomposition in polynomial time (Lemma 21). This means that \mathcal{M} -strong-monotony can be checked in polynomial time. The \mathcal{M} -progress-consistency property can also be checked in polynomial time by Lemma 22. ◀

NP-hardness. We show that the MONOTONY problem is NP-hard, using a reduction from the (directed) HAMILTONIANCYCLE problem, which is NP-complete [15]. In the following, a (directed) graph is a tuple $G = (V, E)$ with $E \subseteq V \times V$. A Hamiltonian cycle of G is a sequence (u_1, \dots, u_n) in which each state of V appears exactly once, $(u_i, u_{i+1}) \in E$ for all i , $1 \leq i < n$, and $(u_n, u_1) \in E$.

HAMILTONIANCYCLE

Input: A directed graph $G = (V, E)$.

Question: Is there a Hamiltonian cycle in G ?

► **Proposition 24.** *MONOTONY is NP-hard. More precisely, for every graph $G = (V, E)$, there is a polynomial-size automaton \mathcal{D}_G such that G has a Hamiltonian cycle if and only if \mathcal{D}_G has a monotone decomposition of size $|V| + |E| + 1$. Objective $\text{Reach}(\mathcal{L}(\mathcal{D}_G))$ is moreover $\mathcal{M}_{\text{triv}}$ -progress-consistent.*

Proof. We start by defining an operator $\text{Automaton}(\cdot)$ turning a directed graph into an automaton. Let $G = (V, E)$ be a directed graph. We define $\text{Automaton}(G)$ as the automaton $(Q, \Sigma, \delta, q_{\text{init}}, F)$ with $Q = V \uplus E$, $\Sigma = \{\text{in}, \text{out}\}$, and transitions such that

- for $v \in V$, $\delta(v, \text{in}) = \delta(v, \text{out}) = v$;
- for $e = (v_1, v_2) \in E$, $\delta(e, \text{in}) = v_1$ and $\delta(e, \text{out}) = v_2$.

We ignore q_{init} and F at the moment. This definition is inspired from a reduction in [2] (although the rest of the proof is different).

Now let us consider a graph $G = (V, E)$ as an input to the HAMILTONIANCYCLE problem. We show how to transform it in a polynomial-size automaton for which the answer to the MONOTONY problem (along with a well-chosen $k \in \mathbb{N}$) corresponds. Let $n = |V|$ and $m = |E|$. We assume that $m \geq n$ (otherwise, G cannot have a Hamiltonian cycle). We also consider the *cycle graph with n vertices* $C_n = (V_C, E_C)$, with $V_C = \{v_1^C, \dots, v_n^C\}$ and $E_C = \{e_1^C, \dots, e_n^C\}$ such that $e_i^C = (v_i^C, v_{i+1}^C)$ for $1 \leq i < n$ and $e_n^C = (v_n^C, v_1^C)$. We now consider an automaton $\mathcal{D}_G = (Q, \Sigma, \delta, q_{\text{init}}, F)$ based on the disjoint union $\text{Automaton}(C_n) \uplus \text{Automaton}(G)$ along with one new letter for each state and three extra states:

- $Q = (V_C \uplus E_C) \uplus (V \uplus E) \uplus \{q_{\text{init}}, \perp, \top\}$,
- $\Sigma = \{\text{in}, \text{out}\} \uplus \{a_z \mid z \in (V_C \cup E_C) \cup (V \cup E)\}$,
- $F = \{\top\}$.

The transitions with in and out are defined as above for states of $(V_C \cup E_C) \cup (V \cup E)$, and are self-loops on q_{init} , \perp and \top . We illustrate this construction in Figure 8.

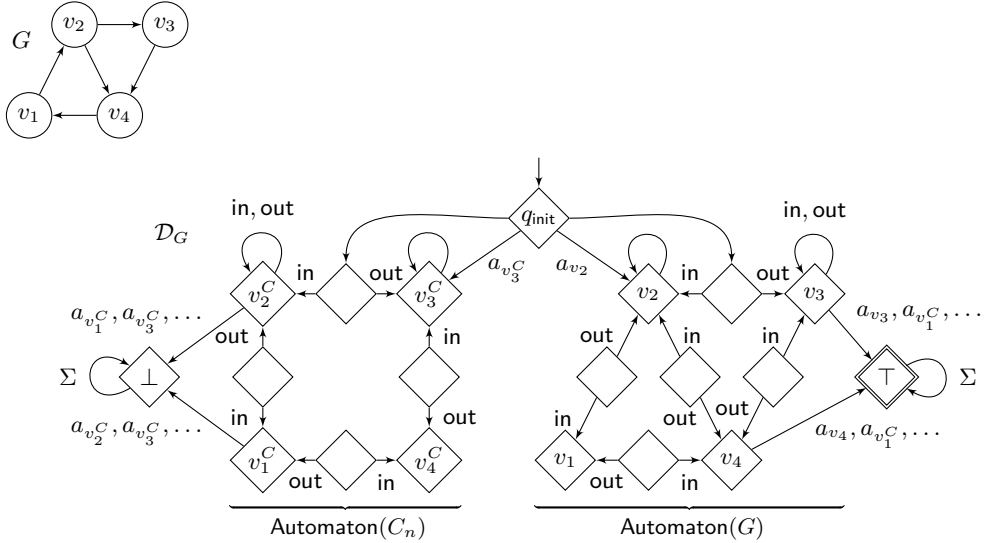

■ **Figure 8** Illustration of automaton \mathcal{D}_G starting from a graph G with 4 vertices. Only a few transitions of each kind are shown. Kinds of transitions that are not completely represented include: transitions from q_{init} to all states $z \in (V_C \cup E_C) \cup (V \cup E)$ with letter a_z , self-loops on all states in $V_C \cup V$ with letters in and out , transitions from all states $z \in (V_C \cup E_C) \cup (V \cup E)$ to \top with letter a_z , transitions from all states in V to \top with letters a_{v^C} with $v^C \in V_C$, transitions from all states in E to \top with letters a_{e^C} with $e^C \in E_C$, and transitions from all states in $(V_C \cup E_C) \cup (V \cup E)$ to \perp for letters a_z that do not go to \top .

The sole purpose of the new letters a_z is to induce a relevant ordering \preceq — intuitively, we want \perp to be the smallest state, \top to be the largest, and all automaton states corresponding to vertices (resp. edges) of $\text{Automaton}(C_n)$ to be smaller than all automaton states corresponding to vertices (resp. edges) of $\text{Automaton}(G)$, while making all other pairs of states

non-comparable. Formally, for $z, z' \in (V_C \cup E_C) \cup (V \cup E)$ we define

$$\delta(z, a_{z'}) = \begin{cases} \top & \text{if } z = z', \\ \top & \text{if } z \in V \text{ and } z' \in V_C, \\ \top & \text{if } z \in E \text{ and } z' \in E_C, \\ \perp & \text{otherwise.} \end{cases}$$

We moreover define, for all $z \in (V_C \cup E_C) \cup (V \cup E)$, $\delta(q_{\text{init}}, a_z) = z$, $\delta(\perp, a_z) = \perp$, and $\delta(\top, a_z) = \top$.

We sum up the relations between the elements that follow from this construction:

- for all $q \in Q \setminus \{\perp\}$, $\perp \prec q$,
- for all $q \in Q \setminus \{\top\}$, $q \prec \top$,
- for all $v^C \in V_C$, for all $v \in V$, $v^C \prec v$,
- for all $e^C \in E_C$, for all $e \in E$, $e^C \prec e$,
- all other pairs of distinct states are non-comparable for \preceq .

The largest antichain in \mathcal{D}_G for \preceq is attained by $V \cup E \cup \{q_{\text{init}}\}$: all these states are non-comparable, and all other states are comparable to some of them. This antichain has size $n + m + 1$. Therefore, a monotone decomposition of \mathcal{D}_G has size at least $n + m + 1$. We claim that it can have a size of exactly $n + m + 1$ if and only if G has a Hamiltonian cycle. This suffices to end the proof, since the size of \mathcal{D}_G is polynomial in the size of G , and `HAMILTONIANCYCLE(G)` then returns YES if and only if `MONOTONE($\mathcal{D}_G, n + m + 1$)` returns YES.

▷ **Claim 25.** Graph G has a Hamiltonian cycle if and only if \mathcal{D}_G has a monotone decomposition with $n + m + 1$ sets.

We first prove the left-to-right implication. We assume that G has a Hamiltonian cycle (u_1, \dots, u_n) . Let $e_i = (u_i, u_{i+1})$ for $1 \leq i < n$, and $e_n = (u_n, u_1)$. Let $E \setminus \{e_1, \dots, e_n\} = \{e_{n+1}, \dots, e_m\}$. The fact that there is a Hamiltonian cycle in G allows for a natural pairing of vertices (resp. edges) of C_n with vertices (resp. edges) of G in sets of a monotone decomposition, which will in particular be closed by reading in and out. We define sets $(\Gamma_i)_{1 \leq i \leq n+m+1}$ such that:

- for $1 \leq i \leq n$, $\Gamma_i = \{\perp, v_i^C, u_i, \top\}$;
- for $1 \leq i \leq n$, $\Gamma_{n+i} = \{\perp, e_i^C, e_i, \top\}$;
- for $1 \leq i \leq m - n$, $\Gamma_{2n+i} = \{\perp, e_{n+i}, \top\}$;
- $\Gamma_{n+m+1} = \{\perp, q_{\text{init}}, \top\}$.

We check that these sets form a monotone decomposition of \mathcal{D}_G . These sets cover the states of \mathcal{D}_G , and they are chains by construction. It is left to check the second requirement of a monotone decomposition. Let $i \in \{1, \dots, n + m + 1\}$. If $i \geq 2n + 1$, then Γ_i has three elements. For $a \in \Sigma$, the set $\delta(\Gamma_i, a)$ is a set with at most three elements that includes \perp and \top , so it is clearly a subset of some Γ_j . If $i \leq 2n$, Γ_i is a four-element set. Then,

- for $1 \leq i \leq n$, $\delta(\Gamma_i, \text{in}) = \delta(\Gamma_i, \text{out}) = \Gamma_i$ (as in and out are self-loops on states of $V_C \cup V \cup \{\perp, \top\}$);
- for $1 \leq i \leq n$, $\delta(\Gamma_{n+i}, \text{in}) = \{\perp, v_i^C, u_i, \top\} = \Gamma_i$ and $\delta(\Gamma_{n+i}, \text{out}) = \{\perp, v_{i+1}^C, u_{i+1}, \top\} = \Gamma_{i+1}$;
- for $z \in (V_C \cup E_C) \cup (V \cup E)$, $\delta(\Gamma_i, a_z) = \{\perp, \top\}$, which is a subset of any Γ_j .

We have shown that sets $(\Gamma_i)_{1 \leq i \leq n+m+1}$ form a monotone decomposition of \mathcal{D}_G of size $n + m + 1$.

We now prove the right-to-left implication. Let $(\Gamma_i)_{1 \leq i \leq n+m+1}$ be a monotone decomposition of \mathcal{D}_G with $n+m+1$ sets. Every set Γ_i contains at most two states besides \perp and \top (due to the chain requirement and the structure of chains in \mathcal{D}_G). As $V \cup E \cup \{q_{\text{init}}\}$ is an antichain of size $n+m+1$, every state of this set is in exactly one set Γ_i . Due to the limited number of sets and the chain structure, states of V_C (resp. E_C) need to be in a Γ_i along with an element of V (resp. E). As V_C and V have the same cardinality, this implies that for every $i \in \{1, \dots, n\}$, there is a unique $u_i \in V$ such that v_i^C and u_i are in the same Γ_j . We show that the sequence (u_1, \dots, u_n) is a Hamiltonian cycle of G . We write $u_{n+1} = u_1$ for brevity. Let $i \in \{1, \dots, n\}$. The edge e_i^C of C_n is in some set Γ_j along with some edge $e_i = (v_i, v_{i+1}) \in E$. We have that

- $\delta(\Gamma_j, \text{in})$ contains v_i^C and v_i . As $\delta(\Gamma_j, \text{in})$ is a subset of some Γ_l , and that v_i^C is in a single set along with u_i , we deduce that $v_i = u_i$.
- similarly, from observing $\delta(\Gamma_j, \text{out})$, we deduce that $v_{i+1} = u_{i+1}$.

Therefore, $e_i = (v_i, v_{i+1}) = (u_i, u_{i+1}) \in E$. We have shown that (u_1, \dots, u_n) is a Hamiltonian cycle of G , which proves the claim.

We additionally observe that objective $\text{Reach}(\mathcal{L}(\mathcal{D}_G))$ is $\mathcal{M}_{\text{triv}}$ -progress-consistent. Indeed, notice that if there are $q_1, q_2 \in Q$, $w \in C^*$ such that $\delta^*(q_1, w) = q_2$ and $q_1 \prec q_2$, then $q_2 = \top$ (any progress is immediately winning). ◀

We now have all the ingredients to prove Theorem 17.

► **Theorem 17** (Complexity of MEMORY-SAFE and MEMORY-REACH). *Both MEMORY-SAFE and MEMORY-REACH are NP-complete.*

Proof. The MEMORY-SAFE problem is in NP (Lemma 21), and was shown to be equivalent to the MONOTONE problem, itself NP-hard (Proposition 24). This shows that MEMORY-SAFE is NP-complete.

The MEMORY-REACH problem is in NP (Corollary 23). Moreover, in Proposition 24, the finite automata considered (the \mathcal{D}_G for G a directed graph) induce $\mathcal{M}_{\text{triv}}$ -progress-consistent regular reachability objectives. By Theorem 14, this means that a memory structure \mathcal{M} suffices for such an objective if and only if it is \mathcal{M} -strongly-monotone. In other words, a memory structure \mathcal{M} suffices for $\text{Reach}(\mathcal{L}(\mathcal{D}_G))$ if and only if it suffices for $\text{Safe}(\mathcal{L}(\mathcal{D}_G))$. As the problem is NP-hard for the family $\text{Safe}(\mathcal{L}(\mathcal{D}_G))$, it is also NP-hard for the family $\text{Reach}(\mathcal{L}(\mathcal{D}_G))$. ◀

We remark that our proof of NP-hardness of MEMORY-REACH relies solely on the \mathcal{M} -strong-monotony notion. We leave as an open problem whether finding a small \mathcal{M} such that a regular reachability objective is \mathcal{M} -progress-consistent is also NP-hard. This would be especially interesting if it held for the class of $\mathcal{M}_{\text{triv}}$ -strongly-monotone objectives, as it would suggest that there is a class of automata for which finding a smallest memory for their induced reachability objective is harder than for their induced safety objective.

7 Conclusion

We have characterized the minimal memory structures sufficient to play optimally for regular reachability and safety objectives. In doing so, we were able to prove that related decision problems about regular objectives were NP-complete. Our characterizations were encoded into a SAT solver that automatically generates a minimal memory structure given a finite automaton as an input (link in Section 1).

This article can be seen as one step toward understanding more generally the (chromatic or chaotic) memory requirements of all ω -regular objectives, as well as synthesizing minimal memory structures for them. The chaotic memory requirements of regular reachability objectives are still unknown, as well as the chromatic memory requirements of larger classes of ω -regular objectives (such as, e.g., the objectives recognized by deterministic Büchi automata).

References

- 1 Alessandro Bianco, Marco Faella, Fabio Mogavero, and Aniello Murano. Exploring the boundary of half-positionality. *Ann. Math. Artif. Intell.*, 62(1-2):55–77, 2011. doi:10.1007/s10472-011-9250-1.
- 2 Kellogg S. Booth. Isomorphism testing for graphs, semigroups, and finite automata are polynomially equivalent problems. *SIAM J. Comput.*, 7(3):273–279, 1978. doi:10.1137/0207023.
- 3 Patricia Bouyer, Antonio Casares, Mickael Randour, and Pierre Vandenbove. Half-positional objectives recognized by deterministic Büchi automata. In Bartek Klin, Slawomir Lasota, and Anca Muscholl, editors, *33rd International Conference on Concurrency Theory, CONCUR 2022, September 12–16, 2022, Warsaw, Poland*, volume 243 of *LIPICs*, pages 20:1–20:18. Schloss Dagstuhl – Leibniz-Zentrum für Informatik, 2022. doi:10.4230/LIPICs.CONCUR.2022.20.
- 4 Patricia Bouyer, Stéphane Le Roux, Youssouf Oualhadj, Mickael Randour, and Pierre Vandenbove. Games where you can play optimally with arena-independent finite memory. *Log. Methods Comput. Sci.*, 18(1), 2022. doi:10.46298/lmcs-18(1:11)2022.
- 5 Patricia Bouyer, Stéphane Le Roux, and Nathan Thomasset. Finite-memory strategies in two-player infinite games. In Florin Manea and Alex Simpson, editors, *30th EACSL Annual Conference on Computer Science Logic, CSL 2022, February 14–19, 2022, Göttingen, Germany (Virtual Conference)*, volume 216 of *LIPICs*, pages 8:1–8:16. Schloss Dagstuhl – Leibniz-Zentrum für Informatik, 2022. doi:10.4230/LIPICs.CSL.2022.8.
- 6 Patricia Bouyer, Mickael Randour, and Pierre Vandenbove. Characterizing omega-regularity through finite-memory determinacy of games on infinite graphs. In Petra Berenbrink and Benjamin Monmege, editors, *39th International Symposium on Theoretical Aspects of Computer Science (STACS 2022)*, volume 219 of *Leibniz International Proceedings in Informatics (LIPIcs)*, pages 16:1–16:16, Dagstuhl, Germany, 2022. Schloss Dagstuhl – Leibniz-Zentrum für Informatik. doi:10.4230/LIPICs.STACS.2022.16.
- 7 Antonio Casares. On the minimisation of transition-based Rabin automata and the chromatic memory requirements of Muller conditions. In *CSL*, volume 216, pages 12:1–12:17, 2022. doi:10.4230/LIPICs.CSL.2022.12.
- 8 Antonio Casares, Thomas Colcombet, and Karoliina Lehtinen. On the size of good-for-games Rabin automata and its link with the memory in Muller games. In Mikołaj Bojanczyk, Emanuela Merelli, and David P. Woodruff, editors, *49th International Colloquium on Automata, Languages, and Programming, ICALP 2022, July 4–8, 2022, Paris, France*, volume 229 of *LIPICs*, pages 117:1–117:20. Schloss Dagstuhl – Leibniz-Zentrum für Informatik, 2022. doi:10.4230/LIPICs.ICALP.2022.117.
- 9 Thomas Colcombet, Nathanaël Fijalkow, and Florian Horn. Playing safe. In Venkatesh Raman and S. P. Suresh, editors, *34th International Conference on Foundation of Software Technology and Theoretical Computer Science, FSTTCS 2014, December 15–17, 2014, New Delhi, India*, volume 29 of *LIPICs*, pages 379–390. Schloss Dagstuhl – Leibniz-Zentrum für Informatik, 2014. doi:10.4230/LIPICs.FSTTCS.2014.379.
- 10 Stefan Dziembowski, Marcin Jurdziński, and Igor Walukiewicz. How much memory is needed to win infinite games? In *Proceedings, 12th Annual IEEE Symposium on Logic in Computer Science, Warsaw, Poland, June 29 – July 2, 1997*, pages 99–110. IEEE Computer Society, 1997. doi:10.1109/LICS.1997.614939.

- 11 Hugo Gimbert and Wiesław Zielonka. Games where you can play optimally without any memory. In Martín Abadi and Luca de Alfaro, editors, *CONCUR 2005 – Concurrency Theory, 16th International Conference, CONCUR 2005, San Francisco, CA, USA, August 23–26, 2005, Proceedings*, volume 3653 of *Lecture Notes in Computer Science*, pages 428–442. Springer, 2005. doi:10.1007/11539452_33.
- 12 Abraham Ginzburg and Michael Yoeli. Products of automata and the problem of covering. *Transactions of the American Mathematical Society*, 116:253–266, 1965. URL: <http://www.jstor.org/stable/1994117>.
- 13 Yuri Gurevich and Leo Harrington. Trees, automata, and games. In Harry R. Lewis, Barbara B. Simons, Walter A. Burkhard, and Lawrence H. Landweber, editors, *Proceedings of the 14th Annual ACM Symposium on Theory of Computing, May 5-7, 1982, San Francisco, California, USA*, pages 60–65. ACM, 1982. doi:10.1145/800070.802177.
- 14 Alexey Ignatiev, António Morgado, and João Marques-Silva. PySAT: A Python toolkit for prototyping with SAT oracles. In Olaf Beyersdorff and Christoph M. Wintersteiger, editors, *Theory and Applications of Satisfiability Testing – SAT 2018 – 21st International Conference, SAT 2018, Held as Part of the Federated Logic Conference, FloC 2018, Oxford, UK, July 9–12, 2018, Proceedings*, volume 10929 of *Lecture Notes in Computer Science*, pages 428–437. Springer, 2018. doi:10.1007/978-3-319-94144-8_26.
- 15 Richard M. Karp. Reducibility among combinatorial problems. In Raymond E. Miller and James W. Thatcher, editors, *Proceedings of a symposium on the Complexity of Computer Computations, held March 20–22, 1972, at the IBM Thomas J. Watson Research Center, Yorktown Heights, New York, USA*, The IBM Research Symposia Series, pages 85–103. Plenum Press, New York, 1972. doi:10.1007/978-1-4684-2001-2_9.
- 16 Alexander S. Kechris. *Classical Descriptive Set Theory*. Graduate Texts in Mathematics. Springer New York, NY, 1995. doi:10.1007/978-1-4612-4190-4.
- 17 Eryk Kopczyński. *Half-positional Determinacy of Infinite Games*. PhD thesis, Warsaw University, 2008.
- 18 Stéphane Le Roux, Arno Pauly, and Mickael Randour. Extending finite-memory determinacy by Boolean combination of winning conditions. In Sumit Ganguly and Paritosh K. Pandya, editors, *38th IARCS Annual Conference on Foundations of Software Technology and Theoretical Computer Science, FSTTCS 2018, December 11–13, 2018, Ahmedabad, India*, volume 122 of *LIPICs*, pages 38:1–38:20. Schloss Dagstuhl – Leibniz-Zentrum für Informatik, 2018. doi:10.4230/LIPICs.FSTTCS.2018.38.
- 19 Robert McNaughton. Testing and generating infinite sequences by a finite automaton. *Inf. Control.*, 9(5):521–530, 1966. doi:10.1016/S0019-9958(66)80013-X.
- 20 Anil Nerode. Linear automaton transformations. *Proceedings of the American Mathematical Society*, 9(4):541–544, 1958. doi:10.2307/2033204.
- 21 Michael O. Rabin. Decidability of second-order theories and automata on infinite trees. *Transactions of the American Mathematical Society*, 141:1–35, 1969. URL: <http://www.jstor.org/stable/1995086>.
- 22 Wiesław Zielonka. Infinite games on finitely coloured graphs with applications to automata on infinite trees. *Theor. Comput. Sci.*, 200(1-2):135–183, 1998. doi:10.1016/S0304-3975(98)00009-7.