

Computational Choreography using Human Motion Synthesis

Patrick Perrine

California Polytechnic State University
1 Grand Avenue, San Luis Obispo, CA 93407
paperrin@calpoly.edu

Trevor Kirkby

tkirkby@calpoly.edu

Abstract

Should deep learning models be trained to analyze human performance art? To help answer this question, we explore an application of deep neural networks to synthesize artistic human motion. Problem tasks in human motion synthesis can include predicting the motions of humans in-the-wild, as well as generating new sequences of motions based on said predictions. We will discuss the potential of a less traditional application, where learning models are applied to predicting dance movements. There have been notable, recent efforts to analyze dance movements in a computational light, such as the Everybody Dance Now (EDN) learning model and a recent Cal Poly master's thesis, Take The Lead (TTL). We have effectively combined these two works along with our own deep neural network to produce a new system for dance motion prediction, image-to-image translation, and video generation.

1. Introduction

Human motion synthesis involves digitally extracting the geometry of the human body for analysis or use in software applications. This area has been explored using a variety of methodologies for a multitude of application areas. Some current research themes involve using deep neural networks for predicting human motion [17], generating graphics for augmented reality [3], and motion transfer [11].

In this research we intended to accomplish the following:

- Reproduce the results of relevant research in academia. More specifically, implement an instance of OpenPose [10] for processing human skeletons from video and Everybody Dance Now [11] for video generation.
- Design a custom deep learning model for human motion prediction, specifically for performance art.
- Apply a new dataset to all these models.

This model could be used by dance choreographers to analyze their dance pieces. Artists sometimes are concerned with subverting or reinforcing expectations, so being able to measure the predictability of their performance could allow them greater control to work to be more predictable or less predictable in their movements. This model could also have applications in computer graphics, animation, and mixed reality. Being able to generate new human motion and a subsequent video of predicted motion could ease the processing of human avatars.

2. Background

To understand human motion synthesis, one must understand the principles of computer vision. This field is concerned with utilizing digital cameras as “eyes” for computer programs to “see.” If one has some intuition of computer graphics, one can conceptualize computer vision as inverse computer graphics [6]. Whereas work in computer graphics is concerned with generating visuals based on data, computer vision is about extracting data from visuals. Despite the two fields being logical complements to each other, there has been much cross-fertilization in research for vision and graphics over decades. This has resulted in various sub-disciplines such as human motion synthesis, which has conceptual roots as early as the mid-1970's [22]. Studies in human motion saw a significant surge in the late 1990's/early 2000's [2] and have been consistently present in computer vision literature since.

Being familiar with various machine learning models, such as Recurrent Neural Networks (RNNs) [29], Convolutional Neural Networks (CNNs) [23], and Generative Adversarial Networks (GANs) [13] are often required to understand the architecture of these models.

Generative Adversarial Networks are systems in which two distinct neural networks are trained in competition. One of them optimizes towards distinguishing genuine and synthesized examples from a dataset, while the other optimizes towards synthesizing convincing examples to fool the first network [13]. Generative adversarial networks have been used successfully to create or transform images [42], and

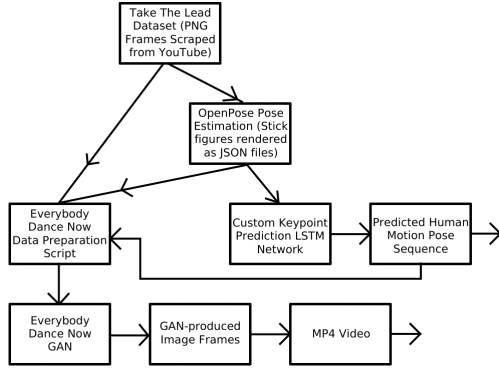

Figure 1. Our video-to-video system. We can intake 2D videos of human motion and output predicted sequences of motion, as well as output synthesized video of said predicted sequences.

more specifically for generating human motion [11].

3. Related Work

There have been various approaches to understanding human motion in digital form. A common approach is to intake video of humans performing actions, generate representations of their bodies, and then perform motion prediction [4, 7–9, 17–20, 24, 25, 27, 28, 31, 32, 36, 37, 40], motion transfer [11, 41], generate more sequences of motion [5], or various forms of analysis [15]. For the latter operations described, deep neural networks have commonly been applied, sometimes in conjunction with the popular OpenPose framework [10].

There has also been recent interest in human motion forecasting [26, 34], which focuses on predicting human movement trajectories from a distant, top-down perspective. Interest in prediction methods have also lent themselves to head position prediction for virtual reality [3].

4. Data Acquisition

Data was obtained primarily from the Take The Lead Dataset, which was published as part of a Cal Poly Master’s Thesis [14]. This data was originally collated from a publicly available repository: videos of dance were that were publicly posted on YouTube. Videos were downloaded and labeled by hand to reflect several different genres of dance. We acknowledge that there may exist some noise within the image data, which could affect results drawn from models trained on such data. Sample data from the Everybody Dance Now system was also used as a reference point. This includes footage of collaborators in the Everybody Dance Now project performing basic human motions optimized targeted for testing the Everybody Dance Now system. This sample data is linked publicly in the associated repository: <https://github.com/carolineec/>

EverybodyDanceNow. There were no human subjects involved within the course of this work.

As with virtually all machine learning systems, the products of our system may inherit biases present in the data the system is taught with. This issue has continued to be addressed within the academic communities of machine learning [16]. The potential of bias is difficult to entirely eliminate from machine learning, and it is important to consider the potential biases introduced through datasets. A significant mitigating factor of bias in this work is that all video of humans is preprocessed down to simple stick figures, which only convey information about a subject’s physical pose. Since our system is only aware of humans as stick figures, we believe it is difficult for our system to inherit biases from information such as race, gender, et cetera. The datasets we used were also acquired from two existing works that were vetted prior to publication. We suggest the investigation of ethical frameworks when creating new datasets to be released publicly [30].

5. System Design

Our system (see Figure 1) learns from the contents of YouTube videos of dancing, obtained from Take The Lead. These are stored as sequences of PNG images for each video frame. From there, OpenPose is used to estimate the human poses in each frame, creating JSON representations that give two-dimensional coordinates for various keypoints (head, chest, shoulders, et cetera). At this point, the data may be used in two separate models: Everybody Dance Now and the custom keypoint prediction LSTM network.

To make Everybody Dance Now work for videos scraped from YouTube, which often contain multiple people, the OpenPose JSON files are altered to only keep track of the poses for a single person in each video (using the closeness of the keypoints of consecutive frames to infer which person is which between frames). Then a data preparation script provided in the EDN repository is used to convert the JSON files to images of stick figures, which are provided as inputs to EDN’s conditional GAN. EDN trains from footage of a specific person performing movements and then can create footage of that same person performing new movements, based on stick figures of those movements. The footage is provided as sequential image frames, which are resized to a correct aspect ratio and then combined into a single video.

The custom keypoint predicting LSTM network, (KP-RNN, seen in Figure 2) accepts a sequence of poses as input (stored as 50 numbers, which are the (x,y) coordinates of the 25 keypoints created by OpenPose to model the position of a single person). It has several LSTM layers and some densely connected layers at the end, and for the most part is a pretty conventional sequential network that uses stochastic gradient descent to optimize mean squared error. The output is the prediction for the person’s pose in the next

frame of the video, again represented as 50 numbers. It should be noted that the predictions of this network can be used to generate a sequence of poses, which can then be provided as an input to Everybody Dance Now as poses to generate a new video based on. There was some fine-tuning of the architectural design of KP-RNN, but not so much as to overfit our training data.

Implementation

This system was set up on an instance of Google Colab Pro running with a Tesla P100 GPU as a development environment. The system is implemented using primarily Python and Bash, and both Everybody Dance Now and the custom architecture KP-RNN are implemented using Tensorflow [1] and Keras [12]. The creation of skeleton pose estimates is accomplished using the OpenPose project compiled from source. Results are visualized with Tensorboard and Python matplotlib, and pre-processed into video using Python Image Library and the FFMPEG command-line interface.

6. Testing and Validation

For the KP-RNN architecture, evaluation is mainly scored the same as the loss function, namely mean squared error between the predicted set of key point coordinates and the actual set of key point coordinates.

$$\text{Mean Squared Error} = \frac{1}{n} \left(\sum_{i=0}^n (\text{predicted}_i - \text{expected}_i)^2 \right)$$

KP-RNN is also able to generate a sequence of human movement which may be evaluated qualitatively.

For EDN, there are several relevant evaluation metrics available based on scoring the difference between the generated video and the actual video. The first such metric is the feature matching loss (figures 4a and 5a). Feature matching is calculated by running both the generated image and the actual image for a given pose through the image discriminator, comparing the similarities between the vector outputs of intermediate layers in the discriminator network, and optimizing to improve this similarity [38]. The second metric is perceptual reconstruction loss (figures 4b and 5b), which takes a very similar approach, except instead of using the intermediate layers of the GAN discriminator, it looks at the intermediate layers of a completely different image recognition architecture, specifically VGG19 [35]. Note that EDN records the difference between intermediate layers rather than the similarities for this metric, so while a higher value indicates better accuracy for feature matching, the opposite is true for perceptual reconstruction loss.

The actual generator and discriminator loss functions are comparatively not useful for the purposes of evaluation, because by construction they exist in a zero-sum game and in

a successful GAN they will remain approximately evenly matched. EDN also produces video outputs, which may be evaluated qualitatively. See figures 6b and 7b for sample frames from the generated video, based on the inputs in figures 6a and 7a. Figure 6a is from the Everybody Dance Now demonstration dataset, and uses a more complex skeleton figure with individual keypoints for hands and face, whereas figure 7a is from the Take The Lead dataset, and uses a simplified skeleton with fewer keypoints.

Project Goal Evaluation

Here is how we accomplished our original goals, along with some more technical details:

- Reproduce the results of relevant research in academia.

This was mostly accomplished. However, for EDN, we found an issue where the model does not recognize more than one person. We now have a functional solution in which we can pre-process new 2D videos of multiple people and focus on a single person throughout the video sequence. This complies with the limitation of EDN being only able to process one person's sequence.

- Design a custom deep learning model for human motion prediction, specifically tailored for performance art.

We now have our own LSTM-based architecture, KP-RNN, for predicting human motion sequences, which we developed in Google Colab. As for the hardware we are used to develop the system, we have been using an instance of Google Colab Pro. Our code is publicly available on this GitHub repository: <https://github.com/patrickrperrine/comp-choreo>

- Apply a new dataset to all these models.

We were interested in creating a new dataset of theatrical performances to be used for prediction along with our existing dance dataset. We found this to be difficult and too time-constrained for the scope of this project.

7. Future Work

Through our literature search, we ended up exploring a number of different types of deep learning models, from GANs to RNNs to various hybrids. We feel that this was acceptable for a class research project, but we are aware that in more dedicated research projects outside of coursework, this is not always the best approach for researching models. It can be difficult to compare models to one another when they have very different architectures and even different end results. This project allowed us to learn this first-hand, so that we will be more targeted in our future research.

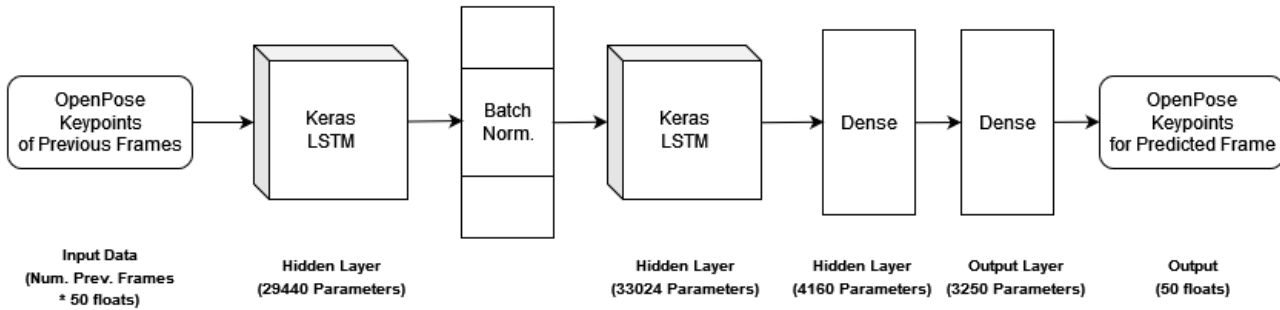

Figure 2. Our Keypoint Recurrent Neural Network Architecture (KP-RNN).

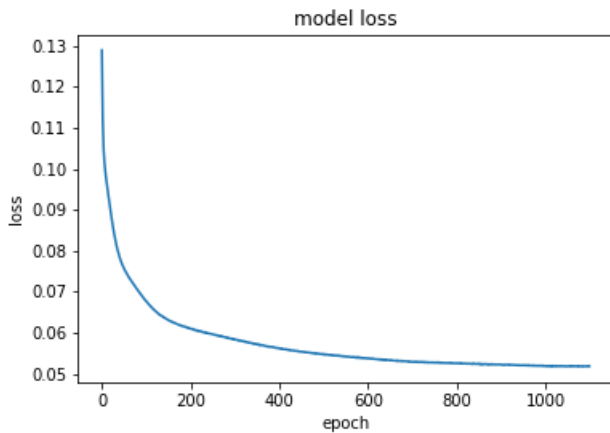

Figure 3. KP-RNN training error over time. Accuracy at 1000 epochs was 0.94579

We found that creating a new, usable dataset can be rather difficult. Acquiring the theatrical performance data as originally proposed could be a fruitful endeavor, as described repeatedly through the project’s documentation. Having more computational power to try to build larger, custom architectures could lead to novel results in human motion prediction. Exploring newer, related topics such as human trajectory prediction [34] using transfer learning could be of interest.

8. Conclusions

This project is a relevant exploration into deep learning applications, as our system contains a deep learning architecture. Our system is also a multiagent system [39], in which it uses multiple intelligent agents, including a predictor agent and the two GAN agents (generator and discriminator.) All three agents interact with each other in some notable fashion, such as the zero-sum game that the generator and discriminator [13]. They all either collaborate or

cooperate in their interactions and are not concerned with resource management. All agents in this system are also implemented as learning agents [33].

In our exploration of various models and other academic works such as datasets, we found issues in the legality in recreating their work. More specifically, we attempted to explore the creation of the Human 3.6M dataset [21], which is very popular in human motion prediction models [5]. This dataset is not in the same format as the keypoint structures of human motion as OpenPose, leading to incompatibility with our Take the Lead dataset and models other than EDN. We attempted to contact the creators of Human 3.6M to learn about how they parsed 2D video data into their result, so that we could parse Take the Lead dance data into that same format to be usable by various models. We ran into an issue where it seemed that this conversion process was proprietary and/or inaccessible to students with limited resources.

Acknowledgements

This work was partially supported by a Cal Poly Graduate Assistant Fellowship to Patrick Perrine. We thank Professors Franz Kurfess and Jonathan Ventura for their support of this work.

References

- [1] Martin Abadi, Paul Barham, Jianmin Chen, Zhifeng Chen, Andy Davis, Jeffrey Dean, Matthieu Devin, Sanjay Ghemawat, Geoffrey Irving, Michael Isard, et al. Tensorflow: A system for large-scale machine learning. In *12th USENIX symposium on operating systems design and implementation (OSDI 16)*, pages 265–283, 2016. 3
- [2] Jake K Aggarwal and Quin Cai. Human motion analysis: A review. *Computer vision and image understanding*, 73(3):428–440, 1999. 1
- [3] Abdenour Amamra. Smooth head tracking for virtual reality applications. *Signal, Image and Video Processing*, 11(3):479–486, 2017. 1, 2

- [4] Emad Barsoum, John Kender, and Zicheng Liu. HP-GAN: Probabilistic 3d human motion prediction via gan. In *Proceedings of the IEEE conference on computer vision and pattern recognition workshops*, pages 1418–1427, 2018. 2
- [5] Neeraj Bhattan, Yudhik Agrawal, Sai Soorya Rao, Aman Goel, and Avinash Sharma. Glocalnet: Class-aware long-term human motion synthesis. In *Proceedings of the IEEE/CVF Winter Conference on Applications of Computer Vision*, pages 879–888, 2021. 2, 4
- [6] Bruce G Baumgart. A polyhedron representation for computer vision. In *Proceedings of the May 19-22, 1975, national computer conference and exposition*, pages 589–596, 1975. 1
- [7] Samy Bengio, Oriol Vinyals, Navdeep Jaitly, and Noam Shazeer. Scheduled sampling for sequence prediction with recurrent neural networks. *arXiv preprint arXiv:1506.03099*, 2015. 2
- [8] Judith Butepage, Michael J Black, Danica Kragic, and Hedvig Kjellstrom. Deep representation learning for human motion prediction and classification. In *Proceedings of the IEEE conference on computer vision and pattern recognition*, pages 6158–6166, 2017. 2
- [9] Haoye Cai, Chunyan Bai, Yu-Wing Tai, and Chi-Keung Tang. Deep video generation, prediction and completion of human action sequences. In *Proceedings of the European Conference on Computer Vision (ECCV)*, pages 366–382, 2018. 2
- [10] Zhe Cao, Gines Hidalgo, Tomas Simon, Shih-En Wei, and Yaser Sheikh. Openpose: realtime multi-person 2d pose estimation using part affinity fields. *IEEE transactions on pattern analysis and machine intelligence*, 43(1):172–186, 2019. 1, 2
- [11] Caroline Chan, Shiry Ginosar, Tinghui Zhou, and Alexei A Efros. Everybody dance now. In *Proceedings of the IEEE/CVF International Conference on Computer Vision*, pages 5933–5942, 2019. 1, 2
- [12] Francois Chollet et al. Keras: The python deep learning library. *Astrophysics Source Code Library*, pages ascl–1806, 2018. 3
- [13] Antonia Creswell, Tom White, Vincent Dumoulin, Kai Arulkumaran, Biswa Sengupta, and Anil A Bharath. Generative adversarial networks: An overview. *IEEE Signal Processing Magazine*, 35(1):53–65, 2018. 1, 4
- [14] Ty Farris. Take The Lead: Toward a virtual video dance partner. *Cal Poly Digital Commons*, 2021. 2
- [15] David A Forsyth, Okan Arikan, Leslie Ikemoto, Deva Ramanan, and James O’Brien. Computational studies of human motion: Tracking and motion synthesis. *Foundations and Trends in Computer Graphics and Vision*, 2006. 2
- [16] Andre Fu, Elisa Ding, Mahdi S Hosseini, and Konstantinos N Plataniotis. P4ai: Approaching ai ethics through principlism. In *Neural Information Processing Systems 2021 Workshops*, 2021. 2
- [17] Partha Ghosh, Jie Song, Emre Aksan, and Otmar Hilliges. Learning human motion models for long-term predictions. In *2017 International Conference on 3D Vision (3DV)*, pages 458–466. IEEE, 2017. 1, 2
- [18] Anand Gopalakrishnan, Ankur Mali, Dan Kifer, Lee Giles, and Alexander G Ororbia. A neural temporal model for human motion prediction. In *Proceedings of the IEEE/CVF Conference on Computer Vision and Pattern Recognition*, pages 12116–12125, 2019. 2
- [19] Chunzhi Gu, Yan Zhao, and Chao Zhang. Learning to predict diverse human motions from a single image via mixture density networks. *arXiv preprint arXiv:2109.05776*, 2021. 2
- [20] Luca Hermes, Barbara Hammer, and Malte Schilling. Application of graph convolutions in a lightweight model for skeletal human motion forecasting. *arXiv preprint arXiv:2110.04810*, 2021. 2
- [21] Catalin Ionescu, Dragos Papava, Vlad Olaru, and Cristian Sminchisescu. Human3.6m: Large scale datasets and predictive methods for 3d human sensing in natural environments. *IEEE transactions on pattern analysis and machine intelligence*, 36(7):1325–1339, 2013. 4
- [22] Gunnar Johansson. Visual motion perception. *Scientific American*, 232(6):76–89, 1975. 1
- [23] Yann LeCun, Yoshua Bengio, et al. Convolutional networks for images, speech, and time series. *The handbook of brain theory and neural networks*, 3361(10):1995, 1995. 1
- [24] Maosen Li, Siheng Chen, Yangheng Zhao, Ya Zhang, Yanfeng Wang, and Qi Tian. Multiscale spatio-temporal graph neural networks for 3d skeleton-based motion prediction. *IEEE Transactions on Image Processing*, 30:7760–7775, 2021. 2
- [25] Zimo Li, Yi Zhou, Shuangjiu Xiao, Chong He, Zeng Huang, and Hao Li. Auto-conditioned recurrent networks for extended complex human motion synthesis. *arXiv preprint arXiv:1707.05363*, 2017. 2
- [26] Karttikeya Mangalam, Yang An, Harshayu Girase, and Jitendra Malik. From goals, waypoints and paths to long term human trajectory forecasting. In *Proceedings of the IEEE/CVF International Conference on Computer Vision*, pages 15233–15242, 2021. 2
- [27] Wei Mao, Miaomiao Liu, and Mathieu Salzmann. Generating smooth pose sequences for diverse human motion prediction. In *Proceedings of the IEEE/CVF International Conference on Computer Vision*, pages 13309–13318, 2021. 2
- [28] Angel Martinez-Gonzalez, Michael Villamizar, and Jean-Marc Odobez. Pose transformers (potr): Human motion prediction with non-autoregressive transformers. In *Proceedings of the IEEE/CVF International Conference on Computer Vision*, pages 2276–2284, 2021. 2
- [29] Larry Medsker and Lakhmi C Jain. *Recurrent neural networks: design and applications*. CRC press, 1999. 1
- [30] Margaret Mitchell, Simone Wu, Andrew Zaldivar, Parker Barnes, Lucy Vasserman, Ben Hutchinson, Elena Spitzer, Inioluwa Deborah Raji, and Timnit Gebru. Model cards for model reporting. In *Proceedings of the Conference on Fairness, Accountability, and Transparency*, pages 220–229, 2019. 2
- [31] Abdullh Mohamed, Huancheng Chen, Zhangyang Wang, and Christian Claudel. Skeleton-graph: Long-term 3d motion prediction from 2d observations using deep spatio-temporal graph cnns. *arXiv preprint arXiv:2109.10257*, 2021. 2

- [32] Hee-Seung Moon and Jiwon Seo. Fast user adaptation for human motion prediction in physical human–robot interaction. *IEEE Robotics and Automation Letters*, 7(1):120–127, 2021. 2
- [33] Stuart Russell and Peter Norvig. *Artificial Intelligence: A Modern Approach*. Pearson, 2021. 4
- [34] Nasim Shafiee, Taskin Padir, and Ehsan Elhamifar. Introvert: Human trajectory prediction via conditional 3d attention. In *Proceedings of the IEEE/CVF Conference on Computer Vision and Pattern Recognition*, pages 16815–16825, 2021. 2, 4
- [35] Karen Simonyan and Andrew Zisserman. Very deep convolutional networks for large-scale image recognition. *arXiv preprint arXiv:1409.1556*, 2014. 3
- [36] Ruben Villegas, Dumitru Erhan, Honglak Lee, et al. Hierarchical long-term video prediction without supervision. In *International Conference on Machine Learning*, pages 6038–6046. PMLR, 2018. 2
- [37] Chenxi Wang, Yunfeng Wang, Zixuan Huang, and Zhiwen Chen. Simple baseline for single human motion forecasting. In *Proceedings of the IEEE/CVF International Conference on Computer Vision*, pages 2260–2265, 2021. 2
- [38] Ting-Chun Wang, Ming-Yu Liu, Jun-Yan Zhu, Andrew Tao, Jan Kautz, and Bryan Catanzaro. High-resolution image synthesis and semantic manipulation with conditional gans. In *Proceedings of the IEEE conference on computer vision and pattern recognition*, pages 8798–8807, 2018. 3
- [39] Michael Wooldridge. *An introduction to multiagent systems*. John Wiley & sons, 2009. 4
- [40] Mohammad Samin Yasar and Tariq Iqbal. Improving human motion prediction through continual learning. *arXiv preprint arXiv:2107.00544*, 2021. 2
- [41] Dongsheng Zhou, Chongyang Guo, Rui Liu, Chao Che, Deyun Yang, Qiang Zhang, and Xiaopeng Wei. Hierarchical learning recurrent neural networks for 3d motion synthesis. *International Journal of Machine Learning and Cybernetics*, pages 1–13, 2021. 2
- [42] Jun-Yan Zhu, Taesung Park, Phillip Isola, and Alexei A Efros. Unpaired image-to-image translation using cycle-consistent adversarial networks. In *Proceedings of the IEEE international conference on computer vision*, pages 2223–2232, 2017. 1

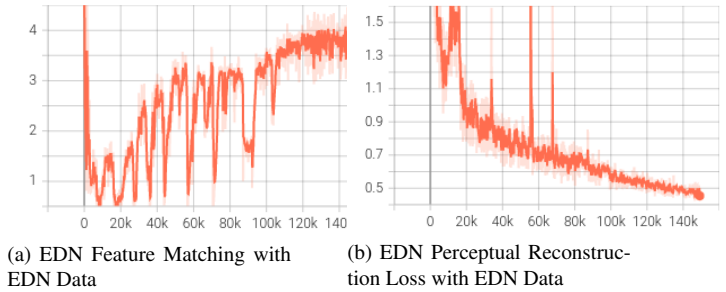

Figure 4

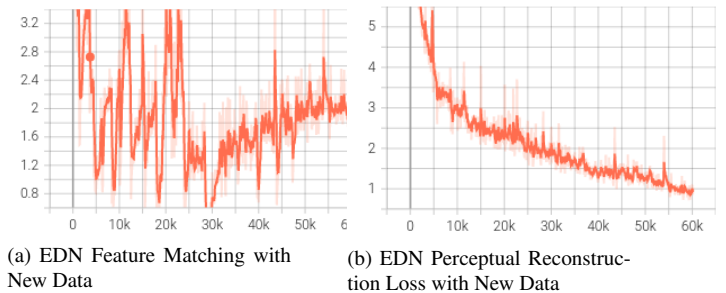

Figure 5

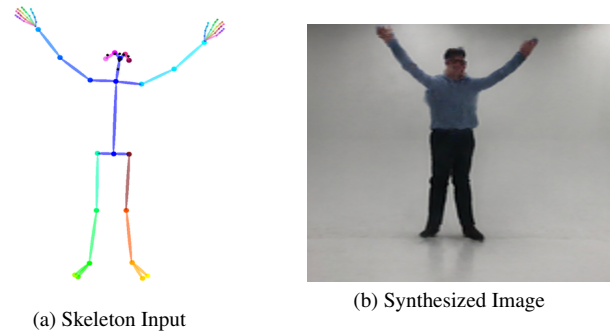

Figure 6

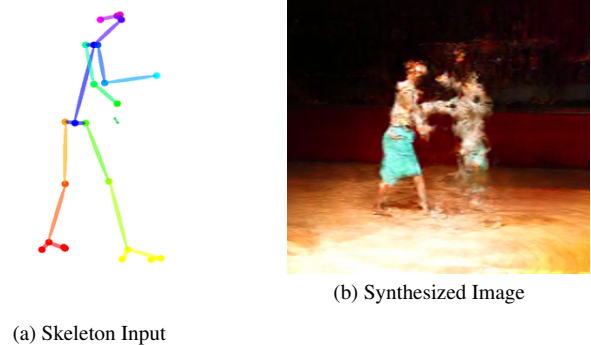

Figure 7