

# In the realm of hybrid Brain: Human Brain and AI

**Hoda Fares<sup>1</sup>, Margherita Ronchini<sup>1</sup>, Milad Zamani<sup>1</sup>, Hooman Farkhani<sup>1</sup>, and Farshad Moradi<sup>1</sup>**

<sup>1</sup>ICELab, IbrAIn center, Department of electrical and Computer Engineering, Aarhus University, Aarhus, Denmark

**\*Correspondence:**

Corresponding Authors: Farshad Moradi and Hoda Fares

Email: [moradi@ece.au.dk](mailto:moradi@ece.au.dk), [hfares@ece.au.dk](mailto:hfares@ece.au.dk)

**Keywords: Artificial intelligence (AI), Brain-computer interfaces (BCI), neuromorphic engineering, Neuroscience, Neural Interfaces, Neuroprostheses**

## Abstract

With the recent developments in neuroscience and engineering technology, it is now possible to record brain signals and decode it. In parallel, a growing number of stimulation methods are being utilized to modulate and influence brain activity. These advances opened the door for innovative neurotechnologies that directly interface with the human brain. Current brain-computer interface (BCI) technology is mainly focused on therapeutic outcomes, it already demonstrated its efficiency as assistive and rehabilitative technology for patients with severe motor impairments. For instance, it enables users to perform relatively simple motor tasks like moving a computer cursor or controlling a motorized wheelchair or prosthetic/robotic arm. In another flip, artificial intelligence (AI) and machine learning (ML) technologies have been used to understand the enormous multimodal neural data and to decode brain signals. Beyond this impressive progress, combining artificial intelligence (AI) with advanced brain-computer interfaces in the format of implantable neurotechnologies grant new possibilities for the diagnosis, prediction, and treatment of neurological and psychiatric disorders. In this context, we envision the development of closed-loop smart, low-power, and miniaturized neural interfaces that will use brain-inspired AI techniques with neuromorphic hardware to process the data from the brain. This will be referred to as Brain Inspired- Brain Computer interfaces/implants (BI-BCIs). Such neural interfaces would offer access to deeper brain regions and better understanding for brain's functions and working mechanism, which improves BCIs operative stability and system's efficiency. On one hand, brain inspired-AI algorithms represented by spiking neural networks (SNNs) would be used to interpret the multimodal neural signals in the BCI system. On the other hand -due to the ability of SNNs to capture rich dynamics of biological neurons and to represent and integrate different information dimensions such as time, frequency, and phase- it would be used to model and encode complex information processing in the brain and to provide feedback to the users. In this paper, we provide an overview of the different methods to interface with the brain, present future applications and discuss the merger of AI with BCI systems.

## 1 Neurotechnology: The future game changer

Neurodegenerative disorders are incurable and debilitating conditions caused by gradual damage or loss of the nervous system structure and function. They lead to cognitive, sensory, and motor dysfunction. Parkinson's Disease (PD), Epilepsy, Multiple Sclerosis (MS), Alzheimer, and Dementia are the most predominant neurodegenerative diseases. As the world's population ages and life expectancy increases, age-related neurodegenerative diseases are becoming more prevalent and the

risk of being affected by them is increasing dramatically. Parkinson’s Foundation estimates that around 1.2 million people in the USA will be living with Parkinson’s disease by 2030 [1]. They are responsible for the greatest economic burden and influence the lives of millions of people worldwide, for instance, in 2010, more than 179 million people in Europe were affected by brain disorders with an associated bill of around 800 billion euros [2]. According to the Global Burden of Disease Injuries, and Risk Factors Study (GBD) 2016, neurological disorders were reported as the top leading causes of disability in the globe with 11.6% Disability-adjusted life years (DALYs) (~276 million per year), and second leading cause of deaths after cardiovascular diseases with 16.5% of all deaths (~9 million) [3]. A general summary on the most common neurological disorders, their effects and economic burden is presented in Table 1. Currently, there is no effective therapeutics to cure such disorders, except for some traditional pharmaceutical drugs that could reduce the symptoms severity such dopaminergic treatment for PD and movement disorders, cholinesterase for cognitive disorders, anti-inflammatory and analgesic for neuronal infections and pain, antipsychotic for dementia, etc. [4], [5]. A large mass of research is focusing on establishing novel therapeutic tools and strategies by targeting the nervous system.

Neurotechnologies such as deep brain stimulation and optogenetics have emerged as new tools to study the brain and as alternatives for traditional pharmaceutical approaches for neurological diseases treatment [6], [7]. Their goal is to establish a direct communication between the nervous system and the electronic components (e.g., electrodes, computers, robotic arm, etc.) or wire up the human brain to machines. They either record brain signals then decode it into control commands or stimulate electrically or optically the brain to modulate its activity and responses [8], [9]. There have already been several neurotechnologies developed in the past few decades that have proven to be useful in both assistive and rehabilitative applications, including cochlear implants for restoring hearing [10], retinal implants for restoring vision [11], [12], and brain-computer interfaces (BCIs) that use brain activity for moving a computer cursor or controlling a motorized wheelchair /robotic arm [13], [14]. However, with the advances in neuroscience and engineering technologies, especially the development of Artificial intelligence (AI), machine learning, and other information science, neurotechnologies become more intelligent and more promising.

Nowadays, researchers consider neurotechnologies to be the next game-changers in terms of diagnosing, predicting, and treating neurological and psychiatric disorders. Even they have been applied in several studies, for example, to reduce tremors in Parkinson's disease and overcome movement stiffness [6], to suppress epileptic seizures, and to treat cognitive impairment [9], chronic pain, headaches, and depression obsessive-compulsive disorder (OCD)[15]. However, most of these technologies are still limited to laboratories and their performance need to improve so that it can be used in daily life. Moreover, developing a closed-loop system that connect the brain with the external world in real-time remains a major challenge.

**Table 1: Top leading neurodegenerative diseases based on world health organization (WHO) reports [3], [16], [17]**

Neurodegenerative Diseases	Facts and Symptoms	Percentages and economic Burden
<b>Dementia and Alzheimer’s disease</b>	<ul style="list-style-type: none"> <li>- Dementia causes symptoms that affect memory, thinking, and social abilities severely enough to interfere with a patient’s daily life.</li> <li>- Memory Loss, planning difficulties, mood changes, personality changes, Confusion about time and place.</li> </ul>	<ul style="list-style-type: none"> <li>- Over 50 million people worldwide were living with dementia in 2020 (will double every 20 years).</li> <li>- ~10 million new cases every year (one every 3 seconds).</li> <li>- 7<sup>th</sup> leading cause of death.</li> <li>- In 2018, it cost one trillion (it will be around two trillion by 2030).</li> </ul>
<b>Parkinson’s disease (PD)</b>	<ul style="list-style-type: none"> <li>- Rigidity, postural disturbance, rest tremor, slow movement, anosmia in early stages.</li> </ul>	<ul style="list-style-type: none"> <li>- 10 million patients affected globally (1.5x more likely men than women)</li> <li>- The prevalence ranges from 41 per 100,000 among people in their thirties to more than 1,900 per 100,000 among those who are over 80.</li> <li>- In 2016, it caused 3.2 million DALYs and 211.96 deaths.</li> </ul>

		<ul style="list-style-type: none"> <li>- In 2021, in the USA it costed US\$51.9 billion (double previous estimates).</li> </ul>
<b>Multiple sclerosis (MS)</b>	<ul style="list-style-type: none"> <li>- Multiple sclerosis is a disease with unpredictable symptoms that can also vary in intensity. Different symptoms can manifest during relapses or attacks.</li> <li>- Pain from spasticity, impaired ambulation, depression, cognitive impairment, ataxia, and tremor.</li> </ul>	<ul style="list-style-type: none"> <li>- ~around 2.8 million people worldwide registered</li> <li>- Women four times more likely to have MS than man</li> <li>- Mean costs of MS ~37100 annually per patient with moderate disease in EU.</li> </ul>
<b>Epilepsy</b>	<ul style="list-style-type: none"> <li>- Recurrent seizures, which are brief episodes of involuntary movement that may involve a part of the body or the entire body and are sometimes accompanied by loss of consciousness and control of bowel or bladder function.</li> </ul>	<ul style="list-style-type: none"> <li>- ~ 50 million people worldwide have epilepsy (most common neurological diseases globally).</li> <li>- Up to 70% of people living with epilepsy could be seizure-free if properly diagnosed and treated.</li> <li>- Premature death in people with epilepsy is up to three times higher than for the general population.</li> <li>- The estimated proportion of the general population with active epilepsy (i.e., continuing seizures or with the need for treatment) at a given time is between 4 and 10 per 1000 people.</li> </ul>

As the brain controls several processes of the human body through electrical signals, and that most of the neurological diseases are associated with changes in neural information flow, then why not starting by the brain by itself? Why not “overwriting” or correcting the wrong patterns and alleviating the symptoms of those disorders? Why not developing intelligent neural interfaces to communicate, repair or treat damaged brain regions and enhance human capabilities? In support of this, vast resources have been poured on projects to study, model and map the brain and its fundamental mechanism along with neurotechnology development. For instance, the BRAIN initiative (Brain Research through Advancing Innovative Neurotechnologies) launched in 2013 and supported by US government (around 6.6 billion dollars estimated budget until 2027) and Brain/MINDS (Brain Mapping by Integrated Neurotechnologies for Disease Studies) project launched in 2014 by Japan which involves mapping neural networks in the marmoset. Similarly, the HBP (Human Brain Project) by the European commission ((\$703 million) aims at creating the largest brain circuitry simulator. In Dec 2020, the HBP launched its EBRAINS platform, which grants access to data sets, digital tools for analysis and experiment conduction [18]. In addition, several developments have been done in the field of BCIs to communication and interact with brain. Different recording and stimulation techniques that vary in spatial and temporal resolution, are used for the acquisition of brain signals (e.g., electrophotography (EEG), electrocorticography (ECoG), functional magnetic resonance imaging (fMRI), etc.) and to modulate neural activities (e.g., deep brain stimulation (DBS), transcranial magnetic stimulus (TMS), transcranial focused ultrasound (tFUS), etc.) [19]. The rapid development of AI and machine learning technologies has enabled BCI systems to successfully use AI to interpret enormous multimodal neural data specially to decode brain signals.

In this paper, we would like to give an insight about the current state of applied research of neurotechnologies and the possible clinical application resulting from it. Moreover, we will address the merger of artificial intelligence (AI) with neural interfaces. The paper is organized as follows: section 2 presents a summary of state-of-art available neural interfaces with special focus on brain-computer interface systems and neural implants. Section 3 reviews the development of spiking neural networks and neuromorphic architectures. Section 4 discusses the use of SNNs in BCIs. Finally, our closing remarks and vision about merging brain-inspired computing with neural interfaces to achieve intelligent BCIs that would be the new generation to low-power, smart, and miniaturized therapeutic devices for a wide range of neurological and psychiatric disorders, will be sketched.

## 2 Neural Interfaces: The Brain Editors

### 2.1 Connecting Brain to Computers: BCIs History and outlook

BCI is a general term for any technology that directly communicates with the brain, either to extract information from it or to insert information into the brain through stimulation [8][9]. This terminology was first proposed by Vidal in 1970s, who did the first attempt to create a system that could translate electroencephalography (EEG) signals -non-invasive method that records neural activity from the scalp- into computer control signals [20]. Research applications of BCI technology have evolved substantially over the past two decades. Their development was boosted by the technological advancement of microelectrode and single neuron recordings technologies, both in rodents [21] and non-human primates [22], [23]. In the experiments carried out with these systems, animals learned to use their brain activity to control the movement of computer cursors or robotic arms to feed themselves [24], [25]. In a later stage, researchers used similar electrode arrays and implanted it in the parietal or motor cortex of patients with severe paralysis and tetraplegia, they were trained to perform skilled motor movements with a robotic arm, for example bringing a cup to their mouth to drink or eat a piece of chocolate [26], [27]. BCIs could be used to restore (e.g., unlock patients with locked-in syndrome), replace (e.g., BCI-controlled neuroprosthesis), enhance (e.g., user experience enhancement through computer games), supplement (e.g., VR virtual reality and AR augmented reality glasses), improve (e.g., lower limb rehabilitation after stroke), and research tool (e.g., coding, and decoding brain activity with real-time feedback) [28]. BCIs can record and decode cortical activity while performing or imagining performing a task. These neural signals of the intended movement can be transformed into visual [26], [29], auditory [30]–[32], or haptic feedback [33] of the movement [19]. Figure: 1 illustrates the generalized schematic for BCIs and common state-of-art (SoA) applications.

BCIs can be classified based on the way they use or interact with the brain. As the name implies, active BCIs directly involve the user's intention-induced brain activity [34] whereas passive BCIs decode unconscious psychological states [35] are BCI systems based on intentionally motor imagery (MI) and visually evoked P300 produced by external stimuli (e.g., visual, auditory, or somatosensory stimuli) [19], [36]. BCIs that allow users to spell a word, move a cursor, and control a robotic arm or wheelchair, can be considered as active BCI systems [19], [37], [38]. In contrast, monitoring driver's drowsiness to prevent accidents is an example of passive BCI [39]. Also, passive BCIs have been used to monitor users' cognitive states as intentions, emotional state, and situational interpretations [30], [35].

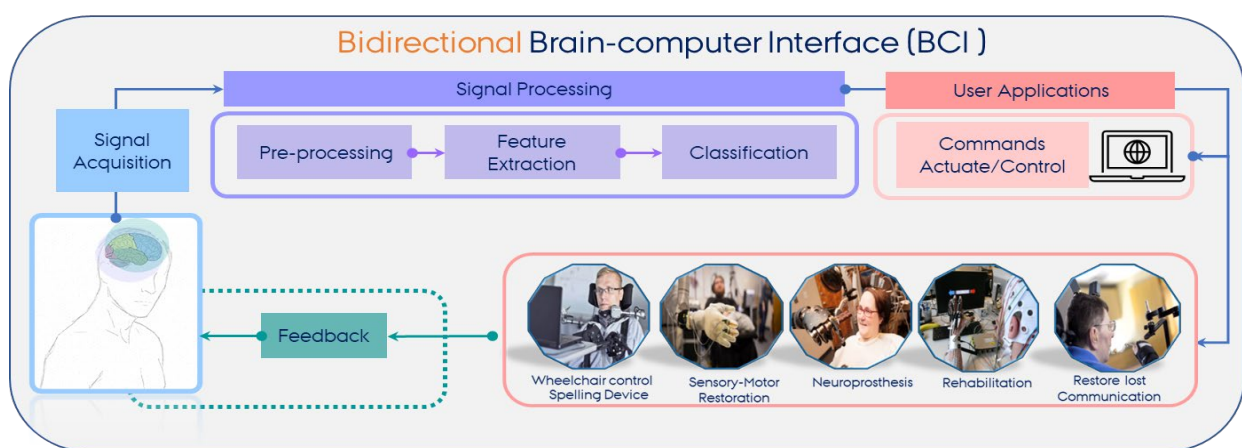

**Figure 1 Generalized schematic for Bidirectional brain computer Interface.** The produced Brain signals are recorded from the scalp, cortical surface or from within the brain by electrodes. These signals are processed to extract the correlated features with user's intentions. The extracted features are translated into commands to control / actuate a wide range of applications. (Could be used to control devices, artificial limbs, or obtain knowledge of user's intentions). Then, sensory information is fed back to the user either invasively or non-invasively

## 2.2 From brain to external devices: Recording and decoding

Recording brain activity and having access to the ongoing thought process of animals and humans is usually done by either **invasive** or **non-invasive** BCIs. Non-invasive methods comprise **electroencephalography** (EEG) [31], **magnetoencephalography** (MEG) [14], **functional near-infrared spectroscopy** (fNIRS) [38], and **functional magnetic resonance imaging** (fMRI)[40]. Using these techniques, metabolic and electrophysiological brain signals can be collected with different temporal and spatial resolutions. Signals related to electrophysiology such as EEG provide high temporal resolution and demonstrate relatively low rate of information transfer, yet it can be augmented by sensory stimuli such as steady-state visually evoked potential (SSVEP). While metabolic signals collected by fMRI provides good spatial resolution and is more sensitive to subcortical regions than electrophysiological signals, however, its main limitation is that users need to be inside a scanner to be able to measure their brain activity. Researchers were able to reconstruct the perceived visual images, just by analyzing fMRI signals collected from visual cortex [41]. With similar approaches, it has been demonstrated that patients in a vegetative or minimally conscious state understand and respond to instructions [42], [43].

Alternatively, invasive BCIs such as **electrocorticography** (ECoG) [44][45], [46]and **intracortical electrodes** (IR) [47], provide higher signal-noise ratio and better localization of brain activity as they directly interface with brain. During the last years, a notable progress has been made with invasive BCIs that need brain surgery. A major application of invasive BCIs is assisting paralyzed people, for example by implanting subdural electrodes over the cortex [48]. The latter electrodes provide stable readings yet show relatively low-bandwidth readout than the local EEG. Higher bandwidths could be achieved by implanting electrode arrays deeper into the cortex (e.g., motor and parietal cortices) to record neuronal spiking activity [25], [49]. The recorded spiking activity in turn will be used to decode [50]user's intention to move hand in certain direction or control a robotic arm for skilled movements. For instance, Bouton et al. were able to restore wrist and hand control to a patient and allowed him to perform his daily life tasks [51]. Also, Lajoie, G., et al. used bidirectional BCI to artificially induce task-related neuroplasticity [52]. In summary, such BCI methods mainly target brain regions that represent low-level and high-level motor commands to restore motor control in patients. In addition, these methods could be used to read the neural codes associated with perceptions [50], attention [53], and decisions [54].

Recently, invasive BCIs enabled researchers to decode the thoughts of a person from the activity of their "concept cells", which were discovered for the first time in the temporal lobe of patients implanted with electrodes to identify brain regions responsible for intractable epilepsy [55]. They also found out that these cells represent abstract concepts about specific places and people, and they get activated when the person thinks, sees, or retrieves memories about such concepts [56], [57].

Researchers would likely be able to monitor thoughts with greater clarity if large numbers of concept neurons were recorded at one time, given that this study recorded only a single cell or a few neurons at one time. In fact, extracting complex intentions could revolutionize communication BCIs used to decode the intentions of locked-in syndrome patients (ALS) [13], [48] [58].

Meanwhile, electrode arrays can record simultaneously from hundreds of neurons in humans and monkeys and the high-density probes have made it possible even to monitor a greater number of neurons [59]. However, the advances in optical cellular imaging have shifted this numbers by several orders of magnitude. The electrical activity of each neuron expressing genetically encoded calcium indicators (GECIs) can be optically measured, for example Kim et al. used such technique to optically record the activity of up to one million neurons in a single rodent [60]. In the future, such methods

might make it possible to record millions of neurons in humans. Table 2 and 3 summarize the most relevant non-invasive and invasive recording techniques respectively and their BCI applicability.

**Table 2: Non-Invasive Recording Technologies and BCIs applications**

Techniques Definition	Type	Resolution		Portable	Application	Publication
		Temporal	Spatial			
<b>EEG</b> It is a method to record the electrical activity of the brain with electrodes placed on the scalp. It represents the macroscopic activity of the surface layer of the brain underneath.	Electrical	~ 0.05 s	~10mm	Yes	Epilepsy	[61]
					Motor learning & plasticity induction	[62]
					Multimodal BCI for psychological prediction (attention, motivation, memory load, fatigue)	[63], [64], [65]
					Motor recovery after stroke	[66]
					Transfer learning (Inter-subject BCI)	[67]
					Motor rehabilitation (Parkinson's disease)	[68]
<b>MEG</b> It is a neuroimaging method that uses SQUID to measure weak magnetic fields outside the head. It reflects the magnetic changes arising from cortical neural activity.	Magnetic	~ 0.05 s	~ 5 mm	No	Multimodal BCI for motor rehabilitation	[69]
					Assistive technology (BMI for paralysis)	[70]
					MEG-based brain-computer interface (BCI)	[71]
					Real time control of neuroprosthetic hand	[72]
<b>fMRI</b> It uses magnetic resonance imaging to detect local brain activity by measuring the changes in the BOLD signal.	Metabolic	~ 1 s	~ 1 mm	No	Multimodal BCI for Psychological prediction (attention, motivation, memory load, fatigue)	[63], [73]
					Brain activity Regulation	[29]
					Neuroplasticity Rehabilitation of attention deficit	[74]
<b>fNIRS</b> It measures the concentration variation of oxygenated and deoxygenated hemoglobin respectively HbO and HbR in brain tissue depending on changes of the exiting photon intensity and incident -photon intensity, then characterizes the local neural activity	Metabolic	~ 1 s	~ 5 mm	No	Multimodal BCI for Gait rehabilitation	[75]
					Robotic control	[76]
					Motor Rehabilitation	[77]
					Intention detection	[78]
<b>MRI</b> It is an imaging technique that combines strong magnetic fields, electrical gradients, and radio waves to measure the biological tissue composition and derive its structure.	Hybrid (magnetic + electrical+ radio waves)	~ 1 s	~ 1 mm	No	Locked In syndrome (Somatosensory Rehabilitation in stroke and phantom limb pain)	[79]
					Neurofeedback	[80]

*Abbreviations: EEG (Electroencephalography), MEG (Magnetoencephalography), fMRI (Functional Magnetic Resonance Imaging), fNIRS (Functional near-infrared spectroscopy), MRI (Magnetic Resonance Imaging), BMI (Brain machine interface), BOLD (blood oxygenation level dependent), SQUID (superconducting quantum interference device)*

**Table 3: Invasive Recording Technologies and BCIs applications**

Techniques Definition	Type	Resolution		Portable	Application	Publication
		Temporal	Spatial			
<b>ECoG</b> It uses flexible subdural grid or strip electrodes that directly	Electrical	~ 0.003 s	~ 1mm	Yes	Assistive technology neuroprosthetic control	[45]
						[81]

interface with the brain surface to measure cortical activity. It exhibits higher spatio-temporal resolution than EEG, larger bandwidth, and excellent signal-to-noise ratio (SNRs)				(subdural ECoG ~1.25mm) (epidural ECoG ~1.4 mm)		Motor learning and rehabilitation [46] Intracranial BCI for severely motor-impaired patients [48], [82] Neural decoding and encoding (speech synthesis, text translation) [83] [84]
<b>IRI</b> (Intracortical recording interfaces) are critical components of BCIs and consist of arrays of penetrating electrodes that are implanted into the motor cortex of the brain.	Electrical	~ 0.003 s	LFP ~ 0.5mm MUA ~ 0.1 mm SUA ~ 0.05 mm)	Yes		BCI for ALS, Diagnostics, Therapeutic Treatments [48] [85] Neural decoding and stimulation, robotic prosthetics control [86] [87] Assistive technologies and clinical BCI [47] [27] Restoration of mobility and communication, cursor control, epilepsy monitoring [26], [47]
<b>PET</b> is a minimally invasive imaging procedure. It is a combination of nuclear medicine and biochemical analysis. PET studies evaluate the metabolism of a particular organ or tissue, so that information about the physiology (functionality) and anatomy (structure) of the organ or tissue is evaluated, as well as its biochemical properties.	Metabolic	~ 1-2 min	~ 4 mm	No		Limit potential Diagnostic tools of neurological disorders such as dementia, epilepsy [88] Evaluate brain state after trauma Cancer spread detection
<b>Stentrodes</b>	Catheter angiography guided implantation	-	-	Yes		Minimally invasive BCIs (ongoing Human trails) Motor neuroprosthesis [89], [90]
<b>Neural Dusts</b>	-	-	-			Optogenetics (biomedical/ implants) Brain [91], [92] [93], [94] Parkinson (STARDUST) [95]–[97]
<b>Neural pixels</b>	High density probe for stable long-term brain recording					Recording thousands of individual neurons in living brain (Freely moving animals) [98]
<b>Neural lace</b>						

*Abbreviations: ECoG (electrocorticography), PET (Positron emission tomography), IRI (Intracortical recording interfaces), iMEA, (intracortical microelectrode array), ALS (Amyotrophic lateral sclerosis)*

Interpreting the activity of such enormous number of neurons could be problematic. Neural decoding techniques aim to extract information from neural activity to reconstruct the event or stimulus that led to it or to predict the action that will be evoked by it. Typically, a decoder is made of three main compartments: signal processing, feature extraction, and pattern classification as shown in Figure 1. The primary goal of signal processing is to remove noise from the recorded signals and highlight useful information. Feature extraction is used to recognize the most significant features based on subject's intention. Then, it is followed by pattern classification, which determines the different classes of user's intentions [99]. AI and ML methods have been heavily used in brain signal decoding and classification [100], [101]. Despite the success of traditional linear decoding approaches, recent

advances in machine learning have led to even more effective neural network decoding approaches [102]. For example, Deep Neural Networks (DNNs) have been used to interpret activity patterns elicited by visual stimuli and predict it with a remarkable precision around 90% [50]. Mostly, lower layers in DNNs represent simple features while higher layers represent conceptual information which in turn will be mapped to different brain regions [103]. Therefore, the development of novel technologies for recording and decoding neural activity could enable researchers to read the human brain and expose subject's intentions, preferences, thoughts, and emotions. Nevertheless, this raises issues of privacy, security, and mental ownership as well.

### 2.3 From external device to the Brain: Encoding and Stimulating

Several technologies have been developed to influence the brain activity. Modulating neural activity could be done either by neurofeedback (i.e., with no direct intervention with the brain) or brain stimulation (i.e., by applying energy directly to brain regions). Non-invasive methods such as **transcranial magnetic stimulation (TMS)** [104], **transcranial direct current stimulation (tDCS)** [105], **transcranial electrical stimulus (TES)** [105], **focused ultrasound stimulation (FUS)** [86], and **transcranial focused ultrasound (tFUS)** [106], as well, invasive methods such as DBS [7], surface cortical and intracortical stimulation, all belong to direct brain stimulation technologies. Non-invasive methods have limited spatial resolution and their effects are still not clarified. Here, our focus is centered on invasive neural technologies.

First attempts to interface with the peripheral nervous system had been done with cochlear implants, which electrically stimulate the inner ear and meanwhile became the conventional treatment for deafness [10]. Restoring vision in patients with damaged retina also was achieved, either by electrical stimulation with retinal chips [107] or by chemical or optogenetic stimulation that re-establish retina's light sensitivity [12] [108]. For example, Argus I (16 channel electrode) and Argus II (60 channel electrode) retinal prosthesis system developed by Second sight, it is made of an embedded part inside the eye's retina and an external pair of glasses that has a forward-facing camera [11], [109]. Further progress has been done with upper limb prosthesis to equip it with artificial sense of touch by electrically stimulating the residual nerves in the arm [110], [111].

Researchers have a longstanding goal to interact directly with the brain and impose certain activity patterns onto it. For instance, spinal cord implants allow patients to relieve chronic pain by sending low level electrical impulses directly into the spinal cord [112], [113]. Scientists implanted stimulation electrodes in the visual cortex to activate the neurons nearby (few tens of micrometers around the electrode) then evoke visual percepts in the brain. Such visual cortical prosthesis uses a camera mounted on a pair of glasses to capture visual information. The information be processed by a BCI system and translated into stimulation patterns that delivered into cortex through microelectrodes. Each stimulation electrode evokes a phosphene (i.e., the percept of light) to later build a visual image (pixel by pixel). Stimulating higher cortical areas formulate more detailed percepts like as shapes of faces [114] and spatial layout of scenes [115]. Moreover, discriminable tactile information has been elicited by stimulating the somatosensory cortex of non-human primates [110], [116]. Yet, the main challenge still is the need of detailed knowledge of how complex thoughts are encoded in brain activity as well as the technical capability to evoke activity patterns will be required to directly communicate information to higher order cortices, such as the parietal and temporal cortex.

Treating Parkinson's disease with deep brain stimulation (DBS) has demonstrated the therapeutic potential of stimulation techniques in treating neurological disorders [6]. In a similar vein, DBS has been tested for treating psychiatric disorders including depression and obsessive-compulsive disorder



(OCD) [6], [117]. Nowadays, the electrodes used for DSB exhibit large surface areas which make the stimulation patterns relatively simple, however, with further technological developments their precision maybe augmented which in turn boost their therapeutic benefits while reducing risks. Alternatively, using optogenetic techniques could shift the usage of stimulation techniques specifically through activating certain subsets of neurons [118], [119]. The current used tools for optogenetic stimulation (i.e., two -photon microscopes) are bulky and impractical for clinical use. Hence, researchers worked on developing wearable single-photon microscopes that might increase the precision, quality, and bandwidth of these optogenetic stimulation methods thus increase its effectiveness as a therapeutic tool in the future. Table 4 depicts the developed brain stimulation technologies and their BCI applicability.

Disregarding its benefits, one drawback for stimulating the brain is the activation of multiple brain structures responsible for to control behavior or emotional state[120] . A recent study shows that optogenetic stimulation could steer complex behaviors such as attacking a prey [121], eating, drinking and sexual behavior in rodents and other animals [122]. Also, functions like memory and attention can be influenced [123]. For instance, the stimulation of parietal cortex or frontal eye field modulates visuo-spatial attention [124], [125], likewise electrical stimulation of the temporal lobes induces vivid recollection of memories of a patient's past [126]. Several BCI applications instead target behavior change to avoid certain diseases, for example Lipsman et al. used for the treatment of refractory anorexia nervosa [7], [127]. Researchers could also suppress or reinforce certain behavior by inhibiting or activating set of neurons (e.g., activation of dopamine neurons in the ventral tegmental, activation of circuits that mediate aversion in the lateral habenula) [128] [129].

BCI applications that incorporate both recoding and stimulation systems could be extremely influential, as it would enable real-time and co-adaptive feedback between the brain and the external devices (i.e., the encoding stimulation could be conditioned on the current state of the brain). Such approach has been used to increase the control of neuroprosthesis by reading neural activity from the primary motor cortex and translating it to movement commands then sending haptic feedback to somatosensory cortex by micro-stimulation [130]. This stimulation improved control's precision and provide feedback about touched objects. Figure 2 presents the SoA of existing neural interfaces for stimulation and recording.

Adding to what presented in the previous sections, neurotechnology research has significantly become an interesting attraction for industry in the past decade (e.g., © Neuralink [131], ©Paradromics [132], ©Synchron [133], ©Blackrock Neurotech [134], ©Neurable [135], ©Thync [136], ©Medtronic [137], ©kernel [138], etc.). For instance, ©NeuroPace developed a brain-responsive neurostimulator called RNS System for treating adults with drug-resistant focal epilepsy, it uses feature thresholding over 4 channels to detect seizures [139], [140] . Also, ©Medtronic developed Percept PC DBS system by that implements 4 Channels [141] and ©Neuralink 1024 channel closed-loop Brain Machine Interface (BMI) implantable chip which integrates neural recoding, spike detection circuitry while using external devices for motor intention decoding [142].

## **2.4 Cutting-edge Neurosurgical Innovations in BCIs**

Neurophysiological discoveries, device innovation, and integration of technology will be needed for the development of effective BCIs in the future. In this paragraph, we review some of the cutting-edge neurosurgical innovations in the BCI research field. In [143], a systematic review on the current state-of-art of ECoG-based BCIs for decoding movements, vision and speech and their clinical implementation in patients with ALS and with tetraplegia is presented. Alternatively, Soldozy et al. review the use of minimally invasive neurovascular approaches (stent-electrodes) in BMIs [144].

Gogia et al. demonstrated a new neurophysiological application of BCI application and showed that movement related electrical movements in the range 30 and 300 Hz can be measured from human amygdala. They used stereo-electroencephalography (SEEG) electrodes implanted for epilepsy monitoring [145]. While Price et al. illustrate how a novel neurochemical sensor coupled with electrodes have produced a new family of closed-loop neurostimulation devices [146]. In other hand, Lehman et al. show how the combination of tractography and MRI techniques can optimize electrode implantation [147]. BCIs are expanding to be a part of psychiatric therapy to treat depression, obsessive compulsive disorder, and Tourette syndrome. For instance, Wang et al. piloted a study and used deep brain stimulation of the habenula for intractable schizophrenia and it shows its efficiency on two patients [148]. It was also used for controlling animals' movements, Baek et al. developed an operative protocol of fully implantable brain stimulation system in pigeons, they were able to deviate pigeons usual flight after stimulating the ventral part of the nucleus intercollicular and formation reticular mesencephalic structures [149]. Koh et al. implanted electrodes in the nigrostriatal pathways of rats and by electrical stimulation they were able to direct them through a maze thus influencing their choice of direction at intersections [150].

## 2.5 Closed-loop intelligent Brain computer interaction (BCI)

Classical BCIs are one-way feedforward systems that mostly used in control and communication applications [13]. These BCIs generally focus on applying different types of electroencephalograms signals such as, **slow cortical potentials (SCP)** [151], **sensorimotor rhythms (SMRs)** [152], **P300 event-related potentials (ERPs)**, and **steady-state visual evoked potentials (SSVEPs)** [153], to realize brain-computer communication and they feedback the results on a computer screen (as presented in Table 5 which summarizes the different EEG-based open-loop BCIs and their applications). However, when this feedback is used to alter the neural or behavioral activities as well as the external devices, they become closed-loop brain computer interaction systems. This system is based on closed-loop control system with a brain-in-the-loop and it combines both decoding and encoding pathways to form a bidirectional BCI. Hence, as illustrated in Figure 3-left, there are two complementary routes: from the brain to the device and from the device to the brain. Bidirectional BCIs usually aim to change brain's state to augment human performance (e.g., modulation of brain activity for treating neurological disorders or boost mental capacity of healthy subjects).

Besides closed-loop neuroprostheses that bidirectionally interact with the brain, closed-loop DSB is another example of bidirectional BCI systems, where stimulation relies on simultaneous monitoring of brain activity. In Parkinson patients, the recorded oscillations in the local field potential (LFP) of the subthalamic nucleus provide real-time information about their clinical state, this in turn will be utilized to control the electrical stimulation settings and limit its application to specific time slots when it is needed. Limiting the application time expands the battery life and decreases the occurrence of potential adverse effects. These oscillations might be used in future DBS applications as a trigger signal for stimulation. Similarly, closed-loop brain stimulation has been used to detect early epileptic seizures then interrupt them by electrically stimulating the anterior thalamus or deep cerebellum nuclei before the seizures progress [154]. Lately, electrical stimulation was applied to the temporal cortex to improve memory encoding in users exhibiting weak memory [123]. Based on what was priorly discussed, to realize robust and effective closed-loop brain computer interfaces, it is necessary to have three key elements: neuromodulation, real-time co-adaptive interaction, and close-loop construction, so the brain adapts to external stimulus and continuously optimizes the task execution, and the decoders/actuators learn to tailor their responses accordingly with neural activity change and user's intentions as illustrated in Figure 3-right. However, there are still several problems that need

to be resolved, such as implanted electrodes longevity, electrical stimulation artifacts, electrochemical safety of electrode tissue interface, etc.

With the rapid of BCI and AI and machine learning fields, the scientists start promoting for a mutual collaboration between them. Researcher meanwhile are working on coupling BCIs with AI and machine learning techniques. On one side, AI will be used for interpreting the vast multimodal recorded neural signals in BCIs, on the other side, AI-based intelligent devices will encode and feedback information to the users. Scientists believe it would improve the performance and expand the applicability of BCI systems. Moreover, they postulate that AI can complement human cognitive abilities, which in turn will enable the development of hybrid intelligence driven by directly interfacing with brain. Figure 3-right shows the closed-loop intelligent BCI system. Disregarding whether these methods are used to record from brain or stimulate it, their general goal is to help patients. However, the idea of augmenting human cognition is still merely an abstract and fictional idea. We will discuss later the potentials and downsides of using brain computer interfaces for enhancing human cognition

**Table 4: Stimulation Techniques and BCIs**

Techniques Definition	Invasiveness	Context of Application	Publication
<b>DBS</b> It is surgical procedure that chronically implant electrodes into the brain to allow stimulation of deep structure.	Invasive	Chronic pain treatments	[155]
		Treatment of resistant movement and neuropsychiatric disorders	[156]
		Parkinson disease	[6]
		Obsessive-compulsive disorder (OCD)	[117]
		Treatment of psychiatric disorders (depression)	[157] [156]
<b>FUS</b> Non-Invasive neuromodulation method that focuses on a beam of high-frequency soundwaves to synchronize at specific location of the brain to influence the neuronal activity.	non-Invasive	Modulation of brain and behavior	[158]
		Brain modulation (Human somatosensory cortex activity modulation)	[106] [147]
<b>OS</b> It is a method used to control cellular activity through light. It involves genetically modified neurons to express light-sensitive ion channels or pumps which can be opened or closed with light of specific wavelengths.[102]		Choice biasing in primates	[124]
		Restoration of light sensitivity of the retina	[12] [108]
		Behavioral control (e.g., pursuit of prey)	[121]
		Optogenetics, electrophysiology and pharmacology with an ultrasonically powered DUST for Parkinson's disease	[93], [94]
<b>tDCS</b> a non-invasive brain stimulation method in which a low constant direct current is applied to electrodes on the skull to elicit current flow in the underlying brain tissue.	Non-invasive	Behavior modulation, neuroplasticity	[105], [159], [160]
		Hyper interaction (Brain to brain interface)	[161] [162]
<b>TMS</b> A non-invasive brain stimulation technique that uses a changing magnetic field outside the skull to generate a localized electric current in the brain via electromagnetic induction.	Non-invasive	Cognitive and clinical neuroscience	[104], [163], [164]

*Abbreviations: FES (functional electrical stimulation); TMS (transcranial magnetic stimulation), DBS (deep brain stimulation), FUS (focused ultrasound stimulation), OS (optogenetic stimulation), tDCS (transcranial direct current stimulation)*

**Table 5: EEG- based Recording Technologies and BCIs applications**

EEG- based BCIs Definition	Modulation	Application		Publication
<b>P300 ERP-based BCI</b> <b>P300- event related potential based BCI: Based on P300 event-related potential which is a positive deviation occurs at approximately 300 ms after a rare and relevant stimulus happens. P300 signals could have higher amplitudes when a specific stimulus acquires higher attention.</b>	P300 signals could have higher amplitudes when a specific stimulus acquires higher attention	vibrotactile stimulation	Spinal cord injury rehabilitation	[33] [165]
		Driving scenario in virtual reality	Drowsiness detection	[39], [166]
		Amyotrophic lateral sclerosis (ALS)	Visual P300 speller, Brain painting	[167] [168]
		Cerebral palsy	Cognitive assessment	[169]
		Brain fingerprinting	Lie Detection	[170]
		Assistive technology	Wheelchair control	[171]
<b>SMR-based BCI</b> <b>Sensorimotor rhythms Based BCI: Based on mu (8-12Hz) and Beta (18-26Hz) oscillations in EEG signals recorded over the sensorimotor cortex.</b>	The amplitude of SMRs could be modulated using mental strategy of motor imagery	Motor learning Brain plasticity	Motor Rehabilitation Lower limb rehabilitation	[31] [172]
		Robotics and Assistive technology (ALS, Stroke)	Hand prosthesis control	[37], [38] [173]
		Assistive technology	Wheelchair navigation	[152]
		Motor training with proprioceptive feedback	Upper limb rehabilitation	[174]
		Plasticity Induction	Stroke rehabilitation	[62]
		Neuroanatomical predictor	Motor rehabilitation	[172]
<b>SCP- based BCI</b> <b>Slow-cortical potential-based BCI: Based on very slow variation of the cortical activity.</b>	Positive SCPs correlate with mental inhibition and relaxation, while negative SCPs correlate with mental preparation.		Biofeedback in epilepsy	[151]
<b>SSVEPs-Based BCI</b> <b>Steady-state visually evoked Potential-based BCI: Based on periodic brain responses induced by repeated visual stimulation.</b>	SSVEPs appear as an increase in brain activity at the stimulation frequency and its harmonics	Dry and non-contact sensors	Typical BCI applications	[153] [175]
		Motor plasticity	Upper extremity Rehabilitation combined with FES	[176]
		Assistive technology	Video Games, Text speller	[177] [178]
<b>VEP</b> <b>Visual evoked potential</b>			Epilepsy, Hybrid and multimodal BCI applications	[30] [179]
<i>Abbreviations: P300 (an event-related potential), SSVEP (steady-state visual evoked potential), VEP (visual evoked potential), SMR (sensorimotor rhythms), SCP (slow-cortical potential),</i>				

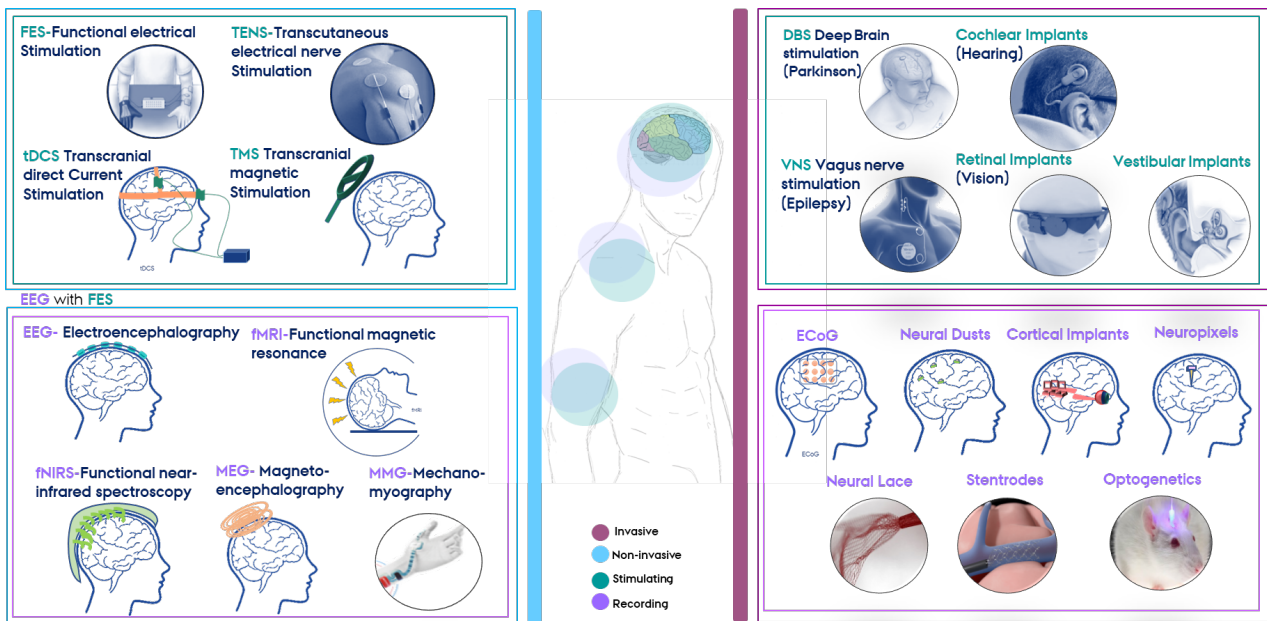

**Figure 2: Neural stimulation and recording interfaces Invasive vs. Non-invasive.** On the left in blue represents the non-invasive interfaces, while the right in red represents the invasive interfaces. In addition, upper right and left in green represent the stimulation interfaces, and the lower right and left in purple represent the recording interfaces.

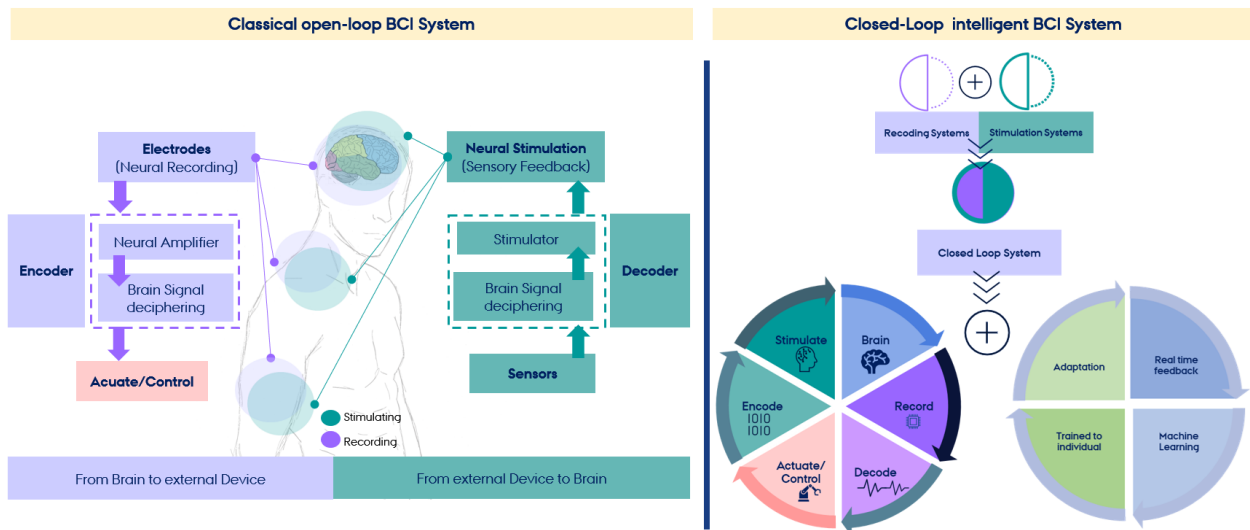

**Figure 3 Bidirectional closed loop brain interface:** Left: Classical open-loop BCI systems: Two complementary routes: in purple the controlled actuator (from brain to device) and in green the modulated brain state (from device to brain), Right: Closed-loop intelligent BCI system: the recording

### 3 Brain-inspired Intelligence: Merging Neuroscience with AI

#### 3.1 Neuromorphic computing

With the rapid growth of AI and development of neural networks, computers nowadays display outstanding abilities in multiple cognitive tasks. For instance, the ability of AlphaGo to overcome human players at the strategic boardgame Go [180]. Though such performance is outstanding, the key question is still how to reduce the computational cost of these algorithms and how to get brain-like efficiency? The human brain is one the most fascinating organs. It has a remarkable information

storage and processing system with impressive computation-per-volume efficiency. The raw computational power of the human brain ranges between  $10^{13}$  to  $10^{16}$  operations/sec [181], [182]. It performs diverse operations such as recognition, reasoning, control movement with a power budget of nearly 20 W (like a lightbulb) [183] and power density of  $1.1-1.8 \times 10^4$  W/m<sup>3</sup> at an operating temperature of 37 °C [182]. In contrast, a computer performing a classification between one thousand kinds of objects requires around 250W [183]. Neurons and synapses constitute the fundamental computational units and storage of the human brain [184]. Brain neural networks are formed by billions of neurons ( $\sim 9 \times 10^9$  neurons) interconnected with trillions of synapses ( $\sim 3 \times 10^{14}$  synapses). Neurons are responsible for transferring information through discrete action potentials or 'spikes', while synapses are the intrinsic elements for long-term and short-term memory storage and deletion.

Synapses play a crucial role in temporal information processing at a spiking rate of around  $\sim 5 \times 10^{15}$  spikes/sec, allowing the human to process data at rate  $\sim 6 \times 10^{16}$  bits/sec [181], [182]. Moreover, they are the key factors for brain plasticity and provide the basis for cognition formation. Apart from neurons and synapses, studies have also revealed that several elements such as dendritic trees, axons, proteins, and neural microtubules contribute to the brain storage and computation capabilities [185]. Based on the discovery that dendrites generate 10 times more spikes than neurons and that they are hybrids that could process both analog and digital signals, the estimated human brain computational capacity rises 10 times higher than previously thought (i.e., from  $1.48 \times 10^{11}$  bits/sec to  $3.2 \times 10^{29}$  bits/sec) [181], [182], [185]. These intertwined networks of neurons and synapses along with the temporal spiking processing enable the fast and efficient transfer of information between the brain's various areas.

State-of-the-art artificial intelligence is intrinsically based on neural networks, which are inspired by the brain's hierarchical structure and neuro-synaptic architecture. For example, deep convolutional neural networks (DNNs) are multilayered and utilize synaptic storage and neuronal nonlinearity to learn representative features about the data. Indeed, deep learning networks in core are hierarchical structures composed of multiple layers or transformations that represent variable features within input data. These neural networks are powered by hardware computing systems, that primarily depend on silicon transistors. Billions of transistors can be integrated on a single silicon chip for enormous computing platforms. Several silicon-based computing platforms (e.g., graphics processing units (GPUs) and CPU (central processing units) based cloud servers) are organized in a similar fashion to brain's hierarchy to facilitate data exchange. Such platforms have been a key enabler in the current machine learning revolution. Today's deep neural networks are trained on powerful cloud servers, yielding incredible accuracy although incurring huge energy consumption. For instance, the deployment of deep network on a smart glass embedded processor would drain its battery (2.1 Wh) within 25 minutes [186]. It may be possible to enable energy-efficient machine intelligence by designing full-custom hardware that resembles biological brains. Nevertheless, obtaining great connectivity in neuronal networks and replicating time-dependent plasticity of synapses are the biggest challenges in mimicking the brain activity.

In 1980s, neuromorphic computing was invented to mimic the human brain functionality, by exploiting the similarity between ionic transport across the neuron membrane and carrier diffusion in the transistor channel. With time, neuromorphic computing progressed but preserved some unique characteristics, e.g., the event-driven nature of information representation [187]. Currently, researchers are exploring the potential and the downsides of using spike-driven computations to promote scalable, energy efficient spiking neural networks (SNNs). In this regard, neuromorphic computing field could be described as synergetic domain that focuses on both hardware and software tools to enable spike-based artificial intelligence. It has become an appealing paradigm to overcome

the von-Neumann bottleneck and accelerate computing efficiency [188]. Brain-inspired computing systems and conventional digital (von-Neumann) computing architectures present few key contrasting characteristics include: (1) Neuromorphic computing systems (NCSs) exhibit highly parallel operation; thus, neurons and synapses operate simultaneously, even though the performed computations by neurons and synapses are still simple in comparison with parallelized von Neumann systems [188]. (2) Both the processing unit (i.e., neurons) and memory (i.e., synapses) are co-located on the same hardware unit which reduce the computational cost and maximize the throughput. (3) NCSs are inherently scalable. In other words, adding more neuromorphic chips could increase the number of neurons and synapses implemented. Several neuromorphic chips can also be combined and treated as a single neuromorphic implementation, such as in SpiNNaker [189], [190] and Loihi [191]. (4) NCSs display stochasticity to insure the inclusion of noise. (5) Moreover, NCSs use event-driven computations (i.e., it computes only when the data are available), which allows them to be more attractive for implementation and usage, also they often operate in lower orders of magnitude power wise than conventional systems [192]. Table 6: presents a short comparison between Von-Neuman architecture and neuromorphic ones.

**Table 6: Fundamental differences between conventional architecture and neuromorphic architecture**

	<b>Conventional architecture</b>	<b>Neuromorphic architecture</b>
<b>Organization</b>	Separated Computation and Memory units	Collocated processing and memory
<b>Operation</b>	Sequential processing	Parallel processing
<b>Timing</b>	Synchronous (clock-driven)	Asynchronous (event- driven)
<b>Communication</b>	Binary	Spikes
<b>Programming</b>	Digital (code with binary instructions)	Spiking neural network (SNN)

### 3.2 Hardware Implementation: CMOS Neuromorphic chips

Neuromorphic computing systems are innate platforms for today’s AI and machine learning applications as they inherently operate at extremely low-power and implement neural network computation style. Both industry and academic researchers have been keenly interested in developing and implementing neuromorphic systems. Some industrial neuromorphic chips including IBM’s TrueNorth [193] and Intel’s Loihi [191]. Academia wise, there are many works aiming to build large-scale neuromorphic chips, for instance, BrainScales [194] [195], SpiNNaker [189], [190] were realized as a part of the European Union Human Brain project for neuroscience simulations, Stanford University’s NeuroGrid [196], IFAT [197] and DYNAPs [198]. These chips have their own specific end- to end software toolchains and applications. Several tasks for instance keyword spotting, medical image analysis and object detection have been successfully applied on existing platform like Intel’s Loihi and IBM’s TrueNorth [199] [200]. Alternatively, there is research emerging to create general-purpose neuromorphic platforms that connect hardware and software frameworks for wider classes applications [201]. Tianjic chip is a hybrid neuromorphic chip that was developed to support both neuromorphic SNNs and traditional ANNs [202]. The previously mentioned large-scale neuromorphic chips are silicon-based and implemented with conventional Complementary metal oxide semiconductor (CMOS) technology either in digital (synchronous or asynchronous), analog (subthreshold or super-threshold), or mixed signal (where in general neurons are implemented in analog and synapses and learning are implemented in digital domain) [201], [203].

Despite remarkable progress in CMOS based-neuromorphic computing systems, they are not energy- and area-efficient which limits the scalability of such networks [204]. This has driven a significant

effort to investigate non-CMOS implementations of ANNs using emerging technologies such as memristors [205], [206], magnetic tunnel junctions (MTJs) and spin Hall nano-oscillators (SHNOs) [207], etc., as synapses, and MTJs [208], [209], spin-torque nano-oscillators (STNOs) [210], [211] [212], SHNOs [213], phase change materials (PCM), ferroelectric, topological insulators, biomolecular memristor, no-filamentary, etc. [214], [215] as artificial neuron. Meanwhile, memristive technologies are used to build resistive memories to collocate both processing and memory units [203], [216]. On the other hand, spintronics is a strong contender as it is CMOS compatible, multifunctional, and extremely versatile with features like non-volatility, plasticity and oscillatory behavior which can be exploited to implement both artificial neural components (i.e., neuron and synapse) to develop energy efficient ANNs. Each of these technologies have shown unique features that significantly improved energy efficiency with comparable footprints as biological counterparts. Figure 4 represents the structural organization of the central nervous system from carriers ( $1A^\circ$ ) until the brain and most common methods used to study it (top-down analysis), alternatively it shows the equivalent neuromorphic systems used to mimic the brain (bottom-up analogy). Also, Table 7 presents a summary for designing neuromorphic systems from materials to applications [201], [203], [215].

### 3.3 About Spiking Neural Networks SNNs: analogy, overview, and perspectives

Nowadays, SNNs are considered as the third generation of ANNs [217]. Bearing in mind that neurons communicate via electric pulses or action potentials (AP) called spikes. It was only in the early nineties that neuroscientists discovered that biological brains use the exact timing of spikes to encode information [218]. This in turn boosted the development of spike-based neural networks to further understand the information processing skills of the brain. SNNs provide a more biologically realistic

Table 7: Summary of state-of-art for designing neuromorphic systems from materials to applications

Materials	Technology	Circuits		Algorithms	Applications
		Micro-architecture	System architecture		
1. Phase-change materials	1. Electrochemical transistors	1. Digital	1. Feed-forward	1. Control	
2. Ferromagnetic materials	2. Spintronic	2. Analogue	neural network	2. Classification	
3. Ferroelectric materials	3. Memristors	3. Mixed signal	2. Recursive neural network	3. Security	
4. Non-filamentary RRAM materials	4. Optical devices		3. Reservoir computing	4. Benchmarks	
5. Topological insulator materials	5. Charge-trapping transistors		4. Spike-based backpropagation	5. Neural signal processing	
6. Channel-doped bio-membrane	6. Phase-change memories		5. Mapping (conversion-based)	6. Forecasting	
	7. Ferroelectric transistors		6. STDP	7. Edge-computing	
	8. Threshold switching devices		7. Graph-based		
			8. Evolutionary based		

brain-like approach compared to ANNs by incorporating spatial and temporal considerations through neural connectivity and plasticity. Their ability to deal with precise timing spikes makes them competitive with traditional ANNs in terms of accuracy and computational power, and in some cases, better suited for hardware implementation [219], [220].

*Neuron*--The basic computational unit for ANNs is the artificial neuron and its input is processed by an activation function  $f(-)$ , while SNNs unit is the spiking neuron which is expressed by a set of differential equations. SNNs employ several spiking neuron models to simulate the nervous system and the properties of the neurons that generate electrical potentials across their cell membrane. Neuron models implemented in SNNs in the literature range from simple linear models with a fixed



threshold and non-linear models with a spiking mechanism, to more complex and biologically plausible models [162][163]. The most representative neuron models are: i) Leaky Integrate-and-Fire (LIF) [221], ii) Hodgkin–Huxley [222], iii) Izhikevich [223], iv) FitzHugh Nagumo [224]. In LIF, a charge is integrated over time until a threshold value is reached. In brief, a neuron emits a spike each time its membrane potential gets to a specific threshold, afterward it enters a hyperpolarization state during which it is impossible to emit another spike for certain time (i.e., refractory period). It is represented by an electrical circuit consisting of a capacitor in parallel with resistor and driven by current  $I(t)$ . The Hodgkin–Huxley model approximates the functionality of specific neuron aspects such as ion channels. On the other flip, Izhikevich claimed to be biologically plausible as Hodgkin–Huxley model and computationally effective as LIF model [221]. SNNs use mainly clock-driven and event-driven, in contrast with ANNs which use step-by-step stimulation process. Figure 6 presents the most representative neurons models (adapted from [221]).

*Spike encoding*-- To apply the neuron model, the input data must be encoded into spike trains before presenting it to SNNs. Neuroscience is still grappling with several significant questions about the encoding part including: what is the information included in these spatio-temporal spike patterns? What is the used code to transmit information by neurons? Also, how other neurons receive this information and communicate? It is necessary to create spike patterns that preserve most of the task-related information in the input stimuli. Studies have found that such information is merely embedded in the mean firing rate of neurons.

In literature, there are two main encoding schemes a) rate-based encoding and b) temporal encoding (see Figure 6) [225], [226]. The first scheme is based on a spiking characteristic within an interval of time (such as frequency), while the latter is based on spike timing. Several neuron models use rate codes to explain computational processes in the brain. Rate-based schemes include three different notions of mean firing rate “rate as a spike count”, “rate as a spike density” and “rate as a population activity”. However, spiking neuron models can model more complex processes that depend on the relative timing between spikes or timing relative to a reference signal such network oscillation. Taking as a reference the encoding mechanism of biological neurons to specific stimulus signals, researchers have come up with many temporal encoding strategies, such as “time-to-first-spike”, “latency phase,” population encoding”, “correlations and synchrony”, and “Ben’s spiker algorithm”[226], [227]. Often decisions have to be made before a reliable estimate of a spike rate can be computed, therefore temporal codes are highly interesting where even a single spike or small-scale temporal variation in the firing time of a neuron may trigger a different reaction. Figure 6 shows the difference between the two encoding schemes.

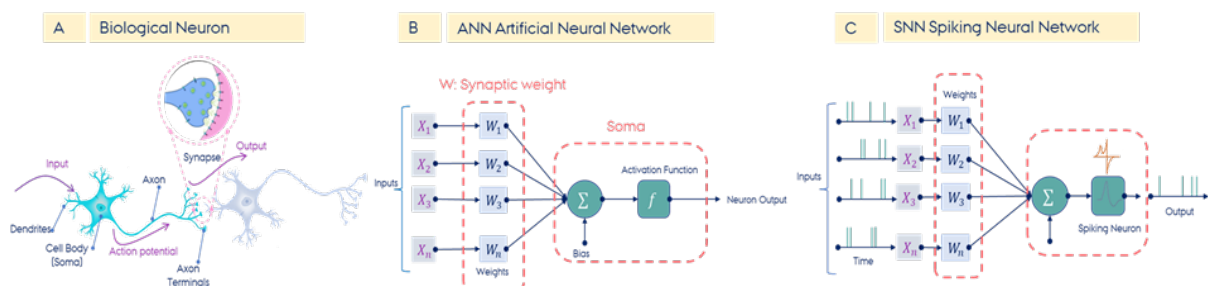

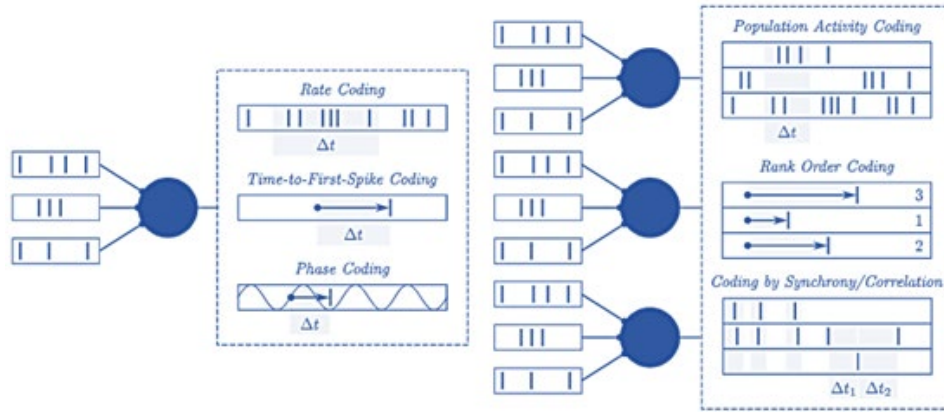

**Figure 5 A. Simplified diagram of a typical biological neural cell.** Soma receives synaptic signals from other neurons through its dendrites, and axon propagates signals to other neurons. A synapse is a contact between the axon of one neuron and a dendrite of another. Soma maintains a voltage gradient across neuron membrane. If the voltage changes by a large enough amount, an action potential pulse, called spike, is generated, then travels along the axon, and eventually activates synaptic connections with other cells when it arrives. **B. Artificial neural network (ANNs), and C. Artificial spiking neural network (SNNs),** it is only active when it receives or emits spikes which make it energy efficient over a given period. The spiking units that donot experience any events remains dormant.



**Figure 6 Rate-based encoding versus temporal encoding:** Schematic representation of some neural codes, neurons are the blue circles the simplified spike coding types and the actual coding schemes are shown respectively on the left and the right © computation by Time by Walter et al. [226]

**Table 8: Comparison between ANNs and SNNs**

	ANNs 1 <sup>st</sup> gen.	ANNs 2 <sup>nd</sup> gen.	SNNs 3 <sup>rd</sup> gen.	Biological systems
<b>Computational units</b>	Perceptron neuron [228]	Artificial Neuron	Spiking Neuron [217]	
<b>Function</b>	Performs thresholding in a digital (1,0) output	Sigmoid unit or a rectified linear unit (ReLU), adds continuous nonlinearity to the neural unit, which enables it to evaluate continuous set of output values	Mainly based on integrate and fire type that exchange information via spikes	
<b>Neuron Model</b>	$y = f\left(\sum_{i=1}^n w_i x_i - \theta\right)$ $= \begin{cases} 0, & \sum_{i=1}^n w_i x_i - \theta < 0 \\ 1, & \sum_{i=1}^n w_i x_i - \theta \geq 0 \end{cases}$	$y = f\left(\sum_{i=1}^n w_i x_i + b\right)$	$\begin{cases} \frac{dX}{dt} = f(X) \\ X \leftarrow g_i(X) \end{cases}$	
<b>Encoding Scheme</b>	Rate encoding	Rate encoding	Temporal encoding	
<b>Information representation</b>	Scalar values	Scalars values	Spike trains	
<b>Computation mode</b>	Activation function	Activation function	Differential equations	
<b>Network simulation</b>	Step-by-step	Step-by-step	Clock driven and event driven	
<b>Input vs Output</b>	Binary, Binary	Real, Real	Real, Real	

Neural Networks architecture	1. Perceptron 2. Multilayer Perceptron (MLP)	1. Conventional Neural networks (CNNs) 2. Recurrent neural network (RNNs)	Spiking Neural Network (SNNs)
<b>Pros</b>	<ol style="list-style-type: none"> <li>1. Intuitive interpretation as spikes</li> <li>2. Few parameters to be optimized</li> </ol>	<ol style="list-style-type: none"> <li>1. Higher biological plausibility than 1<sup>st</sup> gen.</li> <li>2. Large scale gradient base optimization techniques</li> <li>3. Higher computational power than 1<sup>st</sup> gen.</li> <li>4. Implicit time notion, codes fire rates</li> </ol>	<ol style="list-style-type: none"> <li>1. Higher biological plausibility than 2nd gen.</li> <li>2. Massive parallelization and powerful computation</li> <li>3. Successful hardware implementation (Neuromorphic VLSI) Excellent with Spatio and Spectro-temporal data treatment (SSDT)</li> <li>4. Explicit time notion, codes fire rates</li> </ol>
<b>Cons</b>	<ol style="list-style-type: none"> <li>1. Only binary outputs</li> <li>2. Limited analog implementation</li> <li>3. No time notion (coding spikes)</li> </ol>	<ol style="list-style-type: none"> <li>1. No direct Hebbian learning, It only compute fire rates instead of fires</li> <li>2. No intuitive interpretation for spikes</li> <li>3. Moderate parallelization and Spatio and Spectro-temporal data treatment (SSDT)</li> <li>4. VLSI Hardware implementation</li> <li>5. More parameters to be optimized and high sensitivity to its values</li> </ol>	<ol style="list-style-type: none"> <li>1. Biological insights still not sufficient to develop rigid theory</li> <li>2. Unknown behavior with Spatio-temporal data</li> <li>3. No gradient-based optimization interpretation for discontinuity of spikes</li> <li>4. More parameters to be optimized and high sensitivity to its values</li> <li>5. Lack of common framework for the different models and coding schemes</li> </ol>



### 3.4 Learning methods in SNNs

Synaptic plasticity refers to the ability of synaptic connections to change their strength (i.e., modulation of synaptic weights) over time based on network activity. It translated to learning in SNNs. There are various schemes of synaptic plasticity such as Hebbian [225] and non-Hebbian schemes [229], differing primarily in their time scales and induction conditions. Taking the time scale, certain plasticities decay in around 10-100 ms, whereas others last for more time (e.g., Long-Term Potentiation (LTP) or Long-Term-Depression (LTD)). Depending on induction conditions, some synaptic plasticities depend on the relative timing of the pre- neuron and post-neuron synaptic spikes, the temporal order spikes, and on certain factors like specific chemical ion concentrations. While others rely only on the past pre-synaptic stimulation (disregarding the postsynaptic response). The neural circuits either get inhibited or excited according to the type of the synaptic input they receive [221].

Choosing a proper spiking neuron model with suitable synaptic plasticity, along with exploiting event-based, data-driven updates (with event-based sensors) is the key element to obtain computationally efficient intelligence applications such as inference and recognition. SNNs have used two major learning schemes so far: *conversion-based* and *spike-based schemes* which are explained below:

*Conversion-based schemes* -- are based on converting trained 2<sup>nd</sup> ANNs such as deep learning neural networks (DLNs) into SNNs using weight rescaling and normalization to adapt the attributes of nonlinear continuous output of the artificial neuron with that of the spiking neuron (e.g., leak time constant, refractory period, membrane threshold, firing rate, etc.) [230], [231]. By far, they achieve the highest accuracies on large scale spiking networks in image classification like ImageNet dataset [231]–[233]. Commonly, DLNs are trained on frame-based data such as TensorFlow [234] which

gives them a high training-associated flexibility. Conversion needs parsing of the trained DLNs on event-based data (generated by rate-coding of static image dataset) then applying transformations. Conversion-based scheme has the merit of removing training burden in temporal domain. It achieves the same accuracy for image-recognition tasks as that obtained from image classification in traditional deep learning neural networks (DNNs) [235] [233], however, it shows intrinsic limitations as follows. The non-linear neuron output value could take both positive and negative values, while the rate of a spiking neuron can only be positive. Therefore, all the negative values are excluded which lessens the accuracy of converted SNNs. Another issue with conversion-based is the difficulty of achieving an optimal firing rate at each layer without sacrificing performance. Furthermore, the inference time for converted SNNs is quite large which impairs the latency and the energy efficiency [236]. A new mapping strategy was proposed by Stockl et al., in which SNNs use Few Spikes neuron (FS-neuron) model to represent complex activation functions with two spikes at most. The proposed strategy exhibited similar deep learning accuracy with fewer time steps per inference in comparison to typical conversion-based techniques [237]. Applications such as keyword detection, medical image analysis, and object detection have used those mapping strategies and were implemented on existing neuromorphic hardware platforms (e.g., Intel's Loihi, IBM's True North) [199], [200], [238], [239].

*Spike-based* schemes-- fall into three main categories including supervised (training with labeled data), unsupervised (training without labeled data), and reinforcement learning [239]. Supervised Hebbian learning (SHL) rule is one of the most straightforward spike-based learning processes, it is usually supervised by an extra -teaching signal- that drives the post-synaptic neuron to fire at targeted time intervals and to remain silent at other times [217], [240]. Remote Supervised Method (ReSuMe) [241], and tempotron [242] are two of the most early representative works in supervised learning for single layered SNN to perform classification. Researchers have been focusing on integrating spike-based quasi-backpropagation error gradient descent to deploy supervised learning in multi-layered SNNs [243], [244]. For instance, SpikeProp [244] -a learning rule based on gradient descent for training SNNs- and some of created a new backpropagation rule for SNNs by fixing a target spike train at the output layer [245]. Recent works adapted deep-learning training style using surrogate gradient and smoothed activation function to compute the error gradients when adjusting weights in each of the successive layers [246], [247]. There have also been some approaches that perform stochastic gradient descent on real-valued membrane potentials to get more random spikes from the correct output neuron [248], [249]. These few demonstrations shown close to state-of-art-classification performance on the Modified National Institute of Standards and Technology (MNIST) handwritten digits dataset [250]. Backpropagation through time and real time recurrent learning approaches have been applied in neuromorphic datasets such as the Spiking Heidelberg Digits (SHD) and the Spiking Speech Command (SSC) datasets [251], [252]. Supervised learning may be more computationally efficient however, it will not outperform conversion-based approaches in terms of accuracy for large-scale tasks.

In unsupervised learning, the neural connections are reorganized depending on the modification of synaptic weights of the Hebbian processes[225], leading to new functions for example input clustering, pattern recognition, source separation, dimensionality reduction, associative memory formation, etc. Spike-timing-dependent plasticity (STDP) – a learning strategy based on varying the synaptic weights according to the relative spiking timing from pre- and postsynaptic neurons - is the most widely implemented synaptic plasticity in neuromorphic literature. It assimilates more brain-like architectures, due to the possibility of bringing both memory and computation units closer. This in turn induces more energy-efficient on-chip implementations. Diel et al. were from the first groups that demonstrated fully unsupervised learning on an SNN, leading to analogous accuracy to deep learning on the MNIST database [247], [253]. Deep SNNs - Spiking Convolutional Neural network

(SCNN)- are one of the recent scenarios that have shown that adding random error signals through feedback connections enhance learning [254], [255]. It depends on training multilayer SNN network with local spike-based learning per layer then follow it up global backpropagation for classification. Additional class of SNNs are the recurrent networks with delays and synaptic plasticity, it used for modelling dynamical system. Alemi and colleagues applied a local learning rule with recurrent SNNs with less spikes to demonstrate non-linear dynamical systems [256]. These recurrent SNNs display greater classification capacity with winner-take-all models [257], [258]. An alternative algorithm used in SNNs is reservoir computing or liquid state machines (LSM). It is considered as Spiking Recurrent Neural networks (SRNNs), as it uses sparse and recurrent connections with synaptic delays in spiking neural networks to shape the input into a higher dimensional space spatially and temporally [259]. In addition to liquid or reservoir which is the SNN component and untrained, the reservoir computing methods includes a readout mechanism which is trained to realize the output of reservoir. The main advantage of spike-based reservoir computing is the elimination of training in SNN component, and it has shown its effectiveness at processing temporally varying signals in a wide range of application such as bio-signal processing and prosthetic applications [260], [261]. Table 9 and 10 summarize the learning methods in both ANNs and SNNs and give comments on their usage. In another flip, neuromorphic systems have recently been considering few non-machine learning based learning algorithms such as those rising from graph theory [262] and Markov chains [263]. For instance, neuromorphic computing together with graph theory was used as a tool for analyzing Covid-19 disease spread [264]. Neuromorphic deployment of discrete time Markov chains was used by Smith et al., to estimate particle transport problems and heat flow on complex geometries [265]. Figure 7 depicted the different SNNs algorithms.

SNNs are promising candidates for processing data in a low energy mode although there are much more to be investigated to process the applicability of SNNs for general applications. Due to the feature of the SNN as a brain-inspired computing or processing technique, the idea of bringing SNN to the BCIs, whether implantable or wearable, to communicate with the brain can be a potential game changer in this field with a high impact. In the next section, a discussion on the intelligent tools (ANN and SNN) for interfacing the brain signal as well as our perspective on brain inspired BCIs are included.

**Table 9: Learning Methods for both ANNs and SNNs**

Learning models	ANNs	SNNs	Comments
<b>Supervised Learning</b>	1.	SPAN Spike Pattern Association Neuron	1. It works with labeled data to find a mapping of the input to the output through a loss function (error function)
	2.	Surrogate Gradient Descent	2. Two main categories: Classification and regression
			3. Labels in ANNs are represented as integers (classification) or real numbers (regression), while in SNNs it is represented as spike trains with spatial-temporal properties

<b>Unsupervised Learning</b>	<ol style="list-style-type: none"> <li>1. <b>Autoencoder:</b> It is neural network model that learns the implicit features of data (encoding) and reconstructs the original inputs with the newly learned features (decoding)→ feature extraction</li> <li>2. <b>Generative adversarial network (GAN),</b> it learns by contest two networks called generative network and discriminative network.</li> <li>3. <b>Self-organizing map (SOM):</b> It is a method of dimension reduction and uses competitive learning in which output neurons compete for activation, with only one neuron being activated at any given time, called winner-takes-all neuron.</li> </ol>	<ol style="list-style-type: none"> <li>1. <b>Hebbian Learning:</b></li> <li>2. <b>STDP Spike-Timing Dependent Plasticity:</b> Confirms that precise spike timing affects the excitation of inhibition of synaptic plasticity. It may lead to either long-term-travel potentiation (LTP) or Long-term-travel depression (LTD)</li> <li>3. <b>Triples STDP:</b> LTP is constructed as combination of one presynaptic and two postsynaptic spikes. While, LTD is based on two presynaptic and one postsynaptic spike. It takes in account the spiking timing interaction</li> </ol>	<ol style="list-style-type: none"> <li>1. It works with unlabeled data and was presented to overcome the limitation of supervised learning</li> </ol>
<b>Reinforcement learning</b>	<ol style="list-style-type: none"> <li>1. <b>Value-based:</b> Learn the state or station action value. Q-learning most classic value-based algorithms. DeepMind proposed a combination between RL and deep neural networks (Deep Q-Network algorithm)</li> <li>2. <b>Policy-based:</b> It maps the state space to the action space, then taking best action to maximize its return</li> </ol>	<ol style="list-style-type: none"> <li>1. <b>Three-factor learning rules:</b> It sets a flag called eligibility factor on the synapse when co-activating both presynaptic and postsynaptic neurons. Synaptic weights only change when a reward (third factor) is presented.</li> <li>2. <b>ANNs to SNNs:</b> Conversion based learning approaches. It matches the firing frequency of the firing neurons and the successive analog neurons. The training phase is done on ANNs ad then converted to SNNs.</li> </ol>	<ol style="list-style-type: none"> <li>1. It is a machine learning approach to artificial intelligence that works to create processors that solve problem with intelligence</li> <li>2. It was inspired by reward mechanisms for animal learning</li> <li>3. In ANNs, RL based algos it learns from feedback through iterative trails that are simultaneously sequential. It uses nonlinear function approximations.</li> <li>4. RL is biologically interpretable RL in deep learning is time consuming</li> </ol>

**Table 10: Neural networks in SNNs**

<b>Neural Networks</b>	<b>Feedforward Neural network (FNN)</b>	<b>Convolutional Neural networks (CNN)</b>	<b>Recurrent Neural network (RNN)</b>
<b>Definition</b>	<p>Feedforward Neural networks or Multilayer perceptron (MLP) map input <math>x</math> to the output <math>y(x)</math> through a series of non-linear transformations. Elements of network: input layer (1<sup>st</sup> layer), output layer (last layer), hidden layers (in between layers), perceptron,</p>	<p>It learns spatial patterns in an image. Convolutional layer extract spatial features from the input through convolution kernels. It convolves the input with cross-correlation operation followed with nonlinear activation function to obtain multiple outputs. The pooling layer reduces the number of the parameters in the network and computation load by reducing the size of the feature space. The fully connected layer transforms the output of the feature extraction layer into vectors and connects it to the FNN. The last layer classifies the output by a SoftMax function</p>	<p>Instead of memorizing the whole sequence of information. RNNs use the representational information in the hidden layer to memorize the information in the most recent time step in the learning process based on time series, then it combines it with the input of the actual time step to infer the output of the current time step.</p>
		<p>They are used to process visual information specially images. Multiple layers are used to process the grided data such as convolutional, pooling and fully connected layers.</p>	<p>RNN-based Gated recurrent unit (GRU) and long short-term memory (LSTM) have been used in real-life applications</p> <p>They are used to process sequential data or time series data, and to solve ordinal or temporal problems, such as language translation, speech recognition, etc.</p>

SNNs	Spiking feedforward Neural network (SFNN)	Spiking Convolutional Neural network (SCNN)	Spiking Recurrent Neural networks (SRNNs)
	<p>SNNs based on STDP learning and Back propagation- based supervised learning used for pattern recognition.</p> <p>Using a two-layer SNN, based on the biological properties of excitatory type neurons and inhibitory neurons as the processing layer, using lateral inhibition as well as winner-take-all properties, enabling the neurons in the processing layer to extract features with significant characteristics from the input signal based on STDP learning rules, with optimal performance of 95% on the MNIST dataset.</p>	<p>Trained SNNs often have lower performance than DNNs. While training on non-neuromorphic is time consuming.</p> <p>Converted SCNNs are close in performance to CNNs and could perform inference tasks on neuromorphic hardware and consume less time and energy.</p> <p>Difference-of-Gaussian kernel for the input image, followed by unsupervised STDP-based training of the convolutional layer as well as the pooling layer, and finally, the extracted features are passed into the classifier</p>	<p>SRNNs have complex nonlinear dynamics and usually used to study biological neural networks in specific microcircuits of the brain. Excitatory and inhibitory neurons connect to form neural network that is chaotic yet in equilibrium state machine.</p> <p>LSM Liquid state machine is used for computational modeling. It is made of three layers: the input layer, the reservoir or the liquid layer and the memory less readout layer. It transforms the time varying input information into higher dimensional space to express temporal and spatial properties of neuronal dynamics, thus memorize the input information.</p>

## SNNs in BCIs: Spiking neural networks in brain-computer interfaces

ML algorithms commonly learn to identify categories or predict unknown future conditions starting from data. ML methods allow the prediction and progression of brain degenerative disorders as Alzheimer's disease, dementia, schizophrenia, multiple sclerosis, cancer, etc. [266]. As an example, an ML approach combining multiple biomarkers of tremor in LFP like multi-band spectral power, phase-amplitude coupling, and high-frequency oscillations ratio, with a smoothing Kalman filter achieved 89.2% sensitivity in detecting rest state tremor in Parkinson disease patients [101], [267]. Further exemplars were reported in the detailed systematic review paper on AI for Brain diseases published by Segato et al. [100]. In addition, approaches for segmentation and detection of brain structures, as well as pathological tissues, are also widely studied. For instance, a subject-specific logistic regression model was applied to predict memory encoding state from brain-wide ECoG recordings and activate closed-loop stimulation to improve memories anchoring in humans [123], [268]. Nevertheless, it is worth noting that, because of the complexity and the amount of brain data, ML methodologies usually comprise several steps to perform a task. For example, image pre-processing, feature selection and ranking, and dimensionality reduction are often required as initial stages to boost algorithm performances up to adequate levels. Several low-power, area- efficient digital/mixed signal systems on-chips (SoC) with embedded ML have been reported in literature for neural signals acquisition and treatment. Zhang et al. developed the first- in- literature real-time SoC with both online tuning and one-shot learning for patient-specific closed-loop epilepsy tracking system [269]. The work in ref [270] developed a neural interface processor for brain-state classification (NuriP), it implemented an exponentially decaying-memory support vector machine (EDM-SVM) classifier combined with a neural network autoencoder to lower the dimensionality of input data. Alternatively, Cheng et al. presented a low power closed-loop neuromodulation chipset for epilepsy with high common mode interference tolerance that integrates a two-level classifier [271]. Most of these systems were verified offline on human epilepsy data, and in closed-loop seizure control in animal models of epilepsy. ML SoCs also used DDNs (deep neural networks) for emotion detection of autistic children [272], and CNNs (Convolutional Neural Networks) with online training for emotion recognition from EEG- based data [273].

Brain-inspired neuromorphic architectures have been used in several fields of applications such as image recognition, decision making and action selection, spatial navigation and environment

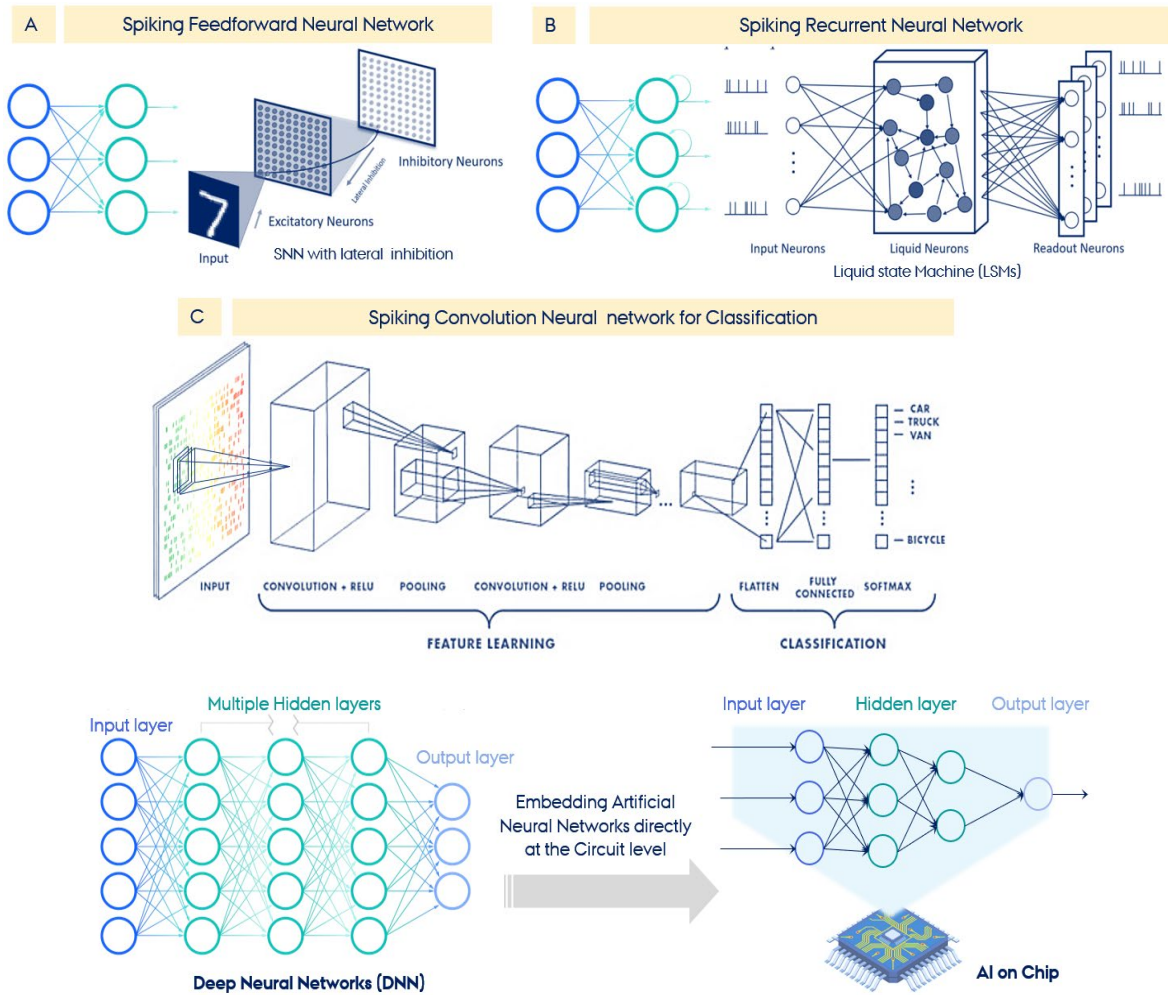
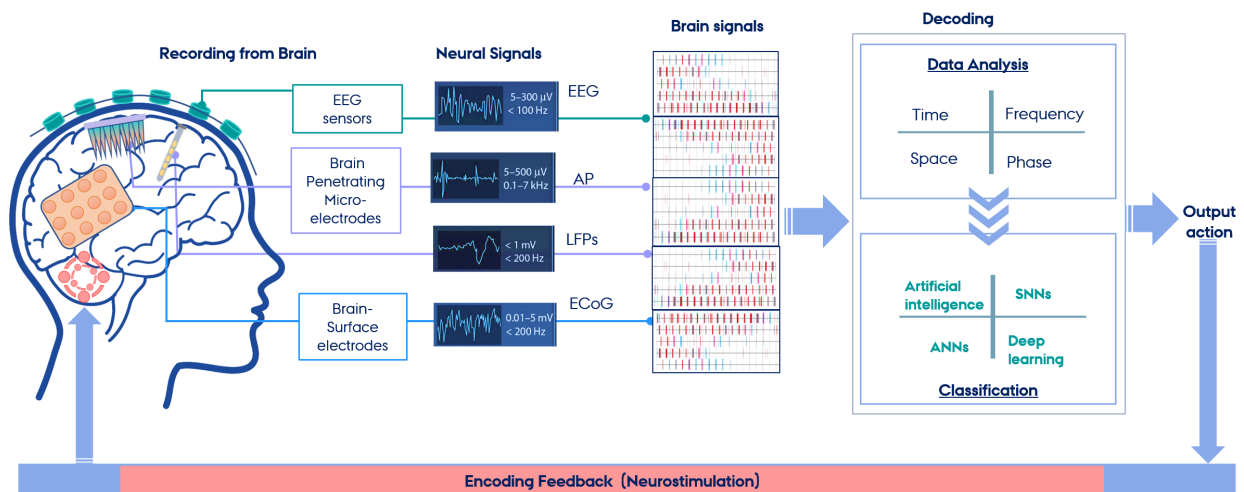

**Figure 7** Neural networks in SNNs: A. Spiking feedforward Neural network (SFNN), B. Spiking Recurrent Neural networks (SRNNs), C. Spiking Convolutional Neural network (SCNN), on-chip Machine learning (ML) implementation.

exploration, rehabilitation and motor control [271], robotic control based [272], etc. For example, iCub Humanoid robot was able to develop brain -inspired cognitive abilities like memory and learned to interact and respond to a dynamic environment through SNNs- based controllers[273]. Additionally, SNNs have been used too for brain disease diagnosis and prognosis, motor imagery signal classification and cognitive process measurement. For example, Capecchi et al. have proposed a method based on NeuCube spiking neural network to classify brain EEG data from patients of Alzheimer's Disease and people diagnosed with mild cognitive impairment and analyze the functional changes in their brain activity [274]. Also, Ghosh-Dastidar et al. data investigated SpikeProp, QuikProp and RProp SNN's classification algorithms to detect epileptic seizures from EEG [243], [275]. Wang et al. suggested an alternative approach for multiple motor imagery decoding based on SNNs. They used a filter with one-vs-rest (OVR) strategy were employed to extract the spatio-temporal-frequency features of multiple imagery after preprocessing. Then, they applied F-score to optimize and select these features which in turn were fed for SNN for classification [276]. Some SNN accelerators take advantage of weight sparsity to efficiently reduce the model size, computation, and data transfer energy. They are commonly implemented in Application Specific Integrated Circuit (ASIC) with either offline [193], [196] or on chip learning [277]–[279].



Thanks to their low power, high adaptability, and ability to emulate the nervous system functionality in analog, digital or mixed-signal CMOS hardware, neuromorphic designs are receiving more attention in BCIs and neural prostheses systems [280]. For instance, the neuromorphic system in ref [281] used an analog Spiking Neural Network (SNN) classifier and demonstrated STDP rule as a spike sorter for BCI applications [223]. Similarly, combinations of spiking reservoirs and STDP have been used in a SNN architecture called NeuCube [282], which was used to process electroencephalograms (EEG) signals and functional magnetic resonance imaging (fMRI) signals in applications such as sleep state detection [283] and prosthetic controllers [284]. Indiveri et al. developed an event-based neuromorphic system with on-line learning for classifying auditory stimuli [285]. Likewise, the neuromorphic processor was implemented in modular closed-loop BCI for decoding motor intentions and delivering sensory stimuli to the brains of anesthetized rats [286], [287]. Another method based on spiking activity, LFP features was used to evoke somatosensory feedback in closed loop BCI in rodents [288]. Another method used wireless battery-powered neural implant to stimulate the somatosensory cortex in response to spikes detected in the premotor cortex in a rat model with brain injury [289]. Neural chips can be applied too in a bidirectional closed loop prostheses for brain disorder treatment as epilepsy. Recently, Moradi et al. built a CMOS-based neuromorphic device for the detection of epileptic seizures from local field potential (LFP) signals [290]. Also, a mixed-signal multi-core neuromorphic processor (DYNAPs) exploiting an event-based communication was used to detect High-Frequency Oscillations (HFO) as biomarkers of seizure events [61], [198]. A high-density retinal implant with in-pixel neuromorphic image processing and temperature-regulation circuits, mimics human retinal operation [291]. Neuromorphic platforms such as IBM's TrueNorth processor were used to implement CNNs that treats electrophysiological signals [292], [293].

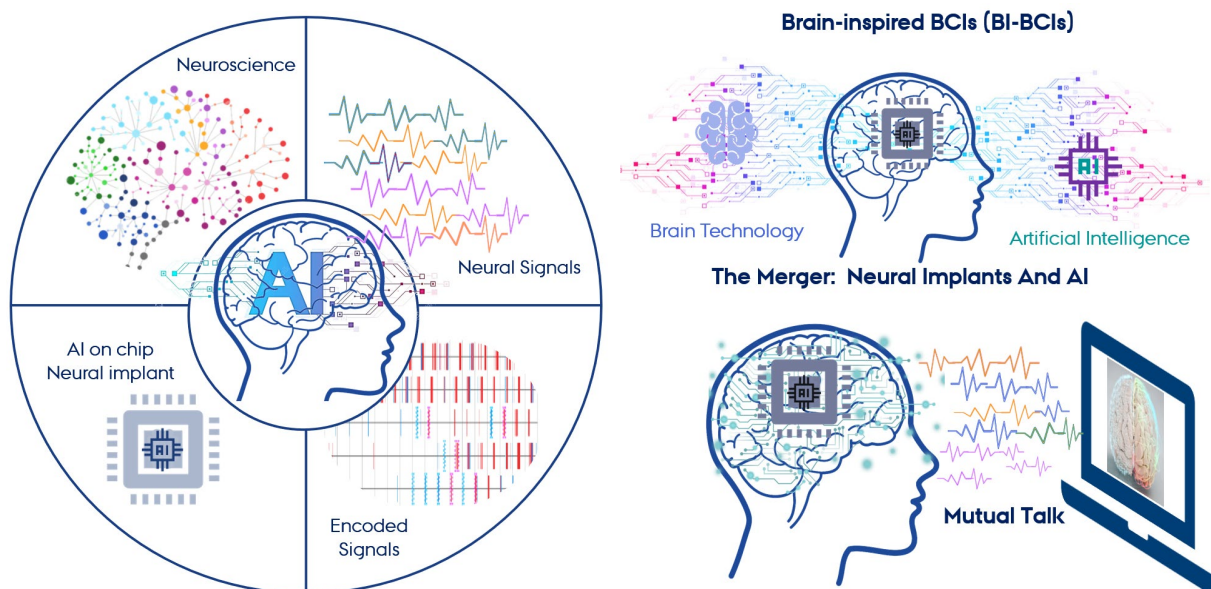

**Figure 8 SNNs In BCIs for communication.** The user's intention can be converted into commands to control the external devices after the process of decoding, transmitting, and encoding. Several extracted neural signals recorded by either invasive or non-invasive BCIs: Electroencephalography (EEG) signals recorded from the scalp, ECoG from brain surface, action potential (AP or spikes) and Local field potential (LEPs) from Brain penetrating microelectrodes. The extracted signals will be decoded and transformed into spikes and later translated into output action to control external devices such robotic arm, neuroprostheses, etc. The missing block is encoding multimodal information and feeding it back to brain through neurostimulation.

#### 4 Conclusion and outlook: Brain inspired- Brain computer interfaces (BI-BCIs)

Based on what presented, it is becoming clear that neuromorphic computing embedded into neural interfaces can play a critical role in the future landscape of technologies for treating neurological disorders. The feasibility of such systems has been demonstrated, however there are still major questions that need to be resolved in the hardware and software levels.

Currently, the existing encoding systems [19], [99] suffer from high latency due to the large amount of data fed into these systems. To improve the latency of such systems is to reduce the volume of the unnecessary information to be processed. Although, recently, the encoding speed as well as the accuracy of BCIs have been improved due to the advances in ML/AI algorithms and more optimized hardware, [294], [295], we are still far from the realization of a real-time BCI interfacing the brain and communicating with it. SNNs provides a powerful tool for modeling complex information processing in the brain, due to their ability to simulate the rich dynamics of the biological neurons and to represent and integrate different information dimensions, as time, frequency, and phase. It leverages spike information representation (binary events) which is like the action potentials in the brain. Besides, SNNs use biologically plausible local learning rules such as STDP and Hebbian learning, which allow for fast real-time learning and low computational complexity. SNNs as neuromorphic computing architecture offers several advantages such as: flexible structure, incremental life-long learning, temporal or spatio-temporal associations between input variables are learned, event-based or asynchronous learning leading to less volume of data, facilitate interpretability of the model, low power and computational demand, more energy-efficient communication through spikes, and fault tolerance. By taking the advantages of the synergy and complementarity between SNNs and human intelligence, we postulate that bringing SNNs into BCIs, in implantable or wearable form, to communicate with the brain would radically change the neuroscience research field and push it further to attain better results than any classical system using new BCIs.



**Figure 9 Brain inspired-BCIs:** Left: BCI as an interdisciplinary field that combine neuroscience and engineering, Right: Merging neural implants interface with AI to obtain intelligent BCI that would interact with external devices.

Our future vision is to create an intelligent BCI system that would merge AI with neural interface technologies in what so-called Brain Inspired- BCI (BI-BCIs) (see Figure 9) which interacts with the brain in the most natural way as it should. This paper reviewed the most recent developments in this domain, with a focus on brain-inspired computing techniques and their implementations. Merging brain-inspired neuromorphic computing with BCIs creates a human-in-loop system, in which both technologies interwind to alleviate disabilities and impairments and to restore human performance. The joint interaction between the human and the machine could lead us to realize augmented human intelligence, which in turn one of the main endeavors for future BCI research. Moreover, we consider that these systems could lead to a whole new generation of intelligent brain interfaces with unprecedented therapeutic efficiency for a wide range of neurological and mental disorders as illustrated in Figure 10.

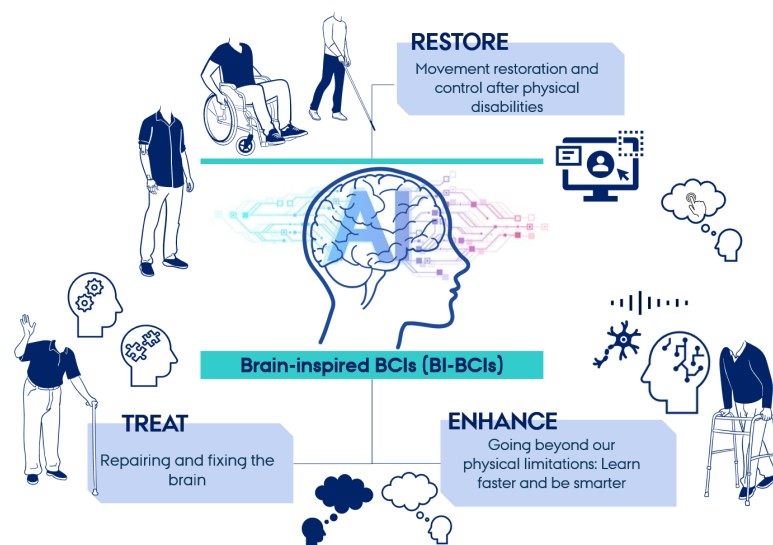

**Figure 10** Brain Inspired- Brain Computer Interfaces (BI-BCIs) that links the human intelligence with AI-neural Implants

Finally, BCI is an interdisciplinary field of research, and its advancement depends on the collaboration between neuroscience and engineering technologies. From the neuroscience standpoint, we need to understand better the function and the working mechanisms of the brain. While from the engineering standpoint, we need to create new develop intelligent miniaturized low-power neural implants that allows us to access deep brain structures, brain inspired neural algorithms to analyze neural activity and encode it efficiently to acquire real-time interaction, and spike-based energy efficient hardware.

### Acknowledgement:

This work was supported by STARDUST project, that received funding from the European Union's Horizon 2020 research and innovation program under grant agreement ID: 767092 and DOI [10.3030/767092](https://doi.org/10.3030/767092). Also, by the European Union's Horizon project H2020-HERMES, under grant agreement ID: 824164 and DOI [10.3030/824164](https://doi.org/10.3030/824164)

### 5 References:

- [1] C. Marras *et al.*, 'Prevalence of Parkinson's disease across North America', *NPJ Parkinsons Dis*, vol. 4, no. 1, Dec. 2018, doi: 10.1038/S41531-018-0058-0.
- [2] G. Deuschl *et al.*, 'The burden of neurological diseases in Europe: an analysis for the Global Burden of Disease Study 2017', *Lancet Public Health*, vol. 5, no. 10, pp. e551–e567, Oct. 2020, doi: 10.1016/S2468-2667(20)30190-0.
- [3] V. L. Feigin *et al.*, 'Global, regional, and national burden of neurological disorders, 1990-2016: a systematic analysis for the Global Burden of Disease Study 2016', *Lancet Neurol*, vol. 18, no. 5, pp. 459–480, May 2019, doi: 10.1016/S1474-4422(18)30499-X.
- [4] X. Chen and W. Pan, 'The Treatment Strategies for Neurodegenerative Diseases by Integrative Medicine', *Integr Med Int*, vol. 1, no. 4, pp. 223–225, Apr. 2014, doi: 10.1159/000381546.
- [5] M. K. Poddar, A. Chakraborty, and S. Banerjee, 'Neurodegeneration: Diagnosis, Prevention, and Therapy', *Oxidoreductase*, Jan. 2021, doi: 10.5772/INTECHOPEN.94950.
- [6] G. Deuschl *et al.*, 'A Randomized Trial of Deep-Brain Stimulation for Parkinson's Disease', *New England Journal of Medicine*, vol. 355, no. 9, pp. 896–908, Aug. 2006, doi: 10.1056/NEJMOA060281.
- [7] J. K. Krauss *et al.*, 'Technology of deep brain stimulation: current status and future directions', *Nature Reviews Neurology* 2020 17:2, vol. 17, no. 2, pp. 75–87, Nov. 2020, doi: 10.1038/s41582-020-00426-z.
- [8] O. Müller and S. Rotter, 'Neurotechnology: Current Developments and Ethical Issues', *Front Syst Neurosci*, vol. 11, p. 93, Dec. 2017, doi: 10.3389/FNSYS.2017.00093/BIBTEX.
- [9] C. Cinel, D. Valeriani, and R. Poli, 'Neurotechnologies for human cognitive augmentation: Current state of the art and future prospects', *Front Hum Neurosci*, vol. 13, no. January, 2019, doi: 10.3389/fnhum.2019.00013.
- [10] A. I. Journal and D. L. Sorkin, 'Cochlear implantation in the world's largest medical device market: Utilization and awareness of cochlear implants in the United States', <https://doi.org/10.1179/1467010013Z.00000000076>, vol. 14, no. SUPPL. 1, Mar. 2013, doi: 10.1179/1467010013Z.00000000076.
- [11] A. K. Ahuja *et al.*, 'Blind subjects implanted with the Argus II retinal prosthesis are able to improve performance in a spatial-motor task', *British Journal of Ophthalmology*, vol. 95, no. 4, pp. 539–543, Apr. 2011, doi: 10.1136/BJO.2010.179622.
- [12] I. Tochitsky *et al.*, 'Restoring visual function to blind mice with photoswitches that selectively target the degenerated retina.', *Invest Ophthalmol Vis Sci*, vol. 55, no. 13, pp. 4616–4616, Apr. 2014.
- [13] M. J. Vansteensel and B. Jarosiewicz, 'Brain-computer interfaces for communication', *Handb Clin Neurol*, vol. 168, pp. 67–85, Jan. 2020, doi: 10.1016/B978-0-444-63934-9.00007-X.
- [14] B. K. Min, M. J. Marzelli, and S. S. Yoo, 'Neuroimaging-based approaches in the brain–computer interface', *Trends Biotechnol*, vol. 28, no. 11, pp. 552–560, Nov. 2010, doi: 10.1016/J.TIBTECH.2010.08.002.
- [15] M. C. Lo and A. S. Widge, 'Closed-loop neuromodulation systems: next-generation treatments for psychiatric illness', <https://doi.org/10.1080/09540261.2017.1282438>, vol. 29, no. 2, pp. 191–204, Mar. 2017, doi: 10.1080/09540261.2017.1282438.
- [16] G. Deuschl *et al.*, 'The burden of neurological diseases in Europe: an analysis for the Global Burden of Disease Study 2017', *Lancet Public Health*, vol. 5, no. 10, pp. e551–e567, Oct. 2020, doi: 10.1016/S2468-2667(20)30190-0.
- [17] S. S. Tarun Dua, Marco Garrido Cumbreira, Colin Mathers, 'Global burden of neurological disorders: estimates and projections', *NEUROLOGICAL DISORDERS public health challenges*, pp. 27–39, 2007.
- [18] A. Abbott, 'Billion-Dollar Brain maps: What we've learnt', Oct. 07, 2021. Accessed: Jun. 20, 2022. [Online]. Available: <https://media.nature.com/original/magazine-assets/d41586-021-02661-w/d41586-021-02661-w.pdf>
- [19] S. Saha *et al.*, 'Progress in Brain Computer Interface: Challenges and Opportunities', *Front Syst Neurosci*, vol. 15, no. February, pp. 1–20, 2021, doi: 10.3389/fnsys.2021.578875.
- [20] J. J. Vidal, 'Toward direct brain-computer communication', *Annu Rev Biophys Bioeng*, vol. 2, pp. 157–180, 1973, doi: 10.1146/ANNUREV.BB.02.060173.001105.
- [21] J. K. Chapin, K. A. Moxon, R. S. Markowitz, and M. A. L. Nicolelis, 'Real-time control of a robot arm using simultaneously recorded neurons in the motor cortex', *Nature Neuroscience* 1999 2:7, vol. 2, no. 7, pp. 664–670, Jul. 1999, doi: 10.1038/10223.
- [22] D. M. Taylor, S. I. H. Tillery, and A. B. Schwartz, 'Direct cortical control of 3D neuroprosthetic devices', *Science (1979)*, vol. 296, no. 5574, pp. 1829–1832, Jun. 2002, doi: 10.1126/SCIENCE.1070291/SUPPL\_FILE/1070291S3.MOV.
- [23] G. Santhanam, S. I. Ryu, B. M. Yu, A. Afshar, and K. v. Shenoy, 'A high-performance brain–computer interface', *Nature* 2006 442:7099, vol. 442, no. 7099, pp. 195–198, Jul. 2006, doi: 10.1038/nature04968.
- [24] M. A. L. Nicolelis, 'Actions from thoughts', *Nature* 2001 409:6818, vol. 409, no. 6818, pp. 403–407, Jan. 2001, doi: 10.1038/35053191.

- [25] M. Velliste, S. Perel, M. C. Spalding, A. S. Whitford, and A. B. Schwartz, ‘Cortical control of a prosthetic arm for self-feeding’, *Nature* 2008 453:7198, vol. 453, no. 7198, pp. 1098–1101, May 2008, doi: 10.1038/nature06996.
- [26] L. R. Hochberg *et al.*, ‘Neuronal ensemble control of prosthetic devices by a human with tetraplegia’, *Nature* 2006 442:7099, vol. 442, no. 7099, pp. 164–171, Jul. 2006, doi: 10.1038/nature04970.
- [27] J. P. Donoghue, A. Nurmikko, M. Black, and L. R. Hochberg, ‘Assistive technology and robotic control using motor cortex ensemble-based neural interface systems in humans with tetraplegia’, *J Physiol*, vol. 579, no. 3, pp. 603–611, Mar. 2007, doi: 10.1113/JPHYSIOL.2006.127209.
- [28] C. Brunner *et al.*, ‘BNCI Horizon 2020: towards a roadmap for the BCI community’, <http://dx.doi.org/10.1080/2326263X.2015.1008956>, vol. 2, no. 1, pp. 1–10, Jan. 2015, doi: 10.1080/2326263X.2015.1008956.
- [29] A. Caria, R. Sitaram, and N. Birbaumer, ‘Real-time fMRI: A tool for local brain regulation’, *Neuroscientist*, vol. 18, no. 5, pp. 487–501, Oct. 2012, doi: 10.1177/1073858411407205.
- [30] Y. Wang, R. Wang, X. Gao, B. Hong, and S. Gao, ‘A practical VEP-based brain-computer interface’, *IEEE Transactions on Neural Systems and Rehabilitation Engineering*, vol. 14, no. 2, pp. 234–239, Jun. 2006, doi: 10.1109/TNSRE.2006.875576.
- [31] M. A. Romero-Laiseca *et al.*, ‘A Low-Cost Lower-Limb Brain-Machine Interface Triggered by Pedaling Motor Imagery for Post-Stroke Patients Rehabilitation’, *IEEE Transactions on Neural Systems and Rehabilitation Engineering*, vol. 28, no. 4, pp. 988–996, Apr. 2020, doi: 10.1109/TNSRE.2020.2974056.
- [32] F. Nijboer *et al.*, ‘An auditory brain–computer interface (BCI)’, *J Neurosci Methods*, vol. 167, no. 1, pp. 43–50, Jan. 2008, doi: 10.1016/J.JNEUMETH.2007.02.009.
- [33] Z. R. Lugo *et al.*, ‘A vibrotactile P300-based brain-computer interface for consciousness detection and communication’, *Clin EEG Neurosci*, vol. 45, no. 1, pp. 14–21, Jan. 2014, doi: 10.1177/1550059413505533.
- [34] T. O. Zander, C. Kothe, S. Welke, and M. Roetting, ‘Utilizing secondary input from passive brain-computer interfaces for enhancing human-machine interaction’, *Lecture Notes in Computer Science (including subseries Lecture Notes in Artificial Intelligence and Lecture Notes in Bioinformatics)*, vol. 5638 LNAI, pp. 759–771, 2009, doi: 10.1007/978-3-642-02812-0\_86/COVER/.
- [35] P. Arico, G. Borghini, G. di Flumeri, N. Sciaraffa, and F. Babiloni, ‘Passive BCI beyond the lab: current trends and future directions’, *Physiol Meas*, vol. 39, no. 8, p. 08TR02, Aug. 2018, doi: 10.1088/1361-6579/AAD57E.
- [36] S. Marchesotti, M. Bassolino, A. Serino, H. Bleuler, and O. Blanke, ‘Quantifying the role of motor imagery in brain-machine interfaces’, *Scientific Reports* 2016 6:1, vol. 6, no. 1, pp. 1–12, Apr. 2016, doi: 10.1038/srep24076.
- [37] U. Chaudhary, ‘Brain-computer interfaces for communication and rehabilitation’, *Nat Rev Neurol*, vol. 12, no. 9, pp. 513–525, 2016, doi: 10.1038/nrneurol.2016.113.
- [38] U. Chaudhary, B. Xia, S. Silvoni, L. G. Cohen, and N. Birbaumer, ‘Brain–Computer Interface–Based Communication in the Completely Locked-In State’, *PLoS Biol*, vol. 15, no. 1, p. e1002593, Jan. 2017, doi: 10.1371/JOURNAL.PBIO.1002593.
- [39] Z. Gao *et al.*, ‘EEG-Based Spatio-Temporal Convolutional Neural Network for Driver Fatigue Evaluation’, *IEEE Trans Neural Netw Learn Syst*, vol. 30, no. 9, pp. 2755–2763, Sep. 2019, doi: 10.1109/TNNLS.2018.2886414.
- [40] J. D. Haynes, ‘A Primer on Pattern-Based Approaches to fMRI: Principles, Pitfalls, and Perspectives’, *Neuron*, vol. 87, no. 2, pp. 257–270, Jul. 2015, doi: 10.1016/J.NEURON.2015.05.025.
- [41] Y. Miyawaki *et al.*, ‘Visual Image Reconstruction from Human Brain Activity using a Combination of Multiscale Local Image Decoders’, *Neuron*, vol. 60, no. 5, pp. 915–929, Dec. 2008, doi: 10.1016/J.NEURON.2008.11.004.
- [42] A. M. Owen, M. R. Coleman, M. Boly, M. H. Davis, S. Laureys, and J. D. Pickard, ‘Detecting awareness in the vegetative state’, *Science (1979)*, vol. 313, no. 5792, p. 1402, Sep. 2006, doi: 10.1126/SCIENCE.1130197/SUPPL\_FILE/OWEN.SOM.PDF.
- [43] A. M. Owen and M. R. Coleman, ‘Functional neuroimaging of the vegetative state’, *Nature Reviews Neuroscience* 2008 9:3, vol. 9, no. 3, pp. 235–243, Mar. 2008, doi: 10.1038/nrn2330.
- [44] G. Buzsáki, C. A. Anastassiou, and C. Koch, ‘The origin of extracellular fields and currents — EEG, ECoG, LFP and spikes’, *Nature Reviews Neuroscience* 2012 13:6, vol. 13, no. 6, pp. 407–420, May 2012, doi: 10.1038/nrn3241.
- [45] G. Schalk and E. C. Leuthardt, ‘Brain-computer interfaces using electrocorticographic signals’, *IEEE Rev Biomed Eng*, vol. 4, pp. 140–154, 2011, doi: 10.1109/RBME.2011.2172408.
- [46] T. Kaiju *et al.*, ‘High Spatiotemporal Resolution ECoG Recording of Somatosensory Evoked Potentials with Flexible Micro-Electrode Arrays’, *Front Neural Circuits*, vol. 11, Apr. 2017, doi: 10.3389/FNCIR.2017.00020.
- [47] C. Pandarinath *et al.*, ‘High performance communication by people with paralysis using an intracortical brain-computer interface’, *Elife*, vol. 6, Feb. 2017, doi: 10.7554/ELIFE.18554.

- [48] M. P. Branco, Z. v. Freudenburg, E. J. Aarnoutse, M. G. Bleichner, M. J. Vansteensel, and N. F. Ramsey, ‘Decoding hand gestures from primary somatosensory cortex using high-density ECoG’, *Neuroimage*, vol. 147, pp. 130–142, Feb. 2017, doi: 10.1016/J.NEUROIMAGE.2016.12.004.
- [49] S. Schaffelhofer, A. Agudelo-Toro, and H. Scherberger, ‘Decoding a wide range of hand configurations from macaque motor, premotor, and parietal cortices’, *Journal of Neuroscience*, vol. 35, no. 3, pp. 1068–1081, Jan. 2015, doi: 10.1523/JNEUROSCI.3594-14.2015.
- [50] D. L. K. Yamins, H. Hong, C. F. Cadieu, E. A. Solomon, D. Seibert, and J. J. DiCarlo, ‘Performance-optimized hierarchical models predict neural responses in higher visual cortex’, *Proc Natl Acad Sci U S A*, vol. 111, no. 23, pp. 8619–8624, Jun. 2014, doi: 10.1073/PNAS.1403112111/SUPPL\_FILE/PNAS.201403112SI.PDF.
- [51] C. E. Bouton *et al.*, ‘Restoring cortical control of functional movement in a human with quadriplegia’, *Nature* 2016 533:7602, vol. 533, no. 7602, pp. 247–250, Apr. 2016, doi: 10.1038/nature17435.
- [52] G. Lajoie, N. I. Krouchev, J. F. Kalaska, A. L. Fairhall, and E. E. Fetz, ‘Correlation-based model of artificially induced plasticity in motor cortex by a bidirectional brain-computer interface’, *PLoS Comput Biol*, vol. 13, no. 2, p. e1005343, Feb. 2017, doi: 10.1371/JOURNAL.PCBI.1005343.
- [53] M. R. Cohen and J. H. R. Maunsell, ‘A Neuronal Population Measure of Attention Predicts Behavioral Performance on Individual Trials’, *Journal of Neuroscience*, vol. 30, no. 45, pp. 15241–15253, Nov. 2010, doi: 10.1523/JNEUROSCI.2171-10.2010.
- [54] M. Siegel, T. J. Buschman, and E. K. Miller, ‘Cortical information flow during flexible sensorimotor decisions’, *Science (1979)*, vol. 348, no. 6241, pp. 1352–1355, Jun. 2015, doi: 10.1126/SCIENCE.AAB0551/SUPPL\_FILE/SIEGEL-SM.PDF.
- [55] R. Q. Quiroga, ‘Concept cells: the building blocks of declarative memory functions’, *Nature Reviews Neuroscience* 2012 13:8, vol. 13, no. 8, pp. 587–597, Jul. 2012, doi: 10.1038/nrn3251.
- [56] H. Gelbard-Sagiv, R. Mukamel, M. Harel, R. Malach, and I. Fried, ‘Internally generated reactivation of single neurons in human hippocampus during free recall’, *Science (1979)*, vol. 322, no. 5898, pp. 96–101, Oct. 2008, doi: 10.1126/SCIENCE.1164685/SUPPL\_FILE/GELBARD-SAGIV1164685S2.REVISION.1.MOVIE.MOV.
- [57] R. Q. Quiroga, L. Reddy, G. Kreiman, C. Koch, and I. Fried, ‘Invariant visual representation by single neurons in the human brain’, *Nature* 2005 435:7045, vol. 435, no. 7045, pp. 1102–1107, Jun. 2005, doi: 10.1038/nature03687.
- [58] M. J. Vansteensel *et al.*, ‘Fully Implanted Brain–Computer Interface in a Locked-In Patient with ALS’, *New England Journal of Medicine*, vol. 375, no. 21, pp. 2060–2066, Nov. 2016, doi: 10.1056/NEJM0A1608085/SUPPL\_FILE/NEJM0A1608085\_DISCLOSURES.PDF.
- [59] J. J. Jun *et al.*, ‘Fully integrated silicon probes for high-density recording of neural activity’, *Nature* 2017 551:7679, vol. 551, no. 7679, pp. 232–236, Nov. 2017, doi: 10.1038/nature24636.
- [60] T. H. Kim *et al.*, ‘Long-Term Optical Access to an Estimated One Million Neurons in the Live Mouse Cortex’, *Cell Rep*, vol. 17, no. 12, pp. 3385–3394, Dec. 2016, doi: 10.1016/J.CELREP.2016.12.004.
- [61] M. Sharifshazileh, K. Burelo, J. Sarnthein, and G. Indiveri, ‘An electronic neuromorphic system for real-time detection of high frequency oscillations (HFO) in intracranial EEG’, *Nature Communications* 2021 12:1, vol. 12, no. 1, pp. 1–14, May 2021, doi: 10.1038/s41467-021-23342-2.
- [62] W. Park, G. H. Kwon, Y. H. Kim, J. H. Lee, and L. Kim, ‘EEG response varies with lesion location in patients with chronic stroke’, *J Neuroeng Rehabil*, vol. 13, no. 1, pp. 1–10, Mar. 2016, doi: 10.1186/S12984-016-0120-2/FIGURES/4.
- [63] S. I. Gonçalves *et al.*, ‘Correlating the alpha rhythm to BOLD using simultaneous EEG/fMRI: Inter-subject variability’, *Neuroimage*, vol. 30, no. 1, pp. 203–213, Mar. 2006, doi: 10.1016/J.NEUROIMAGE.2005.09.062.
- [64] I. Käthner, S. C. Wriessnegger, G. R. Müller-Putz, A. Kübler, and S. Halder, ‘Effects of mental workload and fatigue on the P300, alpha and theta band power during operation of an ERP (P300) brain–computer interface’, *Biol Psychol*, vol. 102, no. 1, pp. 118–129, Oct. 2014, doi: 10.1016/J.BIOPSYCHO.2014.07.014.
- [65] L. Acqualagna, L. Botrel, C. Vidaurre, A. Kübler, and B. Blankertz, ‘Large-Scale Assessment of a Fully Automatic Co-Adaptive Motor Imagery-Based Brain Computer Interface’, *PLoS One*, vol. 11, no. 2, p. e0148886, Feb. 2016, doi: 10.1371/JOURNAL.PONE.0148886.
- [66] N. N. Johnson *et al.*, ‘Combined rTMS and virtual reality brain–computer interface training for motor recovery after stroke’, *J Neural Eng*, vol. 15, no. 1, p. 016009, Jan. 2018, doi: 10.1088/1741-2552/AA8CE3.
- [67] S. Saha *et al.*, ‘Wavelet Entropy-Based Inter-subject Associative Cortical Source Localization for Sensorimotor BCI’, *Front Neuroinform*, vol. 13, Jul. 2019, doi: 10.3389/FNINF.2019.00047/FULL.
- [68] D. Sand, Z. Peremen, D. Haor, D. Arkadir, H. Bergman, and A. Geva, ‘Optimization of deep brain stimulation in STN among patients with Parkinson’s disease using a novel EEG-based tool’, *Brain Stimul*, vol. 10, no. 2, p. 510, Mar. 2017, doi: 10.1016/J.BRS.2017.01.490.

- [69] M. C. Corsi *et al.*, ‘Integrating EEG and MEG Signals to Improve Motor Imagery Classification in Brain–Computer Interface’, <https://doi.org/10.1142/S0129065718500144>, vol. 29, no. 1, Jan. 2019, doi: 10.1142/S0129065718500144.
- [70] U. Chaudhary, N. Birbaumer, and M. R. Curado, ‘Brain-Machine Interface (BMI) in paralysis’, *Ann Phys Rehabil Med*, vol. 58, no. 1, pp. 9–13, Feb. 2015, doi: 10.1016/J.REHAB.2014.11.002.
- [71] J. Mellinger *et al.*, ‘An MEG-based brain–computer interface (BCI)’, *Neuroimage*, vol. 36, no. 3, pp. 581–593, Jul. 2007, doi: 10.1016/J.NEUROIMAGE.2007.03.019.
- [72] R. Fukuma *et al.*, ‘Real-time control of a neuroprosthetic hand by magnetoencephalographic signals from paralysed patients’, *Sci Rep*, vol. 6, Feb. 2016, doi: 10.1038/SREP21781.
- [73] V. D. Calhoun and T. Adali, ‘Time-Varying Brain Connectivity in fMRI Data: Whole-brain data-driven approaches for capturing and characterizing dynamic states’, *IEEE Signal Process Mag*, vol. 33, no. 3, pp. 52–66, May 2016, doi: 10.1109/MSP.2015.2478915.
- [74] M. T. DeBettencourt, J. D. Cohen, R. F. Lee, K. A. Norman, and N. B. Turk-Browne, ‘Closed-loop training of attention with real-time brain imaging’, *Nat Neurosci*, vol. 18, no. 3, pp. 470–478, Mar. 2015, doi: 10.1038/NN.3940.
- [75] H. Khan, N. Naseer, A. Yazidi, P. K. Eide, H. W. Hassan, and P. Mirtaheri, ‘Analysis of Human Gait Using Hybrid EEG-fNIRS-Based BCI System: A Review’, *Front Hum Neurosci*, vol. 14, p. 613254, Jan. 2020, doi: 10.3389/FNHUM.2020.613254.
- [76] A. Rezaadeh Sereshkeh, R. Yousefi, A. T. Wong, F. Rudzicz, and T. Chau, ‘Development of a ternary hybrid fNIRS-EEG brain–computer interface based on imagined speech’, *Brain-Computer Interfaces*, vol. 6, no. 4, pp. 128–140, Oct. 2019, doi: 10.1080/2326263X.2019.1698928.
- [77] A. M. Chiarelli, P. Croce, A. Merla, and F. Zappasodi, ‘Deep learning for hybrid EEG-fNIRS brain-computer interface: application to motor imagery classification’, *J Neural Eng*, vol. 15, no. 3, Apr. 2018, doi: 10.1088/1741-2552/AAAF82.
- [78] C. Li, M. Su, J. Xu, H. Jin, and L. Sun, ‘A Between-Subject fNIRS-BCI Study on Detecting Self-Regulated Intention during Walking’, *IEEE Transactions on Neural Systems and Rehabilitation Engineering*, vol. 28, no. 2, pp. 531–540, Feb. 2020, doi: 10.1109/TNSRE.2020.2965628.
- [79] A. Kaas, R. Goebel, G. Valente, and B. Sorger, ‘Topographic Somatosensory Imagery for Real-Time fMRI Brain-Computer Interfacing’, *Front Hum Neurosci*, vol. 13, p. 427, Dec. 2019, doi: 10.3389/FNHUM.2019.00427/BIBTEX.
- [80] J. H. Lee, J. Kim, and S. S. Yoo, ‘Real-time fMRI-based neurofeedback reinforces causality of attention networks’, *Neurosci Res*, vol. 72, no. 4, pp. 347–354, Apr. 2012, doi: 10.1016/J.NEURES.2012.01.002.
- [81] M. Pahwa, M. Kusner, C. D. Hacker, D. T. Bundy, K. Q. Weinberger, and E. C. Leuthardt, ‘Optimizing the Detection of Wakeful and Sleep-Like States for Future Electroencephalographic Brain Computer Interface Applications.’, *PLoS One*, vol. 10, no. 11, p. e0142947, Jan. 2015, doi: 10.1371/JOURNAL.PONE.0142947.
- [82] F. Sauter-Starace *et al.*, ‘Long-Term Sheep Implantation of WIMAGINE®, a Wireless 64-Channel Electroencephalogram Recorder’, *Front Neurosci*, vol. 13, Aug. 2019, doi: 10.3389/FNINS.2019.00847/PDF.
- [83] J. G. Makin, D. A. Moses, and E. F. Chang, ‘Machine translation of cortical activity to text with an encoder–decoder framework’, *Nature Neuroscience* 2020 23:4, vol. 23, no. 4, pp. 575–582, Mar. 2020, doi: 10.1038/s41593-020-0608-8.
- [84] G. K. Anumanchipalli, J. Chartier, and E. F. Chang, ‘Speech synthesis from neural decoding of spoken sentences’, *Nature* 2019 568:7753, vol. 568, no. 7753, pp. 493–498, Apr. 2019, doi: 10.1038/s41586-019-1119-1.
- [85] M. Yin *et al.*, ‘Wireless Neurosensor for Full-Spectrum Electrophysiology Recordings during Free Behavior’, *Neuron*, vol. 84, no. 6, pp. 1170–1182, Dec. 2014, doi: 10.1016/J.NEURON.2014.11.010.
- [86] E. W. Keefer, B. R. Botterman, M. I. Romero, A. F. Rossi, and G. W. Gross, ‘Carbon nanotube coating improves neuronal recordings’, *Nature Nanotechnology* 2008 3:7, vol. 3, no. 7, pp. 434–439, Jun. 2008, doi: 10.1038/nnano.2008.174.
- [87] J. E. Downey *et al.*, ‘Blending of brain-machine interface and vision-guided autonomous robotics improves neuroprosthetic arm performance during grasping’, *J Neuroeng Rehabil*, vol. 13, no. 1, pp. 1–12, Mar. 2016, doi: 10.1186/S12984-016-0134-9/TABLES/2.
- [88] L. Rejc *et al.*, ‘Longitudinal evaluation of neuroinflammation and oxidative stress in a mouse model of Alzheimer disease using positron emission tomography’, *Alzheimers Res Ther*, vol. 14, no. 1, pp. 1–14, Dec. 2022, doi: 10.1186/S13195-022-01016-5/FIGURES/8.
- [89] T. J. Oxley *et al.*, ‘Motor neuroprosthesis implanted with neurointerventional surgery improves capacity for activities of daily living tasks in severe paralysis: first in-human experience’, *J Neurointerv Surg*, vol. 13, no. 2, pp. 102–108, Feb. 2021, doi: 10.1136/NEURINTSURG-2020-016862.

- [90] T. J. Oxley *et al.*, ‘Minimally invasive endovascular stent-electrode array for high-fidelity, chronic recordings of cortical neural activity’, *Nature Biotechnology* 2016 34:3, vol. 34, no. 3, pp. 320–327, Feb. 2016, doi: 10.1038/nbt.3428.
- [91] R. M. Neely, D. K. Piech, S. R. Santacruz, M. M. Maharbiz, and J. M. Carmena, ‘Recent advances in neural dust: towards a neural interface platform’, *Curr Opin Neurobiol*, vol. 50, pp. 64–71, Jun. 2018, doi: 10.1016/J.CONB.2017.12.010.
- [92] T. Mondal, K. Laursen, S. Hosseini, A. Rashidi, F. Moradi, and B. Corbett, ‘Realization of high efficiency ultrasound-powered micro-LEDs for optogenetics’, <https://doi.org/10.1117/12.2555762>, vol. 11364, pp. 126–133, Apr. 2020, doi: 10.1117/12.2555762.
- [93] A. Rashidi, S. Hosseini, K. Laursen, and F. Moradi, ‘STARDUST: Optogenetics, electrophysiology and pharmacology with an ultrasonically powered DUST for parkinson’s disease’, *2019 26th IEEE International Conference on Electronics, Circuits and Systems, ICECS 2019*, pp. 109–110, Nov. 2019, doi: 10.1109/ICECS46596.2019.8965042.
- [94] K. Laursen, A. Rashidi, S. Hosseini, T. Mondal, B. Corbett, and F. Moradi, ‘Ultrasonically Powered Compact Implantable Dust for Optogenetics’, *IEEE Trans Biomed Circuits Syst*, vol. 14, no. 3, pp. 583–594, Jun. 2020, doi: 10.1109/TBCAS.2020.2984921.
- [95] M. N. Christensen, M. Zamani, A. Rashidi, and F. Moradi, ‘Ultrasonic Backscatter Communication for Brain Implants: Mathematical Model, Simulation, and Measurement’, *BioCAS 2021 - IEEE Biomedical Circuits and Systems Conference, Proceedings, 2021*, doi: 10.1109/BIOCAS49922.2021.9644968.
- [96] S. Hosseini, K. Laursen, A. Rashidi, T. Mondal, B. Corbett, and F. Moradi, ‘S-MRUT: Secteded-Multiring Ultrasonic Transducer for Selective Powering of Brain Implants’, *IEEE Trans Ultrason Ferroelectr Freq Control*, vol. 68, no. 1, pp. 191–200, Jan. 2021, doi: 10.1109/TUFFC.2020.3001084.
- [97] A. Rashidi, K. Laursen, S. Hosseini, H. A. Huynh, and F. Moradi, ‘An Implantable Ultrasonically Powered System for Optogenetic Stimulation with Power-Efficient Active Rectifier and Charge-Reuse Capability’, *IEEE Trans Biomed Circuits Syst*, vol. 13, no. 6, pp. 1362–1371, Dec. 2019, doi: 10.1109/TBCAS.2019.2949154.
- [98] N. A. Steinmetz *et al.*, ‘Neuropixels 2.0: A miniaturized high-density probe for stable, long-term brain recordings’, *Science (1979)*, vol. 372, no. 6539, Apr. 2021, doi: 10.1126/SCIENCE.ABF4588/SUPPL\_FILE/ABF4888\_MDAR\_REPRODUCIBILITY\_CHECKLIST.PDF.
- [99] L. F. Nicolas-Alonso and J. Gomez-Gil, ‘Brain computer interfaces, a review’, *Sensors*, vol. 12, no. 2, pp. 1211–1279, 2012, doi: 10.3390/s120201211.
- [100] A. Segato, A. Marzullo, F. Calimeri, and E. de Momi, ‘Artificial intelligence for brain diseases: A systematic review’, *APL Bioeng*, vol. 4, no. 4, 2020, doi: 10.1063/5.0011697.
- [101] J. Watts, A. Khojandi, O. Shylo, and R. A. Ramdhani, ‘Machine learning’s application in deep brain stimulation for parkinson’s disease: A review’, *Brain Sci*, vol. 10, no. 11, pp. 1–16, Nov. 2020, doi: 10.3390/BRAINSCI10110809.
- [102] J. I. Glaser, A. S. Benjamin, R. H. Chowdhury, M. G. Perich, L. E. Miller, and K. P. Kording, ‘Machine Learning for Neural Decoding’, *eNeuro*, vol. 7, no. 4, pp. 1–16, Jul. 2020, doi: 10.1523/ENEURO.0506-19.2020.
- [103] H. Wen, J. Shi, Y. Zhang, K.-H. Lu, J. Cao, and Z. Liu, ‘Neural Encoding and Decoding with Deep Learning for Dynamic Natural Vision’, *Cerebral Cortex*, vol. 28, pp. 4136–4160, 2018, doi: 10.1093/cercor/bhx268.
- [104] A. Valero-Cabré, J. L. Amengual, C. Stengel, A. Pascual-Leone, and O. A. Coubard, ‘Transcranial magnetic stimulation in basic and clinical neuroscience: A comprehensive review of fundamental principles and novel insights’, *Neurosci Biobehav Rev*, vol. 83, pp. 381–404, Dec. 2017, doi: 10.1016/J.NEUBIOREV.2017.10.006.
- [105] W. Paulus, M. A. Nitsche, and A. Antal, ‘Application of Transcranial Electric Stimulation (tDCS, tACS, tRNS)’, <http://dx.doi.org/10.1027/1016-9040/a000242>, vol. 21, no. 1, pp. 4–14, Mar. 2016, doi: 10.1027/1016-9040/A000242.
- [106] W. Legon *et al.*, ‘Transcranial focused ultrasound modulates the activity of primary somatosensory cortex in humans’, *Nature Neuroscience* 2013 17:2, vol. 17, no. 2, pp. 322–329, Jan. 2014, doi: 10.1038/nn.3620.
- [107] E. Zrenner, ‘Will retinal implants restore vision?’, *Science (1979)*, vol. 295, no. 5557, pp. 1022–1025, Feb. 2002, doi: 10.1126/SCIENCE.1067996/ASSET/536722EB-3EAD-4368-8969-A46F209B4E48/ASSETS/GRAPHIC/SE0520182003.JPEG.
- [108] V. Busskamp *et al.*, ‘Genetic reactivation of cone photoreceptors restores visual responses in retinitis pigmentosa’, *Science (1979)*, vol. 329, no. 5990, pp. 413–417, Jul. 2010, doi: 10.1126/SCIENCE.1190897/SUPPL\_FILE/BUSSKAMP.SOM.PDF.
- [109] Second Sight, ‘Argus II: the life-changing retinitis pigmentosa treatment.’, 2022. <https://secondsight.com/discover-argus/> (accessed Jun. 20, 2022).
- [110] V. Mendez, F. Iberite, S. Shokur, and S. Micera, ‘Annual Review of Control, Robotics, and Autonomous Systems Current Solutions and Future Trends for Robotic Prosthetic Hands Neuroprosthesis: a device that connects to the



- nervous system and either replaces missing parts of it or improves it', *Annu. Rev. Control Robot. Auton. Syst.*, vol. 4, pp. 595–627, 2021, doi: 10.1146/annurev-control-071020.
- [111] B. T. Nghiem *et al.*, 'Providing a Sense of Touch to Prosthetic Hands', *Plast Reconstr Surg*, vol. 135, no. 6, pp. 1652–1663, Jun. 2015, doi: 10.1097/PRS.0000000000001289.
- [112] R. Vallejo, K. Bradley, and L. Kapural, 'Spinal Cord Stimulation in Chronic Pain', *Spine (Phila Pa 1976)*, vol. 42, pp. S53–S60, Jul. 2017, doi: 10.1097/BRS.0000000000002179.
- [113] B. Lundeland, M. Toennis, M. Züchner, L. Janerås, A. Stubhaug, and P. Hansson, 'Spinal cord stimulation for the treatment of peripheral neuropathic pain', *Tidsskrift for Den norske legeförening*, vol. 141, no. 9, Jun. 2021, doi: 10.4045/TIDSSKR.20.1010.
- [114] S. Moeller, T. Crape, L. Chang, and D. Y. Tsao, 'The effect of face patch microstimulation on perception of faces and objects', *Nat Neurosci*, vol. 20, no. 5, pp. 743–752, May 2017, doi: 10.1038/NN.4527.
- [115] P. Mégevand *et al.*, 'Seeing scenes: topographic visual hallucinations evoked by direct electrical stimulation of the parahippocampal place area', *J Neurosci*, vol. 34, no. 16, pp. 5399–5405, 2014, doi: 10.1523/JNEUROSCI.5202-13.2014.
- [116] G. A. Tabot *et al.*, 'Restoring the sense of touch with a prosthetic hand through a brain interface', *Proc Natl Acad Sci U S A*, vol. 110, no. 45, pp. 18279–18284, Nov. 2013, doi: 10.1073/PNAS.1221113110/-DCSUPPLEMENTAL/PNAS.201221113SI.PDF.
- [117] M. Figeé *et al.*, 'Deep brain stimulation restores frontostriatal network activity in obsessive-compulsive disorder', *Nature Neuroscience* 2013 16:4, vol. 16, no. 4, pp. 386–387, Feb. 2013, doi: 10.1038/nn.3344.
- [118] K. Deisseroth, 'Optogenetics', *Nature Methods* 2011 8:1, vol. 8, no. 1, pp. 26–29, Dec. 2010, doi: 10.1038/nmeth.f.324.
- [119] V. Gradinaru, M. Mogri, K. R. Thompson, J. M. Henderson, and K. Deisseroth, 'Optical deconstruction of parkinsonian neural circuitry', *Science (1979)*, vol. 324, no. 5925, pp. 354–359, Apr. 2009, doi: 10.1126/SCIENCE.1167093/SUPPL\_FILE/GRADINARU.SOM.PDF.
- [120] S. A. Guillory and K. A. Bujarski, 'Exploring emotions using invasive methods: review of 60 years of human intracranial electrophysiology', *Soc Cogn Affect Neurosci*, vol. 9, no. 12, pp. 1880–1889, Dec. 2014, doi: 10.1093/SCAN/NSU002.
- [121] W. Han *et al.*, 'Integrated Control of Predatory Hunting by the Central Nucleus of the Amygdala', *Cell*, vol. 168, no. 1–2, pp. 311–324.e18, Jan. 2017, doi: 10.1016/J.CELL.2016.12.027.
- [122] C. A. Zimmerman *et al.*, 'Thirst neurons anticipate the homeostatic consequences of eating and drinking', *Nature* 2016 537:7622, vol. 537, no. 7622, pp. 680–684, Aug. 2016, doi: 10.1038/nature18950.
- [123] Y. Ezzayat *et al.*, 'Closed-loop stimulation of temporal cortex rescues functional networks and improves memory', *Nature Communications* 2018 9:1, vol. 9, no. 1, pp. 1–8, Feb. 2018, doi: 10.1038/s41467-017-02753-0.
- [124] J. Dai, D. I. Brooks, and D. L. Sheinberg, 'Optogenetic and Electrical Microstimulation Systematically Bias Visuospatial Choice in Primates', *Current Biology*, vol. 24, no. 1, pp. 63–69, Jan. 2014, doi: 10.1016/J.CUB.2013.11.011.
- [125] R. J. Krauzlis, L. P. Lovejoy, and A. Zénon, 'Superior Colliculus and Visual Spatial Attention', *Annu Rev Neurosci*, vol. 36, pp. 165–182, Jul. 2013, doi: 10.1146/ANNUREV-NEURO-062012-170249.
- [126] J. Jacobs *et al.*, 'Direct Electrical Stimulation of the Human Entorhinal Region and Hippocampus Impairs Memory', *Neuron*, vol. 92, no. 5, pp. 983–990, Dec. 2016, doi: 10.1016/J.NEURON.2016.10.062.
- [127] N. Lipsman *et al.*, 'Deep brain stimulation of the subcallosal cingulate for treatment-refractory anorexia nervosa: 1 year follow-up of an open-label trial', *Lancet Psychiatry*, vol. 4, no. 4, pp. 285–294, Apr. 2017, doi: 10.1016/S2215-0366(17)30076-7.
- [128] H. C. Tsai *et al.*, 'Phasic firing in dopaminergic neurons is sufficient for behavioral conditioning', *Science (1979)*, vol. 324, no. 5930, pp. 1080–1084, May 2009, doi: 10.1126/SCIENCE.1168878/SUPPL\_FILE/TSAI.SOM.REV1.PDF.
- [129] C. D. Proulx, O. Hikosaka, and R. Malinow, 'Reward processing by the lateral habenula in normal and depressive behaviors', *Nature Neuroscience* 2014 17:9, vol. 17, no. 9, pp. 1146–1152, Aug. 2014, doi: 10.1038/nn.3779.
- [130] S. N. Flesher *et al.*, 'Intracortical microstimulation of human somatosensory cortex', *Sci Transl Med*, vol. 8, no. 361, Oct. 2016, doi: 10.1126/SCITRANSLMED.AAF8083/SUPPL\_FILE/8-361RA141\_SM.PDF.
- [131] 'Home - Neuralink'. <https://neuralink.com/> (accessed Sep. 21, 2022).
- [132] 'Paradromics'. <https://www.paradromics.com/> (accessed Sep. 21, 2022).
- [133] 'Synchron | Unlocking the natural highways of the brain.' <https://synchron.com/> (accessed Sep. 21, 2022).
- [134] 'Blackrock Neurotech - Blackrock Neurotech'. <https://blackrockneurotech.com/> (accessed Sep. 21, 2022).
- [135] 'Neurable'. <https://neurable.com/> (accessed Sep. 21, 2022).
- [136] 'Thync | Neurostimulation For Everyone – Thync Global, Inc.' <https://thync.com/> (accessed Sep. 21, 2022).
- [137] 'Spinal Cord Stimulation Systems | Medtronic'. <https://europe.medtronic.com/xd-en/healthcare-professionals/products/neurological/spinal-cord-stimulation-systems.html> (accessed Sep. 21, 2022).

- [138] 'kernel | Home'. <https://www.kernel.com/> (accessed Sep. 21, 2022).
- [139] 'NeuroPace | A Smarter Way to Treat Epilepsy'. <https://neuropace.com/> (accessed Sep. 21, 2022).
- [140] B. Jarosiewicz and M. Morrell, 'The RNS System: brain-responsive neurostimulation for the treatment of epilepsy', <https://doi.org/10.1080/17434440.2019.1683445>, vol. 18, no. 2, pp. 129–138, 2020, doi: 10.1080/17434440.2019.1683445.
- [141] S. Stanslaski *et al.*, 'A Chronically Implantable Neural Coprocessor for Investigating the Treatment of Neurological Disorders', *IEEE Trans Biomed Circuits Syst*, vol. 12, no. 6, pp. 1230–1245, Dec. 2018, doi: 10.1109/TBCAS.2018.2880148.
- [142] E. Musk and Neuralink, 'An Integrated Brain-Machine Interface Platform With Thousands of Channels', *J Med Internet Res* 2019;21(10):e16194 <https://www.jmir.org/2019/10/e16194>, vol. 21, no. 10, p. e16194, Oct. 2019, doi: 10.2196/16194.
- [143] K. J. Miller, D. Hermes, and N. P. Staff, 'The current state of electrocorticography-based brain-computer interfaces', *Neurosurg Focus*, vol. 49, no. 1, p. E2, Jul. 2020, doi: 10.3171/2020.4.FOCUS20185.
- [144] S. Soldozy *et al.*, 'A systematic review of endovascular stent-electrode arrays, a minimally invasive approach to brain-machine interfaces', *Neurosurg Focus*, vol. 49, no. 1, p. E3, Jul. 2020, doi: 10.3171/2020.4.FOCUS20186.
- [145] A. S. Gogia *et al.*, 'Gamma-band modulation in the human amygdala during reaching movements', *Neurosurg Focus*, vol. 49, no. 1, p. E4, Jul. 2020, doi: 10.3171/2020.4.FOCUS20179.
- [146] J. B. Price *et al.*, 'Clinical applications of neurochemical and electrophysiological measurements for closed-loop neurostimulation', *Neurosurg Focus*, vol. 49, no. 1, p. E6, Jul. 2020, doi: 10.3171/2020.4.FOCUS20167.
- [147] V. T. Lehman *et al.*, 'MRI and tractography techniques to localize the ventral intermediate nucleus and dentatorubrothalamic tract for deep brain stimulation and MR-guided focused ultrasound: a narrative review and update', *Neurosurg Focus*, vol. 49, no. 1, p. E8, Jul. 2020, doi: 10.3171/2020.4.FOCUS20170.
- [148] Y. Wang *et al.*, 'Habenula deep brain stimulation for intractable schizophrenia: a pilot study', *Neurosurg Focus*, vol. 49, no. 1, p. E9, Jul. 2020, doi: 10.3171/2020.4.FOCUS20174.
- [149] C. Baek *et al.*, 'Investigation of stereotactic surgery for avian brain stimulation by a fully implanted wireless system', *Neurosurg Focus*, vol. 49, no. 1, p. E10, Jul. 2020, doi: 10.3171/2020.4.FOCUS2025.
- [150] C. S. Koh *et al.*, 'A novel rat robot controlled by electrical stimulation of the nigrostriatal pathway', *Neurosurg Focus*, vol. 49, no. 1, p. E11, Jul. 2020, doi: 10.3171/2020.4.FOCUS20150.
- [151] B. Kotchoubey, S. Busch, U. Strehl, and N. Birbaumer, 'Changes in EEG Power Spectra During Biofeedback of Slow Cortical Potentials in Epilepsy', *Applied Psychophysiology and Biofeedback* 1999 24:4, vol. 24, no. 4, pp. 213–233, 1999, doi: 10.1023/A:1022226412991.
- [152] Y. Yu, Y. Liu, J. Jiang, E. Yin, Z. Zhou, and D. Hu, 'An Asynchronous Control Paradigm Based on Sequential Motor Imagery and Its Application in Wheelchair Navigation', *IEEE Transactions on Neural Systems and Rehabilitation Engineering*, vol. 26, no. 12, pp. 2367–2375, Dec. 2018, doi: 10.1109/TNSRE.2018.2881215.
- [153] H. Cecotti, 'Adaptive Time Segment Analysis for Steady-State Visual Evoked Potential Based Brain-Computer Interfaces', *IEEE Transactions on Neural Systems and Rehabilitation Engineering*, vol. 28, no. 3, pp. 552–560, Mar. 2020, doi: 10.1109/TNSRE.2020.2968307.
- [154] L. Kros *et al.*, 'Cerebellar output controls generalized spike-and-wave discharge occurrence', *Ann Neurol*, vol. 77, no. 6, pp. 1027–1049, Jun. 2015, doi: 10.1002/ANA.24399.
- [155] J. P. Nguyen, J. Nizard, Y. Keravel, and J. P. Lefaucheur, 'Invasive brain stimulation for the treatment of neuropathic pain', *Nature Reviews Neurology* 2011 7:12, vol. 7, no. 12, pp. 699–709, Sep. 2011, doi: 10.1038/nrneuro.2011.138.
- [156] I. O. Bergfeld *et al.*, 'Deep Brain Stimulation of the Ventral Anterior Limb of the Internal Capsule for Treatment-Resistant Depression: A Randomized Clinical Trial', *JAMA Psychiatry*, vol. 73, no. 5, pp. 456–464, May 2016, doi: 10.1001/JAMAPSYCHIATRY.2016.0152.
- [157] H. S. Mayberg *et al.*, 'Deep Brain Stimulation for Treatment-Resistant Depression', *Neuron*, vol. 45, no. 5, pp. 651–660, Mar. 2005, doi: 10.1016/J.NEURON.2005.02.014.
- [158] F. Munoz, C. Aurup, E. E. Konofagou, and V. P. Ferrera, 'Modulation of Brain Function and Behavior by Focused Ultrasound', *Curr Behav Neurosci Rep*, vol. 5, no. 2, pp. 153–164, Jun. 2018, doi: 10.1007/S40473-018-0156-7/TABLES/1.
- [159] X. Hong *et al.*, 'Brain plasticity following MI-BCI training combined with tDCS in a randomized trial in chronic subcortical stroke subjects: a preliminary study', *Scientific Reports* 2017 7:1, vol. 7, no. 1, pp. 1–12, Aug. 2017, doi: 10.1038/s41598-017-08928-5.
- [160] B. S. Baxter, B. J. Edelman, A. Sohrabpour, and B. He, 'Anodal transcranial direct current stimulation increases bilateral directed brain connectivity during motor-imagery based brain-computer interface control', *Front Neurosci*, vol. 11, no. DEC, p. 691, Dec. 2017, doi: 10.3389/FNINS.2017.00691/BIBTEX.
- [161] R. P. N. Rao *et al.*, 'A Direct Brain-to-Brain Interface in Humans', *PLoS One*, vol. 9, no. 11, p. e111332, Nov. 2014, doi: 10.1371/JOURNAL.PONE.0111332.

- [162] C. Grau *et al.*, ‘Conscious Brain-to-Brain Communication in Humans Using Non-Invasive Technologies’, *Brain Stimulation: Basic, Translational, and Clinical Research in Neuromodulation*, vol. 8, no. 2, p. 323, Mar. 2015, doi: 10.1016/J.BRS.2015.01.047.
- [163] V. Walsh and A. Cowey, ‘Transcranial magnetic stimulation and cognitive neuroscience’, *Nature Reviews Neuroscience* 2000 1:1, vol. 1, no. 1, pp. 73–80, 2000, doi: 10.1038/35036239.
- [164] N. Schaworonkow, J. Triesch, U. Ziemann, and C. Zrenner, ‘EEG-triggered TMS reveals stronger brain state-dependent modulation of motor evoked potentials at weaker stimulation intensities’, *Brain Stimul*, vol. 12, no. 1, pp. 110–118, Jan. 2019, doi: 10.1016/J.BRS.2018.09.009.
- [165] J. Jin, Z. Chen, R. Xu, Y. Miao, X. Wang, and T. P. Jung, ‘Developing a Novel Tactile P300 Brain-Computer Interface with a Cheeks-Stim Paradigm’, *IEEE Trans Biomed Eng*, vol. 67, no. 9, pp. 2585–2593, Sep. 2020, doi: 10.1109/TBME.2020.2965178.
- [166] C. S. Wei, Y. te Wang, C. T. Lin, and T. P. Jung, ‘Toward Drowsiness Detection Using Non-hair-Bearing EEG-Based Brain-Computer Interfaces’, *IEEE Transactions on Neural Systems and Rehabilitation Engineering*, vol. 26, no. 2, pp. 400–406, Feb. 2018, doi: 10.1109/TNSRE.2018.2790359.
- [167] V. Guy, M. H. Soriani, M. Bruno, T. Papadopoulo, C. Desnuelle, and M. Clerc, ‘Brain computer interface with the P300 speller: Usability for disabled people with amyotrophic lateral sclerosis’, *Ann Phys Rehabil Med*, vol. 61, no. 1, pp. 5–11, Jan. 2018, doi: 10.1016/J.REHAB.2017.09.004.
- [168] L. Botrel, E. M. Holz, and A. Kübler, ‘Brain Painting V2: evaluation of P300-based brain-computer interface for creative expression by an end-user following the user-centered design’, <https://doi.org/10.1080/2326263X.2015.1100038>, vol. 2, no. 2–3, pp. 135–149, Apr. 2015, doi: 10.1080/2326263X.2015.1100038.
- [169] R. E. Alcaide-Aguirre, S. A. Warschawsky, D. Brown, A. Aref, and J. E. Huggins, ‘Asynchronous brain-computer interface for cognitive assessment in people with cerebral palsy’, *J Neural Eng*, vol. 14, no. 6, p. 066001, Oct. 2017, doi: 10.1088/1741-2552/AA7FC4.
- [170] L. A. Farwell, D. C. Richardson, G. M. Richardson, and J. J. Furedy, ‘Brain fingerprinting concealed information test detects US Navy military medical information with P300’, *Front Neurosci*, vol. 8, no. DEC, p. 410, 2014, doi: 10.3389/FNINS.2014.00410/BIBTEX.
- [171] I. Iturrate, J. M. Antelis, A. Kübler, and J. Minguez, ‘A noninvasive brain-actuated wheelchair based on a P300 neurophysiological protocol and automated navigation’, *IEEE Transactions on Robotics*, vol. 25, no. 3, pp. 614–627, 2009, doi: 10.1109/TRO.2009.2020347.
- [172] K. Kasahara, C. S. DaSalla, M. Honda, and T. Hanakawa, ‘Neuroanatomical correlates of brain-computer interface performance’, *Neuroimage*, vol. 110, pp. 95–100, Apr. 2015, doi: 10.1016/J.NEUROIMAGE.2015.01.055.
- [173] A. Ramos-Murguialday *et al.*, ‘Brain-machine interface in chronic stroke rehabilitation: A controlled study’, *Ann Neurol*, vol. 74, no. 1, pp. 100–108, Jul. 2013, doi: 10.1002/ANA.23879.
- [174] S. Darvishi, A. Gharabaghi, C. B. Boulay, M. C. Ridding, D. Abbott, and M. Baumert, ‘Proprioceptive feedback facilitates motor imagery-related operant learning of sensorimotor  $\beta$ -band modulation’, *Front Neurosci*, vol. 11, no. FEB, p. 60, Feb. 2017, doi: 10.3389/FNINS.2017.00060/BIBTEX.
- [175] Y. M. Chi, Y. te Wang, Y. Wang, C. Maier, T. P. Jung, and G. Cauwenberghs, ‘Dry and noncontact EEG sensors for mobile brain-computer interfaces’, *IEEE Transactions on Neural Systems and Rehabilitation Engineering*, vol. 20, no. 2, pp. 228–235, Mar. 2012, doi: 10.1109/TNSRE.2011.2174652.
- [176] X. Zhao, Y. Chu, J. Han, and Z. Zhang, ‘SSVEP-Based Brain-Computer Interface Controlled Functional Electrical Stimulation System for Upper Extremity Rehabilitation’, *IEEE Trans Syst Man Cybern Syst*, vol. 46, no. 7, pp. 947–956, Jul. 2016, doi: 10.1109/TSMC.2016.2523762.
- [177] M. van Vliet, A. Robben, N. Chumerin, N. v. Manyakov, A. Combaz, and M. M. van Hulle, ‘Designing a brain-computer interface controlled video-game using consumer grade EEG hardware’, *2012 ISSNIP Biosignals and Biorobotics Conference: Biosignals and Robotics for Better and Safer Living, BRC 2012*, 2012, doi: 10.1109/BRC.2012.6222186.
- [178] J. J. S. Norton *et al.*, ‘Soft, curved electrode systems capable of integration on the auricle as a persistent brain-computer interface’, *Proc Natl Acad Sci U S A*, vol. 112, no. 13, pp. 3920–3925, Mar. 2015, doi: 10.1073/PNAS.1424875112.
- [179] Y. Petrov, J. Nador, C. Hughes, S. Tran, O. Yavuzcetin, and S. Sridhar, ‘Ultra-dense EEG sampling results in two-fold increase of functional brain information’, *Neuroimage*, vol. 90, pp. 140–145, Apr. 2014, doi: 10.1016/J.NEUROIMAGE.2013.12.041.
- [180] D. Silver *et al.*, ‘Mastering the game of Go without human knowledge’, *Nature* 2017 550:7676, vol. 550, no. 7676, pp. 354–359, Oct. 2017, doi: 10.1038/nature24270.

- [181] N. R. B. Martins, W. Erlhagen, and R. A. Freitas, Jr., ‘Human Connectome Mapping and Monitoring Using Neuronanorobots’, *Journal of Ethics and Emerging Technologies*, vol. 26, no. 1, pp. 1–25, Jan. 2016, doi: 10.55613/jeet.v26i1.49.
- [182] N. R. B. Martins *et al.*, ‘Human brain/cloud interface’, *Front Neurosci*, vol. 13, no. March, 2019, doi: 10.3389/fnins.2019.00112.
- [183] D. D. Cox and T. Dean, ‘Neural Networks and Neuroscience-Inspired Computer Vision’, *Current Biology*, vol. 24, no. 18, pp. R921–R929, Sep. 2014, doi: 10.1016/J.CUB.2014.08.026.
- [184] S. L. Jackman and W. G. Regehr, ‘The Mechanisms and Functions of Synaptic Facilitation’, *Neuron*, vol. 94, no. 3, pp. 447–464, May 2017, doi: 10.1016/J.NEURON.2017.02.047.
- [185] J. J. Moore *et al.*, ‘Dynamics of cortical dendritic membrane potential and spikes in freely behaving rats’, *Science (1979)*, vol. 355, no. 6331, Mar. 2017, doi: 10.1126/SCIENCE.AAJ1497.
- [186] S. Venkataramani, K. Roy, and A. Raghunathan, ‘Efficient embedded learning for IoT devices’, *Proceedings of the Asia and South Pacific Design Automation Conference, ASP-DAC*, vol. 25-28-January-2016, pp. 308–311, Mar. 2016, doi: 10.1109/ASPDAC.2016.7428029.
- [187] C. Mead, ‘How we created neuromorphic engineering’, *Nature Electronics 2020 3:7*, vol. 3, no. 7, pp. 434–435, Jul. 2020, doi: 10.1038/s41928-020-0448-2.
- [188] V. Sze, Y. H. Chen, J. Einer, A. Suleiman, and Z. Zhang, ‘Hardware for machine learning: Challenges and opportunities’, *Proceedings of the Custom Integrated Circuits Conference*, vol. 2017-April, Jul. 2017, doi: 10.1109/CICC.2017.7993626.
- [189] C. Mayr, S. Höppner, and S. Furber, ‘SpiNNaker 2: A 10 Million Core Processor System for Brain Simulation and Machine Learning’, *Concurrent Systems Engineering Series*, vol. 70, pp. 277–280, Nov. 2019, doi: 10.48550/arxiv.1911.02385.
- [190] S. B. Furber, F. Galluppi, S. Temple, and L. A. Plana, ‘The SpiNNaker project’, *Proceedings of the IEEE*, vol. 102, no. 5, pp. 652–665, 2014, doi: 10.1109/JPROC.2014.2304638.
- [191] M. Davies *et al.*, ‘Loihi: A Neuromorphic Manycore Processor with On-Chip Learning’, *IEEE Micro*, vol. 38, no. 1, pp. 82–99, Jan. 2018, doi: 10.1109/MM.2018.112130359.
- [192] H. Mostafa, L. K. Müller, and G. Indiveri, ‘An event-based architecture for solving constraint satisfaction problems’, *Nature Communications 2015 6:1*, vol. 6, no. 1, pp. 1–10, Dec. 2015, doi: 10.1038/ncomms9941.
- [193] P. A. Merolla *et al.*, ‘A million spiking-neuron integrated circuit with a scalable communication network and interface’, *Science (1979)*, vol. 345, no. 6197, pp. 668–673, Aug. 2014, doi: 10.1126/SCIENCE.1254642/SUPPL\_FILE/MEROLLA.SM.REV1.PDF.
- [194] J. Schemmel, D. Brüderle, A. Grübl, M. Hock, K. Meier, and S. Millner, ‘A wafer-scale neuromorphic hardware system for large-scale neural modeling’, *ISCAS 2010 - 2010 IEEE International Symposium on Circuits and Systems: Nano-Bio Circuit Fabrics and Systems*, pp. 1947–1950, 2010, doi: 10.1109/ISCAS.2010.5536970.
- [195] J. Schemmel, S. Billaudelle, P. Dauer, and J. Weis, ‘Accelerated Analog Neuromorphic Computing’, *Analog Circuits for Machine Learning, Current/Voltage/Temperature Sensors, and High-speed Communication*, pp. 83–102, 2022, doi: 10.1007/978-3-030-91741-8\_6/FIGURES/12.
- [196] B. V. Benjamin *et al.*, ‘Neurogrid: A mixed-analog-digital multichip system for large-scale neural simulations’, *Proceedings of the IEEE*, vol. 102, no. 5, pp. 699–716, 2014, doi: 10.1109/JPROC.2014.2313565.
- [197] C. S. Thakur *et al.*, ‘Large-Scale Neuromorphic Spiking Array Processors: A Quest to Mimic the Brain’, *Frontiers in Neuroscience*, vol. 12, Frontiers Media S.A., Dec. 03, 2018, doi: 10.3389/fnins.2018.00891.
- [198] S. Moradi, N. Qiao, F. Stefanini, and G. Indiveri, ‘A Scalable Multicore Architecture with Heterogeneous Memory Structures for Dynamic Neuromorphic Asynchronous Processors (DYNAPs)’, *IEEE Trans Biomed Circuits Syst*, vol. 12, no. 1, pp. 106–122, Feb. 2018, doi: 10.1109/TBCAS.2017.2759700.
- [199] P. Blouw, X. Choo, E. Hunsberger, and C. Eliasmith, ‘Benchmarking keyword spotting efficiency on neuromorphic hardware’, *ACM International Conference Proceeding Series*, vol. 19, Mar. 2019, doi: 10.1145/3320288.3320304.
- [200] N. Getty, T. Brettin, D. Jin, R. Stevens, and F. Xia, ‘Deep medical image analysis with representation learning and neuromorphic computing’, *Interface Focus*, vol. 11, no. 1, Feb. 2021, doi: 10.1098/RSFS.2019.0122.
- [201] T. Potok, C. Schuman, R. Patton, T. Hylton, H. Li, and R. Pino, ‘Neuromorphic Computing, Architectures, Models, and Applications. A Beyond-CMOS Approach to Future Computing, June 29-July 1, 2016, Oak Ridge, TN’, Dec. 2016, doi: 10.2172/1341738.
- [202] J. Pei *et al.*, ‘Towards artificial general intelligence with hybrid Tianjic chip architecture’, *Nature 2019 572:7767*, vol. 572, no. 7767, pp. 106–111, Jul. 2019, doi: 10.1038/s41586-019-1424-8.
- [203] C. D. Schuman *et al.*, ‘A Survey of Neuromorphic Computing and Neural Networks in Hardware’, May 2017, doi: 10.48550/arxiv.1705.06963.

- [204] ‘Training a single AI model can emit as much carbon as five cars in their lifetimes | MIT Technology Review’. <https://www.technologyreview.com/2019/06/06/239031/training-a-single-ai-model-can-emit-as-much-carbon-as-five-cars-in-their-lifetimes/> (accessed Sep. 23, 2022).
- [205] J. Kim *et al.*, ‘Spin-based computing: Device concepts, current status, and a case study on a high-performance microprocessor’, *Proceedings of the IEEE*, vol. 103, no. 1, pp. 106–130, Jan. 2015, doi: 10.1109/JPROC.2014.2361767.
- [206] Y. Li, Z. Wang, R. Midya, Q. Xia, and J. Joshua Yang, ‘Review of memristor devices in neuromorphic computing: materials sciences and device challenges’, *J Phys D Appl Phys*, vol. 51, no. 50, p. 503002, Sep. 2018, doi: 10.1088/1361-6463/AADE3F.
- [207] H. Ghanatian, M. Ronchini, H. Farkhani, and F. Moradi, ‘STDP implementation using multi-state spin-orbit torque synapse’, *Semicond Sci Technol*, vol. 37, no. 2, p. 024004, Dec. 2021, doi: 10.1088/1361-6641/AC419C.
- [208] H. Farkhani, M. Tohidi, S. Farkhani, J. K. Madsen, and F. Moradi, ‘A Low-Power High-Speed Spintronics-Based Neuromorphic Computing System Using Real-Time Tracking Method’, *IEEE J Emerg Sel Top Circuits Syst*, vol. 8, no. 3, pp. 627–638, Sep. 2018, doi: 10.1109/JETCAS.2018.2813389.
- [209] H. Farkhani, I. L. Prejbeanu, and F. Moradi, ‘LAS-NCS: A laser-assisted spintronic neuromorphic computing system’, *IEEE Transactions on Circuits and Systems II: Express Briefs*, vol. 66, no. 5, pp. 838–842, May 2019, doi: 10.1109/TCSII.2019.2908077.
- [210] J. Torrejon *et al.*, ‘Neuromorphic computing with nanoscale spintronic oscillators’, *Nature* 2017 547:7664, vol. 547, no. 7664, pp. 428–431, Jul. 2017, doi: 10.1038/nature23011.
- [211] H. Farkhani *et al.*, ‘LAO-NCS: Laser Assisted Spin Torque Nano Oscillator-Based Neuromorphic Computing System’, *Front Neurosci*, vol. 13, p. 1429, Jan. 2020, doi: 10.3389/FNINS.2019.01429/BIBTEX.
- [212] F. Moradi *et al.*, ‘Spin-Orbit-Torque-based Devices, Circuits and Architectures’, Dec. 2019, doi: 10.48550/arxiv.1912.01347.
- [213] M. Zahedinejad *et al.*, ‘Two-dimensional mutually synchronized spin Hall nano-oscillator arrays for neuromorphic computing’, *Nature Nanotechnology* 2019 15:1, vol. 15, no. 1, pp. 47–52, Dec. 2019, doi: 10.1038/s41565-019-0593-9.
- [214] J. S. Najem *et al.*, ‘Memristive Ion Channel-Doped Biomembranes as Synaptic Mimics’, *ACS Nano*, vol. 12, no. 5, pp. 4702–4711, May 2018, doi: 10.1021/ACS.NANO.8B01282/ASSET/IMAGES/LARGE/NN-2018-01282F\_0005.JPEG.
- [215] R. Islam *et al.*, ‘Device and materials requirements for neuromorphic computing’, *J Phys D Appl Phys*, vol. 52, no. 11, p. 113001, Jan. 2019, doi: 10.1088/1361-6463/AAF784.
- [216] S. H. Jo, T. Chang, I. Ebgong, B. B. Bhadviya, P. Mazumder, and W. Lu, ‘Nanoscale memristor device as synapse in neuromorphic systems’, *Nano Lett*, vol. 10, no. 4, pp. 1297–1301, Apr. 2010, doi: 10.1021/NL904092H/SUPPL\_FILE/NL904092H\_SI\_001.PDF.
- [217] W. Maass, ‘Networks of Spiking Neurons: The Third Generation of Neural Network Models’, *Neural Networks*, vol. 10, no. 9, pp. 1659–1671, Dec. 1997, doi: 10.1016/S0893-6080(97)00011-7.
- [218] M. Abeles, H. Bergman, E. Margalit, and E. Vaadia, ‘Spatiotemporal firing patterns in the frontal cortex of behaving monkeys’, <https://doi.org/10.1152/jn.1993.70.4.1629>, vol. 70, no. 4, pp. 1629–1638, 1993, doi: 10.1152/JN.1993.70.4.1629.
- [219] N. K. Kasabov, ‘Time-Space, Spiking Neural Networks and Brain-Inspired Artificial Intelligence’, vol. 7, 2019, doi: 10.1007/978-3-662-57715-8.
- [220] L. Deng *et al.*, ‘Rethinking the performance comparison between SNNs and ANNs’, *Neural Networks*, vol. 121, pp. 294–307, Jan. 2020, doi: 10.1016/J.NEUNET.2019.09.005.
- [221] W. Gerstner and W. M. Kistler, ‘Spiking Neuron Models’, *Spiking Neuron Models*, Aug. 2002, doi: 10.1017/CBO9780511815706.
- [222] A. L. Hodgkin and A. F. Huxley, ‘A quantitative description of membrane current and its application to conduction and excitation in nerve’, *J Physiol*, vol. 117, no. 4, p. 500, Aug. 1952, doi: 10.1113/JPHYSIOL.1952.SP004764.
- [223] E. M. Izhikevich, ‘Simple model of spiking neurons’, *IEEE Trans Neural Netw*, vol. 14, no. 6, pp. 1569–1572, Nov. 2003, doi: 10.1109/TNN.2003.820440.
- [224] W. E. Sherwood, ‘FitzHugh-Nagumo Model’, doi: 10.1007/978-1-4614-7320-6\_147-1.
- [225] D. O. Hebb, ‘The Organization of Behavior: A Neuropsychological Theory’, *The Organization of Behavior*, Apr. 2005, doi: 10.4324/9781410612403.
- [226] F. Walter, F. Röhrbein, A. Knoll, and B. Florian Walter, ‘Computation by Time’, *Neural Process Lett*, vol. 44, pp. 103–124, 2016, doi: 10.1007/s11063-015-9478-6.
- [227] B. Petro, N. Kasabov, and R. M. Kiss, ‘Selection and Optimization of Temporal Spike Encoding Methods for Spiking Neural Networks’, *IEEE Trans Neural Netw Learn Syst*, vol. 31, no. 2, pp. 358–370, Feb. 2020, doi: 10.1109/TNNLS.2019.2906158.

- [228] W. S. McCulloch and W. Pitts, 'A logical calculus of the ideas immanent in nervous activity', *The bulletin of mathematical biophysics* 1943 5:4, vol. 5, no. 4, pp. 115–133, Dec. 1943, doi: 10.1007/BF02478259.
- [229] L. F. Abbott and S. B. Nelson, 'Synaptic plasticity: taming the beast', *Nature Neuroscience* 2000 3:11, vol. 3, no. 11, pp. 1178–1183, 2000, doi: 10.1038/81453.
- [230] P. U. Diehl, G. Zarrella, A. Cassidy, B. U. Pedroni, and E. Neftci, 'Conversion of artificial recurrent neural networks to spiking neural networks for low-power neuromorphic hardware', *2016 IEEE International Conference on Rebooting Computing, ICRC 2016 - Conference Proceedings*, Nov. 2016, doi: 10.1109/ICRC.2016.7738691.
- [231] B. Rueckauer, I. A. Lungu, Y. Hu, M. Pfeiffer, and S. C. Liu, 'Conversion of continuous-valued deep networks to efficient event-driven networks for image classification', *Front Neurosci*, vol. 11, no. DEC, p. 682, Dec. 2017, doi: 10.3389/FNINS.2017.00682/BIBTEX.
- [232] A. Sengupta, Y. Ye, R. Wang, C. Liu, and K. Roy, 'Going Deeper in Spiking Neural Networks: VGG and Residual Architectures', *Front Neurosci*, vol. 13, p. 95, Mar. 2019, doi: 10.3389/FNINS.2019.00095/BIBTEX.
- [233] P. U. Diehl, D. Neil, J. Binas, M. Cook, S. C. Liu, and M. Pfeiffer, 'Fast-classifying, high-accuracy spiking deep networks through weight and threshold balancing', *Proceedings of the International Joint Conference on Neural Networks*, vol. 2015-September, Sep. 2015, doi: 10.1109/IJCNN.2015.7280696.
- [234] M. Abadi *et al.*, 'TensorFlow: A system for large-scale machine learning', 2016, Accessed: Jun. 13, 2022. [Online]. Available: <https://tensorflow.org>.
- [235] Y. Cao, Y. Chen, and D. Khosla, 'Spiking Deep Convolutional Neural Networks for Energy-Efficient Object Recognition', *Int J Comput Vis*, vol. 113, no. 1, pp. 54–66, May 2015, doi: 10.1007/S11263-014-0788-3/TABLES/9.
- [236] M. Pfeiffer and T. Pfeil, 'Deep Learning With Spiking Neurons: Opportunities and Challenges', *Front Neurosci*, vol. 12, p. 774, Oct. 2018, doi: 10.3389/FNINS.2018.00774/BIBTEX.
- [237] C. Stöckl and W. Maass, 'Optimized spiking neurons can classify images with high accuracy through temporal coding with two spikes', *Nature Machine Intelligence* 2021 3:3, vol. 3, no. 3, pp. 230–238, Mar. 2021, doi: 10.1038/s42256-021-00311-4.
- [238] R. Shukla, M. Lipasti, B. van Essen, A. Moody, and N. Maruyama, 'Remodel: Rethinking deep CNN models to detect and count on a neurosynaptic system', *Front Neurosci*, vol. 13, no. FEB, p. 4, 2019, doi: 10.3389/FNINS.2019.00004/BIBTEX.
- [239] F. Ponulak and A. Kasiński, 'Introduction to spiking neural networks: Information processing, learning and applications', *Acta Neurobiol Exp (Wars)*, vol. 71, no. 4, pp. 409–433, 2011.
- [240] R. Legenstein, C. Naeger, and W. Maass, 'Communicated by Wulfram Gerstner What Can a Neuron Learn with Spike-Timing-Dependent Plasticity?', 2005.
- [241] F. Ponulak and A. Kasiński, 'Supervised Learning in Spiking Neural Networks with ReSuMe: Sequence Learning, Classification, and Spike Shifting', *Neural Comput*, vol. 22, no. 2, pp. 467–510, Feb. 2010, doi: 10.1162/NECO.2009.11-08-901.
- [242] R. Gütiğ and H. Sompolinsky, 'The tempotron: a neuron that learns spike timing-based decisions', *Nature Neuroscience* 2006 9:3, vol. 9, no. 3, pp. 420–428, Feb. 2006, doi: 10.1038/nm1643.
- [243] S. Ghosh-Dastidar and H. Adeli, 'A new supervised learning algorithm for multiple spiking neural networks with application in epilepsy and seizure detection', *Neural Networks*, vol. 22, no. 10, pp. 1419–1431, Dec. 2009, doi: 10.1016/J.NEUNET.2009.04.003.
- [244] S. M. Bohte, J. N. Kok, and H. la Poutré, 'Error-backpropagation in temporally encoded networks of spiking neurons', *Neurocomputing*, vol. 48, no. 1–4, pp. 17–37, Oct. 2002, doi: 10.1016/S0925-2312(01)00658-0.
- [245] J. van Campenhout and B. Schrauwen, 'Improving spikeprop: Enhancements to an error-backpropagation rule for spiking neural networks', 2004, Accessed: Jun. 14, 2022. [Online]. Available: <https://www.researchgate.net/publication/228571840>
- [246] E. O. Neftci, H. Mostafa, and F. Zenke, 'Surrogate Gradient Learning in Spiking Neural Networks: Bringing the Power of Gradient-based optimization to spiking neural networks', *IEEE Signal Process Mag*, vol. 36, no. 6, pp. 51–63, Nov. 2019, doi: 10.1109/MSP.2019.2931595.
- [247] S. Yin *et al.*, 'Algorithm and hardware design of discrete-time spiking neural networks based on back propagation with binary activations', *2017 IEEE Biomedical Circuits and Systems Conference, BioCAS 2017 - Proceedings*, vol. 2018-January, pp. 1–4, Mar. 2018, doi: 10.1109/BIOCAS.2017.8325230.
- [248] J. H. Lee, T. Delbruck, and M. Pfeiffer, 'Training deep spiking neural networks using backpropagation', *Front Neurosci*, vol. 10, no. NOV, 2016, doi: 10.3389/fnins.2016.00508.
- [249] H. Mostafa, 'Supervised learning based on temporal coding in spiking neural networks', *IEEE Trans Neural Netw Learn Syst*, vol. 29, no. 7, pp. 3227–3235, Jul. 2018, doi: 10.1109/TNNLS.2017.2726060.
- [250] Y. , C. C. & B. C. J. C. LeCun, 'THE MNIST DATABASE of handwritten digits | CiNii Research', 1998. <https://cir.nii.ac.jp/crid/1571417126193283840> (accessed Jun. 14, 2022).

- [251] F. Zenke and E. O. Neftci, ‘Brain-Inspired Learning on Neuromorphic Substrates’, *Proceedings of the IEEE*, vol. 109, no. 5, pp. 935–950, May 2021, doi: 10.1109/JPROC.2020.3045625.
- [252] B. Cramer, Y. Stradmann, J. Schemmel, and F. Zenke, ‘The Heidelberg Spiking Data Sets for the Systematic Evaluation of Spiking Neural Networks’, *IEEE Trans Neural Netw Learn Syst*, 2020, doi: 10.1109/TNNLS.2020.3044364.
- [253] P. U. Diehl and M. Cook, ‘Unsupervised learning of digit recognition using spike-timing-dependent plasticity’, *Front Comput Neurosci*, vol. 9, no. AUGUST, p. 99, Aug. 2015, doi: 10.3389/FNCOM.2015.00099/BIBTEX.
- [254] A. Tavanaei, M. Ghodrati, S. R. Kheradpisheh, T. Masquelier, and A. Maida, ‘Deep learning in spiking neural networks’, *Neural Networks*, vol. 111, pp. 47–63, Mar. 2019, doi: 10.1016/J.NEUNET.2018.12.002.
- [255] J. Wu, Y. Chua, M. Zhang, Q. Yang, G. Li, and H. Li, ‘Deep Spiking Neural Network with Spike Count based Learning Rule’, *Proceedings of the International Joint Conference on Neural Networks*, vol. 2019-July, Jul. 2019, doi: 10.1109/IJCNN.2019.8852380.
- [256] A. Alemi, C. K. Machens, S. Denève, and J.-J. Slotine, ‘Learning Nonlinear Dynamics in Efficient, Balanced Spiking Networks Using Local Plasticity Rules’, *Proceedings of the AAAI Conference on Artificial Intelligence*, vol. 32, no. 1, Apr. 2018, doi: 10.1609/AAAI.V32I1.11320.
- [257] D. Kappel, B. Nessler, and W. Maass, ‘STDP Installs in Winner-Take-All Circuits an Online Approximation to Hidden Markov Model Learning’, *PLoS Comput Biol*, vol. 10, no. 3, p. e1003511, 2014, doi: 10.1371/JOURNAL.PCBI.1003511.
- [258] M. Oster, R. Douglas, and S. C. Liu, ‘Computation with Spikes in a Winner-Take-All Network’, *Neural Comput*, vol. 21, no. 9, pp. 2437–2465, Sep. 2009, doi: 10.1162/NECO.2009.07-08-829.
- [259] P. Wijesinghe, G. Srinivasan, P. Panda, and K. Roy, ‘Analysis of liquid ensembles for enhancing the performance and accuracy of liquid state machines’, *Front Neurosci*, vol. 13, no. MAY, p. 504, 2019, doi: 10.3389/FNINS.2019.00504/BIBTEX.
- [260] C. Du, F. Cai, M. A. Zidan, W. Ma, S. H. Lee, and W. D. Lu, ‘Reservoir computing using dynamic memristors for temporal information processing’, *Nature Communications 2017 8:1*, vol. 8, no. 1, pp. 1–10, Dec. 2017, doi: 10.1038/s41467-017-02337-y.
- [261] M. Pfeiffer *et al.*, ‘Design and Analysis of a Neuromemristive Reservoir Computing Architecture for Biosignal Processing.’, *Front Neurosci*, vol. 9, pp. 502–502, Jan. 2015, doi: 10.3389/FNINS.2015.00502.
- [262] K. E. Hamilton, T. M. Mintz, and C. D. Schuman, ‘Spike-based primitives for graph algorithms’, Mar. 2019, doi: 10.48550/arxiv.1903.10574.
- [263] W. Severa, R. Lehoucq, O. Parekh, and J. B. Aimone, ‘Spiking Neural Algorithms for Markov Process Random Walk’, *Proceedings of the International Joint Conference on Neural Networks*, vol. 2018-July, Oct. 2018, doi: 10.1109/IJCNN.2018.8489628.
- [264] K. Hamilton, P. Date, B. Kay, and C. Schuman D., ‘Modeling epidemic spread with spike-based models’, *ACM International Conference Proceeding Series*, Jul. 2020, doi: 10.1145/3407197.3407219.
- [265] J. D. Smith *et al.*, ‘Neuromorphic scaling advantages for energy-efficient random walk computations’, *Nature Electronics 2022 5:2*, vol. 5, no. 2, pp. 102–112, Feb. 2022, doi: 10.1038/s41928-021-00705-7.
- [266] R. Bruffaerts, ‘Machine learning in neurology: what neurologists can learn from machines and vice versa’, *J Neurol*, 2018, doi: 10.1007/s00415-018-8990-9.
- [267] S. He *et al.*, ‘Closed-Loop Deep Brain Stimulation for Essential Tremor Based on Thalamic Local Field Potentials’, *Movement Disorders*, vol. 36, no. 4, pp. 863–873, Apr. 2021, doi: 10.1002/MDS.28513.
- [268] Y. Ezzyat *et al.*, ‘Closed-loop stimulation of temporal cortex rescues functional networks and improves memory’, *Nature Communications 2018 9:1*, vol. 9, no. 1, pp. 1–8, Feb. 2018, doi: 10.1038/s41467-017-02753-0.
- [269] M. Zhang *et al.*, ‘A One-Shot Learning, Online-Tuning, Closed-Loop Epilepsy Management SoC with 0.97 $\mu$ J/Classification and 97.8% Vector-Based Sensitivity’, *IEEE Symposium on VLSI Circuits, Digest of Technical Papers*, vol. 2021-June, Jun. 2021, doi: 10.23919/VLSICIRCUITS52068.2021.9492429.
- [270] G. O’Leary, D. M. Groppe, T. A. Valiante, N. Verma, and R. Genov, ‘NuriP: Neural interface processor for brain-state classification and programmable-waveform neurostimulation’, *IEEE J Solid-State Circuits*, vol. 53, no. 11, pp. 3150–3162, 2018, doi: 10.1109/JSSC.2018.2869579.
- [271] Y. Wang *et al.*, ‘A Closed-Loop Neuromodulation Chipset with 2-Level Classification Achieving 1.5-Vpp CM Interference Tolerance, 35-dB Stimulation Artifact Rejection in 0.5ms and 97.8%-Sensitivity Seizure Detection’, *IEEE Trans Biomed Circuits Syst*, vol. 15, no. 4, pp. 802–819, Aug. 2021, doi: 10.1109/TBCAS.2021.3102261.
- [272] A. R. Aslam, T. Iqbal, M. Aftab, W. Saadeh, and M. A. bin Altaf, ‘A10.13uJ/classification 2-channel Deep Neural Network-based SoC for Emotion Detection of Autistic Children’, *Proceedings of the Custom Integrated Circuits Conference*, vol. 2020-March, Mar. 2020, doi: 10.1109/CICC48029.2020.9075952.
- [273] S. Y. Chang *et al.*, ‘An ultra-low-power dual-mode automatic sleep staging processor using neural-network-based decision tree’, *IEEE Transactions on Circuits and Systems I: Regular Papers*, vol. 66, no. 9, pp. 3504–3516, Sep. 2019, doi: 10.1109/TCSI.2019.2927839.

- [274] T. Dewolf, T. C. Stewart, J.-J. Slotine, and C. Eliasmith, 'A spiking neural model of adaptive arm control', doi: 10.1098/rspb.2016.2134.
- [275] Z. Bing, C. Meschede, F. Röhrbein, K. Huang, and A. C. Knoll, 'A survey of robotics control based on learning-inspired spiking neural networks', *Front Neurobot*, vol. 12, p. 35, 2019, doi: 10.3389/FNBOT.2018.00035/BIBTEX.
- [276] D. Gamez, A. K. Fidjeland, and E. Lazdins, 'iSpike: a spiking neural interface for the iCub robot', *Bioinspir Biomim*, vol. 7, no. 2, p. 025008, May 2012, doi: 10.1088/1748-3182/7/2/025008.
- [277] E. Capecci, Z. G. Doborjeh, N. Mammone, F. la Foresta, F. C. Morabito, and N. Kasabov, 'Longitudinal study of Alzheimer's disease degeneration through EEG data analysis with a NeuCube spiking neural network model', *Proceedings of the International Joint Conference on Neural Networks*, vol. 2016-October, pp. 1360–1366, Oct. 2016, doi: 10.1109/IJCNN.2016.7727356.
- [278] S. Ghosh-Dastidar and H. Adeli, 'Improved spiking neural networks for EEG classification and epilepsy and seizure detection', *Integr Comput Aided Eng*, vol. 14, no. 3, pp. 187–212, Jan. 2007, doi: 10.3233/ICA-2007-14301.
- [279] H. Wang *et al.*, 'An Approach of One-vs-Rest Filter Bank Common Spatial Pattern and Spiking Neural Networks for Multiple Motor Imagery Decoding', *IEEE Access*, vol. 8, pp. 86850–86861, 2020, doi: 10.1109/ACCESS.2020.2992631.
- [280] P. Knag, J. K. Kim, T. Chen, and Z. Zhang, 'A Sparse Coding Neural Network ASIC With On-Chip Learning for Feature Extraction and Encoding', *IEEE J Solid-State Circuits*, vol. 50, no. 4, pp. 1070–1079, Apr. 2015, doi: 10.1109/JSSC.2014.2386892.
- [281] J. Seo, B. Brezzo, Y. Liu, ... B. P.-2011 I. C., and U. 2011, 'A 45nm CMOS neuromorphic chip with a scalable architecture for learning in networks of spiking neurons', *ieeexplore.ieee.org*, 2011, Accessed: Jun. 12, 2022. [Online]. Available: <https://ieeexplore.ieee.org/abstract/document/6055293/>
- [282] Y. Wu, X. Wang, W. D. Lu, J. M. Cruz-Albrecht, T. Derosier, and N. Srinivasa, 'A scalable neural chip with synaptic electronics using CMOS integrated memristors', *Nanotechnology*, vol. 24, no. 38, p. 384011, Sep. 2013, doi: 10.1088/0957-4484/24/38/384011.
- [283] K. Berggren *et al.*, 'Neuromorphic neural interfaces: from neurophysiological inspiration to biohybrid coupling with nervous systems', *J Neural Eng*, vol. 14, no. 4, p. 041002, Jun. 2017, doi: 10.1088/1741-2552/AA67A9.
- [284] A. Kumar Mukhopadhyay *et al.*, 'Power-efficient Spike Sorting Scheme Using Analog Spiking Neural Network Classifier', *ACM Journal on Emerging Technologies in Computing Systems (JETC)*, vol. 17, no. 2, Jan. 2021, doi: 10.1145/3432814.
- [285] N. K. Kasabov, 'NeuCube: A spiking neural network architecture for mapping, learning and understanding of spatio-temporal brain data', *Neural Networks*, vol. 52, pp. 62–76, Apr. 2014, doi: 10.1016/J.NEUNET.2014.01.006.
- [286] S. Budhraja, B. Bhattacharya, ... S. D.-... J. C. on, and undefined 2020, 'Sleep Stage Classification using NeuCube on SpiNNaker: a Preliminary Study', *ieeexplore.ieee.org*, 2020, Accessed: Jun. 12, 2022. [Online]. Available: <https://ieeexplore.ieee.org/abstract/document/9207369/>
- [287] K. Kumarasinghe, M. Owen, D. Taylor, N. Kasabov, and C. Kit, 'FaNeuRobot: A Framework for Robot and Prosthetics Control Using the NeuCube Spiking Neural Network Architecture and Finite Automata Theory', *Proc IEEE Int Conf Robot Autom*, pp. 4465–4472, 2018, doi: 10.1109/ICRA.2018.8460197.
- [288] F. Corradi and G. Indiveri, 'A Neuromorphic Event-Based Neural Recording System for Smart Brain-Machine-Interfaces', *IEEE Trans Biomed Circuits Syst*, vol. 9, no. 5, pp. 699–709, Oct. 2015, doi: 10.1109/TBCAS.2015.2479256.
- [289] F. Boi *et al.*, 'A bidirectional brain-machine interface featuring a neuromorphic hardware decoder', *Front Neurosci*, vol. 10, Dec. 2016, doi: 10.3389/FNINS.2016.00563.
- [290] N. Qiao *et al.*, 'A reconfigurable on-line learning spiking neuromorphic processor comprising 256 neurons and 128K synapses', *Front Neurosci*, vol. 9, no. APR, 2015, doi: 10.3389/FNINS.2015.00141.
- [291] S. Venkatraman, K. Elkabany, J. D. Long, Y. Yao, and J. M. Carmena, 'A system for neural recording and closed-loop intracortical microstimulation in awake rodents', *IEEE Trans Biomed Eng*, vol. 56, no. 1, pp. 15–22, Jan. 2009, doi: 10.1109/TBME.2008.2005944.
- [292] D. J. Guggenmos *et al.*, 'Restoration of function after brain damage using a neural prosthesis', *Proc Natl Acad Sci U S A*, vol. 110, no. 52, pp. 21177–21182, Dec. 2013, doi: 10.1073/pnas.1316885110.
- [293] M. Ronchini *et al.*, 'A CMOS-based neuromorphic device for seizure detection from LFP signals', *J Phys D Appl Phys*, vol. 55, no. 1, p. 014001, Oct. 2021, doi: 10.1088/1361-6463/AC28BB.
- [294] J. H. Park, J. S. Y. Tan, H. Wu, Y. Dong, and J. Yoo, '1225-Channel Neuromorphic Retinal-Prosthesis SoC with Localized Temperature-Regulation', *IEEE Trans Biomed Circuits Syst*, vol. 14, no. 6, pp. 1230–1240, Dec. 2020, doi: 10.1109/TBCAS.2020.3036091.



- [295] B. S. Mashford, A. J. Yepes, I. Kiral-Kornek, J. Tang, and S. Harrer, 'Neural-network-based analysis of EEG data using the neuromorphic TrueNorth chip for brain-machine interfaces', *IBM J Res Dev*, vol. 61, no. 2–3, 2017, doi: 10.1147/JRD.2017.2663978.
- [296] E. Nurse, B. S. Mashford, A. J. Yepes, I. Kiral-Kornek, S. Harrer, and D. R. Freestone, 'Decoding EEG and LFP signals using deep learning: Heading truenorth', *2016 ACM International Conference on Computing Frontiers - Proceedings*, pp. 259–266, May 2016, doi: 10.1145/2903150.2903159.
- [297] M. Nakanishi, Y. Wang, X. Chen, Y. te Wang, X. Gao, and T. P. Jung, 'Enhancing Detection of SSVEPs for a High-Speed Brain Speller Using Task-Related Component Analysis', *IEEE Trans Biomed Eng*, vol. 65, no. 1, pp. 104–112, Jan. 2018, doi: 10.1109/TBME.2017.2694818.
- [298] S. Nagel and M. Spüler, 'World's fastest brain-computer interface: Combining EEG2Code with deep learning', *PLoS One*, vol. 14, no. 9, Sep. 2019, doi: 10.1371/JOURNAL.PONE.0221909.
- [299] F. D. Broccard, S. Joshi, J. Wang, and G. Cauwenberghs, 'Neuromorphic Neural Interfaces', doi: 10.1007/978-981-15-2848-4\_41-1.