

---

# DEEP LEARNING IN A BILATERAL BRAIN WITH HEMISPHERIC SPECIALIZATION

---

• **Chandramouli Rajagopalan**  
Cerenaut  
Melbourne, Australia  
chanduiyer.raja@gmail.com

• **David Rawlinson**  
Cerenaut  
Melbourne, Australia  
dave@cerenaut.ai

• **Elkhonon Goldberg**  
Luria Neuroscience Institute  
& NYU Grossman School of Medicine  
New York City, USA  
eg@elkhonongoldberg.com

• **Gideon Kowadlo**  
Cerenaut  
Melbourne, Australia  
gideon@cerenaut.ai

## ABSTRACT

The brains of all bilaterally symmetric animals on Earth are divided into left and right hemispheres. The anatomy and functionality of the hemispheres have a large degree of overlap, but there are asymmetries and they specialize to possess different attributes. Several computation models mimic hemispheric asymmetries with a focus on reproducing human data on semantic and visual processing tasks. In this study, we aimed to understand how dual hemispheres in a bilateral architecture interact to perform well in a given task. We propose a bilateral artificial neural network that imitates lateralization observed in nature: that the left hemisphere specializes in specificity and the right in generalities. We used different training objectives to achieve the desired specialization and tested it on an image classification task with two different CNN backbones – ResNet and VGG. Our analysis found that the hemispheres represent complementary features that are exploited by a network head which implements a type of weighted attention. The bilateral architecture outperformed a range of baselines of similar representational capacity that don't exploit differential specialization, with the exception of a conventional ensemble of unilateral networks trained on a dual training objective for specifics and generalities. The results demonstrate the efficacy of bilateralism, contribute to the discussion of bilateralism in biological brains and the principle may serve as an inductive bias for new AI systems.

**Impact statement** A striking feature of the brain is that it is divided into two hemispheres. It is a conserved feature across all bilaterally symmetric animals, strongly suggesting its importance for intelligence. Many researchers have investigated observed hemispheric asymmetry. We take a different approach, assuming specialization, which enables an investigation into how dual hemispheres complement each other to improve performance. The study constitutes a novel approach to understanding the role of dual hemispheres for the cognitive sciences and the analysis suggests possible mechanisms. In addition, the architecture outperformed a variety of comparable baselines, demonstrating that bilateralism is an important biologically-inspired principle to be considered in the design of new AI systems.

**Keywords** Hemispheric specialization, Hemispheric asymmetry, Brain-inspired architecture, Bilateral, Computational cognitive neuroscience, Deep learning, Inductive bias

## 1 Introduction

Many advances in the field of AI have been inspired by the human brain including the perceptron, reinforcement learning and imitation learning. In this study, we took inspiration from the bilateral nature of the brain and applied it to a standard task suited to a bilateral architecture.

*What is bilateralism?* The brain is divided into left and right hemispheres. It's a remarkably conserved feature across species, suggesting its importance for intelligence. The anatomy and functionality of the hemispheres have a large degree of overlap, but they are asymmetric and specialize to possess different attributes.

A likely explanation for the emergent specialization is hemispheric asymmetry through small differences in functional and anatomical properties of the cortex. For example, neuron density distribution. The left resembles a pyramid with a greater density of neurons near input layers, whereas the right resembles an inverted pyramid, with greater neuron density near output layers [1, 2, 3, 4, 5, 6]. Network topology also plays a role. The left has more short local pathways constituting a modular network organization, whereas the right has more longer inter-regional pathways [4, 5, 6]. More differences are described in Section 2.1.1, in the Related Work.

Many researchers have used computational models to study the bilateral brain. They mimic anatomical and functional asymmetries, subject the system to standard tasks, and compare the results to human behavioral data. The various studies provide evidence that asymmetric functional and anatomical differences can give rise to observed lateralization of activity (i.e. specialization) for specific tasks. More detail is given in Section 2.1.2, in the Related Work.

The central question of the existing models, is to understand what gives rise to observed specialization. The aim of this project is to investigate a different question – what is the benefit of having differentially specialized hemispheres and how do they complement each other for a given task? Our approach is to induce specialization directly, rather than test if it emerges as a result of architectural asymmetry. We investigated bilateralism through a computational model, with the objective of developing a theory of operation and to understand how bilateral principles could be exploited for AI/ML.

## 1.1 Our approach

As a starting point, we focused on the left hemisphere's specialization on specifics, and the right's specialization on generalities [4, 5, 6]. We hypothesize that an ANN with differentially specialized sub-networks would outperform a single comparable network in a classification task featuring both fine and coarse class labels.

We chose a hierarchical image classification task where each sample belongs to both a fine and a coarse class. For example, **coarse**: sea creature, **fine**: penguin, seal, shark etc. We modelled the hemispheres with left and right CNNs and induced specialization using supervised training with different training objectives, using either coarse or fine labels. The bilateral network was compared to several comparative baselines that do not have specialization but do have the same number of learnable parameters. The differences were analyzed to explore the effects of bilateral specialization. Experiments were repeated across two types of CNN hemispheres, VGG and ResNet variants, to test generalization over different core CNN architecture.

We predicted that with specialization, the hemispheres would extract distinct but overlapping features, despite identical observations. In addition, we expected that a bilateral architecture would be able to combine these features to improve overall accuracy.

The source code is available at [7].

## 2 Related work

### 2.1 Biological computational models

Multiple studies examine hemispheric function in standard behavioral tasks. The studies use bilateral artificial neural networks that mimic functional and architectural hemispheric asymmetries. They replicate aspects of human behavioral data on the tasks, focussing on lateralized hemispheric activity. Some of the studies also consider neurological development, disorders or damage and recovery. With the exception of face perception studies, they all used synthetic abstracted representations for input and output vectors and do not operate on realistic sensory data.

This section is divided into two subsections: a) 'Hemispheric asymmetries' which provides additional background on observed architectural and anatomical asymmetries, and b) 'Models and tasks' which describes the models that were created, organized by the tasks that were used for testing them.

#### 2.1.1 Hemispheric asymmetries

In addition to the examples given in the introduction, topology and neuron density distribution, other architectural differences come into play. From a connectivity perspective, there are different intra-hemispheric patterns of connectivity between regions within each hemisphere [8, 9]. Furthermore, inter-hemispheric communication by the Corpus callosum

results in a competitive process between the hemispheres [2, 1, 10, 11] which is believed to support lateralization of activity. Asymmetry in the visual stream is caused by a split-fovea, where each hemisphere receives the contra-lateral half of the visual field [12, 13, 14, 11, 15, 16, 17].

There are also functional asymmetries. Neurotransmitters such as dopamine and norepinephrine are asymmetrically distributed and neuron firing thresholds differ between hemispheres [10]. Also, the hemispheres respond asymmetrically to frequency: the left responds to higher frequencies than the right [14, 15, 12]. Finally, there may be additional asymmetries that are not yet discovered.

### 2.1.2 Models and tasks

The behavioral tasks can be divided into two major groups, semantic processing and visual perception. For semantic processing, behavioral data and patterns of hemispheric asymmetry were reproduced by varying intra-hemispheric connectivity [9] in the context of semantic dementia [18], and in the context of unilateral and bilateral lesions [8]. Other studies varied anatomical features such as inter-hemispheric connectivity and the distribution of units between layers, as well as functional features such as learning rate, sensitivity and maximum unit activation and combinations of these factors [2, 1, 10] and in the context of lesions and recovery [3]. Another anatomical feature that was explored is the split-fovea [12] and in the context of dyslexia [13]. In the case of the split-fovea experiments, hemispheric asymmetry emerged as a result of the orthographic to semantic patterns inherent in the language.

Visual perception tasks can be further divided into face perception and the line-bisection task. Face perception includes identification of faces and emotions. In the line-bisection tasks, subjects are asked to mark the center of a horizontal line, as perception of the center is affected by hemispheric function. Face perception was first studied by Dailey et al. [15] with a model that mimicked the hemispheric frequency response asymmetry. Hsiao et al. [14] added a split-fovea and then Wang et al. [11] incorporated other functional parameter differences between the hemispheres as well as a learned gating mechanism for inter-hemispheric communication. For the line bisection task, Shillcock et al. [16] and Monaghan and Shillcock [17] used a split-fovea, asymmetric frequency response as well as asymmetric distribution of units in layers between left and right.

In the closest work to this project, Mayan et al. [19] tackled the same problem of image classification with fine and coarse (hierarchical) classes. The authors created a single network with two hemispheres, and trained it with supervised learning and a single loss function. They used hyperparameters with analogies to biological parameters in each hemisphere to encourage specialization. Specialization was achieved in each side but the bilateral network did not have an advantage over baselines.

## 2.2 Biologically inspired multi-network architectures

Several studies cover related ideas, although they did not explicitly model bilateral hemispheres. [20] created a dual-stream architecture called Neuromodulator Meta-learner, where one network learns to modulate the other, to enhance continual learning. [21] created a network with parallel pathways to reproduce the functionality of dorsal ('where') and ventral ('what') pathways in an ANN trained with a single loss function. [22] discussed specialization of a branched neural network when trained on a Gabor filter dataset and found that the training curriculum is inconsequential to specialization of the branched neural network.

### 2.3 Ensemble models

The dual-hemisphere architecture in this work can be viewed as a type of ensemble model. Ensembling is a popular approach in ML [23]. The most common techniques involve combining the outputs of the same model type, trained with different seeds. However, there are also many techniques that encourage diversity within the ensemble using different training objectives, sampling, architecture, or losses [24, 25, 26]. Our work may be seen as a special case of a diversified ensemble, where the ensemble architecture exploits hierarchical data labels to achieve the diversification.

### 2.4 Multi-domain learning

Another related area is multi-domain learning. In multi-domain learning (MDL), multiple models are trained to specialize on a particular domain [27]. Two of the main approaches include a) modelling domain-specific and domain-general features [28] and b) explicitly modelling the relationship between domains. MDL is focussed on classes from domains with different distributions. The domain is sometimes explicit, and other times it is determined by the model [29]. In contrast, this project is focussed on explicit hierarchical labels from the same distribution. The objective being to mimic learning different aspects of a single task with left and right hemispheres (2 separate models).

## 2.5 Hierarchical image datasets

We focused on image classification of fine and coarse classes, exploiting the hierarchical nature of CIFAR-100 [30]. CIFAR-100 and other hierarchical image classification datasets are widely used as benchmarks, including ImageNet [31] and Omniglot [32]. However, the hierarchical nature of available classes is rarely exploited to enhance training or generate a more difficult task. Notable exceptions arise in the Continual Few-Shot Learning literature, such as the Meta-Dataset of [33] which generates class-hierarchy-aware episodes of data and the Tiered-ImageNet of [34] which uses class hierarchy to generate Out of Distribution (OoD) data.

## 3 Models

We implemented a bilateral model as well as several baselines. Each model consists of one or more feature extractors, representing hemispheres, as well as one or two classifier heads. The hemispheres were implemented with two different CNN architectures to test if the effects generalize across architecture types: ResNet [35] and VGG [36]. We chose VGG and ResNet because they are common, well understood and amongst the best performing on many vision tasks.

In the case of the ResNet-based models, we took the concept of residual layers and skip connections, and empirically optimized the number of layers on the dataset, resulting in a 9-layer network shown in Figure 2, and hereafter referred to as ResNet-9.

For the VGG based model, we chose the VGG-11A variant [36], hereafter referred to as VGG-11, as it is closest in depth to ResNet-9 and has been shown to work well for CIFAR100 [37]. We used the pre-defined PyTorch implementation, but removed the final fully-connected layer as we later add our own classifier (explained below). In shorthand, the full architecture is: **conv64-pool-conv128-pool-conv256-conv256-pool-conv512-conv512-pool-conv512-conv512-pool-fc4096-fc4096**. ConvX = convolutional with X filters, pool = max pool, fcX = fully connected with X units. All filters are 3x3 pixels. Although VGG-11 and ResNet-9 are both convolutional networks with a similar depth, there are substantial architectural differences. VGG does not have skip connections, and there are a lot more parameters due to the fully-connected layers.

The heads consist of a single fully-connected layer, without bias or non-linearity and with output dimensions the same size as the number of classes (10 for coarse and 100 for fine).

All networks were trained with a cross-entropy loss function, which includes a softmax operation (not shown explicitly in the diagrams as it is part of the loss function). Details about training and evaluation are given in Section 4.1.2.

The models are depicted in Figure 1 and described in the subsections below.

### 3.1 Bilateral network - specialized

Training and assembling the bilateral network consisted of two phases. In Phase 1, individual hemispheres were trained to be specialized feature extractors with a single classifier head, Figure 1a, referred to as ‘Unilateral - specialized’. The left hemisphere was specialized for specific classes through supervised training using the fine labels. The right hemisphere was specialized for general classes through supervised training using the coarse labels. See Section 4.1.2 for details on training and evaluation.

Then in Phase 2, the hemispheres were brought together into a broader architecture consisting of two hemispheres, which serve as feature extractors, and two newly initialized classifier heads, one each for fine and coarse labels, Figure 1b, referred to as ‘Bilateral - specialized’. The weights of the individual hemispheres were frozen and the heads were trained to use the features for classifying fine and coarse labels. A single loss was calculated by adding the loss from each head.

### 3.2 Baseline models

**Unilateral network *with* specialization** To understand the effect of specialization on performance, we compared to the specialized single-hemispheres, Figure 1a, as the first baseline. Specialization was achieved using supervised training with selective labels as described above in Section 3.1, ‘Bilateral network - specialized’.

**Unilateral network *without* specialization** To better understand the single-hemisphere, and the role of using complementary loss functions in the absence of dual hemispheres, we also compared to a single-hemisphere without specialization, Figure 1d. The single hemisphere was trained on both types of labels simultaneously, by using two classifier heads and adding the loss from both.

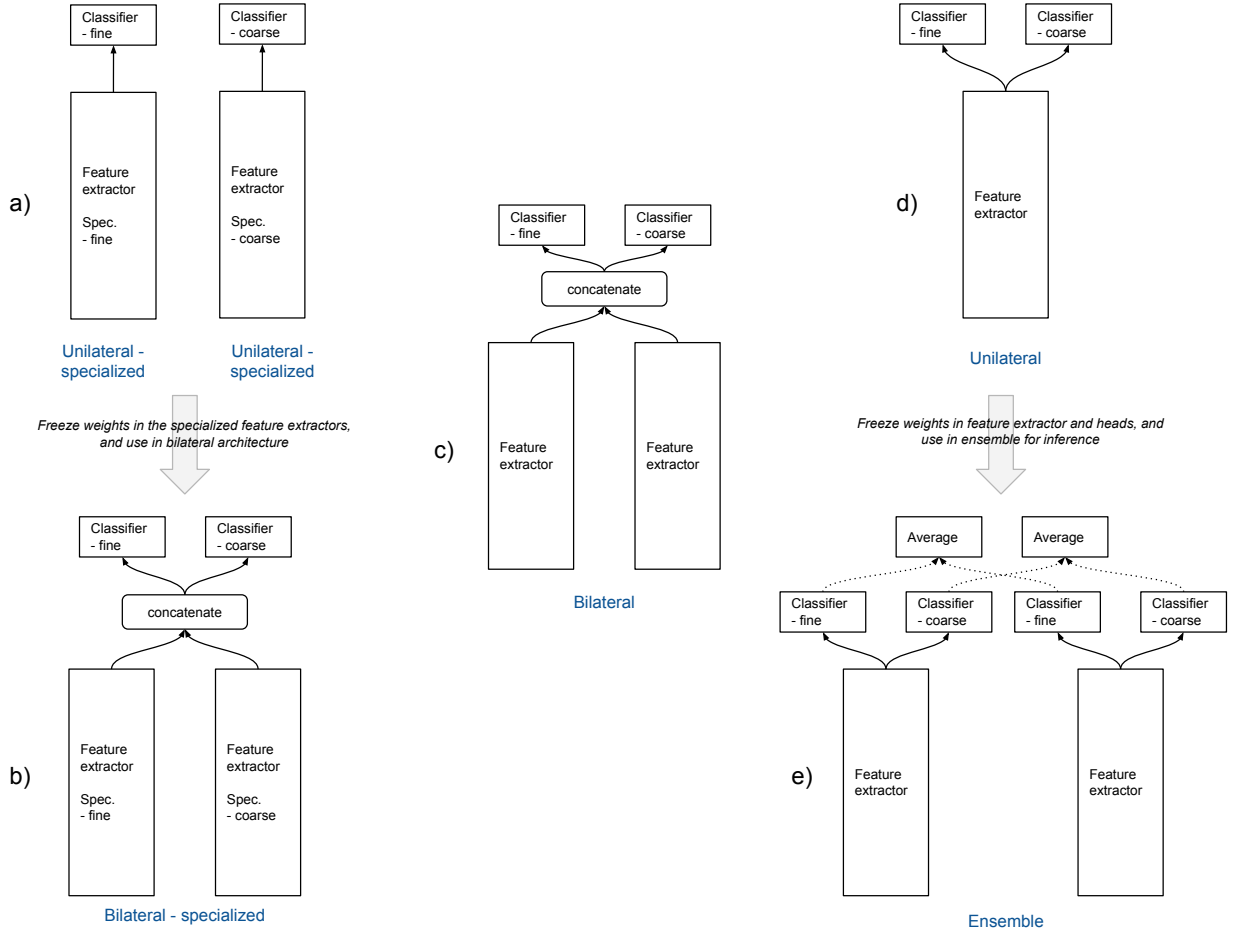

Figure 1: **The range of models.** Feature extractors are either ResNet-9 or VGG-11. The classifier heads are single layer fully connected networks, with output dimensions the same size as the number of classes. For brevity, if not specified, the network is un-specialized.

**Bilateral network without specialization** To better understand the role of specialization, we compared the bilateral network to an equivalent network without specialization, Figure 1c. This baseline has the same number of trainable parameters. It can be viewed as a type of ensemble, where the models are combined in the same way as the specialized bilateral network.

We trained the entire network (two hemispheres and two heads) without first explicitly inducing specialization in the individual hemispheres. Like for the unilateral network and bilateral network with specialization, the loss from each head are added together to create a single loss value.

**Ensembles** The bilateral network is a type of ensemble. Ensemble learning denotes combining different models or algorithms to obtain improved performance over a single model [23]. To understand the differences between differential specialization and conventional ensembling, we compared to a 2-model ensemble, Figure 1e. We chose 2 models, so that the ensemble has approximately the same number of trainable parameters as the bilateral network. We used two unilateral models without specialization, trained from different seeds. The output of the ensemble (in training and inference) was the average output from the heads: for the fine classification, it was the average of the fine classifier heads, and for the coarse classification, it was the average of the coarse classifier heads. In order to test multiple seeds, we trained five models with different seeds, and then constructed five 2-model ensembles, each with a unique pair of models selected from the pool of five.

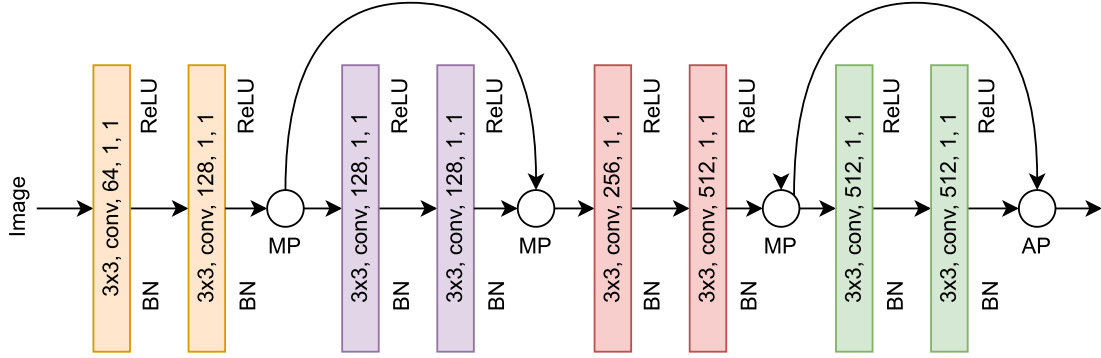

Figure 2: **ResNet-9 architecture.** A convolutional neural net with 9 layers and skip connections. The format of the description within each convolutional layer is filter w x h, number of filters, stride and padding. BN = Batch Norm, MP = Max Pool and AP = Average Pool.

## 4 Experiments

### 4.1 Experimental setup

#### 4.1.1 Dataset

We used the CIFAR-100 dataset [30], as it includes hierarchical labels that denote fine (specific) and coarse (general) class labels. The dataset is split into 50,000 training and 10,000 test samples. Images were resized to 32x32 and we used two widely adopted data augmentation techniques, a random crop (using the RandomCrop PyTorch function) and a random horizontal flip (using the RandomHorizontalFlip PyTorch function) to increase the diversity of the training set.

#### 4.1.2 Training and evaluation

The models were trained with supervised learning using a cross-entropy loss function. Depending on the model, the fine or coarse labels were used. In the case of dual heads (one with each label type, see Section 3), the loss from each head was added to create a single loss value. Weights were initialized with PyTorch defaults, from a random uniform distribution  $U(-\sqrt{k}, \sqrt{k})$ : for linear layers  $k = 1/in\_features$ , and for the convolutional layers  $k = \frac{1}{C_{in} * \prod_{i=0}^1 kernel\_size[i]}$ . We used weight decay of 1.0e-5, dropout of 0.6 on the classifier heads [38] to regularize the models, Adam [39] for optimization, with a learning rate of 1.0e-4 and a mini-batch size of 256.

Each network was trained for 180 epochs from 5 random seeds. At the end of each epoch, the models were validated on the test split. The number of epochs was sufficient to ensure that the validation accuracy had plateaued, and the final model was the one with the highest validation accuracy across epochs.

#### 4.1.3 Framework and computational resources

Experiments were conducted with the PyTorch-Lightning [40] research framework, a wrapper around the PyTorch library [41]. All models were trained and evaluated with a virtual machine with a single NVIDIA A10 GPU, 24GB RAM (through Lambda Labs <https://lambdalabs.com/>).

### 4.2 Visualizing network operation

For visualizations, we focussed on one hemisphere architecture, ResNet-9. We used two types of visualizations to better understand the operation of the bilateral network.

In order to be informative, we selected key scenarios that are distinct from each other and highlight the contribution of different parts of the network. The scenarios are:

- Scenario 1: The bilateral-specialized network is correct, left and right hemispheres are incorrect.
- Scenario 2: The bilateral-specialized network and the right hemisphere are correct, the left hemisphere is incorrect.

- Scenario 3: The bilateral-specialized network and the left hemisphere are correct, the right hemisphere is incorrect.
- Scenario 4: The bilateral-specialized network is incorrect, the left and right hemispheres are correct.

The definition of ‘correct’ for the bilateral-specialized network, is that it was successful for both fine and coarse class labels.

**Gradient camera (Grad-Cam) visualization** To understand how the specialized bilateral network exploits features from both hemispheres, we visualized gradient flow with respect to target convolutional layers [42, 43, 44] using the Grad-Cam library. The gradients reveal which areas of the image contribute most to the prediction; the gradient heatmap highlights the region of focus. We applied the visualization to each of the specialized hemispheres individually, and compared it to the bilateral network.

For a single hemisphere, the gradients were averaged over the 2nd convolutional layer of each residual block (2 convolutional layers with skip connections, see Figure 2) during prediction. In the case of the bilateral network, the gradients were averaged over both hemispheres during simultaneous prediction of both coarse and fine labels (the network had two heads).

**Feature analysis using cosine similarity** We investigated how left and right features are exploited by the bilateral network by analyzing the relationship between representations in different parts of the network, with a focus on how the representations are transformed by the network heads. We did this by measuring the similarity of features for images of the same label. They are expected to have similar features, so measuring the feature similarity at different parts of the network should be revealing.

We first grouped the image samples into random pairs with the same class label. We then plotted a bivariate distribution of cosine similarity between the pairs, one for the input to the heads, denoted ‘concatenated’ and the other for the average of the network head outputs, denoted ‘bilateral’. Similarity is plotted along the following dimensions: left hemisphere, right hemisphere and a third dimension, either concatenated or bilateral. Additionally, univariate marginal distributions were plotted for each hemisphere.

## 5 Results

### 5.1 Accuracy

Quantitative results are shown in tabular form in Tables 1 and 2 and with plots in Figures 3 and 4.

The relative performance of models was very consistent between ResNet and VGG architectures. In summary, the bilateral architecture with specialization provided a performance boost for both fine and coarse classes over an individual specialized hemisphere (unilateral-specialized). Moreover, it outperformed the baselines, except for the 2-model ensemble. The 2-model ensemble consists of unilateral models, which were more effective than unilateral that were specialized in most cases. The exception was the VGG architecture with coarse labels, where the unspecialized unilateral model *was not* better than the specialized version, and the resulting 2-model ensemble did not outperform the specialized bilateral network.

Model	# Params (M)	Accuracy (%) - fine labels	Accuracy (%) - coarse labels
Unilateral	6.63	67.81 ± 0.46	78.25 ± 0.51
Unilateral (specialized for fine)	6.58	67.81 ± 0.31	—
Unilateral (specialized for coarse)	6.62	—	75.87 ± 0.70
Bilateral	13.26	68.80 ± 0.59	78.82 ± 0.65
Bilateral - with specialization	13.26	71.35 ± 0.36	80.71 ± 0.48
Ensemble (2 unilateral models)	13.26	72.15 ± 0.11	81.80 ± 0.24

Table 1: **Accuracy of ResNet-based models.** Accuracy is given as mean ± 1 standard deviation of 5 seeds.

### 5.2 Visualizing network operation

Visualizations of Grad-Cam and similarity distributions are shown for the selected scenarios described in Section 4.2.

Model	# Params (M)	Accuracy (%) - fine labels	Accuracy (%) - coarse labels
Unilateral	129.26	53.13 $\pm$ 0.41	66.86 $\pm$ 0.41
Unilateral (specialized for fine)	129.18	51.87 $\pm$ 0.58	—
Unilateral (specialized for coarse)	128.85	—	66.86 $\pm$ 0.41
Bilateral	258.52	53.05 $\pm$ 0.49	66.42 $\pm$ 0.27
Bilateral with specialization	258.52	56.09 $\pm$ 0.33	71.57 $\pm$ 0.42
Ensemble (2 unilateral models)	258.52	57.81 $\pm$ 0.38	70.68 $\pm$ 0.30

Table 2: **Accuracy of VGG-based models.** Accuracy is given as mean  $\pm$  1 standard deviation of 5 seeds.

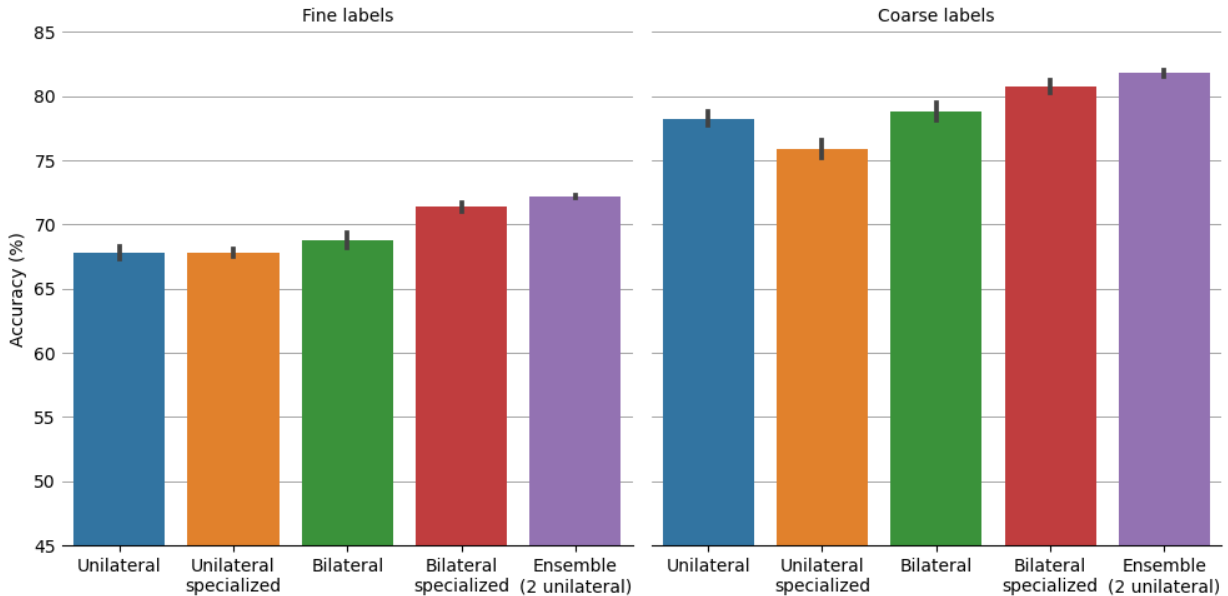

Figure 3: Accuracy of ResNet-based architectures. For brevity, if not specified, the network is unspecialized. The height of the bars is the mean accuracy, and the error bars are 1 standard deviation of 5 seeds.

The Grad-Cam visualizations are shown in Figures 5 to 8. In general, the features are more local in the left hemisphere and more global in the right hemisphere. The heads blend different aspects of features from the left and right hemispheres for the task. The effect is that in many cases, features trained for fine classes are helpful for coarse classes and vice versa, and a correct classification can be achieved even if both hemispheres are individually incorrect.

The cosine similarity results are shown in Figure 9 and Figure 10. In the concatenated distribution, there is a strong correlation between similarity in left and concatenated, and right and concatenated. In contrast, there is no obvious correlation in the bilateral distribution. The network heads learned a non-linear transformation of the feature space.

## 6 Discussion

### 6.1 Key findings

We conducted experiments to implement and study bilateralism in Artificial Neural Networks. The effects of bilateralism were studied by comparing against baselines that captured distinct characteristics of the proposed bilateral network. We used a classification task with hierarchical classes that captured an observed characteristic of biological hemispheres, that the left is more specialized for fine classes and the right for coarse classes.

We found that there is an advantage of two hemispheres over one, demonstrated by the fact that Bilateral-specialized outperformed individual hemispheres alone. Furthermore, we found that it is not due to the greater number of learnable



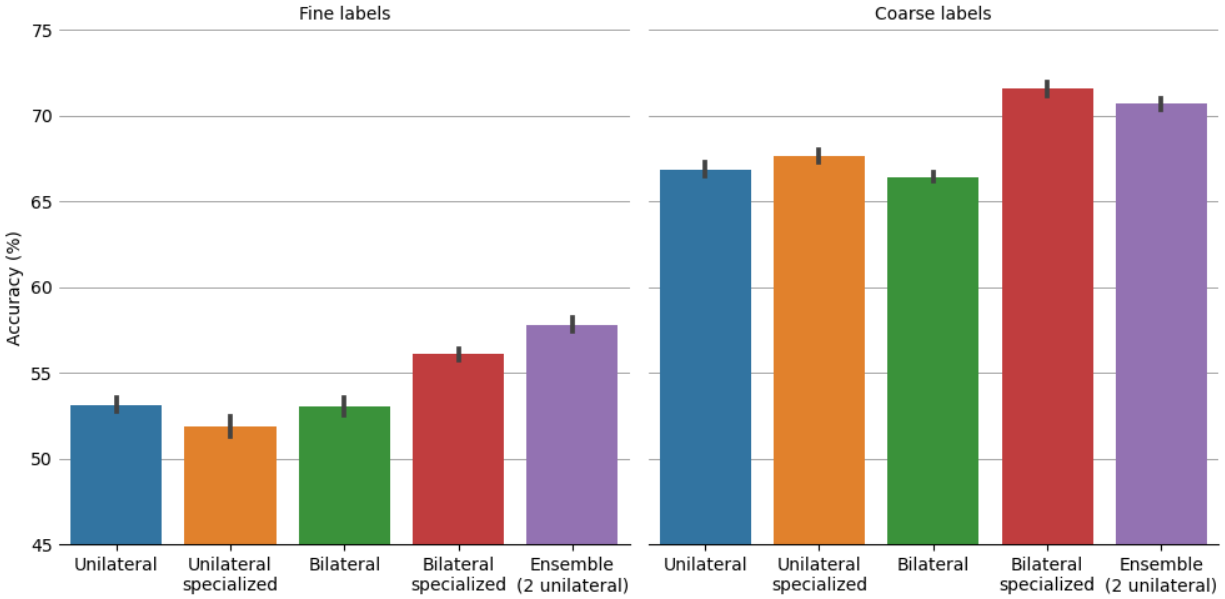

Figure 4: **Accuracy of VGG-11-based models.** For brevity, if not specified, the network is unspecialized. The height of the bars is the mean accuracy, and the error bars are 1 standard deviation of 5 seeds.

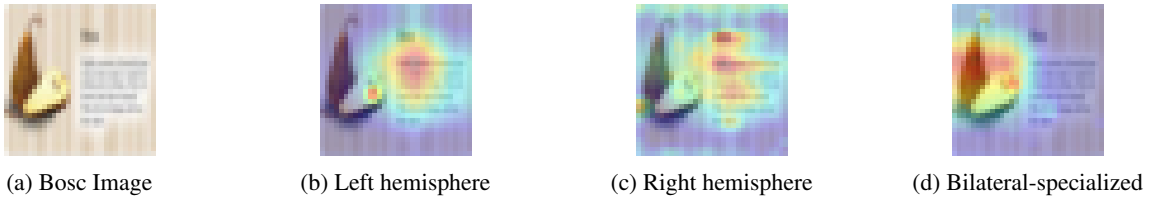

Figure 5: **Grad-Cam for Scenario 1: The bilateral-specialized network is correct, left and right hemispheres are incorrect.** The bilateral network appears to adjust the area of focus even when both the hemispheres' features are situated external to the bosc.

parameters, and having two hemispheres is not sufficient, but that specialization is important, shown by the benefit of bilateral-specialized over bilateral.

Surprisingly, an unspecialized hemisphere (Unilateral) performed as well or better than specialized hemispheres (Unilateral-specialized) in most cases. Training with two objective functions (fine and coarse) led to better performance on both labels – whether that is in a bilateral or unilateral architecture.

Ultimately, two hemispheres arranged into a conventional ensemble achieved the best results. A key difference with Bilateral-specialized, is that the component models were more effective to begin with. Another difference is the way in which the model outputs are combined – averaging of the classification vs concatenation of the feature vector. Future work could explore this in more detail.

Both the specialized bilateral network and the ensemble were able to boost performance of individual hemispheres. However, they use different mechanisms.

The novel finding of the paper is that a bilateral architecture can exploit specialized hemispheres, and the remainder of the paper examines this principles.

## 6.2 Computational cost

Compared to a conventional single network, the bilateral architecture has approximately double the number of parameters and computational cost. The performance boost between unilateral and specialized bilateral models may appear modest for the additional cost. However, incremental gains are difficult to achieve at high levels of performance, making

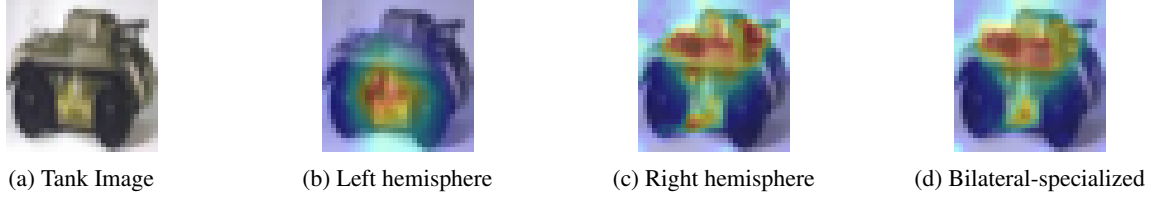

Figure 6: **Grad-Cam for Scenario 2: The bilateral-specialized network and the right hemisphere are correct, the left hemisphere is incorrect.** Possibly due to the fact that there are multiple labels with wheels, the left failed to differentiate the tank by its wheels alone, however the bilateral appears to overcome this, using the right hemisphere’s features.

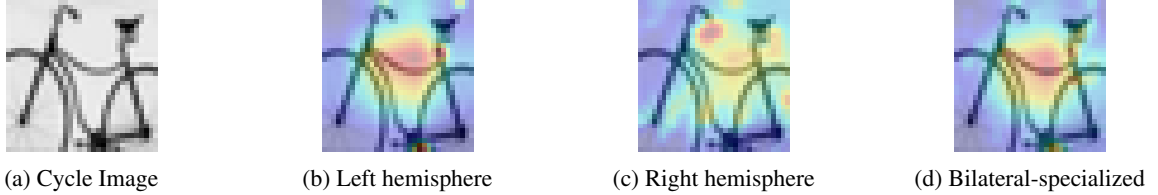

Figure 7: **Grad-Cam for Scenario 3: The bilateral-specialized network and the left hemisphere are correct, the right hemisphere is incorrect.** The left hemisphere identified more local features of the bicycle compared to the right. The network head appear to exploit the left representations to make an accurate prediction.

the 2.5-5% improvement (across fine, coarse and hemisphere architectures) consequential. This is the first study to demonstrate the bilateral principle, and like other new architectures, greater improvements can be expected in the future.

### 6.3 How does the bilateral architecture work?

The Grad-Cam images reveal that the left hemisphere extracts more localized features than the right. Different learning objectives enable them to capture different aspects of the environment. Collectively the set of features is greater than one network with one objective.

Interestingly, even though the left is explicitly trained on fine class labels, the features that it extracts are helpful for coarse classes. The inverse is true of the right.

With reference to the cosine similarity visualization, before the network heads, the similarity of pairs of images of the same class is correlated with left and right. The similarity is no longer correlated after the network heads, which must implement some sort of non-linear transformation. In many cases, when left or right produce ineffective features, shown by low similarity between these images of the same class, the heads are able to produce features that have increased similarity. The network heads learn to combine the features from left and right, to different degrees, to produce better predictions. In some cases, the bilateral network makes a correct classification, even if both hemispheres are individually wrong.

In summary, specialization creates a higher diversity of features. The network heads implement a type of weighted attention to left and right hemispheres selectively in a task dependent manner, improving overall class prediction.

### 6.4 Relation to biology

A limitation of our model, in terms of biological accuracy, was that inter-hemispheric connectivity was achieved at the outputs of the hemispheres. In contrast, biological hemispheres are interconnected throughout their hierarchies [45]. Nevertheless, the heads may serve a similar purpose, albeit in a cruder way. Inter-hemispheric connectivity comprises a complex combination of inhibitory and excitatory projections. The hemisphere that is better able to represent the input is likely to have stronger activation and thus inhibit the other hemisphere [1, 2]. Like the heads, this too is a type of selectivity. Building a model with interconnected hemispheres throughout the hierarchy is a topic for future research.

The central finding that in our model, left and right hemispheres extracted local and non-local features, used together in fine tasks, provides one plausible suggestion for the prevalence of bilateral brains in nature. A possible approach to investigate this idea is with transcranial magnetic stimulation (TMS) to selectively impair one hemisphere at a time on controlled tasks [46].

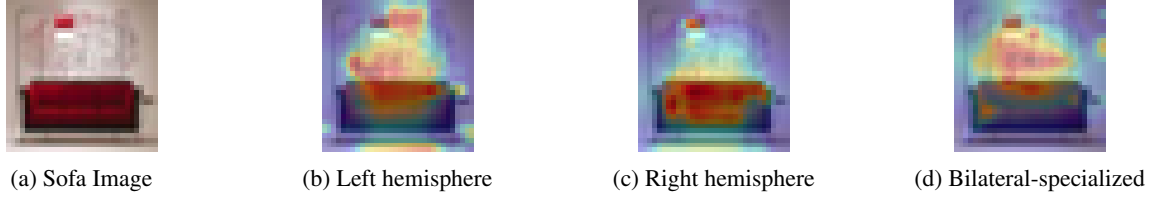

Figure 8: **Grad-Cam for Scenario 4: The bilateral-specialized network is incorrect, the left and right hemispheres are correct.** Both hemispheres identified local and global features. The network heads appear to over-compensate and focus on the region outside of the sofa, which is ultimately unsuccessful.

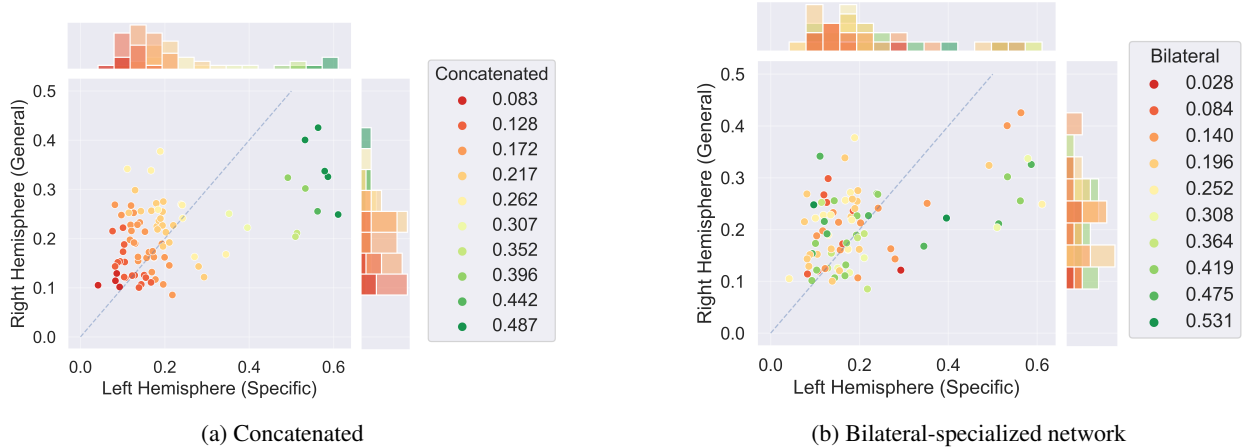

Figure 9: **Cosine similarity distribution for Scenario 1: The bilateral-specialized network is correct, left and right hemispheres are incorrect.** Many of the pairs (same label) have dissimilar (values closer to 0) features in left and right, seen in the density of points close to the origin. The concatenated features are also dissimilar, but the bilateral network elevates the similarity of many of the points. Each point is a pair of images with the same label. The x-axis is similarity in the left hemisphere, y-axis is similarity in the right hemisphere. The color is similarity in the combined representation. Additionally, the univariate marginal distributions are shown for left and right with histograms above and to the side of the bivariate distribution.

## 6.5 Why it's important

The key findings are a small step towards understanding and taking advantage of the characteristics of biological brains, and show the potential of bilateralism to improve ML/AI. More broadly, it's a biological principle that warrants further investigation.

The fact that bilateralism has a material effect on the network as a whole, suggests that bilateralism should be considered for other cognitive neuroscience models, where it is usually ignored. One potentially fruitful area is extending the standard Hippocampal/Neocortical model, CLS [47, 48], by introducing asymmetries into the bilateral Hippocampal architecture. Indeed, evidence exists of asymmetric contributions of left and right Hippocampi to memory [49, 50].

Bilateralism could also inspire new priors or inductive biases to improve ML models.

## 6.6 Future work

Given that conventional ensembling was effective, and in addition differential specialization provided benefits, it would be interesting to examine the advantage of each. For example, does one of these methods take you further on different or more difficult datasets? Furthermore, are there ways to combine aspects of both methods, such as ensembling bilateral models – would this be more effective than simply increasing the size of the ensemble for the same total number of hemispheres. Finally, can we leverage the specialized features in more effective ways, such as using a combiner network as opposed to simple concatenation of features.

A promising direction to improve the model as well as our understanding of the neuroscience, is to further investigate and model the neurobiology. There are several avenues. For example, replicating recurrent connectivity, more

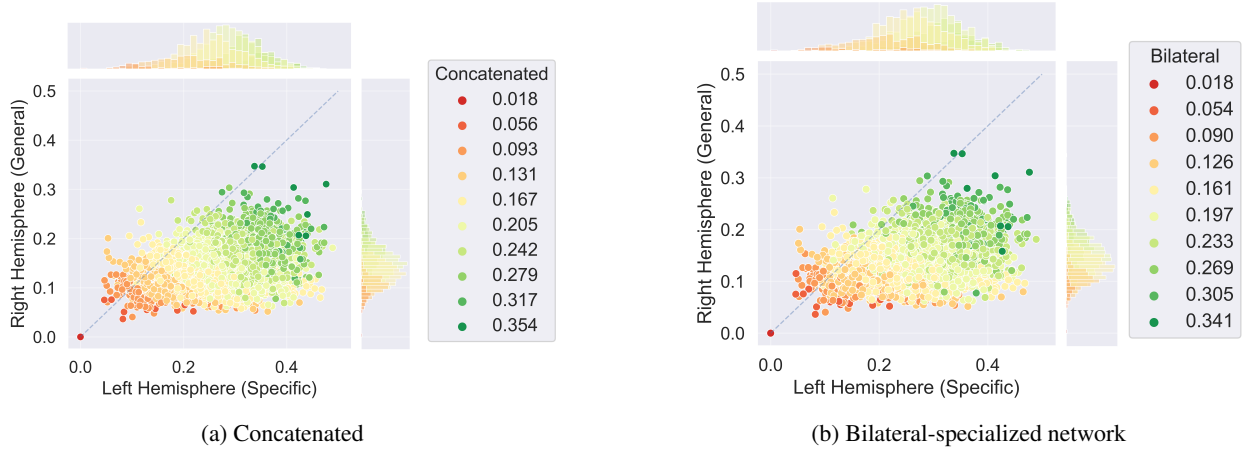

Figure 10: **Cosine similarity distribution for Scenario 2: The bilateral-specialized network and the right hemisphere are correct, the left hemisphere is incorrect.** Some regions with points that have low similarity in the left (at approximately  $x, y = 0.2, 0.2$ ), have elevated similarity in the bilateral output, compared to concatenated. Also, for points with high similarity in the left (approximately  $0.35, 0.1$ ), the similarity is lower in the bilateral output. In other words, the bilateral network was able to exploit features in the right hemisphere over the left. Each point is a pair of images with the same label. The x-axis is similarity in the left hemisphere, y-axis is similarity in the right hemisphere. The color is similarity in the combined representation. Additionally, the univariate marginal distributions are shown for left and right with histograms above and to the side of the bivariate distribution.

complex biologically inspired interactions between the hemispheres, mimicking known substrate differences between the hemispheres such as topological differences, resource allocation (see Figure ??) and experiments on inducing specialization without supervision.

This study focused on one aspect of bilateralism with an image classification task. There are also interesting lateral effects for motor control. For example, in most people, the right hand is better at trajectories, and the left hand is better at position/posture (dynamic dominance theory [51]). Developing an architecture and experiments to explore motor control is an interesting area for future work.

One theory is that the observed differences between the hemispheres emerge from a more fundamental specialization for novelty (right) and routine (left) [4, 5, 52]. These ideas could be explored with an agent that can act in a dynamic environment. The right hemisphere could be a generalist that can perform unfamiliar tasks as a beginner, while the left becomes an expert over time. The agent would be able to adopt new tasks, without being inept at them. Currently, the field of Continual RL does not focus on avoiding poor performance, but rather maximizing the best performance. In real-life scenarios however, an agent must avoid death and serious injury to themselves and those around them (also relevant for physical robots and virtual artificial agents).

As mentioned earlier in this section, bilateralism could be incorporated into existing cognitive computational models, and the benefits of bilateralism could be studied within more powerful ML architectures.

## 7 Conclusion

We built a bilateral architecture with left and right neural networks, inspired by our bilateral brains. The hemispheres were trained to specialize on fine and coarse classes. They extracted specialized features and through a type of ‘weighted attention’ by a simple fully connected layer, outperformed various (but not all) baselines on classification of both fine and coarse classes. The specialized representations had benefits above the explicit objective of their individual hemispheres. The results demonstrate that small procedural changes to training can achieve specialization, and that specialization can be complementary and beneficial for certain tasks. The operation of the artificial network provides ideas for the study of neurobiological hemispheric specialization. Simultaneously, this work shows that neuroscientific principles can provide inductive biases for novel ML architectures. Currently, in the field of AI/ML where scaling of existing architectures is achieving great success, it’s interesting to look at new principles on smaller architecture that could then be scaled.

## Acknowledgments

In an earlier Masters project, co-supervised by Levin Kuhlmann, Amir Mayan explored similar ideas, which formed a valuable background to planning this project. Thanks to Punarjay Chakravarty for helpful discussions.

## Author contributions

GK conceived and supervised the project, CR designed and implemented the experiments, GK and CR authored the manuscript, DR advised and assisted with the manuscript and EG introduced the concept and provided advice. All authors read and approved the final manuscript.

## References

- [1] Natalia Shevtsova and James A. Reggia. A neural network model of lateralization during letter identification. *Journal of Cognitive Neuroscience*, 11:167–181, 1999. ISSN 0898929X. doi:[10.1162/089892999563300](https://doi.org/10.1162/089892999563300). URL [/record/1999-05033-003](https://record/1999-05033-003).
- [2] Scott A. Weems and James A. Reggia. Hemispheric specialization and independence for word recognition: A comparison of three computational models. *Brain and Language*, 89:554–568, 6 2004. ISSN 0093-934X. doi:[10.1016/J.BANDL.2004.02.001](https://doi.org/10.1016/J.BANDL.2004.02.001).
- [3] Ya Ning Chang and Matthew A. Lambon Ralph. A unified neurocomputational bilateral model of spoken language production in healthy participants and recovery in poststroke aphasia. *Proceedings of the National Academy of Sciences of the United States of America*, 117:32779–32790, 12 2020. ISSN 10916490. doi:[10.1073/PNAS.2010193117/SUPPL\\_FILE/PNAS.2010193117.SAPP.PDF](https://doi.org/10.1073/PNAS.2010193117/SUPPL_FILE/PNAS.2010193117.SAPP.PDF). URL <https://www.pnas.org/doi/abs/10.1073/pnas.2010193117>.
- [4] Elkhonon Goldberg and Louis D Costa. Hemisphere differences in the acquisition and use of descriptive systems. *Brain and Language*, 14:144–173, 1981. ISSN 0093-934X. doi:[https://doi.org/10.1016/0093-934X\(81\)90072-9](https://doi.org/10.1016/0093-934X(81)90072-9). URL <https://www.sciencedirect.com/science/article/pii/0093934X81900729>.
- [5] E. Goldberg, K. Podell, and M. Lovell. Lateralization of frontal lobe functions and cognitive novelty. *Journal of Neuropsychiatry and Clinical Neurosciences*, 6:371–378, 1994. ISSN 08950172. doi:[10.1176/JNP.6.4.371](https://doi.org/10.1176/JNP.6.4.371). URL [/record/1995-12594-001](https://record/1995-12594-001).
- [6] Elkhonon Goldberg, Donovan Roediger, N Erkut Kucukboyaci, Chad Carlson, Orrin Devinsky, Ruben Kuzniecky, Eric Halgren, and Thomas Thesen. Hemispheric asymmetries of cortical volume in the human brain. *Cortex*, 49: 200–210, 2013. ISSN 00109452. doi:[10.1016/j.cortex.2011.11.002](https://doi.org/10.1016/j.cortex.2011.11.002). URL <http://dx.doi.org/10.1016/j.cortex.2011.11.002>.
- [7] Chandramouli Rajagopalan and Gideon Kowadlo. Bilateral brain (v1.0) [computer software], 2022. URL <https://github.com/Cerenaut/bilateral-brain>.
- [8] Anna C. Schapiro, James L. McClelland, Stephen R. Welbourne, Timothy T. Rogers, and Matthew A. Lambon Ralph. Why bilateral damage is worse than unilateral damage to the brain. *Journal of Cognitive Neuroscience*, 25:2107–2123, 12 2013. ISSN 0898-929X. doi:[10.1162/JOCN\\_A\\_00441](https://doi.org/10.1162/JOCN_A_00441). URL <https://direct.mit.edu/jocn/article/25/12/2107/28012/Why-Bilateral-Damage-Is-Worse-than-Unilateral>.
- [9] Orna Peleg, Larry Manevitz, Hananel Hazan, and Zohar Eviatar. Two hemispheres—two networks: a computational model explaining hemispheric asymmetries while reading ambiguous words. *Annals of Mathematics and Artificial Intelligence* 2010 59:1, 59:125–147, 8 2010. ISSN 1573-7470. doi:[10.1007/S10472-010-9210-1](https://doi.org/10.1007/S10472-010-9210-1). URL <https://link.springer.com/article/10.1007/s10472-010-9210-1>.
- [10] James A. Reggia, Sharon Goodall, and Yuri Shkuro. Computational studies of lateralization of phoneme sequence generation. *Neural Computation*, 10:1277–1297, 7 1998. ISSN 0899-7667. doi:[10.1162/089976698300017458](https://doi.org/10.1162/089976698300017458). URL <https://direct.mit.edu/neco/article/10/5/1277/6196/Computational-Studies-of-Lateralization-of-Phoneme>.
- [11] Panqu Wang and Garrison Cottrell. A computational model of the development of hemispheric asymmetry of face processing. *Proceedings of the Annual Meeting of the Cognitive Science Society*, 35:35, 2013. ISSN 1069-7977.
- [12] Padraic Monaghan, Richard Shillcock, and Scott McDonald. Hemispheric asymmetries in the split-fovea model of semantic processing. *Brain and Language*, 88:339–354, 3 2004. ISSN 0093-934X. doi:[10.1016/S0093-934X\(03\)00165-2](https://doi.org/10.1016/S0093-934X(03)00165-2).

- [13] Padraic Monaghan and Richard Shillcock. Hemispheric dissociation and dyslexia in a computational model of reading. *Brain and Language*, 107:185–193, 12 2008. ISSN 0093-934X. doi:[10.1016/J.BANDL.2007.12.005](https://doi.org/10.1016/J.BANDL.2007.12.005).
- [14] Janet Hui Wen Hsiao, Danke X. Shieh, and Garrison W. Cottrell. Convergence of the visual field split: Hemispheric modeling of face and object recognition. *Journal of Cognitive Neuroscience*, 20:2298–2307, 12 2008. ISSN 0898929X. doi:[10.1162/JOCN.2008.20162](https://doi.org/10.1162/JOCN.2008.20162).
- [15] M. N. Dailey and G. W. Cottrell. Organization of face and object recognition in modular neural network models. *Neural Networks*, 12:1053–1074, 10 1999. ISSN 0893-6080. doi:[10.1016/S0893-6080\(99\)00050-7](https://doi.org/10.1016/S0893-6080(99)00050-7).
- [16] Richard Shillcock and Padraic Monaghan. The computational exploration of visual word recognition in a split model. *Neural Computation*, 13:1171–1198, 5 2001. ISSN 08997667. doi:[10.1162/08997660151134370](https://doi.org/10.1162/08997660151134370).
- [17] Padraic Monaghan and Richard Shillcock. Hemispheric asymmetries in cognitive modeling: connectionist modeling of unilateral visual neglect. *Psychological review*, 111:283–308, 4 2004. ISSN 0033-295X. doi:[10.1037/0033-295X.111.2.283](https://doi.org/10.1037/0033-295X.111.2.283). URL <https://pubmed.ncbi.nlm.nih.gov/15065911/>.
- [18] M. A. Lambon Ralph, J. L. McClelland, K. Patterson, C. J. Galton, and J. R. Hodges. No right to speak? the relationship between object naming and semantic impairment: neuropsychological evidence and a computational model. *Journal of Cognitive Neuroscience*, 13:341–356, 4 2001. ISSN 0898-929X. doi:[10.1162/08989290151137395](https://doi.org/10.1162/08989290151137395). URL <https://direct.mit.edu/jocn/article/13/3/341/3557/No-Right-to-Speak-The-Relationship-between-Object>.
- [19] Amir Mayan, Gideon Kowadlo, and Levin Kuhlmann. Right and left neural networks – inspired by the bicameral brain, 2021.
- [20] Shawn Beaulieu, Lapo Frati, Thomas Miconi, Joel Lehman, Kenneth O Stanley, Jeff Clune, and Nick Cheney. Learning to continually learn. volume 325, pages 992–1001. {IOS} Press, 2020. doi:[10.3233/FAIA200193](https://doi.org/10.3233/FAIA200193). URL <https://doi.org/10.3233/FAIA200193>.
- [21] Shahab Bakhtiari, Patrick Mineault, Tim Lillicrap, Christopher C Pack, and Blake A Richards. The functional specialization of visual cortex emerges from training parallel pathways with self-supervised predictive learning. *bioRxiv*, page 2021.06.18.448989, 2021. URL <https://www.biorxiv.org/content/10.1101/2021.06.18.448989v1>. abstract%0Ahttps://www.biorxiv.org/content/10.1101/2021.06.18.448989v1%0Ahttps://www.biorxiv.org/content/10.1101/2021.06.18.448989v1.
- [22] Chenguang Li and Arturo Deza. What matters in branch specialization? using a toy task to make predictions. 2021. URL <https://openreview.net/forum?id=0kPS1i6wict>.
- [23] Omer Sagi and Lior Rokach. Ensemble learning: A survey. *Wiley Interdisciplinary Reviews: Data Mining and Knowledge Discovery*, 8:e1249, 7 2018. ISSN 1942-4795. doi:[10.1002/WIDM.1249](https://doi.org/10.1002/WIDM.1249). URL <https://onlinelibrary.wiley.com/doi/full/10.1002/widm.1249><https://onlinelibrary.wiley.com/doi/abs/10.1002/widm.1249><https://wires.onlinelibrary.wiley.com/doi/10.1002/widm.1249>.
- [24] Jin Tian, Minqiang Li, Fuzan Chen, and Jisong Kou. Coevolutionary learning of neural network ensemble for complex classification tasks. *Pattern Recognition*, 45:1373–1385, 4 2012. ISSN 0031-3203. doi:[10.1016/J.PATCOG.2011.09.012](https://doi.org/10.1016/J.PATCOG.2011.09.012).
- [25] Stefan Lee, Senthil Purushwalkam, Michael Cogswell, David Crandall, and Dhruv Batra. Why m heads are better than one: Training a diverse ensemble of deep networks. 11 2015. doi:[10.48550/arxiv.1511.06314](https://doi.org/10.48550/arxiv.1511.06314). URL <https://arxiv.org/abs/1511.06314v1>.
- [26] Kazi Md Rokibul Alam, Nazmul Siddique, and Hojjat Adeli. A dynamic ensemble learning algorithm for neural networks. *Neural Computing and Applications*, 32:8675–8690, 6 2020. ISSN 14333058. doi:[10.1007/S00521-019-04359-7](https://doi.org/10.1007/S00521-019-04359-7). URL <https://link.springer.com/article/10.1007/s00521-019-04359-7>.
- [27] Rui He, Shengcai Liu, Shan He, and Ke Tang. Multi-Domain Active Learning: Literature Review and Comparative Study, October 2022. URL <http://arxiv.org/abs/2106.13516>. arXiv:2106.13516 [cs].
- [28] Mahesh Joshi, Mark Dredze, William Cohen, and Carolyn Rose. Multi-domain learning: when do domains matter? In *Proceedings of the 2012 Joint Conference on Empirical Methods in Natural Language Processing and Computational Natural Language Learning*, pages 1302–1312, 2012.
- [29] Yimin Chen, Rongrong Lu, Yibo Zou, and Yanhui Zhang. Branch-activated multi-domain convolutional neural network for visual tracking. *Journal of Shanghai Jiaotong University (Science)*, 23:360–367, 2018.
- [30] Alex Krizhevsky. Learning multiple layers of features from tiny images, 2009.
- [31] Jia Deng, Wei Dong, Richard Socher, Li-Jia Li, Kai Li, and Li Fei-Fei. Imagenet: A large-scale hierarchical image database. pages 248–255, 3 2010. doi:[10.1109/CVPR.2009.5206848](https://doi.org/10.1109/CVPR.2009.5206848).

- [32] Brenden M Lake, Ruslan Salakhutdinov, and Joshua B Tenenbaum. Human-level concept learning through probabilistic program induction. *Science*, 350:1332–1338, 2015. ISSN 10959203. doi:[10.1126/science.aab3050](https://doi.org/10.1126/science.aab3050).
- [33] Eleni Triantafyllou, Tyler Zhu, Vincent Dumoulin, Pascal Lamblin, Utku Evci, Kelvin Xu, Ross Goroshin, Carles Gelada, Kevin Swersky, Pierre-Antoine Manzagol, and Hugo Larochelle. Meta-dataset: A dataset of datasets for learning to learn from few examples. 3 2020. doi:[10.48550/arxiv.1903.03096](https://doi.org/10.48550/arxiv.1903.03096). URL <https://arxiv.org/abs/1903.03096v4>.
- [34] Massimo Caccia, Pau Rodriguez, Oleksiy Ostapenko, Fabrice Normandin, Min Lin, Lucas Page-Caccia, Issam Hadj Laradji, Irina Rish, Alexandre Lacoste, David Vázquez, and Laurent Charlin. Online fast adaptation and knowledge accumulation (osaka): a new approach to continual learning. *Advances in Neural Information Processing Systems*, 33:16532–16545, 2020. URL <https://github.com/ElementAI/osaka>.
- [35] Kaiming He, Xiangyu Zhang, Shaoqing Ren, and Jian Sun. Deep residual learning for image recognition. *Proceedings of the IEEE Computer Society Conference on Computer Vision and Pattern Recognition*, 2016–Decem:770–778, 9 2015. ISSN 10636919. doi:[10.48550/arxiv.1512.03385](https://doi.org/10.48550/arxiv.1512.03385). URL <https://arxiv.org/abs/1512.03385v1>.
- [36] Karen Simonyan and Andrew Zisserman. Very Deep Convolutional Networks for Large-Scale Image Recognition, April 2015. URL <http://arxiv.org/abs/1409.1556>. arXiv:1409.1556 [cs].
- [37] Arild Nøkland and Lars Hiller Eidnes. Training Neural Networks with Local Error Signals, May 2019. URL <http://arxiv.org/abs/1901.06656>. arXiv:1901.06656 [cs, stat].
- [38] Nitish Srivastava, Geoffrey Hinton, Alex Krizhevsky, Ilya Sutskever, and Ruslan Salakhutdinov. Dropout: A simple way to prevent neural networks from overfitting. *Journal of Machine Learning Research*, 15:1929–1958, 2014.
- [39] Diederik P Kingma and Jimmy Ba. Adam: A method for stochastic optimization. 9 2014. URL <http://arxiv.org/abs/1412.6980>.
- [40] William Falcon and contributors. Pytorch lightning (v1.4.1) [computer software], 2019. URL <https://github.com/PyTorchLightning/pytorch-lightning>.
- [41] Adam Paszke, Sam Gross, Francisco Massa, Adam Lerer, James Bradbury, Gregory Chanan, Trevor Killeen, Zeming Lin, Natalia Gimelshein, Luca Antiga, Alban Desmaison, Andreas Köpf, Edward Yang, Zach DeVito, Martin Raison, Alykhan Tejani, Sasank Chilamkurthy, Benoit Steiner, Lu Fang, Junjie Bai, and Soumith Chintala. Pytorch: An imperative style, high-performance deep learning library. *Advances in Neural Information Processing Systems*, 32, 2019. ISSN 10495258.
- [42] Aditya Chattopadhyay, Anirban Sarkar, Prantik Howlader, and Vineeth N Balasubramanian. Grad-cam++: Improved visual explanations for deep convolutional networks. 9 2017. doi:[10.1109/WACV.2018.00097](https://doi.org/10.1109/WACV.2018.00097). URL <http://arxiv.org/abs/1710.11063><http://dx.doi.org/10.1109/WACV.2018.00097>.
- [43] Ramprasaath R Selvaraju, Michael Cogswell, Abhishek Das, Ramakrishna Vedantam, Devi Parikh, and Dhruv Batra. Grad-cam: Visual explanations from deep networks via gradient-based localization. 9 2016. doi:[10.1007/s11263-019-01228-7](https://doi.org/10.1007/s11263-019-01228-7). URL <http://arxiv.org/abs/1610.02391><http://dx.doi.org/10.1007/s11263-019-01228-7>.
- [44] Jacob Gildenblat and contributors. Pytorch library for cam methods (v1.4.5) [computer software], 2021. URL <https://github.com/jacobgil/pytorch-grad-cam>.
- [45] Richard G. Carson. Inter-hemispheric inhibition sculpts the output of neural circuits by co-opting the two cerebral hemispheres. *The Journal of Physiology*, 598:4781–4802, 11 2020. ISSN 1469-7793. doi:[10.1113/JP279793](https://doi.org/10.1113/JP279793). URL <https://onlinelibrary.wiley.com/doi/full/10.1113/JP279793><https://physoc.onlinelibrary.wiley.com/doi/10.1113/JP279793>.
- [46] Gorana Pobric, Nira Mashal, Miriam Faust, and Michal Lavidor. The role of the right cerebral hemisphere in processing novel metaphoric expressions: A transcranial magnetic stimulation study. *Journal of Cognitive Neuroscience*, 20:170–181, 1 2008. ISSN 0898-929X. doi:[10.1162/JOCN.2008.20005](https://doi.org/10.1162/JOCN.2008.20005). URL <https://direct.mit.edu/jocn/article/20/1/170/4440/The-Role-of-the-Right-Cerebral-Hemisphere-in>.
- [47] James L McClelland, Bruce L McNaughton, and Randall C O’Reilly. Why there are complementary learning systems in the hippocampus and neocortex: Insights from the successes and failures of connectionist models of learning and memory. *Psychological Review*, 102:419–457, 1995. ISSN 0033295X. doi:[10.1037/0033-295X.102.3.419](https://doi.org/10.1037/0033-295X.102.3.419).
- [48] Randall C O’Reilly, Rajan Bhattacharyya, Michael D Howard, and Nicholas Ketz. Complementary learning systems. *Cognitive Science*, 38:1229–1248, 2014. ISSN 03640213. doi:[10.1111/j.1551-6709.2011.01214.x](https://doi.org/10.1111/j.1551-6709.2011.01214.x).

- 
- [49] Olivia A. Shipton, Mohamady El-Gaby, John Apergis-Schoute, Karl Deisseroth, David M. Bannerman, Ole Paulsen, and Michael M. Kohl. Left-right dissociation of hippocampal memory processes in mice. *Proceedings of the National Academy of Sciences of the United States of America*, 111:15238–15243, 10 2014. ISSN 10916490. doi:10.1073/PNAS.1405648111/SUPPL\_FILE/PNAS.201405648SI.PDF. URL <https://www.pnas.org/doi/abs/10.1073/pnas.1405648111>.
- [50] Mohamady El-Gaby, Olivia A. Shipton, and Ole Paulsen. Synaptic plasticity and memory. <http://dx.doi.org/10.1177/1073858414550658>, 21:490–502, 9 2014. ISSN 10894098. doi:10.1177/1073858414550658. URL <https://journals.sagepub.com/doi/abs/10.1177/1073858414550658>.
- [51] Robert L. Sainburg. Handedness: Differential specializations for control of trajectory and position. *Exercise and Sport Sciences Reviews*, 33:206–213, 10 2005. ISSN 0091-6331. doi:10.1097/00003677-200510000-00010. URL <https://pennstate.pure.elsevier.com/en/publications/handedness-differential-specializations-for-control-of-trajectory>.
- [52] Elkhonon. Goldberg. *The new executive brain: frontal lobes in a complex world*. Oxford University Press, 2009. ISBN 9780195329407.