

Scalable Proof Producing Multi-Threaded SAT Solving with Gimsatul through Sharing instead of Copying Clauses

Mathias Fleury  and Armin Biere 

Albert-Ludwig-Universität Freiburg, Germany
fleury@cs.uni-freiburg.de biere@cs.uni-freiburg.de

Abstract

We give a first account of our new parallel SAT solver Gimsatul. Its key feature is to share clauses physically in memory instead of copying them, which is the method of other state-of-the-art multi-threaded SAT solvers to exchange clauses logically. Our approach keeps information about which literals are watched in a clause local to a solving thread but shares the actual immutable literals of a clause globally among all solving threads. This design gives quite remarkable parallel scalability, allows aggressive clause sharing while keeping memory usage low and produces more compact proofs.

1 Introduction

The SAT Competition is the place to show off the newest and fastest SAT solvers for many years now. To improve reliability and increase correctness, every solver in the main track must produce a DRAT certificate that is checked by the official checker DRAT-TRIM – and only checked problems count as solved. Solvers implementing techniques that cannot be expressed in DRAT can only take part in the no-limit track (even if no technique seems to bring an edge over other main-track solvers). While sequential solvers have improved considerably recently, making use of multiple CPU cores can improve performance even further. Therefore the SAT Competition has a parallel and a cloud track. In those track no proofs are required.

There are several ways to parallelize SAT solvers (Section 2), but most solvers in both the parallel and the cloud track rely on the common portfolio approach pioneered by MANYSAT [7] enhanced by exchanging clauses. The idea is to rely on existing fast single-core SAT solvers without the need to modify them beyond possibly adding a mechanism for exchanging clauses. The main approach to exchange clauses between solver threads is copying them.

The main argument in favor of this approach is that adding a light-weight synchronization to existing code is simple and does not need to change the sophisticated and complex core data-structures of the solvers. We argue that this argument leads to sub-optimal results both with respect to scalability and memory usage. Instead we propose to physically share clause data (through pointers) during exchanging clauses instead of copying them.

More precisely, the classical portfolio approach generates two issues (Section 3). First, it increases the amount of memory needed by each solver thread. Second, even if proof production was implemented, it produces larger proofs than necessary by requiring duplicating shared clauses in the proof. By actually sharing instead of copying clauses we can address both issues.

Current proof checkers do not support exchanging clauses between certificates and it is not obvious how to do this correctly, because clause exchanges go in both directions. The other issue is that proof checking cannot completely independently be done in parallel, again, because the solver threads exchange clauses. One partial solution to the problem is to log all the clauses into a single file and have a global clock to serialize all the derived clauses in order. However this solution still requires to duplicate exchanged clauses in the proof log, leading to large traces and long checking times, as also our experiments confirm.

In order to reduce this work, we have started a new SAT solver called GIMSATUL that aggressively shares clauses among the solver instances. We revisit an old idea that co-existed with the currently dominating exchange-only approach until around 2011, which on the other hand pre-dates more sophisticated proof tracing techniques used in the SAT competition now as well as all the improvements to sequential solving made in the last decade. We observe that physically sharing clauses not only makes it possible to reduce the memory footprint, but also enables sharing in the proof log, thus reducing the amount of work required for checking. While these changes have a large impact on the core data-structures of the SAT solver they do not require any change to existing proof checkers.

We implemented our new solver GIMSATUL in 13kloc of C. It is available online¹ and uses atomic operations to adjust reference counters and exchange pointers, as standardized with C11 in `stdatomic.h`. It relies on the Pthreads programming model for threads, locking, and condition variables. Furthermore it uses lockless fast-path code whenever reasonable.

The name GIMSATUL is derived from *gimbatul* in the “Black Speech” language invented by R. Tolkien and occurs in the inscription of the “One Ring” in “Lord of the Rings” and literally translates to “find them” (all). We follow that terminology in the paper and in the source code. Accordingly the main thread which performs preprocessing sequentially and organizes everything is called the *Ruler* and an actual solver thread is called *ring*.

Besides briefly going over the architecture of the solver we focus in this paper on describing differences to the core data-structures compared to other solvers. In particular watched literals cannot be kept as the first two literals in the clauses, since different solver instances may need to watch different literals (Section 4). The solver also performs sequential inprocessing, requiring to give back all irredundant clauses to a single instance. This new infrastructure makes sharing possible and space efficient. The main advantage as highlighted by our experiments is that our solver scales *linearly* with the number of threads. Another major consequence is that sharing ensures that less memory is required to run GIMSATUL (Section 5).

Finally, we compare DRUP/DRAT proofs generated by GIMSATUL (Section 6) with the version of the solver where sharing is not done at the proof level and instead clauses are duplicated in the proofs (Section 7). We show that proof size is largely independent of the number of threads.

2 Parallel SAT Solving and Related Work

This work does not attempt to define what SAT is and how SAT solvers works in details. For those details, we refer to the *Handbook of Satisfiability* [4]. Detailed knowledge about the inner working of SAT solvers is not required beyond the fact that SAT solvers resolves clauses to derive new clauses and that those clauses can be exchanged if two solvers work on the same problem. Non-satisfiability preserving transformation are not done in parallel.

With respect to parallelization, we classify the approaches used by SAT solvers into three different categories, as shown in the following table:

| | One solver | Several solvers |
|-------------------|--|--|
| One Problem | CDCL + simplification (1) (e.g., KISSAT [3]) | Portfolio (2) (e.g., MALLOB [15]) |
| Multiple Problems | Cube-and-conquer (CnC) by hand (3) (e.g., Marijn Heule [9]) | CnC + resplitting + sharing (4) (e.g., PARACOOBA [3]) |

¹<https://github.com/arminbiere/gimsatul>

Note that some solvers also combine techniques like PAINLESS [6] from (2) and (4), but in their default configuration from the SAT Competition, they use Approach (2). In this work we reconsider Approach (2) where current solvers rely on mostly unmodified single-core SAT solver engines. The current state-of-the-art solvers rely on (logically) *exchanging* clauses through copying but not physically sharing them.

Usually this approach further takes advantage of the portfolio idea: different solver threads use different strategies, e.g., different restart scheduling, decision heuristics, etc. The hope is that different instances learn clauses useful in other threads, especially short clauses.

For detailed information on the architecture or the solver that used physical sharing of clauses before 2011 (even though none of these solvers seems to be maintained anymore) we refer to the corresponding chapter in the *Handbook of Parallel Constraint Reasoning* [1]. Most current research tries to improve the portfolio approach and investigates better selection of clauses to exchange. Another interesting idea is to let a GPU select the clauses which are useful [13], partially based on the idea the clauses that would have produced a conflict earlier are likely useful in the future too. We focus on scalability and proofs and leave this aspect to future work.

3 Proof Checking

In the previous section we discussed the different approach to solve problems. Proof checking has a different flavor:

| | One solver | Several solvers |
|-------------------|--|---|
| One Problem | one checker (e.g., DRAT-TRIM [19]) (1) | previous work and this paper (2) (e.g., DRAT-TRIM [19]) |
| Multiple Problems | parallel checker (e.g., CAKE_LPR [17]) (3) | none |

Checking (1) is the most standard and best understood approach, even if there is some technical issue on the semantics of (reused) units [14]. The approach (3) is very promising to check cube-and-conquer proofs. The checker checks each proof (i.e., the one with the cubes) and checks that the cubes cover the entire search space. All those checks can be done in parallel. There are some limitations in the verified proof checker of (3); for example, cubes generated by MARCH cannot be used because trivially unsatisfiable cubes are removed from the clauses, and more critically, the “exchange” of information that the cubes are unsatisfiable is done via (forgeable) command line arguments (while the checking itself is verified in CakeML).

In this paper we attempt to both improve the memory requirement by sharing physically clauses and also, as a side effect, to reduce the size of the proofs.

4 GIMSATUL

The key difference of our new solver GIMSATUL compared to all recent portfolio solver is the physical sharing of clauses. In order to do so, we have to revisit the implementation of watched literals, a data structure to identify propagation and conflicts (Section 4.2). Invariants on watched literals also limit how clauses can be imported by an instance (Section 4.3). We further discuss how model reconstruction is used to handle units (Section 4.4) and how sequential inprocessing can be achieved with clause sharing (Section 4.5).

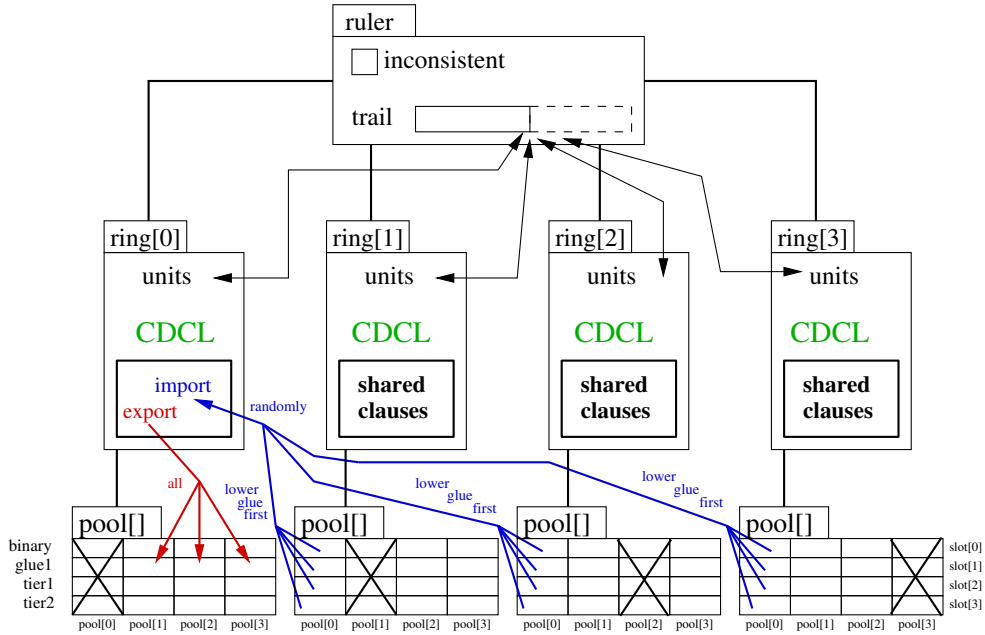

Figure 1: Exporting and importing learned clauses, including the empty clause through the “inconsistency” flag, learned units, and low glue clauses. Irredundant (including original) clauses are shared up-front while cloning the initial clause data-base (after pre- and inprocessing).

4.1 Overall Organization

The core SAT solvers in GIMSATUL follow the design of our other recent solvers, particularly they share many ideas with the “sc2022-light” version of KISSAT. There are two differences worth mentioning. First, the SAT solver does not use an arena to compactly represent the clauses in memory. One motivation for this trick is to put clauses consecutively in memory in the order in which the solver accesses them [16]. It further allows efficient garbage collection during clause data-base reduction (forgetting heuristically-unimportant learned clauses). This is something that we cannot do for GIMSATUL because each ring (solver instance) completely independently allocates and reduces clauses in memory. Hence, we allocate memory with `malloc`. Second, we use two watch lists, one for binary watch lists (shared across the instances) and one for watching clauses, unlike the single watch list used in our other solvers.

Overall the solving process looks as follows. First, the main thread called *Ruler* parses and allocates all clauses. At that point, the *Ruler* owns all the clauses. It then enters a “cloning” phase, which first passes all its clauses to the first ring as new owner. It also creates the shared global watch lists for irredundant binary clauses. This first instance is then forked into as many instances as needed, to match the number of requested solving threads given on the command line, sharing all large clauses through new sets of watched literal lists. However, each solver instance reuses the same watch lists (a flat literal array) for the irredundant binary clauses.

After cloning, solvers start solving the CNF individually, importing and exporting learned clauses (Section 4.3). The first solver instance to determine the problem as solved is declared the winner and a termination flag is raised, forcing other solver threads to exit their CDCL loop too. If the winner deduced the empty clause the problem is unsatisfiable. Otherwise it has found a satisfying assignment which is then extended by the main thread to a full model using

| Ring number mod 12 | 0 | 1 | 2 | 3 | 4 | 5 | 6 | 7 | 8 | 9 | 10 | 11 |
|--------------------|-----|---|---|-----|---|---|-----|---|---|-----|----|----|
| Mode | S+F | S | F | S+F | S | F | S+F | S | F | S+F | S | F |
| Phase | 0 | 1 | 0 | 1 | 0 | 1 | 0 | 1 | 0 | 1 | 0 | 1 |
| Reason Bumping | 0 | 0 | 1 | 1 | 0 | 0 | 1 | 1 | 0 | 0 | 1 | 1 |

Table 1: Strategy of each thread (S = stable, F = Focused)

the reconstruction stack of the *Ruler/Simplifier* produced during pre- and inprocessing.

All solver instances logically reclaim (dereference) clauses satisfied by learned root-level units, as part of frequent clause-database reductions, which mainly have the purpose of discarding useless learned clauses. However, reclaiming in this context just means decreasing the reference count of a clause. Only until the satisfying root-level unit has reached all solver instances and is picked up during clause-database reduction, that root-level clause is finally physically deallocated (and is also deleted in the proof trace).

Cleaning the clauses from root-level falsified literals is much more involved, as the actual clauses can not be shrunk in parallel – the blocking and watched literals potentially have to be changed. For that purpose the first ring is responsible for starting simplification rounds during which all irredundant clauses are handed over back to the *Ruler*. Redundant watches pointing to redundant clauses are saved locally for each ring separately. After this preparation phase (called “uncloning” in the code), the inprocessing can start.

As clauses are shared we do not remove falsified literals during solving. Instead solvers synchronize regularly and *hand* back their clauses to the initial thread which then, in the role of the *Ruler* process, becomes responsible for (i) removing satisfied clauses (which is something that can already be done by each ring by marking the clause as removed locally), (ii) removing false literals from clauses, and (iii) renumbering literals if holes appeared to keep literals compact. After that, the heuristics are adapted (by renaming literals in those heuristics too).

Besides sharing clauses and waiting for each other for inprocessing, all solver instances are independent of each other and can run using a different strategy. We currently use a simple and limited portfolio: we use a different initialization for the first random walk (limited local search) that initializes the phases, which is one of the phases of our rephasing strategy [2]. The result of this walk is exported and used as saved phases initially, leading the solver to different search directions. Interestingly, we initially had no diversification at all and already observed improvement in the performance of the solver, due the exchange of clauses (described in more details in Section 4.3). In Table 1, we show the amount of diversification we do, but note, that we currently only have 12 different configurations.

4.2 Revisiting Propagations

Since zCHAFF [11], all modern SAT solvers use *watched literals* to identify clauses that can propagate or are in conflict. The idea is to distinguish two literals in a clause. Whenever either of those literals is set to false, then the clause must be checked to see if it can propagate information or is conflicting. Otherwise, the clauses do not need to be updated (nor visited). This is essential to make propagations and conflict detection efficient. Originally pointers to the two watched literals in each clause were used. Modern implementation however make sure that the first two literals of the clause are watched, by swapping clause literals during propagation.

However, insisting on watching exactly the first two literals does not work when sharing clauses because different solver threads (rings) have different partial assignments (and trails)

and thus usually watch different clauses and literals in those clauses. Hence when sharing clauses we can not swap literals in the literal list of a clause anymore.

Our solution is to store the watched literal pair in a watcher data-structure separately, which also has a pointer to the immutable actual clause. Those watchers are *not* shared amongst solver instances, except for irredundant *binary clauses*, because they do not require any changes. It is important to notice that, as the clauses are not changed, there is no need for locks when accessing a clause by different threads.

The pair of literals in our thread-local watcher data-structure also serves as “blocking literals” which are checked first to satisfy the clause. This is a common technique to reduce the number of times the actual clause data has to be accessed. If the blocking literal check fails, however, this scheme incurs an additional pointer access compared to the standard version of placing the two watched literals in front of the literal list of a clause, effectively merging the clause and the watcher data-structure. On the other hand our watcher structure is much more compact than a full clause and thus likely has better cache locality.

4.3 Clause Sharing

An important design choice for parallel solvers is to determine which clauses to share and how often they are imported. We use a very simple policy: (i) at most one clause is imported before each decision and (ii) when learning a clause with a low glucose level, we immediately export it. We do however import and export all derived root-level assignments eagerly as well as check for termination and thus “inconsistency” (another thread proved the formula to be unsatisfiable). Figure 1 shows how the sharing happens and is described in the text below. All rings share the trail composed of unit literals.

Which Clauses to Import. When importing clauses before a decision, only a single one is imported at a time. To import and export clauses, each ring has 4 slots for each other ring with clauses to export: one for binary clauses (64 bits representing two 31-bit literals), glue 1 (non-binary) clauses, glue-2 clauses (remaining tier1 clauses), and finally tier2 clauses (glue 3 to 6). In Figure 1, the slots are called *pools* and the pool from a ring for itself is crossed out (because it is useless to have a ring share a clause with itself).

Before every decision, each ring attempts to import one clause after checking that no new units should be imported first. Without any new unit it selects its pool among the shared pools of another randomly chosen ring. The goal of randomly picking the exporting ring is to implement a global (bounded) queue with relaxed semantics [8], i.e., a bounded k -queue, which probabilistically guarantees low contention. Each queue is implicitly bounded because threads during exporting learned clauses simply overwrite references and thus drop clauses with the same glue class (binary, tier1, tier2, tier3) as the exported clause.

Then the importing ring checks its slots in order with lowest glue first (this is a fast-path without locking) if there is any clause to import (the blue arrows in Figure 1). If one is found, then the slot is emptied with an atomic exchange operation (thus requiring 64-bit word size).

Importing Clauses. As described in the previous paragraph, the solver imports one clause at a time. The current partial assignment on the trail has to be fixed if the clauses is propagating/conflicting. Otherwise, some literals (not arbitrary ones) have to be selected as watched literals to fulfill the watch list invariants.

Before we actually import a clause it is checked for not being already subsumed by another existing clauses, using the watch list as an approximation for occurrence lists. This forward subsumption check traverses the watcher list of a new watched literal which is smaller and thus might miss some subsuming clauses, but is complete for exact matches (identical clauses

ignoring root-level falsified literals). Besides adapting the current interpretation to the single imported clause, importing simply means watching the correct literals and adding the clauses to the correct watch lists.

In our implementation importing a clause amounts to increasing the overall number of occurrences of that clause. We rely on atomic operations to adjust these counters (using `atomic_fetch_add` and `atomic_fetch_sub` from `stdatomic.h` in C11).

In contrast to operating in single-threaded mode and unlike all our single-threaded SAT solvers GIMSATUL using multiple threads is highly *non-deterministic*, because importing clauses is done eagerly and depends on the exact thread scheduling, in which order memory accesses occur and caches are updated etc.

Exporting Clauses. Important learned clauses with small glucose level are exported immediately during the conflict analysis, with references to the exported clause added to the $n - 1$ pools of the exporting thread (the red arrows starting from ring 0 in Figure 1). Each pool corresponds to exactly one thread and has four slots of clauses references sorted by glucose level (binary, tier1, tier2, tier3 clauses). This allows to share these important learned clauses with all other solver threads, prioritized by importing low-glue clauses first.

Life and Death of Clauses. Remark that the clauses are imported according to the score they had previously and are handled the same way as every other learned clause. Therefore, low LBD clauses are never removed (in particular binary clauses), but unused tier2 clauses will eventually be deleted. Large tier1 clauses might be removed by vivification though.

4.4 Model Reconstruction

GIMSATUL relies on the model reconstruction [10] to produce a model and “undo” the inprocessing. This reconstruction stack is not shared amongst the rings. Instead, a single one is used. This is sufficient because all solvers work on the same formula.

Unlike previous solvers, we actually go one step further and completely remove fixed literals assigned at root-level (decision-level zero). In KISSAT we would also remove those literals but not remove them from external partial assignment. Therefore, we do not need to put those literals on the reconstruction stack. Reusing the reconstruction stack is in particular used for units derived during inprocessing techniques (see more details in the next paragraph), because it avoids communicating such literals back to each SAT instance.

4.5 Inprocessing

We have implemented two different kinds of inprocessing in GIMSATUL. Some transformations are part of probing like vivification. They run directly in the different rings but they do not shorten shared clauses. Instead a new shortened clause is added and the other is removed from the clause set. Other inprocessing techniques require to change the set of original or in general irredundant clauses such as bounded variable elimination [5]. For those transformation, each instance first gives up all references to the clauses. At the end, only the first instance knows the location in memory of all the clauses. It gives them back to the *Ruler* instance which then starts the *Simplifier*. This *Simplifier* is then in charge of transforming all the irredundant clauses (including shortening and strengthening them) using the standard algorithms, e.g., for variable elimination. After that the clause are passed back to the first ring which in turn passes them back to the other rings (with the shared watch list of binary clauses).

Getting this “uncloning” option to work was rather challenging, because units produced must still be shared amongst all rings. This in turn can enable more propagations at root-level

| | solved | sat | uns | elapsed time (s) | PAR-2 (10 ³) | space |
|--------------|------------|------------|------------|---------------------|-----------------------------|-----------|
| GIMSATUL-32 | 310 | 151 | 159 | 3 928 732 | 1 031 | 1 578 816 |
| P-MCOMSPS-32 | 315 | 141 | 174 | 5 804 244 | 1 037 | 3 038 965 |
| GIMSATUL-16 | 308 | 149 | 159 | 2 069 523 | 1 055 | 843 444 |
| P-MCOMSPS-16 | 309 | 136 | 173 | 2 607 129 | 1 076 | 1 495 201 |
| GIMSATUL-64 | 304 | 150 | 154 | 4 768 809 | 1 119 | 2 948 359 |
| GIMSATUL-8 | 298 | 144 | 154 | 1 223 199 | 1 178 | 460 013 |
| P-MCOMSPS-8 | 297 | 131 | 166 | 1 584 009 | 1 229 | 723 740 |
| GIMSATUL-4 | 282 | 138 | 144 | 744 566 | 1 371 | 263 227 |
| P-MCOMSPS-4 | 260 | 119 | 141 | 854 403 | 1 614 | 317 691 |
| GIMSATUL-2 | 262 | 130 | 132 | 499 420 | 1 633 | 167 771 |
| GIMSATUL-1 | 230 | 117 | 113 | 263 851 | 1 963 | 80 947 |
| P-MCOMSPS-2 | 204 | 87 | 117 | 679 142 | 2 187 | 187 676 |

Table 2: Results on the problems from the SAT Competition 2021

(at decision-level zero) that again needs to be shared. If this is not done properly, some units might get lost, which is an issue as then the candidate model of the different instances might not know about those units, leading potentially to incorrect models: If the *Simplifier* removes irredundant clauses containing a given literal, because this literal is not assigned and can appear in the redundant clauses, it can get assigned to the opposite value leading to an incorrect model.

5 Experiments on Scalability

We ran experiments² on our cluster equipped with Intel Xeon E5-2620 v4 CPU at 2.10 GHz (with turbo-mode disabled) with a memory limit of 128 GB for each node. Those CPUs have 16 real cores and 32 cores using hyper-threading. In order to keep the testing time reasonable (and running solvers in parallel), we assigned 127 GB for 8 cores or more, 63 GB for 4 cores, 31 GB for 2 cores, and 15 GB for 1 core.

Performance. We first compare the overall wall-clock-time performance of our solver GIMSATUL to the state-of-the-art solver P-MCOMSPS [18], which won the parallel track of the SAT Competition 2021. It features an advanced SAT core solver and incorporates many ideas to improve parallel solving including sophisticated diversification techniques. However, it fails when run with a single thread (producing an exception). We assume that this is due to the fact that one thread is used to strengthen clauses and the others for solving. Therefore we only consider experiments for P-MCOMSPS with at least two threads. The CDF (Figure 6) and the raw results (Table 2) give the results for this initial experiment.

At first we were surprised by the fact that P-MCOMSPS needs twice as many threads to match the performance of GIMSATUL for less than 8 threads. Due to time constraints, we could not run all the configurations on the SAT Competition 2020 too. But partial runs show that the results are very similar for 2, 4, and 8 threads (i.e., the performance of P-MCOMSPS with n threads is similar to the performance of GIMSATUL with $n/2$ threads). This shows that our results do not seem to be biased to the 2021 benchmarks (a valid threat to validity).

²Experimental data available at <https://cca.informatik.uni-freiburg.de/pos22gimsatul>.

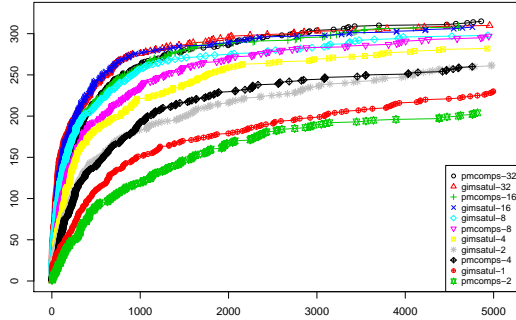

Figure 2: Cumulative distribution function (CDF) of the wall-clock solving time of both GIMSATUL and P-MCOMSPS for various considered number of threads.

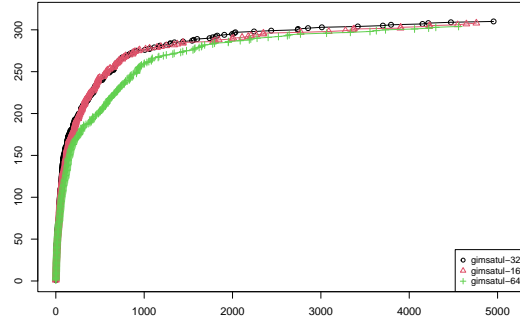

Figure 3: CDF with more threads than cores

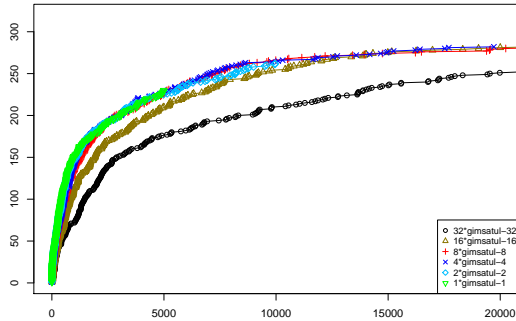

Figure 4: Scalability GIMSATUL

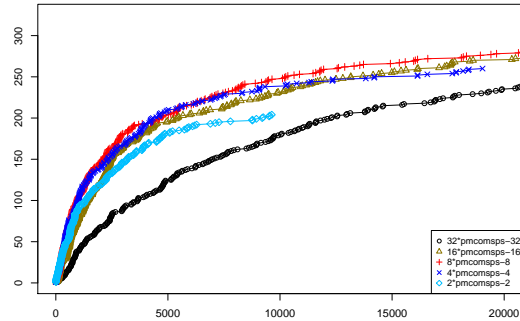

Figure 5: Scalability P-MCOMSPS

The plot also shows that GIMSATUL is in general faster than P-MCOMSPS, particularly with respect to the PAR-2 score, even though both solve a similar number of benchmarks.

We have also experimented with higher number of threads than our machines support (Figure 3). The performance gap when using all 32 virtual threads on the 16 “real” cores does not yield a performance decrease. However, when using 64 threads, performance decreases. This indicates that GIMSATUL does not spend all its time waiting for the other threads.

Scalability. While we only considered wall-clock-time performance above it is also interesting to investigate how effectively compute resources are used. This kind of question can arise in a cloud context where customers pay only for what is used and do not want to provision redundant compute resources (cores) unless solving latency is reduced effectively. We try to answer this question by plotting CDFs where (wall-clock) time is replaced by “time * number of cores”. This is equivalent to run our multi-threaded version on a single core.

For GIMSATUL (Figure 4), we see once saturation is reached (i.e., after 32 threads on our 16 “real” core nodes), performance decreases. The 16-thread version has a disadvantage at the beginning, but catches up. One reason might be that our portfolio has only 12 different policies, and the 4 other rings run the same first four policies again. Even though the behavior is not deterministic, more diversification is probably better. It is significant to see that the other curves are basically identical. This shows that our solver scales with the number of cores.

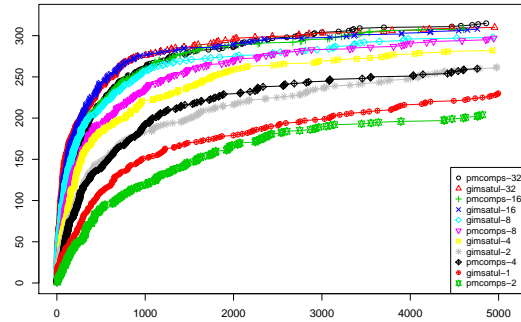

Figure 6: Cumulative distribution function (CDF) of wall-clock solving time of GIMSATUL and P-MCOMSPS for various number of threads.

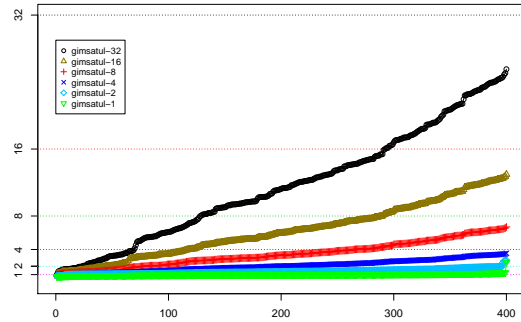

Figure 7: Initial relative memory increase of GIMSATUL w.r.t. resident size before and after cloning, i.e., after preprocessing but before solving.

For P-MCOMSPS (Figure 5), the picture is different. Remark that the 2-thread version stops at 11 000 s, i.e., exactly the timeout of 5 500 s when you have 2 threads. First the performance loss for 32 threads is already much more pronounced. So virtual threading seems to be very harmful. Second, we can see that performance for 2 threads is worse than for the other configuration. We attribute this to a lack of optimization and diversification for this case. Third, peak performance seems to be reached already for 8 threads, but the performance decrease compared to 16 threads is limited: it is more important to go from 4 to 8 threads, than to go from 8 to 16.

Memory Usage. In order to compare memory usage we have prepared two different plots. The first (Figure 8) shows peak memory usage (maximum resident-set-size) during the run. We can clearly see that GIMSATUL uses much less memory than P-MCOMSPS. For 32 threads GIMSATUL only needs in one case for 32 threads slightly more than 80 GB and otherwise stays below 64 GB, which is half the memory available on our cluster nodes. On the other hand, also for 32 threads, P-MCOMSPS hits the memory limit of 128 GB once.

In order to check how sharing works, we also checked the amount of memory used after the first preprocessing round but before cloning and any learning is done (Figure 7). This value is interesting because it shows an (optimistic) view on the cost of duplicating the watch lists and all other data-structures of the solver. With only binary clauses, the overhead would be very low. Without any binary clause all watch lists are duplicated, even though the actual clause data - the literals in clauses - are shared. Here we show how much more memory is used once GIMSATUL has initialized all the different rings. We can see that the increase is on average much lower than the number of solver instances, i.e., the number of threads.

6 Generating DRAT Proofs

The DRAT proof format was selected to be easy to implement for single threaded SAT solvers: It is sufficient to dump the derived clauses in order and to stop when the empty clause is derived. For parallel SAT solvers, it is tempting to produce one proof file per solver instance, but this does not work when the different instances exchange clauses. Instead we focus on a variant that produces a *single* proof file. This approach is not a new approach, but we did not find a description of it in related work.

One trivial solution is that every derived clause is written to the proof file in the order it is created and additionally added again (with multi-set semantics) when the clause is imported by

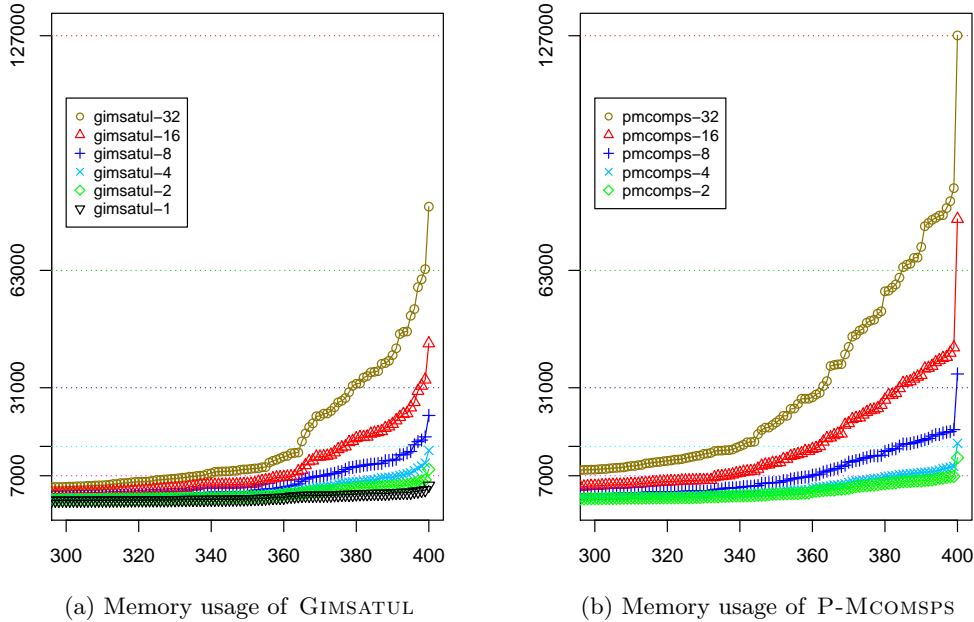

Figure 8: Memory usage in MB of both solvers on problems of the SAT Competition 2021

another solver thread. This makes sure that the individual solver instances can delete individual clauses as they like and log these deletion steps independently of each other in the proof file.

With this trivial “copying” solution clauses are repeated as many times as they are copied, increasing the size of the proof file almost linearly with respect to the number of threads (core solver instances). We propose instead in this work to *share* those clauses in the proof instead of duplicating them, which in turn requires to share them among the solver threads too. Unfortunately, this requires some substantial changes to the data-structures for watched literals, as described in the next section, and is one of the main reasons we started GIMSATUL from scratch instead of incorporating similar ideas into our sequential state-of-the-art solver KISSAT.

Generating proofs is very easy in GIMSATUL: Every large (non-binary) clause has an atomically incremented and decremented reference counter for the number of occurrences in different solver threads (rings), occurrences in clause pools and during simplification phases in the simplifier. When creating (allocating) the clause, it is *added* to the proof. Sharing a clause consists of passing a pointer and incrementing (atomically) the reference count. Dereferencing a clause (for instance during clause-database reduction) decrements the reference count and when the reference counter reaches zero the clause is deallocated and at the same time marked as *deleted* in the proof trace. In the meantime the clause is considered alive. As binary clauses are virtual and only occur in the watch lists, they are handled as in other solvers with virtual binary clauses as long as proof tracing is concerned.

All solver threads share the same proof trace file and writing to that file is synchronized implicitly using the standard locking mechanism of file I/O in `libc`. In particular, the library makes sure that calls to `fwrite` are executed atomically. To avoid additional locking, we first asynchronously collect complete proof lines in thread local buffers before calling `fwrite` and then rely on its implicit locking mechanism.

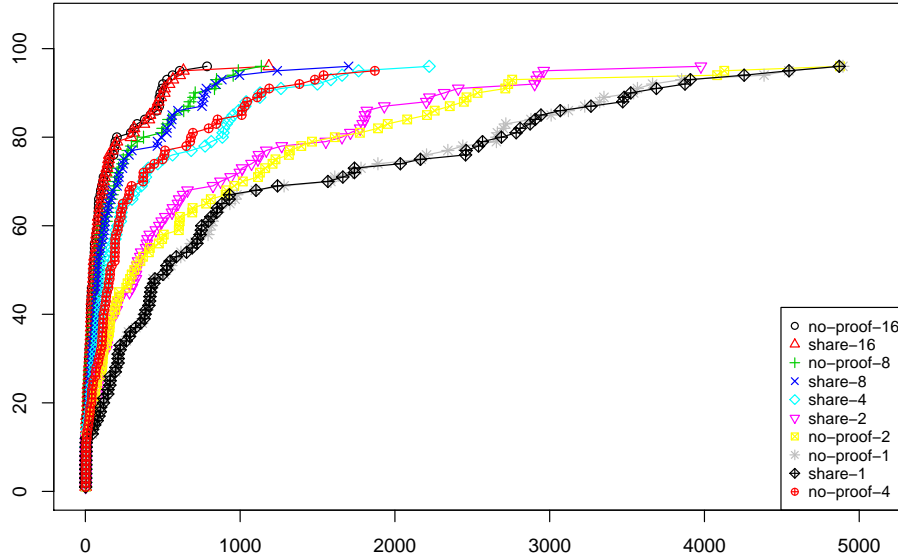

Figure 9: Cumulative distribution function (CDF) of the wall-clock solving time of GIMSATUL with and without proof generation for the discussed variant with sequential inprocessing disabled

7 Experiments on Proofs

We want to evaluate the advantage of not copying the clauses in the proofs. But instead of implementing a variant that really copies clauses, we *fake copying*: the clauses are *only* duplicated in the proof, but not in the solver. We argue that this approach gives similar performance as really copying clauses, as it would be necessary in other multi-threaded solvers which copy clauses, both in terms of proof size and checking time.

However, adapting inprocessing was a challenge, as our current version of for instance bounded variable elimination during inprocessing requires that all irredundant clauses are deduplicated. Instead we *deactivated* any form of sequential inprocessing completely which requires deduplication. Thus, in the following experiments we only report on a variant of GIMSATUL with initial preprocessing enabled, but only thread-local inprocessing enabled (vivification and failed literal probing).

We consider the 96 unsatisfiable problems that are solved by GIMSATUL without inprocessing by all 1, 2, 4, 8, and 16-thread configurations (due to non-determinism, rerunning benchmarks could lead to a different set of solved problems though). We use unsatisfiable problems in order to be able to do backwards checking instead of forward checking as is required if the problem is satisfiable or no contradiction is derived. Due to the time required to check proofs (≥ 10 h), we were not able to run the benchmarks for 32 threads before the submission deadline either.

Does Proof Generation Cause a Slowdown? Generating proofs is much more costly in a context of parallel SAT solving because proof logging is inherently single-threaded. However, according to our experiments in Figure 9, the cost of proof generation is negligible.

Do Proofs become Longer or Shorter? The answer to this question amounts to answering: is the work done by other rings useful or are the lines never used and could be removed. If the proofs are longer, then the work was useless. If the proof have similar length, then the rings just do work that has to be done too.

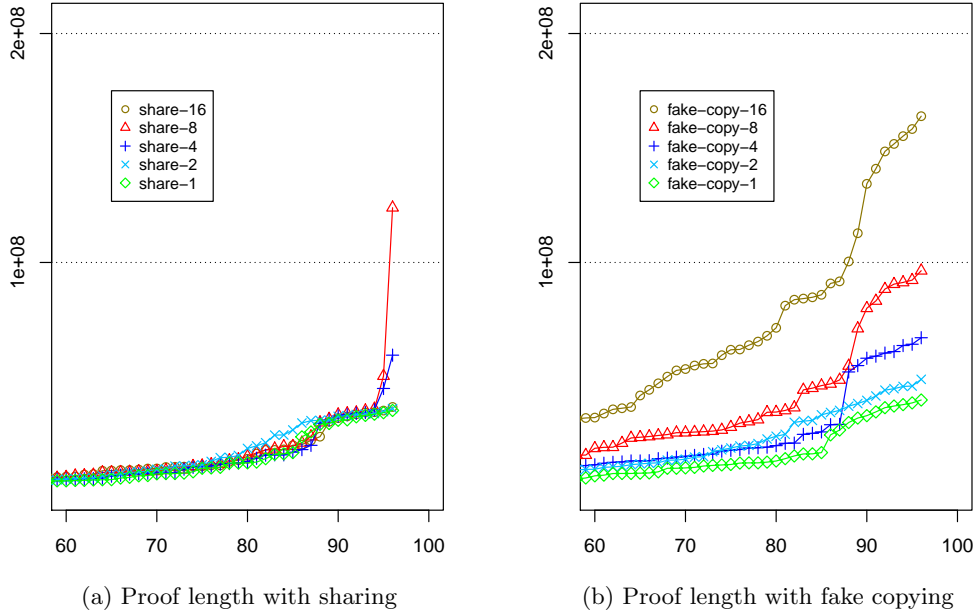

Figure 10: Proof length

In Figure 10a we show the proof size for runs using different number of threads. The plots are not completely conclusive. The 2-thread configuration produces larger proofs than the 1-thread and 4-thread versions. We realized after looking at the results of the experiments that our portfolio strategy might not be the best possible one and explain the bad behavior of 2 and 16 threads compared to 4 or 1. For 2 threads, instead of using one thread that focuses on SAT (stable mode) and one that focuses on UNSAT (focused mode) following the idea of Chanseok Oh [12], one threads runs in focused mode and one in alternating mode. For 16 threads, we have 8 threads that are running the same strategy. Testing both assumptions is future work.

Is Sharing Clauses Useful? In Figure 10b, we show the length of the proofs without sharing the proofs. It is clear that the proofs are longer or even much longer. Interestingly, for most problems, the size does not change much between the 4-thread and the 2-thread version. This indicates that the number of exchanged clauses is either limited or that the shared clauses are useful to reduce the search space limiting the overhead: If every clause was shared and entirely useless, the proofs would be n times as large for n threads.

Is Proof Checking Easier? In Figure 11, we have plotted the amount of time DRAT-TRIM needed to check the proofs. It is important to notice that DRAT-TRIM does not seem to detect duplicates³ and hence must reprove the lemma each time and every copy must be propagated when either of them is propagating.

With sharing, checking scales better, but is still much slower than in the single-threaded case. This can be explained by the fact that DRAT-TRIM does not know the context of learned clauses, i.e., which solver thread produced which clauses.

Should Proof Checking be added to the SAT Competition? This is the most controversial question without clear answer: even without physical clause sharing, DRAT-TRIM is able to

³Our understanding of the source code of DRAT-TRIM is that it uses a hash table only to count the number of clauses for deletions, but not to avoid relearning clauses.

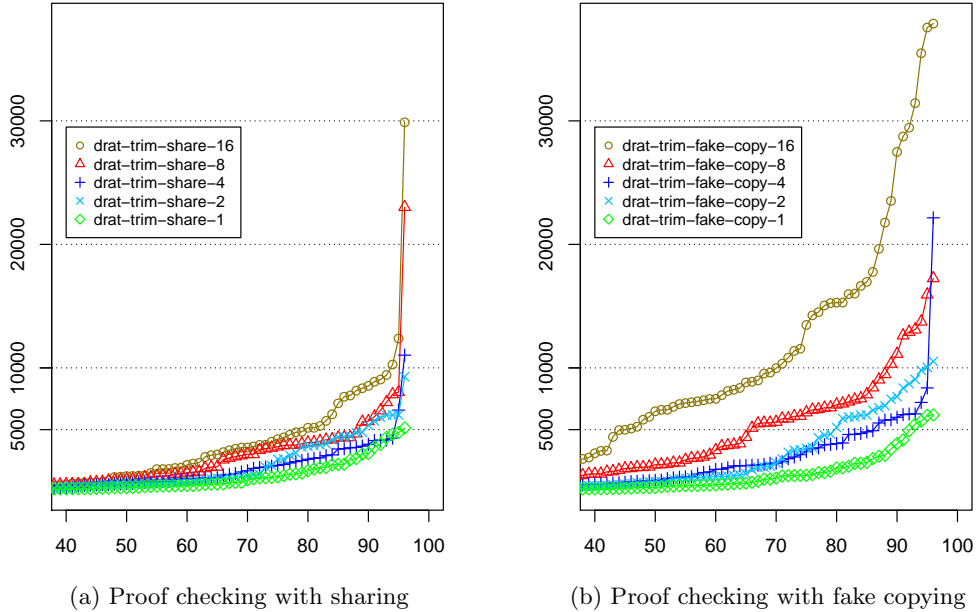

Figure 11: Amount of time required to check the proofs produced by GIMSATUL

check clauses. However, even though checking 32-thread certificates is less than 32-times slower, it most likely is too slow to be run in practice. Thus we consider parallelizing DRAT checkers as an important future work to solve this problem.

8 Conclusion

We presented the architecture of our newest solver GIMSATUL which shares clauses physically without copying. Even though it only features a simple form of diversification it scales linearly with the number of threads in our experiments. We also study the number of proof steps in this setting and observed that physical sharing yields smaller proofs. Nearly all proofs generated by runs with multiple solving threads have similar size as those produced by a single thread.

We want to further explore alternative clause exchange and search diversification strategies. We might also look into parallelizing variable elimination, subsumption and equivalent literal substitution, which are currently run by a single thread, even though this part does not seem to be a bottle-neck for large time-outs as used in the SAT competition. Making the solver deterministic like ManyGlucose would make the SAT solver easier to debug, and the biggest requirement, the time measurement by memory accesss, is already present in the code.

Acknowledgment. This work is supported by the Austrian Science Fund (FWF), NFN S11408-N23 (RiSE), and the LIT AI Lab funded by the State of Upper Austria. Some of the design choices for the clause sharing architecture of GIMSATUL are inspired by discussions with Christoph Kirsch and his former students Martin Aigner and Andreas Haas and other colleagues in RiSE [8]. The idea of using separate distributed pools inspired by k -stacks, in order to avoid a global lock-less queue and at the same time reduce false sharing was first proposed to us by Andreas in 2012 during our joint project. We also thank Sonja Gurtner for many timely textual improvements.

References

- [1] Balyo, T., Sinz, C.: Parallel satisfiability. In: Hamadi, Y., Sais, L. (eds.) *Handbook of Parallel Constraint Reasoning*, pp. 3–29. Springer (2018). doi:[10.1007/978-3-319-63516-3_1](https://doi.org/10.1007/978-3-319-63516-3_1)
- [2] Biere, A., Fleury, M.: Chasing target phases. In: *Workshop on the Pragmatics of SAT 2020* (2020), <http://fmv.jku.at/papers/BiereFleury-POS20.pdf>
- [3] Biere, A., Fleury, M., Heisinger, M.: CADICAL, KISSAT, PARACOOBA entering the SAT Competition 2021. In: Balyo, T., Froleyks, N., Heule, M., Iser, M., Jarvisalo, M., Suda, M. (eds.) *SAT Competition 2021* (2021), submitted
- [4] Biere, A., Jarvisalo, M., Kiesl, B.: Preprocessing in SAT solving. In: Biere, A., Heule, M., van Maaren, H., Walsh, T. (eds.) *Handbook of Satisfiability, Frontiers in Artificial Intelligence and Applications*, vol. 336, pp. 391 – 435. IOS Press, 2nd edition edn. (2021)
- [5] Eén, N., Biere, A.: Effective preprocessing in SAT through variable and clause elimination. In: Bacchus, F., Walsh, T. (eds.) *Theory and Applications of Satisfiability Testing, 8th International Conference, SAT 2005*, St. Andrews, UK, June 19-23, 2005, Proceedings. *Lecture Notes in Computer Science*, vol. 3569, pp. 61–75. Springer (2005)
- [6] Frioux, L.L., Baarir, S., Sopena, J., Kordon, F.: Modular and efficient divide-and-conquer SAT solver on top of the Painless framework. In: Vojnar, T., Zhang, L. (eds.) *Tools and Algorithms for the Construction and Analysis of Systems - 25th International Conference, TACAS 2019, Held as Part of the European Joint Conferences on Theory and Practice of Software, ETAPS 2019, Prague, Czech Republic, April 6-11, 2019, Proceedings, Part I. Lecture Notes in Computer Science*, vol. 11427, pp. 135–151. Springer (2019). doi:[10.1007/978-3-030-17462-0_8](https://doi.org/10.1007/978-3-030-17462-0_8)
- [7] Hamadi, Y., Jabbour, S., Sais, L.: ManySat: solver description. Tech. Rep. MSR-TR-2008-83 (May 2008), <https://www.microsoft.com/en-us/research/publication/manysat-solver-description/>
- [8] Henzinger, T.A., Kirsch, C.M., Payer, H., Sezgin, A., Sokolova, A.: Quantitative relaxation of concurrent data structures. In: Giacobazzi, R., Cousot, R. (eds.) *The 40th Annual ACM SIGPLAN-SIGACT Symposium on Principles of Programming Languages, POPL '13, Rome, Italy - January 23 - 25, 2013*. pp. 317–328. ACM (2013). doi:[10.1145/2429069.2429109](https://doi.org/10.1145/2429069.2429109), <https://doi.org/10.1145/2429069.2429109>
- [9] Heule, M.J.: Marijn J.H. Heule, associate professor at carnegie mellon university (mar 2022), <https://www.cs.cmu.edu/~mheule/>, accessed on 31. May 2021.
- [10] Jarvisalo, M., Biere, A.: Reconstructing solutions after blocked clause elimination. In: Strichman, O., Szeider, S. (eds.) *Theory and Applications of Satisfiability Testing - SAT 2010, 13th International Conference, SAT 2010, Edinburgh, UK, July 11-14, 2010. Proceedings. Lecture Notes in Computer Science*, vol. 6175, pp. 340–345. Springer (2010). doi:[10.1007/978-3-642-14186-7_30](https://doi.org/10.1007/978-3-642-14186-7_30), https://doi.org/10.1007/978-3-642-14186-7_30
- [11] Mahajan, Y.S., Fu, Z., Malik, S.: zChaff 2004: An efficient SAT solver. In: Hoos, H.H., Mitchell, D.G. (eds.) *Theory and Applications of Satisfiability Testing, 7th International Conference, SAT 2004, Vancouver, BC, Canada, May 10-13, 2004, Revised Selected Papers. Lecture Notes in Computer Science*, vol. 3542, pp. 360–375. Springer (2004). doi:[10.1007/11527695_27](https://doi.org/10.1007/11527695_27)
- [12] Oh, C.: Between SAT and UNSAT: the fundamental difference in CDCL SAT. In: *Theory and Applications of Satisfiability Testing–SAT 2015–18th International Conference, Austin, TX, USA, September 24-27, 2015, Proceedings*. pp. 307–323 (2015). doi:[10.1007/978-3-319-24318-4_23](https://doi.org/10.1007/978-3-319-24318-4_23)
- [13] Prevot, N., Soos, M., Meel, K.S.: Leveraging GPUs for effective clause sharing in parallel SAT solving. In: Li, C., Manyà, F. (eds.) *Theory and Applications of Satisfiability Testing - SAT 2021 - 24th International Conference, Barcelona, Spain, July 5-9, 2021, Proceedings. Lecture Notes in Computer Science*, vol. 12831, pp. 471–487. Springer (2021). doi:[10.1007/978-3-030-80223-3_32](https://doi.org/10.1007/978-3-030-80223-3_32)
- [14] Rebola-Pardo, A., Biere, A.: Two flavors of DRAT. In: Berre, D.L., Jarvisalo, M. (eds.) *Proceedings of Pragmatics of SAT 2015, Austin, Texas, USA, September 23, 2015 / Pragmatics of*

- SAT 2018, Oxford, UK, July 7, 2018. EPIc Series in Computing, vol. 59, pp. 94–110. EasyChair (2018). doi:[10.29007/lt8r](https://doi.org/10.29007/lt8r)
- [15] Schreiber, D., Sanders, P.: Scalable SAT solving in the cloud. In: International Conference on Theory and Applications of Satisfiability Testing. pp. 518–534. Springer (2021). doi:[10.1007/978-3-030-80223-3_35](https://doi.org/10.1007/978-3-030-80223-3_35)
- [16] Soos, M.: Memory layout of clauses in minisat (mar 2016), <https://www.msos.org/2016/03/memory-layout-of-clauses-in-minisat/>, accessed on 31. May 2021
- [17] Tan, Y.K., Heule, M.J.H., Myreen, M.O.: cake_lpr: Verified propagation redundancy checking in CakeML. In: Groote, J.F., Larsen, K.G. (eds.) Tools and Algorithms for the Construction and Analysis of Systems - 27th International Conference, TACAS 2021, Held as Part of the European Joint Conferences on Theory and Practice of Software, ETAPS 2021, Luxembourg City, Luxembourg, March 27 - April 1, 2021, Proceedings, Part II. Lecture Notes in Computer Science, vol. 12652, pp. 223–241. Springer (2021). doi:[10.1007/978-3-030-72013-1_12](https://doi.org/10.1007/978-3-030-72013-1_12)
- [18] Vallade, V., Le Frioux, L., Oanea, R., Baarir, S., Sopena, J., Kordon, F., Nejati, S., Ganesh, V.: New concurrent and distributed painless solvers: P-MCOMSPS, P-MCOMSPS-COM, P-MCOMSPS-MPI, and P-MCOMSPS-COM-MPI. In: Balyo, T., Froleyks, N., Heule, M., Iser, M., Jarvisalo, M., Suda, M. (eds.) SAT Competition 2021 (2021), submitted
- [19] Wetzler, N., Heule, M., Jr., W.A.H.: DRAT-trim: Efficient checking and trimming using expressive clausal proofs. In: Sinz, C., Egly, U. (eds.) Theory and Applications of Satisfiability Testing - SAT 2014 - 17th International Conference, Held as Part of the Vienna Summer of Logic, VSL 2014, Vienna, Austria, July 14-17, 2014. Proceedings. Lecture Notes in Computer Science, vol. 8561, pp. 422–429. Springer (2014). doi:[10.1007/978-3-319-09284-3_31](https://doi.org/10.1007/978-3-319-09284-3_31)