

Highlights

BDPC: Controlling Application Delay in 6TiSCH networks for the Industrial Internet of Things

Lucas Aimaretto, Diego Dujovne

- Scheduling Function to address resource allocation considering the delay to root node and the consumed time budget by data packets. This allows for the network to cope with the application's *deadline* requirements.
- The resource allocation is addressed on the opposite direction of data traffic flow.

BDPC: Controlling Application Delay in 6TiSCH networks for the Industrial Internet of Things

Lucas Aimaretto^a, Diego Dujovne^b

^a*Facultad de Ciencias Exactas, Físicas y Naturales, Universidad Nacional de Córdoba, Córdoba, Argentina*

^b*Escuela de Informática y Telecomunicaciones, Universidad Diego Portales, Santiago, Chile*

Abstract

One of the essential requirements of the Industrial Internet of Things (IIoT), is to have an extremely high packet delivery rate, generally over 99.9%. However, packets which arrive after a predefined deadline shall be considered lost too. Industrial applications require a predictable delay. To solve this problem, we propose a new mechanism, called BDPC (Bounded Delay Packet Control). BDPC combines the knowledge of a node's delay to its root with the time budget of a data packet traversing the IoT network, to allocate cells in 6TiSCH slotFrames in order to fulfill the application's maximum delay requirements in a controlled manner: the application packets must arrive before the deadline, but not faster. This is achieved by allocating cells from a parent node to a child node, thereby adapting the cell capacity and attaining the bounded delay goal, by the analysis of the new variable *latePaqs*. In other words, the resource allocation is a function of *latePaqs*. Moreover, the number of packets arriving after the predefined deadline can be controlled by two thresholds: `sfMax` and `sfMin`. Our results show that using BDPC, the number of packets arriving before the deadline can be improved more than 2.6 times compared to the case when using the default Minimal Scheduling Function from the standard. As a further advantage, BDPC involves minor modifications to the 6TiSCH protocol stack, which makes it compatible with current implementations.

Keywords: 6TiSCH, Bounded, Control, Delay, TSCH

1. Introduction

In the context of the the Industrial Internet of Things (IIoT), it is fundamental to guarantee an extremely high packet delivery rate [1], and to satisfy realtime performance, data packets must also arrive within a limited time frame. A packet which is delayed after the expected deadline is discarded by the application, and should be considered lost too. Currently, the standardized Architecture of Deterministic Networks [2] includes both minimum Packet Delivery Rate requirements and time-bounded data packet delivery, or *bounded latency*.

However, Deterministic Networks are generally defined for wired solutions, while wireless Industrial IoT has been following a parallel path. One of the most developed wireless Industrial IoT implementations is the Time Slotted Channel Hopping (TSCH) mode of the IEEE 802.15.4 standard, which defines how nodes reserve resources according to a channel-timeslot schedule matrix, called slotframe. The slotframe matrix determines a number of cells, where a pair of nodes over a communication link can exchange packets. The IPv6 over the TSCH mode of IEEE 802.15.4e (6TiSCH) stack establishes the mechanisms for resource allocation, leaving to the Scheduling Functions (SFs) the implementation of the algorithms that decide when and how to allocate resources [3].

Scheduling Functions are the core of the allocation intelligence in 6TiSCH-based IoT networks. SFs implement an algorithm to improve a specific network characteristic such as delay, power consumption, network lifetime and packet delivery rate. Among the wide range of proposed SFs, there is a subgroup where the aim is to reduce the end-to-end delay. However, to the best of our knowledge, there is no SF currently designed to maximize the Packet Delivery Rate within a certain application-defined deadline. As a consequence, we have compiled in the state of the art the most representative SFs which minimize packet delay, as the closest reference.

First, MSF [4] is the Minimal Scheduling Function, which is the full-featured standard SF used by default within the 6TiSCH stack. MSF recommends increasing the number of cells in the data plane to decrease latency, always at the cost of higher power consumption.

Second, the Low Latency Scheduling Function (LLSF) [5] is a SF designed to decrease end-to-end latency in 6TiSCH multi-hop networks, using a *daisy-chain* approach. The transmission sequence is defined by a succession of allocated timeSlots incrementally shifted in time for each node in the network.

Once a packet is received in a RX timeSlot, it is automatically transmitted to the next node in the following TX timeSlot. The results in [5] show that the end-to-end delay is 82.8% lower than using SF0 [6] for a 5-hop linear topology.

Third, the Low-latency Distributed Scheduling Function (LDSF) [7] algorithm is oriented to minimize the end-to-end delay while providing high reliability. LDSF is able to generate a schedule for a large number of transmissions, also managing the buffering delay when oversubscription cells are chained. In order to achieve this goal, LDSF divides a long slotframe into small blocks that repeat over time. Each node then selects the right block corresponding to its hop distance to the border router which minimizes delay.

The concepts of primary and ghost cells are also defined. The primary cells correspond to the earliest expected reception time of a data packet from the previous hop. To ensure network reliability, ghost cells correspond to the retransmission opportunity in the event that a receiver has not received the data packet during the primary cell. The ghost cells are allocated at the same timeSlot offset in subsequent subFrames.

By performing simulations, LDSF delivers a PDR_{e2e} above 98.5% with a network lifetime of 4 years, for a traffic flow of 1 packet every 30s. In this scenario, the end-to-end delay is 250ms.

Finally, the Recurrent Low-Latency Scheduling Function (ReSF) [8] is a SF that focuses on optimizing the delay of applications with periodic traffic.

This function uses a distributed method to allocate resources through 6P [9], focusing on building a resource reservation mechanism that minimizes recurring communication latencies, aimed towards IoT systems where devices perform periodic data transmission. ReSF assumes that the source node is aware of the traffic period pattern. With this information, ReSF is able to generate a recurring path, which consists of cells that are activated only when traffic is expected and deactivated otherwise. ReSF allows nodes to make reservations that are based on the ASN where it started generating data, the ASN where it stops generating data and the repetition period. This information is sent to the next hop until it reaches the destination, thus reserving resources for each node along the path.

By performing simulations, ReSF shows that the latency, for a network size of 25 elements and a traffic flow of 1 packet per minute, is close to 0.5 seconds with a PDR_{e2e} of 100%.

Although the former proposals show that delay can be reduced, they do not consider first, a maximum delay goal i.e. the application-level *deadline*;

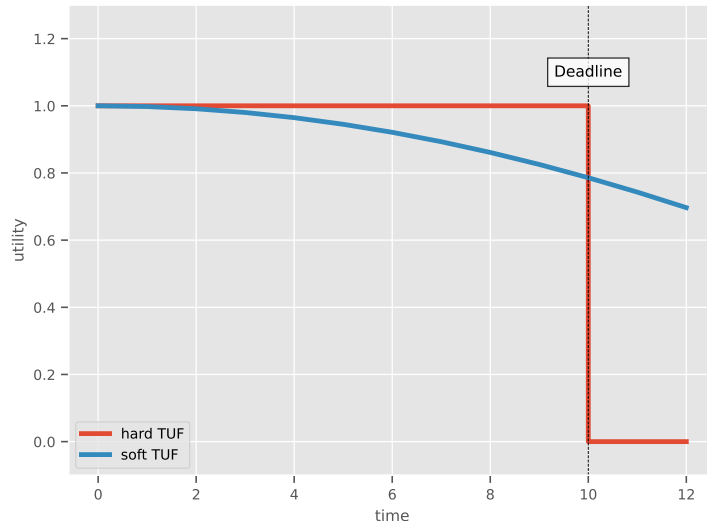

Figure 1: Hard and Soft Time Utility Functions. For the hard case, if the task is completed after the maximum deadline, the outcome is discarded.

this is expected in a deterministic environment, for example, if an application running on a 6TiSCH-based network requires that the packets must arrive to destination before a maximum *deadline*. Second, they do not consider the effect of jitter of the arriving packets, which increment packet loss for those arriving later than the *deadline*; and third, even though the former proposals provide a high PDR_{e2e} , they do not take into account the PDR_{e2e} for a specific application *deadline*, considering that late packets are lost packets [10].

The most important characteristic in time-related tasks, is the requirement of time expressed as a function of its maximum limit, called the *deadline*. There are two kinds of deadlines [11]: hard deadlines and soft deadlines. The hard deadline case establishes a conditioning over the maximum limit in which the task must be completed, while if the condition is a soft deadline, the task is less strict on the arrival time. The hard deadline case is mostly related to real time applications, such as industrial control systems. Thus, for the hard deadline case, if any task is completed after the maximum deadline, the outcome is discarded, even if the outcome is correct. Hard and soft Time Utility Functions (TUF) can be observed in Fig. 1.

Our proposal, BDPC (Bounded Delay Packet Control) deals with real-

time applications with hard timing requirements and solves this problem combining upstream and downstream information in order to allocate cells in the reverse direction, i.e. on the child node link, so as to provide enough resources to let the highest number of packets reach the destination before the expected deadline. This is a completely different approach from the former delay optimization proposals: the application packets must arrive before the deadline, but not necessarily faster. Further, BDPC is agnostic to traffic pattern, flow isolation or topology structure.

Our solution comprises the following contributions:

- BDPC is the first SF that combines the estimated delay to the root node (upstream information, $d2r$) with the packet time budget ($timeLeft$, downstream information) to allocate resources. Thus, the $latePaqs$ variable is the result of the combination of $d2r$ and $timeLeft$. Formally, $latePaqs = f(d2r, timeLeft)$.
- Unlike most SFs, which allocate data cells to the Next-Hop, BDPC assigns data cells to the previous node, or Pre-Hop, based on the analysis of the $latePaqs$ variable.
- BDPC enables the control over the percentage of packets allowed to arrive after the pre-established deadline at their destination, with only two parameters $sfMax$ and $sfMin$.

The rest of the paper is organized as follows: Section 2 presents the current mechanisms and provides motivation for this work; section 3 presents the BDPC algorithm and the full compatibility with current standards. In section 4, we present the results based on simulation work; and finally in section 5 we conclude our work.

2. Motivation

The resource scheduling algorithms for the Industrial Internet of Things must satisfy the requirements of each data flow, specially in control networks. SFs which reduce delay generally achieve this goal as a global process, where no packet delay information is taken into consideration to make a decision. We propose to use the packet time budget, plus the estimation of a node's delay to the root, to allow the SF allocate resources and adapt to the dynamic data flow requirements.

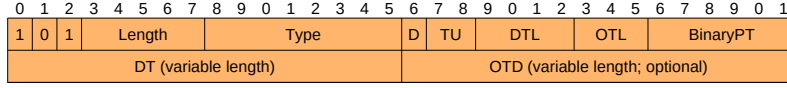

Figure 2: 6LoRHE - Routing Header with timing information

The Packet Delivery Deadline Time field in the Routing Header for IPv6 over Low-Power Wireless Personal Area Networks [12] is the current standard field where the deadline time for the application packets can be propagated from origin to destination. This header (Fig. 2) is inserted at the Network layer (as defined on the 6LoWPAN standard [13]) and includes, among other fields, the packet origin time and the maximum delivery time of the packet.

For example, for a 6TiSCH network with 10ms timeSlots, a source node has a number of enqueued data packets ready to be transmitted. The current Absolut Slot Number (ASN) is 54400, which represents the $originTime_{packet}$. The maximum application delay, $maxDelay$, is 1s. The $deadLine$ of the application, is calculated as follows:

$$\begin{aligned}
 deadLine &= originTime_{packet} + maxDelay/10ms \\
 deadLine &= 54400 + 100 \\
 deadLine &= 54500
 \end{aligned}$$

Consequently, the application data packet deadline to be included in the DT field is 54500 (Fig. 2), and the maximum supported delay is 100 timeSlots.

If an intermediate node receives a packet and analyzes the 6LoRHE header, that node can tell if the packet is still within the delivery $deadLine$, by calculating the $timeLeft$, which is the difference between the $deadLine$ carried by the packet, and the current time. To follow the former example, if the intermediate node receives the packet at ASN 54450:

$$\begin{aligned}
 timeLeft_{asn} &= deadLine_{packet} - currentTime_{asn} \\
 timeLeft_{asn} &= 54500 - 54450 \\
 timeLeft_{asn} &= 50 \\
 timeLeft_{seg} &= 0.5
 \end{aligned}$$

However, the delay information carried by the packet is not enough for the SF to decide a cell allocation. A negative *timeLeft* value means that the time budget has been consumed, and the packet could be discarded, while if the *timeLeft* is positive, the received packet still has 0.5s to reach its destination: it is unknown whether this positive *timeLeft* is enough to reach the root node.

Thus, if an intermediate node is aware of its own delay to the root node (equivalent to the application destination), as well as the state of the time budget of the data packet, the SF will be able to make a cell scheduling decision for the traversing packet flow.

3. Proposed Solution

3.1. Overview

BDPC is a system based on a simple and modular architecture contained within each of the network intermediate nodes (Fig. 3). It is designed to run as part of the 6TiSCH protocol stack and interacts with 6P and the TSCH MAC layer (Fig. 5). Algorithms 1 and 2 are complementary: they calculate *latePaqs* and decide packet allocation respectively. The DB_{data} and DB_{dio} databases store data packet statistics, and delay to root measurements carried by the DIO RPL [14] packet. The **sfMax** and **sfMin** thresholds are externally configurable parameters.

Algorithm 1 estimates the late packet rate, *latePaqs*. When an intermediate node's SF receives a data packet, it analyzes the 6LoRHE of the packet and verifies if the remaining time, *timeLeft*, is enough to reach the root node. The comparison is done against the delay of the intermediate node towards the root node, *d2r*. If the time is not enough, the *delayed* variable is increased; otherwise, *inTime* is increased. Finally, *latePaqs* is calculated and stored in a database. The late packet rate is fundamental to the operation of BDPC because it gives an intermediate node information about each child's current overtime packet arrival statistics.

Algorithm 2 uses *latePaqs*, and compares it against the **sfMax** and **sfMin** thresholds. Using 6P, it performs one of these possible options:

- add a **RX** cell towards the previous node;
- remove a **RX** cell towards the previous node.

$$\text{alg1}(\text{deadLine}, d2r) \xrightarrow{\text{store}} \text{latePaqs}$$

$$\text{alg2}(\text{latePaqs}, \text{sfMax}, \text{sfMin}) \xrightarrow{6P} (\text{addCell}/\text{delCell})$$

Algorithm 1 Estimation of *latePaqs*

```

timeLeft = deadLinepacket - currentTimeasn
d2r  $\xleftarrow{\text{get}}$  DBdio
inTime  $\xleftarrow{\text{get}}$  DBdata
delayed  $\xleftarrow{\text{get}}$  DBdata
if timeLeft >= 0 and timeLeft >= d2r then
    inTime = inTime + 1
else
    delayed = delayed + 1
end if
latePaqs = delayed / (delayed + inTime)
latePaqs  $\xrightarrow{\text{store}}$  DBdata
inTime  $\xrightarrow{\text{store}}$  DBdata
delayed  $\xrightarrow{\text{store}}$  DBdata

```

Algorithm 2 Cell assignment to the PreHop

```

latePaqs  $\xleftarrow{\text{get}}$  DBdata
if latePaqs >= sfMax then
    addCell(PreHop)
else if 0 <= latePaqs and latePaqs <= sfMin then
    delCell(PreHop)
end if

```

3.2. System Model

The single path end to end data delay, is the difference between the arrival time of a data packet at the root node, and the departure time from

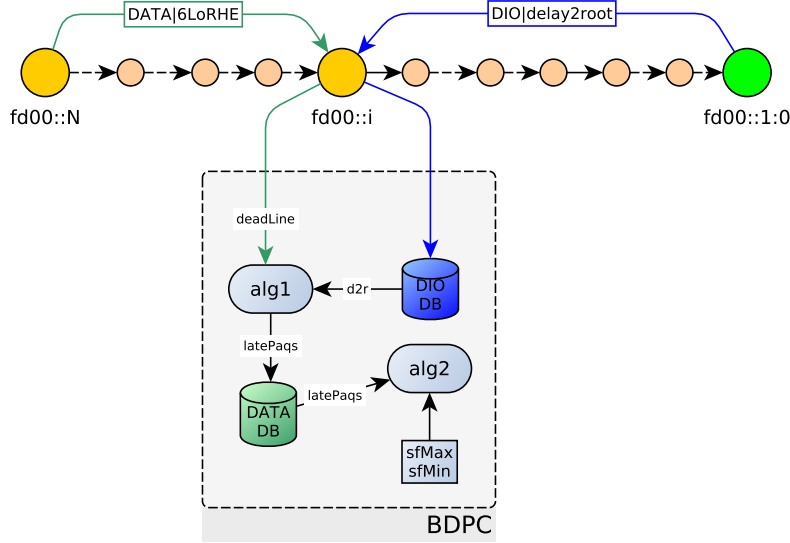

Figure 3: BDPC system at an intermediate node

an intermediate node: $d = t_{rx} - t_{tx}$. It can be shown by fitting [15] the results of Fig. 14, that the delay is beta distributed, i.e., $d \sim Beta(\alpha, \beta)$.

Furthermore, the end to end data delay can be modeled as:

$$d = \sum_i^{N-1} t_{q_i}$$

Where d is the end to end data delay, N is the amount of nodes forming a single path towards the root node and t_{q_i} is the queuing time, for each consecutive link i . The queuing time is the time a packet waits in the queue before being put into the next available cell in the schedule, towards the next hop.

In a 6TiSCH network, the TSCH slotFrame is composed of cells that can be of type **SHARED**, **TX**, **RX**, or a combination of those. According to [4], the delay can be reduced by adding cells into the schedule so data packets will have extra capacity for their journey. The idea of the paper is to modify the parameters α and β of $d \sim Beta(\alpha, \beta)$, using algorithm 1: the mean of the beta distribution, $\alpha/(\alpha + \beta)$, is equal to the variable *latePaqs*. Using algorithm 2 we can add **RX** cells from a parent node to a child node and as such, increment β (Fig. 5). Thus, the probability of the delay being lower

than or equal to its maximum deadline, maxDelay , is equal to $(1 - \text{sfMax})$. Formally:

$$P(d \leq \text{maxDelay}) = 1 - \text{sfMax} \quad (1)$$

Hence, $(1 - \text{sfMax})$ is the probability that packets traversing the network towards the root node, will make it in time. In other words, the PDR_{e2e} before the *deadline* is equal to $(1 - \text{sfMax})$.

3.3. Delay to the root node estimation

The DODAG Information Object (DIO) messages of the IPv6 Routing Protocol for Low-Power and Lossy Networks can be used to provide an intermediate node with a delay reference to the root, from the packet structure provided by the RPL standard [14].

In this proposal, a node generating DIO messages includes additional information to allow the child nodes become aware of the delay to the root. When a child node receives a DIO message with timing information from its parent node, it updates the delay to the root node value in the internal DB_{dio} database. Timing information in DIOs must only be considered by a node when coming from a parent.

The DIO messages traverse the network using the Minimal-Cell [4] specification. Consequently, the intermediate nodes will not observe any changes in the delay to the root over time (Fig. 9). However, this phenomena does not constitute a problem from a global performance point of view, since only the result of the combination of the system parameters mentioned earlier is what triggers the cell allocation in the data plane to the previous node.

3.4. Cell assignment to the PreHop

The usual allocation type implies the assignment of a TX cell from a child to its parent. BDPC initiates a RX cell request to each child, where the child is identified by the source MAC address of the sent frames. This means that each parent can seamlessly manage cell allocation among children independently. In other words, BDPC is agnostic to topology structure.

Fig. 6 shows the allocation procedure to the PreHop along the network. The transmitted IP packet includes a field inside 6LoRHE (Fig. 2) with the *deadline* value required by the application. The packet departs from the leaf node towards the root node. On each intermediate node, algorithms 1 and 2

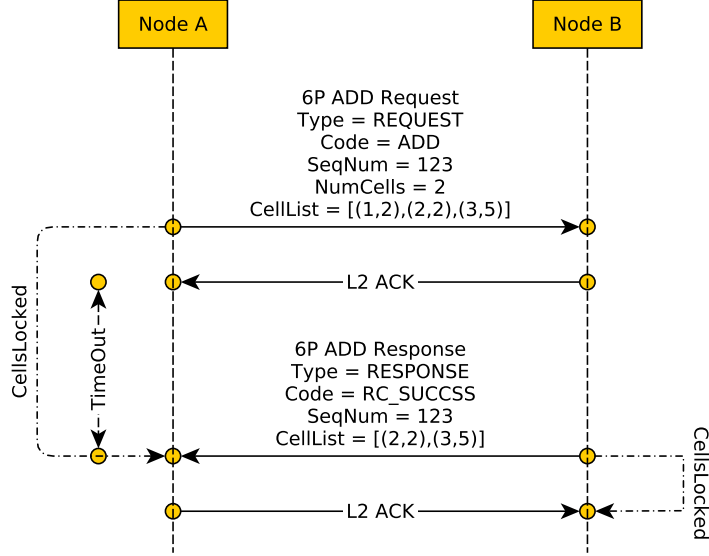

Figure 4: 6P two-way handshake for cell assignment.

will process the deadline as one of the inputs. Depending on the outcomes of the algorithms 1 and 2, a RX type cell can be added or removed in the PreHop direction (i.e. the previous hop). We must emphasize that the addition of a RX type cell to the PreHop automatically instructs the local TSCH layer of the PreHop to install a TX type cell towards the next-hop (in the direction of the root node).

The assignment process uses the 6P [9] protocol, which is the same mechanism that MSF is already using when adding or removing cells towards the next-hop. Both MSF and BDPC use the same two-way 6P standard handshake for the assignment. Every time a node needs to assign cells, it triggers a 6P request to its neighbor (if MSF, the next-hop; if BDPC, the pre-hop) to perform such an assignment. The client will offer a list of possible cells, out of which the server will decide and confirm back. Fig. 4 shows the 6P two-way hand shake for cell-assignment between nodes.

The cell allocation from the parent to the child node (Pre-Hop), managed by algorithm 2 interacts seamlessly with the allocation mechanism of cells to the preferred parent (Next-Hop) as defined on MSF [4]. This means that, if required, the number of added cells by BDPC in the reverse direction can be removed by MSF in the child-parent direction of the same link.

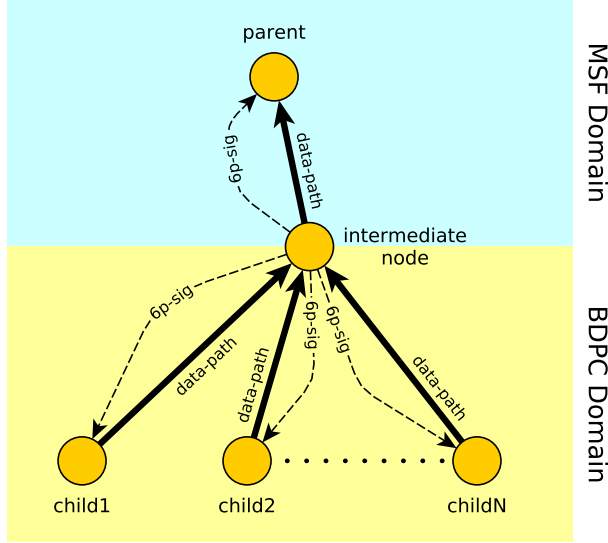

Figure 5: Cell allocation on the parent-child direction (Pre-Hop) controlled by algorithm 2 of BDPC. MSF still controls cell assignment to the Next-Hop.

Thus, the solution integrates two complimentary behaviors: (i) the one defined by the standard, MSF, towards the preferred parent and (ii) the one performed by BDPC, towards the previous node. This is shown in Fig. 5.

3.5. *latePaqs*

In a 6TiSCH network, the path to the root node is handled by the RPL protocol [14]. RPL uses the well-known Rank value. The Rank value represents an abstract distance to the root of the DODAG tree. The Rank value is exchanged between the nodes using DIO messages, and allows other RPL nodes to avoid loops and to build the routing topology of the network that will enable data packets to arrive at the root node [16]. As such, the Rank value is an always increasing strictly positive number that gives the node an approximation of its topological situation within the network.

Unlike the Rank value, *latePaqs* is not exchanged between nodes, but inferred by each intermediate node by using algorithm 1. Inside the DB_{data} database, each intermediate node stores a version of *latePaqs* for each of their children. Each child is identified by the source MAC address of the receiving data frames in their path to the root node and each version of *latePaqs*

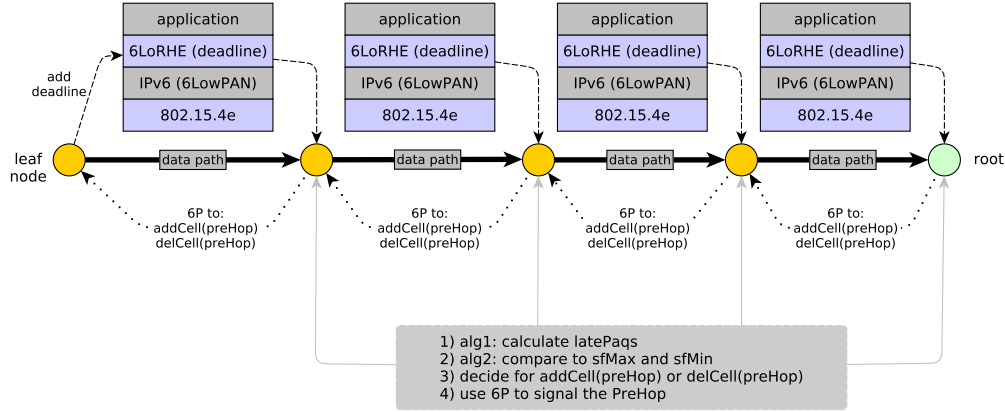

Figure 6: Cell allocation procedure on the parent-child direction (Pre-Hop) controlled by algorithms 1 and 2. The IP packet that leaves the leaf node, traverses the whole network to the root node. Along its path, the intermediate nodes analyze the *deadline* carried by the 6LoRHE and decide if a cell will be allocated for each case. Fig. 3 shows in detail the processes and entities within an intermediate node.

gets updated whenever the intermediate node receives a data frame from its children.

In the same way that the Rank provides a node information about its topological situation, *latePaqs* provides an intermediate node the instantaneous number of packets that will not arrive before the deadline at the root node. A packet is considered a late packet when the estimated time lapse to arrive at the root node from an intermediate node, is larger than the packet's own remaining time. *latePaqs* accumulates all the packets arriving fulfilling the former condition from each of its children. In other words, *latePaqs* informs an intermediate node the rate of packets that are already late at that precise node and moment.

Consequently, *latePaqs* becomes the fundamental element of BDPC: It is calculated by algorithm 1 and it is used as an input to the Scheduling Function to define if RX cells must be added or removed to the appropriate child (Fig. 5).

Fig. 7 shows an example of the different *latePaqs* measurements that each intermediate node obtains from its children. When MSF is used, *latePaqs* is hardly reduced and hence an important number of data packets arrive late at the root node. On the other hand, when BDPC is used, the *latePaqs* starts to decrease more aggressively because of the added cells in the parent-child

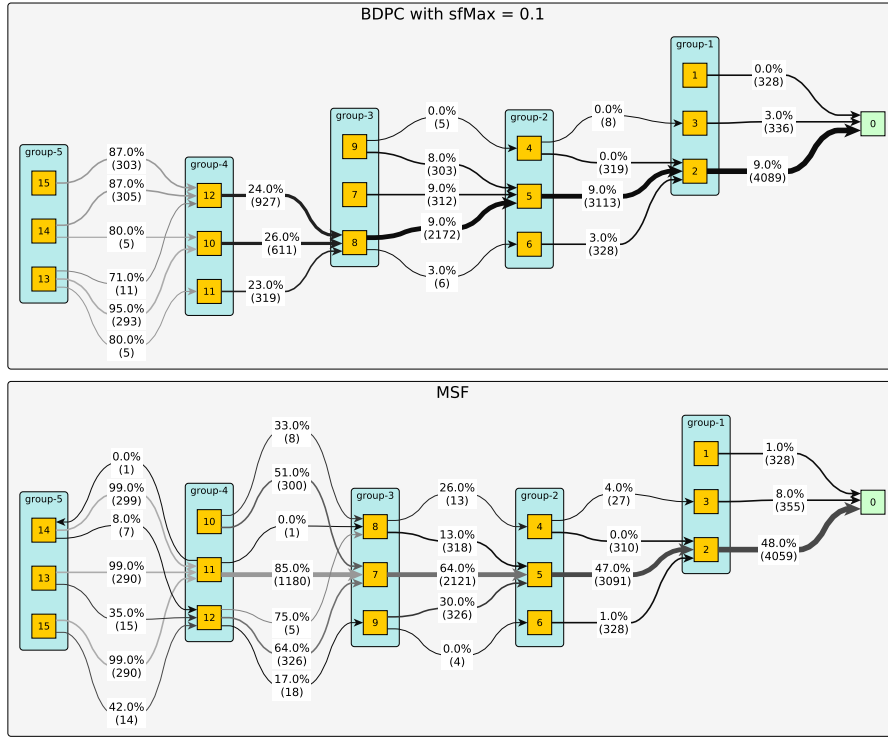

Figure 7: Example of the evolution of *latePags* along the network. When MSF is used, *latePags* is hardly reduced. On the other hand, when BDPC is used, the *latePags* starts to decrease more aggressively because of the added cells in the parent-child direction. The width of the links represent the traffic load, showing the path from leaf nodes to the root node. The number between parenthesis shows the number of packets being received by a node. The darker the links, the better *latePags* measurement.

direction, which is coherent with Fig. 11. For example, in Fig. 7, when using MSF, 48% of the packets received by the root node from node 2, were late packets. Conversely, when using BDPC, only 9% of the packets that the root node received from node 2, were late packets (which is coherent with the value of $\text{sfMax}=10\%$). It is important to note that the outgoing arrows mean aggregated traffic: the packets delivered by node 2 to the root node is a compound of its own packets plus the packets received from its child nodes. The results shown in Fig. 7 correspond only to the outcome from seed 4 from the simulations.

4. Simulation

4.1. Setup

The 6TiSCH simulator [17] includes the standard protocol implementations for MSF, 6P, and RPL in the 6TiSCH network stack. The RPL DIO message was modified to add the delay to root information.

We performed three experiments with 30 different seeds each. The first two experiments evaluate the performance of BDPC for different values of `sfMax` and `sfMin`, while the remaining experiment is used as a reference, running the original MSF implementation.

The length of each simulation run is 10000 `slotFrames` (approximately 2.8 hours in simulation time) in order to allow the system stabilize after the initial network convergence stage.

The network is a hierarchy of groups of nodes (Fig. 8), each group containing three nodes. In the first group, each node has a link towards the root node, which is shown in green. In the rest of the groups, each node has links towards every node in the group above, and also towards every node in the group below: nodes in even groups cannot be seen among them. This topology allows for a dynamic parent change situation along the simulation run. Also this setup of links gives the topology a certain depth that will allow to visualize the effect of delay on the data packets traversing the network. The values of $PDR = 100\%$ and $RSSI = -10dB$ for each of the links, correspond to the default values provided by the simulator.

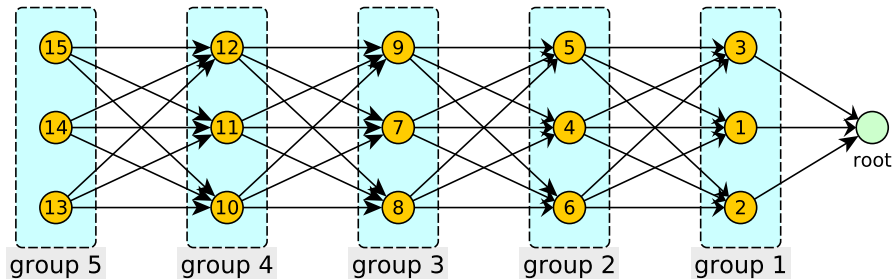

Figure 8: Simulation topology

All the nodes (except for the root) generate data traffic where the destination is the root node. This means that there are multiple flows of data

packets traversing the network in parallel, going from the child nodes towards the root node. Each node generates 90-Byte¹ data packets that are transmitted every 30s, with 0.05 variance². The application maximum delay threshold (`maxDelay`) is configured to 1.5s³. The `timeSlot` duration is 10ms and the `slotFrame` is composed of 101 `timeSlots`, both default values from the standard. Table 1 summarizes the simulation parameters.

4.2. Results

Fig. 9 shows the average delay observed by a node within its group, with respect to the root node, based on the information provided by the DIO messages. The horizontal dotted line shows the maximum delay supported by the application (`maxDelay`). The delay to the root, $d2r$, remains constant across the experiments because the DIO messages use the Minimal-Cell, which belongs to the control plane, while BDPC manages the Data plane delay.

The application packets delay measured at the root node is shown in Fig. 10. Using MSF, the average delay exceeds the maximum application allowed delay when the nodes reside on group-2 and backwards; however, when BDPC is enabled, the average delay stays below the maximum delay until the packets arrive at the root node: the packets transmitted by a node within group-5, show an average delay measured at the root of 1.03s and 0.48s for `sfMax` values of 0.1 and 0.0001, respectively.

Fig. 11 shows the evolution of the variable *latePaqs* along the network topology. It can be observed that *latePaqs* in groups away from the root is substantially higher compared to groups closer to the root node; this means that BDPC, reacting to *latePaqs*, adds `RX` cells to the pre-hop recursively creating a chain that will reduce *latePaqs* in nodes closer to the root node. A smaller *latePaqs* means less packets arrive late at that intermediate node.

Fig. 12 describes the number of late packets arriving to the root from each source group. As such, 44% of the packets which were generated from group

¹The IEEE 802.15.4 header is 23 bytes long. This leaves room for a 104 bytes payload. A 90 bytes payload is a big enough application packet to avoid fragmentation.

²The default period for packets in the simulator, is 60s. We've cut it in half, to double the throughput.

³In control networks, the dead time is the delay a signal takes from a controller output until it is measured and hence there is a response. The effect of dead time in a process needs to be cancelled because time delay makes the designed controller unstable [18]. In [19], the delay ranges between 30s and 45s.

General Parameters	
Seeds	30 per experiment
Nodes	15 + root
Topology	Multi-hop with parent change possibility
Link PDR	100.00%
Link RSSI	-10dB
Simulation time	10000 slotFrames (2.8hs)
slotFrame	101 timeSlots
timeSlot	10ms
Channels	16
Packet Generation	30s
Packet Variance	0.05
Packet Size	90 Bytes
TSCH TX Queue Size	10 packets
TSCH Max Retries	5
Application <code>maxDelay</code>	1.5s
MSF	
Original Implementation	
BDPC	
BDPC#1	<code>sfMax = 0.1</code> <code>sfMin = 0.05</code>
BDPC#2	<code>sfMax = 0.0001</code> <code>sfMin = 1e-05</code>
PreHop <code>addCell</code>	1

Table 1: Simulation Setup

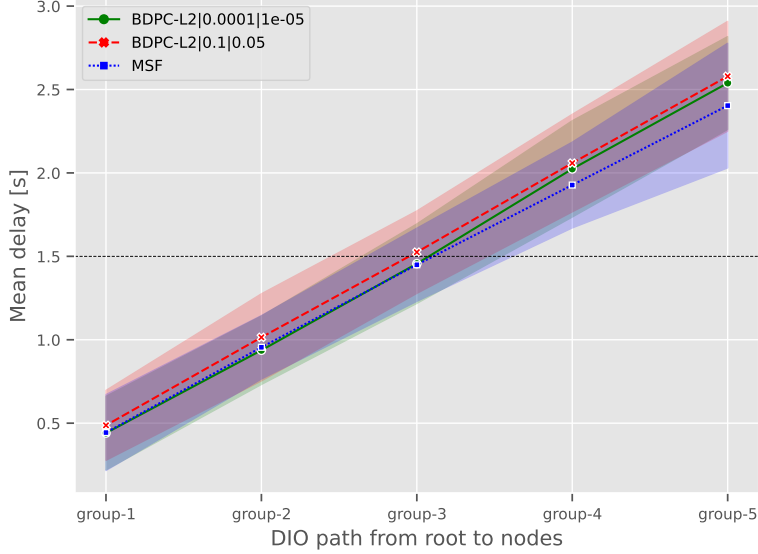

Figure 9: DIO Delay to root measured at each node. The horizontal black-dashed line represents the maximum application delay, maxDelay . The shaded area around the average delay to root, is the standard deviation for the series.

2 arrived after the deadline when using MSF as the Scheduling Function. On the other hand, when using BDPC, this rate drops down to less than 6% for packets generated at the same group. Thus, when BDPC is used, the smaller sfMax is, the lower the percentage of packets arriving late at the destination. For example, for data packets leaving a node within group-5, the average rate of packets arriving late at root is 97.34% when using MSF; when using BDPC this rate drops to 14.06% and 0.29% for sfMax values of 0.1 and 0.0001, respectively.

By comparing the results of Fig. 11 and Fig. 12, i.e., latePaqs versus the actual rate of packets arriving late at the root node, it can be observed that even though latePaqs is high in groups away from the root, the number of packets originated in such groups (i.e., group-5) that actually arrive late when using BDPC, is less than 20% while for the case of MSF is close to 100% of late packets. Since latePaqs measures the rate of packets arriving late at an intermediate node, the lower latePaqs becomes means lesser late packets arriving late at their destination. As a consequence, BDPC has the objective of reducing latePaqs by using algorithm 2 and thus adding RX

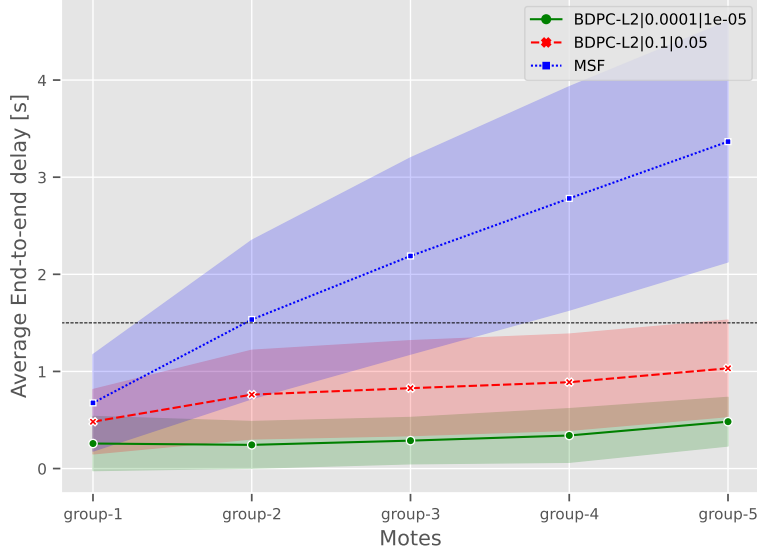

Figure 10: End-to-End Data packet delay measured at the root node. The horizontal black-dashed line represents the maximum application delay, \maxDelay . The shaded area around the average delay, is the standard deviation for the series.

cells to the pre-hop. This results in a *latePaqs* decrease in nodes closer to the root node and, as a consequence, a decrease in the actual rate of packets arriving late at their destination. Table 2, shows in detail the mean percentage of packets arriving late versus its corresponding value of *latePaqs* for data packets originated in groups for different number of hops from the root node.

Fig. 13 shows a different analysis from a combination of what can be observed on Fig. 11 and Fig. 12. Fig. 13 is a scatter plot that depicts the distribution of the percentage of late packets at the root node for the full range of values of *latePaqs* along the different groups of the topology. It can be observed that *latePaqs* has a different distribution for each group: the measurements of *latePaqs* are concentrated to the right for groups away from the root node (i.e., group-5). However, an increase of *latePaqs* rate using BDPC does not follow an increase of the number of data packets arriving late at the root node. This is not the case for MSF, where an increment of *latePaqs* results in an increment of the rate of late packets at the root node. The average packet delivery rate values for the three configurations can be

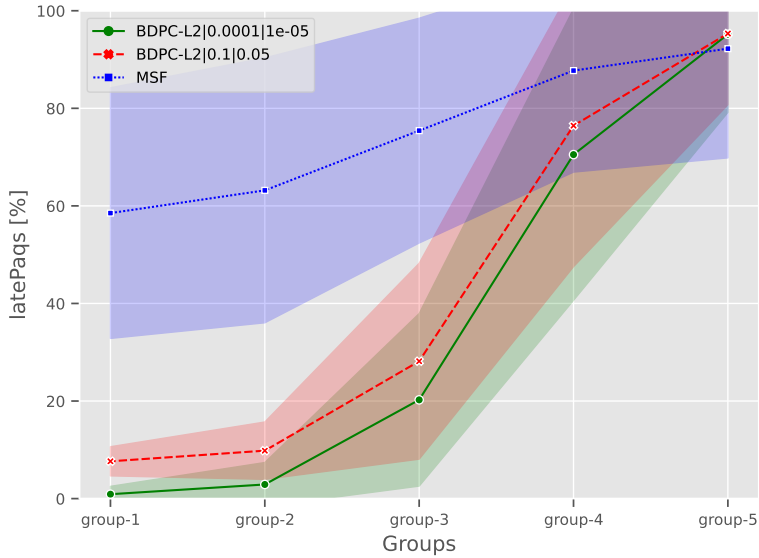

Figure 11: Evolution of *latePaqs* along the network. The shaded area around the average *latePaqs*, is the standard deviation for the series. An example over the network topology can be seen in Fig. 7.

run	group	<i>latePaqs</i> %	late at root %
MSF	group-1	58.52262	6.33998
MSF	group-5	92.22803	97.34692
BDPC-L2—sfMax=0.0001	group-1	0.89990	0.12184
BDPC-L2—sfMax=0.0001	group-5	95.17487	0.29296
BDPC-L2—sfMax=0.1	group-1	7.64576	0.71938
BDPC-L2—sfMax=0.1	group-5	95.33046	14.06473

Table 2: Packets arriving late at the root node versus *latePaqs* at nodes in groups 1 and 5. When using BDPC, an increment of *latePaqs* does not provoke an increment on the rate of late packets at the root node.

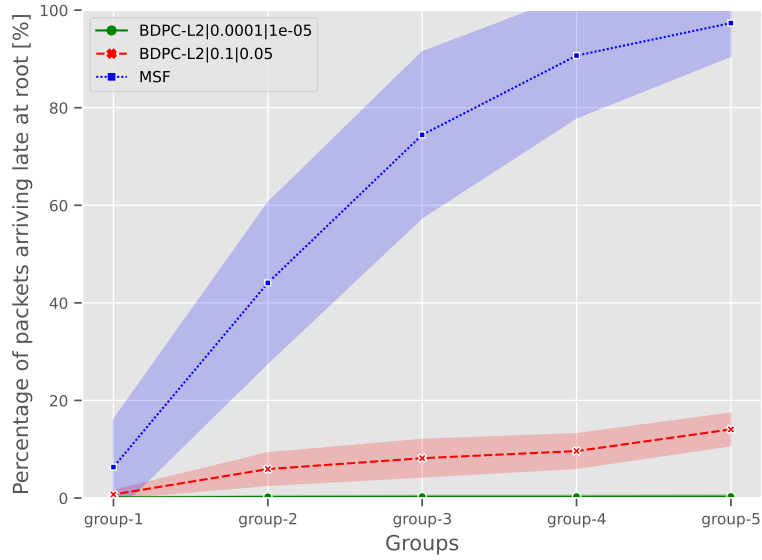

Figure 12: Data packets arriving late at the root node. Packets are originated from the nodes for each group on the network. The shaded area around the average late packets arrival rate is the standard deviation for the series.

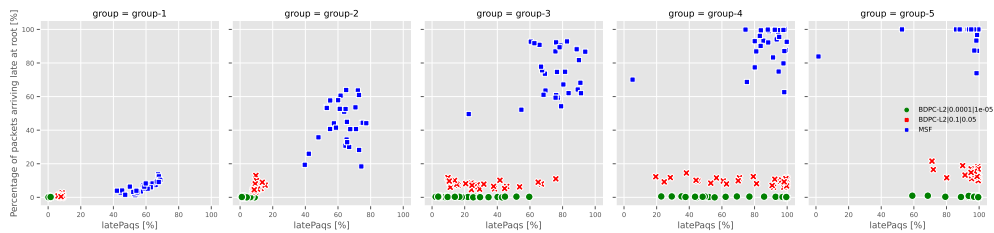

Figure 13: Evolution of *latePaqs* along the network. The y-axis represents the overall late packets arriving at the root node from each group in the network. Table 2 summarizes the graphics' average values for groups 1 and 5

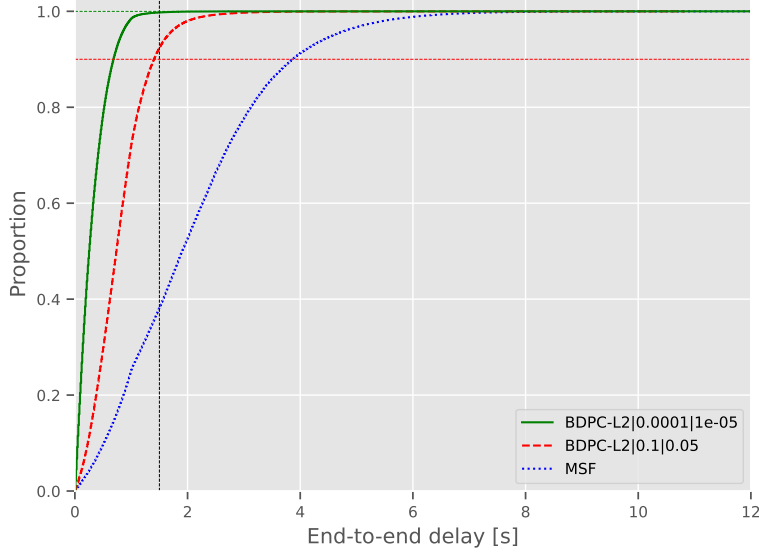

Figure 14: End-to-End data packets delay. The vertical black-dashed line represents the maximum delay tolerated by the application, maxDelay . The horizontal red and green dashed lines, represent the values of $(1 - \text{sfMax})$, for sfMax values of 0.1 and 0.0001. MSF performance shows that only 38.5% of the data packets will arrive within the deadline, while BDPC guarantees that the packets arriving in term will be 92.5% and 99.8% for sfMax values of 0.1 and 0.0001, respectively

observed in Table 2.

The overall E2E delay performance of the network can be observed in Fig. 14. The vertical dotted line shows the maximum delay defined by the application, while the horizontal dotted lines represent the value of $(1 - \text{sfMax})$. According to Eq. (1), this value represents the overall rate of packets that will arrive at the destination within the deadline.

Moreover, MSF performance shows that only 38.5% of the data packets will arrive within the deadline, while BDPC guarantees that the packets arriving in term will be 92.5% and 99.8% for sfMax values of 0.1 and 0.0001, respectively. If MSF is expected to achieve a packet delivery (before deadline) rate of 90%, the maximum delay tolerated by the application must be 4s or longer. Consequently, not only BDPC enables a better deadline compliance, but also the sfMax parameter can finely control the overall rate of packets that will arrive within the deadline.

Fig. 15a and Fig. 15b show the packet delivery rate (PDR) at the

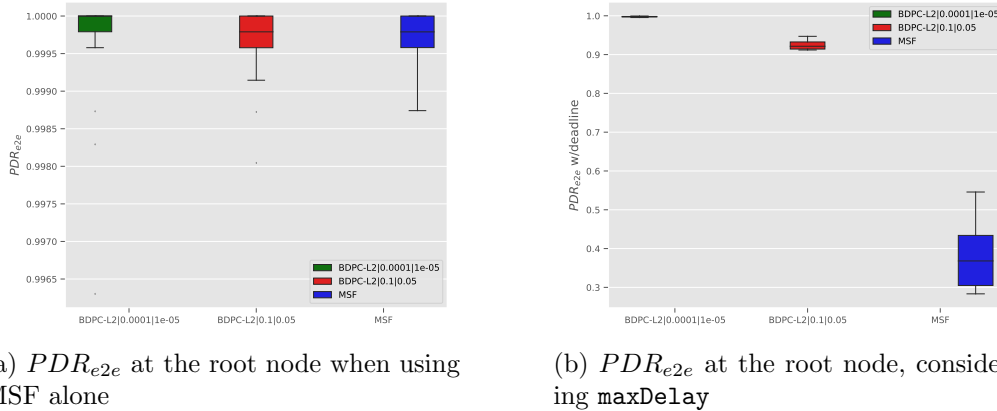

Figure 15: Comparing of PDR_{e2e} when using MSF versus when using BDPC and considering a maxDelay

application level. The first figure shows the rate of packets that successfully arrived at the root node, for each of the series. Since the PDR at the link level is configured to 100%, the PDR at the application level is close to 99.975%. However, when the packet deadline is used as a criteria to discard packets, Fig. 15b shows that BDPC guarantees the arrival of more than 90% of the packets, compared to MSF which guarantees less than 40% of the packets arriving on time. Table 3 summarizes the graphics' values as a reference.

Fig. 16 correlates the results of Fig. 15a and 15b. The horizontal red and green dashed lines, represent the values of $(1 - \text{sfMax})$, for sfMax values of 0.1 and 0.0001 respectively. In this figure it can be observed that even though all the alternatives deliver a PDR_{e2e} above 99.8%, only when using BDPC the packets arrive before the deadline. Furthermore, the smaller sfMax is, the lesser jitter can be obtained for the packets arriving before the deadline.

run	PDR_{e2e} w/deadline	PDR_{e2e}
BDPC-L2— $\text{sfMax}=0.0001$	0.99766	0.99972
BDPC-L2— $\text{sfMax}=0.1$	0.92459	0.99968
MSF	0.38329	0.99971

Table 3: Average packet delivery rate when the maxDelay limit is enabled

But yet, why does it work? The previous shown results have presented the performance in terms of PDR_{e2e} vs PDR_{e2e} before maxDelay (Fig. 16),

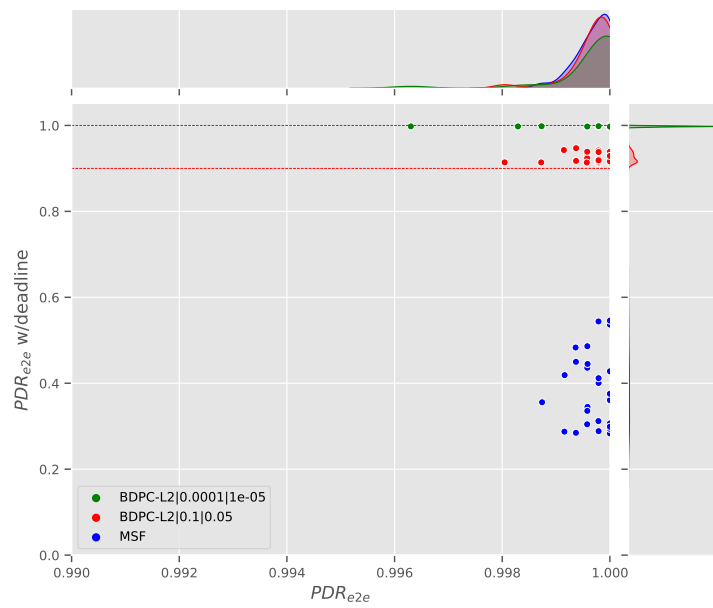

Figure 16: Joint Plot of PDR_{e2e} vs PDR_{e2e} with deadline. The horizontal red and green dashed lines, represent the values of $(1 - \text{sfMax})$, for sfMax values of 0.1 and 0.0001 respectively. Both MSF and BDPC guarantee a high PDR_{e2e} , but only when BDPC is used, packets arrive before the maximum deadline. Table 3 summarizes the graphics' average PDR_{e2e} values as a reference

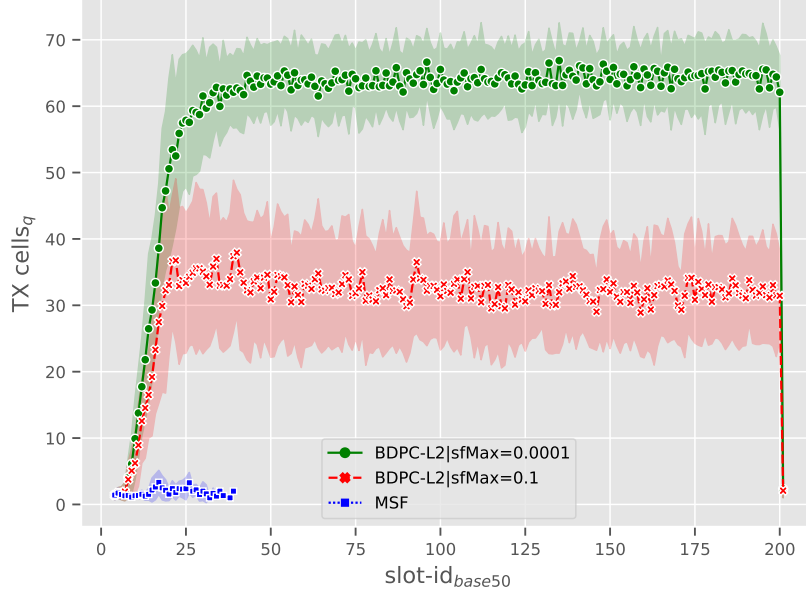

Figure 17: Reserved dedicated TX cells along the simulation run. The cells are shown over the span of 50 slotFrames for the sake of clarity (hence $50 \times 200 = 10000$ slotFrames, which is the duration of the simulation run). The shaded area is the standard deviation of the series. After slotFrame 2000, MSF stops allocating resources, because traffic load is already stable. However, BDPC keeps on sensing the data traffic value every time a packet traverses a node and adjusts cell capacity to cope with the application requirements.

end-to-end delay distribution (Fig. 14) and the distribution of the *latePags* variable (Fig. 7 and 13). Fig. 17 shows the dedicated reserved TX cells along the simulation run. For the case of MSF, after 2000th slotFrame, the scheduling function has already clustered all the necessary cells for the current traffic load. On the other hand, BDPC senses the traffic value every time a packet traverses a node, and precisely adjusts the required cells to agree to the application deadline requirements (Fig. 6). Once the traffic has converged, BDPC only triggers little modifications to the schedule, by means of algorithm 2. In general BDPC with $\text{sfMax}=0.1$ requires less TX cells to cope with the application requirements, while BDPC with $\text{sfMax}=0.0001$ requires the double of capacity, on average, for the same purpose.

Finally, Fig. 18 shows the expected lifetime for each group in the net-

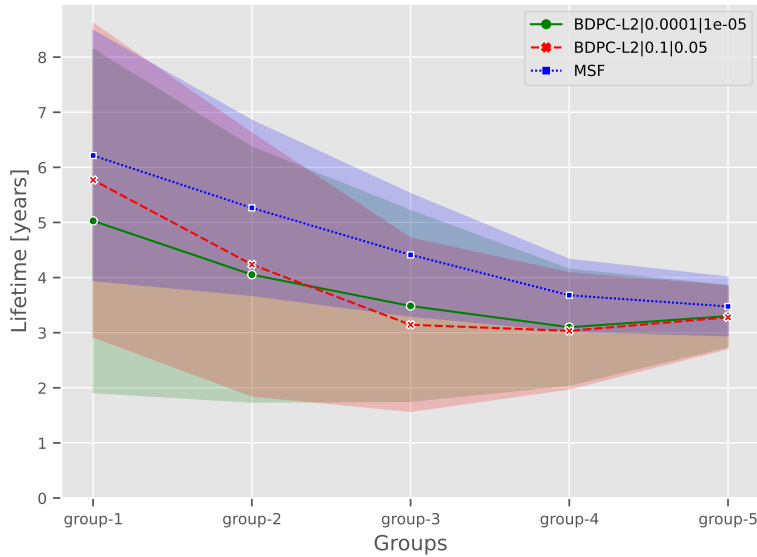

Figure 18: Node lifetime. The lifetime of the network is defined by the period until at least one of the nodes in the network depletes its energy storage and stops responding.

work, for each of the experiments⁴. The life of the network is defined by the longest time all nodes are still alive, which corresponds to the node with the shortest lifetime. From this point of view, all experiments behave similarly⁵. Consequently, the average lifetime of the network using BDPC is 3.06 and 3.11 years, for the experiments with `sfMax` values of 0.1 and 0.0001, respectively while the network would run 3.48 years, with MSF, a lifetime increase of only 4.4 months. By sacrificing 11.8% of the network lifetime when using MSF, 99.8% of the packets could reach their destination within the deadline.

⁴To calculate the node lifetime, the charge of a 2821.5mAh AA battery is considered as a reference. The energy consumption is calculated by counting the number of TX/RX/ACK/Listen/Sleep radio operations performed by a node.

⁵Nodes closer to the root with a lower power consumption than nodes located farther away is counter-intuitive; this is a result of the network cell allocation process using management frames. Nodes closer to the root need less packet management exchanges given that the traffic is already clustered, while power consumption at the extremes requires more negotiation instances.

5. Conclusion

This paper proposes a new approach to achieve realtime capabilities in wireless IIoT. In the industrial context, two critical factors define performance: an extremely low packet loss rate and deadline compliance at application data packets. Packets arriving late are discarded at the application layer: guaranteeing the delivery of data packets within a maximum and predictable deadline is of utmost importance. In other words, it is not only important to guarantee an extremely high PDR_{e2e} , it is also important to guarantee an extremely high PDR_{e2e} within the application deadline.

We solve this problem with BDPC (Bounded Delay Packet Control). BDPC is a mechanism that combines the knowledge of the maximum delay tolerated by the application with the observed delay towards the root node to allocate network resources. Additionally, we create the variable *latePaqs*. *latePaqs* informs the intermediate node about the rate of late packets traversing it. We also define two thresholds called **sfMax** and **sfMin** to establish the number of packets allowed to arrive later than the deadline, and finally, we establish a new allocation request in the inverse, parent-child direction (PreHop). On top of that, BDPC is agnostic to traffic pattern, flow isolation or topology structure.

BDPC shows a substantial improvement over the standard behavior of MSF, where the network delivers 99.8% of the packets within the deadline, for a value of **sfMax** = 0.0001, compared to MSF, which guarantees on-time delivery of only 38.5% of the packets, for the same network and application with only a network lifetime decrease of 11.8% (equivalent to 4.4 months).

Finally, this proposal has the potential to be implemented in the current standard, given that the solution only involves minor modifications to the 6TiSCH protocol stack.

Acknowledgment

The authors would like to thank the CYTED AgIoT Project (520rt0011), CORFO CoTH2O “Consortio de Gestión de Recursos Hídricos para la Macrozona Centro-Sur”, Proyecto Asociativo UDP “Plataformas Digitales como modelo organizacional” and 19STIC-09 “WirelessWine” STIC-AmSud, for their support during the development of this research work.

References

- [1] D. Dujovne, T. Watteyne, X. Vilajosana, P. Thubert, 6tisch: deterministic ip-enabled industrial internet (of things), *IEEE Communications Magazine* 52 (12) (2014) 36–41.
- [2] N. Finn, P. Thubert, B. Varga, J. Farkas, Deterministic Networking Architecture, RFC 8655 (Oct. 2019). doi:10.17487/RFC8655.
URL <https://rfc-editor.org/rfc/rfc8655.txt>
- [3] X. Vilajosana, K. Pister, T. Watteyne, Minimal IPv6 over the TSCH Mode of IEEE 802.15.4e (6TiSCH) Configuration, RFC 8180 (May 2017). doi:10.17487/RFC8180.
URL <https://rfc-editor.org/rfc/rfc8180.txt>
- [4] T. Chang, M. Vučinić, X. Vilajosana, S. Duquenooy, D. R. Dujovne, 6TiSCH Minimal Scheduling Function (MSF), RFC 9033 (May 2021). doi:10.17487/RFC9033.
URL <https://rfc-editor.org/rfc/rfc9033.txt>
- [5] T. Chang, T. Watteyne, Q. Wang, X. Vilajosana, Llsf: Low latency scheduling function for 6TiSCH networks, in: 2016 International Conference on Distributed Computing in Sensor Systems (DCOSS), IEEE, 2016, pp. 93–95.
- [6] D. R. Dujovne, L. A. Grieco, M. R. Palattella, N. Accettura, 6TiSCH 6top Scheduling Function Zero (SF0), Internet-Draft draft-ietf-6tisch-6top-sf0-05, Internet Engineering Task Force, work in Progress (Jul. 2017).
URL <https://datatracker.ietf.org/doc/html/draft-ietf-6tisch-6top-sf0-05>
- [7] V. Kotsiou, G. Z. Papadopoulos, P. Chatzimisios, F. Theoleyre, LDSF: Low-latency distributed scheduling function for industrial internet of things, *IEEE internet of things journal* (2020).
- [8] G. Daneels, B. Spinnewyn, S. Latré, J. Famaey, Resf: Recurrent low-latency scheduling in IEEE 802.15.4e TSCH networks, *Ad Hoc Networks* 69 (2018) 100–114.

- [9] Q. Wang, X. Vilajosana, T. Watteyne, 6TiSCH Operation Sublayer (6top) Protocol (6P), RFC 8480 (Nov. 2018). doi:10.17487/RFC8480. URL <https://www.rfc-editor.org/info/rfc8480>
- [10] P. Thubert, G. Z. Papadopoulos, Reliable and Available Wireless Architecture, work in Progress (Mar. 2022). URL <https://datatracker.ietf.org/doc/html/draft-ietf-raw-architecture-04>
- [11] S. Ryu, B. Ryu, H. Seo, M. Shin, Urgency and efficiency based packet scheduling algorithm for ofdma wireless system, in: IEEE International Conference on Communications, 2005. ICC 2005. 2005, Vol. 4, IEEE, 2005, pp. 2779–2785.
- [12] L. Thomas, S. Anamalamudi, S. Anand, M. Hegde, C. E. Perkins, Packet Delivery Deadline Time in the Routing Header for IPv6 over Low-Power Wireless Personal Area Networks (6LoWPANs), RFC 9034 (Jun. 2021). doi:10.17487/RFC9034. URL <https://rfc-editor.org/rfc/rfc9034.txt>
- [13] P. Thubert, R. Cragie, Ipv6 over low-power wireless personal area network (6lowpan) paging dispatch, IETF, RFC 8025 (2016).
- [14] R. Alexander, A. Brandt, J. Vasseur, J. Hui, K. Pister, P. Thubert, P. Levis, R. Struik, R. Kelsey, T. Winter, RPL: IPv6 Routing Protocol for Low-Power and Lossy Networks, RFC 6550 (Mar. 2012). doi:10.17487/RFC6550. URL <https://rfc-editor.org/rfc/rfc6550.txt>
- [15] E. Taskesen, distfit - Probability density fitting (1 2020). URL <https://erdogant.github.io/distfit>
- [16] P. Thubert, Objective Function Zero for the Routing Protocol for Low-Power and Lossy Networks (RPL), RFC 6552 (Mar. 2012). doi:10.17487/RFC6552. URL <https://www.rfc-editor.org/info/rfc6552>
- [17] E. Municio, G. Daneels, M. Vućinić, S. Latré, J. Famaey, Y. Tanaka, K. Brun, K. Muraoka, X. Vilajosana, T. Watteyne, Simulating 6tisch networks, Transactions on Emerging Telecommunications Technologies

30 (3) (2019) e3494. doi:10.1002/ett.3494.

URL <https://onlinelibrary.wiley.com/doi/abs/10.1002/ett.3494>

- [18] S. K. Sunori, P. K. Juneja, M. Chaturvedi, J. Mittal, Dead time compensation in sugar crystallization process, in: Proceeding of International Conference on Intelligent Communication, Control and Devices, Springer, 2017, pp. 375–381.
- [19] K. Lim, K. Ling, Generalized predictive control of a heat exchanger, IEEE Control Systems Magazine 9 (6) (1989) 9–12.