

---

# TNTORCH: TENSOR NETWORK LEARNING WITH PYTORCH

---

Mikhail Usvyatsov<sup>1\*</sup>, Rafael Ballester-Ripoll<sup>2\*</sup>, and Konrad Schindler<sup>1</sup>

<sup>1</sup>ETH Zurich, Switzerland, {mikhailu, schindler}@ethz.ch

<sup>2</sup>IE University, Madrid, Spain, rafael.ballester@ie.edu

\*Joint first authors

September 22, 2022

## ABSTRACT

We present `tntorch`, a tensor learning framework that supports multiple decompositions (including CANDECOMP/PARAFAC, Tucker, and Tensor Train) under a unified interface. With our library, the user can learn and handle low-rank tensors with automatic differentiation, seamless GPU support, and the convenience of PyTorch’s API. Besides decomposition algorithms, `tntorch` implements differentiable tensor algebra, rank truncation, cross-approximation, batch processing, comprehensive tensor arithmetics, and more.

**Keywords** tensor decompositions · pytorch · low-rank methods · multilinear algebra

## 1 Introduction

In many machine learning and data analysis tasks one is faced with multi-dimensional data arrays. Tensors are a powerful tool to represent and handle such data, but often constitute a bottleneck in terms of storage and computation. *Tensor decompositions* expand a tensor into a set of separable terms. If the tensor has low rank (i.e., there are much fewer degrees of freedom than tensor elements), then such a decomposition can dramatically reduce the representation size (Kolda and Bader, 2009; Cichocki et al., 2016; Khrukov et al., 2019).

Tensor decompositions play an increasingly important role in machine learning: they are used to factorize neural network weights (Novikov et al., 2015; Gusak et al., 2019; Wang et al., 2020; Idelbayev and Carreira-Perpiñán, 2020; Kossaifi et al., 2020), to accelerate learning and inference (Ma et al., 2019; Hrinchuk et al., 2019; Usvyatsov et al., 2021), to impose priors that improve accuracy (Kuznetsov et al., 2019; He et al., 2022) and robustness (Kolbeinsson et al., 2021), etc. For more applications of tensors in machine learning see (Panagakis et al., 2021). Importantly, the distinction between the different classical decomposition schemes has become blurred, as newer types of low-rank constraints and tensor indexing schemes have gained popularity (Novikov et al., 2015; Khrukov et al., 2019; Cichocki et al., 2016; Usvyatsov et al., 2021). There exist multiple frameworks (Novikov et al., 2020; Kossaifi et al., 2019) with emphasis on different aspects. We believe that more than ever, tensor software must be flexible regarding the underlying tensor formats, while exposing a natural and accessible interface to the user.

To this end, we introduce `tntorch` ([github.com/rballester/tntorch](https://github.com/rballester/tntorch)), an open-source Python package that abstracts the choice of format, while providing a wide range of tools for tensor learning, manipulation, and analysis. Compared to similar recent libraries T3F (Novikov et al., 2020), TensorLy (Kossaifi et al., 2019), TedNet (Pan et al., 2021), TensorD (Hao et al., 2018), TensorNetwork (Roberts et al., 2019), and `tt-pytorch` (Khrukov et al., 2019), `tntorch` emphasizes an easy-to-use, decomposition-independent interface inherited from PyTorch<sup>1</sup>. The package’s API is fully documented and features a score of tutorial Jupyter notebooks ([tntorch.readthedocs.io](https://tntorch.readthedocs.io)) across a variety of use cases. See Appendix A.2 for a point-by-point comparison with the aforementioned software packages as of June 2022.

---

<sup>1</sup>`tntorch` can be installed conveniently via the PyPI package manager (command: `pip install tntorch`)

## 2 Supported Tensor Formats

tntorch supports several decomposition models that are important in the context of machine learning, including CANDECOMP/PARAFAC (CP, Harshman, 1970), the Tucker decomposition<sup>2</sup> (de Lathauwer et al., 2000), and the tensor train (TT, Oseledets, 2011). These formats are encapsulated into a single class `Tensor` and share a common interface for all supported operations, which in turn replicate the API of PyTorch as closely as possible. Internally, the decomposition is stored as a low-rank *tensor network*: a graph whose nodes are low-dimensional tensors and whose edges are tensor dimensions that may be contracted together (Cichocki et al., 2016) by performing the corresponding operation (e.g., a matrix-vector product). Tensors in tntorch can mix more than one format, e.g., one may attach Tucker factors to TT cores, interleave CP and TT cores, or even blend all three formats in various ways. See Fig. 1 for illustrative examples.

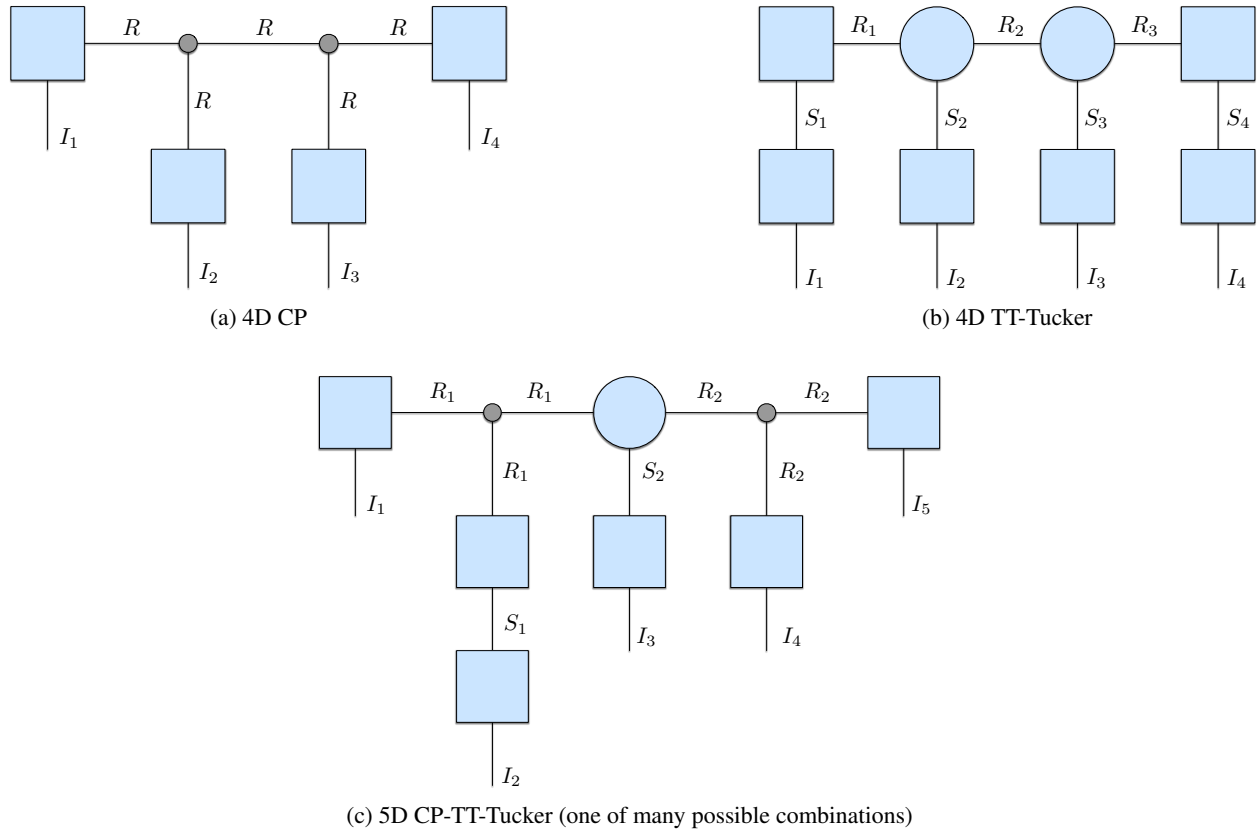

Figure 1: Examples of tensor networks that can be assembled in tntorch. A square represents a matrix, as used for CP factors, Tucker factors, and for the first and last cores of a TT; a circle is a 3D tensor and is used for internal TT cores; a dot is a 3D copy tensor (Biamonte, 2019), i.e., a super-diagonal tensor with ones along the diagonal.

In tntorch, every decomposition consists of a sequence of cores and, optionally, one or more factors. All nodes of the resulting tensor network may also be accessed directly if the user desires low-level control. By virtue of this abstraction, other tensor formats such as INDSCAL, CANDELINC, DEDICOM, and PARATUCK2 (Kolda and Bader, 2009) can be represented as `Tensor` objects, too. See documentation for details.

<sup>2</sup>The Tucker tensor is represented as a TT with arbitrary ranks, which has equal expressive power. Furthermore, Tucker factors are implemented as standard unconstrained matrices, in contrast to other implementations that often implement them as unitary/orthogonal matrices.

### 3 Features and Operations

#### 3.1 Learning Tensors

Given a data tensor, `tntorch` can fit a decomposition in multiple ways. E.g., gradient descent is available out-of-the-box, thanks to PyTorch’s automatic differentiation and the numerous optimizers it provides. It is very general, as it can be used to learn incomplete tensors, tensors with constraints, or to add various loss terms. For the case of learning TT tensors, a cross-approximation routine is provided that performs adaptive sampling (Oseledets and Tyrtshnikov, 2010). Other methods include *TT-SVD* (Oseledets, 2011), *higher-order SVD* and *alternating least squares* (Kolda and Bader, 2009) for the TT, Tucker and CP formats, respectively.

#### 3.2 Tensor Arithmetics

The library supports `tensor×matrix` and `tensor×vector` products, element-wise operations, dot products, convolution, concatenation, mode reordering, padding, orthogonalization, rank truncation, and more. These are useful for common use cases in machine learning: tensor completion; learning low-rank layers or compressing/approximating existing layers; applying multi-linear operators; dimensionality reduction; etc. Advanced element-wise functions such as `/`, `exp`, and `tanh` can be approximately computed via cross-approximation (currently available for TT tensors). Besides these features, `tntorch` also implements further, miscellaneous tools, such as: sensitivity analysis; Boolean algebra operations; statistical moments; a smart reduction operator; sampling from TT-compressed distributions; multi-linear polynomial expansions; etc.

#### 3.3 Slicing and Indexing

Any Tensor may be accessed in several ways:

- *Basic indexing* via slices in the format `start:stop:step` and variants, as in `t[: :-1]`;
- *Fancy indexing* via handcrafted, possibly irregular slices, e.g. by passing a list of indices as in `t[:, (0, 3, 4)]`;
- Indexing by NumPy arrays. For example, accessing an  $N$ -dimensional tensor by an  $M \times N$  NumPy matrix returns a 1D tensor with  $M$  elements.
- Insertion of dummy dimensions, as in `t[None, :]`, or ellipsis, as in `t[ ..., 3]`;
- Broadcasting is supported, i.e., operations will be repeated along one or more dimensions when their sizes do not match. For example, if `t` is a 1D tensor, then `t[:, None] + t[None, :]` is a square matrix.

Such read operations match the behavior of PyTorch tensors almost exactly<sup>3</sup>. They are performed in the compressed domain and return a compressed `Tensor`. Moreover, tensors can be edited using the expected syntax, as in `a[:, 0, :] = 2 * b[0, :, :]` or `t[(0, 2), ..., -1, ::3] += 1`. All read/write operations preserve differentiability, a behavior at present unique to `tntorch`, to the best of our knowledge.

#### 3.4 Batched Tensors

Batch processing is an important capability to increase the efficiency of tensor-based learning. Besides being differentiable and GPU-ready, decomposition and arithmetic operations in `tntorch` work on batches of tensors in any format; internally, a batch is represented as an extra dimension in every node of the tensor network. As an example, we can decompose multiple tensors into TT cores at once using the TT-SVD algorithm (Oseledets, 2011), with linear algebra operations applied in batches. See Section 4 for a benchmark.

#### 3.5 Tensor Train Matrices

The TT matrix decomposition has recently become a particularly relevant format, because it is, among others, well-suited to compress neural weight layers (Novikov et al., 2015). Unlike standard tensors, a TT matrix has a different indexing scheme, with two sets of row and column indices. As a consequence, TT matrices come with a distinct set of computation rules for standard operations such as `matrix×vector` multiplication. Therefore, they have their own class `TTMatrix`, with a separate API. See additional details in Appendix A.4

<sup>3</sup>Interleaving fancy and basic indices is not supported, as it is in general computationally expensive.

## 4 Performance

We benchmark `tntorch`'s running times across four representative operations: TT decomposition using the TT-SVD algorithm, cross-approximation, and two arithmetic operations that can be achieved by direct manipulation of TT cores (Oseledets, 2011). We test four modalities: CPU vs. GPU, and in both cases *for loop* vs. vectorized batch processing. As a baseline, we also compare with the Python library `ttpy` (Oseledets, 2015), which is written in NumPy and FORTRAN and also implements these four operations. All experiments use randomly initialized tensors of TT-rank  $R = 20$ , physical dimension sizes  $I = 15, \dots, 45$ , and number of dimensions  $N = 8$  (except for the TT-SVD experiment, where  $N = 4$ ). We used PyTorch 1.13.0a0+git87148f2 (compiled from source) and NumPy 1.22.4 on an Intel(R) Core(TM) i7-7700K CPU with 64Gb RAM and an NVIDIA GeForce RTX 3090 GPU.

Results are reported in Fig. 2. Note that the GPU is more performant on both batch and non-batch modes. Also, `tntorch` scales better (or similarly, for cross-approximation) than the baseline w.r.t. the tensor size, and is thus a good fit for data-intensive ML applications.

## 5 Conclusions

We have introduced `tntorch`, a PyTorch-powered library that unifies multiple efficient tensor formats under the same interface, together with a rich suite of learning and analysis routines. The library comes with many standard features of modern machine learning frameworks, including auto-differentiation, GPU and batch processing, and advanced indexing. `tntorch` imitates the look and feel of standard PyTorch tensors, while making the power of low-rank tensor decompositions accessible for machine learning.

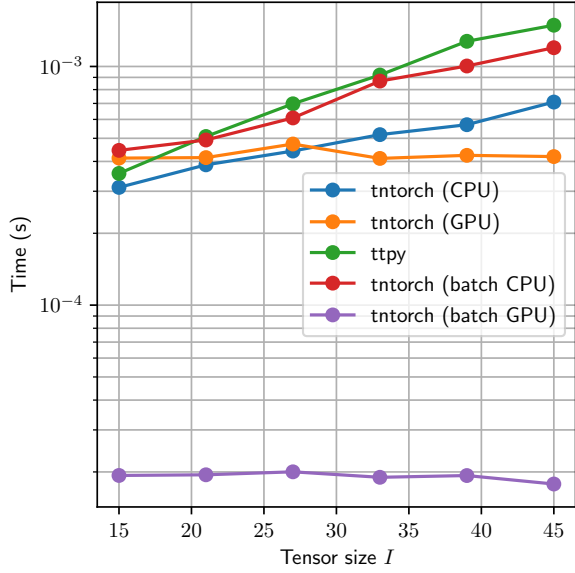

(a) Element-wise sum

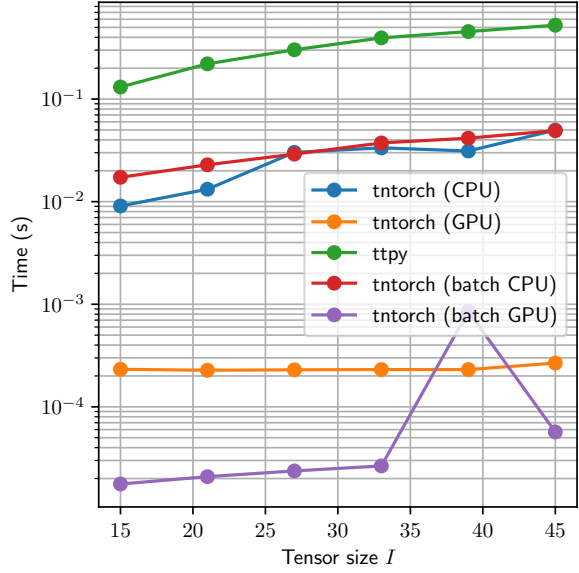

(b) Element-wise product

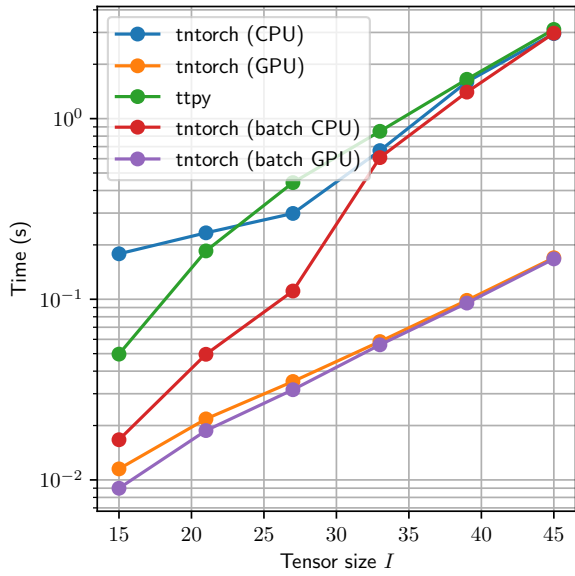

(c) TT-SVD

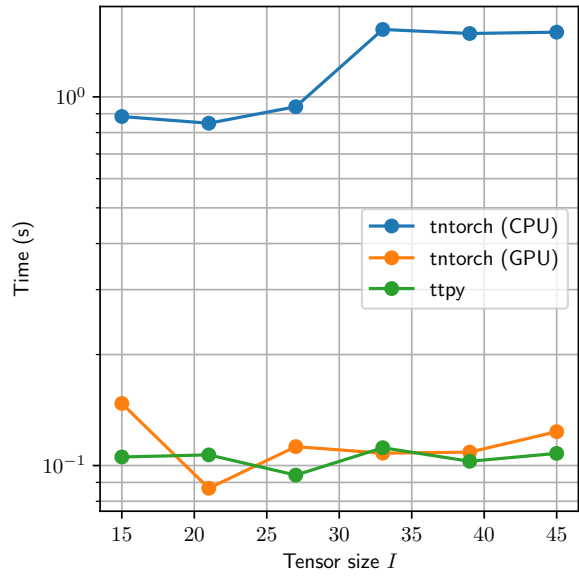

(d) Cross-approximation

Figure 2: Runtimes of four operations with varying tensor sizes (average time per processed object, over 10 runs). The batch size is set to  $B = 32$ . Best viewed in color.

## A Appendix

### A.1 Additional details

We heavily exploit the versatility of Einstein summation algebra as made possible by PyTorch’s `einsum` function. Effectively, `einsum` allows to represent tensor operations like summation and multiplication using compact strings of symbols, each encoding one tensor index. `tntorch` represents basic decompositions using:

- CP: a sequence of 2D factor matrices
- TT: a sequence of 3D tensor train cores
- Tucker: the cores are TT-like, but they are chosen so as to be error-free (i.e. they are not rank reduced). In addition, there is a sequence of 2D factors to encode the Tucker bases.

### A.2 Comparison between tensor libraries

	tntorch	T3F	TensorLy	TedNet	TensorD	TensorNetwork	tt-pytorch
Tensor arithmetics	✓	✓	-	-	✓	-	-
Fancy indexing	✓	-	-	-	-	-	-
CP decomposition	✓	-	✓	✓	✓	✓ <sup>1</sup>	-
Tucker decomposition	✓	-	✓	-	✓	✓ <sup>1</sup>	-
TT decomposition	✓	✓	✓	✓	-	✓ <sup>1</sup>	✓
CP/Tucker/TT blending	✓ <sup>2</sup>	-	-	-	-	✓ <sup>1</sup>	-
Tensor ring	-	-	-	✓	-	✓ <sup>1</sup>	✓
Hierarchical/tree formats	-	-	-	-	-	✓ <sup>1</sup>	-
TT matrix	✓	✓	✓	-	-	✓ <sup>1</sup>	-
CP matrix	✓	-	-	-	-	✓ <sup>1</sup>	-
Cross-approximation	✓	-	✓	-	-	-	-
Global optimization	✓	-	-	-	-	-	-
Riemannian optimization	-	✓	-	-	-	-	-
Batch processing	✓	✓ <sup>2</sup>	-	✓	-	✓ <sup>1</sup>	-
Sparse tensor algorithms	-	✓	✓	-	-	-	-

Table 1: Feature comparison between `tntorch` and six related libraries that also support GPU processing and automatic differentiation as of June 2022.

### A.3 Cross-approximation

`tntorch` implements *cross-approximation* (Oseledets and Tyrtshnikov, 2010), a powerful technique to learn a compressed TT tensor out of a black-box function by evaluating it on a limited set of samples. This is a valuable tool when the target tensor does not fit into memory but it can be sampled on demand, and can be used for surrogate modeling or to efficiently compute functions of already compressed tensors. Cross-approximation has also been adapted as a gradient-free global optimizer for discrete problems, and an implementation is available in `tntorch`. See Sozykin et al. (2022) for a detailed example of an application in reinforcement learning. `tntorch` also provides a differentiable version of cross-approximation which alternates between sample selection (which is a combinatorial, non-differentiable heuristic), followed by evaluation and backpropagation of the target function on the selected samples (Usvyatsov et al., 2021).

Under the hood, cross-approximation selects indices based on a tensor version of an earlier algorithm known as *maxvol* (Mikhalev and Oseledets, 2018). In short, *maxvol* is a greedy heuristic that finds the  $k$  most linearly independent rows or columns from a given matrix (known to be an  $\mathcal{NP}$ -hard problem (Civril and Magdon-Ismail, 2009)). We use the *maxvolpy* library by Mikhalev (2016), which relies on BLAS, for this algorithm, but `tntorch` also provides its own implementation to fall back to whenever BLAS is not available.

### A.4 Tensor Train Matrices

A matrix of shape  $M \times N$  (Fig. 3a) transforms to a tensor of shape  $m_1 \times \dots \times m_k \times n_1 \times \dots \times n_k$ , where  $M = m_1 \times \dots \times m_k$  and  $N = n_1 \times \dots \times n_k$ . Corresponding row and column dimensions are grouped together and the shape

<sup>1</sup>Tensor networks can be constructed, but no tools are provided to decompose a given data tensor into a desired network.  
<sup>2</sup>Batched decomposition of a data tensor is not supported.

of the resulting tensor becomes  $m_1 \times n_1 \times \dots \times m_k \times n_k$  (Fig. 3b). The tensor is subject to standard TT decomposition with the cores of shape  $R_i \times m_i n_i \times R_{i+1}$  (Fig. 3c) and finally each core is reshaped to  $R_i \times m_i \times n_i \times R_{i+1}$  (Fig. 3d), separating each input and output dimension on the core level. Many operations discussed in [Izmailov et al. \(2018\)](#) have also been implemented in tntorch, including fast matrix inverse and determinant algorithms for rank-1 TT matrices that are equivalent to Kronecker products.

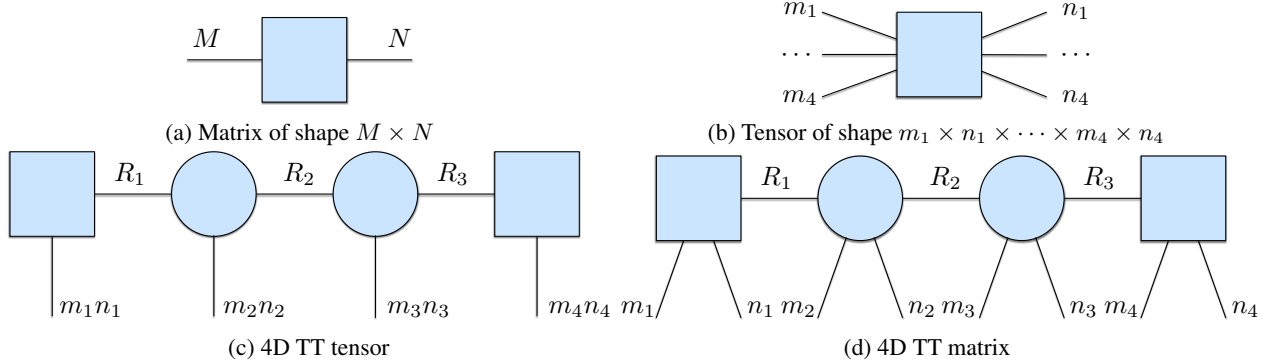

Figure 3: Example of conversion of matrix to 4D TT tensor and corresponding TT matrix

`tt_multiply`. In TT format matrix  $\times$  vector multiplication does not require decompression. The vector of shape  $N$  (Fig. 4a) is reshaped as in Fig. 4 to a tensor of shape  $n_1 \times \dots \times n_k$  (Fig. 4b), such that  $N = n_1 \times \dots \times n_k$  and corresponding dimensions are contracted with the TT matrix (Fig. 3d). The result of matrix  $\times$  vector operation is a contracted tensor of shape  $m_1 \times \dots \times m_k$ , which can be reshaped back to a vector of shape  $M$ . See ([Novikov et al., 2015](#)) for more details.



Figure 4: Example of vector transformation for `tt_multiply`

### A.5 CP Matrices

Similarly to TT matrix decomposition, we have also implemented a CP matrix decomposition. The scheme for indexing and regrouping dimensions is identical to that of `TTMatrix`. In a CP matrix, each CP factor has shape  $m_i n_i \times R$  but is conceptually equivalent to  $m_i \times n_i \times R$ , where  $m_i$  and  $n_i$  are spatial dimensions. Like `TTMatrix`, CP matrices require custom operations (such as matrix  $\times$  vector products) that are not available for CP tensors and thus are implemented as a separate class `CPMatrix`. See Fig. 1a for a visualization of a CP tensor and Fig. 5 for the corresponding CP matrix with  $I_k = m_k \times n_k$ .

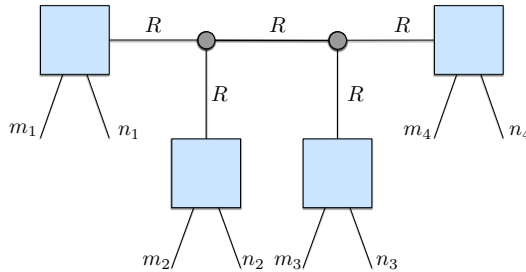

Figure 5: 4D CP matrix, during matrix  $\times$  vector multiplication dimensions  $m_k$  are contracted with corresponding vector dimensions

## References

- Biamonte, J. (2019). Lectures on quantum tensor networks. *arXiv preprint arXiv:1912.10049*. 2
- Cichocki, A., Lee, N., Oseledets, I. V., Phan, A.-H., Zhao, Q., and Mandic, D. P. (2016). Tensor networks for dimensionality reduction and large-scale optimization: Part 1 - Low-rank tensor decompositions. *Foundations and Trends in Machine Learning*, 9(4-5):249–429. 1, 2
- Civril, A. and Magdon-Ismail, M. (2009). On selecting a maximum volume sub-matrix of a matrix and related problems. *Theoretical Computer Science*, 410(47-49):4801–4811. 6
- de Lathauwer, L., de Moor, B., and Vandewalle, J. (2000). On the best rank-1 and rank- $(R_1, R_2, \dots, R_N)$  approximation of higher-order tensors. *SIAM Journal of Matrix Analysis and Applications*, 21(4):1324–1342. 2
- Gusak, J., Kholiavchenko, M., Ponomarev, E., Markeeva, L., Oseledets, I., and Cichocki, A. (2019). MUSCO: Multi-stage compression of neural networks. *arXiv preprint 1903.09973*. 1
- Hao, L., Liang, S., Ye, J., and Xu, Z. (2018). TensorD: A tensor decomposition library in TensorFlow. *Neurocomputing*, 318:196–200. 1
- Harshman, R. A. (1970). Foundations of the PARAFAC procedure: Models and conditions for an “explanatory” multi-modal factor analysis. *UCLA Working Papers in Phonetics*, 16:1–84. 2
- He, W., Chen, Y., Yokoya, N., Li, C., and Zhao, Q. (2022). Hyperspectral super-resolution via coupled tensor ring factorization. *Pattern Recognition*, 122:108280. 1
- Hrinchuk, O., Khrulkov, V., Mirvakhobova, L., Orlova, E., and Oseledets, I. (2019). Tensorized embedding layers for efficient model compression. *arXiv preprint 1901.10787*. 1
- Idelbayev, Y. and Carreira-Perpiñán, M. Á. (2020). Low-rank compression of neural nets: Learning the rank of each layer. In *Proceedings of the IEEE/CVF Conference on Computer Vision and Pattern Recognition*, pages 8049–8059. 1
- Izmailov, P., Novikov, A., and Kropotov, D. (2018). Scalable gaussian processes with billions of inducing inputs via tensor train decomposition. In *International Conference on Artificial Intelligence and Statistics*, pages 726–735. PMLR. 7
- Khrulkov, V., Hrinchuk, O., Mirvakhobova, L., Orlova, E., and Oseledets, I. (2019). Tensorized embedding layers for efficient model compression. *arXiv preprint 1901.10787*. 1
- Kolbeinsson, A., Kossaiji, J., Panagakis, Y., Bulat, A., Anandkumar, A., Tzoulaki, I., and Matthews, P. M. (2021). Tensor dropout for robust learning. *IEEE Journal of Selected Topics in Signal Processing*, 15(3):630–640. 1
- Kolda, T. G. and Bader, B. W. (2009). Tensor decompositions and applications. *SIAM Review*, 51(3):455–500. 1, 2, 3
- Kossaiji, J., Panagakis, Y., Anandkumar, A., and Pantic, M. (2019). TensorLy: Tensor learning in Python. *Journal of Machine Learning Research*, 20(1):925–930. 1
- Kossaiji, J., Toisoul, A., Bulat, A., Panagakis, Y., Hospedales, T. M., and Pantic, M. (2020). Factorized higher-order CNNs with an application to spatio-temporal emotion estimation. In *Proceedings of the IEEE/CVF Conference on Computer Vision and Pattern Recognition*, pages 6060–6069. 1
- Kuznetsov, M., Polykovskiy, D., Vetrov, D., and Zhebrak, A. (2019). A prior of a googol Gaussians: a tensor ring induced prior for generative models. In *Advances in Neural Information Processing Systems*, pages 4104–4114. 1
- Ma, X., Zhang, P., Zhang, S., Duan, N., Hou, Y., Zhou, M., and Song, D. (2019). A tensorized transformer for language modeling. In *Advances in Neural Information Processing Systems*, pages 2232–2242. 1
- Mikhalev, A. (2016). maxvolpy: routines for finding maximum volume submatrices and building cross- and CGR-approximations. BitBucket repository, <https://bitbucket.org/muxas/maxvolpy>. 6
- Mikhalev, A. and Oseledets, I. V. (2018). Rectangular maximum-volume submatrices and their applications. *Linear Algebra and its Applications*, 538(Supplement C):187 – 211. 6
- Novikov, A., Izmailov, P., Khrulkov, V., Figurnov, M., and Oseledets, I. (2020). Tensor train decomposition on TensorFlow (T3F). *Journal of Machine Learning Research*, 21:1–7. 1
- Novikov, A., Podoprikin, D., Osokin, A., and Vetrov, D. (2015). Tensorizing neural networks. In *Advances in Neural Information Processing Systems*, pages 442–450. 1, 3, 7
- Oseledets, I. V. (2011). Tensor-train decomposition. *SIAM Journal on Scientific Computing*, 33(5):2295–2317. 2, 3, 4
- Oseledets, I. V. (2015). ttpy: Python implementation of the tensor train (TT)-Toolbox. GitHub repository, <https://github.com/oseledets/ttpy>. 4



- Oseledets, I. V. and Tyrtyshnikov, E. (2010). TT-cross approximation for multidimensional arrays. *Linear Algebra Applications*, 432(1):70–88. [3](#), [6](#)
- Pan, Y., Wang, M., and Xu, Z. (2021). TedNet: a PyTorch toolkit for tensor decomposition networks. *arXiv e-prints*. [1](#)
- Panagakos, Y., Kossaifi, J., Chrysos, G. G., Oldfield, J., Nicolaou, M. A., Anandkumar, A., and Zafeiriou, S. (2021). Tensor methods in computer vision and deep learning. *Proceedings of the IEEE*, 109(5):863–890. [1](#)
- Roberts, C., Milsted, A., Ganahl, M., Zalcmán, A., Fontaine, B., Zou, Y., Hidary, J., Vidal, G., and Leichenauer, S. (2019). TensorNetwork: A library for physics and machine learning. [1](#)
- Sozykin, K., Chertkov, A., Schutski, R., Phan, A.-H., Cichocki, A., and Oseledets, I. (2022). Ttopt: A maximum volume quantized tensor train-based optimization and its application to reinforcement learning. *arXiv preprint arXiv:2205.00293*. [6](#)
- Usvyatsov, M., Makarova, A., Ballester-Ripoll, R., Rakhuba, M., Krause, A., and Schindler, K. (2021). Cherry-picking gradients: Learning low-rank embeddings of visual data via differentiable cross-approximation. In *International Conference on Computer Vision*. [1](#), [6](#)
- Wang, D., Wu, B., Zhao, G., Chen, H., Deng, L., Yan, T., and Li, G. (2020). Kronecker cp decomposition with fast multiplication for compressing rnns. *arXiv preprint 2008.09342*. [1](#)