

# Vildehaye: A Family of Versatile, Widely-Applicable, and Field-Proven Lightweight Wildlife Tracking and Sensing Tags

Sivan Toledo  
Shai Mendel  
Tel Aviv University

Anat Levi  
Yoni Vortman  
Tel Hai College

Wiebke Ullmann  
Lena-Rosa Scherer  
Jan Pufelski  
University of Potsdam

Frank van Maarseveen  
Bas Denissen  
Allert Bijleveld  
Royal Netherlands Institute for Sea  
Research

Yotam Orchan, Yoav Bartan  
Sivan Margalit  
Idan Talmon  
Ran Nathan  
The Hebrew University of Jerusalem

## ABSTRACT

We describe the design and implementation of *Vildehaye*, a family of versatile, widely-applicable, and field-proven tags for wildlife sensing and radio tracking. The family includes 6 distinct hardware designs for tags, 3 add-on boards, a programming adapter, and base stations; modular firmware for tags and base stations (both standalone low-power embedded base stations and base stations tethered to a computer running Linux or Windows); and desktop software for programming and configuring tags, monitoring tags, and downloading and processing sensor data. The tags are versatile: they support multiple packet formats, data rates, and frequency bands; they can be configured for minimum mass (down to less than 1 g), making them applicable to a wide range of flying and terrestrial animals, or for inclusion of important sensors and large memories; they can transmit packets compatible with time-of-arrival transmitter-localization systems, tag identification and state packets, and they can reliably upload sensor data through their radio link. The system has been designed, upgraded, and maintained as an academic research project, but it has been extensively used by 5 different groups of ecologists in 4 countries over a period of 5 years. More than 7100 tags have been produced and most of these have been deployed. Production used 41 manufacturing runs. The tags have been used in studies that so far resulted in 9 scientific publications in ecology (including in *Science*). The paper describes innovative design aspects of *Vildehaye*, field-use experiences, and lessons from the design, implementation, and maintenance of the system. Both the hardware and software of the system are open.

## 1 INTRODUCTION

Despite rapid and ongoing advances in tracking, sensing, and communication technologies, studying the movement, behavior, and physiology of many species of wild animals remains highly challenging [42]. Most bird and bat species, as well as many small mammals and reptiles, can only carry miniature tracking tags with short antennas that must not entangle. Solar energy harvesting is not an option for nocturnal and underground species (including most bats and rodents). Consequently, technologies designed for

humans and their belongings are often poorly matched to animal sensing and tracking.

This paper presents *Vildehaye* (VH for short) a family of versatile, widely-applicable, and field-proven lightweight wildlife tracking tags, base stations that communicate with them, and software that processes data gathered by tags. VH tags are tiny, down to less than 1 g, making them applicable to a wide range of species. They can be used for regional high-throughput radio tracking using the ATLAS system [4, 23, 56]. VH tags are modular: add-on boards with sensors and large non-volatile memories can be attached to the basic radio tag, allowing tags to sense the behavior and environment of the animal and to log the data. The data is retrieved either by recapturing the animal or by uploading data via radio to a nearby base station. The tags can also upload via radio data from existing specialized wildlife data loggers. A VH tag can turn on an actuator upon reception of a radio command; this is used to release data loggers attached to wild birds. The tags are available for two popular license-free UHF frequency bands and can be easily modified to support many other VHF and UHF bands. VH tags come in several variants featuring different tradeoffs between size and functionality.

VH tags are easy for ecologists to use. A spreadsheet allows researchers to predict the lifespan of a particular variant with a particular battery under a given radio schedule. Printed circuit boards (PCBs) can be ordered directly from a manufacturer in any quantity. Tags are programmed and configured using a simple and inexpensive FTDI USB-to-serial dongle and dedicated software. Users routinely provide and share know-how on how to attach batteries and antennas, how to weatherproof tags, and how to attach them.

Consequently, at least 7100 VH tags have been deployed to successfully track and sense a wide range of wild animals. Users span 5 separate ecology research groups in Israel, the Netherlands, the UK, and Germany, and additional groups in additional countries are in the process of adopting the tags. Data collected using VH tags have already been analyzed and published in several research articles in the scientific (ecology) literature, including *Science* [3, 5, 11, 24, 35, 54, 55], and additional articles are in preparation.

This paper enumerates requirements that users presented the design team (Section 2) and it presents the resulting design from

arXiv:2206.06171v1 [cs.NI] 4 May 2022

the users' viewpoint (Section 3). Section 4 presents the detailed design of the tags and their associated software. The discussion emphasizes innovative aspects related to energy efficiency and effective use of miniature batteries, to the radio protocol, and to effective logging of sensor data to flash. Section 5 discusses certain features that we decided not to implement. Section 6 describes four distinct use cases of the tags, three of which have been used in the field, to demonstrate the versatility and robustness of the design. We conclude the paper with a discussion of related work in Section 7 and with our conclusions from the project in Section 8.

## 2 REQUIREMENTS

The requirements for VH tags were largely defined by users. The initial motivation came from user feedback on the first generation of tags designed for the first ATLAS tracking system [52]. These users expressed a set of needs and desires that led to the initiation of the Vildehaye project in the spring of 2016. As the project progressed, additional requirements came up as users imagined new applications for the tags.

Requirements whose importance was ranked high by users include:

- Compatibility with ATLAS; tags must be able to transmit unique pseudo-random data packets at high data rates at an accurate ping-repetition interval [56].
- Mass that is as low as possible, ideally down to 1 g or less, for wide applicability; ecologists typically limit the mass of a tag to around 3% of the mass of the animal, and many species of interest are small (and thus challenging to track and sense). The effects of tracking and sensing tags have been extensively investigated; in general, tags cause some detrimental effects [6, 25], but their use is nonetheless ethically and scientifically justified in many cases. Smaller tags have smaller effects, so they are preferable.
- On-board sensors, especially accelerometers and altimeters, to provide additional information on the location, environment, and behavior of the animal.
- Modular hardware and/or multiple hardware variants, to allow production of both very lightweight tags with limited functionality and lifespan, and heavier tags with sensors, large memories, and long lifespans; in particular, multiple battery configurations must be supported.
- Upload of sensor measurements from tags to base stations via a radio link, to avoid the need to retrieve the tag in order to collect the data. Users understand that radio data transfer uses battery energy and shortens the lifespan of tags powered by primary batteries.
- Easy programming and configuration (ping-repetition intervals, switching between intervals, sensing schedules, etc.).
- Low-cost manufacturing in both small and large batches.

Over time, users came up with a few additional requests. The requests were examined; some were addressed but not all:

- Transmitting tag-identification packets that can be received by a base station (ideally a low-power base station that can be powered by a primary battery) to indicate proximity of the tag to the base station at distances of up to a few or even tens of kilometers; accepted and implemented at ranges of up to a few kilometers.

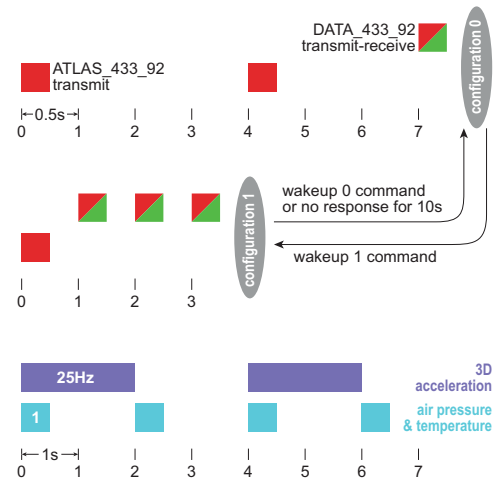

**Figure 1: A sample definition of the behavior of a tag. The first two rows show two radio configurations, 0 and 1, each with two radio setups called ATLAS\_433\_92 and DATA\_433\_92. Configurations are states in a finite-state machine; arrows indicate transition rules. Red squares represent transmit-only slots. Red/green squares represent a slot in which the tag transmits and then listens for a reply from a base station. Acceleration is sensed in bursts, at 25 Hz for 2 seconds every 4 s; air pressure and temperature are sensed once every 2 s. The width of colored squares is not to scale.**

- The ability to transmit a command to a tag to either change its operational schedule (e.g., change ping-repetition interval, attempt data upload) and/or to activate an actuator; implemented.
- The ability to detect close-range encounters between tags even outside the range of an ATLAS tracking system.
- The ability to interoperate with other wildlife radio tracking and sensing systems; implemented with respect to one such system; there are plans to expand.

At a high level, the design of VH tags aims to be as *widely-applicable* and as *versatile* as possible in the sense that it should address as many use cases that require *lightweight radio tags* as possible. The design does not aim to address use cases that can tolerate high weights, high power consumption, or completely different tracking modalities [42], such as GNSS localization [26], underwater ultrasound localization [14], underground magneto-inductive localization [38, 43], or data upload through cellular networks; these use cases require different hardware and firmware architectures so trying to support them would defocus the project.

## 3 USER-FACING DESIGN

**Defining Tag Behavior.** Users define the radio behavior and sensor behavior of a tag using abstractions shown graphically in Figure 1. The radio behavior is defined in terms of a user-specified *period*, here 0.5 s, a set of predefined *radio setups*, which define the frequency, modulation, symbol rate, packet format, etc. (here ATLAS\_433\_92 and DATA\_433\_92), and a set of *configurations*. Each

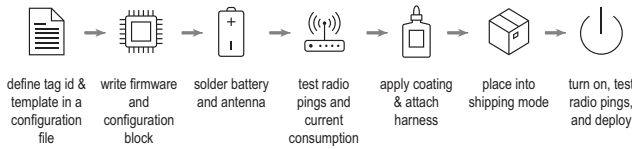

**Figure 2: The steps of preparing a VH tag.**

configuration defines a schedule for the radio in terms of a fixed number of *slots* spaced one period apart. Slots are allocated to radio setups using a cyclic allocation with a given starting slot. In our example, configuration 1 repeats every 8 slots; ATLAS\_433\_92 is allocated every 4th slot starting at slot 0; DATA\_433\_92 is allocated every 8th slot, starting at 7. The slots of the ATLAS setup are transmit-only slots. The slots of the DATA setup are marked as slots that transmit and then listen for a reply from a base station. The definition of the tag also specifies the state machine that controls transitions between configurations. Here, transition from configuration 0, defined as the initial configuration, to configuration 1 occurs when the tag receives a *wakeup* command with argument 1 from a base station. The transition back occurs either when a wakeup 0 command is received, or when the tag has not heard any reply from a base station for 10 s. The actual transmission and reception periods are short, typically a few milliseconds long.

The sensing schedule is defined using a fixed 1 Hz grid. For each available sensor, the user defines how often it is sampled and whether the samples are one-shot or repetitive. For repetitive sampling the user specifies the length of the sampling period and the sampling rate. The user can also specify the configuration of each sensor (what quantities a multimodal sensor should sense, full-scale, etc). The definition in Figure 1 specifies sampling air pressure and temperature once every 2 s and acceleration every 4 s at in bursts of 25 Hz for 2 s.

Users can define the behavior of specific tags as well as general templates applied to tags. Tags have unique individual identification numbers even when defined from templates. All the definitions are stored in version-controlled text files.

**Preparing Tags for Deployment.** Figure 2 summarizes the process of preparing a VH tag. The user assigns a unique ID to the tag and defines its behavior, usually using an existing template. The user attaches a blank assembled tag PCB to an inexpensive USB-to-serial dongle and invokes software on a Windows computer to programs the appropriate firmware onto the tag, as well as a block of binary data that defines the behavior of the tag. Tags can be programmed over and over again. Physical preparation starts with soldering an antenna and a primary battery (single Lithium cell or 2 Silver Oxide cells) to the tag and testing that it transmits. Testing is done either using a VH base station or using a low-cost software-defined radio receiver (SDR) capable of detecting ATLAS transmissions. Next, the tag is coated with insulating varnish [1] and optionally protected from physical damage (biting, scratching) using epoxy ([28, 29], sometimes mixed with glass bubbles to reduce weight, or [2]); for other options for coating and protecting tags, see [14]. If the tag is deployed (attached to an animal) soon after production, it is often left active between production and deployment. Otherwise, the tag

is put into a *shipping mode* in which it consumes little or no power; see below for the mechanisms. When an add-on memory board is attached to a tag, the memory board must be *formatted* prior to attaching to the tag. Formatting the memory board is done using the same USB-to-serial dongle. The two PCBs are then mated using stacking board-to-board connectors, usually glued, and are coated together.

**Collecting Data from Tags.** Deployed tags can be tracked by ATLAS and VH base stations (ATLAS produces accurate localizations, VH base stations only a record of detecting the tag). Data collected by onboard sensors is retrieved in one of two ways. The tag can upload the data to a VH base station via a radio link, or the tag is physically retrieved and the data is downloaded either using the USB-to-serial dongle or by attachment of the memory board to the SPI bus of a Raspberry Pi (this is faster). Physical retrieval can be achieved either by recapturing the animal, or by locating and collecting a tag that was detached from the animal. Detachment can be achieved with both passive release mechanisms (an attachment mechanism that disintegrates over time) or using an active mechanism that is turned on by sending a command from a base station.

**Processing Collected Sensor Data.** Sensor data is stored on tags using a data structure called a *log*, which represents a sequence of pieces of data called *log items*. Data collected from tags is transferred an SQL database in raw form, each row storing a log item as a binary blob. Software running on Linux or Windows reads the log items associated with a particular tag and produces binary numeric files containing time-stamped sensor measurements. These files are read by Matlab or R software that performs further processing, such as converting air-pressure data to altitude, classifying behavior based on accelerometer data, and so on. Similar Matlab and R software is used to process location information from ATLAS tracking [23]. This analysis software is not part of the VH system and will not be further discussed in the paper.

## 4 TECHNICAL DESIGN AND IMPLEMENTATION

### 4.1 Hardware

**Overall Design.** VH tags are based on the low-power Texas Instruments CC1310 or CC1350 radio-frequency microcontroller (RF MCU; CC13X0 for short) chip. The chips contain an ARM Cortex-M3 processor, a VHF/UHF data transceiver, an ARM Cortex-M0 processor dedicated to the radio stack (not user programmable), a low-power processor called a *sensor controller* that can eliminate relatively slow (and hence power hungry) wakeups of the M3 processor, and a range of peripherals, including timers, UART, I2C, and SPI. The chips come in 4-by-4, 5-by-5, and 7-by-7 mm packages; our tags use the 4-by-4 mm package.

All tags contain a number of additional components, including an RF matching network, to match the RF MCU to the antenna and to filter harmonics, decoupling capacitors and passives for the switching and linear regulators, a fairly large (330  $\mu$ F) *reservoir capacitor*, a 32 kHz crystal for the real-time clock, a 24 MHz crystal for the radio, and a miniature male 14-pin board-to-board connector from the Molex *SlimStack* series. This connector is used for

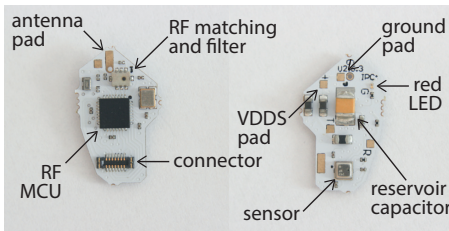

Figure 3: The main components of a tag (version 2.6.3).

programming and configuring tags, as well as for attachment of add-on boards. Figure 3 shows the parts of a typical tag.

**Hardware Variants.** Some tag designs include additional components, as shown in Figure 6. Most versions include an LED that helps users verify that tags function correctly. Version 2.6.3 includes an on-board air-pressure, temperature, and humidity sensor (BME280). Versions 2.8 and 2.9 include perforations between the connector and the rest of the tag, allowing the connector to be snapped off after programming, to save weight. Their 14-pin connector does not carry the I2C and SPI buses, to make the boards more compact. Version 3.10 includes a separate transmitter, AX5043, to support phase modulation [31].

The RF matching networks of the most tag designs are tuned for the 434 MHz band, but version 2.10 is tuned to the 868 and 915 MHz bands. Some variants (2.6.1, 2.6.2f, 2.8, 2.9) use a discrete balanced-to-unbalanced network (BALUN) and an integrated low-pass filter, but we also have all-discrete designs and designs (2.6.3, 3.10) that rely on a single integrated passive component (IPC) for all the matching and filtering (2.6.3, 2.10). Most of our tag designs are shown in Figure 6, along with some of our add-on boards.

The firmware for both tags and base stations runs on CC13X0 LaunchPads and on newer CC13X2 LaunchPads, in which the MCU has a stronger processor (Cortex-M4F) and optionally a 20 dBm RF power amplifier, as well as on low-cost CC1310 and CC1352 modules from a Ebyte, a Chinese manufacturer.

**Batteries and Voltage Regulation.** VH tags are powered by primary batteries including Lithium Manganese Dioxide coin cells [18–20, 44], pairs of Silver Oxide cells [21, 22], and Lithium Thionyl Chloride batteries [49]. Zinc Air batteries, which appear effective in laboratory testing [51] proved so far unreliable in the field. All of these batteries can directly power CC13XX chips, which require a supply voltage and I/O voltage of 1.8–3.8 V (the Lithium Thionyl Chloride batteries must be drained a bit before connecting to a tag, to bring their voltage down to 3.8 V). The chips regulate the supply voltage down to 1.65 V or 1.8 V (allowing transmission at 10 or 14 dBm, respectively) using either a linear or a switching regulator. We use the more power-efficient switching regulator. Most of the internal functional blocks require even lower voltages generated by internal linear regulators from the 1.65 or 1.8 V rail.

Miniature batteries cannot provide the instantaneous current required during transmission; this current must be supplied by reservoir capacitors [15, 51, 52]. We usually use a 330  $\mu\text{F}$  tantalum capacitor. Physically small high-capacitance capacitors are leaky [30, F95 Series]; their leakage current far exceeds the approximately 1  $\mu\text{A}$  that the MCU consumes in sleep mode. This has two

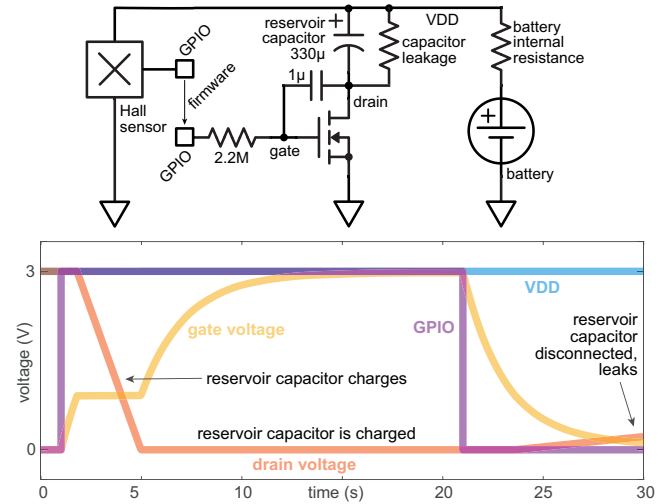

Figure 4: Slowing down the charging of the reservoir capacitor. The leakage resistor and battery’s internal resistor are not actual components but rather part of the model used to simulate the behavior (bottom). The simulation used values of 250K and 10 for the two resistors and was carried out in LTSpice XVII; the results were validated experimentally.

implications: (1) very low duty cycles are ineffective, because they waste most of the battery’s energy on leakage in the reservoir capacitor, and (2) if the battery is small, either the capacitor or the battery must be disconnected until the tag is about to be deployed; we refer to this as shipping mode.

**Shipping Mode.** We support three different shipping-mode mechanisms. The simplest one involves leaving part of one of the wires connecting the battery to the PCB outside the tag’s coating. The tag is tested and then the wire is cut. To deploy, the wire is soldered back and the joint is coated with a bit of varnish or epoxy. This can be done in the field immediately prior to deployment. The wire is used as a primitive and lightweight switch. This simple method has two drawbacks. Soldering in the field and covering the joint are skills that not all ecologists have. Also, with very small batteries the tag might not start up properly, because the reservoir capacitor slows down the voltage rise that the MCU senses; the reset mechanism is not always triggered.

The second shipping-mode mechanism, shown in Figure 4, is implemented in Version 2.9. It includes a Hall sensor and a MOSFET that can disconnect the leaky reservoir capacitor. When a magnet is placed near the tag, the Hall sensor senses it and the MCU turns off the MOSFET to disconnect the capacitor. When the magnet is removed, the reservoir capacitor is reconnected, allowing the tag to transmit. Turning on the MOSFET quickly would reconnect the discharged capacitor, a very low-impedance load, to the miniature battery, causing a sharp voltage drop that would turn off the MCU. The addition of a large gate resistor and a gate-drain capacitor amplifies the Miller effect and charges the capacitor at a controlled constant current, eliminating the problem.

The third shipping mode mechanism, designed for larger batteries (e.g., CR2032) and shown in Figure 5 is implemented in Version



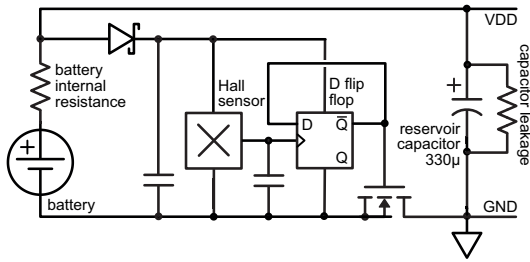

**Figure 5: Disconnecting and reconnecting the battery to the MCU and reservoir capacitor. No firmware support is required.**

**Table 1: The number of CircuitHub manufacturing runs for the main VH circuit boards.**

2.0	2.6.1	2.6.3	2.8	2.9	2.10	3.10	sensors +64MB	sensors +8MB	adapter
1	13	2	7	7	1	1	4	1	4

2.6.2f. Here the hall sensor drives a flip flop whose output connects or disconnects the battery from the rest of the tag, including both the MCU and the reservoir capacitor. No firmware support is needed, but the circuit charges the capacitor quickly and it requires an extra component, the flip flop.

**Add-on Boards.** We currently have two types of add-on boards. One contains an SPI flash memory chip and two sensors, an inertial measurement unit (IMU) containing an accelerometer, gyroscope, and optionally a magnetometer (Bosch BMI160 or BMX160), and an air pressure, temperature, and humidity sensor (Bosch BME280). The memory chip is either a 64 MB NOR flash in an 8-by-6 mm 8-WSON package or an 8MB flash in a 4-by-4 mm USON package. All the chips in these add-on boards allow for a wide range of supply voltages, at least 1.8-3.6 V, almost the same as the RF MCU. The larger 8-WSON footprint can also accommodate NAND flash chips with much larger capacity, but these require voltage regulation and firmware features that we have not yet implemented.

The other type of add-on board includes a MOSFET low-side switch and a flyback diode and is designed to activate a DC motor that powers a tag-release mechanism.

Add-on boards have a male 14-pin connector on the component side and a female connector on the back, where no components are placed, to allow stacking.

Section 8 discusses the tradeoffs involved in the use of add-on boards versus specialized integrated tag variants.

**Manufacturing.** Tags and other boards in the VH system have been designed by the authors and have been manufactured by CircuitHub [9]. We usually use thin 0.4 mm boards to reduce weight, with 4 copper layers for tags and 2 for add-ons. Complete tag PCBs cost about 25 USD in batches of 100 and about 11 USD in batches of 1000 (exact prices vary with the specific design and over time). Table 1 shows how many orders (manufacturing runs) were placed for different VH boards.

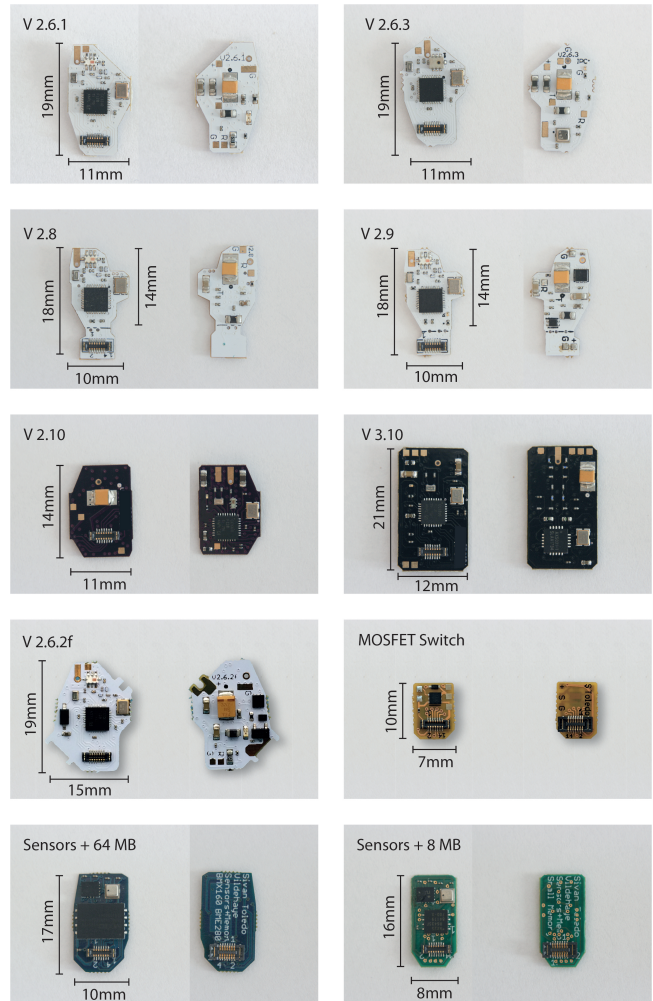

**Figure 6: Vildehaye CC13X0 tags and add-on boards.**

**Programming.** Tags are programmed and configured through a UART bootloader present in all CC13XX RF MCUs [57]. For programming, the tag is attached to an FTDI USB-to-UART bridge using a simple adapter board with a female 14-pin connector. The bridge also provide two GPIO pins that our Windows-side flashing software uses to reset the MCU and to activate the bootloader. The bridge is inexpensive (about 10 USD) and has excellent drivers, simplifying the task of programming blank MCUs for users; no specialized JTAG equipment is required. The 14-pin connector does not carry debugging (JTAG) signals. To debug the firmware, we use Texas Instruments evaluation boards called *LaunchPads*.

**Base Stations.** VH base stations usually use a LaunchPad evaluation board, sometimes attached to additional hardware modules. *Tethered* base stations that attached to a PC or a Raspberry Pi typically contain no hardware beyond the LaunchPad, which includes a UART-to-USB bridge. Standalone logging base stations also includes an SD card socket for the log, a u-blox GNSS module (mainly to set the time), an I2C OLED display, and optionally a temperature and air-pressure sensor. We have a custom board with all of these

components, designed to attach to a LaunchPad, but its base stations can also be assembled from a LaunchPad and hardware modules available from vendors such as Sparkfun and Adafruit or on Ebay. Standalone base stations that are used for remote command and control of tags require nothing beyond the LaunchPad, and can also use a tag PCBs.

**Shortcomings of the CC13XX RF MCUs.** The CC13XX RF MCUs serve us well and are extremely well supported by the manufacturer, but with a few additional or modified features they would have served us even better. The most important issue is voltage regulation. The chips regulate a 1.8–3.8 V supply down to 1.65 or 1.8 V using an efficient step-down switching regulator. However, the regulator cannot supply other devices, so using a NAND flash chip (all of which require regulated voltage) requires an additional regulator, adding complexity and weight. Also, the fact that the regulator cannot be configured as a step-up regulator prevents us from powering tags with a single 1.5 V cell. Finally, the chips do not tolerate supply voltages lower than 1.8 V, even though most of the internal blocks use much lower voltages. Extending the supply voltage down to 1.4 or 1.2 V or less, even with some functional blocks disabled (e.g. the radio transmitter), would have made VH tags more reliable (see next section).

The API that configures the radio on CC13XX is only partially documented; almost all configurations require passing to the radio processor code patches and/or arrays of parameters that only the vendor can produce and which are specific to some set of chips (e.g., CC13X0 but not CC13X2, etc). This leads to complicated and error-prone radio-configuration code.

The chips do not support binary phase-shift keying (BPSK), a form of modulation that is particularly useful for time-of-arrival measurements [31]. BPSK is easy to produce. We do not know why it is not supported; the most likely reason is a misguided belief that it is more difficult to demodulate than frequency-shift keying (FSK); while it is true that coherent BPSK demodulation might be too complex for simple RF MCUs, incoherent demodulation of BPSK is just as easy as demodulation of FSK [31].

## 4.2 Firmware

**Operating System.** VH firmware is written in C on top of Texas Instruments' TI-RTOS operating system. TI-RTOS is an embedded multitasking operating system designed for single-application devices. Multiple tasks or threads are preemptively scheduled according to fixed priorities. It does not offer memory protection or preemptive time-sharing. TI-RTOS has excellent power management capabilities for ultra low-power systems. It comes with a set of drivers for all the peripherals of the CC13XX family. TI-RTOS now supports the POSIX API for many subsystems, such as threads and synchronization, but when we started the project, it did not, so our firmware mostly uses TI-RTOS's idiosyncratic APIs. Also, the APIs for the drivers are all essentially idiosyncratic. Therefore, porting our code to another embedded operation system would be challenging.

**Concentration-Polarization Tolerant Scheduling.** VH tags use a highly specialized scheduler that ensures that the packets are transmitted at precise intervals and that can tolerate a temporary inability of a battery to deliver power.

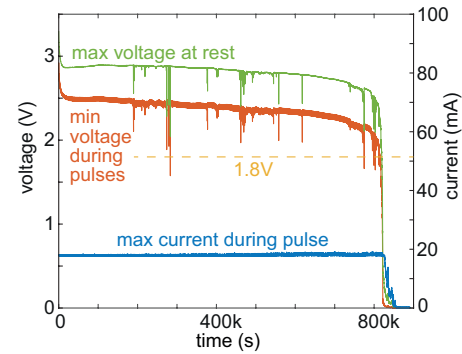

**Figure 7: Concentration Polarization in a Renata CR1025 battery connected to a pulsed load in parallel with a 330  $\mu$ F tantalum capacitor, from [40]. Ceramic capacitors make the phenomenon even worse due to lower ESR.**

Precise timing of packet transmission is important because it allows ATLAS base stations to predict when the next packet from each tag will be received. The prediction allows the base station to perform computationally-expensive signal-processing to detect the packet and estimate its arrival time on a slice of RF samples only slightly longer than the packet itself. The scheduler uses a timer that is part of the radio peripheral to time transmissions, leading to transmission times that are within 100  $\mu$ s or less of the predicted time. However, the firmware does not wait on this timer between activity slot, but rather uses the ultra-low power sensor controller to wake up the ARM processor in time for the next slot.

The use of the sensor controller allows VH tags to tolerate a phenomenon called *concentration polarization*, in which internal resistance increases temporarily because reactants become depleted near the battery's electrodes (see, e.g., [36, 39]). This is resolved through diffusion of the reactants, hence resolution can be slow. This phenomenon can be caused by exposing the battery to a load impedance load, even for short periods[46]. The reservoir capacitor has a low equivalent series resistance (ESR), so it indeed presents a very low-impedance load to the batteries. As the capacitor is discharged during an activity period, the voltage across the capacitor drops below the battery voltage, presenting a very low impedance load to the battery. The graphs in Figure 7, from [40], provide evidence for this phenomenon. The graphs were produced using a battery load simulator that connected a 20 mA constant current sink to a Renata CR1025 for 8 ms every second; this synthesis load is similar to the load presented by a VH tag. The data shows that the battery voltage sometimes drops significantly well below the battery is depleted, once below the minimum 1.8 V required for the CC13XX. Whether this happens varies from battery to battery, even from the same manufacturing batch [40].

VH tags mitigate the risk of failure due to concentration polarization in two ways. The first is a resistor present on most tag variants allowing the user to connect the battery through a current-limiting resistor; the battery never sees a low impedance load, reducing the risk of concentration polarization. See [40] on how to size the resistor. The other is specialized sensor-controller code that implements the inter activity-period wait. The code sleeps on a timer.

When it wakes up, it measures the supply voltage. If the voltage has not recovered sufficiently during the wait, the code assumes that the battery is temporarily unable to provide power, and it waits until the voltage recovers. Because this firmware mechanism is implemented using the ultra-low power sensor controller, it has a chance to survive the concentration polarization phase without causing the battery voltage to drop below 1.8 V. When the sensor controller finally wakes up the ARM processor after such a wait, it notifies the ARM processor that it is off schedule, causing it to restart its scheduler.

### 4.3 Representation, Collection, and Processing of Sensor Measurements

**Representation.** Tags pack sensor measurements are packed into *log items*, typed data structures up to 224 byte long. The length limit allows for efficient on-the-air transport using the CC13XX radio. The items are stored on nonvolatile memory and subsequently either uploaded to a base station or read from memory after the tag is retrieved. The log data structure is described in detail below.

Data from low-frequency sensors, like a barometric altimeter (one-shot measurement every second or more), are collected into a log item along with a 32-bit time stamp of the first measurement. To save space, the log item does not store the inter-measurement interval and does not store the configuration of the sensor (e.g., full scale), because these are identical in all log items for that sensor. These parameters are stored in a *sensor-configuration* item on the log every time the tag boots, and are also available for analysis software from the file that specifies the tag's definition.

Bursts of samples from high-frequency sensors, like accelerometers (a 5 s burst at 20 Hz every 2 minutes is typical) do not fit into a single log item. The samples from the burst are fragmented into multiple log items. Each item stores a whole-second time stamp of the beginning of the burst, a one-byte fragment index, and an array of measurements. Here too, the sampling rate is not represented in the log items that contain the data from the burst, to save space.

Not storing the sensor configuration in every log item saves on-tag storage and the energy required to upload the log via radio. Further saving might be achieved by (lossy or lossless) compression of sensor measurements; we have not explored this yet.

**Data Collection.** To process sensor data from a tag, the log is first transferred to a table in an SQL database. Each row in the table stores one item in binary form, as well as the identifier of the tag or base station that generated the item, the creation time of the log, and the on-flash address of the item in the log. Software specific to each sensor reads the corresponding log items from the table, extracts the measurements and associates each with a time stamp for further processing.

The log can be transferred to the SQL table in two ways, either by physically retrieving the tag or via radio upload. When a base station hears a tag configured to upload data, it invites the tag to upload data. The base station acknowledges received data items; the tag maintains a pointer to the last acknowledged log items, to avoid retransmitting it. The pointer is stored in RAM but is committed to the log in each sector header. Therefore, a reboot might cause retransmission of log items, but at most one sector is retransmitted after each reboot. When a tag leaves the range of a base station,

it ceases to upload data. It may next upload data to another base station into whose range it enters. Base stations store received log items to an SD card (or to a file, if the base station is tethered). The cards (or files) are collected at some point and their contents is uploaded to the SQL table.

Base stations are fragile and are often placed outdoor, so data that they collect from tags can sometimes be lost (due to a damaged or stolen base station, etc). Therefore, the reconstruction of the log in the SQL table may be incomplete. Software that extracts sensor data from the table must be and is able to cope with missing items.

### 4.4 A Nonvolatile Log Data Structure

Tags store sensor data on non-volatile memory using a log data structure. The log represents a sequence of typed data items up to 224 bytes long that we refer to as *log items*. The log is stored either on an external SPI flash chip (currently only NOR flash is supported) or on the part of the CC13XX flash that is not used for firmware. The same data structure, stored on raw SD cards (without an underlying file system) stores packets received from tags in base stations. The log is currently a write-once data structure that fills an erased flash chip or SD card; this saves energy when the tag boots. Reusing flash sectors whose contents have been uploaded to a base station would consume more energy when a tag boots (see below) but may be implemented in the future.

**Design Goals.** The design of the log is optimized for energy efficiency, storage efficiency, low RAM usage (CC13X0 has only 20 kB), and clear semantics, including data integrity. Of these goals, energy efficiency is the most important; it drives most of the design.

Note that complete or even high reliability is not one of our design goals. As explained in Section 4.3, loss or base stations or their SD cards may lead to incomplete reconstruction of the log. Software that uses logged data must be able to cope with missing data. Therefore, the system can tolerate other causes of loss of data, as long as they are infrequent. This simplifies the logging and radio protocols considerably. For example, when a base station receives a log item from a tag, it normally acknowledges it immediately, even though writing it to permanent media may fail. However, we obviously aim to minimize data loss, so a base station with a full SD card does not acknowledge receipt of log items, and so on.

**Naming and Type Labeling.** Log items, most of which store sensor data, are globally uniquely identifiable; each is associated with an abstract 192-bit identifier consisting of the tag identifier, the UTC time that the physical medium of the log was formatted, and the address of the item on that medium. The tag identifier and the log creation time are stored on flash (once for the entire log). The per-item storage overhead of this unique identifier is close to nothing. When a log item is uploaded to a base station, the packet containing it specifies the tag identifier, log creation time, and item address explicitly. These are also stored in the base stations SD card or file, and in the SQL table in which data is collected.

The type of a log item is represented by one byte. We currently use a single registry of log-item types, but the log header contains a registry identifier. Therefore, even though a single log can contain only up to 255 different item types, different logs can contain different sets of types. Most types represent sensor data, but some are part of the log data structure (e.g., sector headers).

**Data Integrity.** Data integrity is achieved by identifying items that might have been only partially written to flash due to a power outage. Whenever the tag boots, it logs a *boot marker*. We ensure that an item has been fully written by verifying that another item was written later but and before the system lost power or crashed. Therefore, a data item that is either the last (highest address) on flash or that is followed by a boot marker is suspect as being partially written and is not used; other data items have been written completely and are used by clients. (Enforcing this rule is more complicated than it seems, since the boot marker may be lost in transport, but we can identify potential loss of boot markers.)

**On-Flash Representation of the Log.** Flash devices are partitioned into *sectors*, which are the smallest erasable blocks, which are further partitioned into *pages*. VH logs are currently not erased, but we still partition the log into logical sectors (whose size may differ from that of physical sectors). Pages are 256-byte long on NOR flash and 512-byte long on SD cards. The implementation never uses byte-write operations, only more energy efficient page-writes. Each log item is stored with a two-byte header specifying its length and type. Items are packed without gaps, except when the next item does not fit within the space left in a sector, as shown in Figure 8.

Because sectors are not erased and rewritten, sectors are filled monotonically from low to high addresses. This allow code to find the first erased sector using a binary search, saving energy relative to a linear search of a large flash chip. The code then scans linearly within the previous sector to find the first free flash address.

Write amplification, which costs both storage and energy, is minimal. Total write amplification consists of the two-byte header (3.2% for items 64-byte or longer), sector headers (9 bytes, 0.2% overhead for 4 kB sectors), and erased gaps at the end of a sector (at most 225 bytes, 5.5%). The overhead of the log header and boot marker are negligible.

Tags upload items to base stations in address order and keep track of the highest acknowledged address. The tag retransmits the next item until it is acknowledged. To minimize writes, the tag does not record each acknowledgment to flash, only when logging operations start a new sector (when the previous has been filled).

## 4.5 Radio Protocol

**Radio Setups.** VH tags communicate with base stations using a simple protocol that uses variable-length radio packets. The length is encoded in one byte, so the payload is up to 255 bytes long. The protocol supports a wide range of radio setups, but we normally use just two: a short-range setup, with symbol rate and data rates of 500 kb/s and with an error detection code (CRC) but no error correction, and a long-range setup with the same symbol rate but with spreading and error-correction codes that reduce the data rate to 31.5 kb/s. The former is effective in ranges of meters to tens of meters, allowing energy-efficient data upload to a nearby base station. The latter was shown to be effective at distances of up to of several kilometers [53] but is only intended for short messages, mostly to identify the tag and announce its presence in the area.

**Data Representation.** The payload consists of a sequence of typed data items, allowing a message to carry multiple data items. Each data item starts with a variable-length header that specifies its 16-bit type and length. The header is highly compressed; if the item is

short and the type index low, the header fits in one byte. Longer data items and high type indexes require longer headers. Common data types are given low indexes and are kept short, so their header fits in one byte.

Packets from tags always carry at least two data items, a *tag state* data structure and the unique 64-bit tag identifier. The tag-state structure specifies whether the tag will listen to a reply after this packet is transmitted, whether it has a significant amount of data to upload to a base station (the current threshold is 4 KB), and in what configuration it is. Tags that log sensor data also send every minute a data item that describes the state of the log, to allow monitoring the progress of uploads to a base station. Logging tags also send periodically the time shown by their real-time clock; base stations reply with the correct time if the advertised time is incorrect (this is how the clock is set after a tag is powered). Tags in configurations intended to upload data to a base station, like configuration 1 in Figure 1, include at most one log item in each packet.

**Replies.** Base stations sometimes reply to packets from tags. Replies always specify the identifier of the tag the reply is sent to. Replies are produced by objects called *intents*; as their name suggests, they encapsulate an intent of the user with respect to a particular tag or to all tags. Every base station that has a valid real-time clock (either from a GNSS receiver or from NTP) acts on an intent to adjust the clocks of tags: upon reception of a packet advertising a local clock that is more than 2 s off from a tag that will listen next, the base station replies with the correct time. Similarly, a logging base station that receives a log item acknowledges it; the tag will move to transmit the next log item. A base station with a user-specified intent to switch a particular tag to a particular radio configuration replies to its packet with an appropriate *wakeup command* data item if the tag's state is not in the intended configuration.

**Uploading Data.** Logging base stations that hear a packet indicating that the tag has data to upload but not carrying a log item replies with a wakeup command telling the tag to go to its highest-indexed configuration (without specifying this index, which the base station does not know). This configuration should be the one in which data upload occurs (like configuration 1 in Figure 1). This starts a data-upload phase in which the tag sends a log item almost every period. The base station replies with an acknowledgment that cause the tag to advance to the next data item. Unacknowledged items are retransmitted.

**Discussion.** Many features of the protocol are designed to save energy and to limit the duration of transmit-receive slots, to allow the radio to be powered by a reservoir capacitor. These include the highly compressed headers and the variable-encoding of some types of data and the transmission of log items only if a base station that might acknowledge them was recently heard. Other features are designed for flexibility. These intents, which make it relatively easy to add protocol features (e.g., channel or frequency-band switching), and the structuring of all messages as lists of typed data items. These goals are sometimes conflicting. For example, a single fixed message structure would make the protocol more energy efficient, because no explicit data types would need to be transmitted, but also much less flexible. We treated flexibility as a constraint and optimized energy use subject to it.

**A Discarded Design.** In our initial design replies did not immediately follow packets from tags but rather occupied the next activity



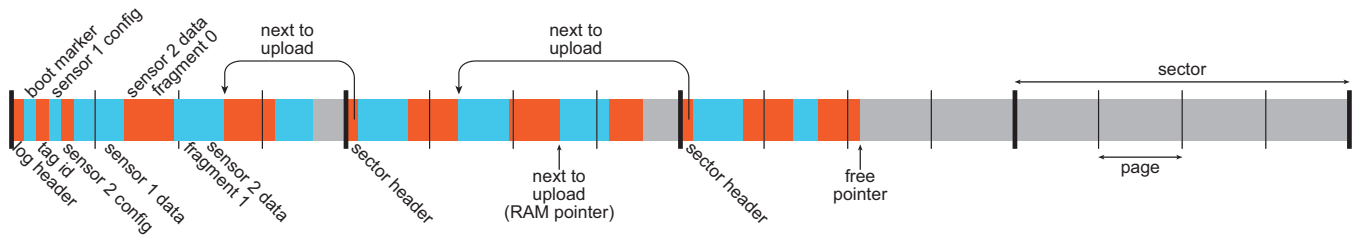

**Figure 8: The log data structure, with 4-page sectors (in practice sectors are larger). The log stores typed *log items*, shown here as alternating blue and red spans for clarity. Bytes in the erased state (all ones) are shown in gray. The log starts with a log-header item. Each sector but the first starts with a sector-header item. At every boot, the MCU writes a boot marker and its identifier into the log, as well as items describing the configuration of sensors. Items are packed contiguously. When the next item to log does not fit in the space remaining in a sector, writing skips to the next sector. The address of the first item that has not yet been uploaded to a base station and acknowledged is maintained in RAM and recorded in sector headers.**

slot of the tag. The idea was that this would shorten the time a tag is active in every slot. But this proved difficult to implement. One difficulty was to time replies precisely, so the base station would transmit exactly when the tag is receiving. Although the API of the CC13XX radio driver timestamps received packets and allows scheduling transmit and receive operations at specific times in the future, the precise temporal semantics of the API are not well documented, making implementation of time-slotted protocols. Also, we did not have a good tracing environment for such protocols; the environment must be able to show the precise timing of packets using a separate receiver. Clearly, it is possible to design and implement time-slotted protocols in sensor networks (see, e.g., [58]), but it requires much more engineering and debugging efforts than immediate request-reply protocols. The slotted design also requires a complex radio scheduler for base stations. In our initial implementation a base station that received a packet and needs to reply in exactly 1 s waits idle during this second. This is inefficient. Scheduling the reply but performing other radio operations until it is sent is more efficient but difficult to implement. Therefore, we switched to the simple and robust protocol described above, in which replies are almost immediate.

## 5 FEATURES THAT WERE CONSIDERED BUT NOT IMPLEMENTED

Over the course of the project we examined but rejected a number of features that are in general compatible with the project’s scope. This section describes some of these features and the reasons that we did not implement them.

**Wakeup Receivers.** In the summer of 2018 we evaluated an alternative family of RF MCUs, the Flex Gecko family from Silicon Labs. These MCUs share many characteristics of the CC13X0 from Texas Instruments: they contain an ARM CPU, they can transmit and receive on the frequency bands that VH tags use, they come in similarly-sized packages, and they are power efficient. However, they were advertised as having two additional important features: the ability to transmit phase-modulated packets and a wakeup receiver. A wakeup receiver is an ultra-low power circuit that can wake up an MCU when strong RF signal is detected (some wakeup receivers can detect a particular pattern, to avoid spurious wakeups, but the wakeup receiver the Flex Geckos acts as a tuned power

detector). A wakeup receiver allows low duty-cycle tags to sense the nearby presence of each other without prior time synchronization [16].

The evaluation included a test to ensure that the Flex Gecko can transmit ATLAS pings and a test to evaluate the wakeup receiver. The wakeup receiver on one evaluation board was able to reliably detect a packet from another board at up to about 2 m.

However, we did not go on to design VH tags with Flex Geckos due to several reasons. One was the fact that blank Flex Gecko’s do not come with a serial bootloader; Silicon Labs offers one, but it must be programmed onto blank chips using JTAG. This would have complicated the production process for tags. Another important issue was the design cost involved: using Flex Geckos would require porting the firmware to a new embedded operating system and designing new tags. Another damper was the discovery that phase modulation was announced but not actually supported; we could not even get a target date or any technical details (data rates in particular are critical for ATLAS localization).

**Battery Tabs, Clips, and Retainers.** VH tags are typically powered by a single Lithium cell or by a pair of Silver Oxide cells. Some Lithium cells come with soldering tabs designed for soldering the battery to a PCB. One of the tag designs, Version 2.6.2f, is designed specifically for tabbed CR2032 cells.

However, most Lithium and all Silver Oxide cells lack tabs. Users connect tabless cells to tags either by soldering thin enamel-coated wires directly to the cell using a specialized soldering technique (to avoid heating up the cell, which degrades it), or by spot welding nickel tabs. These techniques require some expertise and they take time.

We evaluated the use of battery clips and retainers, flexible metal structures that are soldered to a PCB and allow insertion of batteries of a particular size. We decided not to use clips and retainers, mostly due to the large variety of batteries that users wanted to use, to optimize tags for specific animals. To integrate the battery retainer with the tag, we would have had to design and manufacture a large variety of tags, one for each battery size. The extra weight of the retainer and the extra PCB surface area and weight required also contributed to the decision not to use clips or retainers. Also, some materials used to weatherproof tags can electrically disconnect the battery from the clip.

**Table 2: Weights and lifespans of VH tags with various batteries and coatings. For battery specifications, see [18–22, 44, 49].**

PCB	battery	energy capacity	coating	total mass	max lifespan
2.8	SO337 (2)	8.3 mAh → 2.4 V	varnish	0.8 g	10.4 d @ 1/8 Hz
	SO317 (2)	11.5 mAh → 2.4 V	varnish	0.9 g	13.1 d @ 1/8 Hz
	CR1025	30 mAh → 2 V	varnish	1.2 g	32 d @ 1/8 Hz
	CR1025	30 mAh → 2 V	epoxy	1.4 g	32 d @ 1/8 Hz
2.6	CR1620	81 mAh → 2 V	epoxy	2.4 g	79 d @ 1/8 Hz
	CR2032	235 mAh → 2 V	epoxy	4.2 g	226 d @ 1/6 Hz
	CR2477	1000 mAh → 2 V	epoxy, heat shrink	10.5 g	431 d @ 1/8 Hz
	TL4920	8500 mAh → 2 V	epoxy & collar	90.0 g	

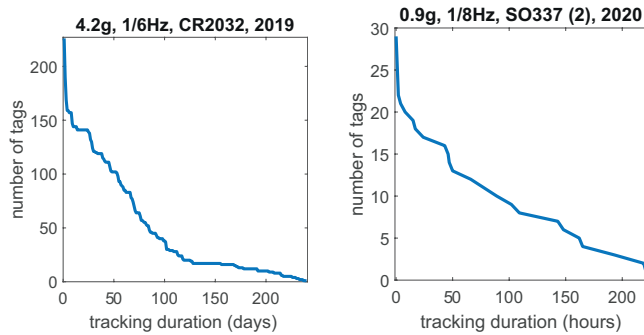
**Figure 9: Tag life spans in the field. The graph on the left plots results from 226 tags deployed on Red Knots in the Netherlands and the graph on the right plots results from 29 tags deployed on Barn Swallows and Common House Martins in Germany.**

The modular structure of VH tags enables add-on boards with a battery retainer, but so far there was not demand for them.

**Attaching Batteries using Conductive Glue.** In some wildlife tags batteries are attached using conductive glue [14]. We experimented with this technique but failed to get it to work well. Two particular difficulties that we encountered were smears that caused shorts (a stencil appears to be required) and attachment of the non-PCB side of the battery, which requires designing a custom metal clip. These are not insurmountable problems but soldering or spot welding proved to be good-enough alternatives.

## 6 USE CASES

### 6.1 ATLAS Pingers (Tracking Tags)

Most of the VH tags that have been deployed in the field have been configured as ATLAS pingers. Each such tag periodically emits a unique pseudo-random packet. The packets are transmitted at a high data rate (usually 8192 bits at 1 Mb/s), to enable accurate localization [4, 31, 56]. Table 2 shows the configuration of typical ATLAS pingers and the maximum lifespan in the field recorded for each configuration. Figure 9 shows the distribution of life spans among sets of identical tags deployed together. Very early failures are usually due to defects in tag preparation (e.g. water ingress). The rest of the distribution is produced mostly by early battery failures and by animals leaving the coverage area of the ATLAS system (i.e., the tag keeps pinging but is not received). It is difficult

to ascertain the cause of the loss of signal from all tags; some user groups collected such data, but it is incomplete.

Most of these tags have been deployed in ATLAS tracking systems. Figure 10 shows a few tagged animals that were tracked by ATLAS. Most of the deployed tags were versions 2.6.1, 2.6.2f, 2.6.3., 2.8, and 2.9.

### 6.2 Tracking and Sensing Tags: Recapture and Remote Downloads

Two groups of birds were tracked using VH tags that both transmitted ATLAS pings and logged the air-pressure onto on-board flash memory. In one study, 27 homing pigeons were tagged with VH tags version 2.6.1 with an add-on board with sensors and a 64 MB flash memory. The birds were released in remote locations (under multiple experimental conditions that are irrelevant in this paper) and they flew back home. Upon their return the tags were removed and the logged data retrieved. Figure 10 shows one of the pigeons just prior to release. Figure 11 plots the first part of the track of one of the pigeons in three dimensions. The air pressure measurements were converted to altitude using the barometric formula, with reference pressure taken from data published by a governmental meteorological service.

Five house martins (*Delichon urbicum*) were tracked in a separate study with VH tags version 2.6.3, which have an on-board air-pressure sensor. The birds nested under the roof of a stable. Two standalone basestations were placed about 3 m from the nests. Air-pressure data was remotely uploaded to the base stations and then transferred to an SQL database for further processing.

We verified the calibration and accuracy of the air-pressure sensor and the correctness of the estimation of altitude from air pressure using a drone; we omit the details.

### 6.3 Remote Activation of a Release Mechanism

We used the VH system to design and implement a release-and-retrieval mechanism for wildlife data loggers. Figure 10 show the mechanism, which we call a *Krukhy*. The data logger (an audio recorder) and a VH tag are installed in an enclosure with a motorized flap. The enclosures were placed on the legs a cranes in Finland and Estonia in the summer with the flap closed, so the enclosure remains attached to the leg. The cranes were also tracked using GNSS. When the GNSS tracking indicates that a migrating tagged crane reached a stopover area in their fall migration, a VH base



Figure 10: A tagged pigeon, terrapin, and crane. The antenna in the pigeon’s tag is a monopole; in the terrapin’s tag, a more effective dipole. The crane carries a data-logging tag with a remote release mechanism (photo taken by Petri Suorsa), shown in the released state in the rightmost picture. The VH tag and the data logger are inside the 3D-printed enclosure. The tag on the other leg of the crane is a separate GNSS tracker.

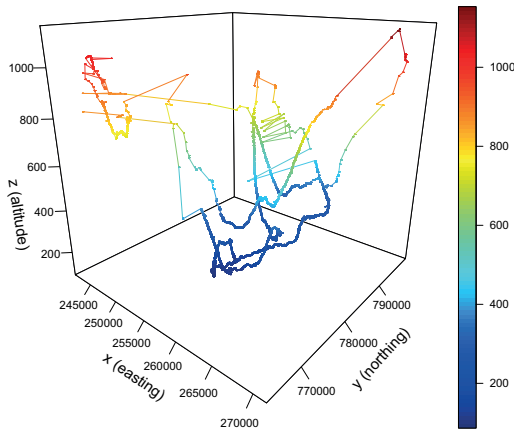

Figure 11: The 3D track of a pigeon tracked using a VH tag. Axes labels are in meters. The  $x$ - $y$  position was estimated by ATLAS from radio pings and the  $z$  coordinate from an air-pressure sensor whose data was logged on the tag). The  $x$ - $y$  positions were not filtered or smooth so the plot shows a few outliers.

station on a drone is flown close to the cranes. It receives long-range transmissions from the VH tag; it responds with a wakeup command. Receipt of the wakeup command by the tag turns on the flap motor and also transitions the tag to a configuration in which it transmits periodic ATLAS pings. The ATLAS pings are used to home in and locate the released mechanism using manual RSSI-based direction-of-arrival estimation.

We have tested the mechanism extensively and determined that a base station on a drone can activate it from at least 30m (the limiting factor is the small antenna inside the release-mechanism enclosure). The actual release in the field is expected to happen later this fall.

#### 6.4 Remote Download Add-On to Vesper Tags

We developed a variant of the firmware that assumes that the log is stored on a separate device accessible as an I2C slave. The VH tag buffers one log item and tries to upload it to a base station. When

it succeeds, it acknowledges the log item to the logger and asks for another log item. If there is none, it repeats the request periodically until the logger produces a log item. The slightly strange setup in which the logger is an I2C slave rather than a master is due to the fact that the I2C peripheral on CC13XX devices does not support a low-power (unlocked) I2C slave or multiple-master mode.

This mechanism allows the VH tag to act as a remote-upload radio for existing data loggers. We have integrated this functionality with a family of wildlife tracking and sensing loggers called *Vesper* tags [17, 48]. This functionality has been tested and is working, but it was not yet deployed in the field.

## 7 RELATED WORK

Early wildlife radio tracking tags emitted periodic pings that carried no information [10, 41]. Later, simple circuits that produce a unique on-off pattern were added to allow identification of individual tags. Tags of this type still attain the lowest mass; a typical example is the commercial family of NanoTags from Lotek [32, 33], which start at 0.15 g with either a single Silver Oxide battery or a solar panel. Such tags are used to either sense the nearby presence of a tag or to localize it from signal-strength (RSSI) based direction-of-arrival estimates.

The next phase in the evolution of radio tracking tags used microcontrollers to modulate a simple transmitter, either to transmit sensor data or to identify tags. Lotimer describes an early tag with identifiable pings [34]; the tag modulated the ping repetition interval and the number, width, and frequency of pulses within each ping. The tags developed by MacCurdy et al. [37] are a more modern, MCU-driven version of this architecture. They were developed for an automated time-of-arrival localization emit a unique phase-modulated code. The tags designed by Krieger [27] for a similar system also use the same architecture, but with OOK modulation.

Integrated transceiver integrated circuits (ICs) enable the design of yet more sophisticated tags, capable of both transmitting and receiving. The tags designed for the Encounternet system [47] are typical; they included an MSP430 microcontroller and a CC1101 integrated transceiver. Communication between tags allowed the system to record short-range encounters between individuals.

Higher levels of IC integration led to RF MCUs, which allowed for even smaller tags, including our VH tags. LifeTags and PowerTags [7,

8, 45] form a family of periodic 434 MHz pingers that emit a static FSK packet with the tag ID, designed for presence logging and RSSI-based direction-of-arrival localization. The tags are single-function and not configurable. The hardware design appears similar to that of VH tags, but with an older RF MCU (Silicon Labs Si1060, which has a 8051-compatible CPU) and a BQ25504 energy harvesting boost converter. One variant (LifeTags) can operate battery-less using a solar panel and a reservoir capacitor. The system also include both embedded receivers and hand-held receivers, like the VH system. The smallest solar LifeTag weighs only 0.45 g, less than VH tags. The functionality is much more restricted than that of VH tags. The tags are available read-to-use from a commercial vendor, which is an advantage, but are expensive, costing 180 USD each at large quantities.

LifeTags, PowerTags, and NanoTags can be detected and identified by receivers of the Motus system [50]. Motus receivers are owned and maintained by several research and conservation groups. Detection reports from all receivers are uploaded to a central database; the reports can be used to reconstruct an approximate track, sometimes on continental or intercontinental scales, mostly based on presence sensing.

Wildlife tracking using time-of-arrival estimation was tested since the early 1970s, but early tags were heavy (11.3 kg) [12, 13] and the technique was largely abandoned until the work of MacCurdy et al. [37].

The BATS project share many similarities with Vildehaye, along with many contrasting points. [16] BATS is a large-scale long-term project intended to develop tracking and sensing tags for bats. VH tags have also been extensively used on bats, but also on many other animals. BATS tags can be localized using an array of terrestrial receivers; receivers estimate direction of arrival from RSSI ratios in two antennas, whereas VH tags are localized by receivers that estimate time of arrival. BATS tags contain a wakeup receiver, allowing them to log close encounters between bats.

## 8 CONCLUSIONS AND LESSONS LEARNED

Multiple hardware variants and the modular design are a key success factor because they allow users to select a tag or a modular configuration that best suits a particular animal and the requirements and constraints of a particular study. Modular tags with add-on boards have advantages and disadvantages relative to specialized integrated single-board variants. Specialized variants require additional design time and they cost more if they are manufactured in small production runs or if multiple runs are required to fix faults in a new design (this has happened to us). On the other hand, integrated variants are physically smaller and lighter, making them applicable to more species and reducing adverse effects on tagged animals. For example, version 2.6.2f is specialized to a particular battery, but a large number has been manufactured, so the extra costs are minor. Version 2.6.3 is another interesting example: it is a specialized integrated variant (with an on-board altimeter), designed to allow tagging small birds that cannot carry modular tags.

The decision to manufacture multiple small and medium-size batches of tags proved effective; we have gone through more than 40 production runs. This eliminates the need for capital for large

runs, enables using multiple variants, and avoids the risk of a large run of a faulty design. On the other hand, the multiple small runs expose users and maintainers to challenges involving part shortages, which we have faced several times. The reservoir capacitor and 0402 1  $\mu$ F capacitors are manufactured by only few vendors and were sometimes impossible to source. An RF IPC that is specific to the CC13X0 was impossible to source for a while. These problems were exacerbated by pandemic-induced shortages (e.g., we can no longer source BME280 sensors and had to switch to BME380, requiring both a board change and a firmware change), but they also occurred before the pandemic.

The SlimStack board-to-board connector, adopted from the design of Vesper tags [48], are effective. The connector is used both for programming and for communication with add-on boards. It is tiny, reliable, and easy to use, even in the field. They proved easier to use than Tag-Connect cables with spring-loaded contacts that we used to program earlier tags [52]. We were originally concerned with durability of the connector in the programming adapter and considered the adapter to be a disposable component, since the connectors are only rated for 30 mating cycles. However, in practice we did not experience connector failures. The 1 mm board-to-board gap requires careful component placement on the PCBs, because in general only one of the two boards facing a gap can carry components (otherwise the combined height of components exceeds 1 mm). We place components on the male-connector side of the board, except on tags Version 2.10 designed to mate with Vesper tags, which have a female connector and components on the same side.

The use of two separate serialization formats that Vildehaye uses, one optimized for data items in radio packets and the other for log items, is a poor design decision. However, the code is already working and unifying the two formats will require work without bringing much benefits.

Planning and executing studies of free-ranging wild animals presents multiple technical challenges. Every action that we have taken to simplify the use of VH tags and their associated software contributed to their adoption and use. These include the (seemingly insignificant) decision to use an FTDI USB-to-serial bridge to program and configure tags, the creation and maintenance of the tag lifespan calculator, and creation of easy ways to test tags after production and before deployment.

*Acknowledgments.* This research was supported in part by the Minerva Foundation, the Minerva Center for Movement Ecology, grants ISF-965/15 and 1919/19 from the Israel Science Foundation, a grant from the Gesellschaft für Ökologie, DFG funded research training group *BioMove* (RTG 2118-1), DFG project UL 546/1-1, and Dutch Research Council grant VI.Veni.192.051. Thanks to the reviewers and shepherd for comments and suggestions.

## REFERENCES

- [1] 3M. *Electrical Insulating Sealers, 1601-C, 1601-R*, September 2016. Datasheet for a clear or red insulating varnish in a spray can.
- [2] 3M. *Scotch-Weld Epoxy Potting Compound/Adhesive, DP270*, March 2019. Datasheet for a clear or black epoxy.
- [3] Christine Beardsworth, Mark Whiteside, Philippa Laker, Ran Nathan, Yotam Orchan, Sivan Toledo, Jayden van Horik, and Joah Madden. Is habitat selection in the wild shaped by individual-level cognitive biases in orientation strategy? *Ecology Letters*, 24(4):751–760, 2021. doi:10.1111/ele.13694.



- [4] Christine E. Beardsworth, Evy Gobbens, Frank van Maarseveen, Bas Denissen, Anne Dekinga, Ran Nathan, Sivan Toledo, and Allert I. Bijleveld. Validating a high-throughput tracking system: ATLAS as a regional-scale alternative to GPS, 2021. BioRxiv preprint, submitted for publication. doi: 10.1101/2021.02.09.430514.
- [5] Christine E. Beardsworth, Mark A. Whiteside, Lucy A. Capstick, Philippa R. Laker, Ellis J. G. Langley, Ran Nathan, Yotam Orchan, Sivan Toledo, Jayden O. van Horik, and Joah R. Madden. Spatial cognitive ability is associated with transitory movement speed but not straightness during the early stages of exploration. *Royal Society Open Science*, 8(3), 2021. doi: 10.1098/rsos.201758.
- [6] Thomas W. Bodey, Ian R. Cleasby, Fraser Bell, Nicole Parr, Anthony Schultz, Stephen C. Votier, and Stuart Bearhop. A phylogenetically controlled meta-analysis of biologging device effects on birds: Deleterious effects and a call for more standardized reporting of study data. *Methods in Ecology and Evolution*, 9(4):946–955, 2017. doi: 10.1111/2041-210X.12934.
- [7] Cellular Tracking Technologies. LifeTag. Retrieved February 9, 2022. URL: <https://celltracktech.com/products/tag-system/lifetag/>.
- [8] Cellular Tracking Technologies. PowerTag. Retrieved February 9, 2022. URL: <https://celltracktech.com/products/tag-system/powertag/>.
- [9] CircuitHub. Rapid electronics manufacturing. Retrieved February 9, 2022. URL: <https://www.circuituhub.com>.
- [10] William W. Cochran and Rexford T. Lord, Jr. A radio-tracking system for wild animals. *The Journal of Wildlife Management*, 27(1):9–24, 1963.
- [11] Ammon Corl, Motti Charter, Gabe Rozman, Sivan Toledo, Sondra Turjeman, Pauline L. Kamath, Wayne M. Getz, Ran Nathan, and Rauri C. K. Bowie. Movement ecology and sex are linked to barn owl microbial community composition. *Molecular Ecology*, 20(7):1358–1371, 2020. doi: 10.1111/mec.15398.
- [12] Frank C. Craighead, Jr., John J. Craighead, Charles E. Cote, and Helmut K. Buechner. Satellite and ground radio tracking of elk. In S. R. Galler, K. Schmidt-Koenig, G. J. Jacobs, and R. E. Belleville, editors, *Animal Orientation and Navigation*, number 262 in NASA Special Publication, pages 99–111, 1972.
- [13] John J. Craighead, Frank C. Craighead, Jr., Joel R. Varney, and Charles E. Cote. Satellite monitoring of black bear. *BioScience*, 21(24):1206–1212, 1971. doi: 10.2307/1296018.
- [14] Z. D. Deng, T. J. Carlson, H. Li, J. Xiao, M. J. Myjak, J. Lu, J. J. Martinez, C. M. Woodley, M. A. Weiland, and M. B. Eppard. An injectable acoustic transmitter for juvenile salmon. *Scientific Reports*, 5(8111), 2015. doi: 10.1038/srep08111.
- [15] Falko Dressler, Simon Ripperger, Martin Hierold, Thorsten Nowak, Christopher Eibel, Bjorn Cassens, Frieder Mayer, Klaus Meyer-Wegener, and Alexander Kolpin. From radio telemetry to ultra-low-power sensor networks: tracking bats in the wild. *IEEE Communications Magazine*, 54(1):129–135, 2016. doi: 10.1109/MCOM.2016.7378438.
- [16] Niklas Duda, Thorsten Nowak, Markus Hartmann, Michael Schadhauer, Björn Cassens, Peter Wägemann, Muhammad Nabeel, Simon Ripperger, Sebastian Herbst, Klaus Meyer-Wegener, Frieder Mayer, Falko Dressler, Wolfgang Schröder-Preikschat, Rüdiger Kapitza, Jörg Robert, Jörn Thielecke, Robert Weigel, and Alexander Kolpin. BATS: Adaptive ultra low power sensor network for animal tracking. *Sensors*, 18(10), 2018. doi: 10.3390/s18103343.
- [17] Katya Egert-Berg, Edward R. Hurme, Stefan Greif, Aya Goldstein, Lee Harten, Luis Gerardo Herrera M., José Juan Flores-Martínez, Andrea T. Valdés, Dave S. Johnston, Ofri Eitan, Ivo Borissov, Jeremy Ryan Shipley, Rodrigo A. Medellín, Gerald S. Wilkinson, Holger R. Goerlitz, and Yossi Yovel. Resource ephemerality drives social foraging in bats. *Current Biology*, 28(22):3667–3673, 2018. doi: 10.1016/j.cub.2018.09.064.
- [18] Energizer. *Lithium Manganese Dioxide Coin Cell, CR1025*. Datasheet, Form No. 1025NA0618; not dated.
- [19] Energizer. *Lithium Manganese Dioxide Coin Cell, CR1620*. Datasheet, Form No. 1620GL0618; not dated.
- [20] Energizer. *Lithium Manganese Dioxide Coin Cell, CR2032*. Datasheet, Form No. CR2032EU0118; not dated.
- [21] Energizer. *Silver Oxide Coin Cell, 317*. Datasheet, Form No. 317GL0719; not dated.
- [22] Energizer. *Silver Oxide Coin Cell, 337*. Datasheet, Form No. 337GL0719; not dated.
- [23] Pratik Rajan Gupte, Christine E. Beardsworth, Orr Spiegel, Emmanuel Lourie, Sivan Toledo, Ran Nathan, and Allert I. Bijleveld. A guide to pre-processing high-throughput animal tracking data. *Journal of Animal Ecology*, 91(2):287–307, 2021. doi: 10.1111/1365-2656.13610.
- [24] Robert J. P. Heathcote, Mark A. Whiteside, Christine Beardsworth, Philippa R. Laker, Jayden Van Horik, Sivan Toledo, Yotam Orchan, Ran Nathan, and Joah R. Madden. Spatial memory and landscape familiarity drive home range formation and predict predation risk, March 2021. Submitted for publication.
- [25] Mark D. Holton, Rory P. Wilson, Jonas Teilmann, and Ursula Siebert. Animal tag technology keeps coming of age: an engineering perspective. *Philosophical Transactions of the Royal Society B*, 376(20200229), 2021. doi: 10.1098/rstb.2020.0229.
- [26] Roland Kays, Margaret C. Crofoot, Walter Jetz, and Martin Wikelski. Terrestrial animal tracking as an eye on life and planet. *Science*, 348(6240), 2015. doi: 10.1126/science.aaa2478.
- [27] S. W. Krüger. An inexpensive hyperbolic positioning system for tracking wildlife using off-the-shelf hardware. Master's thesis, North-West University, South Africa, May 2017.
- [28] Kukdo Chemical. *Curing Agent for use with Epoxy Resins, KH-816*, December 2004. Datasheet.
- [29] Kukdo Chemical. *Low Viscosity Epoxy Resin, YD-114EF*, December 2004. Datasheet.
- [30] Kyocera AVX. *Polymer, Tantalum and Niobium Oxide Capacitors*. Product catalog and datasheets; 285 pages; not dated.
- [31] Andrey Leshchenko and Sivan Toledo. Modulation and signal-processing trade-offs for reverse-GPS wildlife localization systems. In *Proceedings of the European Navigation Conference (ENC)*, pages 154–165, June 2018. doi: 10.1109/EURONAV.2018.8433240.
- [32] Lotek. NanoTags (coded vhf) for birds and bats. Retrieved February 9, 2022. URL: <https://www.lotek.com/products/nanotags/>.
- [33] Lotek. NanoTags Solar (coded vhf). Retrieved February 9, 2022. URL: <https://www.lotek.com/products/solar-nanotags-coded-vhf-for-birds/>.
- [34] J. S. Lotimer. A versatile coded wildlife transmitter. In Charles J. Amlaner, Jr. and David W. Macdonald, editors, *A Handbook on Biotelemetry and Radio Tracking*, pages 185–191. Pergamon Press, 1980.
- [35] Emmanuel Lourie, Ingo Schiffner, Sivan Toledo, and Ran Nathan. Memory and conformity, but not competition, explain spatial partitioning between two neighboring fruit bat colonies. *Frontiers in Ecology and Evolution*, 9(732514):1–15, 2021. doi: 10.3389/fevo.2021.732514.
- [36] Mark W. Lund. Battery impedance and resistance, November 2019. URL: <https://www.powerstream.com/internal-resistance.htm>.
- [37] R. MacCurdy, R. Gabrielson, E. Spaulding, A. Purgue, K. Cortopassi, and K. Frstrup. Automatic animal tracking using matched filters and time difference of arrival. *Journal of Communications*, 4(7):487–495, 2009.
- [38] Andrew Markham, Niki Trigoni, Stephen A. Ellwood, and David W. Macdonald. Revealing the hidden lives of underground animals using magneto-inductive tracking. In *Proceedings of the 8th ACM Conference on Embedded Networked Sensor Systems (SenSys)*, pages 281–294, 2010. doi: 10.1145/1869983.1870011.
- [39] Thomas L. Martin. *Balancing Batteries, Power, and Performance: System Issues in CPU Speed-Setting for Mobile Computing*. PhD thesis, Carnegie Mellon University, 1999.
- [40] Shai Mendel. A system to characterize battery behavior in miniature wildlife tags reveals correctable reliability weaknesses. Master's thesis, Tel Aviv University, 2019.
- [41] B. Naef-Daenzer, D. Früh, M. Stalder, P. Wetli, and E. Weise. Miniaturization (0.2g) and evaluation of attachment techniques of telemetry transmitters. *The Journal of Experimental Biology*, 208:4063–4068, 2005. doi: 10.1242/jeb.01870.
- [42] R. Nathan, C. T. Monk, R. Arlinghaus, T. Adam, J. Alós, M. Assaf, H. Baktoft, C. E. Beardsworth, M. G. Bertram, A. I. Bijleveld, T. Brodin, J. L. Brooks, A. Campos-Candela, S. J. Cooke, K. Ø. Gjelland, P. R. Gupte, R. Harel, G. Hellström, F. Jeltsch, S. S. Killen, T. Klefoth, R. Langrock, R. J. Lennox, E. Lourie, J. R. Madden, Y. Orchan, I. S. Pauwels, M. Říha, M. Roeleke, U. E. Schlägel, D. Shohami, J. Signer, S. Toledo, O. Vilk, S. Westrelin, M. A. Whiteside, and I. Jarić. Big-data approaches lead to an increased understanding of the ecology of animal movement. *Science*, 375(6582), 2022. doi: 10.1126/science.abg1780.
- [43] Michael J. Noonan, Andrew Markham, Chris Newman, Niki Trigoni, Christina D. Buesching, Stephen A. Ellwood, and David W. Macdonald. A new magneto-inductive tracking technique to uncover subterranean activity: what do animals do underground? *Methods in Ecology and Evolution*, 6(5):510–520, 2015. doi: 10.1111/2041-210X.12348.
- [44] Panasonic. *Lithium Manganese Dioxide Coin Cell, CR2477*. Datasheet; not dated.
- [45] Teresa M. Pegan, David P. Craig, Eric R. Gulson-Castillo, Richard M. Gabrielson, Wayne Bezner Kerr, Robert MacCurdy, Steven P. Powell, and David W. Winkler. Solar-powered radio tags reveal patterns of post-fledging site visitation in adult and juvenile Tree Swallows *Tachycineta bicolor*. *PLoS ONE*, 13(11):e0206258, 2018. doi: 10.1371/journal.pone.0206258.
- [46] Emanuel Peled. Personal communication, October 2018. Peled is a Professor of Chemistry in Tel Aviv University.
- [47] Christian Rutz, Zackory T. Burns, Richard James, Stefanie M.H. Ismar, John Burt, Brian Otis, Jayson Bowen, and James J.H. St Clair. Automated mapping of social networks in wild birds. *Current Biology*, 22(17):R669–R671, 2012. doi: 10.1016/j.cub.2012.06.037.
- [48] Alexander Schwartz. Vesper loggers family line. Retrieved February 9, 2022. URL: <https://asd-tech.com/products/>.
- [49] Tadiran. *Lithium Thionyl Chloride C-Size Battery, TL-4920*, January 2006. Datasheet.
- [50] Taylor, P. D., T. L. Crewe, S. A. Mackenzie, D. Lepage, Y. Aubry, Z. Crysler, G. Finney, C. M. Francis, C. G. Guglielmo, D. J. Hamilton, R. L. Holberton, P. H. Loring, G. W. Mitchell, D. Norris, J. Paquet, R. A. Ronconi, J. Smetzer, P. A. Smith, L. J. Welch, and B. K. Woodworth. The Motus wildlife tracking system: a collaborative research network to enhance the understanding of wildlife movement. *Avian Conservation and Ecology*, 12(1), 2017. doi: 10.5751/ACE-00953-120108.

- [51] Sivan Toledo. Evaluating batteries for advanced wildlife telemetry tags. *IET Transactions on Wireless Sensor Systems*, 5:235–242, 2015. doi:10.1049/iet-wss.2014.0042.
- [52] Sivan Toledo, Oren Kishon, Yotam Orchan, Yoav Bartan, Nir Sapir, Yoni Vortman, and Ran Nathan. Lightweight low-cost wildlife tracking tags using integrated transceivers. In *Proceedings of the 6th Annual European Embedded Design in Education and Research Conference (EDERC)*, pages 287–291, Milano, Italy, September 2014. doi:10.1109/EDERC.2014.6924406.
- [53] Sivan Toledo, Yotam Orchan, David Shohami, Motti Charter, and Ran Nathan. Physical-layer protocols for lightweight wildlife tags with Internet-of-things transceivers. In *Proceedings of the 19th IEEE International Symposium on a World of Wireless, Mobile, and Multimedia Networks (WOWMOM)*, June 2018. doi:10.1109/WOWMOM.2018.8449778.
- [54] Sivan Toledo, David Shohami, Ingo Schiffner, Emmanuel Lourie, Yotam Orchan, Yoav Bartan, and Ran Nathan. Cognitive map-based navigation in wild bats revealed by a new high-throughput tracking system. *Science*, 369(6500):188–193, 2020. doi:10.1126/science.aax6904.
- [55] Ohad Vilck, Yotam Orchan, Motti Charter, Nadav Ganot, Sivan Toledo, Ran Nathan, and Michael Assaf. Ergodicity breaking and lack of a typical waiting time in area-restricted search of avian predators, 2021. arXiv preprint, submitted for publication. arXiv:2101.11527.
- [56] Adi Weller, Yotam Orchan, Ran Nathan, Motti Charter Anthony J. Weiss, and Sivan Toledo. Characterizing the accuracy of a self-synchronized reverse-GPS wildlife localization system. In *Proceedings of the 15th ACM/IEEE International Conference on Information Processing in Sensor Networks (IPSN)*, Vienna, Austria, April 2016. doi:10.1109/IPSN.2016.7460662.
- [57] Elin Wollert. *CC2538/CC26x0/CC26x2 Serial Bootloader Interface*. Texas Instruments, August 2021. Application Note SWRA466 revision D.
- [58] Dimitrios Zorbas, Khaled Abdelfadeel, Panayiotis Kotzanikolaou, and Dirk Pesch. TS-LoRa: Time-slotted lorawan for the industrial Internet of things. *Computer Communications*, 153:1–10, 2020. doi:10.1016/j.comcom.2020.01.056.