

# Blended Latent Diffusion

OMRI AVRAHAMI, The Hebrew University of Jerusalem, Israel

OHAD FRIED, Reichman University, Israel

DANI LISCHINSKI, The Hebrew University of Jerusalem, Israel

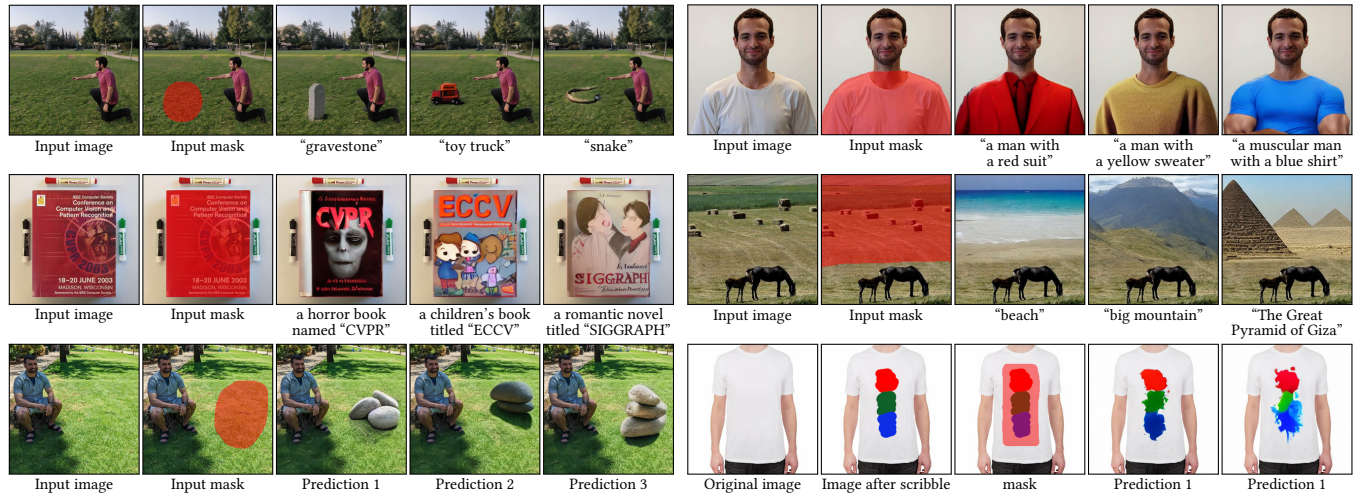

Fig. 1. **Applications of our method:** (top left) adding a new object in the masked area guided by the text prompt, (top right) altering a part within an existing object, (middle left) generation of text, (middle right) altering the background in the scene, (bottom left) generating multiple predictions for the same text prompt (“stones”), and (bottom right) guiding the result by a combination of text (“paint splashes”) and scribbles.

The tremendous progress in neural image generation, coupled with the emergence of seemingly omnipotent vision-language models has finally enabled text-based interfaces for creating and editing images. Handling *generic* images requires a diverse underlying generative model, hence the latest works utilize diffusion models, which were shown to surpass GANs in terms of diversity. One major drawback of diffusion models, however, is their relatively slow inference time. In this paper, we present an accelerated solution to the task of *local* text-driven editing of generic images, where the desired edits are confined to a user-provided mask. Our solution leverages a recent text-to-image Latent Diffusion Model (LDM), which speeds up diffusion by operating in a lower-dimensional latent space. We first convert the LDM into a local image editor by incorporating Blended Diffusion into it. Next we propose an optimization-based solution for the inherent inability of this LDM to accurately reconstruct images. Finally, we address the scenario of performing local edits using thin masks. We evaluate our method against the available baselines both qualitatively and quantitatively and demonstrate that in addition to being faster, our method achieves better precision than the

Authors’ addresses: Omri Avrahami, The Hebrew University of Jerusalem, Israel; Ohad Fried, Reichman University, Israel; Dani Lischinski, The Hebrew University of Jerusalem, Israel.

Permission to make digital or hard copies of all or part of this work for personal or classroom use is granted without fee provided that copies are not made or distributed for profit or commercial advantage and that copies bear this notice and the full citation on the first page. Copyrights for components of this work owned by others than ACM must be honored. Abstracting with credit is permitted. To copy otherwise, or republish, to post on servers or to redistribute to lists, requires prior specific permission and/or a fee. Request permissions from [permissions@acm.org](mailto:permissions@acm.org).

© 2022 Association for Computing Machinery.

0730-0301/2022/6-ART \$15.00

<https://doi.org/XXXXXXX.XXXXXXX>

baselines while mitigating some of their artifacts. Project page is available at <https://omriavrahami.com/blended-latent-diffusion-page/>

CCS Concepts: • **Computing methodologies** → **Image manipulation**.

Additional Key Words and Phrases: Zero-Shot Text-Driven Local Image Editing

## ACM Reference Format:

Omri Avrahami, Ohad Fried, and Dani Lischinski. 2022. Blended Latent Diffusion. *ACM Trans. Graph.* 1, 1 (June 2022), 20 pages. <https://doi.org/XXXXXXX.XXXXXXX>

## 1 INTRODUCTION

In recent years we have witnessed tremendous progress in realistic image synthesis and image manipulation with deep neural generative models. GAN-based models were first to emerge [Goodfellow et al. 2014; Brock et al. 2018; Karras et al. 2019, 2020], soon followed by diffusion-based models [Sohl-Dickstein et al. 2015; Ho et al. 2020; Nichol and Dhariwal 2021]. In parallel, recent advances in multimodal machine learning, such as CLIP [Radford et al. 2021] have opened the way for generating and editing images using a fundamental form of human communication – natural language. The resulting text-guided image generation and manipulation approaches, e.g., [Patashnik et al. 2021; Nichol et al. 2021; Ramesh et al. 2022] enable artists to simply convey their intent in natural language, potentially saving hours of painstaking manual work. Figure 1 demonstrates some examples.

However, the vast majority of the text-guided approaches focus on generating images from scratch or on manipulating existing

images at the *global* level. Thus, the *local* editing scenario, where the artist is only interested in modifying a part of a *generic* image, while preserving the remaining parts, has not received nearly as much attention, despite the ubiquity of this use case in practice. To our knowledge, only three methods to date explicitly address the local editing scenario: Blended Diffusion [Avrahami et al. 2021], GLIDE [Nichol et al. 2021] and DALL·E 2 [Ramesh et al. 2022]. Of these methods, only Blended Diffusion is publicly available in full.

All three local editing approaches above are based on diffusion models [Sohl-Dickstein et al. 2015; Nichol and Dhariwal 2021; Ho et al. 2020]. While diffusion models have shown impressive results on generation, editing, and other tasks (see Section 2), their main drawback is their long inference times, due to the iterative diffusion process that is applied at the pixel level to generate each result. Some recent works [Rombach et al. 2021; Gu et al. 2021; Esser et al. 2021b; Bond-Taylor et al. 2021; Hu et al. 2021] have thus proposed to perform the diffusion on a latent space with lower dimensionality and higher-level semantics, compared to pixels, yielding competitive performance on various tasks with much lower training and inference times. In particular, Latent Diffusion Models (LDM) [Rombach et al. 2021] offer this appealing combination of competitive image quality with fast inference times, however, this approach targets text-to-image generation from scratch, rather than global image manipulation, let alone local editing.

In this work, we harness the merits of LDM to the task of *local* text-guided natural image editing, where the user provides the image to be edited, a natural language text prompt, and a mask indicating an area to which the edit should be confined. Our approach is “zero-shot”, since it relies on available pretrained models, and requires no further training. We first show how to adapt the Blended Diffusion approach of Avrahami et al. [2021] to work on the latent space of LDM, instead of working at the pixel level.

Next, we address the imperfect reconstruction inherent to LDM, due to the use of VAE-based lossy latent encodings. This is especially problematic when the original image contains areas to which human perception is particularly sensitive (e.g., faces or text) or other non-random high frequency details. We present a latent optimization-based approach that is able to effectively mitigate this issue.

Then, we address the challenge of performing local edits inside thin masks. Such masks are essential when the desired edit is highly localized, but they present a difficulty when working in a latent space with lower spatial resolution. To overcome this issue, we propose a solution that starts with a dilated mask, and gradually shrinks it as the diffusion process progresses.

Finally, we evaluate our method against the baselines both qualitatively and quantitatively, using new metrics for text-driven editing methods that we propose: precision and diversity. We demonstrate that our method is not only faster than the baselines but also achieves better precision.

In summary, the main contribution of this paper are: (1) Adapting the promising text-to-image LDM to the task of local text-guided image editing. (2) Addressing the inherent problem of bad image reconstruction in LDM, which severely limits the applicability of this method. (3) Addressing the case when the method is fed by a thin mask, based on our investigation of the diffusion dynamics.

(4) Proposing new evaluation metrics for quantitative comparisons between text-driven editing methods.

## 2 RELATED WORK

**Text-to-image synthesis and global editing:** Text-to-image synthesis has advanced tremendously in recent years. Seminal works based on RNNs [Mansimov et al. 2016] and GANs [Reed et al. 2016; Zhang et al. 2017, 2018b; Xu et al. 2018], were later superseded by transformer-based approaches [Vaswani et al. 2017]. DALL·E [Ramesh et al. 2021] proposed a two-stage approach: first, train a discrete VAE [van den Oord et al. 2017; Razavi et al. 2019] to learn a rich semantic context, then train a transformer model to autoregressively model the joint distribution over the text and image tokens.

Another line of works is based on CLIP [Radford et al. 2021], a vision-language model that learns a rich shared embedding space for images and text, by contrastive training on a dataset of 400 million (image, text) pairs collected from the internet. Some of them [Patashnik et al. 2021; Crowson et al. 2022; Crowson 2021; Liu et al. 2021; Kim and Ye 2021; Murdock 2021; Paiss et al. 2022] combine a pretrained generative model [Brock et al. 2018; Esser et al. 2021a; Dhariwal and Nichol 2021] with a CLIP model to steer the generative model to perform text-to-image synthesis. Utilizing CLIP along with a generative model was also used for text-based domain adaptation [Gal et al. 2021] and text-to-image without training on text data [Zhou et al. 2021; Wang et al. 2022; Ashual et al. 2022]. Make-a-scene [Gafni et al. 2022] first predicts the segmentation mask, conditioned on the text, and then uses the generated mask along with the text to generate the predicted image. These works do not address our setting of *local* text-guided image editing.

**Local text-guided image manipulation:** Paint By Word [Bau et al. 2021] was first to address the problem of zero-shot local text-guided image manipulation by combining BigGAN / StyleGAN with CLIP and editing only the part of the feature map that corresponds to the input mask. However, this method only operated on generated images as input, and used a separate generative model per input domain. Later, Blended Diffusion [Avrahami et al. 2021] was proposed as the first solution for *local* text-guided editing of real *generic* images; this approach is further described in Section 3.

Text2LIVE [Bar-Tal et al. 2022] proposed a way to edit the appearance of an object within an image, without the need to rely on a pretrained generative model. They mainly focus on changing the colors/textures of an existing object or adding effects such as fire/smoke, and not on editing a general scene by removing objects or replacing them with new ones, as we do.

More related to our work are the recent GLIDE [Nichol et al. 2021] and DALL·E 2 [Ramesh et al. 2022] works. GLIDE employs a two-stage diffusion-based approach for text-to-image synthesis: the first stage generates a low-resolution version of the image, while the second stage generates a higher resolution version of the image, conditioned on both the low-resolution version and the guiding text. In addition, they fine-tune their model specifically for the task of local editing by a guiding text prompt. Currently, only GLIDE-filtered, a smaller version of their model (300M parameters instead of 5B), which was trained on a smaller filtered dataset, has been released.

As we demonstrate in Section 5, GLIDE-filtered often fails to obtain the desired edits. DALL·E 2 performs text-to-image synthesis by mapping text prompts into CLIP image embeddings, followed by decoding such embeddings to images. The DALL·E 2 website [OpenAI 2022] shows some examples of local text-guided image editing; however, this is not discussed in the paper [Ramesh et al. 2022]. Furthermore, neither of their two models has been released.

In summary, at the time of this writing, the only publicly available models that address our setting are Blended Diffusion and GLIDE-filtered.

### 3 LATENT DIFFUSION AND BLENDED DIFFUSION

Diffusion models are deep generative models that sample from the desired distribution by learning to reverse a gradual noising process. The process starts from a standard normal distribution noise  $x_T$  and produces a series of less-noisy latents,  $x_{T-1}, \dots, x_0$ . For more details, please refer to [Ho et al. 2020; Nichol and Dhariwal 2021].

Traditional diffusion models operate directly in the pixel space, hence their optimization often consumes hundreds of GPU days and their inference times are long. To enable faster training and inference on limited computational resources, Rombach et al. [2021] proposed Latent Diffusion Models (LDMs). In the first stage, they perform perceptual image compression, using an autoencoder (VAE [Kingma and Welling 2013] or VQ-VAE [Razavi et al. 2019; Van Den Oord et al. 2017; Esser et al. 2021a]). In the second stage, a diffusion model is used that operates on the lower-dimensional latent space. They also demonstrate the ability to train a conditional diffusion model on various modalities (e.g., semantic maps, images, or texts), s.t. when they combine it with the autoencoder they create image-to-image / semantic-map-to-image / text-to-image transitions.

Blended Diffusion [Avrahami et al. 2021] proposed addresses the task of zero-shot text-guided local image editing. This approach utilizes a diffusion model trained on ImageNet [Deng et al. 2009], which serves as a prior for the manifold of the natural images, and a CLIP model [Radford et al. 2021], which navigates the diffusion model towards the desired text-specified outcome. In order to create a seamless result where only the masked region is modified to comply with the guiding text prompt, they spatially blend each of the noisy images progressively generated by the CLIP-guided process with the *corresponding noisy version* of the input image. The main limitations of this method is its slow inference time (about 25 minutes using a GPU) and its pixel-level noise artifacts (see Figure 2).

In the next section, we leverage the trained LDM text-to-image model of Rombach et al. [2021] to offer a solution for zero-shot text-guided local image editing by incorporating Blended Diffusion into the LDM latent space (Section 4.1) and mitigating its inherent artifacts (Sections 4.2 and 4.3).

## 4 METHOD

Given an image  $x$ , a guiding text prompt  $d$  and a binary mask  $m$  that marks the region of interest in the image, our goal is to produce a modified image  $\hat{x}$ , s.t. the content  $\hat{x} \odot m$  is consistent with the text description  $d$ , while the complementary area remains close to the source image, i.e.,  $x \odot (1-m) \approx \hat{x} \odot (1-m)$ , where  $\odot$  is element-wise

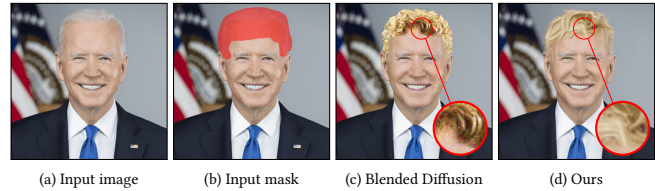

Fig. 2. **Noise artifacts:** Given the input image (a) and mask (b) with the guiding text “curly blond hair”, Blended Diffusion produces noticeable pixel-level noise artifacts (c), in contrast to our method (d).

**Algorithm 1** Latent Blended Diffusion: given a text-conditioned Latent Diffusion model  $\{VAE = (E(x), D(z)), DiffusionModel = (noise(z, t), denoise(z, d, t))\}$

**Input:** source image  $x$ , target text description  $d$ , input mask  $m$ , diffusion steps  $k$ .  
**Output:** edited image  $\hat{x}$  that differs from input image  $x$  inside area  $m$  according to text description  $d$

```

 $m_{latent} = \text{downsample}(m)$ 
 $z_{init} \sim E(x)$ 
 $z_k \sim \text{noise}(z_{init}, k)$ 
for all  $t$  from  $k$  to 0 do
   $z_{fg} \sim \text{denoise}(z_t, d, t)$ 
   $z_{bg} \sim \text{noise}(z_{init}, t)$ 
   $z_t \leftarrow z_{fg} \odot m_{latent} + z_{bg} \odot (1 - m_{latent})$ 
end for
 $\hat{x} = D(z_0)$ 
return  $\hat{x}$ 

```

multiplication. Furthermore, the transition between the two areas of  $\hat{x}$  should ideally appear seamless.

In Section 4.1 we start by incorporating Blended Diffusion [Avrahami et al. 2021] into Latent Diffusion [Rombach et al. 2021] in order to achieve local text-driven editing. The resulting method fails to achieve satisfying results in some cases; specifically, the reconstruction of the complementary area is imperfect, and the method struggles when the input mask  $m$  contains thin parts. We solve these issues in Sections 4.2 and 4.3, respectively.

### 4.1 Blended Latent Diffusion

As explained in Section 3, Latent Diffusion [Rombach et al. 2021] can generate an image from a given text (text-to-image LDM). However, this model lacks the capability of editing an existing image in a local fashion, hence we propose to incorporate Blended Diffusion [Avrahami et al. 2021] into text-to-image LDM. Our approach is summarized in Algorithm 1, for an illustration of the algorithm please read Section C.

LDM performs text-guided denoising diffusion in the latent space learned by a variational auto-encoder  $VAE = (E(x), D(z))$ . Referring to the part that we wish to modify as foreground ( $fg$ ) and to the remaining part as background ( $bg$ ), we follow the idea of Blended Diffusion and repeatedly blend the two parts in this latent space, as the diffusion progresses. The input image  $x$  is encoded into the latent space using the VAE encoder  $z_{init} \sim E(x)$ . The latent space still has spatial dimensions (due to the convolutional nature of the VAE), however the width and the height are smaller than those of the input image (by a factor of 8). We therefore downsample the input mask  $m$  to these spatial dimensions to obtain the latent space mask  $m_{latent}$ , which will be used to perform the blending.

Now, we noise the initial latent  $z_{init}$  to the desired noise level (in a single step) and manipulate the denoising diffusion process in

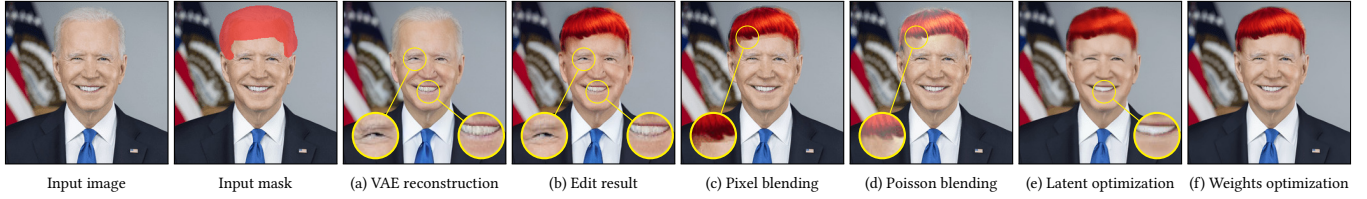

Fig. 3. **Background reconstruction comparison:** Given the input image, mask, and guiding text prompt “red hair”, the reconstruction does not preserve the unmasked area details (a,b). Pixel-level blending yields a result (c) with noticeable seams. Poisson seamless cloning (d) changes the colors of the edited area, while latent optimization (e) produces an over smoothed result. We propose per-sample weights optimization (f) which produces the best results.

the following way: at each step, we first perform a latent denoising step, conditioned directly on the guiding text prompt  $d$ , to obtain a less noisy foreground latent denoted as  $z_{fg}$ , while also noising the original latent  $z_{init}$  to the current noise level to obtain a noisy background latent  $z_{bg}$ . The two latents are then blended using the resized mask, i.e.  $z_{fg} \odot m_{latent} + z_{bg} \odot (1 - m_{latent})$ , to yield the latent for the next latent diffusion step. Similarly to Blended Diffusion, at each denoising step the entire latent is modified, but the subsequent blending enforces the parts outside  $m_{latent}$  to remain the same. While the resulting blended latent is not guaranteed to be coherent, the next latent denoising step makes it so. Once the latent diffusion process terminates, we decode the resultant latent to the output image using the decoder  $D(z)$ .

Operating on the latent level, in comparison to operating directly on pixels using a CLIP model, has the following main advantages:

- (1) **Faster inference:** Because the dimension of the latent space is much smaller, the diffusion process is much faster. In addition, there is no need to calculate the CLIP-loss gradients at each denoising step. Thus, the entire editing process is faster by an order of magnitude (see Section 5.2).
- (2) **Avoiding pixel-level artifacts:** Pixel-level diffusion sometimes results in pixel values outside the valid range, producing noticeable clipping artifacts. Operating in the latent space avoids such artifacts (Figure 2).
- (3) **Avoiding adversarial examples:** Operating on the latent space with no pixel-level CLIP-loss gradients effectively eliminates the risk of adversarial examples. Thus, there is no need for the extending augmentations used by Avrahami et al. [2021].
- (4) **Better precision:** Our method achieves better precision than the baselines, both at the batch level and at the final prediction level (Section 5).

However, operating in latent space introduces some drawbacks, which we will address later in this section:

- (1) **Imperfect reconstruction:** The VAE latent encoding is lossy; hence, the final results are upper bounded by the decoder’s reconstruction abilities. Even the initial reconstruction, before performing any diffusion, often visibly differs from the input. In images of human faces, or images with high frequencies, even such slight changes may be perceptible (see Figure 3(b)).
- (2) **Thin masks:** When the input mask  $m$  is relatively thin (and its downscaled version  $m_{latent}$  can become even thinner), the effect of the edit might be limited or non-existent (see Figure 6).

## 4.2 Background Reconstruction

As discussed above, LDM’s latent representation is obtained using a VAE [Kingma and Welling 2013], which is lossy. As a result, the encoded image is not reconstructed exactly, even before any latent diffusion takes place (Figure 3(a)). The imperfect reconstruction may thus be visible in areas outside the mask (Figure 3(b)).

A naïve way to deal with this problem is to stitch the original image and the edited result  $\hat{x}$  at the pixel level, using the input mask  $m$ . But, because the unmasked areas were not generated by the decoder, there is no guarantee that the generated part will blend seamlessly with the surrounding background. Indeed, this naïve stitching produces visible seams, as demonstrated in Figure 3(c).

Alternatively, one could perform seamless cloning between the edited region and the original, e.g., utilizing Poisson Image Editing [Pérez et al. 2003], which uses gradient-domain reconstruction in pixel space. However, this often results in a noticeable color shift of the edited area, as demonstrated in Figure 3(d).

In the GAN inversion literature [Abdal et al. 2019, 2020; Zhu et al. 2020; Xia et al. 2021] it is standard practice to achieve image reconstruction via latent-space optimization. In theory, latent optimization can also be used to perform seamless cloning, as a post-process step: given the input image  $x$ , the mask  $m$ , and the edited image  $\hat{x}$ , along with its corresponding latent vector  $z_0$ , one could use latent optimization to search for a better vector  $z^*$ , s.t. the masked area will be similar to the edited image  $\hat{x}$  and the unmasked area will be similar to the input image  $x$ :

$$z^* = \underset{z}{\operatorname{argmin}} \|D(z) \odot m, \hat{x} \odot m\| + \lambda \|D(z) \odot (1 - m), x \odot (1 - m)\| \quad (1)$$

using a standard distance metric, such as MSE.  $\lambda$  is a hyperparameter that controls the importance of the background preservation, which we set to  $\lambda = 100$  for all our results and comparisons. The optimization process is initialized with  $z^* = z_0$ . The final image is then inferred from  $z^*$  using the decoder:  $x^* = D(z^*)$ . However, as we can see in Figure 3(e), even though the resulting image is closer to the input image, it is over-smoothed.

The inability of latent space optimization to capture the high-frequency details suggests that the expressivity of the decoder  $D(z)$  is limited. This leads us again to draw inspiration from GAN inversion literature — it was shown [Bau et al. 2020; Pan et al. 2021; Roich et al. 2021] that fine-tuning the GAN generator weights per image results in a better reconstruction. Inspired by this approach, we can achieve seamless cloning by fine-tuning the decoder’s weights  $\theta$  on

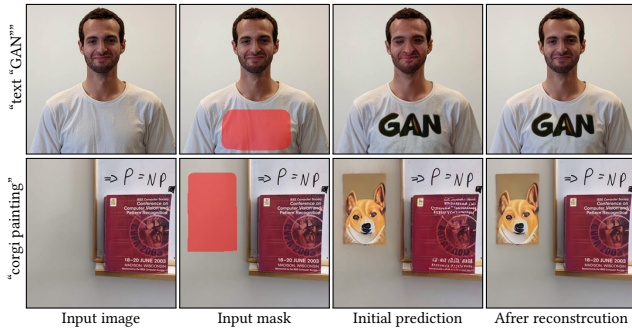

Fig. 4. **Background reconstruction using decoder weights fine-tuning:** Note the bad initial prediction of the high-frequency areas in the background: the human face in the first row, and the text on the book in the second row (zoom in for a better presentation).



Fig. 5. **Thin mask progression:** Given the input image, mask (bottom right corner), and guiding text “fire”, in the standard case (1) only the initial stages correspond to the text (rough red colors), but later the blending overrides it. In contrast, using our progressively shrinking masks (3) the guiding text corresponds to all the images throughout the diffusion process (2).

a per-image basis:

$$\theta^* = \operatorname{argmin}_{\theta} \|D_{\theta}(z_0) \odot m, \hat{x} \odot m\| + \lambda \|D_{\theta}(z_0) \odot (1 - m), x \odot (1 - m)\|, \quad (2)$$

and use these weights to infer the result  $x^* = D_{\theta^*}(z_0)$ . As we can see in Figure 3(f), this method yields the best result: the foreground region follows  $\hat{x}$ , while the background preserves the fine details from the input image  $x$ , and the blending appears seamless.

In contrast to Blended Diffusion [Avrahami et al. 2021], in our method the background reconstruction is optional. Thus, it is only needed in cases where the unmasked area contains perceptually important fine-detail content, such as faces, text, structured textures, etc. A few reconstruction examples are shown in Figure 4.

### 4.3 Progressive Mask Shrinking

When the input mask  $m$  has thin parts, these parts may become even thinner in its downsampled version  $m_{latent}$ , to the point that changing the latent values under  $m_{latent}$  by the text-driven diffusion process fails to produce a visible change in the reconstructed result. In order to pinpoint the root-cause, we visualize the diffusion process:

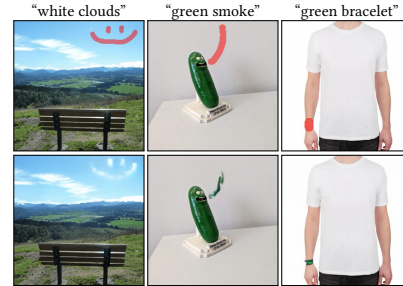

Fig. 6. **Progressive mask shrinking:** With the thin input masks in these examples (top row), the method described in Algorithm 1 fails to alter the image according to the text. This issue is mitigated using progressive mask shrinking (bottom row).

given a noisy latent  $z_t$  at timestep  $t$ , we can estimate  $z_0$  using a single diffusion step with the closed form formula derived by Song et al. [2020]. The corresponding image is then inferred using the VAE decoder  $D(z_0)$ .

Using the above visualization, Figure 5 shows that during the denoising process, the earlier steps generate only rough colors and shapes, which are gradually refined to the final output. The top row shows that even though the guiding text “fire” is echoed in the latents early in the process, blending these latents with  $z_{bg}$  using a thin  $m_{latent}$  mask may cause the effect to disappear.

This understanding suggests the idea of *progressive mask shrinking*: because the early noisy latents correspond to only the rough colors and shapes, we start with a rough, dilated version of  $m_{latent}$ , and gradually shrink it as the diffusion process progresses, s.t. only the last denoising steps employ the thin  $m_{latent}$  mask when blending  $z_{fg}$  with  $z_{bg}$ . The process is visualized in Figure 5. For more implementation details and videos visualizing the process, please see the supplementary material.

Figure 6 demonstrates the effectiveness of this method. Nevertheless, this technique struggles in generating fine details (e.g. the “green bracelet” example).

### 4.4 Prediction Ranking

Because of the stochastic nature of the diffusion model, we can generate multiple predictions for the same inputs, which is a desirable characteristic because of the one-to-many nature of our problem. As in previous works [Razavi et al. 2019; Ramesh et al. 2021; Avrahami et al. 2021], we found it beneficial to generate multiple predictions, rank them, and retrieve the best ones. We rank the predictions by the normalized cosine distance between their CLIP embeddings and the CLIP embedding of the guiding prompt  $d$ .

## 5 RESULTS

We begin by comparing our method against previous methods, both qualitatively and quantitatively. Next, we demonstrate several of the use cases enabled by our method.

### 5.1 Comparisons

In Figure 7 we compare the zero-shot text-driven image editing results produced by our method against the following baselines: (1) Local CLIP-guided diffusion [Crowson 2021], (2) *PaintByWord++* [Bau

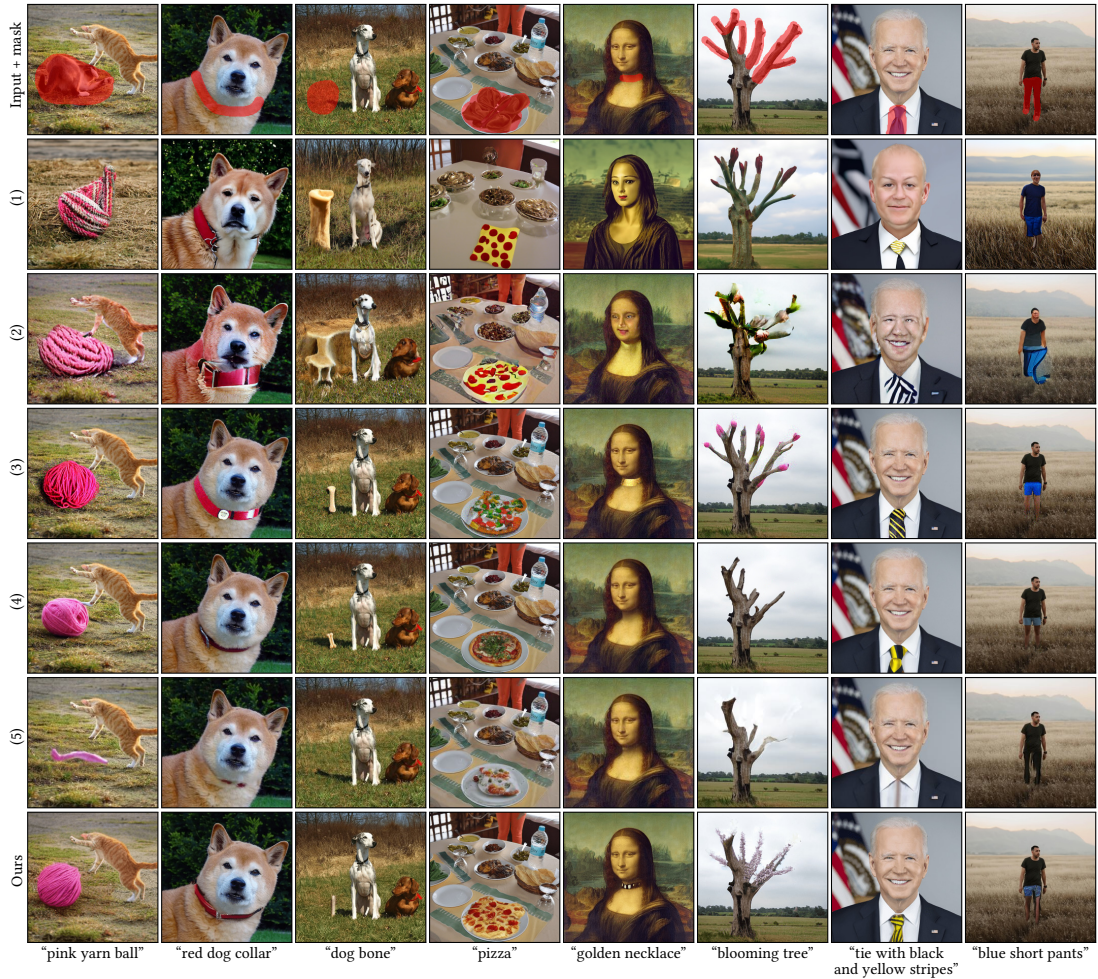

Fig. 7. **Comparison to baselines:** A comparison with (1) Local CLIP-guided diffusion [Crowson 2021], (2) *PaintByWord++* [Bau et al. 2021; Crowson et al. 2022], (3) Blended Diffusion [Avrahami et al. 2021], (4) GLIDE [Nichol et al. 2021] and (5) GLIDE-filtered [Nichol et al. 2021].

et al. 2021; Crowson et al. 2022], (3) Blended Diffusion [Avrahami et al. 2021], (4) GLIDE [Nichol et al. 2021], and (5) GLIDE-filtered [Nichol et al. 2021]. See Avrahami et al. [2021] for more details on baselines (1)–(3). The images for the baselines (1)–(4) were taken directly from the corresponding papers. Note that Nichol et al. [2021] only released GLIDE-filtered, a smaller version of GLIDE, which was trained on a filtered dataset, and this is the only public version of GLIDE. Because the full GLIDE model (4) is not available, we use the results from the paper [Nichol et al. 2021]. The images for (3)–(5) and our method required generating a batch of samples and taking the best one ranked by CLIP. The GLIDE model has about  $\times 3$  the parameters vs. our model. For more comparison details, see Section 2.1 in the supplementary materials.

Figure 7 demonstrates that baselines (1) and (2) do not always preserve the background of the input image. The edits by GLIDE-filtered (5) typically fail to follow the guiding text. So the comparable baselines are (3) Blended Diffusion and (4) GLIDE. As we can see, our method avoids the pixel-level noises of Blended Diffusion (e.g.,

the pizza example) and generates better colors and textures (e.g., the dog collar example). Comparing to GLIDE, we see that in some cases GLIDE generates better shadows than our method (e.g., the cat example), however it can add artifacts (e.g., the front right paw of the cat in GLIDE’s prediction). Furthermore, GLIDE’s generated results do not always correspond to the guiding text (e.g., the golden necklace and blooming tree examples).

During our experiments, we noticed that a batch predicted by our method typically contains more results that comply with the guiding text prompt. In order to verify this quantitatively, we generated editing predictions for 50 random images, random masks, and text prompts randomly chosen from ImageNet classes. Batch precision was then evaluated using an off-the-shelf ImageNet classifier. We refrained from using CLIP cosine similarity as the precision measure, because it was shown [Nichol et al. 2021] that CLIP operates badly as an evaluator for gradient-based solutions that use CLIP, due to adversarial attacks. We denote this measure as the “precision” of the model. For more details read Section C.1 As reported in

| Method                      | Batch Precision $\uparrow$ | Batch Diversity $\uparrow$ | Best Result Precision $\uparrow$ |
|-----------------------------|----------------------------|----------------------------|----------------------------------|
| Blended Diffusion           | 10.4%                      | 0.106                      | 36%                              |
| Local CLIP-guided diffusion | 10.49%                     | <b>0.419</b>               | 38%                              |
| PaintByWord++               | -                          | -                          | 0%                               |
| GLIDE-filtered              | 1.87%                      | 0.114                      | 4%                               |
| Ours                        | <b>28.66%</b>              | 0.115                      | <b>54%</b>                       |

Table 1. **Precision and diversity:** we outperform the baselines in terms of precision, both at the batch level and at the best result level. In terms of diversity, our method is outperformed by the Local CLIP-guided diffusion baseline, probably due to the lack of background preservation of this method.

| Method                         | Batch Size | Single Image (sec) $\downarrow$ | Full Batch (sec) $\downarrow$ | Per Image in Batch (sec) $\downarrow$ |
|--------------------------------|------------|---------------------------------|-------------------------------|---------------------------------------|
| Blended Diffusion              | 64         | 27                              | 1472                          | 23                                    |
| Blended Diffusion              | 24*        | 27                              | 552                           | 23                                    |
| Local CLIP-guided diffusion    | 64         | 27                              | 1472                          | 23                                    |
| Local CLIP-guided diffusion    | 24*        | 27                              | 552                           | 23                                    |
| PaintByWord++                  | -          | 78                              | -                             | -                                     |
| GLIDE-filtered                 | 24         | 7                               | 89                            | 3.7                                   |
| Ours (without background opt.) | 24         | 6                               | 53                            | <b>2.2</b>                            |
| Ours (with background opt.)    | 24         | 25                              | 72                            | <b>3</b>                              |

Table 2. **Inference time comparison:** Our method outperforms all other methods when using batch processing. This stems from the fact that we perform diffusion in the latent space, and because our background preservation optimization is only required for the top-ranked result. Batch sizes marked with \* are below the size recommended by the respective authors (lower batch precision), but are reported for comparison purposes.

Table 1, our method indeed outperforms the baselines by a large margin. In addition, we ranked the results in the batch as described in Section 4.4 and calculated the average accuracy by taking only the top image in each batch, to find that our method still outperforms the baselines.

We also assess the average batch diversity, by calculating the pairwise LPIPS [Zhang et al. 2018a] distances between all the predictions in the batch that were classified correctly by the classifier. As can be seen in Table 1, our method has the second-best diversity, but it is outperformed by Local CLIP-guided diffusion by a large margin, which we attribute to the fact that this method changes the entire image (does not preserve the background) and thus the content generated in the masked area is much less constrained.

## 5.2 Inference Time Comparison

We compare the inference time of various methods on an A10 NVIDIA GPU in Table 2. We show results for Blended Diffusion and GLIDE-filtered (the available smaller model, which is probably faster than the full unpublished model). Both of these methods require generating multiple predictions (batch) and taking the best one in order to achieve good results. The recommended batch size for Blended Diffusion is 64, whereas GLIDE-filtered and our method use a batch size of 24.

Our method supports generation with or without optimizing for background preservation (Section 4.2), and we report both options in Table 2. Our method outperforms the baselines on the standard case of batch inference, even when accounting for the background preservation optimization. The acceleration in comparison to Blended Diffusion and Local CLIP-guided diffusion is  $\times 10$  with equal batch sizes and  $\times 20$  with the recommended batch sizes, which stems from the



Fig. 8. **Limitations:** Top row: our CLIP-based ranking takes into account only the masked area, Thus, the results are sometimes only piece-wise realistic, and the image does not look realistic as a whole. Bottom row: the model has a text bias - it may try to create movie posters/book covers with text instead of or in addition to generating the actual object.

fact that our generation process is done in the lower dimensional latent space, and the background preservation optimization need only be done on the selected result. The acceleration in comparison to PaintByWord++ and GLIDE-filtered is  $\times 1.47$  and  $\times 1.23$ , respectively.

## 5.3 Use Cases

Our method is applicable in a variety of editing scenarios with generic real-world images, several of which we demonstrate here.

**Text-driven object editing:** using our method one can easily add new objects (Figure 1(a)) or modify or replace existing ones (Figure 1(b)), guided by a text prompt. In addition, we have found that the method is capable of injecting visually plausible text into images, as demonstrated in Figure 1(c).

**Background replacement:** rather than inserting or editing the foreground object, another important use case is to replace the background using text guidance, as demonstrated in Figure 1(d).

**Scribble-guided editing:** A user-provided scribble can be used as a guide. Specifically, the user can scribble a rough shape on a background image, provide a mask (covering the scribble) to indicate the area that is allowed to change, and provide a text prompt. Our method transforms the scribble into a natural object while attempting to match the prompt, as demonstrated in Figure 1(f).

For all of the use cases mentioned above, our method is inherently capable of generating multiple predictions for the same input, as discussed in Section 4.4 and demonstrated in Figure 1(e). Due to the one-to-many nature of the task, we believe it is desirable to present the user with ranked (Section 4.4) multiple outcomes, from which they may choose the one that best suits their needs. Alternatively, the highest ranked result can be chosen automatically. For more results of the above applications see Section A in the supplementary.

## 6 LIMITATIONS & CONCLUSIONS

Although our method is significantly faster than prior works, it still takes over a minute to generate a batch of predictions and rank them on an A10 GPU due to the diffusion process. This limits the applicability of our method on lower-end devices. Hence, accelerating the inference time further is still an important research avenue.

In addition, as in Blended Diffusion, the CLIP-based ranking only takes into account the generated masked area. Without a more holistic view of the image, this ranking ignores the overall realism

of the output image which can result in images that are only piecewise realistic, i.e., the masked area looks realistic, but the image does not look realistic overall, e.g., Figure 8(top). Thus, a better ranking system would prove useful.

Furthermore, we observe that LDM’s amazing ability to generate texts is a double-edged sword: the guiding text may be interpreted by the model as a text generation task. For example, Figure 8(bottom) demonstrates that instead of generating a big mountain, the model tries to generate a movie poster named “big mountain”.

Even without solving the aforementioned open problems, we have shown that our system can be used to locally edit images via text. Our results are realistic enough for real-world editing scenarios, and we are excited to see what users will create with our online demo and the source code that we will release upon publication.

## ACKNOWLEDGMENTS

This work was supported in part by the Israel Science Foundation (grants No. 2492/20 and 1574/21).



## REFERENCES

- Rameen Abdal, Yipeng Qin, and Peter Wonka. 2019. Image2stylegan: How to embed images into the StyleGAN latent space?. In *Proc. ICCV*. 4432–4441.
- Rameen Abdal, Yipeng Qin, and Peter Wonka. 2020. Image2stylegan++: How to edit the embedded images?. In *Proc. CVPR*. 8296–8305.
- Oron Ashual, Shelly Sheynin, Adam Polyak, Uriel Singer, Oran Gafni, Eliya Nachmani, and Yaniv Taigman. 2022. KNN-Diffusion: Image Generation via Large-Scale Retrieval. *arXiv preprint arXiv:2204.02849* (2022).
- Omri Avrahami, Dani Lischinski, and Ohad Fried. 2021. Blended diffusion for text-driven editing of natural images. *arXiv preprint arXiv:2111.14818* (2021).
- Omer Bar-Tal, Dolev Ofri-Amar, Rafail Fridman, Yoni Kasten, and Tali Dekel. 2022. Text2LIVE: Text-Driven Layered Image and Video Editing. *arXiv preprint arXiv:2204.02491* (2022).
- David Bau, Alex Andonian, Audrey Cui, YeonHwan Park, Ali Jahanian, Aude Oliva, and Antonio Torralba. 2021. Paint by word. *arXiv preprint arXiv:2103.10951* (2021).
- David Bau, Hendrik Strobelt, William Peebles, Jonas Wulff, Bolei Zhou, Jun-Yan Zhu, and Antonio Torralba. 2020. Semantic photo manipulation with a generative image prior. *arXiv preprint arXiv:2005.07727* (2020).
- Sam Bond-Taylor, Peter Hesse, Hiroshi Sasaki, Toby P Breckon, and Chris G Willcocks. 2021. Unleashing Transformers: Parallel Token Prediction with Discrete Absorbing Diffusion for Fast High-Resolution Image Generation from Vector-Quantized Codes. *arXiv preprint arXiv:2111.12701* (2021).
- Gary Bradski and Adrian Kaehler. 2000. OpenCV. *Dr. Dobb's journal of software tools* 3 (2000), 2.
- Andrew Brock, Jeff Donahue, and Karen Simonyan. 2018. Large scale GAN training for high fidelity natural image synthesis. *arXiv preprint arXiv:1809.11096* (2018).
- Katherine Crowson. 2021. CLIP Guided Diffusion HQ 256x256. [https://colab.research.google.com/drive/12a\\_Wrfi2\\_gwwAuN3VvMTwVMz9TfqtNj](https://colab.research.google.com/drive/12a_Wrfi2_gwwAuN3VvMTwVMz9TfqtNj).
- Katherine Crowson, Stella Biderman, Daniel Kornis, Dashiell Stander, Eric Hallahan, Louis Castricato, and Edward Raff. 2022. VQGAN-CLIP: Open Domain Image Generation and Editing with Natural Language Guidance. *arXiv preprint arXiv:2204.08583* (2022).
- Jia Deng, Wei Dong, Richard Socher, Li-Jia Li, Kai Li, and Li Fei-Fei. 2009. ImageNet: A large-scale hierarchical image database. In *Proc. CVPR*. Ieee, 248–255.
- Prafulla Dhariwal and Alexander Nichol. 2021. Diffusion models beat GANs on image synthesis. *Advances in Neural Information Processing Systems* 34 (2021).
- Alexey Dosovitskiy, Lucas Beyer, Alexander Kolesnikov, Dirk Weissenborn, Xiaohua Zhai, Thomas Unterthiner, Mostafa Dehghani, Matthias Minderer, Georg Heigold, Sylvain Gelly, et al. 2020. An Image is Worth 16x16 Words: Transformers for Image Recognition at Scale. In *International Conference on Learning Representations*.
- Patrick Esser, Robin Rombach, Andreas Blattmann, and Bjorn Ommer. 2021b. Image-BART: Bidirectional context with multinomial diffusion for autoregressive image synthesis. *Advances in Neural Information Processing Systems* 34 (2021).
- Patrick Esser, Robin Rombach, and Bjorn Ommer. 2021a. Taming transformers for high-resolution image synthesis. In *Proc. CVPR*. 12873–12883.
- Ohad Fried, Jennifer Jacobs, Adam Finkelstein, and Maneesh Agrawala. 2020. Editing Self-Image. *Commun. ACM* 63, 3, 70–79. <https://doi.org/10.1145/3326601>
- Oran Gafni, Adam Polyak, Oron Ashual, Shelly Sheynin, Devi Parikh, and Yaniv Taigman. 2022. Make-A-Scene: Scene-Based Text-to-Image Generation with Human Priors. *arXiv preprint arXiv:2203.13131* (2022).
- Rinon Gal, Or Patashnik, Haggai Maron, Gal Chechik, and Daniel Cohen-Or. 2021. StyleGAN-NADA: CLIP-guided domain adaptation of image generators. *arXiv preprint arXiv:2108.00946* (2021).
- Ian Goodfellow, Jean Pouget-Abadie, Mehdi Mirza, Bing Xu, David Warde-Farley, Sherjil Ozair, Aaron Courville, and Yoshua Bengio. 2014. Generative Adversarial Nets. In *Advances in Neural Information Processing Systems*. 2672–2680.
- Shuyang Gu, Dong Chen, Jianmin Bao, Fang Wen, Bo Zhang, Dongdong Chen, Lu Yuan, and Baining Guo. 2021. Vector quantized diffusion model for text-to-image synthesis. *arXiv preprint arXiv:2111.14822* (2021).
- Jonathan Ho, Ajay Jain, and Pieter Abbeel. 2020. Denoising Diffusion Probabilistic Models. In *Proc. NeurIPS*.
- Minghui Hu, Yujie Wang, Tat-Jen Cham, Jianfei Yang, and PN Suganthan. 2021. Global Context with Discrete Diffusion in Vector Quantised Modelling for Image Generation. *arXiv preprint arXiv:2112.01799* (2021).
- Tero Karras, Samuli Laine, and Timo Aila. 2019. A style-based generator architecture for generative adversarial networks. In *Proceedings of the IEEE/CVF Conference on Computer Vision and Pattern Recognition*. 4401–4410.
- Tero Karras, Samuli Laine, Miika Aittala, Janne Hellsten, Jaakko Lehtinen, and Timo Aila. 2020. Analyzing and improving the image quality of StyleGAN. In *Proceedings of the IEEE/CVF Conference on Computer Vision and Pattern Recognition*. 8110–8119.
- Gwanghyun Kim and Jong Chul Ye. 2021. DiffusionCLIP: Text-guided image manipulation using diffusion models. *arXiv preprint arXiv:2110.02711* (2021).
- Diederik P Kingma and Jimmy Ba. 2014. Adam: A method for stochastic optimization. *arXiv preprint arXiv:1412.6980* (2014).
- Diederik P Kingma and Max Welling. 2013. Auto-encoding variational Bayes. *arXiv preprint arXiv:1312.6114* (2013).
- Xihui Liu, Dong Huk Park, Samaneh Azadi, Gong Zhang, Arman Chopikyan, Yuxiao Hu, Humphrey Shi, Anna Rohrbach, and Trevor Darrell. 2021. More Control for Free! Image Synthesis with Semantic Diffusion Guidance. *arXiv preprint arXiv:2112.05744* (2021).
- Elman Mansimov, Emilio Parisotto, Jimmy Ba, and Ruslan Salakhutdinov. 2016. Generating Images from Captions with Attention. *CoRR abs/1511.02793* (2016).
- Ryan Murdock. 2021. The Big Sleep: BigGANxCLIP. [https://colab.research.google.com/github/levindabhi/CLIP-Notebooks/blob/main/The\\_Big\\_Sleep\\_BigGANxCLIP.ipynb](https://colab.research.google.com/github/levindabhi/CLIP-Notebooks/blob/main/The_Big_Sleep_BigGANxCLIP.ipynb).
- Alex Nichol, Prafulla Dhariwal, Aditya Ramesh, Pranav Shyam, Pamela Mishkin, Bob McGrew, Ilya Sutskever, and Mark Chen. 2021. GLIDE: Towards photorealistic image generation and editing with text-guided diffusion models. *arXiv preprint arXiv:2112.10741* (2021).
- Alexander Quinn Nichol and Prafulla Dhariwal. 2021. Improved denoising diffusion probabilistic models. In *Proc. ICML*. 8162–8171.
- OpenAI. 2022. DALL·E 2. <https://openai.com/dall-e-2/>.
- Roni Paiss, Hila Chefer, and Lior Wolf. 2022. No Token Left Behind: Explainability-Aided Image Classification and Generation. *arXiv preprint arXiv:2204.04908* (2022).
- Xingang Pan, Xiaohang Zhan, Bo Dai, Dahua Lin, Chen Change Loy, and Ping Luo. 2021. Exploiting deep generative prior for versatile image restoration and manipulation. *IEEE Transactions on Pattern Analysis and Machine Intelligence* (2021).
- Adam Paszke, Sam Gross, Francisco Massa, Adam Lerer, James Bradbury, Gregory Chanan, Trevor Killeen, Zeming Lin, Natalia Gimelshein, Luca Antiga, et al. 2019. Pytorch: An imperative style, high-performance deep learning library. *Advances in neural information processing systems* 32 (2019), 8026–8037.
- Or Patashnik, Zongze Wu, Eli Shechtman, Daniel Cohen-Or, and Dani Lischinski. 2021. StyleCLIP: Text-driven manipulation of StyleGAN imagery. In *Proceedings of the IEEE/CVF International Conference on Computer Vision*. 2085–2094.
- Patrick Pérez, Michel Gangnet, and Andrew Blake. 2003. Poisson image editing. In *Proc. ACM SIGGRAPH* 2003. 313–318.
- Alec Radford, Jong Wook Kim, Chris Hallacy, Aditya Ramesh, Gabriel Goh, Sandhini Agarwal, Girish Sastry, Amanda Askell, Pamela Mishkin, Jack Clark, et al. 2021. Learning transferable visual models from natural language supervision. *arXiv preprint arXiv:2103.00020* (2021).
- Aditya Ramesh, Prafulla Dhariwal, Alex Nichol, Casey Chu, and Mark Chen. 2022. Hierarchical text-conditional image generation with CLIP latents. *arXiv preprint arXiv:2204.06125* (2022).
- Aditya Ramesh, Mikhail Pavlov, Gabriel Goh, Scott Gray, Chelsea Voss, Alec Radford, Mark Chen, and Ilya Sutskever. 2021. Zero-shot text-to-image generation. *arXiv preprint arXiv:2102.12092* (2021).
- Ali Razavi, Aaron Van den Oord, and Oriol Vinyals. 2019. Generating diverse high-fidelity images with VQ-VAE-2. *Advances in neural information processing systems* 32 (2019).
- Scott Reed, Zeynep Akata, Xinchun Yan, Lajanugen Logeswaran, Bernt Schiele, and Honglak Lee. 2016. Generative adversarial text to image synthesis. In *Proc. ICLR*. 1060–1069.
- Daniel Roich, Ron Mokady, Amit H Bermano, and Daniel Cohen-Or. 2021. Pivotal tuning for latent-based editing of real images. *arXiv preprint arXiv:2106.05744* (2021).
- Robin Rombach, Andreas Blattmann, Dominik Lorenz, Patrick Esser, and Björn Ommer. 2021. High-Resolution Image Synthesis with Latent Diffusion Models. *arXiv preprint arXiv:2112.10752* (2021).
- Christoph Schuhmann, Richard Vencu, Romain Beaumont, Robert Kaczmarczyk, Clayton Mullis, Aarush Katta, Theo Coombes, Jenia Jitsev, and Aran Komatsuzaki. 2021. Laion-400m: Open dataset of clip-filtered 400 million image-text pairs. *arXiv preprint arXiv:2111.02114* (2021).
- Jascha Sohl-Dickstein, Eric Weiss, Niru Maheswaranathan, and Surya Ganguli. 2015. Deep unsupervised learning using nonequilibrium thermodynamics. In *Proc. ICML*. 2256–2265.
- Jiaming Song, Chenlin Meng, and Stefano Ermon. 2020. Denoising Diffusion Implicit Models. In *International Conference on Learning Representations*.
- Mingxing Tan and Quoc Le. 2019. Efficientnet: Rethinking model scaling for convolutional neural networks. In *International conference on machine learning*. PMLR, 6105–6114.
- Aaron Van Den Oord, Oriol Vinyals, et al. 2017. Neural discrete representation learning. *Advances in neural information processing systems* 30 (2017).
- Aaron van den Oord, Oriol Vinyals, and Koray Kavukcuoglu. 2017. Neural Discrete Representation Learning. In *NIPS*.
- Ashish Vaswani, Noam Shazeer, Niki Parmar, Jakob Uszkoreit, Llion Jones, Aidan N Gomez, Łukasz Kaiser, and Illia Polosukhin. 2017. Attention is all you need. In *Advances in neural information processing systems*. 5998–6008.
- Zihao Wang, Wei Liu, Qian He, Xinglong Wu, and Zili Yi. 2022. CLIP-GEN: Language-Free Training of a Text-to-Image Generator with CLIP. *arXiv preprint arXiv:2203.00386* (2022).
- Weihao Xia, Yulun Zhang, Yujiu Yang, Jing-Hao Xue, Bolei Zhou, and Ming-Hsuan Yang. 2021. GAN inversion: A survey. *arXiv preprint arXiv:2101.05278* (2021).

- Tao Xu, Pengchuan Zhang, Qiuyuan Huang, Han Zhang, Zhe Gan, Xiaolei Huang, and Xiaodong He. 2018. AttnGAN: Fine-grained text to image generation with attentional generative adversarial networks. In *Proceedings of the IEEE conference on computer vision and pattern recognition*. 1316–1324.
- Han Zhang, Tao Xu, Hongsheng Li, Shaoting Zhang, Xiaogang Wang, Xiaolei Huang, and Dimitris N Metaxas. 2017. StackGAN: Text to photo-realistic image synthesis with stacked generative adversarial networks. In *Proc. ICCV*. 5907–5915.
- Han Zhang, Tao Xu, Hongsheng Li, Shaoting Zhang, Xiaogang Wang, Xiaolei Huang, and Dimitris N Metaxas. 2018b. StackGAN++: Realistic image synthesis with stacked generative adversarial networks. *IEEE transactions on pattern analysis and machine intelligence* 41, 8 (2018), 1947–1962.
- Richard Zhang, Phillip Isola, Alexei A Efros, Eli Shechtman, and Oliver Wang. 2018a. The unreasonable effectiveness of deep features as a perceptual metric. In *Proceedings of the IEEE conference on computer vision and pattern recognition*. 586–595.
- Yufan Zhou, Ruiyi Zhang, Changyou Chen, Chunyuan Li, Chris Tensmeyer, Tong Yu, Jiuxiang Gu, Jinhui Xu, and Tong Sun. 2021. LAFITE: Towards Language-Free Training for Text-to-Image Generation. *arXiv preprint arXiv:2111.13792* (2021).
- Jiapeng Zhu, Yujun Shen, Deli Zhao, and Bolei Zhou. 2020. In-domain GAN inversion for real image editing. In *Proc. ECCV*. Springer, 592–608.

| Method  | # Parameters          |
|---|-----------------------|
| Blended Diffusion & Local CLIP-guided diffusion | 0.55B + 0.15B = 0.70B |
| PaintByWord++                                   | 0.09B + 0.15B = 0.24B |
| GLIDE   | 5.00B + 0.15B = 5.15B |
| GLIDE-filtered                                  | 0.30B + 0.15B = 0.45B |
| Ours  | 1.45B + 0.15B = 1.60B |

Table 3. **Parameters comparison:** A comparison between the number of parameters of the different models. We used the same CLIP model for all the base models which has 0.15B parameters.

## Appendices

### A ADDITIONAL EXAMPLES

In Figure 9 we demonstrate more examples of adding a new object to a scene. In Figure 10 we demonstrate the one-to-many generation ability of our model. In Figure 11 we demonstrate more examples of background replacement. In Figure 12 we demonstrate more examples of the effectiveness of our background reconstruction technique.

#### A.1 Interactive Editing

Because of the near-perfect background preservation of our method, the user is able to perform an interactive editing session: editing the image gradually s.t. at each stage of the editing session the user edits a different area within the image without changing the other parts of the image that were already edited. An example is demonstrated in Figure 14.

### B ADDITIONAL COMPARISONS

In this section we start by comparing the number of parameters of our model against the baselines and then add further examples from the GLIDE paper.

#### B.1 Parameters Comparison

In Table 3 we compare the number of parameters in our model to that of the following baselines: (1) Local CLIP-guided diffusion [Crowson 2021] (for more details see Avrahami et al. [2021]), (2) *PaintByWord++* [Bau et al. 2021; Crowson et al. 2022] (for more details see Avrahami et al. [2021]), (3) Blended Diffusion [Avrahami et al. 2021], (4) GLIDE [Nichol et al. 2021] and (5) GLIDE-filtered [Nichol et al. 2021]

#### B.2 Comparisons to all GLIDE versions

The results of the GLIDE method that were reported in Figure 7 were taken directly from the GLIDE paper [Nichol et al. 2021]. In their comparison, they noticed that their method sometimes chooses to ignore the given text prompt, so they have experimented with a version of their model that does not take into account the given image — by fully masking the context. As can be seen in Figure 15, using this approach, they manage to generate in the masked area, but it comes at the expense of the transition quality between the masked region and the background (e.g., the plate in the pizza example). Our method is able to generate a result that corresponds to the text in all the examples while being blended into the scene seamlessly.

## C IMPLEMENTATION DETAILS

Figure 16 shows a diagram graphically depicting our method, as described in Algorithm 1.

For all the experiments reported in this paper, the pretrained models that we have used are:

- Text-to-image Latent Diffusion model published by Rombach et al. [2021].
- CLIP model with ViT-B/16 backbone for the Vision Transformer [Dosovitskiy et al. 2020] that was released by Radford et al. [2021].
- Blended Diffusion model from Avrahami et al. [2021].
- GLIDE-filtered model from Nichol et al. [2021].

All these methods were released under MIT license and were implemented using PyTorch [Paszke et al. 2019].

All the input images in this paper are real images that were released freely under a Creative Commons license or from a private collection.

In the reconstruction methods described in Section 4.2 we used the following:

- For Poisson image blending [Pérez et al. 2003] we used the OpenCV [Bradski and Kaehler 2000] implementation.
- For latent optimization & weights optimization we used Adam optimizer [Kingma and Ba 2014] with a learning rate of 0.0001 for 75 optimization steps per image.

For the progressive mask shrinking described in Section 4.3 we used the following scheme: we dilated the downsampled mask  $m_{latent}$  with kernels of ones with sizes  $3 \times 3$ ,  $5 \times 5$  and  $7 \times 7$ , then we divided the diffusion process into four parts of the same length, and used the masks from the most dilated one till the original one.

### C.1 Precision & Diversity Metrics

As described in Section 5 we calculated precision and diversity metrics in order to compare our method against the baselines quantitatively. As was shown by Nichol et al. [2021], using CLIP model as an evaluator for text correspondence of images that were edited with models that use CLIP’s gradients for generation, is not correlated with human evaluation, because these models are susceptible to adversarial examples. Hence, because some of our baselines are using CLIP, we had to look for an alternative evaluation model. We opted to use a pre-trained ImageNet classifier, EfficientNet [Tan and Le 2019], as our backbone.

We took 50 random images from the web and local collection, then, for each image, we generated a random rectangular mask with dimensions that are in the range  $[\frac{dim}{5}, \frac{dim}{2}]$  where  $dim$  is the corresponding image dimension. Then, for each image-mask pair, we sample a random class from ImageNet classes and take the corresponding text label of that class as an input to our model. For each of the baseline models, we generate predictions of the advised batch size. An example of an input and its predictions by the various baselines can be seen in Figure 17.

To calculate the precision for each model, we go over all its predictions, mask them using the input mask, and feed the masked results to the ImageNet classifier. Because ImageNet contains many classes with semantically close meaning (e.g., several different species of



Fig. 9. **Adding a new object:** Additional examples for adding a new object within a scene.

dogs), we considered prediction as a good prediction if the ground-truth class label (the label of the class that was fed to the generative model) is in the top-5 predictions of the classification model. We calculate the average accuracy at the batch level for each input. In addition, we calculate the precision only on the top result that was ranked by the CLIP model as described in Section 4.4. Both of these metrics are reported in Table 1.

In order to calculate the diversity at the batch level, for each input triplet, we take only the images that were classified correctly by the classifier (because only these images are of interest to the end-user).

We then calculate the pairwise LPIPS [Zhang et al. 2018a] distance and take the average across all the batches.

## C.2 Ranking Effectiveness

As described in Section 4.4 in the main paper, we utilized CLIP model in order to rank the predictions of our method. As demonstrated in Figure 18, during our experiments we noticed that the top 20% are constantly better than the bottom 20%, but not in the resolution of a single image — the first image is not always strictly better than the second.

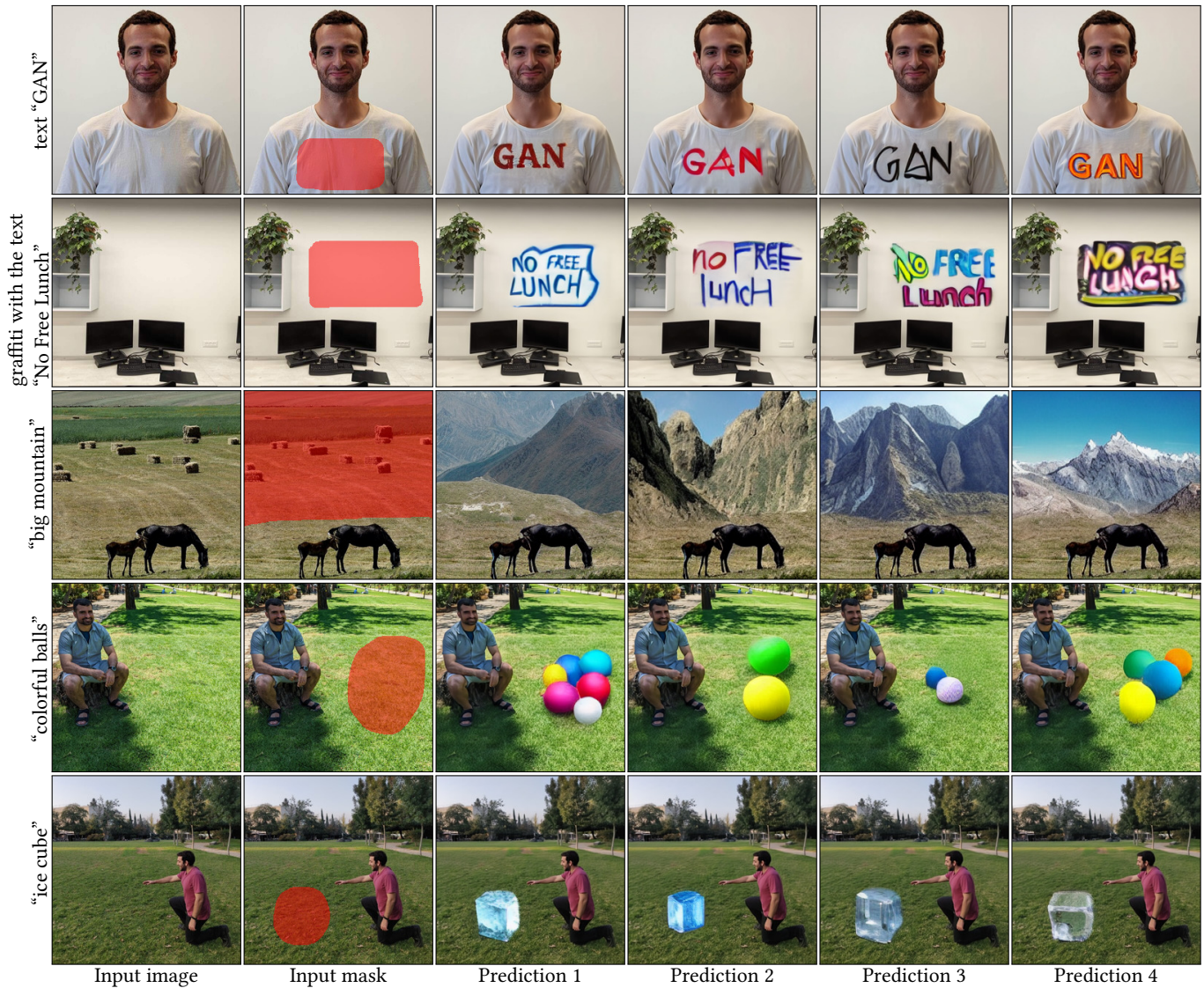

Fig. 10. **Multiple predictions:** Dealing with a one-to-many task, there is a need to generate multiple predictions.

## D SOCIETAL IMPACT

Lowering the barrier for content manipulations is a mixed blessing: on the one hand, it democratizes content creation, enhances creativity, and enables new applications. On the other hand, it can be used in a nefarious manner for generating fake news, harassing, bullying, and causing bad psychological and sociological effects [Fried et al. 2020]. In addition, the LDM model was trained on LAION-400M

dataset [Schuhmann et al. 2021] that consisted of 400M text-image pairs that were collected from the internet. This dataset is non-curated, and as such may contain discomforting and disturbing content that may be repeated by the model. In addition, it was shown [Nichol et al. 2021] that text-to-image generative models may inherit some of the biases in the training data, hence editing images guided by a text prompt may also suffer from this problem.



Fig. 11. **Replacing the background:** Additional examples for the background replacement capability of our model.

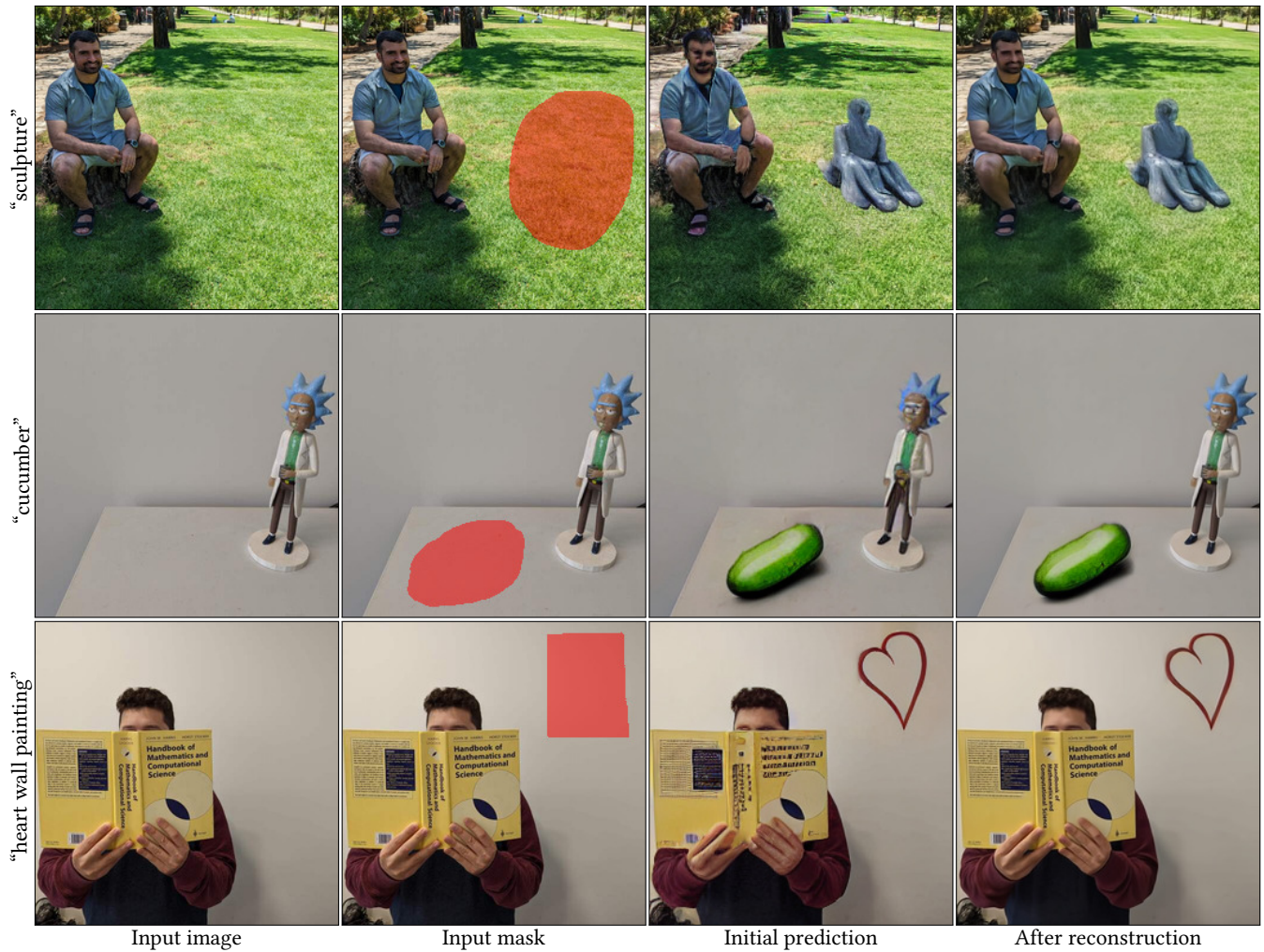

Fig. 12. **Background reconstruction:** Note the bad initial prediction of the high-frequency areas in the background: the human face in the first row, the doll face in the second row and the text on the book and the man's fingers in the third row (zoom in for a better presentation).

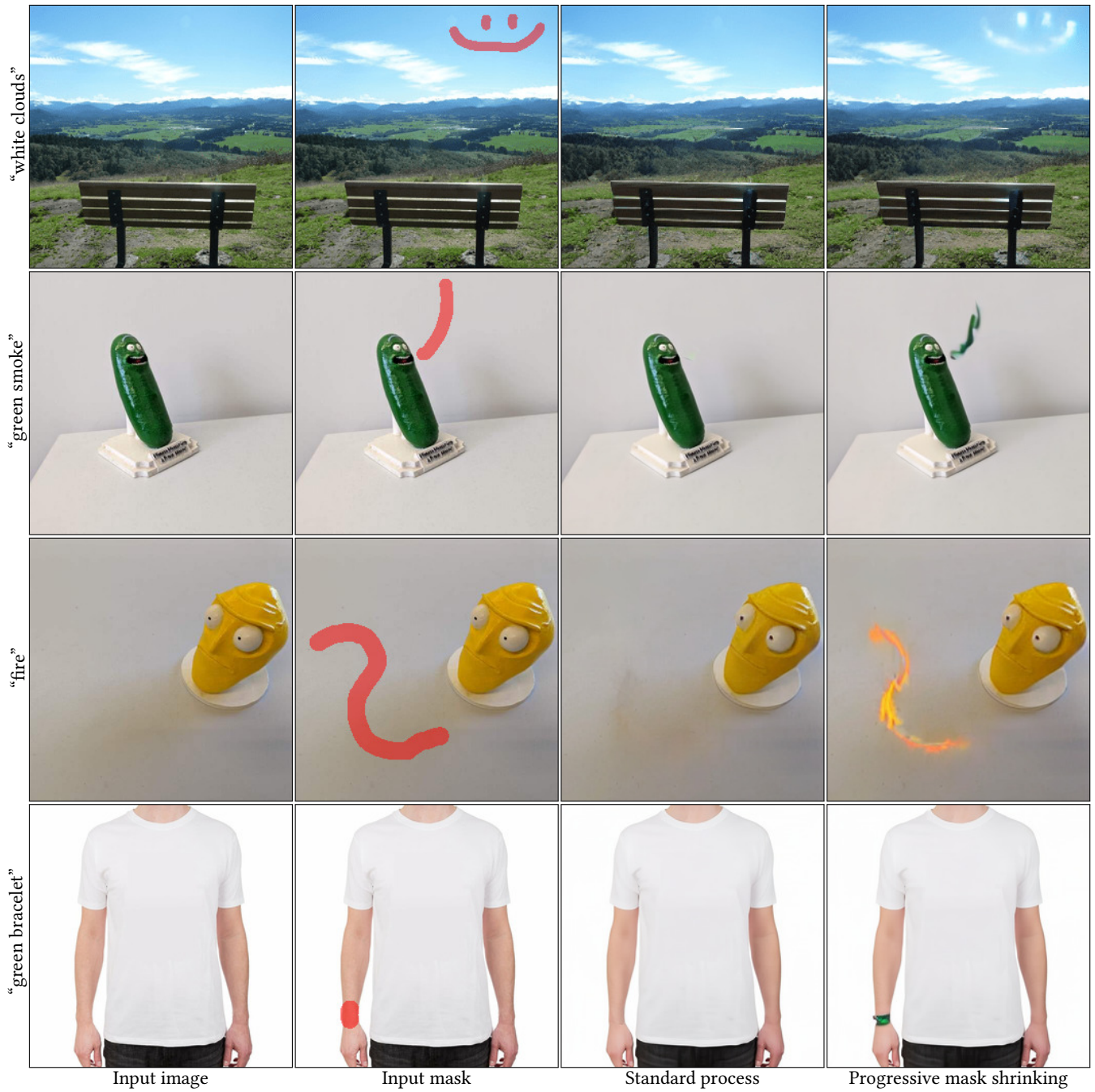

Fig. 13. **Thin masks:** An expanded version of Figure 6 .





Fig. 14. **Editing session:** The user is able to perform several edit operations consecutively. First, the user provides the input image, mask, and text prompt “a man with a green sweater” to get the first result, then, he masks the head area and provides the text prompt “a straw hat”, finally, he masks an area on the wall and provides the text “a window” to get the final result.

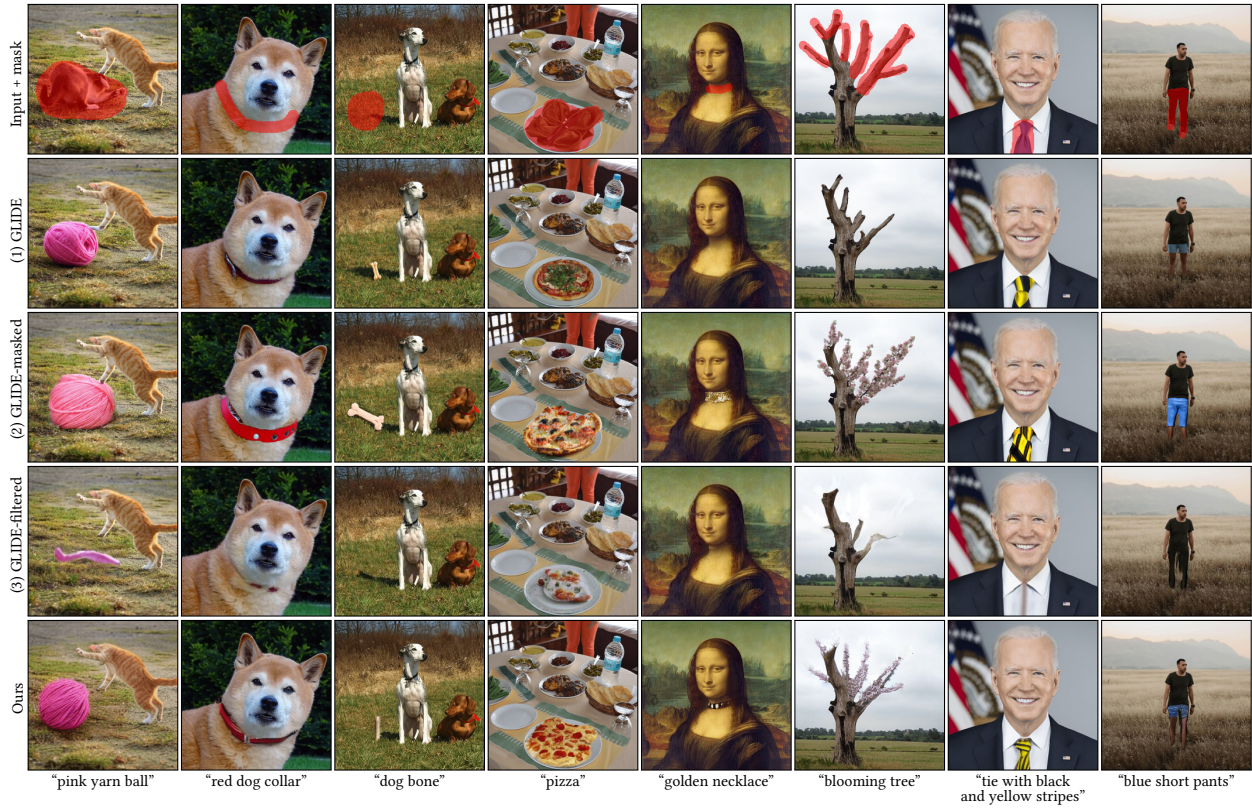

Fig. 15. **Comparison GLIDE:** We compared our method against all GLIDE versions: (1) is the original GLIDE implementation as described in their paper [Nichol et al. 2021], (2) a version of GLIDE that does not take into account the unmasked area, (3) a small version of GLIDE that was trained on a filtered dataset. As we can see, GLIDE (1) demonstrated better context cloning than GLIDE-masked (2), while GLIDE-masked has better correspondence to the text. Our method is able to generate a result that is corresponding to the text in all the examples while being blended into the scene seamlessly.

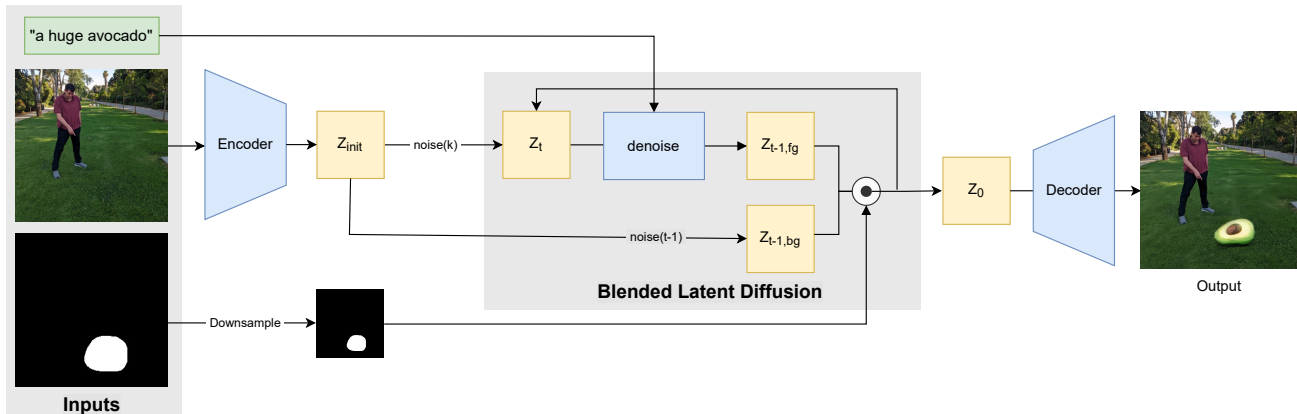

Fig. 16. **Blended Latent Diffusion:** a diagram illustrating our method that is written in Algorithm 1.



Fig. 17. **Precision & Diversity Experiment:** An example of a random image and mask, and the generated results, used in our quantitative evaluation.



Fig. 18. **Ranking effectiveness:** We generated 24 prediction results and ranked them using CLIP [Radford et al. 2021] model, during our experiments we noticed that the top 20% are constantly better than the bottom 20%, but not in the resolution of a single image — the first image is not always strictly better than the second.