

Formal Methods for Characterization and Analysis of Quality Specifications in Component-based Systems

Aritra Hazra

Department of Computer Science and Engineering, Indian Institute of Technology Kharagpur, India.

Abstract. Component-based design paradigm is of paramount importance due to prolific growth in the complexity of modern-day systems. Since the components are developed primarily by multi-party vendors and often assembled to realize the overall system, it is an onus of the designer to certify both the functional and non-functional requirements of such systems. Several of the earlier works concentrated on formally analyzing the behavioral correctness, safety, security, reliability and robustness of such compositional systems. However, the assurance for quality measures of such systems is also considered as an important parameter for their acceptance. Formalization of quality measures is still at an immature state and often dictated by the user satisfaction. This paper presents a novel compositional framework for reliable quality analysis of component-based systems from the formal quality specifications of its constituent components. The proposed framework enables elegant and generic computation methods for quality attributes of various component-based system structures. In addition to this, we provide a formal query-driven quality assessment and design exploration framework which enables the designer to explore various component structures and operating setups and finally converge into better acceptable systems. A detailed case-study is presented over a component-based system structure to show the efficacy and practicality of our proposed framework.

Keywords: Component-Based Systems, Specification, Quality, Reliability, Series-Parallel Composition.

1. Introduction

Component-based design engineering is of paramount importance across all engineering disciplines where complex systems can be obtained by assembling components as basic building blocks [13, 25, 27, 30]. Such paradigms are becoming prevalent due to increasing complexity of hardware and software systems and components requiring procurement from multi-party vendors for product completion. Components are design abstractions that ignore implementation details and are conceptualized formally using behavioral, interaction and execution models. These models are, then, hierarchically composed to build the overall system

Correspondence and offprint requests to: Aritra Hazra, Department of Computer Science and Engineering, Indian Institute of Technology Kharagpur, Paschim Medinipur, West Bengal, India, PIN – 721302. E-mail: aritrah@cse.iitkgp.ac.in

architecture where the formalism for the composite model is attributed from the notion of transfer functions, interfaces and contracts [1, 2, 6, 34]. Component-based engineering broadly involves model-based development of systems [33, 36], platform-based design methodologies [31] and developing software modules, supported by a large number of existing tools and standards, involving object-oriented languages (such as C++, System-C) and modeling languages (such as Stateflow/Statechart, UML, SysML) [5, 16, 17].

The computer scientists and researchers have responded to the challenge of designing complex systems adopting various formal methods and compositional algebra based frameworks [34, 35]. Typically, the component interactions and concurrency have been modeled formally using automated compositional reasoning and connector algebra [3, 4, 32]. With the wider adoption of such structured frameworks for system modeling, it also becomes a primary concern for the designers to ensure the correct operability of composite systems. Over the past few decades, model-based testing [37, 38] and model checking paradigms are explored to ensure the functional correctness, timing and safety behaviors [8, 9]. Additionally, several formal methods are proposed to enforce correct-by-construction approaches while designing system-level composite architectures [15, 29]. In recent times, the certification regime has also been extended towards formal assurance of the non-functional requirements as well, such as power [21, 22], reliability [14, 19, 20] and security [10, 18, 24], for component-based systems. Though the composition modeling is primarily formalized by the help of behavioral component models, formal component interactions and architectural properties, but there is a gap in modeling and assessment of system-level quality from the quality standards of its constituent components.

Quality measures of a system (often considered as a non-functional attribute) primarily reflects how perfectly an operation can be performed by the system and it is often attributed from the composed quality goals attained by its constituent components. It leads to the satisfaction of the users who are being serviced by the output of that system. A real-life example can be witnessed in case of video rendering (one can consider YouTube as an example) during the transmission/streaming where multiple levels of video quality can be produced. Typically, a high quality video input is being processed in multiple operating modes and the output video is produced in various quality levels depending on the bandwidth of the transmission and receiver channel. The two interesting non-functional behaviors in such a procedure is the reliability (or the availability) of the output video and also its quality parameters. The notion of reliability and availability in system design has been extensively studied [26]. However, at recent times, there is a growing need to incorporate the quality measures also into the main-stream formal system design process. The existing formalism for component-based rigorous system designs [34] do not consider into account quality attributes and associated specifications into their present modeling setup, hence the notion and formal treatment of quality measures in component-based systems are still remaining at a premature stage.

As per the best of our knowledge, there are very few works in formal system quality analysis. Some of the early works have subjectively quantified the notion of quality of systems and informally established the same by interaction of components and by following strict designing principles [7]. In embedded system design parlance, architectural quality assurance frameworks, leveraging naïve formal verification and model-based techniques, are formalized in [23, 28]. The notion of symbolic quality and its control was introduced in [11], where the authors propose an optimal quality schedule to ensure Quality-of-Service (QoS). On the same line, the work presented in [12] proposes a fine grain symbolic quality control method for multimedia applications using speed diagrams. The proposed methods takes as input an application software composed of actions, whose execution times are unknown increasing functions considering quality level parameters (considered as integers). The quality controller is able to compute adequate action schedules and choose pre-defined quality levels, in order to meet QoS requirements for a given platform. However, all these existing works do not provide the formal basis for designing and reasoning system involving component-level quality compositions; rather these methods invokes a quality manager to change action quality levels based on the knowledge of control constraints and finally computing a set of optimal schedules improving overall system performance.

Formal characterization of system quality has several deeper underpinnings in relation with the underlying system behavior. The choice of quality may have certain dependence with the system reliability, since some good quality component failure may degrade the overall quality of the system as well. So, formalizing the notions of quality should also incorporate the component-based system reliability formalism into its characterization. Existing literature provides several stand-alone techniques for calculating the reliability of systems based on symbolic/algebraic compositions of component-level reliability expressions from its given component structures [26]. However, there is a lack of effort in formally capturing quality measures for a design in similar terms, and thereby building a suitable framework to assess the compositional quality of component-based systems. This article is an enabler in this direction.

Formally, we define the quality of a component as a set of random variables each associated with a prob-

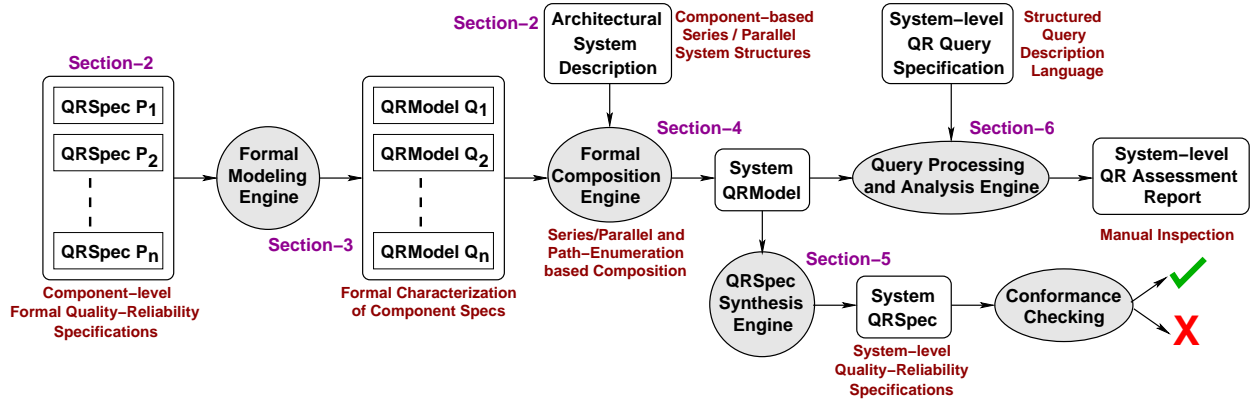

Fig. 1. The Overall Framework of Characterization and Assessment of Quality Specifications

ability value. We assume that for a given minimum input quality value/level, the corresponding minimum output quality value/level for any component is associated with a reliability value, which dictates its probability of successful execution without compromising the mentioned quality. The set of quality levels with different reliability values for a component arises due to a bound on limited execution time and cost of the component comprising the system [12]. Apart from the failure that can occur in a component structure, its operation can also be manually suspended by controlling it (for example, switching it off or executing it in a low functional/power modes) systematically. Such control of component suspension is very important at present context, considering the criticality of power, security and other performance criteria under restricted design setup. Clearly, a component has the output quality zero when its reliability is also zero (irrespective of input quality), meaning that failure is imminent, or its operation has been suspended (controlled). So, it is imperative to formulate algebra for component quality and reliability composition in order to reason about the quality of a system constructed hierarchically from set of component structures.

Given a set of formal quality and reliability specifications for a set of components, it is non-trivial to define the quality and reliability measures of the composite system structure. The composition is not similar to reliability analysis, since there is a choice here to maximize the overall quality during the compositional exploration considering the functional reliability of its constituent components (and their failures). This choice is complicated because there can be multiple ways during system execution to produce the range of quality expressions. For example, when several components, each having a set of quality specifications, are all connected in parallel, the overall quality measure of such a setup may be generated by – (i) computing the highest quality value/level among the operational components every time, (ii) assuming a pre-selected order among the operability of the constituent components, or (iii) reporting the quality from a fixed component (for simplicity) and the quality becomes zero when that component fails – thereby keeping the possibility for varied range of behavioral options. On the other hand, for series composition, the quality value is dictated by the series of components and becomes zero if any one of the components fails. Apart from such choices, the option to suspend/control the component execution in any operating mode brings inherent challenges in assessment of overall system quality attributes.

This work proposes novel methods for formal characterization and assessment of quality specifications for component-based systems that are built involving of series and parallel compositions of component structures at an architectural level. Figure 1 presents the overall flow (steps) of the work presented in this article. To start with, the component-level quality and reliability specifications (QRSPEC) are drafted, which are then formally characterized into a set of component-level QRModel. Next, depending on the system structure, a generic series and parallel composition algebra is followed to formally compose these component models into a composite system-level QRModel. Now, the system level (architectural) QRSpec can also be reverse-synthesized, which may help in – (i) understanding the non-functional performance boundaries (and extremities) of the system under various component-level operating conditions, and (ii) performing a conformance check with respect to the given system configuration, in case the system specifications are known a priori, to compare and know the functional coverage of the system. However, QRSpec only defines an abstraction in terms of specifying the underlying detailed QRModel of the system. Many other interesting observations can be gleaned from QRModel that are not reflected directly through QRSpec, and these will be useful for the designers, who

may want to explore various structures and combinations of available component to converge into the best possible system architecture. For that, the designer are given an option to formulate their queries over the system attributes systematically using a proposed structured query description language (SQDL), using which the information gets automatically extracted from the `QRModel` so that system-level quality and reliability (non-functional) assessments can be performed. In particular, the key contributions out of this work are:

- We define the specification formalism for component-level and system-level quality attributes.
- We introduce a uniform formal characterization of quality configurations for components and subsystems.
- We propose a novel series/parallel quality composition mechanism to hierarchically derive quality configurations for any given system architecture from its component-level quality models.
- We derive the (abstracted) system quality specification from the formal representation of system quality measures through reverse-synthesis to check for conformance and estimate coverage.
- We design a query-driven framework to aid designers for better system exploration and quality assessment.
- We provide a detailed case-study to show the efficacy and practicality of our proposed formal framework.

The rest of the paper is organized as follows¹. Section 2 describes the formal modeling of component-based systems and the notion of quality specifications for the components and subsystems. Section 3 presents the formal characterization of quality measures from quality specifications. Section 4 introduces the primitive composition techniques for series and parallel system structures and formulate generic composition principles for systems. Section 5 elaborates on the synthesis of quality specifications from formal models and conformance checking part. Section 6 proposes the query processing and analysis platform for system-level assessment and design exploration. Section 7 illustrates our proposed framework empirically over few case-studies of composite structures. Finally, Section 8 concludes the work presented in this article.

2. Formal Model and Specification

Component-based design approaches follow the development of an overall system starting from unit-level component structures and laying their specifications. In this section, we first formalize the description of such component-based systems and the notion of formal quality specifications.

2.1. Component-based Systems

Several components may be connected with each other in series and parallel structures to form a system. Formally, such a component-based system, Υ , can be expressed as,

$\Upsilon = \langle \mathcal{I}, \mathcal{O}, \mathcal{C}, \mathcal{V}, \mathcal{E}, \mathcal{L} \rangle$, where:

- $\mathcal{I} = \{I_1, I_2, \dots, I_u\}$ denotes the set of u input nodes of the system.
- $\mathcal{O} = \{O_1, O_2, \dots, O_v\}$ denotes the set of v output nodes of the system.
- $\mathcal{C} = \{C_1, C_2, \dots, C_n\}$ denotes the set of n components of the system, where each component C_i (with a single input and single output) has their own non-functional specification, \mathcal{P}_i (defined in next subsection).
- $\mathcal{V} = \{V_1, V_2, \dots, V_z\}$ denotes the set of z vertices ($z \geq n$).
- $\mathcal{E} \subseteq (\mathcal{I} \cup \mathcal{V}) \times (\mathcal{V} \cup \mathcal{O})$ denotes the set of edges representing the connectors among the vertices including the input/output nodes of the system.
- $\mathcal{L} : \mathcal{V} \rightarrow \mathcal{C}$ is a function that labels each vertices with a component. There may be multiple vertices labeled with a same component indicating that the component is used in multiple places in the system.

The following example of a component-based system illustrates the above mentioned formalism in details.

Example 1. Consider the example of a series/parallel component-based system, Υ_{sp} , given in Figure 2. Here, $\mathcal{C} = \{C_1, C_2, C_3\}$, $\mathcal{I} = \{I_1\}$ and $\mathcal{O} = \{O_1\}$. The overall system architecture can be represented using a directed acyclic graph with the set of vertices, $\mathcal{V} = \{V_1, V_2, V_3, V_4\}$, and the set of edges, $\mathcal{E} = \{(I_1, V_1); (I_1, V_2); (I_1, V_3); (V_3, V_4); (V_1, O_1); (V_2, O_1); (V_4, O_1)\}$. Moreover, the vertices are labeled using three components forming the system architecture as, $\mathcal{L}(V_1) = C_1$, $\mathcal{L}(V_2) = C_2$, $\mathcal{L}(V_3) = C_3$, and $\mathcal{L}(V_4) = C_2$. \square

¹ Sections are also highlighted in Figure 1 to provide a meaningful organization to this article.

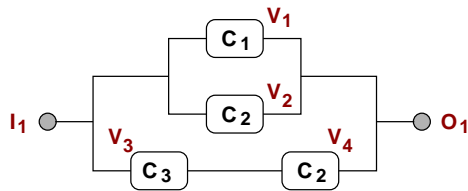

Fig. 2. Component-based System Structure, Υ_{sp} , having Series and Parallel Component Organization

A few pertinent points to note here are as follows.

- The series and parallel system structure is useful in designing many safety-critical systems where the same input-output design functionality can get realized via redundant parallel paths in order to tolerate some intermediate component failures. Typically, the functionalities from a set of parallel executions/paths are converged using a voting mechanism (choosing consistent outcomes from m -out-of- n paths). For example, in Figure 2, three parallel paths, i.e. via C_1 , via C_2 , or via $C_3 - C_2$, may yield the same input-output functionality, though their way of implementation may vary (due to procurement of each component from different sources). From a functional perspective, we may vote and produce output by taking consistent outcomes from 2-out-of-3 paths². However, whenever the parallel paths converge, the overall output quality may come from either choosing the maximum quality across all paths, or choosing quality values from some pre-defined ordering of paths (we discuss this in details in the following sections). Further, we assume that the voting component is fully reliable and do not degrade the quality parameters while bypassing through it. In practical cases, we can take quality and reliability specifications also for the voter and treat it like another component being placed in series whenever a set of parallel paths converge.
- When the same component is placed in multiple positions of the overall system, it indicates different instantiation (in case of hardware systems) or different invocations (in case of software systems) of the same object (defined once). So, going by this analogy, in Figure 2, where there is two installation of same component C_2 , if C_2 fails, then the operating probability of C_2 becomes 0 and hence two paths ($I_1 \rightarrow V_3 \rightarrow V_4 \rightarrow O_1$ and $I_1 \rightarrow V_2 \rightarrow O_1$) fail together (out of three possible) from input to output.
- On the other hand, whenever there is a need to place a duplicate but identical component in the other places, a different component name (with same specifications though) needs to be used in every other constellations. For example, it may be the case in Figure 2 that C_1 and C_3 are identical components in terms of their functionality, but separately defined.
- In practical conditions, sometimes to save power and other design overhead, some redundant components may be *suspended or switched off* (usually controlled by the designer). Component failure and suspension are different, because in first case, if the component has an operating reliability of r , then it has its failure probability of $(1-r)$; whereas the latter makes the component to bypass assuming a reliability of 1 for the suspended component. For example, in Figure 2, if we suspend C_3 , then the path via $I_1 \rightarrow V_3 \rightarrow V_4 \rightarrow O_1$ is blocked due to suspension of C_3 , but C_3 will have reliability as 1.

2.2. Quality and Reliability Specifications

Typically, in component-based system design, the quality and reliability attributes, often known as *non-functional* requirements, are laid from an architectural level of the system and are analyzed over the system structures. We term such non-functional quality and reliability specifications as **QRSpec**. First, let us formally define such a high-level **QRSpec** of a component as well as an overall system.

2.2.1. Component-level Specifications

Every unit-level component within a system operates in multiple modes (each mode having a given operational reliability value between $[0, 1]$) provided it does not undergo any failure³. Now, corresponding to every

² To reduce clutter and without loss of generality, we have not explicitly shown the voting component in the system structure.

³ We treat component failure also as an operational mode with reliability being 0.

quality level of the input for a component, it produces the output in some defined quality levels depending on its mode of operation. Formally, we represent the **QRSpec** for a unit-level component, C_i , as:

$$\mathcal{P}_i = \langle \{C_i\}, M_i, Z_i, Q_i^I, Q_i^O \rangle, \quad \text{where:}$$

- $\{C_i\}$ is the participating component.
 - $M_i = \{m_i^0, m_i^1, m_i^2, \dots, m_i^{d_i}\}$, denotes the set of $(d_i + 1)$ operational modes of C_i including m_i^0 as the failure mode ($d_i \in \mathbb{N}$).
 - $Z_i : M_i \rightarrow \mathbb{R}^{[0,1]}$, is a function that associates a reliability value (within $[0, 1]$) to each operational mode of the component. Here, $Z_i(m_i^0) = 0$ and $\forall k (1 \leq k \leq d_i), Z_i(m_i^k) > 0$.
 - $Q_i^I = \{q_i^1, q_i^2, \dots, q_i^{l_i}\}$, denotes the set of l_i non-negative input quality values (or levels), where $\forall j (1 \leq j < l_i), q_i^j \in \mathbb{R}^+$ and $q_i^j > q_i^{j+1}$.
 - $Q_i^O : M_i \times Q_i^I \rightarrow \mathbb{R}^+$, is a function that maps each input quality level to an output quality (a non-negative real number) corresponding to every operational modes.
- It may be noted that, $\forall k (1 \leq k \leq d_i), \forall j (1 \leq j \leq l_i), Q_i^O(m_i^k, q_i^j) \leq q_i^j$ and $Q_i^O(m_i^0, q_i^j) = 0$, as m_i^0 indicates the mode where C_i failed completely. Moreover, if the input quality (q) falls below $q_i^{l_i}$, then the output quality becomes zero, i.e. $Q_i^O(m_i^k, q) = 0$, when $q < q_i^{l_i}$.

Here, every operating mode for a component has a reliability and can produce different quality output values based on given input quality ranges. The following example illustrates the component **QRSpec** formalism.

Example 2. Let the **QRSpec** for a component, C_1 , is given as, $\mathcal{P}_1 = \langle M_1, Z_1, Q_1^I, Q_1^O \rangle$, where:

- C_1 operates in two operational modes along with a permanent failure mode. Therefore, $M_1 = \{m_1^0, m_1^1, m_1^2\}$.
 - The operational reliability values are, $Z_1(m_1^1) = 0.8$, $Z_1(m_1^2) = 0.7$, and $Z_1(m_1^0) = 0$.
 - The input quality levels are specified as, $Q_1^I = \{50, 30, 20\}$.
 - The corresponding output quality values are, $Q_1^O(m_1^1, 50) = 40$, $Q_1^O(m_1^1, 30) = 25$, $Q_1^O(m_1^1, 20) = 10$ and $Q_1^O(m_1^2, 50) = 35$, $Q_1^O(m_1^2, 30) = 25$, $Q_1^O(m_1^2, 20) = 10$.
- It intuitively means that, the output quality levels maintained by C_1 at mode m_1^1 are at least 40, 25 and 10 when the input quality value is at least 50, within $[30, 50)$ and within $[10, 30)$, respectively. Implicitly, for any $q \in \mathbb{R}^+$, $Q_1^O(m_1^0, q) = 0$ and when $q < 20$, $Q_1^O(m_1^1, q) = 0$ and $Q_1^O(m_1^2, q) = 0$.

Similarly, let the quality specification for C_2 is given as, $\mathcal{P}_2 = \langle M_2, Z_2, Q_2^I, Q_2^O \rangle$, where: $M_2 = \{m_2^0, m_2^1\}$; $Z_2(m_2^1) = 0.95$ and $Z_2(m_2^0) = 0$; $Q_2^I = \{40, 10\}$; $Q_2^O(m_2^1, 40) = 30$ and $Q_2^O(m_2^1, 10) = 10$.

Also, let the quality specification for C_3 , is given as, $\mathcal{P}_3 = \langle M_3, Z_3, Q_3^I, Q_3^O \rangle$, where: $M_3 = \{m_3^0, m_3^1, m_3^2\}$; $Z_3(m_3^1) = 0.9$, $Z_3(m_3^2) = 0.8$ and $Z_3(m_3^0) = 0$; $Q_3^I = \{50, 20, 10\}$; $Q_3^O(m_3^1, 50) = 45$, $Q_3^O(m_3^1, 20) = 20$, $Q_3^O(m_3^1, 10) = 5$ and $Q_3^O(m_3^2, 50) = 40$, $Q_3^O(m_3^2, 20) = 15$, $Q_3^O(m_3^2, 10) = 5$. \square

2.2.2. System-level Specifications

A system architecture is built using a set of inter-connected components which are glued with each other in a series/parallel manner. Formally, we define the **QRSpec** for an overall system, Υ , as⁴:

$$\mathcal{P}_\Upsilon = \langle C_\Upsilon, M_\Upsilon, Z_\Upsilon, Q_\Upsilon^I, Q_\Upsilon^O \rangle, \quad \text{where:}$$

- $C_\Upsilon = \{C_1, C_2, \dots, C_n\}$, is the set of n components used to form the system, Υ .
The quality specification for each component, $C_i (1 \leq i \leq n)$, is denoted by, $\mathcal{P}_i = \langle M_i, Z_i, Q_i^I, Q_i^O \rangle$.
- $M_\Upsilon = (M_1 \times M_2 \times \dots \times M_n)$, denotes the set of d_Υ operational modes of Υ , where each mode is an n -tuple and hence $d_\Upsilon = \prod_{i=1}^n (d_i + 1)$.
- $Z_\Upsilon : M_\Upsilon \rightarrow \mathbb{R}^{[0,1]}$, is a function that associates a reliability value (within $[0, 1]$) to each operational mode of the system.

⁴ It may be noted that, component-level **QRSpec** can also be viewed as a system-level **QRSpec** where $C_\Upsilon = \{C_i\}$, i.e., the system, Υ , comprises of a single component, C_i . Hence, from the next section onwards, we do not differentiate between component and system as such, since their formal modeling and treatment remains uniform.

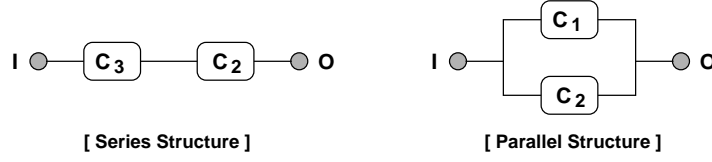

Fig. 3. (a) 2-Component Series System, Υ_S (b) 2-Component Parallel System, Υ_P

System Mode	Reliability	Input Quality	Output Quality
$m_{\Upsilon_S}^0 \equiv (m_3^0, m_2^0)$	0.000	$\langle 0 \rangle$	$\langle 0 \rangle$
$m_{\Upsilon_S}^1 \equiv (m_3^1, m_2^1)$	0.000	$\langle 0 \rangle$	$\langle 0 \rangle$
$m_{\Upsilon_S}^2 \equiv (m_3^2, m_2^2)$	0.000	$\langle 0 \rangle$	$\langle 0 \rangle$
$m_{\Upsilon_S}^3 \equiv (m_3^1, m_2^1)$	0.855	$\langle 50, 20 \rangle$	$\langle 30, 10 \rangle$
$m_{\Upsilon_S}^4 \equiv (m_3^2, m_2^2)$	0.000	$\langle 0 \rangle$	$\langle 0 \rangle$
$m_{\Upsilon_S}^5 \equiv (m_3^2, m_2^1)$	0.760	$\langle 50, 20 \rangle$	$\langle 30, 10 \rangle$

Table 1. Mode-wise Reliability and Quality Values for Υ_S

System Mode	Reliability	Input Quality	Output Quality
$m_{\Upsilon_P}^0 \equiv (m_1^0, m_2^0)$	0.000	$\langle 0 \rangle$	$\langle 0 \rangle$
$m_{\Upsilon_P}^1 \equiv (m_1^1, m_2^1)$	0.950	$\langle 40, 10 \rangle$	$\langle 30, 10 \rangle$
$m_{\Upsilon_P}^2 \equiv (m_1^1, m_2^0)$	0.800	$\langle 50, 30, 20 \rangle$	$\langle 40, 25, 10 \rangle$
$m_{\Upsilon_P}^3 \equiv (m_1^1, m_2^1)$	0.990	$\langle 50, 40, 30, 10 \rangle$	$\langle 40, 30, 25, 10 \rangle$
$m_{\Upsilon_P}^4 \equiv (m_1^2, m_2^0)$	0.700	$\langle 50, 30, 20 \rangle$	$\langle 35, 25, 10 \rangle$
$m_{\Upsilon_P}^5 \equiv (m_1^2, m_2^1)$	0.985	$\langle 50, 40, 30, 10 \rangle$	$\langle 35, 30, 25, 10 \rangle$

Table 2. Mode-wise Reliability and Quality Values for Υ_P

- $Q_{\Upsilon}^I \subseteq \bigcup_{i=1}^n Q_i^I$, denotes the set of non-negative input quality values (levels);
- $Q_{\Upsilon}^O : M_{\Upsilon} \times Q_{\Upsilon}^I \rightarrow \mathbb{R}^+$, is a function that maps each input quality level to an output quality (a non-negative real number) for every operational modes.

The following example demonstrates the **QRSpec** of two elementary systems, Υ_P and Υ_S , each having two components connected simply in parallel and series, respectively.

Example 3. First, let us consider another elementary system, Υ_S , comprised of two components, C_2 and C_3 (as introduced in Example 2), where C_2 is connected with C_3 in series (refer to Figure 3(a)). Now, the **QRSpec** for Υ_S is given as, $\mathcal{P}_{\Upsilon_S} = \langle C_{\Upsilon_S}, M_{\Upsilon_S}, Z_{\Upsilon_S}, Q_{\Upsilon_S}^I, Q_{\Upsilon_S}^O \rangle$, where:

- The participating components are, $C_{\Upsilon_S} = \{C_2, C_3\}$ with **QRSpec**, \mathcal{P}_2 and \mathcal{P}_3 , respectively.
- The *three* operational modes of Υ_S are, $M_{\Upsilon_S} = \{m_{\Upsilon_S}^0, m_{\Upsilon_S}^1, m_{\Upsilon_S}^2\}$, where:

$$m_{\Upsilon_S}^0 \equiv (m_3^0, m_2^0) \equiv (m_3^0, m_2^1) \equiv (m_3^1, m_2^0) \equiv (m_3^2, m_2^0), \quad m_{\Upsilon_S}^1 \equiv (m_3^1, m_2^1), \quad m_{\Upsilon_S}^2 \equiv (m_3^2, m_2^1).$$

Effectively, only two modes, (m_3^1, m_2^1) and (m_3^2, m_2^1) , are non-failure (operating) modes and the rest are all failure modes.

- Since C_2 and C_3 are in series, so the reliability corresponding to every mode of M_{Υ_S} is computed as, $Z_{\Upsilon_S}((m_3^j, m_2^k)) = Z_1(m_3^j) \cdot Z_2(m_2^k)$ ($0 \leq j \leq 2$ and $0 \leq k \leq 1$) and shown in Table 1.
- The input quality levels are, $Q_{\Upsilon_S}^I = \{50, 20\}$ (due to series connected components).
- The output quality value function ($Q_{\Upsilon_S}^O$), with respect to the input quality values/levels for every operational mode of Υ_S is also given in Table 1⁵.

Now, let us consider an elementary system, Υ_P , comprised of two components, C_1 and C_2 (as introduced in Example 2), where C_1 is connected with C_2 in parallel (refer to Figure 3(b)). Now, the **QRSpec** for Υ_P is given as, $\mathcal{P}_{\Upsilon_P} = \langle C_{\Upsilon_P}, M_{\Upsilon_P}, Z_{\Upsilon_P}, Q_{\Upsilon_P}^I, Q_{\Upsilon_P}^O \rangle$, where:

- The participating components are, $C_{\Upsilon_P} = \{C_1, C_2\}$ with **QRSpec**, \mathcal{P}_1 and \mathcal{P}_2 , respectively.
- The *six* operational modes of Υ_P are, $M_{\Upsilon_P} = \{m_{\Upsilon_P}^0, m_{\Upsilon_P}^1, m_{\Upsilon_P}^2, m_{\Upsilon_P}^3, m_{\Upsilon_P}^4, m_{\Upsilon_P}^5\}$, where:

$$m_{\Upsilon_P}^0 \equiv (m_1^0, m_2^0), \quad m_{\Upsilon_P}^1 \equiv (m_1^0, m_2^1), \quad m_{\Upsilon_P}^2 \equiv (m_1^1, m_2^0), \quad m_{\Upsilon_P}^3 \equiv (m_1^1, m_2^1), \quad m_{\Upsilon_P}^4 \equiv (m_1^2, m_2^0), \quad m_{\Upsilon_P}^5 \equiv (m_1^2, m_2^1).$$

⁵ To intuitively explain (detailed methodology is presented later) the last row of Table 1, note that the system mode, $m_{\Upsilon_S}^2 \equiv (m_3^2, m_2^1)$, is dictated by the operating modes of C_3 and C_2 . The output quality values corresponding to input quality level *at least* 50 and *within* [20, 50] can be computed as, $Q_{\Upsilon_S}^O((m_3^2, m_2^1), 50) = Q_2^O(m_2^1, Q_3^O(m_3^2, 50)) = Q_2^O(m_2^1, 40) = 30$, and similarly, $Q_{\Upsilon_S}^O((m_3^2, m_2^1), 20) = Q_2^O(m_2^1, Q_3^O(m_3^2, 20)) = Q_2^O(m_2^1, 15) = Q_2^O(m_2^1, 10) = 10$ (since C_2 is placed after C_3 in series).

- Since C_1 and C_2 are in parallel, so the reliability corresponding to every mode of M_{Υ_P} is computed as, $Z_{\Upsilon_P}((m_1^j, m_2^k)) = \left[1 - (1 - Z_1(m_1^j)) \cdot (1 - Z_2(m_2^k))\right]$ ($0 \leq j \leq 2$ and $0 \leq k \leq 1$) and shown in Table 2.
- The input quality levels are, $Q_{\Upsilon_P}^I = \{50, 40, 30, 20, 10\}$ (due to parallel connected components).
- The output quality value function ($Q_{\Upsilon_P}^O$), with respect to the input quality values/levels for every operational mode of Υ_P is also given in Table 2⁶. \square

It is worthy to note here is that, the architectural **QRSpec** of a system derives its operating modes and quality-reliability attributes with respect to component failures as well as component suspensions. Though the above example only deals with component failures (not provisionize component suspensions), however as pointed at the end of Section 2.1 (and also in Section 1), the designer may explore various quality attributes of a system also involving suspended components. Exploration of such orchestrations in component behaviors needs a generic compositional framework through which one can automatically derive out the system-level **QRSpec** from the **QRSpec** of its component modules involving both failure and suspended components. In subsequent sections, we present the generic procedures to formally derive system-level **QRSpec** from component **QRSpec**.

3. Formal Characterization of Quality Configurations

In this section, we present a formal characterization of the system-level *quality measures* under various operating configurations of its constituent components as state transition models, also termed as **QRModel**, which enables further compositional interpretation of the **QRSpec**. Formally, we characterize the quality measure under different operating configurations of a subsystem, Υ (having one or more components), with the **QRSpec**, $\mathcal{P}_\Upsilon = \langle C_\Upsilon, M_\Upsilon, Z_\Upsilon, Q_\Upsilon^I, Q_\Upsilon^O \rangle$, in terms of the following **QRModel** as,

$$\mathcal{Q}_\Upsilon = \langle C_\Upsilon, Q_\Upsilon^I, R_\Upsilon, S_\Upsilon, s_\Upsilon^1, \Gamma_\Upsilon, Q_\Upsilon^O, T_\Upsilon, \text{Expr}_\Upsilon \rangle, \quad \text{where:}$$

- $C_\Upsilon = \{C_1, C_2, \dots, C_n\}$ is the ordered set of n participating components in the system, Υ .
- $Q_\Upsilon^I = \{q_\Upsilon^1, q_\Upsilon^2, \dots, q_\Upsilon^{l_\Upsilon}\}$, denotes the set of l_Υ non-negative input quality values (or levels), where $\forall j$ ($1 \leq j < l_\Upsilon$), $q_\Upsilon^j \in \mathbb{R}^+$ and $q_\Upsilon^j > q_\Upsilon^{j+1}$.
- $R_\Upsilon = \{r_{\Upsilon,1}, r_{\Upsilon,2}, \dots, r_{\Upsilon,e_\Upsilon}\}$ is the set of $e_\Upsilon (= \sum_{i=1}^n d_i)$ symbolic reliability variables, such that each $r_{\Upsilon,k}$, corresponding to the operating mode m_y^t of C_y , has the reliability value of $Z_y(m_y^t)$, where $1 \leq \sum_{i=1}^{y-1} d_i < k \leq \sum_{i=1}^y d_i \leq e_\Upsilon$ and $t = k - \sum_{i=1}^{y-1} d_i$.
- $S_\Upsilon = \{s_\Upsilon^1, s_\Upsilon^2, \dots, s_\Upsilon^{n_\Upsilon}\}$ is the set of n_Υ operational states characterizing the quality measures. Here, $n_\Upsilon = \prod_{i=1}^n (2^{d_i+1} - 1)$, where each C_i can operate in d_i number of modes ($1 \leq i \leq n$).
- $s_\Upsilon^1 \in S_\Upsilon$ is the start/initial operating state.
- $\Gamma_\Upsilon : S_\Upsilon \rightarrow \{1, 0, X, Y\}^{e_\Upsilon}$ denotes the e_Υ -length configuration function of a state corresponding to d_Υ operational modes in M_Υ (excluding failure mode, $m_\Upsilon^0 \in M_\Upsilon$, which can be expressed as the state having all 0's in the e_Υ -length configuration). Here, $e_\Upsilon = \sum_{i=1}^n d_i$, where d_i is the number of operating modes (excluding the failure mode) of C_i ($1 \leq i \leq n$). Typically, C_i shall execute in the operating mode, m_i^j , when all modes m_i^k ($1 \leq k < j \leq d_i$) have failed.

For a state, $s_\Upsilon^j \in S_\Upsilon$, $\Gamma_\Upsilon(s_\Upsilon^j)[k] \in \{1, 0, X, Y\}$ and $\Gamma_\Upsilon(s_\Upsilon^j)[k..k'] \in \{1, 0, X, Y\}^{(k'-k+1)}$ ($1 \leq k < k' \leq e_\Upsilon$) represent the k^{th} and k -to- k' configuration location(s) of s_Υ^j , respectively. Formally,

$$\Gamma_\Upsilon(s_\Upsilon^j)[k] = \begin{cases} 1, & \text{indicating } C_y \text{ is operating in mode } m_y^t \\ 0, & \text{indicating } C_y \text{ is has failed in mode } m_y^t \\ X, & \text{indicating } C_y \text{ is not availing mode } m_y^t \\ Y, & \text{indicating } C_y \text{ has suspended mode } m_y^t \end{cases} \quad \text{where } 1 \leq \sum_{i=1}^{y-1} d_i < k \leq \sum_{i=1}^y d_i \leq e_\Upsilon \text{ and } t = k - \sum_{i=1}^{y-1} d_i$$

⁶ To intuitively explain (detailed methodology is presented later) the last row of Table 2, note that the system mode, $m_{\Upsilon_P}^5 \equiv (m_1^2, m_2^1)$, is dictated by the operating modes of C_1 and C_2 . The (best possible) output quality value with respect to input quality level *at least* 40 can be computed as, $Q_{\Upsilon_P}^O((m_1^2, m_2^1), 40) = \text{MAX}[Q_1^O(m_1^2, 40), Q_2^O(m_2^1, 40)] = \text{MAX}[Q_1^O(m_1^2, 30), Q_2^O(m_2^1, 40)] = \text{MAX}[25, 30] = 30$. Similarly, we can also find all the (best possible) output quality values, 35, 30, 25 and 10 for the corresponding input quality values, which are *at least* 50, *within* [40, 50), *within* [30, 40) and *within* [10, 30), respectively.

Additionally, when $\Gamma_{\Upsilon}(s_{\Upsilon}^j)[k] = 1$, we have, $\Gamma_{\Upsilon}(s_{\Upsilon}^j)[k'] = 0/Y$ ($\forall k'$ such that $(\sum_{i=1}^{y-1} d_i) < k' < k$), and $\Gamma_{\Upsilon}(s_{\Upsilon}^j)[k''] = X$ ($\forall k''$ such that $k < k'' \leq (\sum_{i=1}^y d_i)$). Moreover, $\Gamma_{\Upsilon}(s_{\Upsilon}^j) \equiv \Gamma_{\Upsilon}(s_{\Upsilon}^j)[1..e_{\Upsilon}]$.

- $Q_{\Upsilon}^O : S_{\Upsilon} \times Q_{\Upsilon}^I \rightarrow \mathbb{R}^+$, is a function that maps each input quality level to an output quality (a non-negative real number) corresponding to every operational modes.

It may be noted that, $\forall k$ ($1 \leq k \leq n_{\Upsilon}$), $\forall j$ ($1 \leq j \leq l_{\Upsilon}$), $Q_{\Upsilon}^O(s_{\Upsilon}^k, q_{\Upsilon}^j) \leq q_{\Upsilon}^j$ and $Q_{\Upsilon}^O(s, q_{\Upsilon}^j) = Q_{\Upsilon}^O(s', q_{\Upsilon}^j) = 0$, whenever $\Gamma_{\Upsilon}(s) = 0^{e_{\Upsilon}}$ and $\Gamma_{\Upsilon}(s') = Y^{e_{\Upsilon}}$ indicating the operating modes where C_{Υ} completely failed or fully suspended, respectively. Moreover, if the input quality (q) falls below $q_{\Upsilon}^{l_{\Upsilon}}$, then the output quality becomes zero, i.e. $Q_{\Upsilon}^O(s_{\Upsilon}^k, q) = 0$, whenever $q < q_{\Upsilon}^{l_{\Upsilon}}$.

- $T_{\Upsilon} = T_{\Upsilon}^F \cup T_{\Upsilon}^C$ denotes the set of transitions from one state to another and $T_{\Upsilon} \subseteq S_{\Upsilon} \times S_{\Upsilon}$. T_{Υ}^F and T_{Υ}^C are the transitions indicating *failure* and *suspension* of an operating mode, respectively.

- The transition, $T_{\Upsilon}^F(s_{\Upsilon}^j, s_{\Upsilon}^k)$, from the state $s_{\Upsilon}^j \in S_{\Upsilon}$ to the state $s_{\Upsilon}^k \in S_{\Upsilon}$ ($1 \leq j, k \leq n_{\Upsilon}$) is *permissible* only when either of the following two conditions happen:

(a) $\exists w'$ ($1 \leq w' \leq e_{\Upsilon}$), such that $\Gamma_{\Upsilon}(s_{\Upsilon}^j)[w'] = 1$ and $\Gamma_{\Upsilon}(s_{\Upsilon}^k)[w'] = 0$, whereas $\forall w$ ($1 \leq w \leq e_{\Upsilon}$ and $w \neq w'$), $\Gamma_{\Upsilon}(s_{\Upsilon}^j)[w] = \Gamma_{\Upsilon}(s_{\Upsilon}^k)[w]$.

(b) $\exists w'$ ($2 \leq w' \leq e_{\Upsilon}$), such that $\Gamma_{\Upsilon}(s_{\Upsilon}^j)[w' - 1] = 1$, $\Gamma_{\Upsilon}(s_{\Upsilon}^j)[w'] = X$ and $\Gamma_{\Upsilon}(s_{\Upsilon}^k)[w' - 1] = 0$, $\Gamma_{\Upsilon}(s_{\Upsilon}^k)[w'] = 1$, whereas $\forall w$ ($1 \leq w \leq e_{\Upsilon}$ and $w \neq w'$ or $w \neq w' - 1$), $\Gamma_{\Upsilon}(s_{\Upsilon}^j)[w] = \Gamma_{\Upsilon}(s_{\Upsilon}^k)[w]$.

- The transition, $T_{\Upsilon}^C(s_{\Upsilon}^j, s_{\Upsilon}^k)$, from the state $s_{\Upsilon}^j \in S_{\Upsilon}$ to the state $s_{\Upsilon}^k \in S_{\Upsilon}$ ($1 \leq j, k \leq n_{\Upsilon}$) is *permissible* only when either of the following two conditions happen:

(a) $\exists w'$ ($1 \leq w' \leq e_{\Upsilon}$), such that $\Gamma_{\Upsilon}(s_{\Upsilon}^j)[w'] = 1$ and $\Gamma_{\Upsilon}(s_{\Upsilon}^k)[w'] = Y$, whereas $\forall w$ ($1 \leq w \leq e_{\Upsilon}$ and $w \neq w'$), $\Gamma_{\Upsilon}(s_{\Upsilon}^j)[w] = \Gamma_{\Upsilon}(s_{\Upsilon}^k)[w]$.

(b) $\exists w'$ ($2 \leq w' \leq e_{\Upsilon}$), such that $\Gamma_{\Upsilon}(s_{\Upsilon}^j)[w' - 1] = 1$, $\Gamma_{\Upsilon}(s_{\Upsilon}^j)[w'] = X$ and $\Gamma_{\Upsilon}(s_{\Upsilon}^k)[w' - 1] = Y$, $\Gamma_{\Upsilon}(s_{\Upsilon}^k)[w'] = 1$, whereas $\forall w$ ($1 \leq w \leq e_{\Upsilon}$ and $w \neq w'$), $\Gamma_{\Upsilon}(s_{\Upsilon}^j)[w] = \Gamma_{\Upsilon}(s_{\Upsilon}^k)[w]$.

- Expr_{Υ} is a function that produces an algebraic operational probability expression⁷ containing the symbolic reliability variables from R_{Υ} based on the configuration of an input state, $s_{\Upsilon}^j \in S_{\Upsilon}$ ($1 \leq j \leq n_{\Upsilon}$). Formally,

$$\forall j (1 \leq j \leq n_{\Upsilon}), \text{Expr}_{\Upsilon}(s_{\Upsilon}^j) = \prod_{k=1}^{e_{\Upsilon}} \text{rel}_{\Upsilon}^j[k], \quad \text{where, } \text{rel}_{\Upsilon}^j[k] = \begin{cases} (r_{\Upsilon,k}), & \text{when } \Gamma_{\Upsilon}(s_{\Upsilon}^j)[k] = 1 \\ (1 - r_{\Upsilon,k}), & \text{when } \Gamma_{\Upsilon}(s_{\Upsilon}^j)[k] = 0 \\ 1, & \text{when } \Gamma_{\Upsilon}(s_{\Upsilon}^j)[k] = X \text{ or } Y \end{cases}$$

Substituting the reliability values for each $r_{\Upsilon,j} \in R_{\Upsilon}$ ($1 \leq j \leq e_{\Upsilon}$) in the expression Expr_{Υ} , we can get the successful operating probability value for the mode of operation in state s_{Υ}^j .

The following example illustrates such formal **QRModel** characterization in details.

Example 4. Consider the three components, C_1, C_2 and C_3 , having the **QRSpec**, $\mathcal{P}_1, \mathcal{P}_2$ and \mathcal{P}_3 , as presented in Example 2. The **QRModel** for these *three* components, which are represented by the state transition diagram and the configuration details corresponding to every state, are illustrated in Figure 4 with Table 3. For C_1 , we have the **QRModel**, $\mathcal{Q}_1 = \langle \{C_1\}, Q_1^I, R_1, S_1, s_1^1, \Gamma_1, Q_1^O, T_1^F \cup T_1^C, \text{Expr}_1 \rangle$, where:

- The input quality levels are specified as, $Q_1^I = \{50, 30, 20\}$.
 - The symbolic reliability variables are, $R_1 = \{r_{1,1}, r_{1,2}\}$.
 - The 7 operational states are, $S_1 = \{s_1^1, s_1^2, \dots, s_1^7\}$.
 - The 2-length operational state configurations are, $\Gamma_1(s_1^1) = 1X, \dots, \Gamma_1(s_1^4) = 00, \dots, \Gamma_1(s_1^7) = YY$.
 - The output quality are defined as, $Q_1^O(s_1^1, 50) = 40, Q_1^O(s_1^1, 30) = 25, Q_1^O(s_1^1, 20) = 10$.
- All output quality values at all other operating states are defined similarly.

⁷ The need to upkeep such algebraic expressions, in its complete form without calculating values instantly, is to enable seamless reliability composition (which will be explained in later sections) where same component participates (i.e. instantiated or invoked) multiple times in a component-based system with series/parallel system setup.

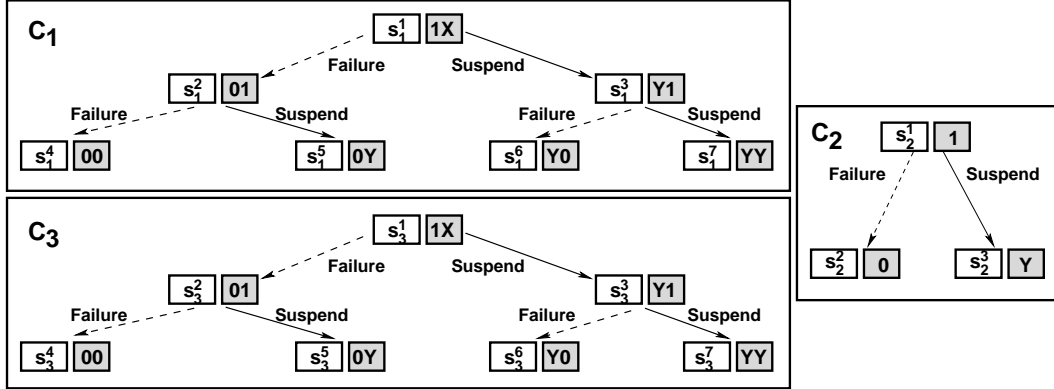

Fig. 4. State Transition Diagram corresponding to QRModel, Q_i , for three Components, C_i ($1 \leq i \leq 3$)

Component Name	State ID	Operating Mode Configuration	Input Quality Values (Levels)	Output Quality Values (Levels)	Operating Mode Probability	
					Algebraic Expression	Value
C_1	s_1^1	1X	$\langle 50, 30, 20 \rangle$	$\langle 40, 25, 10 \rangle$	$r_{1,1}$	0.80
	s_1^2	01	$\langle 50, 30, 20 \rangle$	$\langle 35, 25, 10 \rangle$	$(1 - r_{1,1}) \cdot r_{1,2}$	0.14
	s_1^3	Y1	$\langle 50, 30, 20 \rangle$	$\langle 35, 25, 10 \rangle$	$r_{1,2}$	0.70
	s_1^4	00	$\langle 0 \rangle$	$\langle 0 \rangle$	$(1 - r_{1,1}) \cdot (1 - r_{1,2})$	0.06
	s_1^5	0Y	$\langle 0 \rangle$	$\langle 0 \rangle$	$(1 - r_{1,1})$	0.20
	s_1^6	Y0	$\langle 0 \rangle$	$\langle 0 \rangle$	$(1 - r_{1,2})$	0.30
	s_1^7	YY	$\langle 0 \rangle$	$\langle 0 \rangle$	1	1.00
C_2	s_2^1	1	$\langle 40, 10 \rangle$	$\langle 30, 10 \rangle$	$r_{2,1}$	0.95
	s_2^2	0	$\langle 0 \rangle$	$\langle 0 \rangle$	$(1 - r_{2,1})$	0.05
	s_2^3	Y	$\langle 0 \rangle$	$\langle 0 \rangle$	1	1.00
C_3	s_3^1	1X	$\langle 50, 20, 10 \rangle$	$\langle 45, 20, 5 \rangle$	$r_{3,1}$	0.90
	s_3^2	01	$\langle 50, 20, 10 \rangle$	$\langle 40, 15, 5 \rangle$	$(1 - r_{3,1}) \cdot r_{3,2}$	0.08
	s_3^3	Y1	$\langle 50, 20, 10 \rangle$	$\langle 40, 15, 5 \rangle$	$r_{3,2}$	0.80
	s_3^4	00	$\langle 0 \rangle$	$\langle 0 \rangle$	$(1 - r_{3,1}) \cdot (1 - r_{3,2})$	0.02
	s_3^5	0Y	$\langle 0 \rangle$	$\langle 0 \rangle$	$(1 - r_{3,1})$	0.10
	s_3^6	Y0	$\langle 0 \rangle$	$\langle 0 \rangle$	$(1 - r_{3,2})$	0.20
	s_3^7	YY	$\langle 0 \rangle$	$\langle 0 \rangle$	1	1.00

Table 3. QRModel Configuration Details, Q_i , for Three Components, C_i ($1 \leq i \leq 3$)

- The failure state transitions are, $T_1^F = \{(s_1^1, s_1^2); (s_1^2, s_1^4); (s_1^3, s_1^6)\}$.
- The suspend state transitions are, $T_1^C = \{(s_1^1, s_1^3); (s_1^2, s_1^5); (s_1^3, s_1^7)\}$.
- The operational probability expressions are, $\text{Expr}_1(s_1^1) = (r_{1,1})$, $\text{Expr}_1(s_1^2) = (1 - r_{1,1})(r_{1,2})$, ... so on.

The intuitive explanation of such a QRModel for C_1 is as follows. C_1 can operate in two modes with reliability, $r_{1,1} = Z_1(m_1^1) = 0.8$ and $r_{1,2} = Z_1(m_1^2) = 0.7$. Whenever C_1 is operating in m_1^1 with the reliability 0.8 (as well as the operational probability = 0.8), the output quality values are 40, 25 and 10 units when the input quality levels are at least 50, within [30, 50) and within [20, 30) units, respectively. Now, when C_1 fails in the first mode of operation and moves to operate in mode m_1^2 , then the reliability becomes 0.7 (however, the operational probability becomes = $(1 - 0.8) \times 0.7 = 0.14$ as derived from $\text{Expr}_1(s_1^2)$) in the next/second operational mode, the output quality values are 35, 25 and 10 units when the input quality levels are at least 50, within [30, 50) and within [20, 30) units, respectively. Finally, when C_1 completely fails to operate in any of these two modes and enters m_1^0 (having the operating probability = $(1 - 0.8) \times (1 - 0.7) = 0.06$ derived from $\text{Expr}_1(s_1^4)$), the output quality is 0 (zero) irrespective of its input quality levels. In addition to this, when C_1 is suspended (controlled) at mode m_1^1 , then it automatically enters/operates at m_1^2 with the reliability 0.7 (i.e., having the operational probability = $1.0 \times 0.7 = 0.7$), and the output quality values are 35, 25 and 10 units when the input quality levels are at least 50, within [30, 50) and within [20, 30) units, respectively. When C_1 is suspended in both its operating mode, the output quality is 0 (zero) irrespective of the input quality levels, since it is not operating at all. \square

It may be noted that the formal representation of the quality measures in the component-level and the system-

level are generic and representation-wise similar. Since the underlying representation of the component `QRModel` is a generic state-transition system, so our proposed compositional framework will formally derive composite state-transition model to represent system `QRModel`, as described in the next section in details.

4. A Generic Quality Composition Framework

This section presents the formal approaches to (a) hierarchically compose (series/parallel) formal quality measures (`QRModel`) of components and sub-systems, and (b) then obtain system `QRSpec` directly from such formally represented composed quality measures. The first part will be enabled by the proposed algebra for quality composition of series and parallel component structures and then extend our approach to show its applicability over generic component structures as well.

4.1. Problem Statement

The formal problem statement for quality assessment of a generic component-based system is described as:

Given – A component-based system, $\Upsilon = \langle \mathcal{I}, \mathcal{O}, \mathcal{C}, \mathcal{V}, \mathcal{E}, \mathcal{L} \rangle$ with n connected subsystem structures, where each $C_i \in \mathcal{C}$ has the `QRModel`, $\mathcal{Q}_i = \langle \{C_i\}, Q_i^I, R_i, S_i, s_i^1, \Gamma_i, Q_i^O, T_i, \text{Expr}_i \rangle$.

Objective – Derive the composed `QRModel`, $\mathcal{Q}_\Upsilon = \langle C_\Upsilon, Q_\Upsilon^I, R_\Upsilon, S_\Upsilon, s_\Upsilon^1, \Gamma_\Upsilon, Q_\Upsilon^O, T_\Upsilon, \text{Expr}_\Upsilon \rangle$, for the overall system structure, Υ .

The generic framework to the above problem can be obtained by hierarchical compositions of elementary series and parallel component structures in component-based systems. Therefore, given the two subsystem structures, Υ_i and Υ_j , having their `QRModel` as, $\mathcal{Q}_{\Upsilon_i} = \langle C_{\Upsilon_i}, Q_{\Upsilon_i}^I, R_{\Upsilon_i}, S_{\Upsilon_i}, s_{\Upsilon_i}^1, \Gamma_{\Upsilon_i}, Q_{\Upsilon_i}^O, T_{\Upsilon_i}, \text{Expr}_{\Upsilon_i} \rangle$ and $\mathcal{Q}_{\Upsilon_j} = \langle C_{\Upsilon_j}, Q_{\Upsilon_j}^I, R_{\Upsilon_j}, S_{\Upsilon_j}, s_{\Upsilon_j}^1, \Gamma_{\Upsilon_j}, Q_{\Upsilon_j}^O, T_{\Upsilon_j}, \text{Expr}_{\Upsilon_j} \rangle$ respectively, we formulate the following two primitive quality composition sub-problems to establish the generic compositional framework.

Series Composition Problem: Derive the compositional `QRModel`, $\mathcal{Q}_{\Upsilon_S} = \mathcal{Q}_{\Upsilon_i} \circ \mathcal{Q}_{\Upsilon_j}$, when Υ_i and Υ_j are connected in series (Υ_i followed by Υ_j) forming the system, $\Upsilon_S \equiv \Upsilon_i \circ \Upsilon_j$.

Parallel Composition Problem: Derive the compositional `QRModel`, $\mathcal{Q}_{\Upsilon_P} = \mathcal{Q}_{\Upsilon_i} \parallel \mathcal{Q}_{\Upsilon_j}$, when Υ_i and Υ_j are connected in parallel forming the system, $\Upsilon_P \equiv \Upsilon_i \parallel \Upsilon_j$.

4.2. Approaches for Quality Composition

The composition of quality measures for the series and parallel subsystems can be carried out using various principles. Here, we introduce the compositional algebra for the primitive (series and parallel) operations.

4.2.1. Series Composition

Let the two subsystem structures, Υ_i and Υ_j have the respective `QRModel` as,

$$\mathcal{Q}_{\Upsilon_i} = \langle C_{\Upsilon_i}, Q_{\Upsilon_i}^I, R_{\Upsilon_i}, S_{\Upsilon_i}, s_{\Upsilon_i}^1, \Gamma_{\Upsilon_i}, Q_{\Upsilon_i}^O, T_{\Upsilon_i}, \text{Expr}_{\Upsilon_i} \rangle \text{ and } \mathcal{Q}_{\Upsilon_j} = \langle C_{\Upsilon_j}, Q_{\Upsilon_j}^I, R_{\Upsilon_j}, S_{\Upsilon_j}, s_{\Upsilon_j}^1, \Gamma_{\Upsilon_j}, Q_{\Upsilon_j}^O, T_{\Upsilon_j}, \text{Expr}_{\Upsilon_j} \rangle.$$

These are appended in series forming the composite system, $\Upsilon_S \equiv \Upsilon_i \circ \Upsilon_j$, whose `QRModel`, can be derived as follows: $\mathcal{Q}_{\Upsilon_i} \circ \mathcal{Q}_{\Upsilon_j} \equiv \mathcal{Q}_{\Upsilon_S} = \langle C_{\Upsilon_S}, Q_{\Upsilon_S}^I, R_{\Upsilon_S}, S_{\Upsilon_S}, s_{\Upsilon_S}^1, \Gamma_{\Upsilon_S}, Q_{\Upsilon_S}^O, T_{\Upsilon_S}, \text{Expr}_{\Upsilon_S} \rangle$, where:

- $C_{\Upsilon_S} = C_{\Upsilon_i} \cup C_{\Upsilon_j}$, denotes the set of participating components in Υ_S .
- $Q_{\Upsilon_S}^I = Q_{\Upsilon_i}^I = \{q_{\Upsilon_i}^1, q_{\Upsilon_i}^2, \dots, q_{\Upsilon_i}^{l_{\Upsilon_i}}\}$ denotes the set of $l_{\Upsilon_S} = l_{\Upsilon_i}$ input quality values (levels) used by C_{Υ_i} .
- $R_{\Upsilon_S} = R_{\Upsilon_i} \cup R_{\Upsilon_j}$, denotes the combined set of all symbolic reliability variables with $|R_{\Upsilon_S}| = e_{\Upsilon_S}$.
- S_{Υ_S} is the set of states (with $s_{\Upsilon_S}^1 \in S_{\Upsilon_S}$ being the start state) representing state configurations of \mathcal{Q}_{Υ_S} .
- $\Gamma_{\Upsilon_S} : S_{\Upsilon_S} \rightarrow \{1, 0, X, Y\}^{e_{\Upsilon_S}}$ is the e_{Υ_S} -length state configuration, such that for a state, $s_{\Upsilon_S}^k \in S_{\Upsilon_S}$, the composed state configuration, $s_{\Upsilon_S}^k$ is obtained from states $s_{\Upsilon_i}^a \in S_{\Upsilon_i}$ ($1 \leq a \leq n_{\Upsilon_i}$) and $s_{\Upsilon_j}^b \in S_{\Upsilon_j}$ ($1 \leq b \leq n_{\Upsilon_j}$), denoted as $\Gamma_{\Upsilon_S}(s_{\Upsilon_S}^k) = \Gamma_{\Upsilon_i}(s_{\Upsilon_i}^a) \odot \Gamma_{\Upsilon_j}(s_{\Upsilon_j}^b)$, as follows: $(e_{\Upsilon_i} \leq e_{\Upsilon_S} \leq e_{\Upsilon_i} + e_{\Upsilon_j})$

- $\Gamma_{\Upsilon_S}(s_{\Upsilon_S}^k)[1..e_{\Upsilon_i}] = \Gamma_{\Upsilon_i}(s_{\Upsilon_i}^a)[1..e_{\Upsilon_i}]$, and
- $\forall v (1 \leq v \leq e_{\Upsilon_j}), \exists u (u \leq v), \Gamma_{\Upsilon_S}(s_{\Upsilon_S}^k)[e_{\Upsilon_i} + u] = \Gamma_{\Upsilon_j}(s_{\Upsilon_j}^b)[v]$ ($1 \leq u \leq e_{\Upsilon_S} - e_{\Upsilon_i}$) when $r_{\Upsilon_j, v} \in R_{\Upsilon_j}$ but $r_{\Upsilon_j, v} \notin R_{\Upsilon_i}$.

Intuitively, the last rule prevents the composed configuration to create duplicate configuration entries in case of multiple occurrence of the same component in both C_{Υ_i} and C_{Υ_j} subsystems.

- $Q_{\Upsilon_S}^O : S_{\Upsilon_S} \times Q_{\Upsilon_S}^I \rightarrow \mathbb{R}^+$ indicates the function to compute the output quality value. For a state, $s_{\Upsilon_S}^k \in S_{\Upsilon_S}$, where $\Gamma_{\Upsilon_S}(s_{\Upsilon_S}^k) = \Gamma_{\Upsilon_i}(s_{\Upsilon_i}^a) \odot \Gamma_{\Upsilon_j}(s_{\Upsilon_j}^b)$ ($s_{\Upsilon_i}^a \in S_{\Upsilon_i}, s_{\Upsilon_j}^b \in S_{\Upsilon_j}$), we have: $\forall k_i (1 \leq k_i \leq l_{\Upsilon_i}), \exists k_j (1 \leq k_j \leq l_{\Upsilon_j})$ such that $Q_{\Upsilon_S}^O(s_{\Upsilon_S}^k, q_{\Upsilon_i}^{k_i}) = Q_{\Upsilon_j}^O(s_{\Upsilon_j}^b, q_{\Upsilon_j}^{k_j})$ and $Q_{\Upsilon_i}^O(s_{\Upsilon_i}^a, q_{\Upsilon_i}^{k_i}) \geq q_{\Upsilon_j}^{k_j}$, as well as $\nexists k' (1 \leq k' \leq l_{\Upsilon_j})$ so that $q_{\Upsilon_j}^{k_j} < q_{\Upsilon_j}^{k'} \leq Q_{\Upsilon_i}^O(s_{\Upsilon_i}^a, q_{\Upsilon_i}^{k_i})$.
- $T_{\Upsilon_S} \subseteq S_{\Upsilon_S} \times S_{\Upsilon_S}$ denotes the transition relation and let $T_{\Upsilon_S} = T_{\Upsilon_S}^F \cup T_{\Upsilon_S}^C$, where $T_{\Upsilon_S}^F$ and $T_{\Upsilon_S}^C$ are the set of failure and suspend transitions, respectively. Suppose, $T_{\Upsilon_i}(s_{\Upsilon_i}^a, s_{\Upsilon_i}^{a'})$ and $T_{\Upsilon_j}(s_{\Upsilon_j}^b, s_{\Upsilon_j}^{b'})$ are transition in \mathcal{Q}_{Υ_i} and \mathcal{Q}_{Υ_j} , respectively where $s_{\Upsilon_i}^a, s_{\Upsilon_i}^{a'} \in S_{\Upsilon_i}$ ($1 \leq a, a' \leq n_{\Upsilon_i}$) and $s_{\Upsilon_j}^b, s_{\Upsilon_j}^{b'} \in S_{\Upsilon_j}$ ($1 \leq b, b' \leq n_{\Upsilon_j}$). For $s_{\Upsilon_S}^k \in S_{\Upsilon_S}$, if $\Gamma_{\Upsilon_S}(s_{\Upsilon_S}^k) = \Gamma_{\Upsilon_i}(s_{\Upsilon_i}^a) \odot \Gamma_{\Upsilon_j}(s_{\Upsilon_j}^b)$, then $T_{\Upsilon_S}(s_{\Upsilon_S}^k, s_{\Upsilon_S}^{k'})$ is a permissible transition ($\exists s_{\Upsilon_S}^{k'} \in S_{\Upsilon_S}$) such that one of the following three conditions hold:
 - $\Gamma_{\Upsilon_S}(s_{\Upsilon_S}^{k'}) = \Gamma_{\Upsilon_i}(s_{\Upsilon_i}^a) \odot \Gamma_{\Upsilon_j}(s_{\Upsilon_j}^{b'})$, or
 - $\Gamma_{\Upsilon_S}(s_{\Upsilon_S}^{k'}) = \Gamma_{\Upsilon_i}(s_{\Upsilon_i}^{a'}) \odot \Gamma_{\Upsilon_j}(s_{\Upsilon_j}^b)$, or
 - $\Gamma_{\Upsilon_S}(s_{\Upsilon_S}^{k'}) = \Gamma_{\Upsilon_i}(s_{\Upsilon_i}^{a'}) \odot \Gamma_{\Upsilon_j}(s_{\Upsilon_j}^{b'})$ along with either of the following two constraints:
 - $T_{\Upsilon_i}(s_{\Upsilon_i}^a, s_{\Upsilon_i}^{a'}) \in T_{\Upsilon_i}^F; T_{\Upsilon_j}(s_{\Upsilon_j}^b, s_{\Upsilon_j}^{b'}) \in T_{\Upsilon_j}^F$, or (b) $T_{\Upsilon_i}(s_{\Upsilon_i}^a, s_{\Upsilon_i}^{a'}) \in T_{\Upsilon_i}^C; T_{\Upsilon_j}(s_{\Upsilon_j}^b, s_{\Upsilon_j}^{b'}) \in T_{\Upsilon_j}^C$.

Further, it is important to note the categorization of transitions (failure or suspended) here as follows:

- $T_{\Upsilon_S}(s_{\Upsilon_S}^k, s_{\Upsilon_S}^{k'}) \in T_{\Upsilon_S}^F$ (is a failure transition), whenever either of the following happens:
 - $T_{\Upsilon_i}(s_{\Upsilon_j}^b, s_{\Upsilon_j}^{b'}) \in T_{\Upsilon_j}^F$ and Condition-(i) / Condition-(iii-a) is satisfied from above, or
 - $T_{\Upsilon_i}(s_{\Upsilon_i}^a, s_{\Upsilon_i}^{a'}) \in T_{\Upsilon_i}^F$ and Condition-(ii) / Condition-(iii-a) is satisfied from above.
- $T_{\Upsilon_S}(s_{\Upsilon_S}^k, s_{\Upsilon_S}^{k'}) \in T_{\Upsilon_S}^C$ (is a suspend transition), whenever either of the following happens:
 - $T_{\Upsilon_i}(s_{\Upsilon_j}^b, s_{\Upsilon_j}^{b'}) \in T_{\Upsilon_j}^C$ and Condition-(i) / Condition-(iii-b) is satisfied from above, or
 - $T_{\Upsilon_i}(s_{\Upsilon_i}^a, s_{\Upsilon_i}^{a'}) \in T_{\Upsilon_i}^C$ and Condition-(ii) / Condition-(iii-b) is satisfied from above.

- Expr_{Υ_S} indicates the function for deriving algebraic reliability expression. For a state, $s_{\Upsilon_S}^k \in S_{\Upsilon_S}$, where $\Gamma_{\Upsilon_S}(s_{\Upsilon_S}^k) = \Gamma_{\Upsilon_i}(s_{\Upsilon_i}^a) \odot \Gamma_{\Upsilon_j}(s_{\Upsilon_j}^b)$ with $s_{\Upsilon_i}^a \in S_{\Upsilon_i}, s_{\Upsilon_j}^b \in S_{\Upsilon_j}$, we have:

$$\text{Expr}_{\Upsilon_S}(s_{\Upsilon_S}^k) \leftarrow [\text{Expr}_{\Upsilon_i}(s_{\Upsilon_i}^a)] \cdot [\text{Expr}_{\Upsilon_j}(s_{\Upsilon_j}^b)] \Big|_{r_{\Upsilon_i, k_i}^p = r_{\Upsilon_i, k_i} \text{ and } r_{\Upsilon_j, k_j}^p = r_{\Upsilon_j, k_j}} \quad (1 \leq k_i \leq e_{\Upsilon_i}, 1 \leq k_j \leq e_{\Upsilon_j}, \text{ and } p \in \mathbb{N})$$

which means that, after making the simplified expression of $\text{Expr}_{\Upsilon_S}(s_{\Upsilon_S}^k)$, all the common symbolic reliability variables, leading to the raise in their power of terms, are *normalized*. Intuitively, this step takes care of the effect of having multiple instantiation/invoke of the same component inside the system structure while calculating operating probability from the generated expressions [26].

The following example demonstrates the `QRModel` derivation for a series system from the given `QRModel` for each of its constituent components/subsystems.

Example 5. Let us revisit the 2-component series system (Υ_S) shown in Figure 3(a) and determine the `QRModel` for this, say \mathcal{Q}_{Υ_S} , comprising of the component C_3 followed by the component C_2 . Formally, $\mathcal{Q}_{\Upsilon_S} = \mathcal{Q}_3 \circ \mathcal{Q}_2$, where \mathcal{Q}_3 and \mathcal{Q}_2 are already defined in Example 4 (with Figure 4 and Table 3). Here for Υ_S , the derived `QRModel`, \mathcal{Q}_{Υ_S} , which is represented by the state transition diagram and the configuration details corresponding to every state, is expressed in Figure 5 with Table 4. For Υ_S , we have:

- The set of 2 participating components as, $C_{\Upsilon_S} = \{C_3, C_2\}$

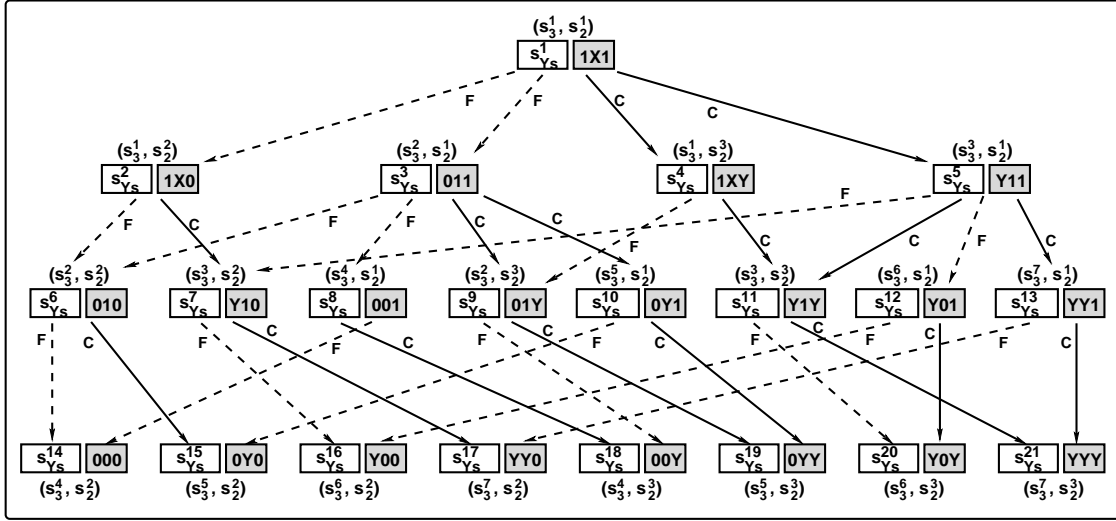
 Fig. 5. State Transition Diagram for the Example QRModel after Series Composition: $Q_{\Gamma_S} = Q_3 \circ Q_2$

State ID	Composite State Pair	Operating Mode Configuration	Input Quality Values (Levels)	Output Quality Values (Levels)	Operating Mode Probability	
					Algebraic Expression	Value
$s_{\Gamma_S}^1$	(s_3^1, s_2^1)	1X1	$\langle 50, 20 \rangle$	$\langle 30, 10 \rangle$	$r_{3,1} \cdot r_{2,1}$	0.855
$s_{\Gamma_S}^2$	(s_3^1, s_2^2)	1X0	$\langle 0 \rangle$	$\langle 0 \rangle$	$r_{3,1} \cdot (1 - r_{2,1})$	0.045
$s_{\Gamma_S}^3$	(s_3^2, s_2^1)	011	$\langle 50, 20 \rangle$	$\langle 30, 10 \rangle$	$(1 - r_{3,1}) \cdot r_{3,2} \cdot r_{2,1}$	0.076
$s_{\Gamma_S}^4$	(s_3^1, s_2^3)	1XY	$\langle 0 \rangle$	$\langle 0 \rangle$	$r_{3,1}$	0.900
$s_{\Gamma_S}^5$	(s_3^3, s_2^1)	Y11	$\langle 50, 20 \rangle$	$\langle 30, 10 \rangle$	$r_{3,2} \cdot r_{2,1}$	0.760
$s_{\Gamma_S}^6$	(s_3^3, s_2^2)	010	$\langle 0 \rangle$	$\langle 0 \rangle$	$(1 - r_{3,1}) \cdot r_{3,2} \cdot (1 - r_{2,1})$	0.004
$s_{\Gamma_S}^7$	(s_3^3, s_2^2)	Y10	$\langle 0 \rangle$	$\langle 0 \rangle$	$r_{3,2} \cdot (1 - r_{2,1})$	0.040
$s_{\Gamma_S}^8$	(s_3^4, s_2^1)	001	$\langle 0 \rangle$	$\langle 0 \rangle$	$(1 - r_{3,1}) \cdot (1 - r_{3,2}) \cdot r_{2,1}$	0.019
$s_{\Gamma_S}^9$	(s_3^2, s_2^3)	01Y	$\langle 0 \rangle$	$\langle 0 \rangle$	$(1 - r_{3,1}) \cdot r_{3,2}$	0.080
$s_{\Gamma_S}^{10}$	(s_3^5, s_2^1)	0Y1	$\langle 0 \rangle$	$\langle 0 \rangle$	$(1 - r_{3,1}) \cdot r_{2,1}$	0.095
$s_{\Gamma_S}^{11}$	(s_3^3, s_2^3)	Y1Y	$\langle 0 \rangle$	$\langle 0 \rangle$	$r_{3,2}$	0.800
$s_{\Gamma_S}^{12}$	(s_3^6, s_2^1)	Y01	$\langle 0 \rangle$	$\langle 0 \rangle$	$(1 - r_{3,2}) \cdot r_{2,1}$	0.190
$s_{\Gamma_S}^{13}$	(s_3^7, s_2^1)	YY1	$\langle 0 \rangle$	$\langle 0 \rangle$	$r_{2,1}$	0.950
$s_{\Gamma_S}^{14}$	(s_3^4, s_2^2)	000	$\langle 0 \rangle$	$\langle 0 \rangle$	$(1 - r_{3,1}) \cdot (1 - r_{3,2}) \cdot (1 - r_{2,1})$	0.001
$s_{\Gamma_S}^{15}$	(s_3^5, s_2^2)	0Y0	$\langle 0 \rangle$	$\langle 0 \rangle$	$(1 - r_{3,1}) \cdot (1 - r_{2,1})$	0.005
$s_{\Gamma_S}^{16}$	(s_3^6, s_2^2)	Y00	$\langle 0 \rangle$	$\langle 0 \rangle$	$(1 - r_{3,2}) \cdot (1 - r_{2,1})$	0.010
$s_{\Gamma_S}^{17}$	(s_3^7, s_2^2)	YY0	$\langle 0 \rangle$	$\langle 0 \rangle$	$(1 - r_{2,1})$	0.050
$s_{\Gamma_S}^{18}$	(s_3^4, s_2^3)	00Y	$\langle 0 \rangle$	$\langle 0 \rangle$	$(1 - r_{3,1}) \cdot (1 - r_{3,2})$	0.020
$s_{\Gamma_S}^{19}$	(s_3^5, s_2^3)	0YY	$\langle 0 \rangle$	$\langle 0 \rangle$	$(1 - r_{3,1})$	0.100
$s_{\Gamma_S}^{20}$	(s_3^6, s_2^3)	Y0Y	$\langle 0 \rangle$	$\langle 0 \rangle$	$(1 - r_{3,2})$	0.200
$s_{\Gamma_S}^{21}$	(s_3^7, s_2^3)	YYY	$\langle 0 \rangle$	$\langle 0 \rangle$	1	1.000

 Table 4. QRModel Configuration Details after the Example Series Composition: $Q_{\Gamma_S} = Q_3 \circ Q_2$

- The set of 3 input quality levels as, $Q_{\Gamma_S}^I = \{50, 20, 10\}$.
- The set of 3 symbolic reliability variables as, $R_{\Gamma_S} = \{r_{3,1}, r_{3,2}, r_{2,1}\}$ with values, 0.9, 0.8, 0.95, respectively.
- The set of 21 states, $S_{\Gamma_S} = \{s_{\Gamma_S}^1, s_{\Gamma_S}^2, \dots, s_{\Gamma_S}^{21}\}$.
- The state configurations are given as, $\Gamma_{\Gamma_S}(s_{\Gamma_S}^1) = \Gamma_{\Gamma_3}(s_3^1) \odot \Gamma_{\Gamma_2}(s_2^1) = 1X1$, $\Gamma_{\Gamma_S}(s_{\Gamma_S}^2) = \Gamma_{\Gamma_3}(s_3^1) \odot \Gamma_{\Gamma_2}(s_2^2) = 1X0$, ... so on.
- All derived output quality values are given in Figure 5. To exemplify the derivation, $Q_{\Gamma_S}^O(s_{\Gamma_S}^1, 50) = Q_2^O(s_2^1, Q_3^O(s_3^1, 50)) = Q_2^O(s_2^1, 45) = Q_2^O(s_2^1, 40) = 30$ (since, $Q_3^O(s_3^1, 50) = 45 > 40$).
- All state transitions (both failure and suspension) are shown in Figure 5. To exemplify the derivation,

- The failure transitions are, $T_{\Upsilon_S}^F = \{(s_{\Upsilon_S}^1, s_{\Upsilon_S}^2), (s_{\Upsilon_S}^1, s_{\Upsilon_S}^3), \dots\}$.
(marked with dotted edges and labeled using F)
- The suspend transitions are, $T_{\Upsilon_S}^C = \{(s_{\Upsilon_S}^1, s_{\Upsilon_S}^4), (s_{\Upsilon_S}^1, s_{\Upsilon_S}^5), \dots\}$.
(marked with solid edges and labeled using C)

- All algebraic operational probability expressions are shown in Figure 5. To exemplify the derivation, $\text{Expr}_{\Upsilon_S}(s_{\Upsilon_S}^1) = r_{3,1}.r_{2,1}$; $\text{Expr}_{\Upsilon_S}(s_{\Upsilon_S}^2) = r_{3,1}.(1 - r_{2,1})$; $\text{Expr}_{\Upsilon_S}(s_{\Upsilon_S}^3) = (1 - r_{3,1}).r_{3,2}.r_{2,1}$; ... so on.

There may be multiple choices from an operational state upon its failure or suspend and such a choice can lead to any one among these options *non-deterministically*. \square

4.2.2. Parallel Composition

Let the two subsystem structures, Υ_i and Υ_j have the respective **QRModel** as,

$$\mathcal{Q}_{\Upsilon_i} = \langle C_{\Upsilon_i}, Q_{\Upsilon_i}^I, R_{\Upsilon_i}, S_{\Upsilon_i}, s_{\Upsilon_i}^1, \Gamma_{\Upsilon_i}, Q_{\Upsilon_i}^O, T_{\Upsilon_i}, \text{Expr}_{\Upsilon_i} \rangle \text{ and } \mathcal{Q}_{\Upsilon_j} = \langle C_{\Upsilon_j}, Q_{\Upsilon_j}^I, R_{\Upsilon_j}, S_{\Upsilon_j}, s_{\Upsilon_j}^1, \Gamma_{\Upsilon_j}, Q_{\Upsilon_j}^O, T_{\Upsilon_j}, \text{Expr}_{\Upsilon_j} \rangle.$$

These are connected in parallel forming the composite system, $\Upsilon_P \equiv \Upsilon_i \parallel \Upsilon_j$, whose **QRModel**, can be derived as follows: $\mathcal{Q}_{\Upsilon_i} \parallel \mathcal{Q}_{\Upsilon_j} \equiv \mathcal{Q}_{\Upsilon_P} = \langle C_{\Upsilon_P}, Q_{\Upsilon_P}^I, R_{\Upsilon_P}, S_{\Upsilon_P}, s_{\Upsilon_P}^1, \Gamma_{\Upsilon_P}, Q_{\Upsilon_P}^O, T_{\Upsilon_P}, \text{Expr}_{\Upsilon_P} \rangle$, where:

- $C_{\Upsilon_P} = C_{\Upsilon_i} \cup C_{\Upsilon_j}$, denotes the set of participating components in Υ_P .
- $Q_{\Upsilon_P}^I = Q_{\Upsilon_i}^I \cup Q_{\Upsilon_j}^I$, denotes the combined set of l_{Υ_P} input quality values (levels) used by C_{Υ_i} and C_{Υ_j} .
- $R_{\Upsilon_P} = R_{\Upsilon_i} \cup R_{\Upsilon_j}$, denotes the combined set of all symbolic reliability variables with $|R_{\Upsilon_P}| = e_{\Upsilon_P}$.
- S_{Υ_P} is the set of states (with $s_{\Upsilon_P}^1 \in S_{\Upsilon_P}$ being the start state) representing state configurations of \mathcal{Q}_{Υ_P} .
- $\Gamma_{\Upsilon_P} : S_{\Upsilon_P} \rightarrow \{1, 0, X, Y\}^{e_{\Upsilon_P}}$ is the e_{Υ_P} -length state configuration, such that for a state, $s_{\Upsilon_P}^k \in S_{\Upsilon_P}$, the composed state configuration, $s_{\Upsilon_P}^k$ is obtained from states $s_{\Upsilon_i}^a \in S_{\Upsilon_i}$ ($1 \leq a \leq n_{\Upsilon_i}$) and $s_{\Upsilon_j}^b \in S_{\Upsilon_j}$ ($1 \leq b \leq n_{\Upsilon_j}$), denoted as $\Gamma_{\Upsilon_P}(s_{\Upsilon_P}^k) = \Gamma_{\Upsilon_i}(s_{\Upsilon_i}^a) \odot \Gamma_{\Upsilon_j}(s_{\Upsilon_j}^b)$, as follows: ($e_{\Upsilon_i} \leq e_{\Upsilon_P} \leq e_{\Upsilon_i} + e_{\Upsilon_j}$)

$$- \Gamma_{\Upsilon_P}(s_{\Upsilon_P}^k)[1..e_{\Upsilon_i}] = \Gamma_{\Upsilon_i}(s_{\Upsilon_i}^a)[1..e_{\Upsilon_i}], \text{ and}$$

$$- \forall v (1 \leq v \leq e_{\Upsilon_j}), \exists u (u \leq v), \Gamma_{\Upsilon_P}(s_{\Upsilon_P}^k)[e_{\Upsilon_i} + u] = \Gamma_{\Upsilon_j}(s_{\Upsilon_j}^b)[v] (1 \leq u \leq e_{\Upsilon_P} - e_{\Upsilon_i}) \text{ when } r_{\Upsilon_j, v} \in R_{\Upsilon_j} \text{ but } r_{\Upsilon_j, v} \notin R_{\Upsilon_i}.$$

Intuitively, the last rule prevents the composed configuration to create duplicate configuration entries in case of multiple occurrence of the same component in both C_{Υ_i} and C_{Υ_j} subsystems.

- $Q_{\Upsilon_P}^O : S_{\Upsilon_P} \times Q_{\Upsilon_P}^I \rightarrow \mathbb{R}^+$ indicates the function to compute the output quality value.

For a state, $s_{\Upsilon_P}^k \in S_{\Upsilon_P}$, where $\Gamma_{\Upsilon_P}(s_{\Upsilon_P}^k) = \Gamma_{\Upsilon_i}(s_{\Upsilon_i}^a) \odot \Gamma_{\Upsilon_j}(s_{\Upsilon_j}^b)$ ($s_{\Upsilon_i}^a \in S_{\Upsilon_i}$, $s_{\Upsilon_j}^b \in S_{\Upsilon_j}$), we generate:

from $q_{\Upsilon_i}^x, q_{\Upsilon_i}^{x'} \in Q_{\Upsilon_i}^I$, $q_{\Upsilon_j}^y, q_{\Upsilon_j}^{y'} \in Q_{\Upsilon_j}^I$ (where $1 \leq x, x' \leq l_{\Upsilon_i}$, $1 \leq y, y' \leq l_{\Upsilon_j}$) and $\forall w (1 \leq w \leq l_{\Upsilon_P})$,

\triangleright Maximum Quality Output: In this case, the overall quality measure is produced by choosing the maximum quality value from various operational modes of the components. Formally, we express this as:

$$Q_{\Upsilon_P}^O(s_{\Upsilon_P}^k, q_{\Upsilon_P}^w) = \begin{cases} \text{MAX}[Q_{\Upsilon_i}^O(s_{\Upsilon_i}^a, q_{\Upsilon_i}^x), Q_{\Upsilon_j}^O(s_{\Upsilon_j}^b, q_{\Upsilon_j}^y)], & \text{when } \exists q_{\Upsilon_i}^x, \exists q_{\Upsilon_j}^y \text{ such that } q_{\Upsilon_j}^y \leq q_{\Upsilon_i}^x \leq q_{\Upsilon_P}^w, \text{ and} \\ & \nexists q_{\Upsilon_j}^{y'} \nexists q_{\Upsilon_i}^{x'} \text{ such that } q_{\Upsilon_j}^y < q_{\Upsilon_j}^{y'} \leq q_{\Upsilon_i}^x < q_{\Upsilon_i}^{x'} \leq q_{\Upsilon_P}^w \\ & \text{or, } \exists q_{\Upsilon_j}^{y'}, \exists q_{\Upsilon_i}^{x'} \text{ such that } q_{\Upsilon_i}^x < q_{\Upsilon_j}^{y'} \leq q_{\Upsilon_P}^w, \text{ and} \\ & \nexists q_{\Upsilon_i}^{x'} \nexists q_{\Upsilon_j}^{y'} \text{ such that } q_{\Upsilon_i}^x < q_{\Upsilon_i}^{x'} \leq q_{\Upsilon_j}^y < q_{\Upsilon_j}^{y'} \leq q_{\Upsilon_P}^w \\ Q_{\Upsilon_i}^O(s_{\Upsilon_i}^a, q_{\Upsilon_i}^x), & \text{when } \forall q_{\Upsilon_j}^y, \exists q_{\Upsilon_i}^x \text{ such that } q_{\Upsilon_i}^x \leq q_{\Upsilon_P}^w < q_{\Upsilon_j}^y, \text{ and} \\ & \nexists q_{\Upsilon_i}^{x'} \text{ such that } q_{\Upsilon_i}^x < q_{\Upsilon_i}^{x'} \leq q_{\Upsilon_P}^w \\ Q_{\Upsilon_j}^O(s_{\Upsilon_j}^b, q_{\Upsilon_j}^y), & \text{when } \forall q_{\Upsilon_i}^x, \exists q_{\Upsilon_j}^y \text{ such that } q_{\Upsilon_j}^y \leq q_{\Upsilon_P}^w < q_{\Upsilon_i}^x, \text{ and} \\ & \nexists q_{\Upsilon_j}^{y'} \text{ such that } q_{\Upsilon_j}^y < q_{\Upsilon_j}^{y'} \leq q_{\Upsilon_P}^w \\ 0, & \text{when } \forall q_{\Upsilon_i}^x, \forall q_{\Upsilon_j}^y \text{ such that } q_{\Upsilon_P}^w < q_{\Upsilon_i}^x, \text{ and } q_{\Upsilon_P}^w < q_{\Upsilon_j}^y \\ & \text{(otherwise)} \end{cases}$$

Here, the output quality measure is derived based on the best output value possible (given an input level) considering both the output functions of C_{Υ_i} and C_{Υ_j} .

▷ Ordered Quality Output: In this case, the out quality is governed by a pre-defined ordering among the components/subsystems, say, $C_{\Upsilon_i} \prec C_{\Upsilon_j}$. Formally, we express this as:

$$Q_{\Upsilon_P}^O(s_{\Upsilon_P}^k, q_{\Upsilon_P}^w) = \begin{cases} 0, & \text{when } \forall q_{\Upsilon_i}^x, \forall q_{\Upsilon_j}^y \text{ such that } q_{\Upsilon_P}^w < q_{\Upsilon_i}^x, \text{ and } q_{\Upsilon_P}^w < q_{\Upsilon_j}^y \\ Q_{\Upsilon_j}^O(s_{\Upsilon_j}^b, q_{\Upsilon_j}^y), & \text{when } \forall q_{\Upsilon_i}^x, \exists q_{\Upsilon_j}^y \text{ such that } q_{\Upsilon_j}^y \leq q_{\Upsilon_P}^w < q_{\Upsilon_i}^x, \text{ and} \\ & \nexists q_{\Upsilon_j}^y \text{ such that } q_{\Upsilon_j}^y < q_{\Upsilon_P}^w \leq q_{\Upsilon_j}^y \\ Q_{\Upsilon_i}^O(s_{\Upsilon_i}^a, q_{\Upsilon_i}^x), & \text{otherwise} \end{cases}$$

Here, the output quality measure is derived based on the following (ordering) rules:

- When both the subsystems, C_{Υ_i} and C_{Υ_j} , are operational then it is the output quality measure provided by C_{Υ_i} , provided its input quality level is above the lowest input quality value supported (only otherwise we switch to C_{Υ_j} 's output quality function),
 - When the subsystem C_{Υ_i} fails or suspended completely and C_{Υ_j} remains operational, then it is the output quality measure provided by C_{Υ_j} , and
 - It is 0 (zero) when both C_{Υ_i} and C_{Υ_j} fails or suspended completely.
- $T_{\Upsilon_P} \subseteq S_{\Upsilon_P} \times S_{\Upsilon_P}$ denotes the transition relation and let $T_{\Upsilon_P} = T_{\Upsilon_P}^F \cup T_{\Upsilon_P}^C$, where $T_{\Upsilon_P}^F$ and $T_{\Upsilon_P}^C$ are the set of failure and suspend transitions, respectively. Suppose, $T_{\Upsilon_i}(s_{\Upsilon_i}^a, s_{\Upsilon_i}^{a'})$ and $T_{\Upsilon_j}(s_{\Upsilon_j}^b, s_{\Upsilon_j}^{b'})$ are transition in \mathcal{Q}_{Υ_i} and \mathcal{Q}_{Υ_j} , respectively where $s_{\Upsilon_i}^a, s_{\Upsilon_i}^{a'} \in S_{\Upsilon_i}$ ($1 \leq a, a' \leq n_{\Upsilon_i}$) and $s_{\Upsilon_j}^b, s_{\Upsilon_j}^{b'} \in S_{\Upsilon_j}$ ($1 \leq b, b' \leq n_{\Upsilon_j}$). For $s_{\Upsilon_P}^k \in S_{\Upsilon_P}$, if $\Gamma_{\Upsilon_P}(s_{\Upsilon_P}^k) = \Gamma_{\Upsilon_i}(s_{\Upsilon_i}^a) \odot \Gamma_{\Upsilon_j}(s_{\Upsilon_j}^b)$, then $T_{\Upsilon_P}(s_{\Upsilon_P}^k, s_{\Upsilon_P}^{k'})$ is a permissible transition ($\exists s_{\Upsilon_P}^{k'} \in S_{\Upsilon_P}$) such that one of the following three conditions hold:

- (i) $\Gamma_{\Upsilon_P}(s_{\Upsilon_P}^{k'}) = \Gamma_{\Upsilon_i}(s_{\Upsilon_i}^a) \odot \Gamma_{\Upsilon_j}(s_{\Upsilon_j}^{b'})$, or (ii) $\Gamma_{\Upsilon_P}(s_{\Upsilon_P}^{k'}) = \Gamma_{\Upsilon_i}(s_{\Upsilon_i}^{a'}) \odot \Gamma_{\Upsilon_j}(s_{\Upsilon_j}^b)$, or
- (iii) $\Gamma_{\Upsilon_P}(s_{\Upsilon_P}^{k'}) = \Gamma_{\Upsilon_i}(s_{\Upsilon_i}^{a'}) \odot \Gamma_{\Upsilon_j}(s_{\Upsilon_j}^{b'})$ along with either of the following two constraints:
 - (a) $T_{\Upsilon_i}(s_{\Upsilon_i}^a, s_{\Upsilon_i}^{a'}) \in T_{\Upsilon_i}^F; T_{\Upsilon_j}(s_{\Upsilon_j}^b, s_{\Upsilon_j}^{b'}) \in T_{\Upsilon_j}^F$, or (b) $T_{\Upsilon_i}(s_{\Upsilon_i}^a, s_{\Upsilon_i}^{a'}) \in T_{\Upsilon_i}^C; T_{\Upsilon_j}(s_{\Upsilon_j}^b, s_{\Upsilon_j}^{b'}) \in T_{\Upsilon_j}^C$.

Further, it is important to note the categorization of transitions (failure or suspended) here as follows:

- $T_{\Upsilon_P}(s_{\Upsilon_P}^k, s_{\Upsilon_P}^{k'}) \in T_{\Upsilon_P}^F$ (is a failure transition), whenever either of the following happens:
 - (a) $T_{\Upsilon_i}(s_{\Upsilon_j}^b, s_{\Upsilon_j}^{b'}) \in T_{\Upsilon_j}^F$ and Condition-(i) / Condition-(iii-a) is satisfied from above, or
 - (b) $T_{\Upsilon_i}(s_{\Upsilon_i}^a, s_{\Upsilon_i}^{a'}) \in T_{\Upsilon_i}^F$ and Condition-(ii) / Condition-(iii-a) is satisfied from above.
 - $T_{\Upsilon_P}(s_{\Upsilon_P}^k, s_{\Upsilon_P}^{k'}) \in T_{\Upsilon_P}^C$ (is a suspend transition), whenever either of the following happens:
 - (a) $T_{\Upsilon_i}(s_{\Upsilon_j}^b, s_{\Upsilon_j}^{b'}) \in T_{\Upsilon_j}^C$ and Condition-(i) / Condition-(iii-b) is satisfied from above, or
 - (b) $T_{\Upsilon_i}(s_{\Upsilon_i}^a, s_{\Upsilon_i}^{a'}) \in T_{\Upsilon_i}^C$ and Condition-(ii) / Condition-(iii-b) is satisfied from above.
- Expr_{Υ_P} indicates the function for deriving algebraic reliability expression. For a state, $s_{\Upsilon_P}^k \in S_{\Upsilon_P}$, where $\Gamma_{\Upsilon_P}(s_{\Upsilon_P}^k) = \Gamma_{\Upsilon_i}(s_{\Upsilon_i}^a) \odot \Gamma_{\Upsilon_j}(s_{\Upsilon_j}^b)$ with $s_{\Upsilon_i}^a \in S_{\Upsilon_i}$, $s_{\Upsilon_j}^b \in S_{\Upsilon_j}$, we have:

$$\text{Expr}_{\Upsilon_P}(s_{\Upsilon_P}^k) \leftarrow [\text{Expr}_{\Upsilon_i}(s_{\Upsilon_i}^a)] \cdot [\text{Expr}_{\Upsilon_j}(s_{\Upsilon_j}^b)] \Big|_{r_{\Upsilon_i, k_i}^p = r_{\Upsilon_i, k_i} \text{ and } r_{\Upsilon_j, k_j}^p = r_{\Upsilon_j, k_j}} \quad (1 \leq k_i \leq e_{\Upsilon_i}, 1 \leq k_j \leq e_{\Upsilon_j}, \text{ and } p \in \mathbb{N})$$

which means that, after making the simplified expression of $\text{Expr}_{\Upsilon_P}(s_{\Upsilon_P}^k)$, all the common symbolic reliability variables, leading to the raise in their power of terms, are *normalized*. Intuitively, this step takes care of the effect of having multiple instantiation/invocation of the same component inside the system structure while calculating operating probability from the generated expressions [26].

The following example demonstrates the `QRModel` derivation of a parallel system from the given `QRModel` for each of its constituent components/subsystems.

Example 6. Let us revisit the 2-component parallel system (Υ_P) shown in Figure 3(b) and determine the

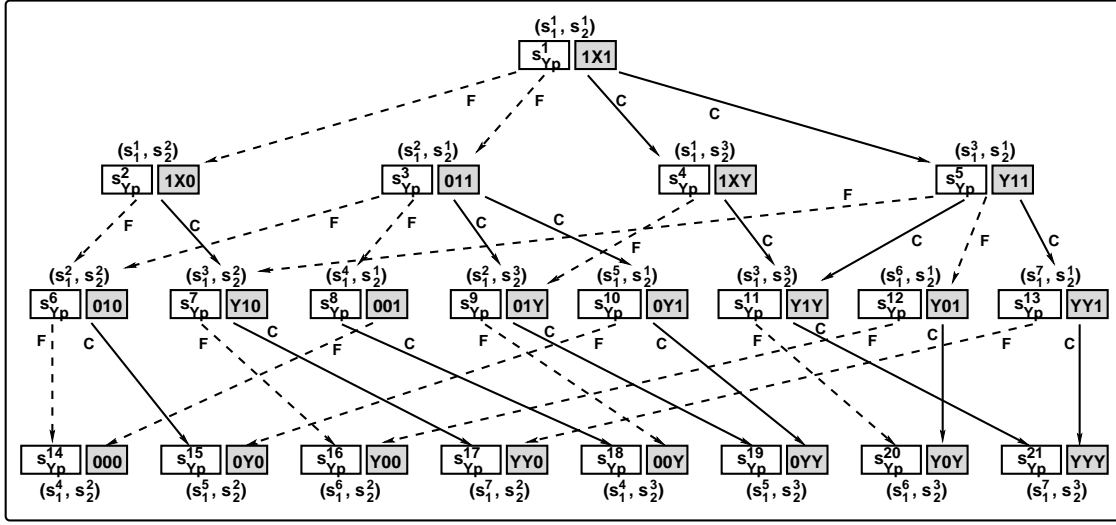

Fig. 6. State Transition Diagram for the Example QRModel after Parallel Composition: $\mathcal{Q}_{\Upsilon_P} = \mathcal{Q}_1 \parallel \mathcal{Q}_2$

State ID	Composite State Pair	Operating Mode Configuration	Input Quality Values (Levels)	Output Quality Values (Levels)	Operating Mode Probability	
					Algebraic Expression	Value
$s_{\Upsilon_P}^1$	(s_1^1, s_2^1)	1X1	$\langle 50, 40, 30, 10 \rangle$	$\langle 40, 30, 25, 10 \rangle$	$r_{1,1} \cdot r_{2,1}$	0.760
$s_{\Upsilon_P}^2$	(s_1^1, s_2^2)	1X0	$\langle 50, 30, 20 \rangle$	$\langle 40, 25, 10 \rangle$	$r_{1,1} \cdot (1 - r_{2,1})$	0.040
$s_{\Upsilon_P}^3$	(s_2^1, s_1^2)	011	$\langle 50, 40, 30, 10 \rangle$	$\langle 35, 30, 25, 10 \rangle$	$(1 - r_{1,1}) \cdot 2_{3,2} \cdot r_{2,1}$	0.133
$s_{\Upsilon_P}^4$	(s_1^1, s_3^1)	1XY	$\langle 50, 30, 20 \rangle$	$\langle 40, 25, 10 \rangle$	$r_{1,1}$	0.800
$s_{\Upsilon_P}^5$	(s_3^1, s_2^1)	Y11	$\langle 50, 40, 30, 10 \rangle$	$\langle 35, 30, 25, 10 \rangle$	$r_{1,2} \cdot r_{2,1}$	0.665
$s_{\Upsilon_P}^6$	(s_2^2, s_2^2)	010	$\langle 50, 30, 20 \rangle$	$\langle 35, 25, 10 \rangle$	$(1 - r_{1,1}) \cdot r_{1,2} \cdot (1 - r_{2,1})$	0.007
$s_{\Upsilon_P}^7$	(s_3^3, s_2^2)	Y10	$\langle 50, 30, 20 \rangle$	$\langle 35, 25, 10 \rangle$	$r_{1,2} \cdot (1 - r_{2,1})$	0.035
$s_{\Upsilon_P}^8$	(s_4^1, s_1^2)	001	$\langle 40, 10 \rangle$	$\langle 30, 10 \rangle$	$(1 - r_{1,1}) \cdot (1 - r_{1,2}) \cdot r_{2,1}$	0.057
$s_{\Upsilon_P}^9$	(s_2^2, s_2^3)	01Y	$\langle 50, 30, 20 \rangle$	$\langle 35, 25, 10 \rangle$	$(1 - r_{1,1}) \cdot r_{1,2}$	0.140
$s_{\Upsilon_P}^{10}$	(s_5^1, s_2^1)	0Y1	$\langle 40, 10 \rangle$	$\langle 30, 10 \rangle$	$(1 - r_{1,1}) \cdot r_{2,1}$	0.190
$s_{\Upsilon_P}^{11}$	(s_3^3, s_3^3)	Y1Y	$\langle 50, 30, 20 \rangle$	$\langle 35, 25, 10 \rangle$	$r_{1,2}$	0.700
$s_{\Upsilon_P}^{12}$	(s_6^1, s_1^2)	Y01	$\langle 40, 10 \rangle$	$\langle 30, 10 \rangle$	$(1 - r_{1,2}) \cdot r_{2,1}$	0.285
$s_{\Upsilon_P}^{13}$	(s_7^1, s_2^1)	YY1	$\langle 40, 10 \rangle$	$\langle 30, 10 \rangle$	$r_{2,1}$	0.950
$s_{\Upsilon_P}^{14}$	(s_4^2, s_2^2)	000	$\langle 0 \rangle$	$\langle 0 \rangle$	$(1 - r_{1,1}) \cdot (1 - r_{1,2}) \cdot (1 - r_{2,1})$	0.003
$s_{\Upsilon_P}^{15}$	(s_5^1, s_2^2)	0Y0	$\langle 0 \rangle$	$\langle 0 \rangle$	$(1 - r_{1,1}) \cdot (1 - r_{2,1})$	0.010
$s_{\Upsilon_P}^{16}$	(s_6^1, s_2^2)	Y00	$\langle 0 \rangle$	$\langle 0 \rangle$	$(1 - r_{1,2}) \cdot (1 - r_{2,1})$	0.015
$s_{\Upsilon_P}^{17}$	(s_7^1, s_2^2)	YY0	$\langle 0 \rangle$	$\langle 0 \rangle$	$(1 - r_{2,1})$	0.050
$s_{\Upsilon_P}^{18}$	(s_4^1, s_3^2)	00Y	$\langle 0 \rangle$	$\langle 0 \rangle$	$(1 - r_{1,1}) \cdot (1 - r_{1,2})$	0.060
$s_{\Upsilon_P}^{19}$	(s_5^1, s_3^2)	0YY	$\langle 0 \rangle$	$\langle 0 \rangle$	$(1 - r_{1,1})$	0.200
$s_{\Upsilon_P}^{20}$	(s_6^1, s_3^2)	Y0Y	$\langle 0 \rangle$	$\langle 0 \rangle$	$(1 - r_{1,2})$	0.300
$s_{\Upsilon_P}^{21}$	(s_7^1, s_3^2)	YYY	$\langle 0 \rangle$	$\langle 0 \rangle$	1	1.000

Table 5. QRModel Configuration Details after the Example Parallel Composition: $\mathcal{Q}_{\Upsilon_P}^{max} = \mathcal{Q}_1 \parallel \mathcal{Q}_2$ (Max. Quality O/P)

QRModel for this, say \mathcal{Q}_{Υ_P} , comprising of the component C_1 connected in parallel with the component C_2 . Formally, $\mathcal{Q}_{\Upsilon_P} = \mathcal{Q}_1 \parallel \mathcal{Q}_2$, where \mathcal{Q}_3 and \mathcal{Q}_2 are already defined in Example 4 (with Figure 4 and Table 3).

Here for Υ_P , the derived QRModel, $\mathcal{Q}_{\Upsilon_P}^{max}$ and $\mathcal{Q}_{\Upsilon_P}^{ord}$, considering both the *maximum* and the *ordered* quality output, which are represented by the state transition diagram and the configuration details corresponding to every state, is expressed in Figure 6 with Table 5 and Figure 6 with Table 6, respectively. Note that, the state transition, mode configuration and the operating mode reliability attributes are same for both these variants, however the input-output quality measures differ due to their varied treatment. For Υ_P , we have:

- The set of 2 participating components as, $C_{\Upsilon_P} = \{C_1, C_2\}$
- The set of 3 input quality levels as, $Q_{\Upsilon_P}^I = \{50, 40, 30, 20, 10\}$.

State ID	Composite State Pair	Operating Mode Configuration	Input Quality Values (Levels)	Output Quality Values (Levels)	Operating Mode Probability	
					Algebraic Expression	Value
$s_{\Upsilon_P}^1$	(s_1^1, s_2^1)	1X1	$\langle 50, 30, 20 \rangle$	$\langle 40, 25, 10 \rangle$	$r_{1,1} \cdot r_{2,1}$	0.760
$s_{\Upsilon_P}^2$	(s_1^1, s_2^2)	1X0	$\langle 50, 30, 20 \rangle$	$\langle 40, 25, 10 \rangle$	$r_{1,1} \cdot (1 - r_{2,1})$	0.040
$s_{\Upsilon_P}^3$	(s_1^2, s_2^1)	011	$\langle 50, 30, 20 \rangle$	$\langle 35, 25, 10 \rangle$	$(1 - r_{1,1}) \cdot 23,2 \cdot r_{2,1}$	0.133
$s_{\Upsilon_P}^4$	(s_1^1, s_2^3)	1XY	$\langle 50, 30, 20 \rangle$	$\langle 40, 25, 10 \rangle$	$r_{1,1}$	0.800
$s_{\Upsilon_P}^5$	(s_1^3, s_2^1)	Y11	$\langle 50, 30, 20 \rangle$	$\langle 35, 25, 10 \rangle$	$r_{1,2} \cdot r_{2,1}$	0.665
$s_{\Upsilon_P}^6$	(s_1^2, s_2^2)	010	$\langle 50, 30, 20 \rangle$	$\langle 35, 25, 10 \rangle$	$(1 - r_{1,1}) \cdot r_{1,2} \cdot (1 - r_{2,1})$	0.007
$s_{\Upsilon_P}^7$	(s_1^3, s_2^2)	Y10	$\langle 50, 30, 20 \rangle$	$\langle 35, 25, 10 \rangle$	$r_{1,2} \cdot (1 - r_{2,1})$	0.035
$s_{\Upsilon_P}^8$	(s_1^4, s_2^1)	001	$\langle 40, 10 \rangle$	$\langle 30, 10 \rangle$	$(1 - r_{1,1}) \cdot (1 - r_{1,2}) \cdot r_{2,1}$	0.057
$s_{\Upsilon_P}^9$	(s_1^2, s_2^2)	01Y	$\langle 50, 30, 20 \rangle$	$\langle 35, 25, 10 \rangle$	$(1 - r_{1,1}) \cdot r_{1,2}$	0.140
$s_{\Upsilon_P}^{10}$	(s_1^5, s_2^1)	0Y1	$\langle 40, 10 \rangle$	$\langle 30, 10 \rangle$	$(1 - r_{1,1}) \cdot r_{2,1}$	0.190
$s_{\Upsilon_P}^{11}$	(s_1^3, s_2^3)	Y1Y	$\langle 50, 30, 20 \rangle$	$\langle 35, 25, 10 \rangle$	$r_{1,2}$	0.700
$s_{\Upsilon_P}^{12}$	(s_1^6, s_2^1)	Y01	$\langle 40, 10 \rangle$	$\langle 30, 10 \rangle$	$(1 - r_{1,2}) \cdot r_{2,1}$	0.285
$s_{\Upsilon_P}^{13}$	(s_1^7, s_2^1)	YY1	$\langle 40, 10 \rangle$	$\langle 30, 10 \rangle$	$r_{2,1}$	0.950
$s_{\Upsilon_P}^{14}$	(s_1^4, s_2^2)	000	$\langle 0 \rangle$	$\langle 0 \rangle$	$(1 - r_{1,1}) \cdot (1 - r_{1,2}) \cdot (1 - r_{2,1})$	0.003
$s_{\Upsilon_P}^{15}$	(s_1^5, s_2^2)	0Y0	$\langle 0 \rangle$	$\langle 0 \rangle$	$(1 - r_{1,1}) \cdot (1 - r_{2,1})$	0.010
$s_{\Upsilon_P}^{16}$	(s_1^6, s_2^2)	Y00	$\langle 0 \rangle$	$\langle 0 \rangle$	$(1 - r_{1,2}) \cdot (1 - r_{2,1})$	0.015
$s_{\Upsilon_P}^{17}$	(s_1^7, s_2^2)	YY0	$\langle 0 \rangle$	$\langle 0 \rangle$	$(1 - r_{2,1})$	0.050
$s_{\Upsilon_P}^{18}$	(s_1^4, s_2^3)	00Y	$\langle 0 \rangle$	$\langle 0 \rangle$	$(1 - r_{1,1}) \cdot (1 - r_{1,2})$	0.060
$s_{\Upsilon_P}^{19}$	(s_1^5, s_2^3)	0YY	$\langle 0 \rangle$	$\langle 0 \rangle$	$(1 - r_{1,1})$	0.200
$s_{\Upsilon_P}^{20}$	(s_1^6, s_2^3)	Y0Y	$\langle 0 \rangle$	$\langle 0 \rangle$	$(1 - r_{1,2})$	0.300
$s_{\Upsilon_P}^{21}$	(s_1^7, s_2^3)	YYY	$\langle 0 \rangle$	$\langle 0 \rangle$	1	1.000

Table 6. QRModel Configuration Details after the Example Parallel Composition: $Q_{\Upsilon_P}^{ord} = Q_1 \parallel Q_2$ (Ord. Quality O/P)

- The set of 3 symbolic reliability variables as, $R_{\Upsilon_P} = \{r_{1,1}, r_{1,2}, r_{2,1}\}$ with values, 0.8, 0.7, 0.95, respectively.
- The set of 21 states, $S_{\Upsilon_P} = \{s_{\Upsilon_P}^1, s_{\Upsilon_P}^2, \dots, s_{\Upsilon_P}^{21}\}$.
- The state configurations are given as,
 $\Gamma_{\Upsilon_P}(s_{\Upsilon_P}^1) = \Gamma_{\Upsilon_1}(s_1^1) \odot \Gamma_{\Upsilon_2}(s_2^1) = 1X1$, $\Gamma_{\Upsilon_P}(s_{\Upsilon_P}^2) = \Gamma_{\Upsilon_1}(s_1^1) \odot \Gamma_{\Upsilon_2}(s_2^2) = 1X0$, ... so on.
- Under *maximum quality output* criteria, all derived output quality values are given in Table 5. To exemplify the derivation,
 $Q_{\Upsilon_P}^O(s_{\Upsilon_P}^1, 50) = \text{MAX}[Q_1^O(s_1^1, 50), Q_2^O(s_2^1, 50)] = \text{MAX}[Q_1^O(s_1^1, 50), Q_2^O(s_2^1, 40)] = \text{MAX}[40, 30] = 40$.
(since $\{50\} \notin Q_2^I$ whereas $\{40\} \in Q_2^I$ and $50 > 40$ being the immediate next input level)
Under *ordered quality output* criteria (with $C_1 \prec C_2$ as given order), all derived output quality values are given in Table 6. To exemplify the derivation, let us understand the following two derivation:
 - $Q_{\Upsilon_P}^O(s_{\Upsilon_P}^1, 50) = Q_1^O(s_1^1, 50) = 40$ (since $C_1 \prec C_2$ and C_1 has not failed),
 - $Q_{\Upsilon_P}^O(s_{\Upsilon_P}^8, 40) = Q_2^O(s_2^1, 40) = 30$ (since C_1 has completely failed, C_2 dictates the output quality)
- All state transitions (both failure and suspension) are shown in Figure 6. To exemplify the derivation,
 - The failure transitions are, $T_{\Upsilon_P}^F = \{(s_{\Upsilon_P}^1, s_{\Upsilon_P}^2), (s_{\Upsilon_P}^1, s_{\Upsilon_P}^3), \dots\}$.
(marked with dotted edges and labeled using F)
 - The suspend transitions are, $T_{\Upsilon_P}^C = \{(s_{\Upsilon_P}^1, s_{\Upsilon_P}^4), (s_{\Upsilon_P}^1, s_{\Upsilon_P}^5), \dots\}$.
(marked with solid edges and labeled using C)
- All algebraic operational probability expressions are shown in Table 5 or in Table 6 (these are same for both variants). To exemplify the derivation,
 $\text{Expr}_{\Upsilon_P}(s_{\Upsilon_P}^1) = r_{1,1} \cdot r_{2,1}$; $\text{Expr}_{\Upsilon_P}(s_{\Upsilon_P}^2) = r_{1,1} \cdot (1 - r_{2,1})$; $\text{Expr}_{\Upsilon_P}(s_{\Upsilon_P}^3) = (1 - r_{1,1}) \cdot r_{1,2} \cdot r_{2,1}$; ... so on.

There may be multiple choices from an operational state upon its failure or suspend and such a choice can lead to any one among these options *non-deterministically*. \square

It may be noted that, the series and parallel composition mechanisms with respect to given subsystem structures are similar except the computation of output quality values. This is due to the fact that the underlying model of computation is a state transition diagram which composes pair of states from two subsystems, thereby maintaining identical configurations in both cases.

4.3. Generic Composition Procedures

In order to compute the composed **QRModel** for a generic series/parallel system structure, we hierarchically use the series and the parallel composition operations, as mentioned above.

4.3.1. Properties of Composition Operations

Such compositional rules can be applied hierarchically due to the satisfaction of some inherent properties of composition operations, which are listed below. (Assume: Q_a, Q_b, Q_c are three **QRModels**.)

Idempotent Properties:

- (a) Series (\circ) composition operation is *not* idempotent, i.e., $Q_a \circ Q_a \neq Q_a$.
- (b) Parallel (\parallel) composition operation is idempotent, i.e., $Q_a \parallel Q_a \equiv Q_a$.

Associative Properties:

- (a) Series (\circ) composition operation is associative, i.e., $(Q_a \circ Q_b) \circ Q_c \equiv Q_a \circ (Q_b \circ Q_c)$.
- (b) Parallel (\parallel) composition operation is associative, i.e., $(Q_a \parallel Q_b) \parallel Q_c \equiv Q_a \parallel (Q_b \parallel Q_c)$.

Commutative Properties:

- (a) Series (\circ) composition operation is *not* commutative, i.e., $Q_a \circ Q_b \neq Q_b \circ Q_a$.
- (b) Parallel (\parallel) composition operation is commutative, i.e., $Q_a \parallel Q_b \equiv Q_b \parallel Q_a$.

Distributive Properties:

- (a) Series (\circ) composition operation is distributive over Parallel (\parallel) composition operation, i.e., $Q_a \circ (Q_b \parallel Q_c) \equiv (Q_a \circ Q_b) \parallel (Q_a \circ Q_c)$.
- (b) Parallel (\parallel) composition operation is *not* distributive over Series (\circ) composition operation, i.e., $Q_a \parallel (Q_b \circ Q_c) \neq (Q_a \parallel Q_b) \circ (Q_a \parallel Q_c)$.

The distributive nature of \circ over \parallel establishes the fact that any series-parallel composition is equivalent to parallel composition of all paths (where each path components are composed in series) from input to output (which is basically the path-enumeration based rule).

4.3.2. Composition Rules

As an example, the **QRModel** for the system, Υ_{sp} (refer to Figure 2), can be computed in two ways leveraging the generic composition techniques proposed above.

- *Using Series/Parallel-Structure based Composition Rule:* The **QRModel** for the two subsystems, Υ_S (the system structure is shown in Figure 3(a)) and Υ_P (the system structure is shown in Figure 3(b)), are already computed in Example 5 and Example 6, respectively. The **QRModel** for the overall system, Υ_{sp} (shown in Figure 2), i.e. $Q_{\Upsilon_{sp}}$, is the parallel quality composition of Q_{Υ_P} and Q_{Υ_S} again, and it can be formally derived as: $Q_{\Upsilon_{sp}} = (Q_{\Upsilon_P} \parallel Q_{\Upsilon_S}) = \left((Q_1 \parallel Q_2) \parallel (Q_3 \circ Q_2) \right)$
- *Using Path-Enumeration based Composition Rule:* There are three paths from input to output of Υ_{sp} , namely through C_1 , through C_2 and through C_3 - C_2 . The quality measure for the overall system, Υ_{sp} , that is $Q_{\Upsilon_{sp}}$, is the parallel quality composition of C_1 (say Q_1), C_2 (say Q_2) and Υ_S (say Q_{Υ_S}), and it can be derived expressed as: $Q_{\Upsilon_{sp}} = (Q_1 \parallel Q_2 \parallel Q_{\Upsilon_S}) = \left(Q_1 \parallel Q_2 \parallel (Q_3 \circ Q_2) \right)$

It is worthy to note two points here as follows:

- The order of serial and parallel compositions may be arbitrary in a composite expression as long as their associative, commutative and distributive properties, as discussed above, remain intact.
- The quality configuration model for non-series/parallel systems is determined using the *path-enumeration* techniques. Here, we can apply the series composition rules over all the component structures that reside in every path from input to the output of the system. Finally, the parallel composition is applied over each of these new composed quality measures for each end-to-end path to get the overall system quality.

5. Conformance Check for System-level QRSpec from QRModel Configurations

The QRModel of a system describes the formal characterization of its quality attributes using an underlying state-transition model based configuration. Such a formalization is useful for assessing quality and reliability properties of systems, which we shall be detailing in the next section. However, from an user perspective, the architectural QRSpec of systems forms a foundational basis, as defined in Section 2.2. Such type of specification, depicting system fault-tolerant behavior with only with failure provisions, is naïve and abstract. So, it is imperative to infer the high-level specifications expressing the system-level quality and reliability measures by refining our formal modeling. In the following, we present the steps to automatically extract back the QRSpecs, $\mathcal{P}_\Upsilon = \langle C_\Upsilon, M_\Upsilon, Z_\Upsilon, Q_\Upsilon^I, Q_\Upsilon^O \rangle$, from the underlying QRModel, $\mathcal{Q}_\Upsilon = \langle C_\Upsilon, Q_\Upsilon^I, R_\Upsilon, S_\Upsilon, s_\Upsilon^1, \Gamma_\Upsilon, Q_\Upsilon^O, T_\Upsilon, \text{Expr}_\Upsilon \rangle$, of the system, Υ .

Step-1: Make abstractions to the QRModel representation (state-transition system), \mathcal{Q}_Υ , keeping only the failure (marked as F) transitions and relevant states to build a new configuration, say \mathcal{Q}'_Υ . This can be easily obtained by doing a depth-first or breadth-first traversal starting from the initial state of \mathcal{Q}_Υ and progressing only through the F-marked transitions.

Step-2: Represent the composed system modes with respect to the operating modes of each n participating components together as an n -tuple. If Υ comprises of n components, where each component C_i ($1 \leq i \leq n$) operates in m_i number of operational modes (excluding the failure mode), then the length every state configuration is $e_\Upsilon = \sum_{i=1}^n d_i$. Here, if for some state $s \in S_\Upsilon$ in \mathcal{Q}'_Υ , we find that,

$\exists k_i$ ($1 \leq \delta < k_i \leq \delta + d_i \leq e_\Upsilon$), where $\delta = \sum_{j=0}^{i-1} d_j$ ($1 \leq i \leq n$), such that the following holds:

$$\Gamma_\Upsilon(s)[(\delta + 1)..(\delta + k_i - 1)] = 0^{(k_i - 1)}, \Gamma_\Upsilon(s)[\delta + k_i] = 1 \text{ and } \Gamma_\Upsilon(s)[(\delta + k_i + 1)..(\delta + d_i)] = \mathbf{X}^{(d_i - k_i)},$$

then the operating mode for the participating component, C_i , is $m_i^{k_i}$. The combination of the modes, $(m_1^{k_1}, m_2^{k_2}, \dots, m_n^{k_n})$, for all the components, C_1, C_2, \dots, C_n , gives the operating modes for the system, Υ , in state, s . Formally, $m_\Upsilon^s = (m_1^{k_1}, m_2^{k_2}, \dots, m_n^{k_n}) \in M_\Upsilon$.

Step-3: Estimate the reliability of each mode from the system structure, $\Upsilon = \langle \mathcal{I}, \mathcal{O}, \mathcal{C}, \mathcal{V}, \mathcal{E}, \mathcal{L} \rangle$. To do so, traditional reliability estimation methods [26] are followed using typical path-enumeration or series/parallel approaches utilizing the reliability value $Z_i(m_i^j)$ for mode m_i^j of component C_i ($1 \leq i \leq n$, $1 \leq j \leq d_i$).

Step-4: Establish the output quality value function Q_Υ^O at each of the composite operational modes of the abstracted QRModel, \mathcal{Q}'_Υ . The QRModel directly lists the output quality values corresponding to each state (modes) of Υ with respect to the mentioned input level, thereby defining Q_Υ^O . However, Q_Υ^I can be found taking the union of input quality levels present in every state/mode of \mathcal{Q}'_Υ .

The above steps reverse synthesize the QRSpec model by only keeping the component mode failure option in the overall system behavior. Let us present an example to illustrate these mentioned steps in details.

Example 7. First, let us revisit the QRModel, \mathcal{Q}_{Υ_S} , obtained for system, Υ_S , in Example 5 (and Figure 5 with Table 4). *Step-1* abstracts \mathcal{Q}_{Υ_S} to form $\mathcal{Q}'_{\Upsilon_S}$ which is shown in Figure 7(a) with Table 9 (for Υ_S). According to *Step-2*, the generated composite modes are labeled against the states of $\mathcal{Q}'_{\Upsilon_S}$ as mentioned in Table 7 (also refer to Figure 7(a)). Then, from the system structure of Υ_S (also schematic is shown in Figure 3(a)), we derive in *Step-3* the reliability of each composite modes by taking product of the two component-level reliability values, i.e. $Z_{\Upsilon_S}((m_3^i, m_2^j)) = Z_3(m_3^i) \cdot Z_2(m_2^j)$ ($0 \leq i \leq 2$, $0 \leq j \leq 1$). As part of *Step-4*, the input-output quality levels (values) can be directly found from QRModel, \mathcal{Q}_{Υ_S} (Figure 5 with Table 4). We find that the outcomes of *Step-3* and *Step-4* (presented in Tables 7-9) are similar to what has been (already) specified as reliability and input-output quality value-pairs in Table 1.

Similarly, let us revisit the QRModel, $\mathcal{Q}_{\Upsilon_P}^{max}$, obtained for system, Υ_P , in Example 6 (and Figure 6 with Table 5). *Step-1* abstracts $\mathcal{Q}_{\Upsilon_P}^{max}$ to form $\mathcal{Q}'_{\Upsilon_P}^{max}$ which is shown in Figure 7(b) with Table 9 (for Υ_P). According to *Step-2*, the generated composite modes are labeled against the states of $\mathcal{Q}'_{\Upsilon_P}^{max}$ as mentioned in Table 8 (also refer to Figure 7(b)). Then, from the system structure of Υ_P (also schematic is shown in Figure 3(b)), we derive in *Step-3* the reliability of each composite modes by composing the two component-level reliability values in parallel, i.e. $Z_{\Upsilon_P}((m_1^i, m_2^j)) = 1 - (1 - Z_1(m_1^i)) \cdot (1 - Z_2(m_2^j))$ ($0 \leq i \leq 2$, $0 \leq j \leq 1$). As part of *Step-4*, the input-output quality levels (values) can be directly found from QRModel, $\mathcal{Q}_{\Upsilon_P}^{max}$ (Figure 6

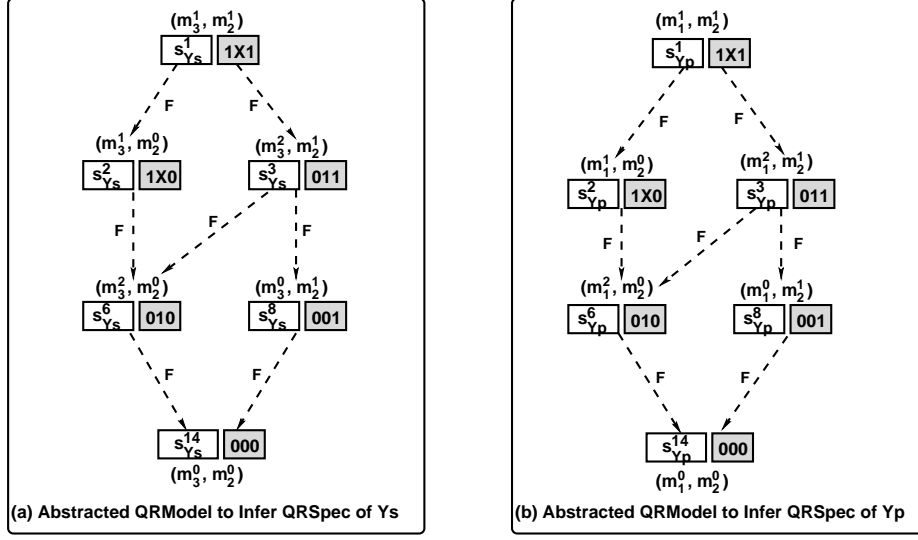

Fig. 7. State Transition Diagram with State Labels as Composite Component-Mode Tuples for the Abstracted QRModel, $\mathcal{Q}'_{\Upsilon_S}$ and $\mathcal{Q}^{max}_{\Upsilon_P}$, Inferred from Quality Configurations, \mathcal{Q}_{Υ_S} and $\mathcal{Q}^{max}_{\Upsilon_P}$, respectively (Introduced in Examples 5-6)

System State	Component Mode (Composite Tuple)	System Mode
$s^1_{\Upsilon_S}$	(m^1_3, m^1_2)	$m^1_{\Upsilon_S}$
$s^2_{\Upsilon_S}$	(m^1_3, m^0_2)	$m^0_{\Upsilon_S}$
$s^3_{\Upsilon_S}$	(m^2_3, m^1_2)	$m^2_{\Upsilon_S}$
$s^6_{\Upsilon_S}$	(m^2_3, m^0_2)	$m^0_{\Upsilon_S}$
$s^8_{\Upsilon_S}$	(m^0_3, m^1_2)	$m^0_{\Upsilon_S}$
$s^{14}_{\Upsilon_S}$	(m^0_3, m^0_2)	$m^0_{\Upsilon_S}$

Table 7. Composite Operating Modes w.r.t. $\mathcal{Q}'_{\Upsilon_S}$ States

System State	Component Mode (Composite Tuple)	System Mode
$s^1_{\Upsilon_P}$	(m^1_1, m^1_2)	$m^3_{\Upsilon_P}$
$s^2_{\Upsilon_P}$	(m^1_1, m^0_2)	$m^2_{\Upsilon_P}$
$s^3_{\Upsilon_P}$	(m^2_1, m^1_2)	$m^5_{\Upsilon_P}$
$s^6_{\Upsilon_P}$	(m^2_1, m^0_2)	$m^4_{\Upsilon_P}$
$s^8_{\Upsilon_P}$	(m^0_1, m^1_2)	$m^1_{\Upsilon_P}$
$s^{14}_{\Upsilon_P}$	(m^0_1, m^0_2)	$m^0_{\Upsilon_P}$

Table 8. Composite Operating Modes w.r.t. $\mathcal{Q}^{max}_{\Upsilon_P}$ States

with Table 5). We find that the outcomes of *Step-3* and *Step-4* (presented in Tables 8-9) are similar to what has been (already) specified as reliability and input-output quality value-pairs in Table 2.

In order to complete the conformance checking of automatically inferred QRSpec, \mathcal{P}_{Υ_S} and \mathcal{P}_{Υ_P} , from QRModel, \mathcal{Q}_{Υ_S} and $\mathcal{Q}^{max}_{\Upsilon_P}$, respectively, the reader may cross-check Table 1 (from Example 3) with Tables 7-9 and Figure 7(a), as well as Table 2 (from Example 3) with Tables 8-9 and Figure 7(b). \square

It may be noted that, the above mentioned steps provide an generic inferencing procedure, aiding to the

System Name	State ID	Operating Mode Configuration	Input Quality Values (Levels)	Output Quality Values (Levels)	Operating Mode Probability	
					Algebraic Expression	Value
Υ_S	$s^1_{\Upsilon_S}$	1X1	$\langle 50, 20 \rangle$	$\langle 30, 10 \rangle$	$r_{3,1}.r_{2,1}$	0.855
	$s^2_{\Upsilon_S}$	1X0	$\langle 0 \rangle$	$\langle 0 \rangle$	$r_{3,1}.(1 - r_{2,1})$	0.045
	$s^3_{\Upsilon_S}$	011	$\langle 50, 20 \rangle$	$\langle 30, 10 \rangle$	$(1 - r_{3,1}).r_{3,2}.r_{2,1}$	0.076
	$s^6_{\Upsilon_S}$	010	$\langle 0 \rangle$	$\langle 0 \rangle$	$(1 - r_{3,1}).r_{3,2}.(1 - r_{2,1})$	0.004
	$s^8_{\Upsilon_S}$	001	$\langle 0 \rangle$	$\langle 0 \rangle$	$(1 - r_{3,1}).(1 - r_{3,2}).r_{2,1}$	0.019
	$s^{14}_{\Upsilon_S}$	000	$\langle 0 \rangle$	$\langle 0 \rangle$	$(1 - r_{3,1}).(1 - r_{3,2}).(1 - r_{2,1})$	0.001
Υ_P	$s^1_{\Upsilon_P}$	1X1	$\langle 50, 40, 30, 10 \rangle$	$\langle 40, 30, 25, 10 \rangle$	$r_{1,1}.r_{2,1}$	0.760
	$s^2_{\Upsilon_P}$	1X0	$\langle 50, 30, 20 \rangle$	$\langle 40, 25, 10 \rangle$	$r_{1,1}.(1 - r_{2,1})$	0.040
	$s^3_{\Upsilon_P}$	011	$\langle 50, 40, 30, 10 \rangle$	$\langle 35, 30, 25, 10 \rangle$	$(1 - r_{1,1}).r_{3,2}.r_{2,1}$	0.133
	$s^6_{\Upsilon_P}$	010	$\langle 50, 30, 20 \rangle$	$\langle 35, 25, 10 \rangle$	$(1 - r_{1,1}).r_{1,2}.(1 - r_{2,1})$	0.007
	$s^8_{\Upsilon_P}$	001	$\langle 40, 10 \rangle$	$\langle 30, 10 \rangle$	$(1 - r_{1,1}).(1 - r_{1,2}).r_{2,1}$	0.057
	$s^{14}_{\Upsilon_P}$	000	$\langle 0 \rangle$	$\langle 0 \rangle$	$(1 - r_{1,1}).(1 - r_{1,2}).(1 - r_{2,1})$	0.003

Table 9. Abstracted QRModel Configuration Details, $\mathcal{Q}'_{\Upsilon_S}$ and $\mathcal{Q}^{max}_{\Upsilon_P}$, obtained from \mathcal{Q}_{Υ_S} and $\mathcal{Q}^{max}_{\Upsilon_P}$ for Υ_S and Υ_P

automatic synthesis of $\text{QRSpec}(\mathcal{P}_\Upsilon)$ which may further be checked for conformance against the already laid specifications to ensure the correctness of the built system in terms of its quality and reliability artifacts. Such conformance checking may happen either through manual inspection, or through a systematic query-based engine (which is able to provide more detailed information from underlying QRModel), by which designers may explore the quality and reliability measures of a system under various operational setup of its constituent components leading to comprehensive coverage. The following section presents this part in details.

6. Query Processing and Analysis over System-level QRModel

To explore the system completeness with respect to quality and reliability specifications, we first develop a language through which we can interact with the system-level QRModel in order to extract various relevant parameters under different operating conditions of the system. Such an exploration can be performed at architectural-level and it helps the designer to determine the coverage of the system in terms of its best and worst possible measures of quality and reliability attributes attainable with the given compositional structure having the possibility of component failures and suspensions as part of the operating setups.

6.1. Structured Query Description Language (SQDL)

We propose a structured query description language, named as SQDL, to express various queries related to a given component-based system structure. SQDL enjoys similar and simple syntactic sugar as that of SQL (Structured Query Language). The detailed syntax for expressing each *query-block* is given below.

```

begin_query [ IDENTIFIER ]
  select
    [ - input_quality ]
    [ - output_quality ]
    [ - operating_mode ]
    [ - reliability ]
    [ - operate_prob ]
    [ - failure ]
    [ - suspend ]
  from
    - system SYSTEM_STRUCTURE_FILE
    - qrspec COMPONENT_QRSPEC_FILE
  where
    [ - input_quality   VALUE_LIST ]
    [ - output_quality [ - minimum VALUE_LIST ] [ - maximum VALUE_LIST ] ]
    [ - reliability     [ - minimum VALUE ] [ - maximum VALUE ] ]
    [ - operate_prob    [ - minimum VALUE ] [ - maximum VALUE ] ]
    [ - failure         [ - minimum NUMBER ] [ - maximum NUMBER ] ]
    [ - suspend         [ - minimum NUMBER ] [ - maximum NUMBER ] ]
end_query

```

It may be noted that, each three-part (**select - from - where**) query specification is encapsulated using “**begin_query ... end_query**” block and all *small-letter* phrases (that followed after a ‘-’) indicate the reserved keywords for query specification. The syntax, **[...]**, indicates that those attributes are optional in query specification. Each query is given a name which is indicated by the **IDENTIFIER**. The input system structure description and the component-level **QRSPEC** definitions are provided using **SYSTEM_STRUCTURE_FILE** and **COMPONENT_QRSPEC_FILE**. Moreover, using the placeholders, **VALUE**, **VALUE_LIST** and **NUMBER**, we indicate a real number, a list of real values (within **{...}** separated by comma), and an integer, respectively.

Semantically, the architectural component-based system structure with the **QRSpec** definitions for each component is chosen from the files mentioned in **from** block. The **select** block proposes to extract the following information: (i) the coverage for input-output quality ranges supported by the system, (ii) the

ranges for its reliability and operating probability, (iii) the supporting operational modes of the components, (iv) the minimum and maximum failures or suspensions admissible by the system. These extraction are subject to the constraints of the system as specified under **where** block having the options of constraining for the following: (i) the prescribed quality values to be attained, (ii) the highest and lowest reliability and operating probability allowed, (iii) the predicted choice of failures and suspensions required during operations.

The following example presents two queries and their representations in SQDL to bring out the essence.

Example 8. Let us first specify (in English) the intent of two example queries over a system as follows:

Query1: *What are the operating modes with their respective set of input-output quality levels (values) and reliability values supported by the system, when we try to operate it maintaining the input quality levels at least 30, with the system reliability guarantee be above 0.85 and allowing a maximum of 2 component failures and without suspending any component?*

Query2: *How many component failures can be tolerated and in which operating modes (with their operating probability) the system can operate in those cases, when we want to maintain the minimum output-quality values as $\langle 30, 25, 10, 5 \rangle$ corresponding to the given input-quality levels $\langle 40, 30, 15, 5 \rangle$, respectively, with the system reliability guarantee be above 0.95 and a maximum of 1 component may be suspended?*

We may express these queries using our proposed SQDL framework as:

```
begin_query Query1
  select
    - input_quality
    - output_quality
    - operating_mode
    - reliability
  from
    - system file.sys
    - qrspec spec.qr
  where
    - input_quality { 30 }
    - reliability
      - minimum 0.85
    - failure
      - maximum 2
    - control
      - maximum 0
end_query
```

```
begin_query Query2
  select
    - operating_mode
    - operate_prob
    - failure
  from
    - system file.sys
    - qrspec spec.qr
  where
    - input_quality { 40,30,15,5 }
    - output_quality
      - minimum { 30,25,10,5 }
    - reliability
      - minimum 0.95
    - suspend
      - maximum 1
end_query
```

Note that, the system structure will be supplied as a directed acyclic graph (as defined formally in Section 2.1) through the formatted file, **file.sys** and the **QRSpec** for each component module (as defined formally in Section 2.2) will be described through the formatted file, **spec.qr**. \square

Interestingly, this query platform can also be used to easily abstract any system behavior out of its **QRModel**. So, in order to infer back the **QRSpec** (as discussed in Section 5), we may write a simple query only constraining the maximum number of control to be 0 and hence retrieving all possible failure options of the system.

In the next subsection, we discuss how the query is processed to retrieve results from the system **QRModel**.

6.2. Query-driven System Behavior Assessment

The query-driven analysis framework helps the component-based system designer by providing a meaningful coverage information related to the quality and reliability attributes of systems through extraction of a range of admissible design configurations. Thereby, it also helps the designer to explore through multiple system setups and finally converge into meaningful compositions of reliable and quality system design. The processing and retrieval of quality measures by our proposed framework are done involving three basic steps.

Mode Configuration	Component Operating Modes		Input Quality Levels	Output Quality Values	Reliability
1X1	$C_1 = (m_1^1 : \text{OP}, m_2^1 : \text{NA})$	$C_2 = (m_2^2 : \text{OP})$	$\langle 50, 40, 30 \rangle$	$\langle 40, 30, 25 \rangle$	0.990
011	$C_1 = (m_1^1 : \text{FL}, m_2^1 : \text{OP})$	$C_2 = (m_2^2 : \text{OP})$	$\langle 50, 40, 30 \rangle$	$\langle 35, 30, 25 \rangle$	0.985
001	$C_1 = (m_1^1 : \text{FL}, m_2^1 : \text{FL})$	$C_2 = (m_2^2 : \text{OP})$	$\langle 40 \rangle$	$\langle 30 \rangle$	0.950

Table 10. Extracted Results over Υ_P from Query1 (OP: Operating, FL: Failed, NA: Not-Availed)

Mode Configuration	Component Operating Modes		Operating Probability	# Failure
1X1	$C_1 = (m_1^1 : \text{OP}, m_2^1 : \text{NA})$	$C_2 = (m_2^2 : \text{OP})$	0.760	0
011	$C_1 = (m_1^1 : \text{FL}, m_2^1 : \text{OP})$	$C_2 = (m_2^2 : \text{OP})$	0.133	0
001	$C_1 = (m_1^1 : \text{FL}, m_2^1 : \text{FL})$	$C_2 = (m_2^2 : \text{OP})$	0.057	1*
0Y1	$C_1 = (m_1^1 : \text{FL}, m_2^1 : \text{SU})$	$C_2 = (m_2^2 : \text{OP})$	0.190	0
Y11	$C_1 = (m_1^1 : \text{SU}, m_2^1 : \text{OP})$	$C_2 = (m_2^2 : \text{OP})$	0.665	0
Y01	$C_1 = (m_1^1 : \text{SU}, m_2^1 : \text{FL})$	$C_2 = (m_2^2 : \text{OP})$	0.285	0

Table 11. Extracted Results over Υ_P from Query2 (OP: Operating, FL: Failed, SU: Suspended, NA: Not-Availed) [* Maximum Number of Failures that can be Tolerated = 1 (though failure in C_2 is not admissible!)]

- (i) *Developing QRModel*. From the system architecture description and the component QRSpec (as specified in **from** part of the query), we follow the component characterization (as proposed in Section 3) and generic composition procedures (proposed in Section 4) to build the system QRModel automatically.
- (ii) *Constraining QRModel*. After parsing SQDL queries, we impose the restriction over the built QRModel adhering to the constraints mentioned under the **where** block of a query.
- (iii) *Exploring QRModel*. This is a simple search and data retrieval step from the underlying state-transition system to gather relevant information from QRModel as asked in the **select** block of the query.

Let us elucidate the outcome of the above-mentioned three-step process by an example.

Example 9. We again revisit the parallel system, Υ_P and seek for the answers of the two queries (Query1 and Query2) introduced in Example 8. Table 10 and Table 11 present the snapshots of the information retrieved over the Υ_P system.

Some interesting observations can be made for the system, Υ_P , from Table 10. Though we asked for the output quality for the input quality of at least 30 units, but the mode configuration 001 (where C_1 fails completely in both modes) can only provide meaningful output with input level being at least 40 and the output quality falls to 0 (zero), when input quality is set within $[30, 40)$. Moreover, the system can maintain a reliability of at least 0.9 (higher than given) in the given setup with at most 1 failure admissible. However, the reliability can range up to $[0.985 - 0.990]$ under the assumption of non-failing components.

Similarly, from the component operating modes listed in Table 11, it is evident that indicates that it is *never* possible in Υ_P to maintain the reliability threshold of 0.95 when the component C_2 fails. It is also shown that only a maximum of 1 failure is admissible to guarantee the query constraint here, but it must be C_1 in the worst case. Moreover, there are few possible provisions to suspend C_1 , if required without violating the given Query2 constraints.

When the same queries are solved over the series system, Υ_S , we find that there is only one configuration (i.e. 1X1) admissible for Query1 with reliability of 0.855 and input-output quality of $50 \rightarrow 30$; but for Query2, there is none adhering to the setup constraints. \square

Though we provided a simple example system to illustrate the query-based assessment mechanism, but our proposed framework is well-generalized to handle any complex systems structure that can be represented by a directed acyclic graph, and with generic queries expressed using SQDL.

7. Case-Study

Let us revisit the example component-based system structure, Υ_{sp} that is introduced in the beginning of this article (refer to Example 1 and Figure 2). We show the applicability of our proposed quality characterization and query-based assessment framework in details over this system to establish that the method can be applied in general to any composite structures.

For Υ_{sp} , the automatically derived formal QRModel has 147 states and 174 failure transitions as well as 174 suspend transitions. When we synthesize the formal QRSpec by abstracting the QRModel (keeping only

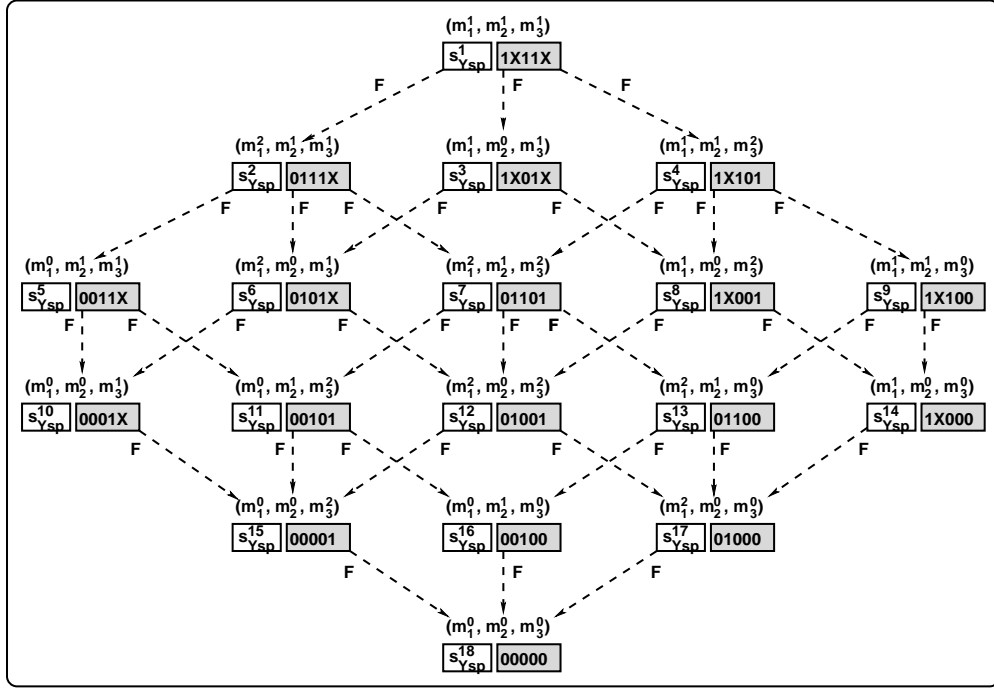

Fig. 8. State Transition Diagram with State Labels as Composite Component-Mode Tuples for the Abstracted $QRModel1$, $Q'_{\Upsilon_{sp}}$, Inferred from Quality Configurations, $Q_{\Upsilon_{sp}}$, which has a total of 147 states with 348 failure and suspend transitions (174 each)

State ID	Operating Mode Config.	Component Mode (Composite Tuple)	Input Quality Values (Levels)	Output Quality Values (Levels)	Operating Mode Probability	
					Algebraic Expression	Value
$s^1_{\Upsilon_{sp}}$	1X11X	(m_1^1, m_2^1, m_3^1)	$\langle 50, 40, 30, 10 \rangle$	$\langle 40, 30, 25, 10 \rangle$	$r_{1,1} \cdot r_{2,1} \cdot r_{3,1}$	0.68400
$s^2_{\Upsilon_{sp}}$	0111X	(m_1^2, m_2^1, m_3^1)	$\langle 50, 40, 30, 10 \rangle$	$\langle 35, 30, 25, 10 \rangle$	$(1 - r_{1,1}) \cdot r_{1,2} \cdot r_{2,1} \cdot r_{3,1}$	0.11970
$s^3_{\Upsilon_{sp}}$	1X01X	(m_1^1, m_2^0, m_3^1)	$\langle 50, 30, 20 \rangle$	$\langle 40, 25, 10 \rangle$	$r_{1,1} \cdot (1 - r_{2,1}) \cdot r_{3,1}$	0.03600
$s^4_{\Upsilon_{sp}}$	1X101	(m_1^1, m_2^1, m_2^0)	$\langle 50, 40, 30, 10 \rangle$	$\langle 40, 30, 25, 10 \rangle$	$r_{1,1} \cdot r_{2,1} \cdot (1 - r_{3,1}) \cdot r_{3,2}$	0.06080
$s^5_{\Upsilon_{sp}}$	0011X	(m_1^0, m_2^1, m_3^1)	$\langle 40, 10 \rangle$	$\langle 30, 10 \rangle$	$(1 - r_{1,1}) \cdot (1 - r_{1,2}) \cdot r_{2,1} \cdot r_{3,1}$	0.05130
$s^6_{\Upsilon_{sp}}$	0101X	(m_1^2, m_2^0, m_3^1)	$\langle 50, 30, 20 \rangle$	$\langle 35, 25, 10 \rangle$	$(1 - r_{1,1}) \cdot r_{1,2} \cdot (1 - r_{2,1}) \cdot r_{3,1}$	0.00630
$s^7_{\Upsilon_{sp}}$	01101	(m_1^2, m_2^1, m_2^0)	$\langle 50, 40, 30, 10 \rangle$	$\langle 35, 30, 25, 10 \rangle$	$(1 - r_{1,1}) \cdot r_{1,2} \cdot r_{2,1} \cdot (1 - r_{3,1}) \cdot r_{3,2}$	0.01064
$s^8_{\Upsilon_{sp}}$	1X001	(m_1^1, m_2^0, m_2^0)	$\langle 50, 30, 20 \rangle$	$\langle 40, 25, 10 \rangle$	$r_{1,1} \cdot (1 - r_{2,1}) \cdot (1 - r_{3,1}) \cdot r_{3,2}$	0.00320
$s^9_{\Upsilon_{sp}}$	1X100	(m_1^1, m_2^1, m_3^0)	$\langle 50, 40, 30, 10 \rangle$	$\langle 40, 30, 25, 10 \rangle$	$r_{1,1} \cdot r_{2,1} \cdot (1 - r_{3,1}) \cdot (1 - r_{3,2})$	0.01520
$s^{10}_{\Upsilon_{sp}}$	0001X	(m_1^0, m_2^0, m_3^1)	$\langle 0 \rangle$	$\langle 0 \rangle$	$(1 - r_{1,1}) \cdot (1 - r_{1,2}) \cdot (1 - r_{2,1}) \cdot r_{3,1}$	0.00270
$s^{11}_{\Upsilon_{sp}}$	00101	(m_1^0, m_2^1, m_2^0)	$\langle 50, 20 \rangle$	$\langle 30, 10 \rangle$	$(1 - r_{1,1}) \cdot (1 - r_{1,2}) \cdot r_{2,1} \cdot (1 - r_{3,1}) \cdot r_{3,2}$	0.04560
$s^{12}_{\Upsilon_{sp}}$	01001	(m_1^2, m_2^0, m_2^0)	$\langle 50, 30, 20 \rangle$	$\langle 35, 25, 10 \rangle$	$(1 - r_{1,1}) \cdot r_{1,2} \cdot (1 - r_{2,1}) \cdot (1 - r_{3,1}) \cdot r_{3,2}$	0.00056
$s^{13}_{\Upsilon_{sp}}$	01100	(m_1^2, m_2^1, m_3^0)	$\langle 50, 40, 30, 10 \rangle$	$\langle 35, 30, 25, 10 \rangle$	$(1 - r_{1,1}) \cdot r_{1,2} \cdot r_{2,1} \cdot (1 - r_{3,1}) \cdot (1 - r_{3,2})$	0.00266
$s^{14}_{\Upsilon_{sp}}$	1X000	(m_1^1, m_2^0, m_3^0)	$\langle 50, 30, 20 \rangle$	$\langle 40, 25, 10 \rangle$	$r_{1,1} \cdot (1 - r_{2,1}) \cdot (1 - r_{3,1}) \cdot (1 - r_{3,2})$	0.00080
$s^{15}_{\Upsilon_{sp}}$	00001	(m_1^0, m_2^0, m_2^0)	$\langle 0 \rangle$	$\langle 0 \rangle$	$(1 - r_{1,1}) \cdot (1 - r_{1,2}) \cdot (1 - r_{2,1}) \cdot (1 - r_{3,1}) \cdot r_{3,2}$	0.00024
$s^{16}_{\Upsilon_{sp}}$	00100	(m_1^0, m_2^1, m_3^0)	$\langle 40, 10 \rangle$	$\langle 30, 10 \rangle$	$(1 - r_{1,1}) \cdot (1 - r_{1,2}) \cdot r_{2,1} \cdot (1 - r_{3,1}) \cdot (1 - r_{3,2})$	0.00114
$s^{17}_{\Upsilon_{sp}}$	01000	(m_1^2, m_2^0, m_3^0)	$\langle 50, 30, 20 \rangle$	$\langle 35, 25, 10 \rangle$	$(1 - r_{1,1}) \cdot r_{1,2} \cdot (1 - r_{2,1}) \cdot (1 - r_{3,1}) \cdot (1 - r_{3,2})$	0.00014
$s^{18}_{\Upsilon_{sp}}$	00000	(m_1^0, m_2^0, m_3^0)	$\langle 0 \rangle$	$\langle 0 \rangle$	$(1 - r_{1,1}) \cdot (1 - r_{1,2}) \cdot (1 - r_{2,1}) \cdot (1 - r_{3,1}) \cdot (1 - r_{3,2})$	0.00006

Table 12. Abstracted $QRModel1$ Configuration Details, $Q'_{\Upsilon_{sp}}$ (presenting the QRSpec for Υ_{sp}), as obtained from $Q_{\Upsilon_{sp}}$

failure transitions and the states reachable by failure transitions from the initial state in the underlying state-transition system), we get the abstract state-transition system as shown in Figure 8 with its specification configurations given in Table 12. In this QRSpec model formed, we have 18 states (combined component modes) and 33 transitions.

Table 13 and Table 14 present the results extracted if we execute the same two queries as proposed in Example 8. For *Query1*, it may be found (from Table 13) that there is no meaningful (guaranteed) output quality when input quality is in the range $[30, 40)$ and we have complete failure of C_1 . However, the reliability

Mode Config.	Component-level Operating Mode Combinations			Input Quality Levels (Values)	Output Quality Levels (Values)	Reliability Value
1X11X	$C_1 = (m_1^1 : \text{OP}, m_1^2 : \text{NA})$	$C_2 = (m_2^1 : \text{OP})$	$C_3 = (m_3^1 : \text{OP}, m_3^2 : \text{NA})$	(50, 40, 30)	(40, 30, 25)	0.990
0111X	$C_1 = (m_1^1 : \text{FL}, m_1^2 : \text{OP})$	$C_2 = (m_2^1 : \text{OP})$	$C_3 = (m_3^1 : \text{OP}, m_3^2 : \text{NA})$	(50, 40, 30)	(35, 30, 25)	0.985
0011X	$C_1 = (m_1^1 : \text{FL}, m_1^2 : \text{FL})$	$C_2 = (m_2^1 : \text{OP})$	$C_3 = (m_3^1 : \text{OP}, m_3^2 : \text{NA})$	(40)	(30)	0.950
01101	$C_1 = (m_1^1 : \text{FL}, m_1^2 : \text{OP})$	$C_2 = (m_2^1 : \text{OP})$	$C_3 = (m_3^1 : \text{FL}, m_3^2 : \text{OP})$	(50, 40, 30)	(35, 30, 25)	0.985
1X101	$C_1 = (m_1^1 : \text{OP}, m_1^2 : \text{NA})$	$C_2 = (m_2^1 : \text{OP})$	$C_3 = (m_3^1 : \text{FL}, m_3^2 : \text{OP})$	(50, 40, 30)	(40, 30, 25)	0.990
1X100	$C_1 = (m_1^1 : \text{OP}, m_1^2 : \text{NA})$	$C_2 = (m_2^1 : \text{OP})$	$C_3 = (m_3^1 : \text{FL}, m_3^2 : \text{FL})$	(50, 40, 30)	(40, 30, 25)	0.990

Table 13. Extracted Results over Υ_{sp} from Query1 (OP: Operating, FL: Failed, NA: Not-Availed)

Mode Config.	Component-level Operating Mode Combinations			Operating Probability	No. of Failure
1X11X	$C_1 = (m_1^1 : \text{OP}, m_1^2 : \text{NA})$	$C_2 = (m_2^1 : \text{OP})$	$C_3 = (m_3^1 : \text{OP}, m_3^2 : \text{NA})$	0.68400	0
0111X	$C_1 = (m_1^1 : \text{FL}, m_1^2 : \text{OP})$	$C_2 = (m_2^1 : \text{OP})$	$C_3 = (m_3^1 : \text{OP}, m_3^2 : \text{NA})$	0.11970	0
0011X	$C_1 = (m_1^1 : \text{FL}, m_1^2 : \text{FL})$	$C_2 = (m_2^1 : \text{OP})$	$C_3 = (m_3^1 : \text{OP}, m_3^2 : \text{NA})$	0.05130	1
00101	$C_1 = (m_1^1 : \text{FL}, m_1^2 : \text{FL})$	$C_2 = (m_2^1 : \text{OP})$	$C_3 = (m_3^1 : \text{FL}, m_3^2 : \text{OP})$	0.00456	1
00100	$C_1 = (m_1^1 : \text{FL}, m_1^2 : \text{FL})$	$C_2 = (m_2^1 : \text{OP})$	$C_3 = (m_3^1 : \text{FL}, m_3^2 : \text{FL})$	0.00114	2*
0010Y	$C_1 = (m_1^1 : \text{FL}, m_1^2 : \text{FL})$	$C_2 = (m_2^1 : \text{OP})$	$C_3 = (m_3^1 : \text{FL}, m_3^2 : \text{SU})$	0.00570	1
001Y1	$C_1 = (m_1^1 : \text{FL}, m_1^2 : \text{FL})$	$C_2 = (m_2^1 : \text{OP})$	$C_3 = (m_3^1 : \text{SU}, m_3^2 : \text{OP})$	0.04560	1
001Y0	$C_1 = (m_1^1 : \text{FL}, m_1^2 : \text{FL})$	$C_2 = (m_2^1 : \text{OP})$	$C_3 = (m_3^1 : \text{SU}, m_3^2 : \text{FL})$	0.01140	1
0Y11X	$C_1 = (m_1^1 : \text{FL}, m_1^2 : \text{SU})$	$C_2 = (m_2^1 : \text{OP})$	$C_3 = (m_3^1 : \text{OP}, m_3^2 : \text{NA})$	0.17100	0
0Y101	$C_1 = (m_1^1 : \text{FL}, m_1^2 : \text{SU})$	$C_2 = (m_2^1 : \text{OP})$	$C_3 = (m_3^1 : \text{FL}, m_3^2 : \text{OP})$	0.01520	0
0Y100	$C_1 = (m_1^1 : \text{FL}, m_1^2 : \text{SU})$	$C_2 = (m_2^1 : \text{OP})$	$C_3 = (m_3^1 : \text{FL}, m_3^2 : \text{FL})$	0.00380	1
01101	$C_1 = (m_1^1 : \text{FL}, m_1^2 : \text{OP})$	$C_2 = (m_2^1 : \text{OP})$	$C_3 = (m_3^1 : \text{FL}, m_3^2 : \text{OP})$	0.01064	0
01100	$C_1 = (m_1^1 : \text{FL}, m_1^2 : \text{OP})$	$C_2 = (m_2^1 : \text{OP})$	$C_3 = (m_3^1 : \text{FL}, m_3^2 : \text{FL})$	0.00266	1
0110Y	$C_1 = (m_1^1 : \text{FL}, m_1^2 : \text{OP})$	$C_2 = (m_2^1 : \text{OP})$	$C_3 = (m_3^1 : \text{FL}, m_3^2 : \text{SU})$	0.01330	0
011Y1	$C_1 = (m_1^1 : \text{FL}, m_1^2 : \text{OP})$	$C_2 = (m_2^1 : \text{OP})$	$C_3 = (m_3^1 : \text{SU}, m_3^2 : \text{OP})$	0.10640	0
011Y0	$C_1 = (m_1^1 : \text{FL}, m_1^2 : \text{OP})$	$C_2 = (m_2^1 : \text{OP})$	$C_3 = (m_3^1 : \text{SU}, m_3^2 : \text{FL})$	0.02660	0
Y111X	$C_1 = (m_1^1 : \text{SU}, m_1^2 : \text{OP})$	$C_2 = (m_2^1 : \text{OP})$	$C_3 = (m_3^1 : \text{OP}, m_3^2 : \text{NA})$	0.59850	0
Y011X	$C_1 = (m_1^1 : \text{SU}, m_1^2 : \text{FL})$	$C_2 = (m_2^1 : \text{OP})$	$C_3 = (m_3^1 : \text{OP}, m_3^2 : \text{NA})$	0.25650	0
Y0101	$C_1 = (m_1^1 : \text{SU}, m_1^2 : \text{FL})$	$C_2 = (m_2^1 : \text{OP})$	$C_3 = (m_3^1 : \text{FL}, m_3^2 : \text{OP})$	0.02280	0
Y0100	$C_1 = (m_1^1 : \text{SU}, m_1^2 : \text{FL})$	$C_2 = (m_2^1 : \text{OP})$	$C_3 = (m_3^1 : \text{FL}, m_3^2 : \text{FL})$	0.00570	1
Y1101	$C_1 = (m_1^1 : \text{SU}, m_1^2 : \text{OP})$	$C_2 = (m_2^1 : \text{OP})$	$C_3 = (m_3^1 : \text{FL}, m_3^2 : \text{OP})$	0.05320	0
Y1100	$C_1 = (m_1^1 : \text{SU}, m_1^2 : \text{OP})$	$C_2 = (m_2^1 : \text{OP})$	$C_3 = (m_3^1 : \text{FL}, m_3^2 : \text{FL})$	0.01330	1
1X101	$C_1 = (m_1^1 : \text{OP}, m_1^2 : \text{NA})$	$C_2 = (m_2^1 : \text{OP})$	$C_3 = (m_3^1 : \text{FL}, m_3^2 : \text{OP})$	0.06080	0
1X100	$C_1 = (m_1^1 : \text{OP}, m_1^2 : \text{NA})$	$C_2 = (m_2^1 : \text{OP})$	$C_3 = (m_3^1 : \text{FL}, m_3^2 : \text{FL})$	0.01520	1
1X10Y	$C_1 = (m_1^1 : \text{OP}, m_1^2 : \text{NA})$	$C_2 = (m_2^1 : \text{OP})$	$C_3 = (m_3^1 : \text{FL}, m_3^2 : \text{SU})$	0.07600	0
1X1Y1	$C_1 = (m_1^1 : \text{OP}, m_1^2 : \text{NA})$	$C_2 = (m_2^1 : \text{OP})$	$C_3 = (m_3^1 : \text{SU}, m_3^2 : \text{OP})$	0.60800	0
1X1Y0	$C_1 = (m_1^1 : \text{OP}, m_1^2 : \text{NA})$	$C_2 = (m_2^1 : \text{OP})$	$C_3 = (m_3^1 : \text{SU}, m_3^2 : \text{FL})$	0.15200	0

Table 14. Extracted Results over Υ_{sp} from Query2 (OP: Operating, FL: Failed, SU: Suspended, NA: Not-Availed) [* Maximum Number of Failures that can be Tolerated = 2 (though failure in C_2 is not admissible!)]

can ranges upto [0.985–0.999] under the no component failure assumption. Similarly, for Query2, it is evident (from Table 14) that non-failure of C_2 is must with respect to the given constraints (primarily keeping the system reliability above 0.95) in the query. Additionally, there are still some provisions of suspending at most one component yet satisfying the query requirements, even in case of failure in one of the components.

It may be further noted that, for Υ_{sp} , the reliability computation is primarily dictated by C_1 and C_2 components. This is because of the instantiation/invocation of same component, C_2 , present in two parallel paths from input to output – which makes the system to only operate through C_1 in case of failure/suspension of C_2 (since C_2 failure closing the $C_3 - C_2$ path too). Therefore, the computed reliability value of the overall system always comes from the computation of, $[Z_1(m_1^i) + Z_2(m_2^j) - Z_1(m_1^i).Z_2(m_2^j)]$, depending on the modes, m_1^i and m_2^j of C_1 and C_2 ($0 \leq i \leq 2$, $0 \leq j \leq 1$), respectively, independent of the involvement of reliability values from C_3 ⁸. This is also the reason why C_2 is critical to maintain high reliability for the operability of Υ_{sp} , as also evident from the outcomes of Query1 and Query2.

⁸ The reliability of Υ_{sp} in every mode is computed as: (Here, $0 \leq i, k \leq 2$ and $0 \leq j \leq 1$)

$$Z_{\Upsilon_{sp}}(m_1^i, m_2^j, m_3^k) = 1 - [1 - Z_1(m_1^i)].[1 - Z_2(m_2^j)].[1 - Z_3(m_3^k).Z_2(m_2^j)] = [Z_1(m_1^i) + Z_2(m_2^j) - Z_1(m_1^i).Z_2(m_2^j)]$$

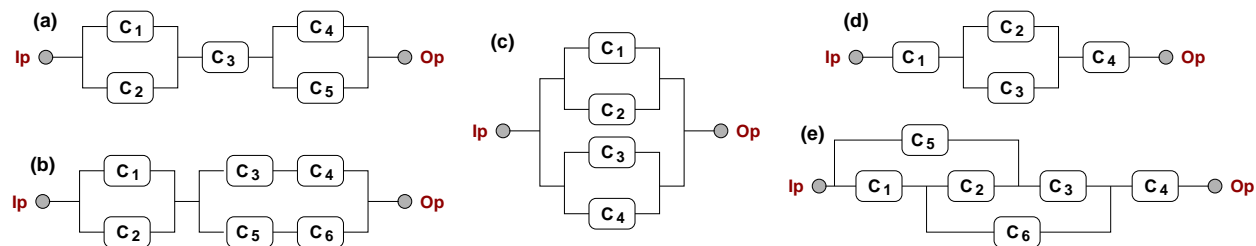

Fig. 9. Some General Composite System Structures Explored by our Framework

Exploration over Miscellaneous System Structures: We also explored our proposed approach over some general system structures, five such composite system variations are shown in Figure 9. We also tried different queries on these variations and found that our framework helps in analyzing the non-functional quality requirements. Moreover, each of the building block of these systems can also be a subsystem by itself and our framework is capable of handling such compositions, which can be primarily derived in a hierarchical manner.

8. Conclusion

In this work, we propose a novel framework (Figure 1) to formally define and characterize the non-functional specifications, such as quality and reliability, of a component-based system and analyze the same. From the component-level quality configurations, we deduce system-level quality measures following a generic series and parallel composition techniques. We have further shown how to synthesize back the system-level non-functional specifications from the derived quality models of the composite system. We find interesting ramifications of such an extraction of non-functional specifications from an architectural level, since it may be used to assess the functional coverage that the quality measure achieves and it may also be correlated with the design intent (if specified) to check for its conformance with the desired and laid specifications. We also establish a query-driven analysis framework to extract relevant non-functional features of the overall system in greater details leveraging the internally derived quality configuration model. To the best of our knowledge, this is the first work that tries to provide a formal and automated analysis for compositional quality requirements from an architectural level of system design. We believe that such an assessment framework will be useful in formally certifying the non-functional requirements of component-based systems.

Additionally, the query-driven quality assessment counterpart equips the system designers presenting them deeper insights while exploring through the possible component-level configurations and thereby the designers may find it easier to explore and converge into the best possible system structures. In case that the desired system-level specification is not met by the derived composite structure, such an assessment tool, adding to our proposed compositional framework, will always help to understand the gap in terms of non-admissible quality configurations and/or prohibitive operational setups from its constituent components. As part of the future work, we shall explore the possibility to automatically bridge the gap by minimal addition or alteration to the existing composite structure. Besides, this being the maiden work, we have considered a rudimentary notion of quality which can be defined generically (and simply) in terms of some levels (as real values). In future, we plan to extend this definition of quality also as a function of component activity and interactions by possibly modeling the same involving logical properties. We also plan to integrate our proposed framework with industrial system design and validation flow and devise suitable metrics for quality and reliability coverage for comprehensive certification of component-based systems from architectural level.

References

- [1] A. Basu, S. Bensalem, M. Bozga, P. Bourgos, and J. Sifakis. Rigorous System Design: The BIP Approach. In *Proceedings of Mathematical and Engineering Methods in Computer Science (MEMICS)*, pages 1–19, 2011.
- [2] A. Basu, S. Bensalem, M. Bozga, J. Combaz, M. Jaber, T.-H. Nguyen, and J. Sifakis. Rigorous Component-Based System Design Using the BIP Framework. *IEEE Software*, 28(3):41–48, 2011.
- [3] S. Bliudze and J. Sifakis. A Notion of Glue Expressiveness for Component-Based Systems. In *Proceedings of 19th International Conference on Concurrency Theory (CONCUR)*, pages 508–522, 2008.

- [4] S. Bliudze and J. Sifakis. Causal Semantics for the Algebra of Connectors. *Formal Methods in System Design*, 36:179–199, December 2008.
- [5] C. Bock. SysML and UML 2 support for Activity Modeling. *Systems Engineering*, 9(2):160–186, 2006.
- [6] P. Bourgos, A. Basu, M. Bozga, S. Bensalem, J. Sifakis, and K. Huang. Rigorous System Level Modeling and Analysis of Mixed HW/SW Systems. In *Proceeding of 9th ACM/IEEE International Conference on Formal Methods and Models for Codesign (MEMOCODE)*, pages 11–20, 2011.
- [7] X. Cai, M. Lyu, K.-F. Wong, and R. Ko. Component-based software engineering: Technologies, development frameworks, and quality assurance schemes. In *7th Asia-Pacific Software Engineering Conference (APSEC)*, pages 372–379, February 2000.
- [8] E. M. Clarke, O. Grumberg, D. Kroening, D. Peled, and H. Veith. *Model Checking*. MIT Press, December 2018.
- [9] E. M. Clarke, T. A. Henzinger, H. Veith, and R. Bloem. *Handbook of Model Checking*. Springer, 2018.
- [10] M. R. Clarkson and F. B. Schneider. Hyperproperties. *Journal of Computer Security*, 18(6):1157–1210, September 2010.
- [11] J. Combaz, J.-C. Fernandez, T. Lepley, and J. Sifakis. QoS Control for Optimality and Safety. In *Proceedings of 5th ACM International Conference on Embedded Software*, page 90–99, 2005.
- [12] J. Combaz, J.-C. Fernandez, J. Sifakis, and L. Strus. Symbolic Quality Control for Multimedia Applications. In *International Journal of Real-Time Systems (RTS)*, Springer, 40(1):1–43, October 2008.
- [13] A. Ferrari and A. L. Sangiovanni-Vincentelli. System Design: Traditional Concepts and New Paradigms. In *Proceedings of IEEE International Conference on Computer Design (ICCD)*, pages 2–12, 1999.
- [14] S. K. Ghosh, A. Hazra, and S. Dey. RELSPEC: A Framework for Early Reliability Refinement of Embedded Applications. In *28th International Conference on VLSI Design (VLSID)*, pages 41–46, 2015.
- [15] G. Goessler and J. Sifakis. Composition for Component-Based Modeling. In *1st International Symposium on Formal Methods for Components and Objects (FMCO)*, pages 443–466, January 2002.
- [16] T. Groetker, S. Liao, G. Martin, and S. Swan. *System Design with SystemC*. Springer, 2002.
- [17] D. Harel. Statecharts: a Visual Formalism for Complex Systems. *Science of Computer Programming*, 8(3):231–274, 1987.
- [18] D. Hatebur, M. Heisel, and H. Schmidt. Analysis and Component-based Realization of Security Requirements. In *3rd International Conference on Availability, Reliability and Security*, pages 195–203, 2008.
- [19] A. Hazra, P. Dasgupta, and P. P. Chakrabarti. Formal Assessment of Reliability Specifications in Embedded Cyber-Physical Systems. *Journal of Applied Logic*, 18:71–104, November 2016.
- [20] A. Hazra, P. Ghosh, S. G. Vadlamudi, P. P. Chakrabarti, and P. Dasgupta. Formal Methods for Early Analysis of Functional Reliability in Component-Based Embedded Applications. *IEEE Embedded Systems Letters*, 5(1):8–11, March 2013.
- [21] A. Hazra, S. Goyal, P. Dasgupta, and A. Pal. Formal Verification of Architectural Power Intent. *IEEE Transactions on Very Large Scale Integration (VLSI) Systems*, 21(1):78–91, January 2013.
- [22] A. Hazra, R. Mukherjee, P. Dasgupta, A. Pal, K. M. Harer, A. Banerjee, and S. Mukherjee. POWER-TRUCTOR: An Integrated Tool Flow for Formal Verification and Coverage of Architectural Power Intent. *IEEE Transactions on Computer-Aided Design of Integrated Circuits and Systems*, 32(11):1801–1813, November 2013.
- [23] Andreas Johnsen. *Quality Assurance for Dependable Embedded Systems*. PhD Dissertation, Maelardalen University, Sweden, 2018.
- [24] Keerthi K., I. Roy, A. Hazra, and C. Rebeiro. Formal Verification for Security in IoT Devices. In R. S. Chakraborty, J. Mathew, and A. V. Vasilakos, editors, *Security and Fault Tolerance in Internet of Things*, pages 179–200. Springer International Publishing, 2019.
- [25] G. Karsai, J. Sztipanovits, A. Ledeczki, and T. Bapty. Model-Integrated Development of Embedded Software. *Proceedings of IEEE*, 91(1):145–164, January 2003.
- [26] I. Koren and C. M. Krishna. *Fault-Tolerant Systems*. Morgan Kaufmann, 2007.
- [27] E. A. Lee and A. L. Sangiovanni-Vincentelli. Component-based design for the Future. In *Proceedings of Design, Automation and Test in Europe (DATE)*, pages 1–5, 2011.
- [28] W. Li, F. Le Gall, P. Vlacheas, and A. Cheptsov. Quality assurance for component-based systems in embedded environments. In *International Conference on Internet of Things, Embedded Systems and Communications (IINTEC)*, pages 171–176, 12 2018.
- [29] A. Paul, E. Baranov, S. Bliudze, M. Jaber, and J. Sifakis. A General Framework for Architecture Composability. *Formal Aspects of Computing*, 28:1–25, December 2015.
- [30] A. Roychoudhury. *Embedded Systems and Software Validation*. Morgan Kaufmann, 2009.
- [31] A. L. Sangiovanni-Vincentelli and R. Passerone. *Platform-Based Design*. Springer, 2022.
- [32] C. Seceleanu and I. Crnkovic. Component Models for Reasoning. *IEEE Computer*, 46(11):40–47, 2013.
- [33] B. Selic. The Pragmatics of Model-driven Development. *IEEE Software*, 20(5):19–25, 2003.
- [34] J. Sifakis. Rigorous System Design. *Foundations and Trends in Electronic Design Automation*, 6(4):293–362, July 2012.
- [35] J. Sifakis, S. Bensalem, S. Bliudze, and M. Bozga. A Theory Agenda for Component-Based Design. In R. De Nicola and R. Hennicker, editors, *Software, Services, and Systems*, pages 409–439. Oxford University Press, 2015.
- [36] J. Sztipanovits and G. Karsai. Model-Integrated Computing. *IEEE Computer*, 30(4):110–111, 1997.
- [37] M. Utting and B. Legear. *Practical Model-Based Testing: A Tools Approach*. Morgan-Kaufmann, 2007.
- [38] J. Zander, I. Schieferdecker, and P. Mosterman. *Model-Based Testing for Embedded Systems*. CRC Press, September 2011.