

Semantic Security with Infinite-dimensional Quantum Eavesdropping Channel

Matthias Frey*, Igor Bjelaković*[†], Janis Nötzel[‡], and Sławomir Stańczak*[†]

*Technische Universität Berlin, Germany

[†]Fraunhofer Heinrich Hertz Institute, Berlin, Germany

[‡]Technical University of Munich, Germany

Abstract

We propose a new proof method for direct coding theorems for wiretap channels where the eavesdropper has access to a quantum version of the transmitted signal on an infinite-dimensional Hilbert space and the legitimate parties communicate through a classical channel or a classical input, quantum output (cq) channel. The transmitter input can be subject to an additive cost constraint, which specializes to the case of an average energy constraint. This method yields errors that decay exponentially with increasing block lengths. Moreover, it provides a guarantee of a quantum version of semantic security, which is an established concept in classical cryptography and physical layer security. Therefore, it complements existing works which either do not prove the exponential error decay or use weaker notions of security. The main part of this proof method is a direct coding result on channel resolvability which states that there is only a doubly exponentially small probability that a standard random codebook does not solve the channel resolvability problem for the cq channel. Semantic security has strong operational implications meaning essentially that the eavesdropper cannot use its quantum observation to gather any meaningful information about the transmitted signal. We also discuss the connections between semantic security and various other established notions of secrecy.

I. INTRODUCTION

Developments in the area of quantum computing in the last decades have put a spotlight on how vulnerable many state-of-the-art security techniques for communication networks are against attacks based on execution of quantum algorithms that exploit the laws of quantum physics [1]. Another aspect of the rapid development in experimental quantum physics, however, has received significantly less attention in communication engineering: Instead of simply performing quantum processing steps on an intercepted classical signal, an attacker can use quantum measurement devices to exploit the quantum nature of the signals themselves. For instance, radio waves as well as visible light that is used in optical fiber communications both consist of photons. This fact was exploited in [2] to introduce the so-called photonic side channels.

Any communication network that involves a vast number of interconnected network elements and systems communicating with each other, by its very nature exposes a large attack surface to potential adversaries. This is even exacerbated if many of the communication paths are wireless, as is the case in cellular networks such as 6G. Examples for possible attacks that can be carried out against various parts of such networks are algorithm implementation attacks, jamming attacks, side-channel attacks, and attacks on the physical layer of the communication system. This multi-faceted nature of the threat necessitates a diverse range of countermeasures. It has therefore been a longstanding expectation that established defenses based on cryptography will need to be complemented with defenses based on physical layer security (PLS) which is a promising approach to protect against lower-layer attacks. It can be used as an additional layer of security to either increase the overall system security or reduce the complexity of cryptographic algorithms and protocols running at higher layers of the protocol stack. We point out that complexity may be a key aspect in massive wireless networks of the future such as 6G, where many low-cost, resource and computationally constrained devices will be deployed, making it difficult to use advanced cryptographic techniques.

In cryptography, sequences of bits are protected against attacks. The main threat posed by the recent progress in the implementation of quantum computers and known quantum algorithms [1], [3] which directly affect the security of certain cryptographic schemes, therefore, is that an attacker may have the ability to process cipher texts with quantum computers. This has triggered significant research and development efforts in the field of post-quantum cryptography [4]. The goal in this field is to develop new cryptographic algorithms and protocols that are resistant to attacks by quantum computers. The threat for defense mechanisms based on PLS, on the other hand, is of a different nature: Since there is no assumption regarding the computational capability of attackers needed to guarantee security, such techniques are inherently safe against attacks with quantum computers that process classically represented signals. But since PLS seeks to protect the communication signals themselves against attacks, they are vulnerable to violations of system assumptions regarding what type of signal the attacker

MF, IB, and SS acknowledge the financial support by the Federal Ministry of Education and Research of Germany in the program of “Souverän. Digital. Vernetzt.” Joint project 6G-RIC, project identification numbers: 16KISK020K and 16KISK030. This work was also supported by the Federal Ministry of Education and Research of Germany (BMBF) under grant 01DR21009, as well as by the German Research Foundation (DFG) under grant STA 864/15-1.

JN acknowledges the financial support by the DFG Emmy-Noether program under grant number NO 1129/2-1 and by the Federal Ministry of Education and Research of Germany in the program of “Souverän. Digital. Vernetzt.”. Joint project 6G-life, project identification number: 16KISK002.

This work was presented in part at the 2022 IEEE Information Theory Workshop (ITW).

can intercept. Therefore, security is not guaranteed if an attack is carried out with quantum hardware such as optical quantum detectors and similar quantum measurement equipment. For example, the photon emission from integrated circuits has been exploited in [2], [5] to read out the used secret keys. The underlying physical process represents a quantum side channel since the properties of the emitted photons strongly depend on the operation that the involved device performs and the data being processed. This shortcoming of (classical) PLS techniques can be addressed by establishing results for PLS that take the quantum nature of wireless communication signals and side channels in transmitters and receivers into account.

Another important aspect is the availability of bounds for secure communication in the finite block length regime. These are important for many practical purposes, such as the construction of secrecy maps for indoor and outdoor wireless networks in [6]–[8] that we expect to be crucial for the integration of PLS into mobile communication networks.

In this work, we prove direct coding results for wiretap channels that take both of these aspects into consideration. The channel models considered have a quantum output at the eavesdropper’s channel terminal, and the derived bounds can be evaluated at finite block lengths. Besides this, we also discuss operational implications of the resulting security guarantees and compare them to other notions of security that are commonly used in the literature.

A. Prior work

The results we provide in this paper are rooted in and draw from several branches of research like classical PLS and its connection to cryptography, channel resolvability, and quantum Shannon theory. For this reason, we give a short overview of existing literature in these fields which is closely related to this work.

a) Classical PLS: An important branch of research with long history in PLS addresses fundamental bounds to confidentiality of communication, which is traditionally based on the communication model of the wiretap channel [9]–[13].

It is important to emphasize that the measure of confidentiality itself has undergone a tremendous evolution. While the results of [9], [10] use equivocation as the underlying measure, [11]–[13] rely on strong secrecy or closely related measures as the security metric. The disadvantage of these security metrics is that they allow no or very limited operational interpretation, i.e., they do not provide a way to quantify leakage of information for specific types of eavesdropping attacks. A confidentiality measure that has been known in the cryptography community for a long time and allows a clear operational interpretation is semantic security [14]. It has been adopted in the PLS community as a suitable measure of secrecy and used for wiretap channel coding problems in [15]–[18].

b) Achievability for wiretap channels with quantum outputs: A quantum version of the wiretap channel was analyzed in [19] for a one-shot scenario. [20], [21] derive non-asymptotic results for general finite-dimensional wiretap channels with classical input and quantum outputs as well as in the case of quantum input and quantum outputs under the strong secrecy criterion, but due to the proof methods used, semantic security is implicitly established as well. In [22], error exponents and equivocation rates are established for the case that there is only randomness of limited quality available at the transmitter. [23] extends the result from [20] to noiseless bosonic channels under the strong secrecy criterion. The series of works [24]–[27] explores a trade-off region between semantically secure communication, public communication and secret key generation which can be specialized to just semantically secure communication in a straightforward way. The channel models considered are the noiseless bosonic channel, the thermal-noise bosonic channel, the quantum amplifier channel and general infinite-dimensional quantum channels. All achievability results are of asymptotic nature. In [28], a feedback scenario is considered under weak secrecy.

c) Converse results for wiretap channels with quantum outputs: Multi-letter converse results for finite-dimensional channels appear in [20], [21]. In [23], [25], single-letter converse results for noiseless bosonic channels are given, but they rely on an unproven conjecture, the entropy photon number inequality. Converse results for general quantum channels and certain bosonic channels that do not rely on unproven conjectures are given in [22], [26], [27]. Single-letter versions are available only in the case of degradable channels, otherwise the converse results are multi-letter.

d) Semantic security for channels with quantum outputs: As mentioned above, many works have either given results that imply semantic security or established them implicitly in their proofs. The works [22], [29], however, have considered the question of security notion explicitly and established an interesting connection between strong secrecy and semantic security. [22] contains a construction that can transform any wiretap code which achieves strong secrecy over a classical input, two quantum outputs (c/qq) wiretap channel into a code that ensures semantic security and has (asymptotically) the same rate. As was observed in [29], this holds also in the infinite-dimensional case. For the finite-dimensional case, [29] gives an alternative construction for this transformation; the advantage here is that the construction is explicit so that it can be expected that if it is used on a practically feasible code that achieves strong secrecy, the transformation will result in a semantically secure wiretap code that retains the practical feasibility.

e) Resolvability for cq channels: To the best of our knowledge, the first works that contain resolvability results for cq channels are [20], [21]. Further results appeared in [30] and a much more in-depth treatment with generalizations to the case of imperfect randomness at the transmitter can be found in [22]. All of these works are specific to the finite-dimensional case.

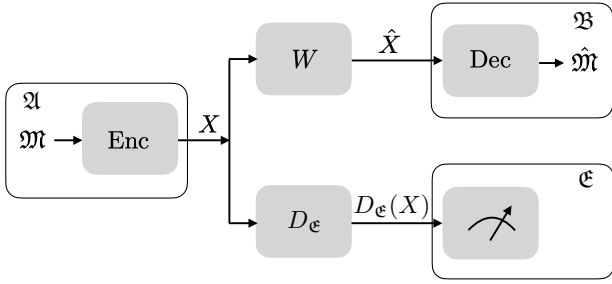

(a) c/cq wiretap channel consisting of a classical channel W with continuous input and output alphabet and a channel D_{ϵ} with classical continuous input alphabet and quantum output on separable infinite-dimensional Hilbert space.

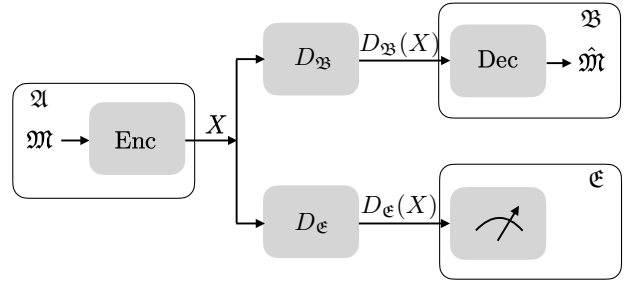

(b) c/cq wiretap channel consisting of the pair of channels $(D_{\mathfrak{B}}, D_{\epsilon})$ both with classical continuous input alphabet and quantum output on separable infinite-dimensional Hilbert space.

Fig. 1: Quantum wiretap channel models.

B. Contribution and Outline

The contribution of this paper can be summarized as follows:

- We establish a semantic security based direct coding theorem for wiretap channels with infinite-dimensional quantum output observed by the eavesdropper (cf. Fig. 1). This result applies both to the case where the legitimate parties communicate over a (possibly) continuous-alphabet classical channel, and to the case in which they also use a channel with classical input and infinite-dimensional quantum output.
- We develop a new proof method for wiretap channels with the eavesdropper having access to a quantum version of the input signal. This method also establishes a resolvability result for cq channels with infinite-dimensional output. Our method is based on symmetrization arguments used to prove non-asymptotic versions of uniform laws of large numbers based on Rademacher complexity.
- While the results are stated in qualitative formulation (exponential and doubly exponential decay for a suitable choice of parameters), our proof method yields bounds for the finite block length regime as well. The explicit form of the exponents can be found in the proofs in Section V.
- We establish our results under additive cost constraints. These types of constraints specialize in particular to the case of average input energy constraints.
- We illustrate the finite-blocklength nature of our methods with numerical evaluations of the obtained error bounds in the special case where both the legitimate communication parties and the eavesdropper use Gaussian cq channels.
- We discuss various established secrecy metrics for quantum communication systems and show how they are related to each other.

In Section II, we introduce the wiretap channel models that are considered in this paper, and state the main results. In Section III, we give the definitions of semantic security and other established secrecy metrics for quantum communication systems, and we discuss how they are related. In particular, we show how the results stated in Section II imply a semantic security guarantee. To establish the main results, we need a theorem on cq channel resolvability and a coding theorem for the cq channel, which we state and briefly discuss in Section IV. Section V contains the proofs of the theorems in Sections II and IV. Finally, in Section VI, we specialize our results to Gaussian cq channels and discuss how the error bounds of our wiretap coding theorem can be evaluated at finite block lengths. For the example of a set of system parameters that is plausible for a real-world optical communication system, we include plots made with these methods. A number of technical lemmas are relegated to the appendix.

II. PROBLEM STATEMENT AND MAIN RESULT

In this section, we introduce the wiretap channel model and state our main results.

A. Notation and Conventions

Before we can make the formal problem statement, it is necessary to introduce some preliminaries. Let \mathcal{H} be a separable Hilbert space over \mathbb{C} and let

$$\mathcal{B}(\mathcal{H}) := \left\{ A : \mathcal{H} \rightarrow \mathcal{H} : A \text{ is linear and } \sup_{h \in \mathcal{H} : \|h\| \leq 1} \|Ah\| < \infty \right\}$$

be the set of bounded linear operators on \mathcal{H} where $\|\cdot\|$ denotes the norm on the Hilbert space \mathcal{H} induced by the inner product. The set $\mathcal{T}(\mathcal{H})$ of trace class operators [31] is defined by

$$\mathcal{T}(\mathcal{H}) := \left\{ A \in \mathcal{B}(\mathcal{H}) : \text{tr}(A^*A)^{\frac{1}{2}} < \infty \right\}.$$

Endowed with the norm $\|\cdot\|_{\text{tr}} : \mathcal{T}(\mathcal{H}) \rightarrow \mathbb{R}_+$ defined by

$$\|A\|_{\text{tr}} := \text{tr}(A^*A)^{\frac{1}{2}},$$

for $A \in \mathcal{T}(\mathcal{H})$, the pair $(\mathcal{T}(\mathcal{H}), \|\cdot\|_{\text{tr}})$ is a Banach space (cf. [31]) and is called the trace class on \mathcal{H} .

The set of states or density operators $\mathcal{S}(\mathcal{H}) \subset \mathcal{T}(\mathcal{H})$ is given by

$$\mathcal{S}(\mathcal{H}) := \{\rho \in \mathcal{T}(\mathcal{H}) : \rho \geq 0, \text{tr}\rho = 1\}, \quad (1)$$

where \geq denotes the positive semi-definite partial ordering of operators, and we follow the tradition of using lowercase Greek letters for states. We will also occasionally use the operator norm $\|\cdot\|_{\text{op}}$ on $\mathcal{B}(\mathcal{H})$ which is given by

$$\|A\|_{\text{op}} := \sup_{h \in \mathcal{H} : \|h\| \leq 1} \|Ah\|$$

for $A \in \mathcal{B}(\mathcal{H})$, and for the reader's convenience we summarize the specific properties of the operator and trace norms that we use in Lemma 15 of the appendix. Note that the pair $(\mathcal{B}(\mathcal{H}), \|\cdot\|_{\text{op}})$ is a Banach space as well (cf. [31]).

Given any finite set V , a V -valued *positive operator-valued measure (POVM)* [32], [33] is a sequence $(F_v)_{v \in V}$ of operators on \mathcal{H} such that for all v , $F_v \geq 0$, and

$$\sum_{v \in V} F_v = \mathbf{1}. \quad (2)$$

The POVM $(F_v)_{v \in V}$ is a mathematical description of a measurement with the possible outcomes $v \in V$. For a system in the state $\rho \in \mathcal{S}(\mathcal{H})$, the probability of the outcome $v \in V$ when performing the measurement represented by the POVM $(F_v)_{v \in V}$ is given by the Born rule as

$$p(v) := \text{tr}(\rho F_v). \quad (3)$$

Since $\rho \geq 0$ and $F_v \geq 0$, we have $p(v) \geq 0$. The defining relations (1), (2), and the linearity of the trace show that

$$\sum_{v \in V} p(v) = 1,$$

so that, indeed, p is a probability mass function (p.m.f.) on V .

Throughout the paper, we use the following abbreviations. For a Hilbert space \mathcal{H} , $A \in \mathcal{B}(\mathcal{H})$, and $n \in \mathbb{N}$, $\mathcal{H}^{\otimes n} := \mathcal{H} \otimes \dots \otimes \mathcal{H}$ stands for n -fold tensor product of \mathcal{H} and $A^{\otimes n} := A \otimes \dots \otimes A$ denotes the n -fold tensor power of A . For a set \mathcal{X} and $n \in \mathbb{N}$ we set $\mathcal{X}^n := \mathcal{X} \times \dots \times \mathcal{X}$ for n -fold Cartesian product of the set \mathcal{X} . Moreover, we use the abbreviation $x^n := (x_1, \dots, x_n) \in \mathcal{X}^n$.

Throughout this work, expectations and integrals of operator-valued random variables and functions will play an important role. Since we do not assume that the input alphabet \mathcal{X} is necessarily finite or discrete, we assume that \mathcal{X} is equipped with a σ -algebra Σ which represents a collection of measurable sets. This means in particular that the probability space underlying these expectations is possibly infinite as well. The expectations are therefore formally defined as Bochner integrals on the Banach space $(\mathcal{T}(\mathcal{H}), \|\cdot\|_{\text{tr}})$. The exact definitions and many important facts about Bochner integration can, e.g., be found in [34, Section V.5]. Therefore, many technical questions of measurability and integrability arise in our proofs. We summarize the preliminaries on measurability that we use in this paper in Lemma 18 and the necessary preliminaries on Bochner integration in Lemma 19 of the appendix. When referring to the notions of continuity (measurability) of functions, it is important to specify with respect to which topology (σ -algebra) the function in question is continuous (measurable). We therefore adopt the following conventions: When the domain or range of a function is given as \mathcal{X} , measurability is with respect to Σ . When the domain or range is given as $\mathcal{B}(\mathcal{H})$, the continuity (measurability) of the function is with respect to the topology (Borel σ -algebra) induced by the operator norm. When the domain or range is given as $\mathcal{T}(\mathcal{H})$ or $\mathcal{S}(\mathcal{H})$, the continuity (measurability) of the function is with respect to the topology (Borel σ -algebra) induced by the trace norm. When the domain or range is a subset of \mathbb{R} or \mathbb{C} , we consider the topology (Borel σ -algebra) induced by the Euclidean norm.

B. System Model and Main Result

In this work, we study wiretap channels with classical input, one classical output, one quantum output (c/cq) and wiretap channels with classical input, two quantum outputs (c/qq). Formally, a c/cq wiretap channel is a pair $(W, D_{\mathcal{E}})$, where W is a stochastic kernel (i.e., a classical channel), $D_{\mathcal{E}}$ is a cq channel, and W and $D_{\mathcal{E}}$ share the same input alphabet. The idea behind this definition is that the eavesdropper observes a quantum system instead of a classical output while the legitimate receiver observes a classical output. A c/qq wiretap channel is a pair $(D_{\mathcal{B}}, D_{\mathcal{E}})$ where both $D_{\mathcal{B}}$ and $D_{\mathcal{E}}$ are cq channels.

In the following, we describe the system model (which is also depicted in Fig. 1) in more detail. The transmitter \mathfrak{A} transmits a channel input X which is a random variable ranging over a measurable space (\mathcal{X}, Σ) , the input alphabet. The eavesdropper \mathfrak{E} observes the output of a cq channel which is described by a measurable map $D_{\mathfrak{E}} : \mathcal{X} \rightarrow \mathcal{S}(\mathcal{H}_{\mathfrak{E}})$ where $\mathcal{H}_{\mathfrak{E}}$ is a separable Hilbert space. The measurability of $D_{\mathfrak{E}}$ is with respect to Σ and the Borel σ -algebra induced by the trace norm. In the case of the c/qc wiretap channel (Fig. 1b), the legitimate receiver \mathfrak{B} also observes the output of a cq channel, described by a measurable map $D_{\mathfrak{B}} : \mathcal{X} \rightarrow \mathcal{S}(\mathcal{H}_{\mathfrak{B}})$, where $\mathcal{H}_{\mathfrak{B}}$ is a separable Hilbert space. In the case of the c/cq wiretap channel (Fig. 1a), the legitimate receiver observes the output \hat{X} which is a random variable ranging over another measurable space $(\hat{\mathcal{X}}, \hat{\Sigma})$ and its relationship with X is described by a stochastic kernel $W : \hat{\Sigma} \times \mathcal{X} \rightarrow [0, 1]$, the legitimate receiver's (classical) channel.

For $x^n := (x_1, \dots, x_n) \in \mathcal{X}^n$ and $B_1, \dots, B_n \in \hat{\Sigma}$, we set

$$W^n(B_1 \times \dots \times B_n, x^n) := \prod_{i=1}^n W(B_i, x_i), \quad (4)$$

for classical channels W , and

$$D^n(x^n) := \bigotimes_{i=1}^n D(x_i) = D(x_1) \otimes \dots \otimes D(x_n), \quad (5)$$

for cq channels D , i.e., we consider n -th memoryless extensions of the channels W and D .

A *wiretap code* for the c/cq channel $(W, D_{\mathfrak{E}})$ (for the c/qc channel $(D_{\mathfrak{B}}, D_{\mathfrak{E}})$) with message set size M and *block length* n is a pair (Enc, Dec) such that

- The encoder is a stochastic kernel mapping $\text{Enc} : \Sigma^{\otimes n} \times \{1, \dots, M\} \rightarrow [0, 1]$, where \mathcal{X} is the common input alphabet of W and $D_{\mathfrak{E}}$ (of $D_{\mathfrak{B}}$ and $D_{\mathfrak{E}}$).
- In case of a classical channel W to the legitimate receiver, the decoder is a deterministic mapping $\text{Dec} : \hat{\mathcal{X}}^n \rightarrow \{1, \dots, M\}$, where $\hat{\mathcal{X}}$ is the output alphabet of W .
- In case of a cq channel $D_{\mathfrak{B}}$ to the legitimate receiver, the decoder is a $\{1, \dots, M\}$ -valued POVM $(Y_m)_{m=1}^M$ on $\mathcal{H}_{\mathfrak{B}}$.

The *rate* of a wiretap code is defined as $\log(M)/n$. In this paper, we always use the logarithm (as well as the exponential function denoted \exp) with Euler's number as a base and consequently, the rate is given in nats per channel use. For the c/cq channel and $\varepsilon \geq 0$, we say that the wiretap code has *average error* ε if

$$\mathbb{E}_{\mathfrak{M}} \mathbb{P}(\text{Dec}(\hat{X}^n) \neq \mathfrak{M}) \leq \varepsilon \quad (6)$$

where \hat{X}^n is the random variable observed by the legitimate receiver, resulting from encoding and transmission of a uniformly distributed message \mathfrak{M} through the channel W^n . For the c/qc channel and $\varepsilon \geq 0$, we say that the wiretap code has *average error* ε if

$$\mathbb{E}_{\mathfrak{M}} \text{tr}(D_{\mathfrak{B}}^n \circ \text{Enc}(\mathfrak{M})(\mathbf{1} - Y_{\mathfrak{M}})) \leq \varepsilon \quad (7)$$

for a uniformly distributed message \mathfrak{M} . The composition of the stochastic kernel mapping $\text{Enc} : \Sigma^{\otimes n} \times \{1, \dots, M\} \rightarrow [0, 1]$ and the cq channel $D_{\mathfrak{B}}^n : \mathcal{X}^n \rightarrow \mathcal{S}(\mathcal{H}_{\mathfrak{B}}^{\otimes n})$ is given by

$$D_{\mathfrak{B}}^n \circ \text{Enc}(m) := \int_{\mathcal{X}^n} D_{\mathfrak{B}}^n(x^n) \text{Enc}(dx^n, m), \quad (8)$$

for $m \in \{1, \dots, M\}$. Note that the integral is well-defined by the measurability of $D_{\mathfrak{B}}$ and that the integral exists in Bochner sense by Lemma 19-1). Moreover, $D_{\mathfrak{B}}^n \circ \text{Enc}(m) \in \mathcal{S}(\mathcal{H}_{\mathfrak{B}}^{\otimes n})$ by Lemmas 19-4) and Lemma 19-3).

Remark 1. *Despite their different appearance, the expressions in (6) and (7) are closely related, as we will briefly explain. Introducing the indicator functions of the decoding sets $\mathbb{1}_{\text{Dec}(m)-1}$ for $m \in \{1, \dots, M\}$, we can write (6) as*

$$\mathbb{E}_{\mathfrak{M}} \mathbb{P}(\text{Dec}(\hat{X}^n) \neq \mathfrak{M}) = \frac{1}{M} \sum_{m=1}^M \sum_{\hat{m}=1: \hat{m} \neq m}^M \int \left(\int \mathbb{1}_{\text{Dec}(\hat{m})-1}(\hat{x}^n) W^n(d\hat{x}^n, x^n) \right) \text{Enc}(dx^n, m). \quad (9)$$

On the other hand, using (2) for the decoding POVM $(Y_m)_{m=1}^M$ together with the linearity of the trace and the integral, we have

$$\mathbb{E}_{\mathfrak{M}} \text{tr}(D_{\mathfrak{B}}^n \circ \text{Enc}(\mathfrak{M})(\mathbf{1} - Y_{\mathfrak{M}})) = \frac{1}{M} \sum_{m=1}^M \sum_{\hat{m}=1: \hat{m} \neq m}^M \int \text{tr}(Y_{\hat{m}} D_{\mathfrak{B}}^n(x^n)) \text{Enc}(dx^n, m). \quad (10)$$

The inner integral in (9) and the term containing the trace in (10) both describe the probability that the message \hat{m} is detected/measured given that the channel input is $x^n \in \mathcal{X}^n$.

For $\delta \geq 0$, we say that the wiretap code (Enc, Dec) has *distinguishing security level* δ if

$$\forall m_1, m_2 \in \{1, \dots, M\} \quad \|D_{\mathfrak{E}}^n \circ \text{Enc}(m_1) - D_{\mathfrak{E}}^n \circ \text{Enc}(m_2)\|_{\text{tr}} \leq \delta, \quad (11)$$

where $D_{\mathfrak{E}}^n \circ \text{Enc}$ is defined in an analogous way to (8).

The main results of this work state that wiretap codes for certain c/cq and c/qq channels exist that simultaneously achieve low average error and low distinguishing security level. Achievable secrecy rates are characterized by two information quantities. Information density and mutual information of the classical channel W associated with an input distribution P on \mathcal{X} are defined in the usual way as

$$i_P(x^n; \hat{x}^n) := \log \frac{dW^n(\cdot, x^n)}{d\hat{P}}(\hat{x}^n), \quad I(P, W) := \mathbb{E}i_P(X; \hat{X}) \quad (12)$$

where \hat{P} is the distribution of the output of W under the input distribution P , and \hat{X} is a random variable distributed according to \hat{P} (or $\hat{X} \sim \hat{P}$ for short). For $\rho \in \mathcal{S}(\mathcal{H})$, we define the *von Neumann entropy*

$$H(\rho) := -\text{tr}(\rho \log \rho)$$

with the convention $H(\rho) = \infty$ if $\rho \log \rho \notin \mathcal{T}(\mathcal{H})$. For an input distribution P , $X \sim P$, and a cq channel $D : \mathcal{X} \rightarrow \mathcal{S}(\mathcal{H})$, we define

$$D_P := \mathbb{E}D(X) \quad (13)$$

to be the density operator of the output of the channel under input distribution P . Note that since $\|D(x)\|_{\text{tr}} = 1$ for all $x \in \mathcal{X}$, the expectation $\mathbb{E}D(X)$ exists by Lemma 19-1). Moreover, von Neumann entropy $H(\cdot)$ is lower semi-continuous with respect to the topology induced by the trace norm $\|\cdot\|_{\text{tr}}$ (cf. [35, Theorem 11.6]). Consequently, the map $\mathcal{X} \ni x \mapsto H(D(x))$ is measurable. Therefore, for a random variable $X \sim P$, we can define the *Holevo information* as

$$\chi(P; D) := \mathbb{E}\text{tr}(D(X) \log D(X)) - \text{tr}(D_P \log D_P) = H(D_P) - \mathbb{E}H(D(X)), \quad (14)$$

where we adopt the convention that $\chi(P; D) = \infty$ whenever $H(D_P) = \infty$ or if the integral $\mathbb{E}H(D(X))$ does not exist. More information on definition, measurability, and structural properties of $\chi(P; D)$ can be found in [36].

An *additive cost constraint* (c, C) consists of a measurable cost function $c : \mathcal{X} \rightarrow [0, \infty)$ and a constraint $C \in (0, \infty)$. A tuple $x^n \in \mathcal{X}^n$ satisfies the additive cost constraint (c, C) if

$$c(x_1) + \dots + c(x_n) \leq nC.$$

We say that the cost constraint is *compatible* with a distribution P on \mathcal{X} if, for $X \sim P$, we have

$$\mathbb{E}c(X) < C,$$

and if there is $t \in (0, \infty)$ with $\mathbb{E}\exp(tc(X)) < \infty$.

We have now introduced all necessary terminology to state the main result of this work. For better readability, we state the result for the c/cq wiretap channel (Theorem 1) and for the c/qq wiretap channel (Theorem 2) separately although the theorems are very similar. The proofs are deferred to Section V-F.

Theorem 1. *Let (W, D) be a c/cq wiretap channel, let P be a probability distribution on the input alphabet \mathcal{X} , and let $X \sim P$ such that*

- *there is $\alpha_{\min} < 1$ with $D_{\mathfrak{E}}(x)^{\alpha_{\min}} \in \mathcal{T}(\mathcal{H})$ for almost all x , $D_P^{\alpha_{\min}} \in \mathcal{T}(\mathcal{H})$, and the Bochner integral $\mathbb{E}D_{\mathfrak{E}}(X)^{\alpha_{\min}}$ exists;*
- *there is $t > 0$ such that $\mathbb{E}\exp(ti_P(X; \hat{X})) < \infty$.*

Let (c, C) be a cost constraint compatible with P , and let $R < I(P, W) - \chi(P; D_{\mathfrak{E}})$. Then there are $\gamma_1, \gamma_2 \in (0, \infty)$ such that for sufficiently large n , there exists a wiretap code with the following properties:

- 1) *The code has a rate of at least R .*
- 2) *The output of the encoder satisfies the cost constraint (c, C) almost surely.*
- 3) *The code has an average error $\varepsilon = \exp(-\gamma_1 n)$ as defined in (6).*
- 4) *The code has distinguishing security level $\delta = \exp(-\gamma_2 n)$ as defined in (11).*

Theorem 2. *Let $(D_{\mathfrak{B}}, D_{\mathfrak{E}})$ be a c/qq wiretap channel, and let P be a probability distribution on the input alphabet \mathcal{X} such that for both choices of $D \in \{D_{\mathfrak{E}}, D_{\mathfrak{B}}\}$, there is $\alpha_{\min} < 1$ with $D(x)^{\alpha_{\min}} \in \mathcal{T}(\mathcal{H})$ for almost all x , $D_P^{\alpha_{\min}} \in \mathcal{T}(\mathcal{H})$, and the Bochner integral $\mathbb{E}D(X)^{\alpha_{\min}}$ exists, where $X \sim P$.*

Let (c, C) be a cost constraint compatible with P , and let $R < \chi(P; D_{\mathfrak{B}}) - \chi(P; D_{\mathfrak{E}})$. Then there are $\gamma_1, \gamma_2 \in (0, \infty)$ such that for sufficiently large n , there exists a wiretap code with the following properties:

- 1) *The code has a rate of at least R .*
- 2) *The output of the encoder satisfies the cost constraint (c, C) almost surely.*
- 3) *The code has an average error of $\varepsilon = \exp(-\gamma_1 n)$ as defined in (7).*
- 4) *The code has distinguishing security level $\delta = \exp(-\gamma_2 n)$ as defined in (11).*

Remark 2. As mentioned in the introduction, converse results were derived in [22], [26], [27]. Single-letter versions are shown for degradable channels; otherwise the bounds are of the multi-letter variety. In [37], it has been shown by means of many explicit examples that the capacity of c/qc and c/cq wiretap channels is non-additive. Therefore, single-letter converses are not possible in general.

III. SECURITY NOTIONS FOR WIRETAP CHANNELS WITH QUANTUM OUTPUTS

The distinguishing security criterion provided by Theorems 1 and 2 implies security guarantees against eavesdropping attacks that extend beyond an attacker's ability to reconstruct the entire transmitted message. In this section, we discuss various notions of security and their operational implications.

A. Semantic Security

In this subsection, we give a definition of semantic security that is analogous to the classical archetype in [15]. Formally, semantic security means that a large class of possible objectives (which includes the objective of reconstructing the entire transmitted message, but also many others) cannot be reached by the eavesdropper.

Problem 1. (Eavesdropper's objective.) *Each possible eavesdropper's objective that we consider in this paper is defined by a partition Π of the message space $\{1, \dots, M\}$. The eavesdropper's objective is then to output some $\pi \in \Pi$ such that the originally transmitted message is contained in π .*

The partition of $\{1, \dots, M\}$ that corresponds to the reconstruction of the entire message consists of all singleton sets, i.e.,

$$\Pi = \{\{1\}, \dots, \{M\}\}.$$

But also other possible objectives can be defined by a message space partition. For instance, the task of reconstructing the first bit of the transmitted message would be represented by

$$\Pi = \{m : \text{The binary representation of } m \text{ starts with } 0\}, \{m : \text{The binary representation of } m \text{ starts with } 1\}.$$

In this section, we assume that the eavesdropper has prior knowledge of the probability distribution $P_{\mathfrak{M}}$ from which the transmitted message \mathfrak{M} is drawn. While this may not be realistic in some practical scenarios, it is certainly possible, for example when the eavesdropper knows that a protocol is executed in which only certain messages can be transmitted at certain time instances. In any case, this is not a restrictive assumption since it represents an additional advantage that the eavesdropper has compared to a case where no such prior knowledge is available.

We assume in this work that, after message \mathfrak{M} has been transmitted, the eavesdropper can perform any Π -valued POVM on the output $\rho_{\mathfrak{E}}^n(\mathfrak{M})$ of the channel

$$\rho_{\mathfrak{E}}^n := D_{\mathfrak{E}}^n \circ \text{Enc}. \quad (15)$$

By the Born rule, a Π -valued POVM $(F_{\pi})_{\pi \in \Pi}$ and $\rho_{\mathfrak{E}}^n(\mathfrak{M})$ induce a probability distribution on Π , described by the p.m.f.

$$p(\pi) := \text{tr}(F_{\pi} \rho_{\mathfrak{E}}^n(\mathfrak{M})).$$

p describes the probability distribution of the eavesdropper's conclusion of what the correct partition element π is under a fixed communication scheme, distribution of the message, and reconstruction strategy of the eavesdropper.

We define the eavesdropper's maximum success probability when a quantum measurement is performed on a quantum state $\rho_{\mathfrak{E}}^n(\mathfrak{M})$ as

$$\text{Succ}(\Pi, P_{\mathfrak{M}}, \rho_{\mathfrak{E}}^n) := \sup \left\{ \mathbb{E}_{\mathfrak{M}} \sum_{\pi \in \Pi: \mathfrak{M} \in \pi} \text{tr}(F_{\pi} \rho_{\mathfrak{E}}^n(\mathfrak{M})) : (F_{\pi})_{\pi \in \Pi} \text{ is a POVM} \right\}. \quad (16)$$

Note that since Π is a partition, the sum consists of only one summand for each fixed realization of \mathfrak{M} .

It is important to emphasize at this point that it is not possible in general to guarantee a low eavesdropper's success probability. For instance, \mathfrak{M} could be drawn from a distribution where the binary representation of \mathfrak{M} almost surely starts with 0. What we can control, however, is the advantage that the eavesdropper gains by observing $\rho_{\mathfrak{E}}^n(\mathfrak{M})$ compared to the situation where it cannot observe any channel output. We denote the maximum achievable success probability in solving Problem 1 for partition Π and message distribution $P_{\mathfrak{M}}$ without observing any quantum state (i.e., by pure guessing) by

$$\text{Guess}(\Pi, P_{\mathfrak{M}}) := \sup \{\mathbb{P}\{\mathfrak{M} \in \pi\} : \pi \text{ is a random variable ranging over } \Pi\}.$$

This leads us to the following definition of semantic security.

Definition 1. The eavesdropper's semantic security advantage associated with the eavesdropper's output state $\rho_{\mathfrak{E}}^n(\mathfrak{M})$ is defined as

$$\text{Adv}_{\text{sem}}(\rho_{\mathfrak{E}}^n) := \sup \left\{ \text{Succ}(\Pi, P_{\mathfrak{M}}, \rho_{\mathfrak{E}}^n) - \text{Guess}(\Pi, P_{\mathfrak{M}}) : \right. \\ \left. \Pi \text{ is a partition of } \{1, \dots, M\}, P_{\mathfrak{M}} \text{ is a probability distribution on } \{1, \dots, M\}. \right\} \quad (17)$$

We say that semantic security level δ is satisfied for the output state $\rho_{\mathfrak{E}}^n$ if

$$\text{Adv}_{\text{sem}}(\rho_{\mathfrak{E}}^n) \leq \delta.$$

This is a straightforward quantum analog of the term *semantic security* which is already an established performance metric both in classical cryptography and information-theoretic secrecy [15].

B. Other Security Notions

There are alternative security definitions that are easier to analyze in proofs than semantic security in the sense of Definition 1. In this section, we introduce several of these alternative established notions of security. We point out that the terminology is not the same everywhere in the literature, neither for classical nor for quantum wiretap channels. Because both distinguishing security as defined in Definition 2-4) and mutual information security as defined in Definition 2-3) below imply semantic security in the sense of Definition 1 above, some papers use these alternative definitions directly for semantic security. In this section, we define these alternative notions and show some implications between them. This is very similar to the treatment of the classical case [15], [38].

Definition 2. Given a cq channel $\{1, \dots, M\} \ni m \mapsto \rho_{\mathfrak{E}}^n(m)$ (cf. Eq. (15)) and $\delta \in \mathbb{R}$, $\delta \geq 0$, we say that:

1) Weak secrecy level δ is satisfied if

$$\text{Adv}_{\text{weak}}(\rho_{\mathfrak{E}}^n) := \frac{1}{n} \chi(P_{\mathfrak{M}}; \rho_{\mathfrak{E}}^n) \leq \delta,$$

where $P_{\mathfrak{M}}$ is the uniform distribution over all messages $\{1, \dots, M\}$.

2) Strong secrecy level δ is satisfied if

$$\text{Adv}_{\text{str}}(\rho_{\mathfrak{E}}^n) := \chi(P_{\mathfrak{M}}; \rho_{\mathfrak{E}}^n) \leq \delta,$$

where $P_{\mathfrak{M}}$ is the uniform distribution over all messages $\{1, \dots, M\}$.

3) Mutual information security level δ is satisfied if

$$\text{Adv}_{\text{inf}}(\rho_{\mathfrak{E}}^n) := \max_{P_{\mathfrak{M}}} \chi(P_{\mathfrak{M}}; \rho_{\mathfrak{E}}^n) \leq \delta,$$

where $P_{\mathfrak{M}}$ ranges over all probability distributions of messages $\{1, \dots, M\}$.

4) Distinguishing security level δ is satisfied if

$$\text{Adv}_{\text{dist}}(\rho_{\mathfrak{E}}^n) := \max \left\{ \|\rho_{\mathfrak{E}}^n(m_1) - \rho_{\mathfrak{E}}^n(m_2)\|_{\text{tr}} : m_1, m_2 \in \{1, \dots, M\} \right\} \leq \delta.$$

The terms on the left-hand side of these inequalities are called the weak secrecy (strong secrecy, mutual information security, distinguishing security) advantage of the eavesdropper.

For a sequence of encoding schemes with growing block length n , we say that the sequence is semantically secure (weakly secret, strongly secret, mutual information secure, distinction secure) if the corresponding advantage vanishes as n tends to infinity.

Remark 3. We note that post-processing steps carried out by the eavesdropper cannot increase any of the advantages given in Definition 1 and Definition 2. To see this, let $\mathcal{N} : \mathcal{T}(\mathcal{H}_{\mathfrak{E}}) \rightarrow \mathcal{T}(\mathcal{H}'_{\mathfrak{E}})$ be a quantum channel, i.e., positive, trace-preserving map such that the dual map $\mathcal{N}' : \mathcal{B}(\mathcal{H}'_{\mathfrak{E}}) \rightarrow \mathcal{B}(\mathcal{H}_{\mathfrak{E}})$, given by

$$\text{tr}(A\mathcal{N}(B)) = \text{tr}(\mathcal{N}'(A)B) \quad (18)$$

for all $A \in \mathcal{B}(\mathcal{H}'_{\mathfrak{E}})$ and all $B \in \mathcal{T}(\mathcal{H}_{\mathfrak{E}})$, is completely positive [33, Section 7.1]. The map \mathcal{N} represents a possible post-processing that can be performed by the eavesdropper. The monotonicity of quantum relative entropy under the action of quantum channels [39] implies that

$$\text{Adv}_{\text{weak}}(\mathcal{N} \circ \rho_{\mathfrak{E}}^n) \leq \text{Adv}_{\text{weak}}(\rho_{\mathfrak{E}}^n),$$

$$\text{Adv}_{\text{str}}(\mathcal{N} \circ \rho_{\mathfrak{E}}^n) \leq \text{Adv}_{\text{str}}(\rho_{\mathfrak{E}}^n),$$

and

$$\text{Adv}_{\text{inf}}(\mathcal{N} \circ \rho_{\mathfrak{E}}^n) \leq \text{Adv}_{\text{inf}}(\rho_{\mathfrak{E}}^n).$$

Moreover, since for all states $\rho, \sigma \in \mathcal{S}(\mathcal{H})$ we have [32, Prop. 4.37]

$$\|\mathcal{N}(\rho) - \mathcal{N}(\sigma)\|_{\text{tr}} \leq \|\rho - \sigma\|_{\text{tr}},$$

we can conclude that

$$\text{Adv}_{\text{dist}}(\mathcal{N} \circ \rho_{\mathcal{E}}^n) \leq \text{Adv}_{\text{dist}}(\rho_{\mathcal{E}}^n),$$

holds as well. Finally, we have

$$\text{Adv}_{\text{sem}}(\mathcal{N} \circ \rho_{\mathcal{E}}^n) \leq \text{Adv}_{\text{sem}}(\rho_{\mathcal{E}}^n),$$

which can be deduced as follows. Since for any given partition Π and probability distribution $P_{\mathfrak{M}}$, the quantity

$$\text{Guess}(\Pi, P_{\mathfrak{M}})$$

does not depend on the eavesdropper's output state, it is sufficient to prove

$$\text{Succ}(\Pi, P_{\mathfrak{M}}, \mathcal{N} \circ \rho_{\mathcal{E}}^n) \leq \text{Succ}(\Pi, P_{\mathfrak{M}}, \rho_{\mathcal{E}}^n),$$

for all partitions Π and probability distributions $P_{\mathfrak{M}}$. Showing this is the aim of the following argument:

$$\begin{aligned} \text{Succ}(\Pi, P_{\mathfrak{M}}, \mathcal{N} \circ \rho_{\mathcal{E}}^n) &= \sup \left\{ \mathbb{E}_{\mathfrak{M}} \sum_{\pi \in \Pi: \mathfrak{M} \in \pi} \text{tr}(F_{\pi} \mathcal{N} \circ \rho_{\mathcal{E}}^n(\mathfrak{M})) : (F_{\pi})_{\pi \in \Pi} \text{ is a POVM on } \mathcal{H}'_{\mathcal{E}} \right\} \\ &\stackrel{(a)}{=} \sup \left\{ \mathbb{E}_{\mathfrak{M}} \sum_{\pi \in \Pi: \mathfrak{M} \in \pi} \text{tr}(\mathcal{N}'(F_{\pi}) \rho_{\mathcal{E}}^n(\mathfrak{M})) : (F_{\pi})_{\pi \in \Pi} \text{ is a POVM on } \mathcal{H}'_{\mathcal{E}} \right\} \\ &= \sup \left\{ \mathbb{E}_{\mathfrak{M}} \sum_{\pi \in \Pi: \mathfrak{M} \in \pi} \text{tr}(F'_{\pi} \rho_{\mathcal{E}}^n(\mathfrak{M})) : F'_{\pi} = \mathcal{N}'(F_{\pi}) \text{ where } (F_{\pi})_{\pi \in \Pi} \text{ is a POVM on } \mathcal{H}'_{\mathcal{E}} \right\} \\ &\stackrel{(b)}{\leq} \sup \left\{ \mathbb{E}_{\mathfrak{M}} \sum_{\pi \in \Pi: \mathfrak{M} \in \pi} \text{tr}(F'_{\pi} \rho_{\mathcal{E}}^n(\mathfrak{M})) : (F'_{\pi})_{\pi \in \Pi} \text{ is a POVM on } \mathcal{H}_{\mathcal{E}} \right\} \\ &= \text{Succ}(\Pi, P_{\mathfrak{M}}, \rho_{\mathcal{E}}^n), \end{aligned}$$

where step (a) is by definition (18) of the dual map \mathcal{N}' . The inequality (b) follows from the fact that \mathcal{N}' is a unital (i.e., $\mathcal{N}'(\mathbf{1}_{\mathcal{H}'_{\mathcal{E}}}) = \mathbf{1}_{\mathcal{H}_{\mathcal{E}}}$) and positive map. Therefore, it maps the POVMs on $\mathcal{H}'_{\mathcal{E}}$ to a subset of the POVMs on the Hilbert space $\mathcal{H}_{\mathcal{E}}$, which leads to a larger supremum in the inequality (b).

Consequently, in proofs of security guarantees, it is sufficient to focus on the case $\rho_{\mathcal{E}}^n = D^n \circ \text{Enc}$, as we do in Theorems 1 and 2, since the guarantees automatically extend to all post-processing attempts represented by application of quantum channels at the eavesdropper.

In the remainder of this section, we follow the arguments in [38] for the classical case and prove that similar implications also hold in the quantum case between the different security notions of Definitions 1 and 2. For the implication from distinguishing security to mutual information security, we use a slightly more general approach that applies not only to finite-dimensional systems but also to some practically relevant infinite-dimensional systems.

Lemma 1. $\text{Adv}_{\text{sem}}(\rho_{\mathcal{E}}^n) \leq \frac{1}{2} \text{Adv}_{\text{dist}}(\rho_{\mathcal{E}}^n)$.

Proof. Suppose the eavesdropper's output state is $\rho_{\mathcal{E}}^n(\mathfrak{M})$, and let $(F_{\pi})_{\pi \in \Pi}$ be a POVM.

We define a p.m.f.

$$q : \Pi \rightarrow [0, 1], \quad \pi \mapsto \mathbb{E}_{\mathfrak{M}} \text{tr}(F_{\pi} \rho_{\mathcal{E}}^n(\mathfrak{M})). \quad (19)$$

Clearly, q does not depend on an observed channel output, so we have

$$\text{Guess}(\Pi, P_{\mathfrak{M}}) \geq \mathbb{E}_{\mathfrak{M}} \sum_{\pi \in \Pi: \mathfrak{M} \in \pi} q(\pi). \quad (20)$$

Therefore,

$$\begin{aligned} \mathbb{E}_{\mathfrak{M}} \sum_{\pi \in \Pi: \mathfrak{M} \in \pi} \text{tr}(F_{\pi} \rho_{\mathcal{E}}^n(\mathfrak{M})) - \text{Guess}(\Pi, P_{\mathfrak{M}}) &\stackrel{(20)}{\leq} \mathbb{E}_{\mathfrak{M}} \sum_{\pi \in \Pi: \mathfrak{M} \in \pi} (\text{tr}(F_{\pi} \rho_{\mathcal{E}}^n(\mathfrak{M})) - q(\pi)) \\ &\stackrel{(19)}{=} \mathbb{E}_{\mathfrak{M}} \sum_{\pi \in \Pi: \mathfrak{M} \in \pi} (\text{tr}(F_{\pi} \rho_{\mathcal{E}}^n(\mathfrak{M})) - \mathbb{E}_{\mathfrak{M}} \text{tr}(F_{\pi} \rho_{\mathcal{E}}^n(\mathfrak{M}))) \\ &= \mathbb{E}_{\mathfrak{M}} \text{tr} \left(\sum_{\pi \in \Pi: \mathfrak{M} \in \pi} (F_{\pi} \rho_{\mathcal{E}}^n(\mathfrak{M}) - F_{\pi} \mathbb{E}_{\mathfrak{M}} \rho_{\mathcal{E}}^n(\mathfrak{M})) \right) \end{aligned}$$

$$\begin{aligned}
&= \mathbb{E}_{\mathfrak{M}} \operatorname{tr} \left(\left(\sum_{\pi \in \Pi: \mathfrak{M} \in \pi} F_{\pi} \right) (\rho_{\mathfrak{E}}^n(\mathfrak{M}) - \mathbb{E}_{\mathfrak{M}} \rho_{\mathfrak{E}}^n(\mathfrak{M})) \right) \\
&\stackrel{(a)}{\leq} \frac{1}{2} \mathbb{E}_{\mathfrak{M}} \|\rho_{\mathfrak{E}}^n(\mathfrak{M}) - \mathbb{E}_{\mathfrak{M}} \rho_{\mathfrak{E}}^n(\mathfrak{M})\|_{\operatorname{tr}} \\
&\stackrel{(b)}{\leq} \frac{1}{2} \mathbb{E}_{\mathfrak{M}, \mathfrak{M}'} \|\rho_{\mathfrak{E}}^n(\mathfrak{M}') - \rho_{\mathfrak{E}}^n(\mathfrak{M})\|_{\operatorname{tr}} \\
&\leq \frac{1}{2} \operatorname{Adv}_{\operatorname{dist}}(\rho_{\mathfrak{E}}^n).
\end{aligned}$$

(a) is by Lemma 15-5), and (b) is by replacing \mathfrak{M} with an independent copy \mathfrak{M}' and then applying Lemma 19-2). Since this derivation holds for every choice of F , $P_{\mathfrak{M}}$ and Π , the lemma immediately follows. \square

Lemma 2. $\operatorname{Adv}_{\operatorname{dist}}(\rho_{\mathfrak{E}}^n) \leq 4 \operatorname{Adv}_{\operatorname{sem}}(\rho_{\mathfrak{E}}^n)$.

Proof. Fix arbitrary $m_1, m_2 \in \{1, \dots, M\}$. We will show that

$$\|\rho_{\mathfrak{E}}^n(m_1) - \rho_{\mathfrak{E}}^n(m_2)\|_{\operatorname{tr}} \leq 4 \operatorname{Adv}_{\operatorname{sem}}(\rho_{\mathfrak{E}}^n).$$

Since this is immediately clear for $m_1 = m_2$, we may assume $m_1 \neq m_2$ in the following. We fix the message probability distribution

$$P_{\mathfrak{M}}(m) := \begin{cases} \frac{1}{2}, & m \in \{m_1, m_2\} \\ 0, & \text{otherwise,} \end{cases}$$

and the partition $\Pi := \{\{m_1\}, \{1, \dots, M\} \setminus \{m_1\}\}$. Any guess over this partition will be correct with probability 1/2. So for any operator $0 \leq F \leq \mathbf{1}$, we can calculate

$$\operatorname{Adv}_{\operatorname{sem}}(\rho_{\mathfrak{E}}^n) \stackrel{(17)}{\geq} \operatorname{Succ}(\Pi, P_{\mathfrak{M}}, \rho_{\mathfrak{E}}^n) - \frac{1}{2} \geq \frac{1}{2} \operatorname{tr}(F \rho_{\mathfrak{E}}^n(m_1)) + \frac{1}{2} \operatorname{tr}((1-F) \rho_{\mathfrak{E}}^n(m_2)) - \frac{1}{2} = \frac{1}{2} \operatorname{tr}(F(\rho_{\mathfrak{E}}^n(m_1) - \rho_{\mathfrak{E}}^n(m_2))).$$

We now fix F as the operator which maximizes the latter term according to Lemma 15-5), and obtain

$$\operatorname{Adv}_{\operatorname{sem}}(A) \geq \frac{1}{4} \|\rho_{\mathfrak{E}}^n(m_1) - \rho_{\mathfrak{E}}^n(m_2)\|_{\operatorname{tr}},$$

concluding the proof. \square

Lemma 3. $\operatorname{Adv}_{\operatorname{dist}}(\rho_{\mathfrak{E}}^n) \leq 2\sqrt{2 \operatorname{Adv}_{\operatorname{inf}}(\rho_{\mathfrak{E}}^n)}$.

Proof. Fix arbitrary $m_1, m_2 \in \{1, \dots, M\}$. We will show that

$$\|\rho_{\mathfrak{E}}^n(m_1) - \rho_{\mathfrak{E}}^n(m_2)\|_{\operatorname{tr}} \leq 2\sqrt{2 \operatorname{Adv}_{\operatorname{inf}}(\rho_{\mathfrak{E}}^n)}. \quad (21)$$

Since this is immediately clear for $m_1 = m_2$, we may assume $m_1 \neq m_2$ in the following. We define quantum states

$$\begin{aligned}
\rho &:= \frac{1}{2} |m_1\rangle \langle m_1| \otimes \rho_{\mathfrak{E}}^n(m_1) + \frac{1}{2} |m_2\rangle \langle m_2| \otimes \rho_{\mathfrak{E}}^n(m_2) \\
\sigma &:= \left(\frac{1}{2} |m_1\rangle \langle m_1| + \frac{1}{2} |m_2\rangle \langle m_2| \right) \otimes \left(\frac{1}{2} \rho_{\mathfrak{E}}^n(m_1) + \frac{1}{2} \rho_{\mathfrak{E}}^n(m_2) \right),
\end{aligned}$$

where $|m_1\rangle, |m_2\rangle$ are an orthonormal basis of some 2-dimensional Hilbert space. We further fix a distribution $P_{\mathfrak{M}}$ on the set $\{1, \dots, M\}$ of messages via

$$P_{\mathfrak{M}}(m) := \begin{cases} \frac{1}{2}, & m \in \{m_1, m_2\} \\ 0, & \text{otherwise.} \end{cases}$$

Then, we can calculate

$$\begin{aligned}
\operatorname{Adv}_{\operatorname{inf}}(\rho_{\mathfrak{E}}^n) &\geq \chi(P_{\mathfrak{M}}; \rho_{\mathfrak{E}}^n) \\
&\stackrel{(a)}{=} H(\rho; \sigma) \\
&\stackrel{(b)}{\geq} \frac{1}{2} \|\rho - \sigma\|_{\operatorname{tr}}^2 \\
&= \frac{1}{2} \left\| \frac{1}{4} (|m_1\rangle \langle m_1| - |m_2\rangle \langle m_2|) \otimes (\rho_{\mathfrak{E}}^n(m_1) - \rho_{\mathfrak{E}}^n(m_2)) \right\|_{\operatorname{tr}}^2 \\
&= \frac{1}{2} \cdot \frac{1}{16} \| |m_1\rangle \langle m_1| - |m_2\rangle \langle m_2| \|_{\operatorname{tr}}^2 \|\rho_{\mathfrak{E}}^n(m_1) - \rho_{\mathfrak{E}}^n(m_2)\|_{\operatorname{tr}}^2 \\
&= \frac{1}{8} \|\rho_{\mathfrak{E}}^n(m_1) - \rho_{\mathfrak{E}}^n(m_2)\|_{\operatorname{tr}}^2
\end{aligned}$$

where step (a) uses the definition of *relative quantum entropy*

$$H(\rho; \sigma) := \text{tr} \rho \log \rho - \text{tr} \rho \log \sigma,$$

where by convention, $H(\rho; \sigma) = \infty$ whenever the support of ρ is not contained in the support of σ or one of the traces is infinite [35, Definition 7.1]. Step (b) is a quantum version of the Pinsker inequality, namely, the stronger version of [35, Prop. 7.3] that is mentioned in [35, Section 7.8] and originally proven for a more general scenario in [40, Theorem 3.1]. This yields (21), concluding the proof of the lemma. \square

For the bound of $\text{Adv}_{\text{inf}}(\rho_{\mathfrak{E}}^n)$ in terms of $\text{Adv}_{\text{dist}}(\rho_{\mathfrak{E}}^n)$, we introduce some technical terms first. A linear operator G on \mathcal{H} is called a *Gibbs observable* if it satisfies the following properties:

- It is of the form

$$G|h\rangle := \sum_{i \in \mathbb{N}} g_i \langle e_i, h \rangle |e_i\rangle, \quad (22)$$

defined on the dense domain

$$\mathcal{D}(G) := \left\{ h \in \mathcal{H} : \sum_{i \in \mathbb{N}} |g_i|^2 |\langle e_i, h \rangle|^2 < \infty \right\}, \quad (23)$$

where $(g_i)_{i \in \mathbb{N}}$ is an unbounded sequence of nonnegative real numbers that includes 0 and $|e_i\rangle_{i \in \mathbb{N}}$ form an orthonormal basis in \mathcal{H} (cf. [35, Definition 11.3] and [41, Section 4]). Note that G is an unbounded self-adjoint operator on the domain $\mathcal{D}(G)$ (which is a simple consequence of [31, Theorem VIII.3 (c)]).

- For every $\beta \in (0, \infty)$, it holds that

$$\exp(-\beta G) \in \mathcal{T}(\mathcal{H}), \quad (24)$$

with the definition

$$\exp(-\beta G)|h\rangle := \sum_{i \in \mathbb{N}} \exp(-\beta g_i) \langle e_i, h \rangle |e_i\rangle,$$

$h \in \mathcal{H}$ (cf. [41, Section 4]). Note that for (24) to hold, it is necessary that the spectrum of G given by the sequence $(g_i)_{i \in \mathbb{N}}$ is unbounded and every eigenvalue has finite multiplicity.

For a Gibbs observable G and $\rho \in \mathcal{S}(\mathcal{H})$, we adopt the convention (cf. [35, (11.6)])

$$\text{tr}(\rho G) := \sum_{i \in \mathbb{N}} g_i \langle e_i, \rho e_i \rangle \in [0, \infty], \quad (25)$$

and we define (see [41, Section 4]) for $E \in [0, \infty)$

$$H_G(E) := \sup \{ H(\rho) : \rho \in \mathcal{S}(\mathcal{H}), \text{tr}(\rho G) \leq E \} \in [0, \infty). \quad (26)$$

In [42, Proposition 1], it is proven that this supremum is finite and is in fact realized by a state of maximum entropy.

Lemma 4. *Suppose that G^n is a Gibbs observable on $\mathcal{H}_{\mathfrak{E}}^{\otimes n}$ and $E \in [0, \infty)$ such that for every $m \in \{1, \dots, M\}$, we have $\text{tr}(\rho_{\mathfrak{E}}^n(m) G^n) \leq E$. Assume further that $\text{Adv}_{\text{dist}}(\rho_{\mathfrak{E}}^n) \leq 1$. Then, we have*

$$\text{Adv}_{\text{inf}}(\rho_{\mathfrak{E}}^n) \leq \text{Adv}_{\text{dist}}(\rho_{\mathfrak{E}}^n) H_{G^n} \left(\frac{2E}{\text{Adv}_{\text{dist}}(\rho_{\mathfrak{E}}^n)} \right) + h \left(\frac{\text{Adv}_{\text{dist}}(\rho_{\mathfrak{E}}^n)}{2} \right),$$

where $h : [0, 1] \rightarrow \mathbb{R}, t \mapsto -t \log t - (1-t) \log(1-t)$ is the binary entropy.

Proof. We fix an arbitrary probability distribution $P_{\mathfrak{M}}$ on $\{1, \dots, M\}$ and define

$$\tilde{m} := \arg \min_{m \in \{1, \dots, M\}} H(\rho_{\mathfrak{E}}^n(m)). \quad (27)$$

Then, we have

$$\begin{aligned} \chi(P_{\mathfrak{M}}; \rho_{\mathfrak{E}}^n) &= H(\mathbb{E}_{\mathfrak{M}} \rho_{\mathfrak{E}}^n(m)) - \mathbb{E}_{\mathfrak{M}} H(\rho_{\mathfrak{E}}^n(\mathfrak{M})) \\ &\stackrel{(27)}{\leq} H(\mathbb{E}_{\mathfrak{M}} \rho_{\mathfrak{E}}^n(m)) - H(\rho_{\mathfrak{E}}^n(\tilde{m})) \\ &\stackrel{(a)}{\leq} \|\mathbb{E}_{\mathfrak{M}} \rho_{\mathfrak{E}}^n(m) - \rho_{\mathfrak{E}}^n(\tilde{m})\|_{\text{tr}} H_{G^n} \left(\frac{2E}{\|\mathbb{E}_{\mathfrak{M}} \rho_{\mathfrak{E}}^n(m) - \rho_{\mathfrak{E}}^n(\tilde{m})\|_{\text{tr}}} \right) + h \left(\frac{\|\mathbb{E}_{\mathfrak{M}} \rho_{\mathfrak{E}}^n(m) - \rho_{\mathfrak{E}}^n(\tilde{m})\|_{\text{tr}}}{2} \right) \\ &\stackrel{(b)}{\leq} \text{Adv}_{\text{dist}}(\rho_{\mathfrak{E}}^n) H_{G^n} \left(\frac{2E}{\text{Adv}_{\text{dist}}(\rho_{\mathfrak{E}}^n)} \right) + h \left(\frac{\text{Adv}_{\text{dist}}(\rho_{\mathfrak{E}}^n)}{2} \right), \end{aligned}$$

where (a) is an application of [41, Lemma 15]. For (b), we first observe that due to Lemma 19-2) and Definition 2-4), we have

$$\|\mathbb{E}_{\mathfrak{M}} \rho_{\mathfrak{E}}^n(\mathfrak{M}) - \rho_{\mathfrak{E}}^n(\tilde{m})\|_{\text{tr}} \leq \mathbb{E}_{\mathfrak{M}} \|\rho_{\mathfrak{E}}^n(\mathfrak{M}) - \rho_{\mathfrak{E}}^n(\tilde{m})\|_{\text{tr}} \leq \text{Adv}_{\text{dist}}(\rho_{\mathfrak{E}}^n) \leq 1.$$

The inequality in the first summand then follows from [41, Corollary 12], and in the second summand from the well-known fact that binary entropy is nondecreasing on $[0, 1/2]$. \square

It is not clear from Lemma 4 how $\text{Adv}_{\text{inf}}(\rho_{\mathbb{E}}^n)$ behaves for $n \rightarrow \infty$ since both $\rho_{\mathbb{E}}^n$ and the Gibbs observable G^n depend on n . In the following Lemmas 5 and 6, we derive a bound for $\text{Adv}_{\text{inf}}(\rho_{\mathbb{E}}^n)$ that depends on n only explicitly and via $\text{Adv}_{\text{dist}}(\rho_{\mathbb{E}}^n)$. To this end, we need a way to lift a Gibbs observable G on a Hilbert space \mathcal{H} to a Gibbs observable G^n on $\mathcal{H}^{\otimes n}$, and a relation between H_G and H_{G^n} . Let $(g_i)_{i \in \mathbb{N}}$ be the eigenvalues and $|e_i\rangle_{i \in \mathbb{N}}$ be the eigenvectors associated with G , i.e., G can be written as in (22) and (23). Then $(|e_{i_1}\rangle \otimes \cdots \otimes |e_{i_n}\rangle)_{i_1, \dots, i_n \in \mathbb{N}}$ is an orthonormal basis of $\mathcal{H}^{\otimes n}$ and the operator

$$G^n := G \otimes \mathbf{1} \otimes \cdots \otimes \mathbf{1} + \cdots + \mathbf{1} \otimes \cdots \otimes \mathbf{1} \otimes G \quad (28)$$

is well-defined on the set of (finite) linear combinations of $(|e_{i_1}\rangle \otimes \cdots \otimes |e_{i_n}\rangle)_{i_1, \dots, i_n \in \mathbb{N}}$. Moreover, for any $i_1, \dots, i_n \in \mathbb{N}$, we have

$$G^n |e_{i_1}\rangle \otimes \cdots \otimes |e_{i_n}\rangle = (g_{i_1} + \cdots + g_{i_n}) |e_{i_1}\rangle \otimes \cdots \otimes |e_{i_n}\rangle.$$

Then on the dense domain

$$\mathcal{D}(G^n) := \left\{ h \in \mathcal{H}^{\otimes n} : \sum_{i_1, \dots, i_n \in \mathbb{N}} |g_{i_1} + \cdots + g_{i_n}|^2 |\langle e_{i_1} \otimes \cdots \otimes e_{i_n}, h \rangle|^2 < \infty \right\}, \quad (29)$$

we can write

$$G^n |h\rangle = \sum_{i_1, \dots, i_n \in \mathbb{N}} (g_{i_1} + \cdots + g_{i_n}) \langle e_{i_1} \otimes \cdots \otimes e_{i_n}, h \rangle |e_{i_1}\rangle \otimes \cdots \otimes |e_{i_n}\rangle. \quad (30)$$

It is easily shown using [31, Theorem VIII.3 (c)] that (29) and (30) define a self-adjoint operator on $\mathcal{H}^{\otimes n}$. Additionally, for any $\beta \in (0, \infty)$, we have

$$\begin{aligned} \text{tr}(\exp(-\beta G^n)) &= \sum_{i_1, \dots, i_n \in \mathbb{N}} \langle e_{i_1} \otimes \cdots \otimes e_{i_n}, \exp(-\beta G^n) e_{i_1} \otimes \cdots \otimes e_{i_n} \rangle \\ &= \sum_{i_1, \dots, i_n \in \mathbb{N}} \exp(-\beta(g_{i_1} + \cdots + g_{i_n})) \\ &\stackrel{(a)}{=} \left(\sum_{i \in \mathbb{N}} \exp(-\beta g_i) \right)^n \\ &< \infty, \end{aligned}$$

where (a) is due to the theorem of Fubini-Tonelli applied to the n -fold product of the counting measure on \mathbb{N} . Therefore,

$$\exp(-\beta G^n) \in \mathcal{T}(\mathcal{H}^{\otimes n}), \quad (31)$$

for all $\beta \in (0, \infty)$. Consequently, (29), (30), and (31) show that G^n is a Gibbs observable on $\mathcal{H}^{\otimes n}$.

Lemma 5. *Let G be a Gibbs observable on \mathcal{H} , and let G^n be the corresponding Gibbs observable on $\mathcal{H}^{\otimes n}$ given by (28) – (30). Let $E \in [0, \infty)$. Then*

$$H_{G^n}(E) = nH_G\left(\frac{E}{n}\right).$$

Proof. Let $\rho \in \mathcal{S}(\mathcal{H}^{\otimes n})$ be the quantum state which attains the supremum in the definition of $H_{G^n}(E)$ (cf. [42, Proposition 1]) analog to (26), i.e., $\text{tr}(\rho G^n) \leq E$ and $H(\rho) = H_{G^n}(E)$. Further, use ρ_1, \dots, ρ_n to denote the marginal states of ρ on the factors of $\mathcal{H}^{\otimes n}$. We have

$$\text{tr}(\rho G^n) = \text{tr}(\rho(G \otimes \mathbf{1} \otimes \cdots \otimes \mathbf{1})) + \cdots + \text{tr}(\rho(\mathbf{1} \otimes \cdots \otimes \mathbf{1} \otimes G)) = \text{tr}(\rho_1 G) + \cdots + \text{tr}(\rho_n G). \quad (32)$$

By sub-additivity of von Neumann entropy, we have

$$H(\rho) \leq H(\rho_1) + \cdots + H(\rho_n) \leq H_G(E_1) + \cdots + H_G(E_n), \quad (33)$$

where we defined $E_i := \text{tr}(\rho_i G)$ for $i \in \{1, \dots, n\}$. On the other hand, for states σ_i , $i \in \{1, \dots, n\}$, with

$$H(\sigma_i) = H_G(E_i)$$

we define

$$\tilde{\sigma} := \sigma_1 \otimes \cdots \otimes \sigma_n.$$

Then

$$\text{tr}(\tilde{\sigma} G^n) \leq E$$

by a calculation similar to (32), and by additivity of von Neumann entropy on product states we obtain

$$H_G(E_1) + \cdots + H_G(E_n) = H(\sigma_1) + \cdots + H(\sigma_n) = H(\tilde{\sigma}) \leq H_{G^n}(E) = H(\rho). \quad (34)$$

From (33) and (34) we arrive at

$$H_{G^n}(E) = H(\rho) = H(\rho_1) + \cdots + H(\rho_n) = H_G(E_1) + \cdots + H_G(E_n). \quad (35)$$

From (32), it is clear that $E \geq E_1 + \cdots + E_n$. Let $E'_1, \dots, E'_n \in [0, \infty)$ be such that $E'_1 + \cdots + E'_n \leq E$, but otherwise arbitrary. By choosing states ρ'_1, \dots, ρ'_n with $\text{tr}(\rho'_i G) \leq E'_i$ and $H(\rho'_i) = H_G(E'_i)$, we can argue

$$H_G(E'_1) + \cdots + H_G(E'_n) = H(\rho'_1) + \cdots + H(\rho'_n) = H(\rho'_1 \otimes \cdots \otimes \rho'_n) \stackrel{(a)}{\leq} H_{G^n}(E'_1 + \cdots + E'_n) \stackrel{(b)}{\leq} H_{G^n}(E),$$

where (a) follows from a calculation similar to (32) and the definition (26), and (b) is by monotonicity of H_{G^n} . By (35), these inequalities hold with equality in case $E_1 = E'_1, \dots, E_n = E'_n$, so we have

$$H_G(E_1) + \cdots + H_G(E_n) = \max \left\{ H_G(E'_1) + \cdots + H_G(E'_n) : E'_1, \dots, E'_n \in [0, \infty), E'_1 + \cdots + E'_n \leq E \right\}.$$

Moreover, we have for any such choice of E'_1, \dots, E'_n

$$nH_G\left(\frac{E}{n}\right) \stackrel{(a)}{\geq} nH_G\left(\sum_{i=1}^n \frac{1}{n} E'_i\right) \stackrel{(b)}{\geq} n \sum_{i=1}^n \frac{1}{n} H_G(E'_i) = H_G(E'_1) + \cdots + H_G(E'_n), \quad (36)$$

where (a) is again by monotonicity and (b) follows from the fact that H_G is a concave function [42, Proposition 1-iii]. Due to the strict monotonicity (it is shown in [42, Proposition 1-ii]) that the derivative is strictly positive) and strict concavity of H_G [42, Proposition 1-iii], these inequalities clearly both hold with equality iff $E'_1 = \cdots = E'_n = E/n$, and since we know that E_1, \dots, E_n maximize the right-hand side of (36), we get $E_1 = \cdots = E_n = E/n$. Substituting this in (35) proves the lemma. \square

Lemma 6. *Let $\rho_{\mathfrak{E}}^n$ be as defined in (15). Assume that for all $x \in \mathcal{X}$, we have $\text{tr}(D_{\mathfrak{E}}(x)G) \leq E$, where G is a Gibbs observable on $\mathcal{H}_{\mathfrak{E}}$. Suppose further that $\text{Adv}_{\text{dist}}(\rho_{\mathfrak{E}}^n) \leq 1$. Then*

$$\text{Adv}_{\text{inf}}(\rho_{\mathfrak{E}}^n) \leq n \text{Adv}_{\text{dist}}(\rho_{\mathfrak{E}}^n) H_G\left(\frac{2E}{\text{Adv}_{\text{dist}}(\rho_{\mathfrak{E}}^n)}\right) + h\left(\frac{\text{Adv}_{\text{dist}}(\rho_{\mathfrak{E}}^n)}{2}\right).$$

Proof. Let G^n be given in (28) – (30). We have, for every $x^n \in \mathcal{X}^n$,

$$\text{tr}(D_{\mathfrak{E}}^n(x^n)G^n) = \text{tr}(D_{\mathfrak{E}}(x_1)G) + \cdots + \text{tr}(D_{\mathfrak{E}}(x_n)G) \leq nE. \quad (37)$$

Note that for each $i \in \{1, \dots, n\}$, the function $\text{tr}(D_{\mathfrak{E}}(x_i)G)$ is measurable due to representation as a series of measurable functions given in (25). Therefore, $\text{tr}(D_{\mathfrak{E}}^n(x^n)G^n)$ is a measurable and bounded function. Thus, using the representation (30) of G^n , we obtain, for every m ,

$$\begin{aligned} \text{tr}(\rho_{\mathfrak{E}}^n(m)G^n) &= \text{tr}\left(\int D_{\mathfrak{E}}^n(x^n)\text{Enc}(dx^n, m)G^n\right) \\ &\stackrel{(25)}{=} \sum_{i_1, \dots, i_n \in \mathbb{N}} (g_{i_1} + \cdots + g_{i_n}) \left\langle \int D_{\mathfrak{E}}^n(x^n)\text{Enc}(dx^n, m) e_{i_1} \otimes \cdots \otimes e_{i_n}, e_{i_1} \otimes \cdots \otimes e_{i_n} \right\rangle \\ &\stackrel{(a)}{=} \sum_{i_1, \dots, i_n \in \mathbb{N}} (g_{i_1} + \cdots + g_{i_n}) \int \langle D_{\mathfrak{E}}^n(x^n) e_{i_1} \otimes \cdots \otimes e_{i_n}, e_{i_1} \otimes \cdots \otimes e_{i_n} \rangle \text{Enc}(dx^n, m) \\ &\stackrel{(b)}{=} \int \sum_{i_1, \dots, i_n \in \mathbb{N}} (g_{i_1} + \cdots + g_{i_n}) \langle D_{\mathfrak{E}}^n(x^n) e_{i_1} \otimes \cdots \otimes e_{i_n}, e_{i_1} \otimes \cdots \otimes e_{i_n} \rangle \text{Enc}(dx^n, m) \\ &\stackrel{(25)}{=} \int \text{tr}(D_{\mathfrak{E}}^n(x^n)G^n)\text{Enc}(dx^n, m) \\ &\stackrel{(37)}{\leq} nE, \end{aligned}$$

where (a) is by Lemma 19-3) and (b) is by the monotone convergence theorem. Therefore, we can apply Lemmas 4 and 5 and obtain

$$\begin{aligned} \text{Adv}_{\text{inf}}(\rho_{\mathfrak{E}}^n) &\leq \text{Adv}_{\text{dist}}(\rho_{\mathfrak{E}}^n) H_{G^n}\left(\frac{2nE}{\text{Adv}_{\text{dist}}(\rho_{\mathfrak{E}}^n)}\right) + h\left(\frac{\text{Adv}_{\text{dist}}(\rho_{\mathfrak{E}}^n)}{2}\right) \\ &= n \text{Adv}_{\text{dist}}(\rho_{\mathfrak{E}}^n) H_G\left(\frac{2E}{\text{Adv}_{\text{dist}}(\rho_{\mathfrak{E}}^n)}\right) + h\left(\frac{\text{Adv}_{\text{dist}}(\rho_{\mathfrak{E}}^n)}{2}\right), \end{aligned}$$

concluding the proof. \square

It is known [42, Proposition 1-ii]) that $\text{Adv}_{\text{dist}}(\rho_{\mathfrak{E}}^n)H_G(2E/\text{Adv}_{\text{dist}}(\rho_{\mathfrak{E}}^n))$ tends to 0 as $\text{Adv}_{\text{dist}}(\rho_{\mathfrak{E}}^n)$ tends to 0, and it is also clear that the binary entropy term vanishes in this case. However, in general, the presence of the extra factor n in the upper bound of Lemma 6 means that an additional argument is necessary to show that distinguishing security implies mutual information security. We do not have such an argument for the general case, but we show in the following lemma that the implication holds in important special cases. The first of these cases is that the eavesdropper's output is finite-dimensional. The other cases are infinite dimensional and assume the existence of Gibbs observables for the eavesdropper's output that are closely related to the Hamiltonian of harmonic oscillator of bounded energy. Therefore, they specialize to bosonic systems with either one or finitely many modes. In this case, the Hilbert space under consideration is $\mathcal{H}_{\mathfrak{E}} = L^2(\mathbb{R})$ and the Gibbs observable is given by

$$G := a^*a, \quad (38)$$

defined, for the moment, on the domain

$$\mathcal{D}(G) = \mathcal{S}(\mathbb{R}) \quad (39)$$

where a^* and a denote the creation resp. annihilation operators (cf. [35, Chapter 12.1]) defined on $\mathcal{S}(\mathbb{R})$ and where $\mathcal{S}(\mathbb{R})$ is the Schwartz space of rapidly decreasing functions which is dense in $L^2(\mathbb{R})$. It is well known that $G := a^*a$ is essentially self-adjoint on $\mathcal{D}(G)$ (cf. [43, Section 2.2.7, Example 4] from which the claim follows by a slight modification of the argument). The operator G is, up to additive scalar multiple of $\mathbf{1}$, the Hamiltonian of the quantum harmonic oscillator [35, Section 12.1.2]. Moreover, the operator G has discrete spectrum with spectral decomposition (cf. [43, Section 2.2.7, Example 4], [35, Chapter 12.1])

$$G = \sum_{i=0}^{\infty} i |e_i\rangle \langle e_i|, \quad (40)$$

where $|e_i\rangle_{i \in \mathbb{N}_0}$ is an orthonormal basis of $\mathcal{H}_{\mathfrak{E}} = L^2(\mathbb{R})$ consisting of so-called number state vectors. The final domain of the operator G is then given by

$$\bar{\mathcal{D}}(G) = \left\{ |h\rangle \in L^2(\mathbb{R}) : \sum_{i=0}^{\infty} i^2 |\langle e_i, h \rangle|^2 < \infty \right\}. \quad (41)$$

The operator G is self-adjoint on $\bar{\mathcal{D}}(G)$.

For the case of s modes, we similarly define the operator

$$G^{(s)} := \sum_{j=1}^s \mathbf{1}^{\otimes j-1} \otimes \omega_j G_j \otimes \mathbf{1}^{\otimes s-j}, \quad (42)$$

on $\mathcal{D}(G^{(s)}) := \mathcal{S}(\mathbb{R})^{\otimes s} \subseteq (L^2(\mathbb{R}))^{\otimes s}$, where $\omega_1, \dots, \omega_s \in (0, \infty)$ denote the frequencies of the modes and the operators G_1, \dots, G_s are given in (38) with the respective creation and annihilation operators of the modes. Using the spectral decomposition (40) for each of the modes, we obtain the spectral decomposition

$$G^{(s)} = \sum_{i_1, \dots, i_s=0}^{\infty} \left(\sum_{j=1}^s \omega_j i_j \right) |e_{1, i_1} \otimes \dots \otimes e_{s, i_s}\rangle \langle e_{1, i_1} \otimes \dots \otimes e_{s, i_s}|, \quad (43)$$

where $(e_{1, i_1} \otimes \dots \otimes e_{s, i_s})$ is the orthonormal basis of $(L^2(\mathbb{R}))^{\otimes s}$ composed of bases consisting of number state vectors of individual modes (40). Defining

$$\bar{\mathcal{D}}(G^{(s)}) := \left\{ |h\rangle \in (L^2(\mathbb{R}))^{\otimes s} : \sum_{i_1, \dots, i_s=0}^{\infty} \left(\sum_{j=1}^s \omega_j i_j \right)^2 |\langle e_{1, i_1} \otimes \dots \otimes e_{s, i_s}, h \rangle|^2 < \infty \right\}, \quad (44)$$

we note that the operator $G^{(s)}$ is self-adjoint on the dense domain $\bar{\mathcal{D}}(G^{(s)})$ [31, Theorem VIII.3 (c)].

In order to show that G and $G^{(s)}$ are Gibbs observables, it remains to verify that for all $\beta \in (0, \infty)$, we have

$$\exp(-\beta G) \in \mathcal{T}(L^2(\mathbb{R})) \quad \text{and} \quad \exp(-\beta G^{(s)}) \in \mathcal{T}((L^2(\mathbb{R}))^{\otimes s}), \quad (45)$$

which will be proven in the implications 3) and 4) of Lemma 7. An example of a c/qq wiretap channel for which G is a Gibbs observable is given in Section VI-A, and a general account and further examples of energy-constrained quantum channels can be found in [35, Chapter 12]. According to the following lemma, superlinear convergence of the distinguishing security level to 0 is sufficient to guarantee mutual information security in the finite-dimensional case. In the case that the eavesdropper's channel has energy constraints described by Gibbs observables of the form (38), (42), superquadratic convergence is a sufficient condition.

Therefore, mutual information security in these cases follows in particular from the exponential bounds on distinguishing security level that we obtain in this work.

Lemma 7. $(\rho_{\mathfrak{E}}^n)_{n \in \mathbb{N}}$ is mutual information secure if any of the following assumption holds:

- 1) $\dim \mathcal{H}_{\mathfrak{E}} = d < \infty$ and $n \text{Adv}_{\text{dist}}(\rho_{\mathfrak{E}}^n) \rightarrow 0$ as $n \rightarrow \infty$.
- 2) There exists a Gibbs observable G on $\mathcal{H}_{\mathfrak{E}}$ and $c_1, E \in [0, \infty)$ such that for all $\beta \in (0, \infty)$, we have $\log \text{tr} \exp(-\beta G) \leq c_1 \beta^{-1}$, and for all $x \in \mathcal{X}$, we have $\text{tr}(D_{\mathfrak{E}}(x)G) \leq E$. Moreover, there exist $c_2 \in (0, \infty), \alpha \in (2, \infty)$ with $\text{Adv}_{\text{dist}}(\rho_{\mathfrak{E}}^n) \leq c_2 n^{-\alpha}$.
- 3) There is a Gibbs observable $G := \sum_{i=0}^{\infty} i |e_i\rangle \langle e_i|$ on $\mathcal{H}_{\mathfrak{E}}$, where $|e_i\rangle_{i=0}^{\infty}$ is an orthonormal basis of $\mathcal{H}_{\mathfrak{E}}$. Moreover, there is $E \in (0, \infty)$ such that for all $x \in \mathcal{X}$, we have $\text{tr}(D_{\mathfrak{E}}(x)G) \leq E$, and there are $c \in (0, \infty), \alpha \in (2, \infty)$ with $\text{Adv}_{\text{dist}}(\rho_{\mathfrak{E}}^n) \leq cn^{-\alpha}$.
- 4) We have $\mathcal{H}_{\mathfrak{E}} = \mathcal{H}^{\otimes s}$ and a Gibbs observable $G := \sum_{j=1}^s \mathbf{1}^{\otimes j-1} \otimes \omega_j G_j \otimes \mathbf{1}^{\otimes s-j}$, where each G_j is a Gibbs observable on \mathcal{H} of the same form as in 3) and each $\omega_j \in (0, \infty)$. We assume further that there is $E \in (0, \infty)$ such that for all $x \in \mathcal{X}$, we have $\text{tr}(D_{\mathfrak{E}}(x)G) \leq E$, and there are $c \in (0, \infty), \alpha \in (2, \infty)$ with $\text{Adv}_{\text{dist}}(\rho_{\mathfrak{E}}^n) \leq cn^{-\alpha}$.

Proof. We first prove the lemma for case 1). In this case, the proof proceeds in parallel to Lemma 4. We fix an arbitrary probability distribution $P_{\mathfrak{M}}$ on $\{1, \dots, M\}$ and define \tilde{m} as in (27). With this, we obtain, for sufficiently large n ,

$$\begin{aligned} \chi(P_{\mathfrak{M}}; \rho_{\mathfrak{E}}^n) &= H(\mathbb{E}_{\mathfrak{M}} \rho_{\mathfrak{E}}^n(m)) - \mathbb{E}_{\mathfrak{M}} H(\rho_{\mathfrak{E}}^n(\mathfrak{M})) \\ &\stackrel{(27)}{\leq} H(\mathbb{E}_{\mathfrak{M}} \rho_{\mathfrak{E}}^n(m)) - H(\rho_{\mathfrak{E}}^n(\tilde{m})) \\ &\stackrel{(a)}{\leq} \|\mathbb{E}_{\mathfrak{M}} \rho_{\mathfrak{E}}^n(m) - \rho_{\mathfrak{E}}^n(\tilde{m})\|_{\text{tr}} n \log d + h\left(\frac{\|\mathbb{E}_{\mathfrak{M}} \rho_{\mathfrak{E}}^n(m) - \rho_{\mathfrak{E}}^n(\tilde{m})\|_{\text{tr}}}{2}\right) \\ &\stackrel{(b)}{\leq} \text{Adv}_{\text{dist}}(\rho_{\mathfrak{E}}^n) n \log d + h\left(\frac{\text{Adv}_{\text{dist}}(\rho_{\mathfrak{E}}^n)}{2}\right), \end{aligned}$$

where (a) is due to the universal bound of [41, Lemma 1] (note that $\dim \mathcal{H}_{\mathfrak{E}}^{\otimes n} = d^n$) and (b) holds for n large enough so that $\text{Adv}_{\text{dist}}(\rho_{\mathfrak{E}}^n) \leq 1$. Clearly, this bound vanishes as $n \text{Adv}_{\text{dist}}(\rho_{\mathfrak{E}}^n)$ vanishes.

Next, we prove the lemma for case 2). We have

$$\begin{aligned} n \text{Adv}_{\text{dist}}(\rho_{\mathfrak{E}}^n) H_G\left(\frac{2E}{\text{Adv}_{\text{dist}}(\rho_{\mathfrak{E}}^n)}\right) &\stackrel{(a)}{=} n \text{Adv}_{\text{dist}}(\rho_{\mathfrak{E}}^n) \inf_{\beta \in (0, \infty)} \left(\beta \frac{2E}{\text{Adv}_{\text{dist}}(\rho_{\mathfrak{E}}^n)} + \log \text{tr} \exp(-\beta G)\right) \\ &\stackrel{(b)}{\leq} n \text{Adv}_{\text{dist}}(\rho_{\mathfrak{E}}^n) \inf_{\beta \in (0, \infty)} \left(\beta \frac{2E}{\text{Adv}_{\text{dist}}(\rho_{\mathfrak{E}}^n)} + \frac{c_1}{\beta}\right) \\ &\stackrel{(c)}{\leq} 2En^{1-\alpha'} + c_1 \text{Adv}_{\text{dist}}(\rho_{\mathfrak{E}}^n) n^{1+\alpha'} \\ &\stackrel{(d)}{\leq} 2En^{1-\alpha'} + c_1 c_2 n^{1+\alpha'-\alpha}, \end{aligned} \tag{46}$$

where (a) uses the variational representation of the function H_G [42, Proposition 1-3]), (b) follows from the assumption $\log \text{tr} \exp(-\beta G) \leq c_1 \beta^{-1}$, (c) follows by upper bounding the infimum with the choices $\beta := n^{-\alpha'}$ and $\alpha' \in (1, \alpha - 1)$, and in (d) we have substituted the upper bound for $\text{Adv}_{\text{dist}}(\rho_{\mathfrak{E}}^n)$ from the lemma statement. The obtained upper bound vanishes, and thus mutual information security follows from Lemma 6 and the fact that binary entropy vanishes at 0.

The remaining two cases are special cases of 2). For 3), we note that with G as defined in this case, we have for $\beta \in (0, \infty)$

$$\begin{aligned} \log \text{tr} \exp(-\beta G) &= \log \sum_{i=0}^{\infty} \exp(-\beta i) \\ &\stackrel{(a)}{=} -\log(1 - \exp(-\beta)) \\ &\stackrel{(b)}{\leq} -\left(1 - \frac{1}{1 - \exp(-\beta)}\right) \\ &= \frac{1}{\exp(\beta) - 1} \\ &\stackrel{(c)}{\leq} \frac{1}{\beta}, \end{aligned} \tag{47}$$

where (a) is the known convergence behavior of the geometric series, (b) is due to the inequality $\forall t \in (0, \infty) \log(t) \geq 1 - 1/t$, and (c) is due to the inequality $\forall t \in \mathbb{R} \exp(t) \geq t + 1$. Thus, the assumption of case 2) is satisfied.

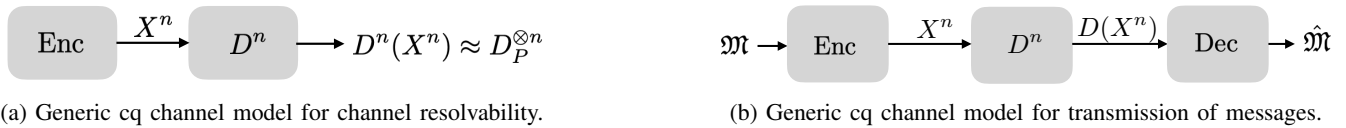

Fig. 2: Point-to-point cq channel models considered in Section IV.

For case 4), we fix suitable orthonormal bases $|e_{1,i}\rangle_{i=0}^\infty, \dots, |e_{s,i}\rangle_{i=0}^\infty$ of \mathcal{H} such that

$$\begin{aligned} G &= \sum_{j=1}^s \sum_{i_1, \dots, i_s=0}^\infty \omega_j i_j |e_{1,i_1} \otimes \dots \otimes e_{s,i_s}\rangle \langle e_{1,i_1} \otimes \dots \otimes e_{s,i_s}| \\ &= \sum_{i_1, \dots, i_s=0}^\infty \left(\sum_{j=1}^s \omega_j i_j \right) |e_{1,i_1} \otimes \dots \otimes e_{s,i_s}\rangle \langle e_{1,i_1} \otimes \dots \otimes e_{s,i_s}|. \end{aligned}$$

It suffices to show $\log \text{tr} \exp(-\beta G) = \beta^{-1}(\omega_1^{-1} + \dots + \omega_s^{-1})$, which we do by induction on s . For $s = 1$, this reduces to (47). For $s > 1$, we calculate

$$\begin{aligned} \log \text{tr} \exp(-\beta G) &= \log \sum_{i_1, \dots, i_s=0}^\infty \exp\left(-\beta \sum_{j=1}^s \omega_j i_j\right) \\ &= \log \sum_{i_1, \dots, i_s=0}^\infty \exp\left(-\beta \sum_{j=1}^{s-1} \omega_j i_j\right) \exp(-\beta \omega_s i_s) \\ &= \log \sum_{i_1, \dots, i_{s-1}=0}^\infty \exp\left(-\beta \sum_{j=1}^{s-1} \omega_j i_j\right) + \log \sum_{i_s=0}^\infty \exp(-\beta \omega_s i_s) \\ &\stackrel{(47)}{\leq} \frac{1}{\omega_s \beta} + \log \sum_{i_1, \dots, i_{s-1}=0}^\infty \exp\left(-\beta \sum_{j=1}^{s-1} \omega_j i_j\right) \\ &\stackrel{(a)}{\leq} \beta^{-1}(\omega_1^{-1} + \dots + \omega_s^{-1}), \end{aligned}$$

where the induction hypothesis is used in step (a). □

Observing the trivial inequalities

$$\text{Adv}_{\text{weak}}(\rho_{\mathcal{E}}^n) \leq \text{Adv}_{\text{str}}(\rho_{\mathcal{E}}^n) \leq \text{Adv}_{\text{inf}}(\rho_{\mathcal{E}}^n),$$

the preceding lemmas imply the following equivalences and implications for the asymptotic notions about sequences of codes in parallel to the classical case [38, Figure 2]

$$\text{semantically secure} \Leftrightarrow \text{distinction secure} \Leftrightarrow \text{mutual information secure} \Rightarrow \text{strongly secure} \Rightarrow \text{weakly secure}.$$

It should be noted that Lemma 7 shows

$$\text{distinction secure} \Rightarrow \text{mutual information secure}$$

only under additional assumptions which capture, however, some practically important cases. But even in the general case, both mutual information secure and distinction secure sequences of codes are also semantically secure in the sense we define it in this paper.

IV. CQ CHANNEL RESOLVABILITY AND CODING

An important prerequisite in proving achievability of rates for the wiretap channel will be results of achievability for the channel resolvability problem, depicted in Fig. 2a, and the channel coding problem, depicted in Fig. 2b.

Here, we just consider a point-to-point cq channel described by a measurable map $D : \mathcal{X} \rightarrow \mathcal{S}(\mathcal{H})$ with some separable Hilbert space \mathcal{H} . We focus on two different problems: In *channel resolvability*, the question will be which transmit strategies (i.e., rules for generating X^n) the transmitter can employ to approximate the output state $D_P^{\otimes n}$ by $D^n(X^n)$ at the receiver. In *channel coding*, the task is to encode a given message for transmission through the channel in such a way that the receiver can with high probability decode the message. In the proof of Theorems 1 and 2, the security criterion can then be shown by applying the resolvability result to the channel $D = D_{\mathcal{E}}$, and for the case of a quantum output at the legitimate receiver, the

average decoding error criterion can be shown by applying the channel coding result to the channel $D = D_{\mathfrak{B}}$ (for the case of classical output at \mathfrak{B} , we cite a classical channel coding result which is used instead).

In the solution to both of these problems, we use the same standard random codebook construction: The random codebook \mathcal{C} of block length n and size M is of the form $\mathcal{C} := (\mathcal{C}(m))_{m=1}^M$ where the codewords $\mathcal{C}(m)$ are vectors with entries from \mathcal{X} and length n where all entries across all codewords are i.i.d. and follow the distribution P .

Both theorems stated in this section use the technical assumption that there is some $\alpha_{\min} \in (0, 1)$ such that:

$$\begin{aligned} D_P^{\alpha_{\min}} &\in \mathcal{T}(\mathcal{H}), \\ \text{for } P\text{-almost all } x &: D(x)^{\alpha_{\min}} \in \mathcal{T}(\mathcal{H}), \\ \text{the Bochner integral } \mathbb{E}(D(X)^{\alpha_{\min}}) &\in \mathcal{T}(\mathcal{H}) \text{ exists.} \end{aligned} \tag{48}$$

It is an immediate consequence of Lemmas 20 and 21 that $\chi(P; D) < \infty$ whenever (48) holds, and we will implicitly use this fact in the following.

For channel resolvability, each fixed realization of \mathcal{C} defines an induced channel output density

$$D_{\mathcal{C}} := \frac{1}{M} \sum_{m=1}^M D^n(\mathcal{C}(m)) \tag{49}$$

which results if the transmitter chooses a codeword for transmission through the channel uniformly at random. With these definitions, we now have the necessary terminology to state our resolvability and coding results. The proofs are deferred to Sections V-B and V-C, and in Sections V-D and V-E, we analyze the concentration behavior of the errors and extend both results to the case of cost-constrained channel inputs.

Theorem 3. *Let $R > \chi(P; D)$, and suppose $M \geq \exp(nR)$. Moreover, assume that (48) holds.*

Then, there is $\gamma \in (0, \infty)$ such that for sufficiently large n ,

$$\mathbb{E}_{\mathcal{C}} \|D_{\mathcal{C}} - D_P^{\otimes n}\|_{\text{tr}} \leq \exp(-n\gamma).$$

For channel coding, given a fixed codebook \mathcal{C} , the transmitter chooses the codeword $\mathcal{C}(\mathfrak{M})$ to encode a message \mathfrak{M} .

Theorem 4. *Let $R < \chi(P; D)$, and suppose $M \leq \exp(nR)$. Moreover, assume that (48) holds.*

Then, for each \mathcal{C} , there is a decoding POVM $(Y_m)_{m=1}^M$ such that every Y_m is measurable as a function of \mathcal{C} , and there is $\gamma \in (0, \infty)$ such that for sufficiently large n ,

$$\mathbb{E}_{\mathcal{C}} \frac{1}{M} \sum_{m=1}^M \text{tr}(D^n(m)(\mathbf{1} - Y_m)) \leq \exp(-n\gamma).$$

V. PROOFS

In this section, we prove the theorems which are stated in the preceding sections. In Section V-A, we introduce notions of typicality and prove two lemmas around typicality that will be needed both for the resolvability and coding results. We then proceed to proving Theorem 3 on resolvability in Section V-B and Theorem 4 on coding in Section V-C. In Section V-D, we show that the error terms are very tightly concentrated around their expectations. Extensions that incorporate an additive input cost constraint can be found in Section V-E. Finally, everything is put together in Section V-F where Theorem 1 and Theorem 2 on coding for the wiretap channel are proved.

A. Prerequisites on Typicality

In this section, we introduce typicality notions and related technical lemmas that are used in the proofs of Theorems 3 and 4. For every $x \in \mathcal{X}$, we fix a spectral decomposition

$$D(x) = \sum_{y \in \mathbb{N}} P(y|x) |e_{y|x}\rangle \langle e_{y|x}|,$$

where $\{|e_{y|x}\rangle\}_{y \in \mathbb{N}}$ is an orthonormal basis of \mathcal{H} for every $x \in \mathcal{X}$. By Lemma 18-1), for every $\mathcal{Y} \subseteq \mathbb{N}$, the map $x \mapsto \sum_{y \in \mathcal{Y}} P(y|x)$ is a pointwise limit of measurable maps and therefore measurable. Moreover, for all x , we have $\sum_{y \in \mathbb{N}} P(y|x) = \text{tr} D(x) = 1$. Therefore, the eigenvalues $P(y|x)$ induce a stochastic kernel from \mathcal{X} to \mathbb{N} , and together with a probability distribution P on \mathcal{X} , we obtain a joint probability distribution on $\mathcal{X} \times \mathbb{N}$. In a slight abuse of notation, we will use the symbol P to denote this joint probability distribution as well as the marginal on \mathbb{N} and all corresponding p.m.f.s. Let $(\Omega, \mathcal{F}, \mu)$ be a probability space and $X : \Omega \rightarrow \mathcal{X}$ be a random variable distributed according to P . We write the density operator of the channel output in terms of its spectral decomposition

$$D_P := \mathbb{E}_X D(X) = \sum_{y \in \mathbb{N}} U(y) |e_y\rangle \langle e_y|.$$

Clearly, U is a p.m.f. on \mathbb{N} which we identify with the probability measure it induces. We define the entropies

$$H_P := - \sum_{x \in \mathcal{X}} \sum_{y \in \mathbb{N}} P(x, y) \log P(y|x) = -\mathbb{E}_X \sum_{y \in \mathbb{N}} P(y|X) \log P(y|X) = -\mathbb{E}_X \text{tr}(D(X) \log D(X)) = \mathbb{E}_X H(D(X)), \quad (50)$$

$$H_U := - \sum_{y \in \mathbb{N}} U(y) \log U(y) = -\text{tr}(D_P \log D_P) = H(D_P). \quad (51)$$

If $\chi(P; D) < \infty$, then H_P and H_U are both finite, and we have

$$\chi(P; D) = -H_P + H_U. \quad (52)$$

For n -fold uses of the channel D , we note that via the definitions

$$\begin{aligned} e_{y^n | x^n} &:= \bigotimes_{i=1}^n e_{y_i | x_i} \\ e_{y^n} &:= \bigotimes_{i=1}^n e_{y_i} \\ P(x^n) &:= \prod_{i=1}^n P(x_i) \\ P(y^n | x^n) &:= \prod_{i=1}^n P(y_i | x_i) \\ U(y^n) &:= \prod_{i=1}^n U(y_i), \end{aligned}$$

we identify P and U with corresponding distributions on $\mathcal{X}^n \times \mathbb{N}^n$ (and the resulting marginals) and \mathbb{N}^n , and we have

$$D^n(x^n) = \sum_{y^n \in \mathbb{N}^n} P(y^n | x^n) |e_{y^n | x^n}\rangle \langle e_{y^n | x^n}|, \quad (53)$$

$$D_P^{\otimes n} = \sum_{y^n \in \mathbb{N}^n} U(y^n) |e_{y^n}\rangle \langle e_{y^n}|. \quad (54)$$

For any $\varepsilon \in (0, \infty)$, we define

$$\begin{aligned} \mathcal{P}_{\varepsilon, n} &:= \{(x^n, y^n) \in \mathcal{X}^n \times \mathbb{N}^n : n(H_P - \varepsilon) < -\log P(y^n | x^n) < n(H_P + \varepsilon)\} \\ \mathcal{U}_{\varepsilon, n} &:= \{y^n \in \mathbb{N}^n : n(H_U - \varepsilon) < -\log U(y^n) < n(H_U + \varepsilon)\} \end{aligned}$$

and, based on these definitions,

$$\Psi_{\varepsilon, n}(x^n) := \sum_{y^n \in \mathbb{N}^n} \mathbb{1}_{\mathcal{P}_{\varepsilon, n}}(x^n, y^n) |e_{y^n | x^n}\rangle \langle e_{y^n | x^n}| \quad (55)$$

$$\Theta_{\varepsilon, n} := \sum_{y^n \in \mathbb{N}^n} \mathbb{1}_{\mathcal{U}_{\varepsilon, n}}(y^n) |e_{y^n}\rangle \langle e_{y^n}|. \quad (56)$$

While $\Theta_{\varepsilon, n}$ is a fixed operator, $\Psi_{\varepsilon, n}$ is an operator-valued function and its measurability is not immediately clear from the definition. Therefore, we note that it can also be written as

$$\Psi_{\varepsilon, n}(x^n) = \mathbb{1}_{(\exp(-n(H_P + \varepsilon)), \exp(-n(H_P - \varepsilon)))}(D^n(x^n))$$

and is therefore a measurable map $\mathcal{X}^n \rightarrow \mathcal{T}(\mathcal{H}^{\otimes n})$ by Lemma 18-2). We also note the following basic properties of these projections which are straightforward to verify from their definitions:

$$\Theta_{\varepsilon, n}^2 = \Theta_{\varepsilon, n}, \quad \Psi_{\varepsilon, n}(x^n)^2 = \Psi_{\varepsilon, n}(x^n), \quad D^n(x^n)\Psi_{\varepsilon, n}(x^n) = \Psi_{\varepsilon, n}(x^n)D^n(x^n). \quad (57)$$

Finally, define

$$\Gamma_{\varepsilon, n} : \mathcal{X}^n \rightarrow \mathcal{T}(\mathcal{H}^{\otimes n}), \quad x^n \mapsto \Theta_{\varepsilon, n}\Psi_{\varepsilon, n}(x^n) \quad (58)$$

$$\Phi_{\varepsilon, n} : \mathcal{X}^n \rightarrow \mathcal{T}(\mathcal{H}^{\otimes n}), \quad x^n \mapsto \Theta_{\varepsilon, n}\Psi_{\varepsilon, n}(x^n)\Theta_{\varepsilon, n}. \quad (59)$$

which clearly are also measurable.

These notions of typicality will allow us to split the error terms that appear in the proofs of Theorems 3 and 4 into a typical and an atypical part. These terms can be bounded separately with the help of the next two lemmas.

Lemma 8. (Bound for typical terms). *We have*

- 1) $\forall x^n \in \mathcal{X}^n \quad \Psi_{\varepsilon,n}(x^n)D^n(x^n)\Psi_{\varepsilon,n}(x^n) \leq \exp(-n(H_P - \varepsilon))\Psi_{\varepsilon,n}(x^n)$
- 2) $\forall x^n \in \mathcal{X}^n \quad \text{tr}\Psi_{\varepsilon,n}(x^n) < \exp(n(H_P + \varepsilon))$.
- 3) $\Theta_{\varepsilon,n}D_P^{\otimes n}\Theta_{\varepsilon,n} \leq \exp(-n(H_U - \varepsilon))\Theta_{\varepsilon,n}$
- 4) $\text{tr}\Theta_{\varepsilon,n} < \exp(n(H_U + \varepsilon))$.

Proof. For 1), we use the presence of the indicator in the definition of $\Psi_{\varepsilon,n}(x^n)$ to bound

$$\begin{aligned} \Psi_{\varepsilon,n}(x^n)D^n(x^n)\Psi_{\varepsilon,n}(x^n) &= \sum_{y^n \in \mathbb{N}^n} \mathbb{1}_{\mathcal{P}_{\varepsilon,n}}(x^n, y^n)P(y^n|x^n)|e_{y^n|x^n}\rangle\langle e_{y^n|x^n}| \\ &\leq \sum_{y^n \in \mathbb{N}^n} \mathbb{1}_{\mathcal{P}_{\varepsilon,n}}(x^n, y^n) \exp(-n(H_P - \varepsilon))|e_{y^n|x^n}\rangle\langle e_{y^n|x^n}| \\ &= \exp(-n(H_P - \varepsilon))\Psi_{\varepsilon,n}(x^n). \end{aligned}$$

For 2), we fix some x^n and note

$$\text{tr}\Psi_{\varepsilon,n}(x^n) = \text{tr} \sum_{y^n \in \mathbb{N}^n} \mathbb{1}_{\mathcal{P}_{\varepsilon,n}}(x^n, y^n)|e_{y^n|x^n}\rangle\langle e_{y^n|x^n}| = |\{y^n : (x^n, y^n) \in \mathcal{P}_{\varepsilon,n}\}|. \quad (60)$$

For every $(x^n, y^n) \in \mathcal{P}_{\varepsilon,n}$, we have

$$P(y^n|x^n) > \exp(-n(H_P + \varepsilon)).$$

This allows us to argue

$$1 \geq \sum_{y^n: (x^n, y^n) \in \mathcal{P}_{\varepsilon,n}} P(y^n|x^n) > \sum_{y^n: (x^n, y^n) \in \mathcal{P}_{\varepsilon,n}} \exp(-n(H_P + \varepsilon)) = |\{y^n : (x^n, y^n) \in \mathcal{P}_{\varepsilon,n}\}| \exp(-n(H_P + \varepsilon)),$$

from which item 2) follows by (60).

For 3), we have a calculation very similar to the one for 1)

$$\begin{aligned} \Theta_{\varepsilon,n}D_P^{\otimes n}\Theta_{\varepsilon,n} &= \sum_{y^n \in \mathbb{N}^n} \mathbb{1}_{\mathcal{U}_{\varepsilon,n}}(y^n)U(y^n)|e_{y^n}\rangle\langle e_{y^n}| \\ &\leq \sum_{y^n \in \mathbb{N}^n} \mathbb{1}_{\mathcal{U}_{\varepsilon,n}}(y^n) \exp(-n(H_U - \varepsilon))|e_{y^n}\rangle\langle e_{y^n}| \\ &= \exp(-n(H_U - \varepsilon))\Theta_{\varepsilon,n}. \end{aligned}$$

For 4), the argument is very similar to the one for 2). We note

$$\text{tr}\Theta_{\varepsilon,n} = \text{tr} \sum_{y^n \in \mathcal{U}_{\varepsilon,n}} |e_{y^n}\rangle\langle e_{y^n}| = |\mathcal{U}_{\varepsilon,n}|. \quad (61)$$

For every $y^n \in \mathcal{U}_{\varepsilon,n}$, we have

$$U(y^n) > \exp(-n(H_U + \varepsilon)).$$

This allows us to argue

$$1 \geq U(y^n \in \mathcal{U}_{\varepsilon,n}) = \sum_{y^n \in \mathcal{U}_{\varepsilon,n}} U(y^n) > \sum_{y^n \in \mathcal{U}_{\varepsilon,n}} \exp(-n(H_U + \varepsilon)) = |\mathcal{U}_{\varepsilon,n}| \exp(-n(H_U + \varepsilon)),$$

from which item 4) follows by (61). \square

The next lemma requires some preliminaries on Rényi entropy. To this end, we define for $\alpha \in [\alpha_{\min}, 1) \cup (1, \infty)$

$$H_{P,\alpha} := \frac{1}{1-\alpha} \log \mathbb{E}_P (P(Y|X)^{\alpha-1}) = \frac{1}{1-\alpha} \log \mathbb{E}_P \sum_{y \in \mathbb{N}} P(y|X)^\alpha = \frac{1}{1-\alpha} \log \mathbb{E}_P \text{tr}(D(X)^\alpha) \quad (62)$$

$$H_{U,\alpha} := \frac{1}{1-\alpha} \log \mathbb{E}_U (U(Y)^{\alpha-1}) = \frac{1}{1-\alpha} \log \sum_{y \in \mathbb{N}} U(y)^\alpha = \frac{1}{1-\alpha} \log \text{tr}(D_P^\alpha). \quad (63)$$

We will use properties of $H_{P,\alpha}$ and $H_{U,\alpha}$ which are stated and proved in Lemmas 20 and 21 of the appendix. Lemma 21 allows us to expand the definitions of $H_{U,\alpha}$ and $H_{P,\alpha}$ to the domain $[\alpha_{\min}, \infty)$ and obtain continuous functions in α with $H_{U,1} = H_U$ and $H_{P,1} = H_P$.

Lemma 9. (Bound for atypical terms). *There is $\gamma_1 \in (0, \infty)$ such that for sufficiently large n ,*

$$\mathbb{E} \text{tr}(D^n(X^n)\Gamma_{\varepsilon,n}(X^n)^*) \geq 1 - \exp(-n\gamma_1) \quad (64)$$

$$\mathbb{E} \text{tr}(D^n(X^n)\Phi_{\varepsilon,n}(X^n)) \geq 1 - \exp(-n\gamma_1), \quad (65)$$

where $\Gamma_{\varepsilon,n}$ is defined in (58) and $\Phi_{\varepsilon,n}$ is defined in (59).

Proof. We bound the trace in (64) as

$$\begin{aligned}
\mathrm{tr}(D^n(X^n)\Gamma_{\varepsilon,n}(X^n)^*) &\stackrel{(58)}{=} \mathrm{tr}(D^n(X^n)\Psi_{\varepsilon,n}(X^n)\Theta_{\varepsilon,n}) \\
&= \mathrm{tr}(D^n(X^n)\Psi_{\varepsilon,n}(X^n)) - \mathrm{tr}(D^n(X^n)\Psi_{\varepsilon,n}(X^n)(1 - \Theta_{\varepsilon,n})) \\
&\stackrel{(a)}{=} \mathrm{tr}(D^n(X^n)\Psi_{\varepsilon,n}(X^n)) - \mathrm{tr}\left((1 - \Theta_{\varepsilon,n})\sqrt{D^n(X^n)}\Psi_{\varepsilon,n}(X^n)\sqrt{D^n(X^n)}(1 - \Theta_{\varepsilon,n})\right) \\
&\stackrel{(b)}{\geq} \mathrm{tr}(D^n(X^n)\Psi_{\varepsilon,n}(X^n)) - \mathrm{tr}(D^n(X^n)(1 - \Theta_{\varepsilon,n})) \\
&= 1 - \mathrm{tr}(D^n(X^n)(1 - \Psi_{\varepsilon,n}(X^n))) - \mathrm{tr}(D^n(X^n)(1 - \Theta_{\varepsilon,n}))
\end{aligned} \tag{66}$$

where (a) and (b) use (57) along with the cyclic property of the trace and (b) additionally uses $\Psi_{\varepsilon,n}(X^n) \leq \mathbf{1}$, which can be verified with the spectral representation (55).

The trace in (65) can be bounded as

$$\begin{aligned}
\mathrm{tr}(D(X^n)\Phi_{\varepsilon,n}(X^n)) &\stackrel{(59)}{=} \mathrm{tr}\left(D(X^n)\Theta_{\varepsilon,n}\Psi_{\varepsilon,n}(X^n)\Theta_{\varepsilon,n}\right) \\
&\stackrel{(a)}{\geq} \mathrm{tr}\left(D(X^n)\Psi_{\varepsilon,n}(X^n)\right) - 2\mathrm{tr}\left(D(X^n)(1 - \Theta_{\varepsilon,n})\right) \\
&= 1 - \mathrm{tr}\left(D(X^n)(1 - \Psi_{\varepsilon,n}(X^n))\right) - 2\mathrm{tr}\left(D(X^n)(1 - \Theta_{\varepsilon,n})\right),
\end{aligned} \tag{67}$$

where (a) is due to [44, Lemma 6].

The same two terms appear in (66) and (67), and we will bound their expectations separately. For the first term, we recall the definition (62). Since $\mathrm{tr}(D(X)^\alpha)$ is nonincreasing in α , it is clear that (48) and Lemma 19-1 ensure that $H_{P,\alpha} < \infty$ for all $\alpha \in [\alpha_{\min}, \infty)$. With that, we have for every $\alpha_1 \in (1, \infty)$ and $\alpha_2 \in [\alpha_{\min}, 1)$

$$\begin{aligned}
&\mathbb{E}\mathrm{tr}(D^n(X^n)(1 - \Psi_{\varepsilon,n}(X^n))) \\
&= \mathbb{E}\mathrm{tr}\left(\sum_{y^n \in \mathbb{N}^n} \mathbb{1}_{\mathcal{X}^n \times \mathbb{N}^n \setminus \mathcal{P}_{\varepsilon,n}}(X^n, y^n) P(y^n|X^n) |e_{y^n|X^n}\rangle \langle e_{y^n|X^n}| \right) \\
&= P(\mathcal{X}^n \times \mathbb{N}^n \setminus \mathcal{P}_{\varepsilon,n}) \\
&= P(-\log(P(Y^n|X^n)) \leq n(H_P - \varepsilon)) + P(-\log(P(Y^n|X^n)) \geq n(H_P + \varepsilon)) \\
&= P(P(Y^n|X^n)^{\alpha_1-1} \geq \exp(-n(\alpha_1 - 1)(H_P - \varepsilon))) + P(P(Y^n|X^n)^{\alpha_2-1} \geq \exp(-n(\alpha_2 - 1)(H_P + \varepsilon))) \\
&\stackrel{(a)}{\leq} \mathbb{E}_P(P(Y^n|X^n)^{\alpha_1-1}) \exp(n(\alpha_1 - 1)(H_P - \varepsilon)) + \mathbb{E}_P(P(Y^n|X^n)^{\alpha_2-1}) \exp(n(\alpha_2 - 1)(H_P + \varepsilon)) \\
&= \exp(-n(\alpha_1 - 1)(H_{P,\alpha_1} + \varepsilon - H_P)) + \exp(-n(1 - \alpha_2)(H_P + \varepsilon - H_{P,\alpha_2})),
\end{aligned} \tag{68}$$

where the inequality step (a) is due to Markov's inequality. Lemma 21 allows us to select $\alpha_1 \in (1, \infty)$ with $H_{P,\alpha_1} > H_P - \varepsilon$ and $\alpha_2 \in [\alpha_{\min}, 1)$ with $H_{P,\alpha_2} < H_P + \varepsilon$, resulting in an exponential decay in (68).

Similarly, we recall the definition (63) and note that if $D_P^\alpha \in \mathcal{T}(\mathcal{H})$, then $H_{U,\alpha} < \infty$. For $\alpha_3 \in (1, \infty)$ and $\alpha_4 \in [\alpha_{\min}, 1)$, we obtain

$$\begin{aligned}
&\mathbb{E}\mathrm{tr}(D^n(X^n)(1 - \Theta_{\varepsilon,n})) \\
&= \mathrm{tr}(D_P^{\otimes n}(1 - \Theta_{\varepsilon,n})) \\
&= \mathrm{tr}\left(\sum_{y^n \in \mathbb{N}^n} \mathbb{1}_{\mathbb{N}^n \setminus \mathcal{U}_{\varepsilon,n}} U(y^n) |e_{y^n}\rangle \langle e_{y^n}| \right) \\
&= U(\mathbb{N}^n \setminus \mathcal{U}_{\varepsilon,n}) \\
&= U(-\log U(y^n) \leq n(H_U - \varepsilon)) + U(-\log U(y^n) \geq n(H_U + \varepsilon)) \\
&= U(U(y^n)^{\alpha_3-1} \geq \exp(-n(\alpha_3 - 1)(H_U - \varepsilon))) + U(U(y^n)^{\alpha_4-1} \geq \exp(-n(\alpha_4 - 1)(H_U + \varepsilon))) \\
&\leq \mathbb{E}_U(U(y^n)^{\alpha_3-1}) \exp(n(\alpha_3 - 1)(H_U - \varepsilon)) + \mathbb{E}_U(U(y^n)^{\alpha_4-1}) \exp(n(\alpha_4 - 1)(H_U + \varepsilon)) \\
&= \exp(-n(\alpha_3 - 1)(H_{U,\alpha_3} + \varepsilon - H_U)) + \exp(-n(1 - \alpha_4)(H_U + \varepsilon - H_{U,\alpha_4})).
\end{aligned} \tag{69}$$

Lemma 21 allows us to select $\alpha_3 \in (1, \infty)$ with $H_{U,\alpha_3} > H_U - \varepsilon$ and $\alpha_4 \in [\alpha_{\min}, 1)$ with $H_{U,\alpha_4} < H_U + \varepsilon$, resulting in an exponential decay in (69).

Finally, the Lemma follows from (66), (67), (68) and (69) for any choice of

$$\gamma_1 \in \left(0, \min \left((\alpha_1 - 1)(H_{P,\alpha_1} + \varepsilon - H_P), \right. \right. \\ \left. \left. (1 - \alpha_2)(H_P + \varepsilon - H_{P,\alpha_2}), \right. \right. \\ \left. \left. (\alpha_3 - 1)(H_{U,\alpha_3} + \varepsilon - H_U), \right. \right. \\ \left. \left. (1 - \alpha_4)(H_U + \varepsilon - H_{U,\alpha_4}) \right) \right). \quad \square$$

B. Proof of Theorem 3 for cq Channel Resolvability

We start with a preliminary lemma which is used in the proof of Theorem 3 and encapsulates a symmetrization argument similar to the one used in [45, Theorem 4.10].

Lemma 10. *Let (\mathcal{X}, Σ) be a measurable space and $T : \mathcal{X} \rightarrow \mathcal{T}(\mathcal{H})$ a measurable map. Let P be a probability measure on \mathcal{X} , and $X := (X_1, \dots, X_\ell)$ be a tuple of \mathcal{X} -valued random variables i.i.d. according to P . Let*

$$T_X := \frac{1}{\ell} \sum_{i=1}^{\ell} T(X_i).$$

Then, we have

$$\mathbb{E} \|T_X - \mathbb{E}T_X\|_{\text{tr}} \leq 2\text{tr} \sqrt{\frac{1}{\ell} \mathbb{E}(T(X_1)^* T(X_1))}, \quad (70)$$

$$\mathbb{E} \|T_X - \mathbb{E}T_X\|_{\text{tr}} \leq 2\text{tr} \sqrt{\frac{1}{\ell} \mathbb{E}(T(X_1) T(X_1)^*)}. \quad (71)$$

Proof. Let $\hat{X}_1, \dots, \hat{X}_\ell$ be i.i.d. independent copies of X_1, \dots, X_ℓ , and let $\mathcal{E}_1, \dots, \mathcal{E}_\ell$ be i.i.d. uniformly on $\{-1, 1\}$. The following derivations are adapted from the proof of [45, Theorem 4.10].

$$\begin{aligned} \mathbb{E} \|T_X - \mathbb{E}T_X\|_{\text{tr}} &= \mathbb{E}_X \left\| \mathbb{E}_{\hat{X}} \sum_{i=1}^{\ell} \frac{1}{\ell} (T(X_i) - T(\hat{X}_i)) \right\|_{\text{tr}} \\ &\stackrel{(a)}{\leq} \mathbb{E}_{X, \hat{X}} \left\| \sum_{i=1}^{\ell} \frac{1}{\ell} (T(X_i) - T(\hat{X}_i)) \right\|_{\text{tr}} \\ &\stackrel{(b)}{=} \mathbb{E}_{X, \hat{X}, \mathcal{E}} \left\| \sum_{i=1}^{\ell} \frac{1}{\ell} \mathcal{E}_i (T(X_i) - T(\hat{X}_i)) \right\|_{\text{tr}} \\ &\leq \mathbb{E}_{X, \mathcal{E}} \left\| \sum_{i=1}^{\ell} \frac{1}{\ell} \mathcal{E}_i T(X_i) \right\|_{\text{tr}} + \mathbb{E}_{\hat{X}, \mathcal{E}} \left\| \sum_{i=1}^{\ell} \frac{1}{\ell} \mathcal{E}_i T(\hat{X}_i) \right\|_{\text{tr}} \\ &= 2\mathbb{E}_{X, \mathcal{E}} \left\| \sum_{i=1}^{\ell} \frac{1}{\ell} \mathcal{E}_i T(X_i) \right\|_{\text{tr}} \\ &= 2\mathbb{E}_{X, \mathcal{E}} \text{tr} \sqrt{\left(\sum_{i=1}^{\ell} \frac{1}{\ell} \mathcal{E}_i T(X_i) \right)^* \left(\sum_{i=1}^{\ell} \frac{1}{\ell} \mathcal{E}_i T(X_i) \right)} \\ &\stackrel{(c)}{\leq} 2\text{tr} \sqrt{\mathbb{E}_{X, \mathcal{E}} \left(\left(\sum_{i=1}^{\ell} \frac{1}{\ell} \mathcal{E}_i T(X_i) \right)^* \left(\sum_{i=1}^{\ell} \frac{1}{\ell} \mathcal{E}_i T(X_i) \right) \right)} \\ &= 2\text{tr} \sqrt{\frac{1}{\ell^2} \mathbb{E}_X \sum_{i_1, i_2=1}^{\ell} \mathbb{E}_{\mathcal{E}} (\mathcal{E}_{i_1} \mathcal{E}_{i_2}) T(X_{i_1})^* T(X_{i_2})} \\ &\stackrel{(d)}{=} 2\text{tr} \sqrt{\frac{1}{\ell^2} \mathbb{E}_X \sum_{i=1}^{\ell} T(X_i)^* T(X_i)} \\ &= 2\text{tr} \sqrt{\frac{1}{\ell} \mathbb{E}_{X_1} T(X_1)^* T(X_1)}. \end{aligned}$$

Step (a) follows by Lemma 19-2). For step (b), we observe that the equality holds conditioned on any realization of $\mathcal{E}_1, \dots, \mathcal{E}_\ell$ since X_i and \hat{X}_i are identically distributed and therefore can be swapped if $\mathcal{E}_i = -1$. Inequality (c) is by Lemma 19-5).

Finally, equality (d) holds because $\mathbb{E}_{\mathcal{E}}(\mathcal{E}_{i_1}\mathcal{E}_{i_2})$ equals 1 if $i_1 = i_2$ and 0 otherwise. This concludes the proof of (70). (71) follows similarly using $\|A\|_{\text{tr}} = \|A^*\|_{\text{tr}}$ before expanding the trace norm. \square

Remark 4. [45, Theorem 4.10] (from the proof of which the first part of the calculation above is adapted) bounds the absolute deviation of an empirical average from its expectation in terms of the Rademacher complexity of a suitably defined class of functions. Indeed, via the trace norm duality stated in Lemma 15-4), the term

$$\mathbb{E}_{X,\mathcal{E}} \left\| \sum_{i=1}^{\ell} \frac{1}{\ell} \mathcal{E}_i T(X_i) \right\|_{\text{tr}}$$

which appears in the calculation can be argued to be equal to the Rademacher complexity of the function class

$$\{\mathcal{X} \rightarrow \mathbb{C}, x \mapsto \text{tr}(AT(x)) : A \in \mathcal{B}(\mathcal{H}), \|A\|_{\text{op}} \leq 1\}.$$

Proof of Theorem 3. In this proof, we use the definitions of Section V-A with some

$$\varepsilon \in (0, (R - \chi(P; D))/4) \tag{72}$$

which we fix for the rest of the proof.

We multiply identities and use the triangle inequality to bound

$$\begin{aligned} & \mathbb{E}_{\mathcal{C}} \|D_{\mathcal{C}} - D_P^{\otimes n}\|_{\text{tr}} \\ &= \mathbb{E}_{\mathcal{C}} \left\| \frac{1}{M} \sum_{m=1}^M \left(D^n(\mathcal{C}(m)) - \mathbb{E}_{\mathcal{C}} D^n(\mathcal{C}(m)) \right) \right\|_{\text{tr}} \\ &= \mathbb{E}_{\mathcal{C}} \left\| \frac{1}{M} \sum_{m=1}^M \left((\Gamma_{\varepsilon,n}(\mathcal{C}(m)) + \mathbf{1} - \Gamma_{\varepsilon,n}(\mathcal{C}(m))) D^n(\mathcal{C}(m)) - \mathbb{E}_{\mathcal{C}} \left((\Gamma_{\varepsilon,n}(\mathcal{C}(m)) + \mathbf{1} - \Gamma_{\varepsilon,n}(\mathcal{C}(m))) D^n(\mathcal{C}(m)) \right) \right) \right\|_{\text{tr}} \\ &\leq \mathbb{E}_{\mathcal{C}} \left\| \frac{1}{M} \sum_{m=1}^M \left(\Gamma_{\varepsilon,n}(\mathcal{C}(m)) D^n(\mathcal{C}(m)) - \mathbb{E}_{\mathcal{C}} \left(\Gamma_{\varepsilon,n}(\mathcal{C}(m)) D^n(\mathcal{C}(m)) \right) \right) \right\|_{\text{tr}} \\ &\quad + \mathbb{E}_{\mathcal{C}} \left\| \frac{1}{M} \sum_{m=1}^M \left((\mathbf{1} - \Gamma_{\varepsilon,n}(\mathcal{C}(m))) D^n(\mathcal{C}(m)) - \mathbb{E}_{\mathcal{C}} \left((\mathbf{1} - \Gamma_{\varepsilon,n}(\mathcal{C}(m))) D^n(\mathcal{C}(m)) \right) \right) \right\|_{\text{tr}} \\ &= \mathbb{E}_{\mathcal{C}} \left\| \frac{1}{M} \sum_{m=1}^M \left(\Gamma_{\varepsilon,n}(\mathcal{C}(m)) D^n(\mathcal{C}(m)) - \mathbb{E}_{\mathcal{C}} \left(\Gamma_{\varepsilon,n}(\mathcal{C}(m)) D^n(\mathcal{C}(m)) \right) \right) \right\|_{\text{tr}} \\ &\quad + \mathbb{E}_{\mathcal{C}} \left\| \frac{1}{M} \sum_{m=1}^M \left((\mathbf{1} - \Gamma_{\varepsilon,n}(\mathcal{C}(m))) D^n(\mathcal{C}(m)) (\Gamma_{\varepsilon,n}(\mathcal{C}(m)) + \mathbf{1} - \Gamma_{\varepsilon,n}(\mathcal{C}(m)))^* \right. \right. \\ &\quad \quad \left. \left. - \mathbb{E}_{\mathcal{C}} \left((\mathbf{1} - \Gamma_{\varepsilon,n}(\mathcal{C}(m))) D^n(\mathcal{C}(m)) (\Gamma_{\varepsilon,n}(\mathcal{C}(m)) + \mathbf{1} - \Gamma_{\varepsilon,n}(\mathcal{C}(m)))^* \right) \right) \right\|_{\text{tr}} \\ &\leq \mathbb{E}_{\mathcal{C}} \left\| \frac{1}{M} \sum_{m=1}^M \left(\Gamma_{\varepsilon,n}(\mathcal{C}(m)) D^n(\mathcal{C}(m)) - \mathbb{E}_{\mathcal{C}} \left(\Gamma_{\varepsilon,n}(\mathcal{C}(m)) D^n(\mathcal{C}(m)) \right) \right) \right\|_{\text{tr}} \\ &\quad + \mathbb{E}_{\mathcal{C}} \left\| \frac{1}{M} \sum_{m=1}^M \left(D^n(\mathcal{C}(m)) \Gamma_{\varepsilon,n}(\mathcal{C}(m))^* - \mathbb{E}_{\mathcal{C}} \left(D^n(\mathcal{C}(m)) \Gamma_{\varepsilon,n}(\mathcal{C}(m))^* \right) \right) \right\|_{\text{tr}} \\ &\quad + \mathbb{E}_{\mathcal{C}} \left\| \frac{1}{M} \sum_{m=1}^M \left(\Gamma_{\varepsilon,n}(\mathcal{C}(m)) D^n(\mathcal{C}(m)) \Gamma_{\varepsilon,n}(\mathcal{C}(m))^* - \mathbb{E}_{\mathcal{C}} \left(\Gamma_{\varepsilon,n}(\mathcal{C}(m)) D^n(\mathcal{C}(m)) \Gamma_{\varepsilon,n}(\mathcal{C}(m))^* \right) \right) \right\|_{\text{tr}} \\ &\quad + \mathbb{E}_{\mathcal{C}} \left\| \frac{1}{M} \sum_{m=1}^M \left((\mathbf{1} - \Gamma_{\varepsilon,n}(\mathcal{C}(m))) D^n(\mathcal{C}(m)) (\mathbf{1} - \Gamma_{\varepsilon,n}(\mathcal{C}(m)))^* \right. \right. \\ &\quad \quad \left. \left. - \mathbb{E}_{\mathcal{C}} \left((\mathbf{1} - \Gamma_{\varepsilon,n}(\mathcal{C}(m))) D^n(\mathcal{C}(m)) (\mathbf{1} - \Gamma_{\varepsilon,n}(\mathcal{C}(m)))^* \right) \right) \right\|_{\text{tr}} \end{aligned} \tag{73}$$

We next bound the summands in (73) separately. For the last summand, we calculate

$$\begin{aligned}
& \mathbb{E}_{\mathcal{C}} \left\| \frac{1}{M} \sum_{m=1}^M \left((\mathbf{1} - \Gamma_{\varepsilon,n}(\mathcal{C}(m))) D^n(\mathcal{C}(m)) (\mathbf{1} - \Gamma_{\varepsilon,n}(\mathcal{C}(m)))^* \right. \right. \\
& \quad \left. \left. - \mathbb{E}_{\mathcal{C}} \left((\mathbf{1} - \Gamma_{\varepsilon,n}(\mathcal{C}(m))) D^n(\mathcal{C}(m)) (\mathbf{1} - \Gamma_{\varepsilon,n}(\mathcal{C}(m)))^* \right) \right) \right\|_{\text{tr}} \\
& \stackrel{(a)}{\leq} \mathbb{E}_{\mathcal{C}} \left\| \frac{1}{M} \sum_{m=1}^M \left((\mathbf{1} - \Gamma_{\varepsilon,n}(\mathcal{C}(m))) D^n(\mathcal{C}(m)) (\mathbf{1} - \Gamma_{\varepsilon,n}(\mathcal{C}(m)))^* \right) \right\|_{\text{tr}} \\
& \quad + \left\| \frac{1}{M} \mathbb{E}_{\mathcal{C}} \sum_{m=1}^M \left((\mathbf{1} - \Gamma_{\varepsilon,n}(\mathcal{C}(m))) D^n(\mathcal{C}(m)) (\mathbf{1} - \Gamma_{\varepsilon,n}(\mathcal{C}(m)))^* \right) \right\|_{\text{tr}} \\
& \stackrel{(b)}{=} 2 \frac{1}{M} \sum_{m=1}^M \mathbb{E}_{\mathcal{C}} \text{tr} \left((\mathbf{1} - \Gamma_{\varepsilon,n}(\mathcal{C}(m))) D^n(\mathcal{C}(m)) (\mathbf{1} - \Gamma_{\varepsilon,n}(\mathcal{C}(m)))^* \right) \\
& = 2 \mathbb{E}_{X^n} \text{tr} \left((\mathbf{1} - \Gamma_{\varepsilon,n}(X^n)) D^n(X^n) (\mathbf{1} - \Gamma_{\varepsilon,n}(X^n))^* \right) \\
& = 2 \mathbb{E}_{X^n} \left(1 - \text{tr} \left(\Theta_{\varepsilon,n} \Psi_{\varepsilon,n}(X^n) D^n(X^n) \right) - \text{tr} \left(D^n(X^n) \Gamma_{\varepsilon,n}(X^n)^* \right) + \text{tr} \left(\Theta_{\varepsilon,n} \Psi_{\varepsilon,n}(X^n) D^n(X^n) \Psi_{\varepsilon,n}(X^n) \Theta_{\varepsilon,n} \right) \right) \\
& \stackrel{(c)}{=} 2 \left(1 - \mathbb{E}_{X^n} \left(\text{tr} \left(D^n(X^n) \Gamma_{\varepsilon,n}(X^n)^* \right) \right) \right) \\
& \stackrel{(d)}{\leq} 2 \exp(-n\gamma_1).
\end{aligned}$$

(a) is due to the triangle inequality, (b) is because trace and trace norm are equal for positive semi-definite operators, (c) is by cyclic permutations inside the trace and using (57). Finally, (d) is due to Lemma 9.

For the first summand in (73), we apply (71) of Lemma 10 with $T : \mathcal{X}^n \rightarrow \mathcal{T}(\mathcal{H})$, $x^n \mapsto \Gamma_{\varepsilon,n}(x^n) D^n(x^n)$, $\ell = M$ and $X_m = \mathcal{C}(m)$. This yields

$$\begin{aligned}
& \mathbb{E}_{\mathcal{C}} \left\| \frac{1}{M} \sum_{m=1}^M \left(\Gamma_{\varepsilon,n}(\mathcal{C}(m)) D^n(\mathcal{C}(m)) - \mathbb{E}_{\mathcal{C}} \left(\Gamma_{\varepsilon,n}(\mathcal{C}(m)) D^n(\mathcal{C}(m)) \right) \right) \right\|_{\text{tr}} \\
& \leq 2 \text{tr} \sqrt{\frac{1}{M} \mathbb{E}_{X^n} \left(\Gamma_{\varepsilon,n}(X^n) D^n(X^n) \Gamma_{\varepsilon,n}(X^n)^* \right)} \\
& \stackrel{(57)}{=} 2 \text{tr} \sqrt{\frac{1}{M} \mathbb{E}_{X^n} \left(\Theta_{\varepsilon,n} D^n(X^n)^{\frac{1}{2}} \Psi_{\varepsilon,n}(X^n) D^n(X^n) \Psi_{\varepsilon,n}(X^n) D^n(X^n)^{\frac{1}{2}} \Theta_{\varepsilon,n} \right)}.
\end{aligned}$$

For the second summand in (73), we use (70) of Lemma 10 with $T : \mathcal{X}^n \rightarrow \mathcal{T}(\mathcal{H})$, $x^n \mapsto D^n(x^n) \Gamma_{\varepsilon,n}(x^n)^*$ and obtain the exact same upper bound.

For the third summand in (73), we use Lemma 10 one more time with $T : \mathcal{X}^n \rightarrow \mathcal{T}(\mathcal{H})$, $x^n \mapsto \Gamma_{\varepsilon,n}(x^n) D^n(x^n) \Gamma_{\varepsilon,n}(x^n)^*$ (this time it does not matter which alternative we use because T has self-adjoint values) and obtain

$$\begin{aligned}
& \mathbb{E}_{\mathcal{C}} \left\| \frac{1}{M} \sum_{m=1}^M \left(\Gamma_{\varepsilon,n}(\mathcal{C}(m)) D^n(\mathcal{C}(m)) \Gamma_{\varepsilon,n}(\mathcal{C}(m))^* - \mathbb{E}_{\mathcal{C}} \left(\Gamma_{\varepsilon,n}(\mathcal{C}(m)) D^n(\mathcal{C}(m)) \Gamma_{\varepsilon,n}(\mathcal{C}(m))^* \right) \right) \right\|_{\text{tr}} \\
& \leq 2 \text{tr} \sqrt{\frac{1}{M} \mathbb{E}_{X^n} \left(\Gamma_{\varepsilon,n}(X^n) D^n(X^n) \Gamma_{\varepsilon,n}(X^n)^* \Gamma_{\varepsilon,n}(X^n) D^n(X^n) \Gamma_{\varepsilon,n}(X^n)^* \right)} \\
& \stackrel{(57)}{=} 2 \text{tr} \sqrt{\frac{1}{M} \mathbb{E}_{X^n} \left(\Theta_{\varepsilon,n} D^n(X^n)^{\frac{1}{2}} \Psi_{\varepsilon,n}(X^n) D^n(X^n)^{\frac{1}{2}} \Psi_{\varepsilon,n}(X^n) \Theta_{\varepsilon,n} \Psi_{\varepsilon,n}(X^n) D^n(X^n)^{\frac{1}{2}} \Psi_{\varepsilon,n}(X^n) D^n(X^n)^{\frac{1}{2}} \Theta_{\varepsilon,n} \right)} \\
& \stackrel{(a)}{\leq} 2 \text{tr} \sqrt{\frac{1}{M} \mathbb{E}_{X^n} \left(\Theta_{\varepsilon,n} D^n(X^n)^{\frac{1}{2}} \Psi_{\varepsilon,n}(X^n) D^n(X^n) \Psi_{\varepsilon,n}(X^n) D^n(X^n)^{\frac{1}{2}} \Theta_{\varepsilon,n} \right)}.
\end{aligned}$$

(a) is by $\Theta_{\varepsilon,n} \leq \mathbf{1}$ and once more applying (57). We have obtained matching upper bounds in all three cases and can conclude our calculation with a successive application of the sub-items of Lemma 8 in conjunction with the operator monotonicity of the square root [46, Theorem]. The number of the subitem of Lemma 8 is indicated above the inequality sign where it is applied.

$$\begin{aligned}
& \text{tr} \sqrt{\frac{1}{M} \mathbb{E}_{X^n} \left(\Theta_{\varepsilon,n} D^n(X^n)^{\frac{1}{2}} \Psi_{\varepsilon,n}(X^n) D^n(X^n) \Psi_{\varepsilon,n}(X^n) D^n(X^n)^{\frac{1}{2}} \Theta_{\varepsilon,n} \right)} \\
& \stackrel{1)}{\leq} \text{tr} \sqrt{\frac{1}{M} \exp(-n(H_P - \varepsilon)) \mathbb{E}_{X^n} \left(\Theta_{\varepsilon,n} D^n(X^n) \Theta_{\varepsilon,n} \right)}
\end{aligned}$$

$$\begin{aligned}
&= \text{tr} \sqrt{\frac{1}{M} \exp(-n(H_P - \varepsilon)) \Theta_{\varepsilon, n} D_P^{\otimes n} \Theta_{\varepsilon, n}} \\
&\stackrel{3)}{\leq} \text{tr} \sqrt{\frac{1}{M} \exp(-n(H_P + H_U - 2\varepsilon)) \Theta_{\varepsilon, n}} \\
&\stackrel{(a)}{\leq} \exp\left(-\frac{1}{2}n(H_P + H_U + R - 2\varepsilon)\right) \text{tr} \Theta_{\varepsilon, n} \\
&\stackrel{4)}{\leq} \exp\left(-\frac{1}{2}n(H_P - H_U + R - 4\varepsilon)\right) \\
&\stackrel{\text{eq. (52)}}{=} \exp\left(-\frac{1}{2}n(R - \chi(P; D) - 4\varepsilon)\right).
\end{aligned} \tag{74}$$

Step (a) is due to the assumption $M \geq \exp(nR)$ and (57). The assumptions of the theorem and choice of ε ensure $R - \chi(P; D) - 4\varepsilon > 0$. Therefore, the theorem follows with any choice

$$\gamma \in \left(0, \min\left(\gamma_1, \frac{1}{2}(R - \chi(P; D) - 4\varepsilon)\right)\right). \quad \square$$

C. Proof of Theorem 4 for cq Channel Coding

In this section, we follow the methodology in [44], making adaptations as needed to derive the exponential error bound as stated in Theorem 4. An essential ingredient will be the following lemma from [44]. In the statement of the lemma, we need the notion of Moore-Penrose pseudoinverse which assigns to any $A \in \mathcal{B}(\mathcal{H})$ an (unbounded) operator A^{-1} acting on \mathcal{H} [47, Definition 2.2]. Moreover, for $A \in \mathcal{B}(\mathcal{H})$, we use the notation $\text{im}(A) := \{h \in \mathcal{H} : \exists \tilde{h} \in \mathcal{H} \text{ such that } h = A\tilde{h}\}$.

Lemma 11. (Hayashi-Nagaoka [44, Lemma 2]) *Let $c \in (0, \infty)$, and let $A, B \in \mathcal{B}(\mathcal{H})$ with $0 \leq A \leq \mathbf{1}$ and $0 \leq B$ such that $\text{im}(A + B)$ is closed. Then the following statements hold true:*

- 1) *The Moore-Penrose pseudoinverse $\sqrt{A + B}^{-1}$ is a bounded linear operator, i.e., $\sqrt{A + B}^{-1} \in \mathcal{B}(\mathcal{H})$.*
- 2) *For any real number $c > 0$, we have*

$$\mathbf{1} - \sqrt{A + B}^{-1} A \sqrt{A + B}^{-1} \leq (1 + c)(\mathbf{1} - A) + (2 + c + c^{-1})B.$$

Proof. 1) In the proof of the first claim, we will use the following fact: If $T \in \mathcal{B}(\mathcal{H})$, $T \geq 0$, and $\text{im}(T)$ is closed, then $\text{im}(T) = \text{im}(\sqrt{T})$. To prove this, first observe that clearly $\text{im}(T) \subseteq \text{im}(\sqrt{T})$ holds since $T = \sqrt{T} \cdot \sqrt{T}$. Therefore, it suffices to show $\text{im}(\sqrt{T}) \subseteq \text{im}(T)$. The last inclusion is a consequence of the elementary relations $\ker(T) = \ker(\sqrt{T})$, and $\ker(T) = \text{im}(T)^\perp$, where $\ker(T) = \{h \in \mathcal{H} : Th = 0\}$ and M^\perp denotes the orthogonal complement of a subspace $M \subseteq \mathcal{H}$:

$$\text{im}(T)^\perp = \ker(T) = \ker(\sqrt{T}) = \text{im}(\sqrt{T})^\perp. \tag{76}$$

Passing to the orthogonal complement in (76), using our assumption that $\text{im}(T)$ is closed, and the fact that for every subspace $M \subseteq \mathcal{H}$ we have $M^{\perp\perp} = \overline{M}$, we obtain

$$\text{im}(T) = \text{im}(\sqrt{T})^{\perp\perp} = \overline{\text{im}(\sqrt{T})} \supseteq \text{im}(\sqrt{T}). \tag{77}$$

Since $\text{im}(A + B)$ is closed by assumption, we have $\text{im}(A + B) = \text{im}(\sqrt{A + B})$. Consequently, $\text{im}(\sqrt{A + B})$ is closed as well and [47, Proposition 2.4] states that in this case the Moore-Penrose pseudoinverse $\sqrt{A + B}^{-1}$ is a bounded linear operator, i.e. $\sqrt{A + B}^{-1} \in \mathcal{B}(\mathcal{H})$.

- 2) The operator inequality in the lemma follows from the proof of [44, Lemma 2]. □

For the proof of Theorem 4, we use a fixed

$$\varepsilon \in (0, (\chi(P; D) - R)/2). \tag{78}$$

along with the corresponding definitions from Section V-A. For decoding, we choose the POVM $(Y_m)_{m=1}^M$ defined as

$$Y_m := \sqrt{\sum_{\hat{m}=1}^M \Phi_{\varepsilon, n}(\mathcal{C}(\hat{m}))}^{-1} \Phi_{\varepsilon, n}(\mathcal{C}(m)) \sqrt{\sum_{\hat{m}=1}^M \Phi_{\varepsilon, n}(\mathcal{C}(\hat{m}))}^{-1}, \tag{79}$$

where we use $\Phi_{\varepsilon, n}$ defined in (59). We note that

$$\dim \text{im} \left(\sum_{\hat{m}=1}^M \Phi_{\varepsilon, n}(\mathcal{C}(\hat{m})) \right) < \infty, \tag{80}$$

by Lemma 8-4) which implies that

$$\text{im} \left(\sum_{\hat{m}=1}^M \Phi_{\varepsilon,n}(\mathcal{C}(\hat{m})) \right) \quad (81)$$

is closed. Consequently, by the first statement of the Lemma 11 we have

$$\sqrt{\sum_{\hat{m}=1}^M \Phi_{\varepsilon,n}(\mathcal{C}(\hat{m}))}^{-1} \in \mathcal{B}(\mathcal{H}). \quad (82)$$

The first part of the statement of Theorem 4, namely that the Y_m are measurable functions of \mathcal{C} , is proven in the next two lemmas. This measurability is also essential for the proof of the remainder of Theorem 4.

Lemma 12. *Let \mathcal{H} be a finite-dimensional complex Hilbert space. Then the function*

$$\cdot^{-1} : \mathcal{B}(\mathcal{H}) \rightarrow \mathcal{B}(\mathcal{H}), \quad A \mapsto A^{-1}$$

which maps every operator to its Moore-Penrose pseudoinverse is measurable.

Proof. We can represent the Moore-Penrose pseudoinverse as a limit (see [48, Chapter 3, Ex. 25])

$$A^{-1} = \lim_{k \rightarrow \infty} \left(A^* A + \frac{1}{k} \mathbf{1} \right)^{-1} A^*.$$

Matrix inversion is continuous (see [48, Chapter 6, eq. (127)]), and so are addition and multiplication. Therefore, \cdot^{-1} is represented as a pointwise limit of continuous (and therefore measurable) functions, hence it is measurable. \square

Lemma 13. *For every $m \in \{1, \dots, M\}$, $\mathcal{X}^{nM} \rightarrow \mathcal{T}(\mathcal{H})$, $\mathcal{C} \mapsto Y_m$ is measurable.*

Proof. Clearly,

$$\sum_{\hat{m}=1}^M \Phi_{\varepsilon,n}(\mathcal{C}(\hat{m}))$$

is a measurable function of \mathcal{C} , so by Lemma 17, its square root is also measurable. Denote the restriction of

$$\sqrt{\sum_{\hat{m}=1}^M \Phi_{\varepsilon,n}(\mathcal{C}(\hat{m}))}$$

to $\text{im}(\Theta_{\varepsilon,n})$ by A . It can be seen in (59) that $A : \text{im}(\Theta_{\varepsilon,n}) \rightarrow \text{im}(\Theta_{\varepsilon,n})$, and that we can write

$$\sqrt{\sum_{\hat{m}=1}^M \Phi_{\varepsilon,n}(\mathcal{C}(\hat{m}))}^{-1} (h) = \begin{cases} A^{-1}h, & h \in \text{im}(\Theta_{\varepsilon,n}) \\ 0, & \text{otherwise.} \end{cases} \quad (83)$$

By Lemma 8-4), $\text{im}(\Theta_{\varepsilon,n})$ is finite-dimensional, so we may apply Lemma 12 to argue that the operator represented in (83) is a measurable function of \mathcal{C} . Since all norms are equivalent on finite-dimensional spaces, this measurability also applies with respect to the trace norm. The measurability of Y_m is then a straightforward consequence of Lemma 16. \square

Proof of Theorem 4. Clearly, $Y_m \geq 0$ and $Y_1 + \dots + Y_M = \mathbf{1}$, so $(Y_m)_{m=1}^M$ is a $\{1, \dots, M\}$ -valued POVM. We have for the decoding error

$$\begin{aligned} & \frac{1}{M} \sum_{m=1}^M \text{tr}(D(\mathcal{C}(m))(\mathbf{1} - Y_m)) \\ &= \frac{1}{M} \sum_{m=1}^M \text{tr} \left(\sqrt{D(\mathcal{C}(m))} \left(\mathbf{1} - \sqrt{\sum_{\hat{m}=1}^M \Phi_{\varepsilon,n}(\mathcal{C}(\hat{m}))}^{-1} \Phi_{\varepsilon,n}(\mathcal{C}(m)) \sqrt{\sum_{\hat{m}=1}^M \Phi_{\varepsilon,n}(\mathcal{C}(\hat{m}))}^{-1} \right) \sqrt{D(\mathcal{C}(m))} \right) \\ &\stackrel{(a)}{\leq} \frac{2}{M} \sum_{m=1}^M \text{tr} \left(D(\mathcal{C}(m))(\mathbf{1} - \Phi_{\varepsilon,n}(\mathcal{C}(m))) \right) + \frac{4}{M} \sum_{m=1}^M \text{tr} \left(D(\mathcal{C}(m)) \sum_{\substack{\hat{m}=1 \\ \hat{m} \neq m}}^M \Phi_{\varepsilon,n}(\mathcal{C}(\hat{m})) \right), \end{aligned} \quad (84)$$

where (a) is an application of Lemma 11 with

$$A := \Phi_{\varepsilon,n}(\mathcal{C}(m)), \quad B := \sum_{\substack{\hat{m}=1 \\ \hat{m} \neq m}}^M \Phi_{\varepsilon,n}(\mathcal{C}(\hat{m})), \quad c := 1,$$

where $\text{im}(A+B)$ is closed because it is finite-dimensional by Lemma 8-4).

As a prerequisite to bounding the expectation of the second summand in (84), we calculate

$$\begin{aligned} \text{tr}(D_P^{\otimes n} \Phi_{\varepsilon,n}(\mathcal{C}(m))) &\stackrel{(59)}{=} \text{tr}(D_P^{\otimes n} \Theta_{\varepsilon,n} \Psi_{\varepsilon,n}(\mathcal{C}(m)) \Theta_{\varepsilon,n}) \\ &\stackrel{(a)}{=} \text{tr}(\Psi_{\varepsilon,n}(\mathcal{C}(m)) \Theta_{\varepsilon,n} D_P^{\otimes n} \Theta_{\varepsilon,n} \Psi_{\varepsilon,n}(\mathcal{C}(m))) \\ &\stackrel{(b)}{\leq} \exp(-n(H_U - \varepsilon)) \text{tr}(\Psi_{\varepsilon,n}(\mathcal{C}(m)) \Theta_{\varepsilon,n} \Psi_{\varepsilon,n}(\mathcal{C}(m))) \\ &\stackrel{(c)}{\leq} \exp(-n(H_U - \varepsilon)) \text{tr}(\Psi_{\varepsilon,n}(\mathcal{C}(m))) \\ &\stackrel{(d)}{\leq} \exp(-n(H_U - H_P - 2\varepsilon)) \\ &\stackrel{(52)}{=} \exp(-n(\chi(P; D) - 2\varepsilon)), \end{aligned}$$

where (a) is by (57) and the cyclic property of the trace, (b) is by Lemma 8-3), (c) is due to $\Theta_{\varepsilon,n} \leq \mathbf{1}$ and (57), and (d) is by Lemma 8-2). We can use this in conjunction with the independence of codewords and bound

$$\begin{aligned} \mathbb{E}_{\mathcal{C}} \text{tr} \left(D(\mathcal{C}(m)) \sum_{\substack{\hat{m}=1 \\ \hat{m} \neq m}}^M \Phi_{\varepsilon,n}(\mathcal{C}(\hat{m})) \right) &= \mathbb{E}_{\mathcal{C}} \text{tr} \left(D_U^{\otimes n} \sum_{\substack{\hat{m}=1 \\ \hat{m} \neq m}}^M \Phi_{\varepsilon,n}(\mathcal{C}(\hat{m})) \right) \\ &\leq M \exp(-n(\chi(P; D) - 2\varepsilon)) \\ &\leq \exp(-n(\chi(P; D) - R - 2\varepsilon)). \end{aligned} \tag{85}$$

Next, we apply $\mathbb{E}_{\mathcal{C}}$ in (84). We use Lemma 9 in the first summand and (85) in the second summand which yields

$$\mathbb{E}_{\mathcal{C}} \left(\frac{1}{M} \sum_{m=1}^M \text{tr}(D(\mathcal{C}(m))(\mathbf{1} - Y_m)) \right) \leq 2 \exp(-n\gamma_1) + 4 \exp(-n(\chi(P; D) - R - 2\varepsilon)).$$

The theorem then follows with the choice $\gamma \in (0, \min(\gamma_1, \chi(P; D) - R - 2\varepsilon))$. \square

D. Concentration of Error

Theorems 3 and 4 are formulated in terms of expectation, but both the decoding error and the trace distance from the ideal output distribution are concentrated around their mean, as can be seen in the following corollaries.

Corollary 1. *Under the assumptions of Theorem 3, there are $\gamma_1, \gamma_2 \in (0, \infty)$ such that, for sufficiently large n ,*

$$\mathbb{P}_{\mathcal{C}} \left(\|D_{\mathcal{C}} - D_P^{\otimes n}\|_{\text{tr}} \geq \exp(-\gamma_1 n) \right) \leq \exp(-\exp(\gamma_2 n)). \tag{86}$$

Corollary 2. *Under the assumptions of Theorem 4, there are $\gamma_1, \gamma_2 \in (0, \infty)$ such that for sufficiently large n ,*

$$\mathbb{P}_{\mathcal{C}} \left(\frac{1}{M} \sum_{m=1}^M \text{tr}(D^n(m)(\mathbf{1} - Y_m)) \geq \exp(-n\gamma_1) \right) \leq \exp(-n\gamma_2).$$

The proof of Corollary 1 is essentially an application of the bounded differences inequality [49]. For the reader's convenience, we reproduce the result here in the form that we will be using.

Theorem 5. (Bounded differences inequality as stated in [50, Theorem 6.2].) *Let \mathcal{X} be a measurable space, and let $f : \mathcal{X}^\ell \rightarrow \mathbb{R}$ be measurable. Assume that there are nonnegative constants c_1, \dots, c_ℓ with the property*

$$\forall i \in \{1, \dots, \ell\} \sup \left\{ |f(x_1, \dots, x_\ell) - f(x_1, \dots, x_{i-1}, x'_i, x_{i+1}, \dots, x_\ell)| : x_1, \dots, x_\ell, x'_i \in \mathcal{X} \right\} \leq c_i, \tag{87}$$

and denote

$$v := \frac{1}{4} \sum_{i=1}^{\ell} c_i^2.$$

Let X_1, \dots, X_ℓ be independent random variables such that $\mathbb{E}f(X_1, \dots, X_\ell)$ exists. Then, for any $t \in (0, \infty)$,

$$\mathbb{P}(f(X_1, \dots, X_\ell) - \mathbb{E}f(X_1, \dots, X_\ell) > t) \leq \exp\left(-\frac{t^2}{2v}\right).$$

Condition (87) is called the *bounded differences property* which gives Theorem 5 its name.

Proof of Corollary 1. We apply Theorem 5 to the function

$$f : (\mathcal{C}(1), \dots, \mathcal{C}(M)) \mapsto \|D_{\mathcal{C}} - D_{\mathcal{P}}^{\otimes n}\|_{\text{tr}},$$

so we first need to compute $c_{\hat{m}}$ with

$$\sup \left\{ \left| \|D_{\mathcal{C}} - D_{\mathcal{P}}^{\otimes n}\|_{\text{tr}} - \|D_{\mathcal{C}'} - D_{\mathcal{P}}^{\otimes n}\|_{\text{tr}} \right| : \forall m \in \{1, \dots, \hat{m} - 1, \hat{m} + 1, \dots, M\} : \mathcal{C}(m) = \mathcal{C}'(m) \right\} \leq c_{\hat{m}}.$$

To this end, we calculate

$$\begin{aligned} \left| \|D_{\mathcal{C}} - D_{\mathcal{P}}^{\otimes n}\|_{\text{tr}} - \|D_{\mathcal{C}'} - D_{\mathcal{P}}^{\otimes n}\|_{\text{tr}} \right| &\stackrel{(a)}{\leq} \|D_{\mathcal{C}} - D_{\mathcal{P}}^{\otimes n} - D_{\mathcal{C}'} + D_{\mathcal{P}}^{\otimes n}\|_{\text{tr}} \\ &\stackrel{(49)}{=} \left\| \frac{1}{M} \sum_{m=1}^M \left(D^n(\mathcal{C}(m)) - D^n(\mathcal{C}'(m)) \right) \right\|_{\text{tr}} \\ &\stackrel{(b)}{=} \frac{1}{M} \|D^n(\mathcal{C}(\hat{m})) - D^n(\mathcal{C}'(\hat{m}))\|_{\text{tr}} \\ &\stackrel{(c)}{\leq} \frac{2}{M}, \end{aligned}$$

where (a) is due to the triangle inequality, (b) is because $\mathcal{C}(m) = \mathcal{C}'(m)$ whenever $m \neq \hat{m}$, and (c) is an application of the triangle inequality and the fact that the range of D is $\mathcal{S}(\mathcal{H})$.

This means that we can choose $c_{\hat{m}} := 2/M$ for all \hat{m} . Consequently, we obtain

$$v = \frac{1}{4} \sum_{\hat{m}=1}^M \frac{2^2}{M^2} = M^{-1}.$$

We fix real numbers $\beta, \gamma_1, \gamma_2$ with the properties

$$0 < \beta < \frac{R}{2}, \quad 0 < \gamma_1 < \min(\beta, \gamma), \quad 0 < \gamma_2 < R - 2\beta \quad (88)$$

where γ is from the statement of Theorem 3. With this, we have, for sufficiently large n ,

$$\begin{aligned} \mathbb{P}_{\mathcal{C}} \left(\|D_{\mathcal{C}} - D_{\mathcal{P}}^{\otimes n}\|_{\text{tr}} \geq \exp(-\gamma_1 n) \right) &\stackrel{(a)}{\leq} \mathbb{P}_{\mathcal{C}} \left(\|D_{\mathcal{C}} - D_{\mathcal{P}}^{\otimes n}\|_{\text{tr}} - \mathbb{E}_{\mathcal{C}} \|D_{\mathcal{C}} - D_{\mathcal{P}}^{\otimes n}\|_{\text{tr}} \geq \exp(-\gamma_1 n) - \exp(-\gamma n) \right) \\ &= \mathbb{P}_{\mathcal{C}} \left(\|D_{\mathcal{C}} - D_{\mathcal{P}}^{\otimes n}\|_{\text{tr}} - \mathbb{E}_{\mathcal{C}} \|D_{\mathcal{C}} - D_{\mathcal{P}}^{\otimes n}\|_{\text{tr}} \geq \exp(-\gamma_1 n)(1 - \exp(-(\gamma - \gamma_1)n)) \right) \\ &\stackrel{(88)}{\leq} \mathbb{P}_{\mathcal{C}} \left(\|D_{\mathcal{C}} - D_{\mathcal{P}}^{\otimes n}\|_{\text{tr}} - \mathbb{E}_{\mathcal{C}} \|D_{\mathcal{C}} - D_{\mathcal{P}}^{\otimes n}\|_{\text{tr}} \geq \exp(-\beta n) \right) \\ &\stackrel{(b)}{\leq} \exp\left(-\frac{\exp(-2\beta n)}{2M^{-1}}\right) \\ &\leq \exp\left(-\frac{1}{2} \exp((R - 2\beta)n)\right) \\ &\stackrel{(88)}{\leq} \exp(-\exp(\gamma_2 n)), \end{aligned}$$

where (a) is the application of Theorem 3 and (b) the application of Theorem 5. □

Proof of Corollary 2. Choose $\gamma_1 \in (0, \gamma)$ and $\gamma_2 := \gamma - \gamma_1$, where γ is from the statement of Theorem 4. Then

$$\begin{aligned} \mathbb{P}_{\mathcal{C}} \left(\frac{1}{M} \sum_{m=1}^M \text{tr}(D^n(m)(\mathbf{1} - Y_m)) \geq \exp(-n\gamma_1) \right) &\stackrel{(a)}{\leq} \mathbb{E}_{\mathcal{C}} \left(\frac{1}{M} \sum_{m=1}^M \text{tr}(D^n(m)(\mathbf{1} - Y_m)) \right) \exp(n\gamma_1) \\ &\stackrel{(b)}{\leq} \exp(-n(\gamma - \gamma_1)) \\ &= \exp(-n\gamma_2), \end{aligned}$$

where (a) is by Markov's inequality and (b) by Theorem 4. □

E. Cost constraint

In this section, we extend Corollaries 1 and 2 to a cost-constrained version $\mathcal{C}_{c,C}$ of the codebook \mathcal{C} , where (c, C) is an additive cost constraint compatible with the input distribution P chosen for the generation of \mathcal{C} .

As long as there exists at least one $x^n \in \mathcal{X}^n$ which satisfies the cost constraint (which is always the case if there is an input distribution compatible with the cost constraint), we can (given any codebook \mathcal{C}) define the *cost-constrained codebook* $\mathcal{C}_{c,C}$ via

$$\mathcal{C}_{c,C}(m) = \begin{cases} \mathcal{C}(m), & \mathcal{C}(m) \text{ satisfies the cost constraint } (c, C), \\ x^n, & \text{otherwise.} \end{cases}$$

We define a set of *bad codeword indices*

$$\mathbb{B} := \{m \in \{1, \dots, M\} : \mathcal{C}(m) \neq \mathcal{C}_{c,C}(m)\}.$$

By [51, Lemma 8], we have (after P is fixed) $\beta_1, \beta_2 \in (0, \infty)$ such that for sufficiently large n ,

$$\mathbb{P}_{\mathcal{C}}(|\mathbb{B}| > M \exp(-n\beta_1)) \leq \exp(-\exp(n\beta_2)). \quad (89)$$

Corollary 3. *Make the same assumptions as in Theorem 3, and let (c, C) be an additive cost constraint which is compatible with the input distribution P and induces the cost-constrained random codebook $\mathcal{C}_{c,C}$.*

Then, there are $\gamma_1, \gamma_2 \in (0, \infty)$ such that, for sufficiently large n ,

$$\mathbb{P}_{\mathcal{C}}(\|D_{\mathcal{C}_{c,C}} - D_P^{\otimes n}\|_{\text{tr}} \geq \exp(-\gamma_1 n)) \leq \exp(-\exp(\gamma_2 n)).$$

Proof. We will bound $\|D_{\mathcal{C}} - D_{\mathcal{C}_{c,C}}\|_{\text{tr}}$ in such a way that this corollary follows as an immediate consequence of Corollary 1.

To this end, we fix $\beta_1, \beta_2 \in (0, \infty)$ such that (89) holds. By Corollary 1, we can also fix some $\gamma'_1, \gamma'_2 \in (0, \infty)$ which satisfy (86). Further, we fix choices of

$$\gamma_1 \in (0, \min(\beta_1, \gamma'_1)) \quad (90)$$

$$\gamma_2 \in (0, \min(\beta_2, \gamma'_2)). \quad (91)$$

Conditioned on the event $|\mathbb{B}| \leq M \exp(-n\beta_1)$, we have almost surely

$$\begin{aligned} \|D_{\mathcal{C}} - D_{\mathcal{C}_{c,C}}\|_{\text{tr}} &= \left\| \frac{1}{M} \sum_{m \in \mathbb{B}} \left(D^n(\mathcal{C}(m)) - D^n(\mathcal{C}_{c,C}(m)) \right) \right\|_{\text{tr}} \\ &\stackrel{(a)}{\leq} \frac{1}{M} \sum_{m \in \mathbb{B}} (\|D^n(\mathcal{C}(m))\|_{\text{tr}} + \|D^n(\mathcal{C}_{c,C}(m))\|_{\text{tr}}) \\ &= \frac{2|\mathbb{B}|}{M} \\ &\leq 2 \exp(-n\beta_1), \end{aligned} \quad (92)$$

where step (a) is due to the triangle inequality. We obtain, for sufficiently large n ,

$$\begin{aligned} \mathbb{P}_{\mathcal{C}}(\|D_{\mathcal{C}_{c,C}} - D_P^{\otimes n}\|_{\text{tr}} \geq \exp(-\gamma_1 n)) &\stackrel{(a)}{\leq} \mathbb{P}_{\mathcal{C}}(\|D_{\mathcal{C}_{c,C}} - D_{\mathcal{C}}\|_{\text{tr}} + \|D_{\mathcal{C}} - D_P^{\otimes n}\|_{\text{tr}} \geq \exp(-\gamma_1 n)) \\ &\stackrel{(b)}{\leq} \mathbb{P}_{\mathcal{C}}(\|D_{\mathcal{C}_{c,C}} - D_{\mathcal{C}}\|_{\text{tr}} > 2 \exp(-n\beta_1)) + \mathbb{P}_{\mathcal{C}}(\|D_{\mathcal{C}} - D_P^{\otimes n}\|_{\text{tr}} \geq \exp(-n\gamma'_1)) \\ &\stackrel{(92)}{\leq} \mathbb{P}_{\mathcal{C}}(|\mathbb{B}| > M \exp(-n\beta_1)) + \mathbb{P}_{\mathcal{C}}(\|D_{\mathcal{C}} - D_P^{\otimes n}\|_{\text{tr}} \geq \exp(-n\gamma'_1)) \\ &\stackrel{(89),(86)}{\leq} \exp(-\exp(n\beta_2)) + \exp(-\exp(n\gamma'_2)) \\ &\stackrel{(c)}{\leq} \exp(-\exp(\gamma_2 n)), \end{aligned}$$

where (a) is due to the triangle inequality, (b) is by the union bound and the choice of γ_1 , and (c) is by the choice of γ_2 . \square

The following lemma is intended to bound the increase of the decoding error that results from transitioning from the standard random codebook to its cost-constrained version. It is phrased in such a way that it is equally applicable to the decoding error (6) of the classical channel and the decoding error (7) of the cq channel.

Lemma 14. *Let $\varepsilon_{\mathcal{C}} : \{1, \dots, M\} \rightarrow [0, 1]$ be a map which depends on \mathcal{C} in such a way that each $\varepsilon_{\mathcal{C}}(m)$ is measurable as a function of \mathcal{C} , let \mathfrak{M} be a random variable uniform in $\{1, \dots, M\}$, and assume that there are $\gamma_1, \gamma_2 \in (0, \infty)$ such that for sufficiently large n ,*

$$\mathbb{P}_{\mathcal{C}}(\mathbb{E}_{\mathfrak{M}} \varepsilon_{\mathcal{C}}(\mathfrak{M}) > \exp(-n\gamma_1)) \leq \exp(-n\gamma_2). \quad (93)$$

Define

$$\varepsilon_{\mathcal{C},c} : \{1, \dots, M\} \rightarrow [0, 1], \quad m \mapsto \begin{cases} \varepsilon_{\mathcal{C}}(m), & \mathcal{C}_{c,C}(m) = \mathcal{C}(m) \\ 1, & \text{otherwise.} \end{cases}$$

Then, there are $\gamma_3, \gamma_4 \in (0, \infty)$ such that for sufficiently large n ,

$$\mathbb{P}_{\mathcal{C}}(\mathbb{E}_{\mathfrak{M}} \varepsilon_{\mathcal{C},c}(\mathfrak{M}) \geq \exp(-n\gamma_3)) \leq \exp(-n\gamma_4).$$

Proof. We fix $\beta_1, \beta_2 \in (0, \infty)$ such that (89) holds, and we fix $\gamma_3 \in (0, \min(\beta_1, \gamma_1))$, along with $\gamma_4 \in (0, \gamma_2)$. Then

$$\begin{aligned} & \mathbb{P}_{\mathcal{C}}(\mathbb{E}_{\mathfrak{M}} \varepsilon_{\mathcal{C},c}(\mathfrak{M}) \geq \exp(-n\gamma_3)) \\ & \stackrel{(a)}{\leq} \mathbb{P}_{\mathcal{C}}(\mathbb{E}_{\mathfrak{M}} \varepsilon_{\mathcal{C},c}(\mathfrak{M}) \geq \exp(-n\gamma_3) \mid |\mathbb{B}| \leq M \exp(-n\beta_1)) + \mathbb{P}(|\mathbb{B}| > M \exp(-n\beta_1)) \\ & \stackrel{(b)}{\leq} \mathbb{P}_{\mathcal{C}}\left(\mathbb{E}_{\mathfrak{M}} \varepsilon_{\mathcal{C}}(\mathfrak{M}) + \frac{|\mathbb{B}|}{M} \geq \exp(-n\gamma_3) \mid |\mathbb{B}| \leq M \exp(-n\beta_1)\right) + \mathbb{P}(|\mathbb{B}| > M \exp(-n\beta_1)) \\ & \stackrel{(a)}{\leq} \frac{\mathbb{P}_{\mathcal{C}}(\mathbb{E}_{\mathfrak{M}} \varepsilon_{\mathcal{C}}(\mathfrak{M}) + \exp(-n\beta_1) \geq \exp(-n\gamma_3))}{\mathbb{P}(|\mathbb{B}| \leq M \exp(-n\beta_1))} + \mathbb{P}(|\mathbb{B}| > M \exp(-n\beta_1)) \\ & \stackrel{(89)}{\leq} \frac{\mathbb{P}_{\mathcal{C}}(\mathbb{E}_{\mathfrak{M}} \varepsilon_{\mathcal{C}}(\mathfrak{M}) + \exp(-n\beta_1) \geq \exp(-n\gamma_3))}{1 - \exp(-\exp(n\beta_2))} + \exp(-\exp(n\beta_2)) \\ & = \frac{\mathbb{P}_{\mathcal{C}}(\mathbb{E}_{\mathfrak{M}} \varepsilon_{\mathcal{C}}(\mathfrak{M}) \geq \exp(-n\gamma_3)(1 - \exp(-n(\beta_1 - \gamma_3)))}{1 - \exp(-\exp(n\beta_2))} + \exp(-\exp(n\beta_2)) \\ & \stackrel{(c)}{\leq} \frac{\mathbb{P}_{\mathcal{C}}(\mathbb{E}_{\mathfrak{M}} \varepsilon_{\mathcal{C}}(\mathfrak{M}) \geq \exp(-n\gamma_1))}{1 - \exp(-\exp(n\beta_2))} + \exp(-\exp(n\beta_2)) \\ & \stackrel{(93)}{\leq} \frac{\exp(-n\gamma_2)}{1 - \exp(-\exp(n\beta_2))} + \exp(-\exp(n\beta_2)) \\ & \stackrel{(d)}{\leq} \exp(-n\gamma_4), \end{aligned}$$

where both steps labeled (a) are due to the law of total probability, (b) is by the definition of $\varepsilon_{\mathcal{C},c}$, (c) follows for sufficiently large n from the choice of γ_3 , and (d) from the choice of γ_4 . \square

F. Proof of Theorem 1 and Theorem 2

We now have everything needed to prove the main results of this paper.

Proof of Theorem 1. We have $R < I(P, W) - \chi(P; D_{\mathfrak{E}})$. This allows us to fix $\tilde{R} \in (\chi(P; D_{\mathfrak{E}}), I(P, W) - R)$, and, subsequently, $\hat{R} \in (R + \tilde{R}, I(P, W))$. For sufficiently large n , this then allows us to fix $M, L \in \mathbb{N}$ satisfying

$$M \geq \exp(n\tilde{R}) \tag{94}$$

$$ML \leq \exp(n\hat{R}) \tag{95}$$

$$L \geq \exp(nR). \tag{96}$$

a) *Codebook generation:* We generate a wiretap codebook $\mathcal{C} := (\mathcal{C}_1, \dots, \mathcal{C}_L)$ which is an L -tuple of i.i.d. standard random codebooks drawn according to P . We also define the associated cost-constrained wiretap codebook $\mathcal{C}_{c,C} = (\mathcal{C}_{1,c,C}, \dots, \mathcal{C}_{L,c,C})$.

b) *Encoding procedure:* Let $\mathfrak{M} \in \{1, \dots, L\}$. In order to generate the corresponding output of Enc, we draw a random number $m \in \{1, \dots, M\}$ and output $\mathcal{C}_{\mathfrak{M},c,C}(m)$. Note that (96) ensures that our code has a rate of at least R .

c) *Decoding procedure:* We use a joint typicality decoder; i.e., Dec outputs $\hat{\mathfrak{M}}$ if there is $m \in \{1, \dots, M\}$ such that $\mathcal{C}_{\hat{\mathfrak{M}}}(m)$ is jointly typical with \hat{X}^n and $\hat{\mathfrak{M}}, m$ are unique with this property. If no such $\hat{\mathfrak{M}}, m$ exist, the decoder outputs 1. The definition of typicality we use is in terms of information density (cf. [52, Def. 4.34]). Let

$$\varepsilon_{\mathcal{C}} : \{1, \dots, L\} \times \{1, \dots, M\} \rightarrow [0, 1], \quad (\ell, m) \mapsto \mathbb{P}(\hat{\mathfrak{M}} \neq \ell \mid X^n = \mathcal{C}_{\ell}(m)).$$

Let us first look at the average decoding error of an alternative encoder Enc' which draws a random number $m \in \{1, \dots, M\}$ and outputs $\mathcal{C}_{\mathfrak{M}}(m)$ to transmit message \mathfrak{M} . The average decoding error in case Enc' is used can be expressed as

$$\frac{1}{LM} \sum_{\ell=1}^L \sum_{m=1}^M \varepsilon_{\mathcal{C}}(\ell, m),$$

and so (95) ensures that by [52, Lemma 4.37], we can fix $\beta_1, \beta_2 \in (0, \infty)$ with the property that for sufficiently large n ,

$$\mathbb{P}_{\mathcal{C}}\left(\frac{1}{LM} \sum_{\ell=1}^L \sum_{m=1}^M \varepsilon_{\mathcal{C}}(\ell, m) \geq \exp(-n\beta_1)\right) \leq \exp(-n\beta_2).$$

Let $\varepsilon_{\mathcal{C}_{c,C}}$ be as defined in the statement of Lemma 14. It follows that there are $\gamma_1, \beta_3 \in (0, \infty)$ such that for sufficiently large n ,

$$\mathbb{P}_{\mathcal{C}} \left(\frac{1}{LM} \sum_{\ell=1}^L \sum_{m=1}^M \varepsilon_{\mathcal{C}_{c,C}}(\ell, m) \geq \exp(-n\gamma_1) \right) \leq \exp(-n\beta_3).$$

This bounds the probability that the average decoding error in case Enc is used at the transmitter exceeds $\exp(-n\gamma_1)$.

d) Distinguishing security level: We first note that by passing \mathfrak{M} through Enc and $D_{\mathfrak{E}}^n$, we obtain the density operator $D_{\mathfrak{E}, \mathcal{C}_{\ell,c,C}}$. Let us assume that we have for every $\ell \in \{1, \dots, L\}$

$$\left\| D_{\mathfrak{E}, \mathcal{C}_{\ell,c,C}} - D_{\mathfrak{E}, P}^{\otimes n} \right\|_{\text{tr}} \leq \frac{1}{2} \exp(-\gamma_2 n). \quad (97)$$

The triangle inequality then yields, for all ℓ_1, ℓ_2 ,

$$\begin{aligned} \left\| D_{\mathfrak{E}, \mathcal{C}_{\ell_1,c,C}} - D_{\mathfrak{E}, \mathcal{C}_{\ell_2,c,C}} \right\|_{\text{tr}} &\leq \left\| D_{\mathfrak{E}, \mathcal{C}_{\ell_1,c,C}} - D_{\mathfrak{E}, P}^{\otimes n} \right\|_{\text{tr}} + \left\| D_{\mathfrak{E}, \mathcal{C}_{\ell_2,c,C}} - D_{\mathfrak{E}, P}^{\otimes n} \right\|_{\text{tr}} \\ &\stackrel{(97)}{\leq} \exp(-\gamma_2 n), \end{aligned} \quad (98)$$

which means that our wiretap code has distinguishing security level $\exp(-n\gamma_2)$.

So it remains to calculate the probability that (97) is not true for all ℓ . By Corollary 3, we can find $\gamma_2, \beta_4 \in (0, \infty)$ such that for sufficiently large n , we have for every $\ell \in \{1, \dots, L\}$

$$\mathbb{P}_{\mathcal{C}} \left(\left\| D_{\mathcal{C}_{\ell,c,C}} - D_P^{\otimes n} \right\|_{\text{tr}} \geq \frac{1}{2} \exp(-\gamma_2 n) \right) \leq \exp(-\exp(\beta_4 n)). \quad (99)$$

With this, we calculate

$$\begin{aligned} &\mathbb{P}_{\mathcal{C}} \left(\exists \ell \in \{1, \dots, L\} \left\| D_{\mathcal{C}_{\ell,c,C}} - D_P^{\otimes n} \right\|_{\text{tr}} \geq \frac{1}{2} \exp(-\gamma_2 n) \right) \\ &\stackrel{(a)}{\leq} \sum_{\ell=1}^L \mathbb{P}_{\mathcal{C}} \left(\left\| D_{\mathcal{C}_{\ell,c,C}} - D_P^{\otimes n} \right\|_{\text{tr}} \geq \frac{1}{2} \exp(-\gamma_2 n) \right) \\ &\stackrel{(99)}{\leq} L \exp(-\exp(n\beta_4)) \\ &\stackrel{(94),(95)}{\leq} \exp(n(\hat{R} - \tilde{R}) - \exp(n\beta_4)), \end{aligned} \quad (100)$$

where step (a) is by the union bound.

In conclusion, if n is sufficiently large so that $\exp(-n\beta_3) + \exp(n(\hat{R} - \tilde{R}) - \exp(n\beta_4)) < 1$ and all bounds derived above hold, the existence of a wiretap code as claimed in the theorem statement is assured. \square

Proof of Theorem 2. We have $R < \chi(P; D_{\mathfrak{B}}) - \chi(P; D_{\mathfrak{E}})$. This allows us to fix $\tilde{R} \in (\chi(P; D_{\mathfrak{E}}), \chi(P; D_{\mathfrak{B}}) - R)$, and, subsequently, $\hat{R} \in (R + \tilde{R}, \chi(P; D_{\mathfrak{B}}))$. For sufficiently large n , this then allows us to fix $M, L \in \mathbb{N}$ satisfying (94), (95), and (96).

a) Codebook generation: See proof of Theorem 1.

b) Encoding procedure: See proof of Theorem 1.

c) Decoding procedure: We treat the wiretap codebook \mathcal{C} as one large codebook $\tilde{\mathcal{C}}$ of size LM defined by $\tilde{\mathcal{C}}(\ell, m) := \mathcal{C}_{\ell}(m)$. Together with (95), this allows us to invoke Theorem 4 to obtain a decoding POVM $(Y_{\ell,m})_{\ell,m=1}^{L,M}$ for the codebook $\tilde{\mathcal{C}}$. Define a corresponding decoding POVM $(Y_{\ell})_{\ell=1}^L$ for the wiretap channel by

$$Y_{\ell} := \sum_{m=1}^M Y_{\ell,m}.$$

Let

$$\varepsilon_{\mathcal{C}} : \{1, \dots, L\} \times \{1, \dots, M\} \rightarrow [0, 1], \quad (\ell, m) \mapsto \text{tr} \left(D_{\mathfrak{B}}^n(\mathcal{C}_{\ell}(m))(\mathbf{1} - Y_{\ell,m}) \right).$$

Then Corollary 2 assures that there are $\beta_1, \beta_2 \in (0, \infty)$ such that for sufficiently large n ,

$$\mathbb{P}_{\mathcal{C}} \left(\frac{1}{LM} \sum_{\ell=1}^L \sum_{m=1}^M \varepsilon_{\mathcal{C}}(\ell, m) \geq \exp(-n\beta_1) \right) \leq \exp(-n\beta_2).$$

As in the classical case, we let $\varepsilon_{\mathcal{C}_{c,C}}$ be as defined in the statement of Lemma 14. It follows that there are $\gamma_1, \beta_3 \in (0, \infty)$ such that for sufficiently large n ,

$$\mathbb{P}_{\mathcal{C}} \left(\frac{1}{LM} \sum_{\ell=1}^L \sum_{m=1}^M \varepsilon_{\mathcal{C}_{c,C}}(\ell, m) \geq \exp(-n\gamma_1) \right) \leq \exp(-n\beta_3).$$

Now, we can bound the decoding error as

$$\begin{aligned}
& \mathbb{P}_{\mathcal{C}} \left(\frac{1}{L} \sum_{\ell=1}^L \text{tr} \left(\frac{1}{M} \sum_{m=1}^M D_{\mathfrak{B}}(\mathcal{C}_{\ell,c,C}(m))(\mathbf{1} - Y_{\ell}) \right) \geq \exp(-n\gamma_1) \right) \\
& \leq \mathbb{P}_{\mathcal{C}} \left(\frac{1}{LM} \sum_{\ell=1}^L \sum_{m=1}^M \text{tr} (D_{\mathfrak{B}}(\mathcal{C}_{\ell,c,C}(m))(\mathbf{1} - Y_{\ell,m})) \geq \exp(-n\gamma_1) \right) \\
& \leq \mathbb{P}_{\mathcal{C}} \left(\frac{1}{LM} \sum_{\ell=1}^L \sum_{m=1}^M \varepsilon_{\mathcal{C}_{\ell,c,C}}(\ell, m) \geq \exp(-n\gamma_1) \right) \\
& \leq \exp(-n\beta_3).
\end{aligned}$$

d) *Distinguishing security level*: See proof of Theorem 1.

Similarly as in the proof of Theorem 1, the existence of a wiretap code as claimed in the theorem statement is assured for sufficiently large n . \square

VI. SPECIALIZATION TO THE GAUSSIAN CQ WIRETAP CHANNEL

Theorem 2 states that the security level and decoding error exhibit exponential decay. However, unspecified constants γ_1, γ_2 appear in the exponents and in particular, the theorem does not tell us what happens at values of n that are not sufficiently large for the exponential bounds to hold. We have opted to formulate Theorem 2 in this way to keep the statement as simple as possible. But the proofs of Theorems 3 and 4 are written up in such a way that the unspecified constants and the ‘‘sufficiently large’’ condition only appear in the very last step. These Theorems give bounds on the expected decoding error and security level of a standard random codebook, and are the two main building blocks that go into the proof of Theorem 2. For a given channel, it is therefore not hard to unpack these proofs far enough to be able to numerically calculate bounds for the decoding error and the security level at finite block lengths.

In this section, we demonstrate this on the example of the Gaussian c/q wiretap channel. We only give a sketch of how to do this in the rest of this section, but the full annotated Python source code that reproduces the plots in Figures 4, 5 and 6 is available as an electronic supplement with this paper.

A. The Gaussian cq Channel

In the following, we introduce the Gaussian cq channel along with some properties that we need in this section. For more details, we refer the reader to [35, Section 12.1].

Let $\mathcal{H} := L^2(\mathbb{R})$ be the complex Hilbert space of equivalence classes of complex-valued, square integrable functions on \mathbb{R} . For $k = 0, 1, \dots$, let $|k\rangle$ be the number state vector defined in [35, eq. (12.17)]. Here, it will only be important that $|0\rangle, |1\rangle, \dots$ form an orthonormal basis of \mathcal{H} . For every $\zeta \in \mathbb{C}$, we define a *coherent state vector* (see [35, eq. before (12.18) and eq. before (12.21)])

$$|\zeta\rangle := \exp\left(-\frac{|\zeta|^2}{2}\right) \sum_{k=0}^{\infty} \frac{\zeta^k}{\sqrt{k!}} |k\rangle. \quad (101)$$

The Gaussian cq channel is then defined (cf. [35, eq. (12.28)]) as

$$D^{(\eta,N)} : \mathbb{C} \rightarrow \mathcal{S}(\mathcal{H}), \quad x \mapsto \frac{1}{\pi N} \int_{\mathbb{C}} |\zeta\rangle \langle \zeta| \exp\left(-\frac{|\zeta - \sqrt{\eta}x|^2}{N}\right) d\zeta. \quad (102)$$

It is parametrized by the *noise power* $N > 0$, and the *transmittivity* $\eta \in [0, 1]$. With $\eta = 1$, this is the same definition as in [35, eq. (12.28)]. In the following, we summarize some properties of this channel that we need in this section. They are derived in [35] for the case $\eta = 1$, but they carry over because $D^{(\eta,N)}(x) = D^{(1,N)}(\sqrt{\eta}x)$. For every $x \in \mathbb{C}$, there is [35, eq. (12.30)] a unitary *displacement operator* U_x such that

$$D^{(1,N)}(x) = U_x D^{(1,N)}(0) U_x^*, \quad (103)$$

and hence

$$D^{(\eta,N)}(x) = D^{(1,N)}(\sqrt{\eta}x) = U_{\sqrt{\eta}x} D^{(1,N)}(0) U_{\sqrt{\eta}x}^* = U_{\sqrt{\eta}x} D^{(\eta,N)}(0) U_{\sqrt{\eta}x}^*. \quad (104)$$

$D^{(\eta,N)}(0) = D^{(1,N)}(0)$ can be written as [35, eq. (12.24)]

$$D^{(\eta,N)}(0) = \frac{1}{N+1} \sum_{k=0}^{\infty} \left(\frac{N}{N+1}\right)^k |k\rangle \langle k|. \quad (105)$$

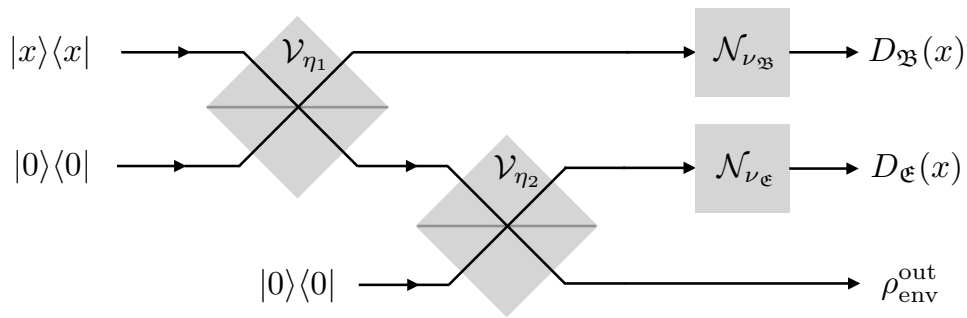

Fig. 3: The cascaded channel model consisting of two beam splitters followed by additive thermal noise channels acting on the signals that are arriving at the legitimate receiver and eavesdropper respectively which is used for the numerical evaluation of the theoretical bounds. Both beam splitters are assumed noiseless which is reflected by the presence of the vacuum state $|0\rangle\langle 0|$ at the second input of both devices. The third output is the state $\rho_{\text{env}}^{\text{out}}$ of photons detected neither by the legitimate receiver nor the eavesdropper.

This state has the von Neumann entropy [35, eq. (12.26)]

$$H\left(D^{(\eta, N)}(0)\right) = g(N), \quad (106)$$

where

$$g : [0, \infty) \rightarrow [0, \infty), \quad t \mapsto \begin{cases} (t+1) \log(t+1) - t \log t, & t > 0, \\ 0, & t = 0 \end{cases} \quad (107)$$

is called the *Gordon function*.

A consequence of (104) and (105) is that for every $f : \mathbb{R} \rightarrow \mathbb{R}$ and every $x \in \mathbb{C}$, we have

$$\begin{aligned} \text{tr}f\left(D^{(\eta, N)}(x)\right) &\stackrel{(104)}{=} \text{tr}f\left(U_{\sqrt{\eta}x} D^{(\eta, N)}(0) U_{\sqrt{\eta}x}^*\right) \\ &\stackrel{(105)}{=} \text{tr}f\left(\frac{1}{N+1} \sum_{k=0}^{\infty} \left(\frac{N}{N+1}\right)^k U_{\sqrt{\eta}x} |k\rangle \langle k| U_{\sqrt{\eta}x}^*\right) \\ &\stackrel{(a)}{=} \text{tr}f\left(\frac{1}{N+1} \sum_{k=0}^{\infty} \left(\frac{N}{N+1}\right)^k |k\rangle \langle k|\right) \\ &\stackrel{(105)}{=} \text{tr}f\left(D^{(\eta, N)}(0)\right), \end{aligned} \quad (108)$$

where step (a) is due to the fact that both $|0\rangle, |1\rangle, \dots$ and $U_{\sqrt{\eta}x}|0\rangle, U_{\sqrt{\eta}x}|1\rangle, \dots$ are orthonormal bases of \mathcal{H} .

As the input distribution P , we choose a complex Gaussian distribution where real and imaginary part are independent with mean 0 and variance $E/2$, and E is the average energy per channel use. In order to relate this to the case $\eta = 1$, we also define an auxiliary input distribution P_{η} which is complex Gaussian with mean 0 and variance $\eta E/2$ per complex component. With this choice, we have [35, eq. 12.41]

$$D_P^{(\eta, N)} = D_{P_{\eta}}^{(1, N)} = \frac{1}{N + \eta E + 1} \sum_{k=1}^{\infty} \left(\frac{N + \eta E}{N + \eta E + 1}\right)^k |k\rangle \langle k|. \quad (109)$$

In this section, we consider a c/qw wiretap channel where $D_{\mathfrak{B}} = D^{(\eta_{\mathfrak{B}}, N_{\mathfrak{B}})}$ and $D_{\mathfrak{E}} = D^{(\eta_{\mathfrak{E}}, N_{\mathfrak{E}})}$.

B. Physical Channel Model

In the following, we describe a commonly employed channel model of physical systems [23], [53] that is a special case of the Gaussian c/qw wiretap channel ($D_{\mathfrak{B}}, D_{\mathfrak{E}}$) introduced in Section VI-A. It uses a quantum channel \mathcal{V}_{η} called a *beam splitter* [54, Chapter 4.] with a parameter $\eta \in [0, 1]$ called *transmittivity*. Denoting by a^*, b^* and a, b the creation resp. annihilation operators on two copies $\mathcal{H}_{\mathfrak{A}}, \mathcal{H}'_{\mathfrak{A}}$ of the Hilbert space $\mathcal{H} = L^2(\mathbb{R})$, $\mathcal{V}_{\eta} : \mathcal{S}(\mathcal{H}_{\mathfrak{A}} \otimes \mathcal{H}'_{\mathfrak{A}}) \rightarrow \mathcal{S}(\mathcal{H}_{\mathfrak{A}} \otimes \mathcal{H}'_{\mathfrak{A}})$ is defined as

$$\mathcal{V}_{\eta}(\rho) := B_{\theta} \rho B_{\theta}^*,$$

where $\theta \in [0, \pi/2]$ is such that $\eta = \cos^2(\theta)$ and the unitary $B_{\theta} : \mathcal{H}_{\mathfrak{A}} \otimes \mathcal{H}'_{\mathfrak{A}} \rightarrow \mathcal{H}_{\mathfrak{A}} \otimes \mathcal{H}'_{\mathfrak{A}}$ is given by [54, eq. (4.16)]

$$B_{\theta} = \exp\{\theta(a^* \otimes b - a \otimes b^*)\}.$$

For every $x, x' \in \mathbb{C}$ and corresponding coherent state vectors $|x\rangle \in \mathcal{H}_{\mathfrak{A}}$ and $|x'\rangle \in \mathcal{H}'_{\mathfrak{A}}$, we have [54, eq. (4.28)]

$$\mathcal{V}_\eta (|x\rangle \langle x| \otimes |x'\rangle \langle x'|) = \left| \sqrt{\eta}x + \sqrt{\eta'}x' \right\rangle \left\langle \sqrt{\eta}x + \sqrt{\eta'}x' \right| \otimes \left| \sqrt{\eta'}x - \sqrt{\eta}x' \right\rangle \left\langle \sqrt{\eta'}x - \sqrt{\eta}x' \right|, \quad (110)$$

where $\eta' := 1 - \eta$. Moreover, we use an *additive thermal noise channel* $\mathcal{N}_N(\rho)$ which is described [53, eq. (3.48)] by

$$\mathcal{N}_N(\rho) = \frac{1}{\pi N} \int_{\mathbb{C}} U_\zeta \rho U_\zeta^* \exp\left(-\frac{|\zeta|^2}{N}\right) d\zeta,$$

where U_ζ are displacement operators and $\zeta \in \mathbb{C}$. For every coherent state $|\zeta\rangle \langle \zeta|$ and $N \in (0, \infty)$, it holds that

$$\mathcal{N}_N (|\zeta\rangle \langle \zeta|) = D^{(1,N)}(\zeta). \quad (111)$$

A bosonic wiretap model [23], [53] can be based on the assumption that every photon which is lost from the original signal can be detected by the eavesdropper. This is an extremely pessimistic model, not taking into account the photons which are detected neither by the legitimate receiver nor the eavesdropper due to channel loss. In contrast, we evaluate a channel model, depicted in Fig. 3, in which both the legitimate receiver and the eavesdropper are subject to channel loss. To this end, we consider Hilbert spaces $\mathcal{H}_{\mathfrak{A},1}$, $\mathcal{H}'_{\mathfrak{A},1}$, $\mathcal{H}_{\mathfrak{A},2}$, $\mathcal{H}'_{\mathfrak{A},2}$, $\mathcal{H}_{\mathfrak{B}}$, $\mathcal{H}_{\mathfrak{E}}$, and \mathcal{H}_{env} all of which are copies of $\mathcal{H} = L^2(\mathbb{R})$. Moreover, we choose transmissivity parameters $\eta_1, \eta_2 \in [0, 1]$.

In this model, the transmitter's channel alphabet is given as $\mathcal{X} := \mathbb{C}$. The transmission symbol $x \in \mathbb{C}$ is transformed into a coherent state $|x\rangle \langle x|$ with $|x\rangle \in \mathcal{H}_{\mathfrak{A},1}$ defined in (101). This state $|x\rangle \langle x|$ is passed to the first input of the beam splitter $\mathcal{V}_{\eta_1} : \mathcal{S}(\mathcal{H}_{\mathfrak{A},1} \otimes \mathcal{H}'_{\mathfrak{A},1}) \rightarrow \mathcal{S}(\mathcal{H}_{\mathfrak{A},1} \otimes \mathcal{H}'_{\mathfrak{A},1})$, where the second input of the beam splitter receives the vacuum state $|0\rangle \langle 0| \in \mathcal{S}(\mathcal{H}'_{\mathfrak{A},1})$. The first output is passed through $\mathcal{N}_{N_{\mathfrak{B}}} : \mathcal{S}(\mathcal{H}_{\mathfrak{A},1}) \rightarrow \mathcal{S}(\mathcal{H}_{\mathfrak{B}})$ to model the thermal noise at the legitimate receiver. The second output is passed through another beam splitter $\mathcal{V}_{\eta_2} : \mathcal{S}(\mathcal{H}_{\mathfrak{A},2} \otimes \mathcal{H}'_{\mathfrak{A},2}) \rightarrow \mathcal{S}(\mathcal{H}_{\mathfrak{A},2} \otimes \mathcal{H}'_{\mathfrak{A},2})$, again with the vacuum state $|0\rangle \langle 0| \in \mathcal{S}(\mathcal{H}'_{\mathfrak{A},2})$ at the second input. The eavesdropper receives a version of the first output of the beam splitter \mathcal{V}_{η_2} which is passed through $\mathcal{N}_{N_{\mathfrak{E}}} : \mathcal{S}(\mathcal{H}_{\mathfrak{A},2}) \rightarrow \mathcal{S}(\mathcal{H}_{\mathfrak{E}})$ to model the eavesdropper's thermal receiver noise. The remaining beam splitter output is considered an environment state which is received neither at the legitimate receiver nor at the eavesdropper. The joint quantum state at the legitimate receiver's channel output, the eavesdropper's channel output, and the environment channel output can thus be written as

$$\begin{aligned} & \left(\mathcal{N}_{N_{\mathfrak{B}}} \otimes \mathcal{N}_{N_{\mathfrak{E}}} \otimes \text{id}_{\mathcal{B}(\mathcal{H}'_{\mathfrak{A},2})} \right) \circ \left(\text{id}_{\mathcal{B}(\mathcal{H}_{\mathfrak{A},1})} \otimes \mathcal{V}_{\eta_2} \right) \left(\mathcal{V}_{\eta_1} (|x\rangle \langle x| \otimes |0\rangle \langle 0|) \otimes |0\rangle \langle 0| \right) \\ & \stackrel{(110)}{=} \left(\mathcal{N}_{N_{\mathfrak{B}}} \otimes \mathcal{N}_{N_{\mathfrak{E}}} \otimes \text{id}_{\mathcal{B}(\mathcal{H}'_{\mathfrak{A},2})} \right) \circ \left(\text{id}_{\mathcal{B}(\mathcal{H}_{\mathfrak{A},1})} \otimes \mathcal{V}_{\eta_2} \right) \left(|\sqrt{\eta_1}x\rangle \langle \sqrt{\eta_1}x| \otimes |\sqrt{\eta_1'}x\rangle \langle \sqrt{\eta_1'}x| \otimes |0\rangle \langle 0| \right) \\ & \stackrel{(110)}{=} \left(\mathcal{N}_{N_{\mathfrak{B}}} \otimes \mathcal{N}_{N_{\mathfrak{E}}} \otimes \text{id}_{\mathcal{B}(\mathcal{H}'_{\mathfrak{A},2})} \right) \left(|\sqrt{\eta_1}x\rangle \langle \sqrt{\eta_1}x| \otimes |\sqrt{\eta_2\eta_1'}x\rangle \langle \sqrt{\eta_2\eta_1'}x| \otimes |\sqrt{\eta_2'\eta_1'}x\rangle \langle \sqrt{\eta_2'\eta_1'}x| \right) \\ & \stackrel{(111)}{=} D^{(1,N_{\mathfrak{B}})}(\sqrt{\eta_1}x) \otimes D^{(1,N_{\mathfrak{E}})}(\sqrt{\eta_2\eta_1'}x) \otimes |\sqrt{\eta_2'\eta_1'}x\rangle \langle \sqrt{\eta_2'\eta_1'}x| \\ & = D^{(\eta_1, N_{\mathfrak{B}})}(x) \otimes D^{(\eta_2\eta_1', N_{\mathfrak{E}})}(x) \otimes |\sqrt{\eta_2'\eta_1'}x\rangle \langle \sqrt{\eta_2'\eta_1'}x|, \end{aligned}$$

where we have used $\eta_1' := 1 - \eta_1$, $\eta_2' := 1 - \eta_2$, and the identity maps $\text{id}_{\mathcal{B}(\mathcal{H}_{\mathfrak{A},1})}$ and $\text{id}_{\mathcal{B}(\mathcal{H}'_{\mathfrak{A},2})}$ on the spaces $\mathcal{B}(\mathcal{H}_{\mathfrak{A},1})$ and $\mathcal{B}(\mathcal{H}'_{\mathfrak{A},2})$.

Therefore, this system is a special case of the c/qw wiretap channel $D_{\mathfrak{B}} = D^{(\eta_{\mathfrak{B}}, N_{\mathfrak{B}})}$ and $D_{\mathfrak{E}} = D^{(\eta_{\mathfrak{E}}, N_{\mathfrak{E}})}$ described in Section VI-A where $\eta_{\mathfrak{B}} := \eta_1$ and $\eta_{\mathfrak{E}} := \eta_2(1 - \eta_1)$.

C. Numerical Evaluation of the Error Bounds in Theorems 3 and 4

In this subsection, we fix a channel $D^{(\eta, N)}$ and show how to compute the quantities $H_P, H_U, H_{P,\alpha}, H_{U,\alpha}$ and evaluate the error bounds of the resolvability and coding results for such a channel under a Gaussian input distribution with energy E as defined in Section VI-A.

The properties collected in Section VI-A allow us to calculate the quantities defined in (50) and (51) as

$$H_P \stackrel{(50)}{=} -\mathbb{E}_X \text{tr} \left(D^{(\eta, N)}(X) \log D^{(\eta, N)}(X) \right) \stackrel{(108)}{=} -\text{tr} \left(D^{(\eta, N)}(0) \log D^{(\eta, N)}(0) \right) \stackrel{(106)}{=} g(N) \quad (112)$$

$$H_U \stackrel{(51)}{=} H \left(D_P^{(\eta, N)} \right) \stackrel{(106), (109)}{=} g(N + \eta E). \quad (113)$$

Next, we use the convergence behavior of the geometric series to argue that for $\alpha \in (0, \infty)$,

$$\text{tr} \left(D^{(\eta, N)}(0)^\alpha \right) = \frac{1}{(N+1)^\alpha} \sum_{k=0}^{\infty} \left(\frac{N}{N+1} \right)^{\alpha k} = \frac{1}{(N+1)^\alpha (1 - N^\alpha / (N+1)^\alpha)} = \frac{1}{(N+1)^\alpha - N^\alpha} \quad (114)$$

With this, we can calculate the quantities defined in (62) and (63) as

$$H_{P,\alpha} \stackrel{(62)}{=} \frac{1}{1-\alpha} \log \mathbb{E}_X \left(\text{tr} \left(D^{(\eta,N)}(X)^\alpha \right) \right) \stackrel{(108)}{=} \frac{1}{1-\alpha} \log \text{tr} \left(D^{(\eta,N)}(0)^\alpha \right) \stackrel{(114)}{=} \frac{1}{\alpha-1} \log((N+1)^\alpha - N^\alpha) = g_\alpha(N) \quad (115)$$

$$H_{U,\alpha} \stackrel{(63)}{=} \frac{1}{1-\alpha} \log \text{tr} \left(\left(D_P^{(\eta,N)} \right)^\alpha \right) \stackrel{(109),(114)}{=} g_\alpha(N + \eta E), \quad (116)$$

where we use a modified version of the Gordon function

$$g_\alpha : [0, \infty) \rightarrow [0, \infty), \quad t \mapsto \frac{\log((t+1)^\alpha - t^\alpha)}{\alpha-1}. \quad (117)$$

From the considerations in Section V-A, we know that with the convention $g_1 := g$, the map $(0, \infty) \rightarrow (0, \infty), \alpha \mapsto g_\alpha(t)$ is continuous. We can also calculate the derivative

$$g'_\alpha(t) := \frac{\partial}{\partial \alpha} g_\alpha(t) = \frac{\frac{(t+1)^\alpha \log(t+1) - t^\alpha \log t}{(t+1)^\alpha - t^\alpha} - g_\alpha(t)}{\alpha-1}. \quad (118)$$

With this, it is possible to numerically evaluate the exponents that appear in (68) and (69) for any given values of $\varepsilon, \alpha_1, \alpha_2, \alpha_3, \alpha_4$ as well as their partial derivatives for $\alpha_1, \alpha_2, \alpha_3, \alpha_4$. Given a value of ε , it is therefore possible to find optimal values for these four parameters.

For the calculation of the error bound of Theorem 3, we look at (73). The first three summands are all upper bounded with the explicit bound given in (74), whereas the last summand is bounded using Lemma 9 and hence (68) and (69). This allows us to evaluate the error bound of Theorem 3 for given values of ε , so it only remains to find an optimal ε within the range (72).

For the calculation of the error bound of Theorem 4, we look at (84). The second term is bounded by (85) which is straightforward to evaluate given a value of ε , and the first term is again bounded using Lemma 9 which can be evaluated as in the case of Theorem 3. So it remains to find an optimal ε in the range (78).

D. Numerical Evaluation of the Error Bounds in Theorem 2

In Section VI-C, we have described a way to evaluate the expectation bounds for resolvability and decoding error for the random codebook ensemble. From this, it is not yet clear that energy-constrained wiretap codebooks exist that satisfy all of these bounds simultaneously. The argument we make in this subsection is that due to the doubly exponential error decay in Corollary 1 and (89), wiretap codebooks exist that realize the expectation bounds up to a negligibly small additional error. For the calculation of the error bounds of Theorem 2, we first find a way to evaluate them for a given value of \tilde{R} , and then optimize over all possible values of this number. The proof of Theorem 2 introduces a number $\hat{R} > R + \tilde{R}$. This is necessary since a codebook of block length n can only have rates of the form $\log(M)/n$ where $M \in \mathbb{N}$. However, this is not a significant numerical restriction even for moderate values of n . We therefore use $\hat{R} = R + \tilde{R}$ to avoid unnecessary complexity.

a) Concentration of the semantic security level: Let the wiretap codebook be $\mathcal{C} = (\mathcal{C}_1, \dots, \mathcal{C}_L)$ as described in the proof of Theorem 2. If all of $\mathcal{C}_1, \dots, \mathcal{C}_L$ satisfy a resolvability bound as in Theorem 3, then we have a connection to the distinguishing security level via the triangle inequality (98) and from there to the semantic security level via Lemma 1. For the concentration around the mean, we use the calculation at the end of the proof of Corollary 1 along with the union bound for the L different resolvability codebooks. For all data points we plot, we ensure that the probability in the random wiretap codebook construction that the resolvability error of one of the codebooks is more than 10^{-8} away from the expectation is less than $\exp(-100)$.

b) Additional error incurred by energy-constrained codebook: For this, we use the considerations in Section V-E, where we use the cost function $c(x) := |x|^2$ (corresponding to an input energy constraint) and the constraint $C := 1.1 \cdot E$, where E is the average energy of the channel input distribution P used for generation of the random codebook. We observe in the proofs of Corollary 3 and Lemma 14 that the additional error incurred in terms of resolvability and decoding is closely related to the cardinality of the set \mathbb{B} of bad codewords as a fraction of the size of the codebook. We can find an explicit version of (89) in the proof of [51, Lemma 8]. With this and the union bound, we ensure that for all plotted data points, the fraction $|\mathbb{B}|/M$ of bad codewords is smaller than 10^{-8} for all codebooks $\mathcal{C}_1, \dots, \mathcal{C}_L$ except for an error event with probability less than $\exp(-100)$. It is clear from the proofs in Section V-E that this ensures a negligible increase in decoding error and semantic security level when the energy-constrained codebooks are used.

c) Realization of the expected decoding error: Since we ensure that the probabilities of the error events discussed in the two preceding paragraphs are each smaller than $\exp(-100)$ and the decoding error is constrained in $[0, 1]$, it follows that wiretap codebooks must exist which realize a decoding error that is only negligibly larger than its expectation. We therefore neglect any additional such error in our numerical evaluations.

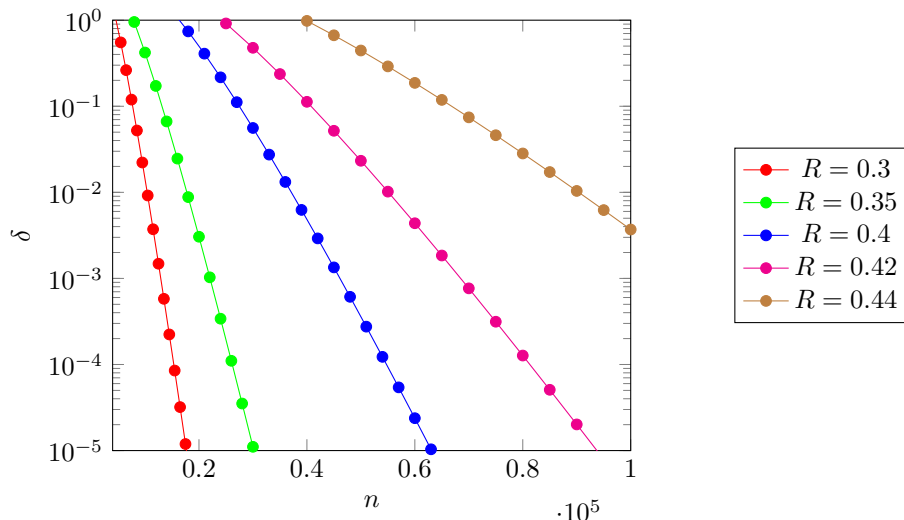

Fig. 4: Decay of semantic security level δ depending on the block length of the codebook for various rates R . The decoding error is fixed at $\varepsilon = 0.01$.

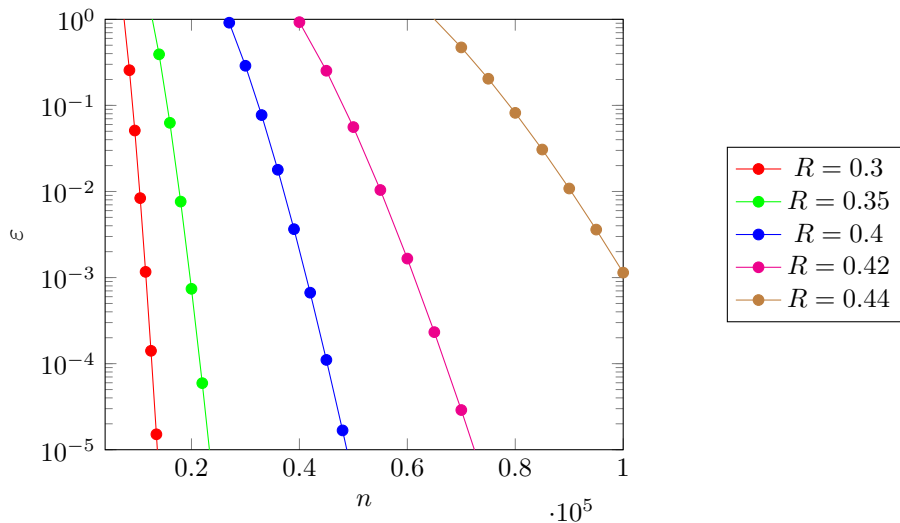

Fig. 5: Decay of decoding error probability ε depending on the block length of the codebook for various rates. The semantic security level is fixed at $\delta = 0.01$.

E. Plots

We plot various quantities of interest for a model of an optical communication system with a noiseless source as described in Section VI-B. In order to find reasonable system parameters, we make a series of rough estimates of what values these parameters may have in a realistic communication system. When a transmitter communicates a line of sight optical signal to a receiver, the transmittivity $\eta \in [0, 1]$ can be roughly estimated as

$$\eta = c \cdot \left(\frac{L_{\text{diam}}}{L_{\text{dist}}} \right)^2 \quad (119)$$

where c is a system-dependent constant, L_{diam} the receiver diameter and L_{dist} the distance between transmitter and receiver [55]. In slightly non-optimal situations where fog disturbs the link, this transmittivity in a free-space optical system can easily be as low as $\eta = 10^{-5}$ already at distances $L_{\text{dist}} = 1\text{km}$ [55]. For our plots, we choose $\eta_1 := 10^{-5}$ and $\eta_2 := 6 \cdot 10^{-6}$ to obtain a scenario in which the eavesdropper is at a slightly greater distance from the sender than the legitimate receiver, and otherwise uses equivalent equipment. For the average transmit energy, we note that the number of photons per channel use can be estimated by considering a laser with $1W$ output power at 1550nm . This system will emit in the order of 10^{19} photons per second, and typically use a modulation format such that 10^{10} pulses are emitted per second. Thus, $E := 10^9$ photons per channel use are a fair estimate. We assume that the number of noise photons per channel use is around 10^{-5} , which is at the lower end of the plausible range of values. At a wave length of 1550nm and a baud rate of 10^{10} pulses per

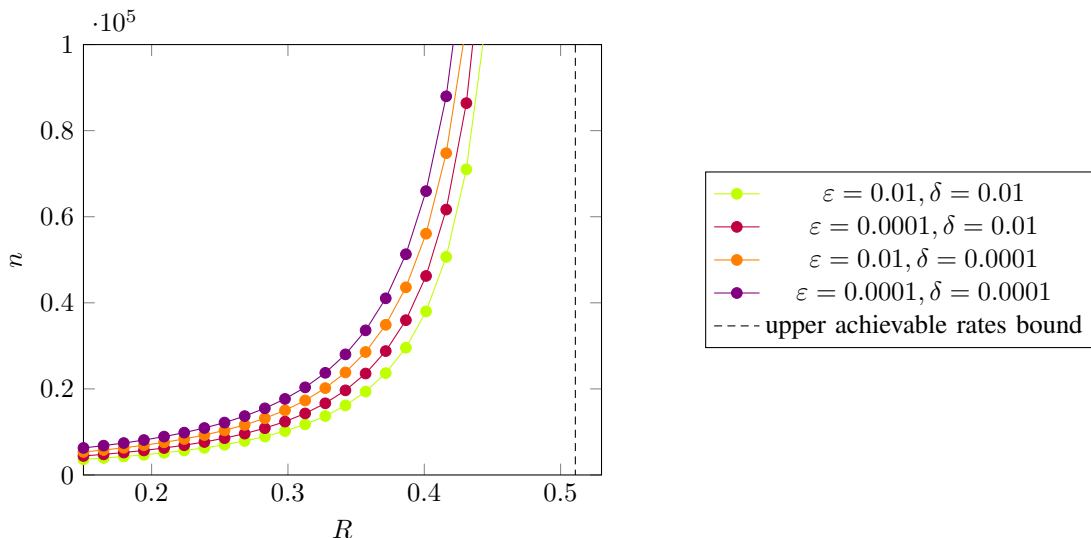

Fig. 6: Block length necessary to achieve a given decoding error ε , semantic security level δ and rate R .

second, this is equivalent to a background noise power of about $1.5 \cdot 10^{-14}W$. This means that in our example, we choose $N_{\mathfrak{B}} := N_{\mathfrak{E}} := 10^{-5}$.

This yields the system parameters $\eta_{\mathfrak{B}} = \eta_1 = 10^{-5}$, $\eta_{\mathfrak{E}} = \eta_2(1 - \eta_1) \approx 6 \cdot 10^{-6}$, $N_{\mathfrak{B}} = N_{\mathfrak{E}} = 10^{-5}$. By Theorem 2 and (112), (113), we obtain a bound

$$\chi(P; D_{\mathfrak{B}}) - \chi(P; D_{\mathfrak{E}}) = g(N_{\mathfrak{B}} + \eta_{\mathfrak{B}}E) - g(N_{\mathfrak{B}}) - g(N_{\mathfrak{E}} + \eta_{\mathfrak{E}}E) + g(N_{\mathfrak{E}}) \approx 0.5108$$

on the achievable rates. In Fig. 4 and 5, it can be seen how the security level and decoding error decay with increasing block length for various rates. As expected, the decay is always at least exponential, but the slope of the lines is steeper for larger gaps to the upper bound of achievable rates. In Fig. 6, we plot the block lengths necessary to achieve a few selected combinations of decoding error and security level in dependence of the rate. It can be seen that the necessary block length increases sharply when the rate gets close to the upper bound.

APPENDIX

Lemma 15. *The norms $\|\cdot\|_{\text{op}}$ on $\mathcal{B}(\mathcal{H})$ and $\|\cdot\|_{\text{tr}}$ on $\mathcal{T}(\mathcal{H})$ have the following properties:*

- 1) $\forall A \in \mathcal{T}(\mathcal{H}) : \|A\|_{\text{op}} \leq \|A\|_{\text{tr}}$
- 2) $\forall A_1 \in \mathcal{B}(\mathcal{H}), A_2 \in \mathcal{T}(\mathcal{H}), A_3 \in \mathcal{B}(\mathcal{H}) : A_1 A_2 A_3 \in \mathcal{T}(\mathcal{H}) \wedge \|A_1 A_2 A_3\|_{\text{tr}} \leq \|A_1\|_{\text{op}} \|A_2\|_{\text{tr}} \|A_3\|_{\text{op}}$
- 3) $\forall A_1, A_2 \in \mathcal{T}(\mathcal{H}) : \|A_1 A_2\|_{\text{tr}} \leq \|A_1\|_{\text{tr}} \|A_2\|_{\text{tr}}$
- 4) *The maps $\mathcal{T}(\mathcal{H}) \rightarrow \mathcal{K}(\mathcal{H})', A \mapsto \text{tr}(A \cdot)$ and $\mathcal{B}(\mathcal{H}) \rightarrow \mathcal{T}(\mathcal{H})', A \mapsto \text{tr}(A \cdot)$ are isometric isomorphisms. In particular,*

$$\forall A \in \mathcal{T}(\mathcal{H}) : \|A\|_{\text{tr}} = \sup \left\{ |\text{tr}(AB)| : B \in \mathcal{B}(\mathcal{H}) \wedge \|B\|_{\text{op}} \leq 1 \right\}.$$

- 5) *For any $\rho, \sigma \in \mathcal{S}(\mathcal{H})$, we have*

$$\|\rho - \sigma\|_{\text{tr}} = 2 \max \{ \text{tr}(B(\rho - \sigma)) : 0 \leq B \leq \mathbf{1} \}.$$

Since these are well-known facts, we provide references to textbooks in lieu of a proof: 1) follows from [56, Theorem III.4], 2) follows from [56, Lemma III.8(v)], 3) is immediate from 1) and 2), 4) is [31, Th. VI.26], and 5) is stated in [57, Lemma 9.1.7] for the finite-dimensional case, however, the proof also works for infinite-dimensional spaces without modification.

Lemma 16. *Let $\ell \in \mathbb{N}$. Then the map $\mathcal{T}(\mathcal{H})^\ell \rightarrow \mathcal{T}(\mathcal{H}), (A_1, \dots, A_\ell) \mapsto A_1 \circ \dots \circ A_\ell$ is continuous.*

Proof. The proof is by induction on ℓ . The case $\ell = 1$ is clear, and the case $\ell > 2$ follows by induction hypothesis and the case $\ell = 2$.

Hence, the only case left to prove is $\ell = 2$. Let $A_1, A_2 \in \mathcal{T}(\mathcal{H})$, and for all $i \in \{1, 2\}$, let $(A_i^{(j)})_{j \in \mathbb{N}}$ be a sequence with

$$\lim_{j \rightarrow \infty} \|A_i - A_i^{(j)}\|_{\text{tr}} = 0.$$

Then we use the triangle inequality and sub-multiplicativity of the trace norm in Lemma 15-3) to argue

$$\begin{aligned} \|A_1 A_2 - A_1^{(j)} A_2^{(j)}\|_{\text{tr}} &= \|A_1 A_2 - A_1^{(j)} A_2 + A_1^{(j)} A_2 - A_1^{(j)} A_2^{(j)}\|_{\text{tr}} \\ &\leq \|A_1 - A_1^{(j)}\|_{\text{tr}} \|A_2\|_{\text{tr}} + \|A_1^{(j)}\|_{\text{tr}} \|A_2 - A_2^{(j)}\|_{\text{tr}} \end{aligned}$$

Since the norm of a convergent sequence is upper bounded, we can apply the limit on both sides and obtain

$$\lim_{j \rightarrow \infty} \left\| A_1 A_2 - A_1^{(j)} A_2^{(j)} \right\|_{\text{tr}} = 0. \quad \square$$

Lemma 17. *Let $s \in (0, \infty)$, and let $D : \mathcal{X} \rightarrow \{A \in \mathcal{T}(\mathcal{H}) : 0 \leq A \leq s\mathbf{1}\}$ be measurable. Let $f : [0, s] \rightarrow \mathbb{R}$ be continuous with $f(0) = 0$, and assume that $f(D(x)) \in \mathcal{T}(\mathcal{H})$ for all $x \in \mathcal{X}$. Then $\mathcal{X} \rightarrow \mathcal{T}(\mathcal{H}), x \mapsto f(D(x))$ is measurable.*

A sufficient condition for $f(D(x)) \in \mathcal{T}(\mathcal{H})$ is that there is $c \in (0, s]$ with $f(t) = 0$ for all $t < c$.

Proof. We begin with the second part of the statement and show that if there is $c \in (0, s]$ with $f(t) = 0$ for all $t < c$, then $f(D(x)) \in \mathcal{T}(\mathcal{H})$ for all $x \in \mathcal{X}$. To this end, we apply the spectral theorem for self-adjoint trace class operators to write

$$f(D(x)) = \sum_{\ell=1}^{\infty} f(\lambda_{\ell}(x)) |e_{\ell}(x)\rangle \langle e_{\ell}(x)|,$$

where $(e_{\ell}(x))_{\ell \in \mathbb{N}}$ is a sequence of corresponding orthonormal eigenvectors and $(\lambda_{\ell}(x))_{\ell \in \mathbb{N}}$ is the non-increasing sequence of eigenvalues of $D(x)$ which contains all nonzero eigenvalues counted with multiplicity and converges to 0. For every x , we have $f(\lambda_{\ell}(x)) > 0$ for only finitely many ℓ , and thus $f(D(x)) \in \mathcal{T}(\mathcal{H})$.

Let us briefly outline the proof of the first part of the lemma statement. We will first prove that if $p : \mathbb{R} \rightarrow \mathbb{R}$ is a polynomial function with $p(0) = 0$,

$$\mathcal{X} \rightarrow \mathcal{T}(\mathcal{H}), x \mapsto p(D(x)) \text{ is measurable.} \quad (120)$$

Next, we will infer that

$$\forall h_1, h_2 \in \mathcal{H} : \mathcal{X} \rightarrow \mathbb{C}, x \mapsto \langle h_1, f(D(x))h_2 \rangle \text{ is measurable.} \quad (121)$$

Finally, we will use (121) to verify the criterion [58, Th. E.9] for measurability of operator valued functions.

For (120), we note that since $p(0) = 0$, we can write

$$p(D(x)) = \sum_{i=1}^{\ell} a_i D(x)^i.$$

Each summand is a composition of the measurable map $D^i : \mathcal{X} \rightarrow \mathcal{T}(\mathcal{H})^i, x \mapsto (D(x), \dots, D(x))$, and the product of operators which is continuous by Lemma 16. Both the trace class and the set of measurable functions are closed under finite summations, hence we obtain (120).

In order to prove (121), we apply the Weierstraß approximation theorem to obtain a sequence of polynomials $(p_i)_{i \in \mathbb{N}}$ with $p_i(0) = 0$ for every i and

$$\lim_{i \rightarrow \infty} \|f - p_i\|_{\infty} = 0,$$

where the difference is pointwise and p_i is implicitly identified with its restriction to $[0, s]$. By the continuity of the continuous functional calculus, this implies, for every x ,

$$\lim_{i \rightarrow \infty} \|f(D(x)) - p_i(D(x))\|_{\text{op}} = 0.$$

The map $\mathcal{B}(\mathcal{H}) \rightarrow \mathbb{C}, A \mapsto \langle h_1, Ah_2 \rangle$ is continuous, so it follows that

$$\lim_{i \rightarrow \infty} \langle h_1, p_i(D(x))h_2 \rangle = \langle h_1, f(D(x))h_2 \rangle. \quad (122)$$

Clearly, the identity map $\mathcal{T}(\mathcal{H}) \rightarrow \mathcal{B}(\mathcal{H})$ is also continuous and $\mathcal{X} \rightarrow \mathcal{T}(\mathcal{H}), x \mapsto p_i(D(x))$ is measurable by (120). Therefore, (122) is a representation of the map $x \mapsto \langle h_1, f(D(x))h_2 \rangle$ as a pointwise limit of measurable functions, hence we obtain (121).

The criterion [58, Th. E.9] requires us to verify that for every $\varphi \in \mathcal{T}(\mathcal{H})'$, the map $\mathcal{X} \rightarrow \mathbb{C}, x \mapsto \varphi(f(D(x)))$ is measurable. By Lemma 15-4), the map

$$\mathcal{B}(\mathcal{H}) \rightarrow \mathcal{T}(\mathcal{H})', A \mapsto \text{tr}(A \cdot)$$

is an isometric isomorphism. Therefore, it remains to show that for all $A \in \mathcal{B}(\mathcal{H})$, the map $\mathcal{X} \rightarrow \mathbb{C}, x \mapsto \text{tr}(Af(D(x)))$ is measurable.

By Lemma 15-2), $Af(D(x)) \in \mathcal{T}(\mathcal{H})$. Pick an orthonormal basis $(e_i)_{i \in \mathbb{N}}$ of \mathcal{H} . Then, by [31, Th. VI.24],

$$\text{tr}(Af(D(x))) := \sum_{i=1}^{\infty} \langle e_i, Af(D(x))e_i \rangle$$

converges absolutely and regardless of the choice of basis. For every $\ell \in \mathbb{N}$, we have

$$\sum_{i=1}^{\ell} \langle e_i, Af(D(x))e_i \rangle = \sum_{i=1}^{\ell} \langle A^* e_i, f(D(x))e_i \rangle,$$

which is a measurable function of x by (121). So we have written the map $\mathcal{X} \rightarrow \mathbb{C}, x \mapsto \text{tr}(Af(D(x)))$ as a pointwise limit of measurable maps. \square

Lemma 18. *Let $D : \mathcal{X} \rightarrow \mathcal{S}(\mathcal{H})$ be measurable. For every $\ell \in \mathbb{N}$, define a map $\lambda_\ell : \mathcal{X} \rightarrow [0, 1]$ in such a way that for every $x \in \mathcal{X}$, $(\lambda_\ell)_{\ell \in \mathbb{N}}$ is the non-increasing sequence which contains all nonzero eigenvalues of $D(x)$ counted with multiplicity.*

Then, we have the following:

- 1) *For every $\ell \in \mathbb{N}$, the map $\lambda_\ell : \mathcal{X} \rightarrow [0, 1]$ is measurable.*
- 2) *Let $0 < a < b \leq 1$. Then $\mathcal{X} \rightarrow \mathcal{T}(\mathcal{H}), x \mapsto \mathbb{1}_{(a,b)}(D(x))$ is measurable.*

Proof. For item 1), we let $s_\ell : \mathcal{S}(\mathcal{H}) \rightarrow [0, 1]$ be the map that maps each A to its ℓ -th largest eigenvalue (counted with multiplicity). We note that $s_\ell \circ D = \lambda_\ell$. Since by Lemma 15-1), the operator norm is upper bounded by the trace norm, [59, Application (b) following Th. III.9.1] implies that the map s_ℓ is continuous. Therefore, λ_ℓ is measurable, since it is the composition of a continuous and a measurable map.

For item 2), we define a sequence $(f_i)_{i \in \mathbb{N}}$ of functions $[0, 1] \rightarrow \mathbb{R}$ as follows:

$$f_i(t) := \begin{cases} 1, & t \in [a + \frac{1}{i}, b - \frac{1}{i}] \\ i(t - a), & t \in (a, a + \frac{1}{i}) \\ i(b - t), & t \in (b - \frac{1}{i}, b) \\ 0, & t \notin (a, b). \end{cases}$$

It is straightforward to verify that $(f_i)_{i \in \mathbb{N}}$ is a sequence of continuous functions and that for all i and all $t < a$, we have $f_i(t) = 0$. This allows us to apply Lemma 17 and conclude that the functions $\mathcal{X} \rightarrow \mathcal{T}(\mathcal{H}), x \mapsto f_i(D(x))$ are measurable.

It remains to show that for every x , $f_i(D(x))$ converges to $\mathbb{1}_{(a,b)}(D(x))$ in trace norm. We are going to prove the stronger statement

$$\forall x \in \mathcal{X} \exists i' \in \mathbb{N} \forall i \geq i' : f_i(D(x)) = \mathbb{1}_{(a,b)}(D(x)).$$

To this end, we observe that we have equality if f_i and $\mathbb{1}_{(a,b)}$ coincide on $\sigma(D(x))$. It can easily be verified that these functions coincide everywhere but on $(a, a + \frac{1}{i})$ and $(b - \frac{1}{i}, b)$. But if $\sigma(D(x))$ has nonempty intersection with one of these intervals for infinitely many i , we have found an accumulation point of $\sigma(D(x))$ either at a or b , contradicting $a, b \neq 0$. \square

Lemma 19. *Let $(\Omega, \mathcal{F}, \mu)$ be a probability space, \mathcal{H} a separable Hilbert space and let $A : \Omega \rightarrow \mathcal{T}(\mathcal{H})$ be a random variable. Then, we have the following:*

- 1) *The Bochner integral $\mathbb{E}A \in \mathcal{T}(\mathcal{H})$ exists iff the Lebesgue integral $\mathbb{E}\|A\|_{\text{tr}}$ exists and is finite.*
- 2) $\|\mathbb{E}A\|_{\text{tr}} \leq \mathbb{E}\|A\|_{\text{tr}}$
- 3) *Let B be a bounded linear functional on $\mathcal{T}(\mathcal{H})$. Then, if $\mathbb{E}A$ exists, $\mathbb{E}(B(A))$ exists and $B(\mathbb{E}A) = \mathbb{E}(B(A))$,*
- 4) *If $\mathbb{E}A$ exists, then $\mathbb{E}\text{tr}A$ exists and $\text{tr}\mathbb{E}A = \mathbb{E}\text{tr}A$.*
- 5) *If for all $\omega \in \Omega$, we have $A(\omega) \geq 0$ and $\sqrt{A(\omega)} \in \mathcal{T}(\mathcal{H})$, then*

$$\mathbb{E}\sqrt{A} \leq \sqrt{\mathbb{E}A}.$$

Proof. For 1) and 2), we note that the separability of \mathcal{H} implies that $\mathcal{T}(\mathcal{H})$ is separable, which means that A has separable range. Therefore, the statements are proven in [34, V.5, Th. 1 and Cor. 1]. 3) is a special case of [34, Cor. V.5.2]. 4) is a special case of 3), since the trace is a bounded linear operator [56, Lemmas III.1.4 and III.1.8(vi)].

We will show 5) as an application of the Theorem in [60] in the form of eq. (K') with the function $\mathcal{T}(\mathcal{H}) \rightarrow \mathcal{T}(\mathcal{H}), A \mapsto A^*A$ substituted for g . To this end, we first have to note that the function is continuous by Lemma 16 and that it satisfies the convexity condition in [60]. In order to show the latter, we calculate for $t \in [0, 1]$ and $A_1, A_2 \in \mathcal{T}(\mathcal{H})$:

$$\begin{aligned} & (tA_1 + (1-t)A_2)^*(tA_1 + (1-t)A_2) \\ &= t^2A_1^*A_1 + t(1-t)(A_1^*A_2 + A_2^*A_1) + (1-t)^2A_2^*A_2 \\ &= tA_1^*A_1 + (1-t)A_2^*A_2 + (t^2 - t)A_1^*A_1 + ((1-t)^2 - (1-t))A_2^*A_2 + t(1-t)(A_1^*A_2 + A_2^*A_1) \\ &= tA_1^*A_1 + (1-t)A_2^*A_2 - t(1-t)(A_1^*A_1 - A_1^*A_2 - A_2^*A_1 + A_2^*A_2) \\ &= tA_1^*A_1 + (1-t)A_2^*A_2 - t(1-t)(A_1 - A_2)^*(A_1 - A_2) \\ &\leq tA_1^*A_1 + (1-t)A_2^*A_2. \end{aligned}$$

We can now argue

$$\mathbb{E}\sqrt{A} \stackrel{(a)}{=} \sqrt{(\mathbb{E}\sqrt{A})^* \mathbb{E}\sqrt{A}} \stackrel{(b)}{\leq} \sqrt{\mathbb{E}(\sqrt{A^*} \sqrt{A})} \stackrel{(c)}{=} \sqrt{\mathbb{E}A}.$$

(a) is due to $\mathbb{E}\sqrt{A} \geq 0$, (b) is the application of [60, Theorem] combined with the fact that the square root is operator monotone [46, Theorem], and (c) follows directly from $A \geq 0$. \square

Lemma 20. Let $p : \mathbb{N} \rightarrow [0, 1]$ be a p.m.f. with

$$\sum_{i \in \mathbb{N}} p(i)^{\alpha_{\min}} < \infty.$$

Then the function

$$f_p : \alpha \mapsto \sum_{i \in \mathbb{N}} p(i)^\alpha \quad (123)$$

is continuously differentiable on (α_{\min}, ∞) , and its derivative is

$$f'_p : \alpha \mapsto \sum_{i \in \mathbb{N}} p(i)^\alpha \log p(i) \in (-\infty, 0]. \quad (124)$$

Moreover, for every $\alpha_0 > \alpha_{\min}$, we have $g_{\max}(\alpha_0) \in [0, \infty)$ such that for all $\alpha \in [\alpha_0, \infty)$

$$|f'_p(\alpha)| \leq g_{\max}(\alpha_0) \sum_{i \in \mathbb{N}} p(i)^{\alpha_{\min}} < \infty. \quad (125)$$

Proof. Fix an arbitrary $\alpha_0 > \alpha_{\min}$. Because α_0 can be chosen arbitrarily close to α_{\min} , it is sufficient to compute f' on $[\alpha_0, \infty)$. By [61, Theorem 7.17], we only have to show that

$$\sum_{i \in \mathbb{N}} \frac{d}{d\alpha} p(i)^\alpha = \sum_{i \in \mathbb{N}} p(i)^\alpha \log p(i)$$

converges uniformly for $\alpha \in [\alpha_0, \infty)$. To this end, we write

$$-p(i)^\alpha \log p(i) = -p(i)^{\alpha_{\min}} p(i)^{\alpha_0 - \alpha_{\min}} p(i)^{\alpha - \alpha_0} \log p(i) \leq -p(i)^{\alpha_{\min}} p(i)^{\alpha_0 - \alpha_{\min}} \log p(i)$$

By the Weierstraß criterion, we only have to show that

$$\sum_{i \in \mathbb{N}} \left(-p(i)^{\alpha_{\min}} p(i)^{\alpha_0 - \alpha_{\min}} \log p(i) \right)$$

converges. To this end, we first examine the function

$$g : (0, 1] \rightarrow [0, \infty), t \mapsto -t^{\alpha_0 - \alpha_{\min}} \log t.$$

Clearly, $g(1) = 0$. Moreover, by substituting $\hat{t} := -\log t$, we get

$$\lim_{t \rightarrow 0} g(t) = \lim_{\hat{t} \rightarrow \infty} \left(-t^{\alpha_0 - \alpha_{\min}} \log t \right) = \lim_{\hat{t} \rightarrow \infty} \hat{t} \exp(-\hat{t}(\alpha_0 - \alpha_{\min})) = 0,$$

so g can be extended to a continuous function on the whole interval $[0, 1]$ with $g(0) = g(1) = 0$. This means that g takes a finite maximum value g_{\max} on $[0, 1]$. So we have

$$\sum_{i \in \mathbb{N}} \left(-p(i)^{\alpha_{\min}} p(i)^{\alpha_0 - \alpha_{\min}} \log p(i) \right) \leq g_{\max} \sum_{i \in \mathbb{N}} p(i)^{\alpha_{\min}} < \infty$$

by the assumption of the lemma, concluding the proof. \square

Lemma 21. Let P and D be such that (48) holds, let H_P be as defined as in 50, H_U as defined in (51), $H_{P,\alpha}$ as defined in (62), and $H_{U,\alpha}$ as defined in (63).

Then $\alpha \mapsto H_{U,\alpha}$ and $\alpha \mapsto H_{P,\alpha}$ are continuously differentiable on $(\alpha_{\min}, 1) \cup (1, \infty)$. Moreover, we have

$$\lim_{\alpha \rightarrow 1} H_{U,\alpha} = H_U \quad (126)$$

$$\lim_{\alpha \rightarrow 1} H_{P,\alpha} = H_P. \quad (127)$$

Proof. In order to apply Lemma 20, we define functions f_U and $f_{P(\cdot|X)}$ as in (123), where the p.m.f. U (respectively $P(\cdot|X)$) is substituted for p . Observe that

$$H_{U,\alpha} = \frac{1}{1-\alpha} \log f_U(\alpha),$$

where f_U is defined by (123) with $p := U$. Therefore, the continuous differentiability follows immediately from Lemma 20.

The argument for the continuous differentiability of

$$H_{P,\alpha} = \frac{1}{1-\alpha} \log \mathbb{E} f_{P(\cdot|X)}(\alpha)$$

is similar, but we need an additional argument that

$$\frac{d}{d\alpha} \mathbb{E} f_{P(\cdot|X)}(\alpha) = \mathbb{E} f'_{P(\cdot|X)}(\alpha), \quad (128)$$

(and, implicitly, that the derivative on the left-hand side exists) where $f'_{P(\cdot|X)}$ is given in (124). It is sufficient to show that this is the case for all $\alpha > \alpha_0 > \alpha_{\min}$. We argue this with the criterion [62, Th. 16.8] for interchangeability of differentiation and expectation, which requires us to show that $f'_{P(\cdot|x)}$ is a continuous function of α for fixed x and that $|f'_{P(\cdot|x)}(\alpha)|$ has an upper bound that is uniform in α and integrable over X . The former clearly follows from Lemma 20, and for the latter, we note the bound (125) in Lemma 20 and observe that

$$\sum_{y \in \mathbb{N}} P(y|x)^{\alpha_{\min}} = \text{tr}(D(x)^{\alpha_{\min}}),$$

so by the interchangeability of expectation and trace, the integrability follows from the assumption that $\mathbb{E}D(X)^{\alpha_{\min}} \in \mathcal{T}(\mathcal{H})$ exists.

In order to show (126), we note that

$$\lim_{\alpha \rightarrow 1} H_{U,\alpha} = - \lim_{\alpha \rightarrow 1} \frac{\log f_U(\alpha) - \log f_U(1)}{\alpha - 1} = (\log \circ f_U)'(1).$$

Lemma 20 and the chain rule yield

$$(\log \circ f_U)'(1) = \frac{f'_U(1)}{f_U(1)} = H_U.$$

For (127), we have

$$\lim_{\alpha \rightarrow 1} H_{P,\alpha} = - \lim_{\alpha \rightarrow 1} \frac{\log \mathbb{E}f_{P(\cdot|X)}(\alpha) - \log \mathbb{E}f_{P(\cdot|X)}(1)}{\alpha - 1} = g'(1),$$

where g' is the derivative of

$$g : \alpha \mapsto \log \mathbb{E}f_{P(\cdot|X)}(\alpha).$$

We use (128) and the chain rule for differentiation to obtain

$$g'(\alpha) = \frac{\mathbb{E}f'_{P(\cdot|X)}(\alpha)}{\mathbb{E}f_{P(\cdot|X)}(\alpha)} = \frac{\mathbb{E} \sum_{y \in \mathbb{N}} P(y|X)^\alpha \log P(y|X)}{\mathbb{E} \sum_{y \in \mathbb{N}} P(y|X)^\alpha},$$

so clearly, $g'(1) = H_P$, concluding the proof of the lemma. \square

REFERENCES

- [1] P. W. Shor, "Polynomial-time algorithms for prime factorization and discrete logarithms on a quantum computer," *SIAM Journal on Computing*, vol. 26, no. 5, pp. 1484–1509, 1997.
- [2] J. Ferrigno and M. Hlaváč, "When AES blinks: introducing optical side channel," *IET Information Security*, vol. 2, pp. 94–98(4), September 2008.
- [3] L. K. Grover, "A fast quantum mechanical algorithm for database search," in *Proceedings of the twenty-eighth annual ACM symposium on Theory of Computing*, 1996, pp. 212–219.
- [4] J. A. Buchmann, D. Butin, F. Göpfert, and A. Petzoldt, *Post-Quantum Cryptography: State of the Art*. Berlin Heidelberg: Springer, 2016, pp. 88–108.
- [5] J. Krämer, M. Kasper, and J.-P. Seifert, "The role of photons in cryptanalysis," in *2014 19th Asia and South Pacific Design Automation Conference*, 2014, pp. 780–787.
- [6] Z. Utkovski, P. Agostini, M. Frey, I. Bjelaković, and S. Stańczak, "Learning radio maps for physical-layer security in the radio access," in *2019 IEEE 20th International Workshop on Signal Processing Advances in Wireless Communications*, 2019, pp. 1–5.
- [7] Z. Utkovski, M. Frey, P. Agostini, I. Bjelaković, and S. Stańczak, "Semantic security based secrecy maps for vehicular communications," in *25th International ITG Workshop on Smart Antennas*, 2021, pp. 307–311.
- [8] R. Schulz, O. Günlü, R. Elschner, R. F. Schaefer, C. Schmidt-Langhorst, C. Schubert, and R. F. Fischer, "Semantic security for indoor THz-wireless communication," in *2021 17th International Symposium on Wireless Communication Systems*, 2021, pp. 1–6.
- [9] A. D. Wyner, "The wire-tap channel," *Bell Labs Technical Journal*, vol. 54, no. 8, pp. 1355–1387, 1975.
- [10] I. Csiszar and J. Korner, "Broadcast channels with confidential messages," *IEEE Transactions on Information Theory*, vol. 24, no. 3, pp. 339–348, 1978.
- [11] I. Csiszar, "Almost independence and secrecy capacity," *Problems of Information Transmission*, vol. 32, no. 1, pp. 40–47, 1996.
- [12] M. Hayashi, "General nonasymptotic and asymptotic formulas in channel resolvability and identification capacity and their application to the wiretap channel," *IEEE Transactions on Information Theory*, vol. 52, no. 4, pp. 1562–1575, 2006.
- [13] M. R. Bloch and J. N. Laneman, "Strong secrecy from channel resolvability," *IEEE Transactions on Information Theory*, vol. 59, no. 12, pp. 8077–8098, 2013.
- [14] S. Goldwasser and S. Micali, "Probabilistic encryption," *Journal of Computer and System Sciences*, vol. 28, no. 2, pp. 270–299, 1984.
- [15] M. Bellare, S. Tessaro, and A. Vardy, "Semantic security for the wiretap channel," in *Annual Cryptology Conference*. Springer, 2012, pp. 294–311.
- [16] P. Cuff, "Soft covering with high probability," in *2016 IEEE International Symposium on Information Theory*. IEEE, 2016, pp. 2963–2967.
- [17] Z. Goldfeld, P. Cuff, and H. H. Permuter, "Semantic-security capacity for wiretap channels of type II," *IEEE Transactions on Information Theory*, vol. 62, no. 7, pp. 3863–3879, July 2016.
- [18] —, "Semantic-security capacity for the physical layer via information theory," in *2016 IEEE International Conference on Software Science, Technology and Engineering*, June 2016, pp. 17–27.
- [19] B. Schumacher and M. D. Westmoreland, "Quantum privacy and quantum coherence," *Physical Review Letters*, vol. 80, no. 25, p. 5695, 1998.
- [20] I. Devetak, "The private classical capacity and quantum capacity of a quantum channel," *IEEE Transactions on Information Theory*, vol. 51, no. 1, pp. 44–55, 2005.
- [21] N. Cai, A. Winter, and R. W. Yeung, "Quantum privacy and quantum wiretap channels," *Problems of Information Transmission*, vol. 40, no. 4, pp. 318–336, 2004.
- [22] M. Hayashi, "Quantum wiretap channel with non-uniform random number and its exponent and equivocation rate of leaked information," *IEEE Transactions on Information Theory*, vol. 61, no. 10, pp. 5595–5622, 2015.

- [23] S. Guha, J. H. Shapiro, and B. I. Erkmen, "Capacity of the bosonic wiretap channel and the entropy photon-number inequality," in *2008 IEEE International Symposium on Information Theory*, 2008, pp. 91–95.
- [24] M. Wilde and M. Hsieh, "Public and private resource trade-offs for a quantum channel," *Quantum Information Processing*, vol. 11, p. 1465–1501, 2012.
- [25] M. M. Wilde, P. Hayden, and S. Guha, "Quantum trade-off coding for bosonic communication," *Physical Review A*, vol. 86, p. 062306, December 2012.
- [26] H. Qi and M. M. Wilde, "Capacities of quantum amplifier channels," *Physical Review A*, vol. 95, p. 012339, January 2017.
- [27] M. M. Wilde and H. Qi, "Energy-constrained private and quantum capacities of quantum channels," *IEEE Transactions on Information Theory*, vol. 64, no. 12, pp. 7802–7827, 2018.
- [28] D. Ding and S. Guha, "Noisy feedback and loss unlimited private communication," in *2018 IEEE International Symposium on Information Theory*, 2018, pp. 586–590.
- [29] H. Boche, M. Cai, C. Deppe, R. Ferrara, and M. Wiese, "Semantic security for quantum wiretap channels," *Journal of Mathematical Physics*, vol. 63, no. 9, p. 092204, 2022.
- [30] M. Hayashi, *Quantum Information*. Berlin Heidelberg: Springer, 2006.
- [31] M. Reed and B. Simon, *Functional Analysis, Revised and Enlarged Edition*, ser. Methods of Modern Mathematical Physics. San Diego: Academic Press, 1980, vol. 1.
- [32] T. Heinosaari and M. Ziman, *The Mathematical Language of Quantum Theory. From Uncertainty to Entanglement*. Cambridge: Cambridge University Press, 2012.
- [33] P. Busch, P. Lahti, J.-P. Pellonpää, and K. Ylänen, *Quantum Measurement*, 1st ed., ser. Theoretical and Mathematical Physics. Basel: Springer, 2016.
- [34] K. Yosida, *Functional Analysis*, 6th ed., ser. Grundlehren der mathematischen Wissenschaften. Berlin Heidelberg New York: Springer, 1980, vol. 123.
- [35] A. S. Holevo, *Quantum Systems, Channels, Information*, 2nd ed., ser. Texts and Monographs in Theoretical Physics. Berlin Boston: de Gruyter, 2019.
- [36] A. S. Holevo and M. E. Shirokov, "Continuous ensembles and the capacity of infinite-dimensional quantum channels," *Theory of Probability & Its Applications*, vol. 50, no. 1, pp. 86–98, 2006.
- [37] A. Tikku, M. Berta, and J. M. Renes, "Non-additivity in classical-quantum wiretap channels," *IEEE Journal on Selected Areas in Information Theory*, vol. 1, no. 2, pp. 526–535, 2020.
- [38] M. Bellare, S. Tessaro, and A. Vardy, "A cryptographic treatment of the wiretap channel," *arXiv preprint arXiv:1201.2205*, 2012.
- [39] G. Lindblad, "Completely positive maps and entropy inequalities," *Communications in Mathematical Physics*, vol. 40, pp. 147–151, 1975.
- [40] F. Hiai, M. Ohya, and M. Tsukada, "Sufficiency, KMS condition and relative entropy in von Neumann algebras," *Pacific Journal of Mathematics*, vol. 96, no. 1, pp. 99–109, 1981.
- [41] A. Winter, "Tight uniform continuity bounds for quantum entropies: conditional entropy, relative entropy distance and energy constraints," *Communications in Mathematical Physics*, vol. 347, pp. 291–313, 2016.
- [42] M. E. Shirokov, "Entropy characteristics of subsets of states. I," *Izvestiya: Mathematics*, vol. 70, no. 6, p. 1265, 2006.
- [43] V. Moretti, *Fundamental Mathematical Structures of Quantum Theory: Spectral Theory, Foundational Issues, Symmetries, Algebraic Formulation*. Springer, 2019.
- [44] M. Hayashi and H. Nagaoka, "General formulas for capacity of classical-quantum channels," *IEEE Transactions on Information Theory*, vol. 49, no. 7, pp. 1753–1768, 2003.
- [45] M. J. Wainwright, *High-Dimensional Statistics. A Non-Asymptotic Viewpoint*, 1st ed., ser. Cambridge Series in Statistical and Probabilistic Mathematics. Cambridge: Cambridge University Press, 2019, vol. 48.
- [46] G. K. Pedersen, "Some operator monotone functions," *Proceedings of the American Mathematical Society*, vol. 36, no. 1, pp. 309–310, November 1972.
- [47] H. Engl, M. Hanke, and A. Neubauer, *Regularization of Inverse Problems*, ser. Mathematics and Its Applications. Springer Netherlands, 2000.
- [48] A. Ben-Israel and T. N. Greville, *Generalized Inverses: Theory and Applications*, 2nd ed., ser. CMS Books in Mathematics. New York: Springer, 2003, vol. 15.
- [49] C. McDiarmid, "On the method of bounded differences," *Surveys in Combinatorics*, vol. 141, no. 1, pp. 148–188, 1989.
- [50] S. Boucheron, G. Lugosi, and P. Massart, *Concentration Inequalities. A Nonasymptotic Theory of Independence*, 1st ed. Oxford: Oxford University Press, 2013.
- [51] M. Frey, I. Bjelaković, and S. Stańczak, "Towards secure over-the-air computation," *arXiv preprint arXiv:2001.03174v4*.
- [52] F. Bender, "Non-asymptotic channel estimation for secrecy maps," Master's thesis, Technische Universität Berlin, 2021, available: <https://www.tu.berlin/netit/theses/ongoing-and-finished-theses/>.
- [53] K. Sharma, M. M. Wilde, S. Adhikari, and M. Takeoka, "Bounding the energy-constrained quantum and private capacities of phase-insensitive bosonic Gaussian channels," *New Journal of Physics*, vol. 20, p. 063025, 2018.
- [54] U. Leonhardt, *Measuring the Quantum State of Light*, ser. Cambridge Studies in Modern Optics. Cambridge University Press, 1997.
- [55] A. Prokes, "Atmospheric effects on availability of free space optics systems," *Optical Engineering*, vol. 48, 2009.
- [56] R. Schatten, *Norm Ideals of Completely Continuous Operators*, 2nd ed., ser. Ergebnisse der Mathematik und ihrer Grenzgebiete. Berlin Heidelberg: Springer, 1970, vol. 27.
- [57] M. M. Wilde, *Quantum Information Theory*. Cambridge: Cambridge University Press, 2013.
- [58] D. L. Cohn, *Measure theory*, 2nd ed., ser. Birkhäuser Advanced Texts. Basel: Birkhäuser, 2013.
- [59] I. Gohberg and S. Goldberg, *Basic Operator Theory*. Boston Basel Stuttgart: Birkhäuser, 1980.
- [60] T. O. To and Y. K. Wing, "A generalized Jensen's inequality," *Pacific Journal of Mathematics*, vol. 58, no. 1, pp. 255–259, 1975.
- [61] W. Rudin, *Principles of Mathematical Analysis*, 3rd ed., ser. International Series in Pure and Applied Mathematics. Singapore: McGraw-Hill, 1986.
- [62] P. Billingsley, *Probability and Measure*, anniversary ed., ser. Wiley Series in Probability and Mathematical Statistics. Hoboken: Wiley, 2012.