

# DACSR: Decoupled-Aggregated End-to-End Calibrated Sequential Recommendation

Jiayi Chen<sup>1</sup>, Wen Wu<sup>1\*</sup>, Liye Shi<sup>1</sup>, Yu Ji<sup>1</sup>, Wenxin Hu<sup>2</sup>, Wei Zheng<sup>3</sup> and Liang He<sup>1</sup>

<sup>1</sup>School of Computer Science and Technology, East China Normal University, 200062, Shanghai, China.

<sup>2</sup>The Computer Center, East China Normal University, 200062, Shanghai, China.

<sup>3</sup>Information Technology Services, East China Normal University, 200062, Shanghai, China.

\*Corresponding author(s). E-mail(s): [wwu@cc.ecnu.edu.cn](mailto:wwu@cc.ecnu.edu.cn);  
Contributing authors: [jychen@ica.stc.sh.cn](mailto:jychen@ica.stc.sh.cn); [lyshi@ica.stc.sh.cn](mailto:lyshi@ica.stc.sh.cn);  
[52205901009@stu.ecnu.edu.cn](mailto:52205901009@stu.ecnu.edu.cn); [wxhu@cc.ecnu.edu.cn](mailto:wxhu@cc.ecnu.edu.cn);  
[wzheng@admin.ecnu.edu.cn](mailto:wzheng@admin.ecnu.edu.cn); [lhe@cs.ecnu.edu.cn](mailto:lhe@cs.ecnu.edu.cn);

## Abstract

Recent years have witnessed the progress of sequential recommendation in accurately predicting users' future behaviors. However, only persuading accuracy leads to the risk of filter bubbles where recommenders only focus on users' main interest areas. Different from other studies which improve diversity or coverage, we investigate the calibration in sequential recommendation, which aims to calibrate the interest distributions of recommendation lists and behavior sequences. However, existing calibration methods followed a post-processing paradigm, which costs more computation time and sacrifices the recommendation accuracy. To this end, we propose an end-to-end framework to provide both accurate and calibrated recommendations in sequential recommendation. We propose an objective function to measure the divergence of distributions between recommendation lists and historical behaviors. In addition, we design a decoupled-aggregated model which extracts information from two individual sequence encoders with different objectives to further improve the recommendation. Experiments on two benchmark datasets demonstrate the effectiveness and efficiency of our model.

**Keywords:** Sequential Recommendation, Calibrated Recommendation, End-to-End

## 1 Introduction

Recommender systems aim to help users find their interests among large-scale items. In recent years, sequential recommendation has achieved great attention, which predicts users' future behaviors according to sequences of historical behaviors. Existing studies focused on modeling sequences, learning item transitions and obtaining accurate recommendations. The deep learning based architectures, such as Recurrent Neural Networks and Graph Neural Networks, have progressed in sequential recommendation [1–3].

Most of existing studies attempted to obtain higher recommendation accuracy. However, seeking high accuracy solely may bring the risk of filter bubbles. The recommender systems tend to provide skewed recommendation lists which only focus on users' major interest areas. Although the recommendation accuracy is satisfactory, users may feel bored by the homogeneous recommended items. Therefore, some studies measured the quality of recommendation lists from other perspectives, such as diversity [4–8], coverage [9–11], and unexpectedness [12–14]. The calibrated recommendation was first proposed in [15]. It aims to provide the recommendation list which is consistent with the spectrum of items of the user's historical behaviors [15]. For example, if a user has watched 70% action movies and 30% comedies, a fully calibrated recommendation list should contain action and comedy movies with this ratio. The calibrated recommendation can improve the diversity and reduce the effect of filter bubble to a certain degree by diversifying the distributions of recommendation lists [15, 16]. It is also a metric of fairness, which aims to provide unbiased recommendation lists for different users in terms of the distributions [15].

Existing studies in calibrated recommendations followed a post-ranking paradigm, which ranks items from a candidate list that has been generated by a basic recommendation model. In addition, they focused on the collaborative filtering models, such as item-based collaboration and matrix factorization [15, 17, 18]. One advantage of these approaches is that they can be adapted to almost any base model, and it only requires the items and scores of the candidate list generated by the base model. However, models based on post-ranking need extra computations, resulting in more response time. These models applied an extra ranking stage which generate results step by step. In each step, the model needs to compute the gains of all candidates. Though the number of candidates is much less than that of all items, the ranking stage is still time consuming. Another issue is that a high weight on calibration is harmful to recommendation accuracy. The ranking model considers more for calibration at each step where the user's next item obtains less score and has a lower ranking position. Therefore, the recommendation accuracy is affected,

especially the ranking performance. Finally, calibration was not investigated in sequential recommendation scenario. Therefore, it is meaningful to propose an end-to-end sequential recommendation model, which provides accurate and calibrated recommendations without the post-ranking stage.

We propose an end-to-end sequential recommendation framework, namely “DACSR”, consisting of a calibration loss function and a decoupled-aggregated framework. First, we provide a loss function for end-to-end calibrated sequential recommendation. We combine the prediction scores of all items and the item category information to estimate the distribution of the recommendation list. Then we use cosine similarity to measure the consistency between distributions of the recommendation list and behavior sequence. Next, we propose a decoupled-aggregated framework to provide accurate and calibrated recommendations. Concretely, we utilize two individual sequence encoders which only focus on accuracy and calibration, respectively. Then we apply an aggregation module to extract information from two sequence encoders, and make predictions optimized by a trade-off between calibration and accuracy.

The contributions of this paper are listed as follows:

- We propose an end-to-end framework to provide accurate and calibrated recommendation lists for sequential recommendation.
- We design a calibration loss function for model optimization. In addition, we propose a decoupled-aggregated framework which aggregates information from individual sequence encoders to ensure accuracy and improve the calibration.
- Experiments on benchmark datasets show that our model can achieve higher accuracy than other baselines. In addition, recommendation lists generated by our model are more calibrated than baseline models.

The rest of this paper is organized as follows. We first review the existing literature in Sec. 2. Then we introduce our model in Sec. 3 and the experimental details in Sec. 4. We show the experimental results and analysis in Sec. 5. Finally, we discuss our work in Sec. 6 and conclude our paper and indicate some future work in Sec. 7.

## 2 Related Work

In this section, we provide a literature review of our work. We first introduce existing studies in sequential recommendation. Then we review the recent advances in calibrated recommendation.

### 2.1 Sequential Recommendation

Sequential recommendation relies on users’ historical behavior sequences to predict their future behaviors. Existing studies focused on modeling sequences and obtained better sequence representations to achieve higher recommendation accuracy. Hidasi et al. first utilized gated recurrent units for sequential

recommendations and provided a parallel training strategy [1]. Li et al. further proposed an attention mechanism to capture the main purposes of the sequence [19]. Caser utilized convolutional neural networks to extract information from short-term sequences [20]. With the development of self-attention, self-attentive-based models were proposed to achieve better sequence representations. For example, SASRec applied a self-attentive mechanism to learn both long-term and short-term preferences of user behavior sequences, which achieved satisfactory performance of recommendation accuracy [21]. Xu et al. divided sequences into subsequences and captured users' long- and short-term preferences with two self-attention networks [22]. In addition, transformer-based sequence encoders were proposed, such as BERT4Rec and Transformer4Rec [23, 24]. In recent years, graph neural networks were also utilized for sequential recommendation [2, 3, 25]. For example, Wu et al. applied GGNN to learn item transitions from historical behaviors which treated sequences as graphs [3]. In addition, multi-interest-based models were proposed which used multiple vectors to represent a sequence in order to disentangle users' diverse intentions [5, 6, 26, 27].

## 2.2 Calibrated Recommendation

Existing sequential recommendation models achieved satisfactory recommendation accuracy. However, these algorithms tended to generate skewed recommendation lists which focus on users' main interest area, leading to the risk of filter bubbles [9, 15]. Therefore, recent studies evaluated sequential recommendation algorithms by different metrics, such as diversity [4–8], coverage [9–11] and unexpectedness [12–14]. In recent years, calibration was proposed, which aimed to generate recommendation lists whose category distributions are less divergent with the users profile [15]. In [15], the author also provided a post-processing greedy re-ranking model which considered both accuracy and calibration at each step of generating results. Abdollahpouri et al. studied the connections between popularity bias and calibration [28]. They found that users who are affected more by popularity bias tend to achieve less calibrated recommendation lists. Kaya and Bridge compared intent-aware algorithms and calibration algorithms [16]. They found that the diversity-oriented intent-aware models can achieve calibrated recommendations and calibration-oriented models can obtain diversity to some extent. Seyman et al. proposed weighted total variation to measure the consistency between two distributions and a constrained optimization model to improve the ranking stage for calibration [17]. Silva et al. proposed new metrics to evaluate calibrated recommendations and adaptive selection strategies for the trade-off weight in the post-processing algorithms [18].

Although these calibration methods progressed in collaborative filtering, few studies focused on sequential recommendation. In addition, these methods require a post-process stage, which needs more time consumption for recommendation. Therefore, we investigate the end-to-end framework for

the calibrated sequential recommendation, which does not require a post-processing stage. In addition, we attempt to propose models which can obtain satisfactory calibration and cause less reduction in recommendation accuracy.

### 3 Methodology

In this section, we introduce our DACSR model in detail. First, we provide preliminaries of the paradigm of sequential recommendation and the computations of distributions. Then we introduce our proposed loss function and Decoupled-Aggregated framework for end-to-end calibrated sequential recommendation.

#### 3.1 The Sequential Recommendation Paradigm

The sequential recommendation predicts items that the user may view in the future based on the user’s historical behavior sequence. In general, it can be decomposed into two parts, the sequence encoder and the prediction layer. The sequence encoder takes the historical behavior sequence as the input, and represents it to a vector. Formally, the procedure can be written as:

$$\begin{aligned} h &= f(s \mid E^I, \theta, L) \\ s &= \{x_1, x_2, \dots, x_T\} \end{aligned}$$

where  $f(\cdot)$  is the sequence encoder and  $h$  is the sequence representation of sequence  $s$ .  $E^I$  represents the item embedding matrix of all items  $I$ , and  $\theta$  stands for the parameters of the sequence encoder.  $L$  is the loss function that is used to optimize the sequence encoder  $f$ .

The sequence representation  $h$  is further used to predict the score of all items. The prediction layer is usually a linear transformation layer:

$$\hat{y} = Wh^T + b \quad (1)$$

where  $W$  and  $b$  are  $|I| \times d$  and  $|I|$  dimensional learnable parameters. A common setting is that  $W$  is the item embedding matrix which is used in  $f$  and bias  $b$  is removed:

$$\hat{y} = E^I h^T \quad (2)$$

where  $E_I$  is the item embedding matrix. This prediction layer is widely used in existing studies [3, 19, 21, 22, 29], and we also follow this setting in our work. In our work, we select SASRec [21] as the basic sequence encoder, because our goal is not to investigate modeling sequences and the SASRec model has achieved satisfactory performances in existing studies.

#### 3.2 Item Category Distributions

In our work, we use the same formulation proposed by [15] to define the distributions.

- $p(s)$  is the item category distribution from the sequence  $s$ . For each category  $g$ , the distribution value is computed as:

$$p(g | s) = \frac{\sum_{x \in s} p(g | x)}{|s|} \quad (3)$$

where  $p(g | x)$  is the indicator function of item  $x$  and category  $g$ , which satisfies  $\sum_{g \in G} p(g | x) = 1$ . If item  $x$  does not contain category  $g$ , the value of  $p(g | x)$  is 0. If the item contains two categories, the value of  $p(g | x)$  equals to 0.5 for each category  $g$ . Finally, the category distribution can be represented as a  $G$ -dimensional vector  $\{p(g = 1 | x), p(g = 2 | x), \dots, p(g = G | x)\}$ , where  $|G|$  is the total amount of item categories.

- $q(s)$  is the category distribution of the recommendation list. For each category  $g$ , the distribution value is computed as:

$$q(g | RL) = \frac{\sum_{x \in RL} p(g | x)}{K} \quad (4)$$

where  $RL$  is the recommendation list, and  $K$  is the size of  $RL$ . Similar to  $p(s)$ , the distribution  $q(s)$  can also be represented as a  $G$ -dimensional vector  $\{q(g = 1 | x), q(g = 2 | x), \dots, q(g = G | x)\}$ .

Note that although [15] added a weight for each item in  $s$  and  $RL$ , the weight was equal to 1 in [15] and following studies, which is equivalent to our work.

### 3.3 The Proposed Model

We first introduce the loss function for calibration, and then show our Decoupled-Aggregation framework next.

#### 3.3.1 The Calibration Loss

To generate a calibrated recommendation list, we design the loss function for the model training. The calibration measures the consistency between the recommendation list and the historical sequence. The distribution of historical sequence  $p(s)$  can be computed as Eq. 3. We estimate the distribution of the recommendation list  $q(s)$  as follows:

$$\hat{q}(g | s) = \sum_i^{\|I\|} \hat{y}_i \cdot p(g | i) \quad (5)$$

$$\hat{y}_i = \text{softmax}(\hat{y}_i / \tau) \quad (6)$$

where  $\hat{y}_i$  is the score of the item  $i$  predicted by the model, and it is further processed by a softmax function. If an item has more prediction score, it contributes more to  $\hat{q}(g | s)$ . The softmax function also amplifies the difference in scores. Items with high scores will still be given higher weights, while weights of

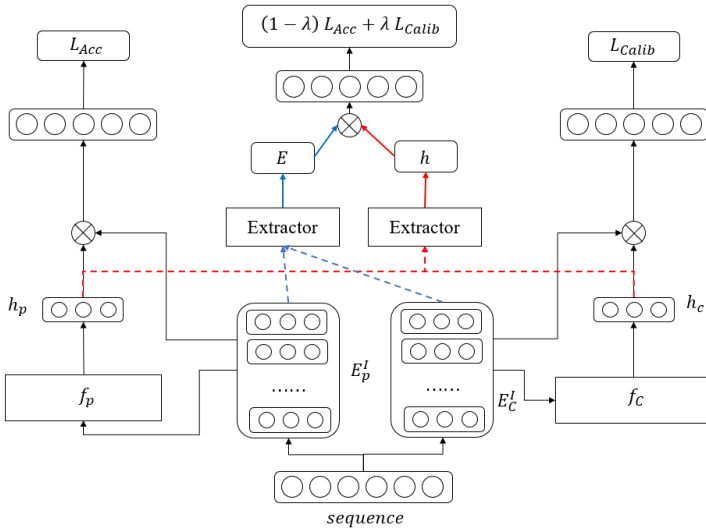

**Fig. 1** The architecture of our DACSR model

other items are close to 0. Therefore, we can use the above equation to estimate the category distribution  $q(s)$  of the recommendation list with Top-K items.  $\tau$  ( $\tau > 0$ ) is the temperature parameter of softmax function. If  $\tau < 1$ , the score distribution becomes sharper and items with higher scores get more emphasis. In contrast, an extremely large value of  $\tau$  will make the score distribution more uniform.

After estimating  $q(s)$ , we define the loss function of calibration as:

$$L_{Calib}(I, \hat{y}) = 1 - \cos(\hat{q}(s), p(s)) \quad (7)$$

where  $\hat{q}(s)$  is the estimated distribution vector  $\{\hat{q}(g = 1 | s), \dots, \hat{q}(g = G | s)\}$  and  $\cos$  is the cosine similarity between two vectors. If the two distributions are more consistent, the value of  $L_{Calib}$  will be lower.

However, a calibrated recommendation list is not always a diversified list (e.g., a user who only focused on a few types of items). If we want a diversified recommendation list to a certain degree, we can modify the distribution as follows:

$$p_d(s) = \text{softmax}(p(s)/\tau_{div}) \quad (8)$$

In this equation, the historical distribution  $p(s)$  is normalized by a softmax function. For item category  $g$  that the user did not interacted (i.e.,  $p(g | s) = 0$ ), it will obtain a positive value. Therefore, all categories are considered. The parameter  $\tau_{div}$  is also used to control the distribution, similar to  $\tau$ .

### 3.4 The DACSR Recommendation Framework

To obtain recommendation lists with accuracy and calibration, an intuitive way is directly optimizing the sequential recommendation model with a weighted

sum of loss function:

$$L_w = (1 - \lambda) \times L_{Acc} + \lambda \times L_{Calib} \quad (9)$$

where  $\lambda \in [0, 1]$  is the trade-off factor between accuracy and calibration. A higher value of  $\lambda$  means more consideration on calibration.  $L_{Acc}$  is the accuracy-based loss function. In our work, we choose the cross-entropy loss function:

$$L_{Acc}(y, \hat{y}) = \sum_{i=0}^{|I|} y_i \log(\hat{y}_i) \quad (10)$$

where  $y$  and  $\hat{y}$  are the vectors of the ground-truth and predicted scores of all items, respectively. The  $y$  is an one-hot vector where  $y_i = 1$  means item  $i$  is the next item of the sequence, and 0 otherwise.

However, directly optimizing by the weighted loss function may lead to a seesaw problem. For example, the performance of calibration increases by sacrificing the recommendation accuracy. Therefore, we propose our Decoupled-Aggregated framework, which includes two basic sequence encoders, as shown in Fig. 1. The two sequence encoders are optimized separately. One is to accurately predict the next behavior, while the other one is to provide a fully calibrated recommendation list. Formally, this can be represented as:

$$h_p = f_p(s | E_p^I, \theta_p, L_{Acc}) \quad (11)$$

$$h_c = f_c(s | E_c^I, \theta_c, L_{Calib}) \quad (12)$$

where  $f_p$  and  $f_c$  are two different sequence encoders with different parameters and objective functions.  $E_p^I$  and  $E_c^I$  are item embedding matrices of the two sequence encoders.  $\theta_p$  and  $\theta_c$  are their parameters. Note that the two encoders  $f_p$  and  $f_c$  do not share the same parameters and item embedding matrices, and are optimized by their unique loss functions  $L_{Acc}$  and  $L_{Calib}$ , respectively.

Next, we use the sequence representations and item embeddings of the two encoders to provide calibrated recommendation list. A direct way is to concatenate the representations of two sequence encoders:

$$h_a = [h_p, h_c] \quad (13)$$

$$E_a^I = [E_p^I, E_c^I] \quad (14)$$

Based on this, we concatenated vectors are input to two extractor nets:

$$h_a = EX_{seq}^a([h_p, h_c]) \quad (15)$$

$$E_a^I = EX_{emb}^a([E_p^I, E_c^I]) \quad (16)$$

where  $[\cdot]$  is the concatenation execution of two vectors or matrices.  $EX_{seq}^a$  and  $EX_{emb}^a$  are two extractor nets. The extractor net is a feed-forward network



which can be defined as follows:

$$h^t = W^t \sigma(h^{t-1}) + b^t \quad (t = 1, 2, 3 \dots) \quad (17)$$

where  $W^0, W^1, \dots, W^t$  and  $b^0, b^1, \dots, b^t$  are  $2d \times 2d$  and  $2d$  dimensional parameters need to learn ( $d$  is the dimension of hidden states).  $t$  is the number of layers in the extractor net.  $\sigma$  is the activation function. In our work, we use *ReLU* as the activation function.  $h_0$  is the input of the feed-forward network (i.e.,  $[h_p, h_c]$  and  $[E_p^I, E_c^I]$ ). Inspired by ResNet, we add the original input as the final representation:

$$h^t = h^t + h^0 \quad (18)$$

Finally, the scores of all items can be computed as:

$$\hat{y}_a = E_a^I h_a^T \quad (19)$$

which is similar to Eq. 2. We also use the weighted loss function  $L_w$  to optimize the model. In conclusion, the loss function of the DACSR model can be written as:

$$L = L_w(\hat{y}_a) + L_{Acc}(y, \hat{y}_p) + L_{Calib}(I, \hat{y}_c) \quad (20)$$

where  $\hat{y}_p$  and  $\hat{y}_c$  are scores of all items generated by  $f_p$  and  $f_c$ .

## 4 Experiments

To evaluate the effectiveness of our model, we conducted experiments on real-world datasets and compared our model with existing models.

### 4.1 Dataset

We adopted two commonly-used benchmark datasets to evaluate the performance of our model. The first one is Movielens-1m<sup>1</sup>, which contains interaction logs of more than 6000 users and 3000 movies. The other is Tmall<sup>2</sup>, which includes user behavior logs on an e-commerce platform. For both datasets, we sort each user's behaviors according to the timestamp. We follow a 5-core strategy that removes the users and items whose number of occurrences is less than 5. We also apply the leave-one-out evaluation protocol [21]. The latest clicked item of a user belongs to the testing set, and the previous one of this item belongs to the validation set. The remaining sequences construct the training set. To augment the training data, we extend the user's sequence following [3, 19]. We set the maximum sequence length equal to 200 and 100 for the ML-1m and Tmall dataset, respectively. The statistics are listed in Table 1.

### 4.2 Comparison Models

We selected the following methods as baselines:

---

<sup>1</sup><https://grouplens.org/datasets/movielens/1m>

<sup>2</sup><https://tianchi.aliyun.com/dataset/dataDetail?dataId=53>

**Table 1** Statistics of Datasets

Statistics	MI-1m	Tsmall
Number of users	6,040	31,854
Number of Items	3,883	58,343
Number of Training Sequences	981,504	832,603
Number of Testing Sequences	6,040	31854
Number of Categories	18	70

- **SASRec** [21] is a self-attentive-based sequential recommendation model, and is a strong baseline. We apply the SASRec model as the sequence encoder for  $f_p$  and  $f_c$ , and compare our model with SASRec.
- **CaliRec** [15] is a post-processing model which re-ranks the results generated by the sequence encoder. It makes a trade-off between accuracy and calibration at each time step.
- **GC** [18] utilizes an adaptive selection for the trade-off factor. The higher coverage of item categories of the user historical sequence results in more consideration for calibration.

### 4.3 Evaluation Metrics

We evaluate models from accuracy and calibration perspectives. Following previous work[3, 19], we use Recall and MRR as evaluation metrics to measure the recommendation accuracy of models.

- **Recall@K** (Rec@K) is a widely used metric in recommendation and information retrieval areas. Recall@K computes the proportion of correct items in the top-N items of the list.

$$Recall@K = \frac{1}{N} \sum_s 1(x_{n+1} \in RL_s) \quad (21)$$

where  $1()$  is an indication function whose value equals 1 when the condition in brackets is satisfied and 0 otherwise.

- **MRR@K** is another important metric that considers the rank of correct items. The score is computed by the reciprocal rank when the rank is within N; otherwise the score is 0.

$$MRR@K = \frac{1}{\|N\|} \sum_s \frac{1}{rank(x_{n+1}, RL_s)} \quad (22)$$

To evaluate the effectiveness in terms of calibration, we adopt  $C_{KL}$  which is a common metric used for calibrated recommendation [15]. The  $C_{KL}$  compares the consistency between two distribution:

$$C_{KL}(RL, s) = \frac{1}{N} \sum_s \sum_{g \in G} q(g | s) \frac{q(g | s)}{p(g | s)} \quad (23)$$

where  $N$  is the number of testing cases. The lower  $C_{KL}$  value means we provide more calibrated recommendation lists.

In addition, to better compare performances of our model and baseline models, we define the improvement as follows:

$$Improv. = \frac{Metric_{DACSR} - Metric_{Baseline}}{Metric_{Baseline}} \quad (24)$$

where *Metric* can be any metric mentioned above.

## 4.4 Experimental Setup

We use grid search to find the optimal hyperparameters on the validation dataset. The dimension of hidden states is tuned from  $\{32, 64, 128, 256\}$ , following. We tune the learning rate from  $\{0.1, 0.01, 0.001\}$ . The number of layers in the extractor net  $t$  equals 2 for all datasets. We use the Adam [30] optimizer with a batch size of 128. We report the performance under the model parameters with the optimal prediction accuracy on the validation set. We make hyper-parameter  $\lambda = 0.5$  and  $\tau = 1$  as the default setting, and analyze their influence in following sections. To accelerate the training procedure, we initialize the parameters of sequence encoders used in our models by pre-trained parameters. For the top-K recommendation, we set  $K = 10$  and 20 which is a common setting.

## 5 Results and Analysis

### 5.1 Overall Performance

The performances of baselines and our model are listed in Table 2, where the best performance is marked in bold.

**Recommendation Accuracy** We first analyze the performance from the perspective of accurate recommendation (i.e., Recall and MRR). In general, on both datasets, our model achieves the best prediction accuracy in terms of Recall and MRR. On the MI-1m dataset, the Recall and MRR of our model are higher than the original SASRec model (e.g., 0.1236 v.s. 0.1102 in terms of MRR@10). Compared to the CaliRec model and GC model, our model can provide much more accurate recommendation results. For example, the MRR@20 of our model is 0.1303, while it is 0.1098 and 0.0746 for CaliRec and GC model, with the improvement of 18.67% and 74.66%, respectively. On the Tsmall dataset, our DACSR model can still achieve the best recommendation accuracy. For example, the MRR@20 of our DACSR model is 0.0881, which is higher than 0.0871 of the SASRec model and 0.0855 of the CaliRec model.

**Calibrated Recommendation** From the calibration perspective, our model can provide more calibrated recommendation lists compared to the original sequential recommendation model. On both datasets,  $C_{KL}@10$  and  $C_{KL}@20$  of our model are lower than the original SASRec model. For example, the  $C_{KL}@20$  of our model is 0.7046, which is 22.10% better than the

**Table 2** Performances of our models and baselines (best performances are marked in bold)

Datasets	Metrics	SASRec	CaliRec	GC	DACSR
ML-1m	Rec@10	0.2627	0.2624	0.2192	<b>0.2758</b>
	MRR@10	0.1102	0.1027	0.0672	<b>0.1236</b>
	CKL@10	1.3029	0.9943	<b>0.4592</b>	1.0303
	Rec@20	0.3675	0.3656	0.3265	<b>0.3735</b>
	MRR@20	0.1174	0.1098	0.0746	<b>0.1303</b>
	CKL@20	0.9045	0.7619	<b>0.3984</b>	0.7046
Tmall	Rec@10	0.1512	0.1513	0.1513	<b>0.1517</b>
	MRR@10	0.0847	0.083	0.0851	<b>0.0857</b>
	CKL@10	2.4871	2.0604	2.4020	<b>2.0114</b>
	Rec@20	0.1860	<b>0.1869</b>	0.1860	0.1855
	MRR@20	0.0871	0.0855	0.0875	<b>0.0881</b>
	CKL@20	2.1092	1.7894	2.0435	<b>1.6240</b>

0.9045 of the SASRec model. On the Tmall dataset, our model also achieves a 23.00% improvement in terms of  $C_{KL}@20$ . On the two datasets, our DACSR model can achieve more accurate and calibrated recommendation lists, which demonstrates the effectiveness of our model.

We next compare our model with calibrated recommendation models. Compared to the CaliRec model, our model performs better in terms of recommendation accuracy under the same value of the trade-off factor  $\lambda = 0.5$ , which has been analyzed above. For the calibrated recommendation, the performances differ when the evaluation position changes (i.e.,  $K=10$  and  $K=20$ ). For example, on the ML-1m dataset, the  $C_{KL}@20$  of our DACSR model is 0.7046, which is better than the 0.7619 of the CaliRec model. However, the  $C_{KL}@10$  of our model is 1.0303, which is worse than the 0.9943 of the CaliRec model. On the Tmall dataset, the trend is similar. This is because of the difference in the procedure for generating recommendation lists. The CaliRec model followed the greedy ranking strategy, which generates recommendation lists step by step. At each step, it tried to maximize the gain of adding a candidate item to the recommendation list, where the gain is a weighted sum of calibration and accuracy. However, our model generated recommendation lists in an end-to-end way, which computes the scores of all items and selects top- $K$  items with the highest scores. This strategy did not build connections between the rank and calibration, leading to the larger difference between  $C_{KL}@10$  and  $C_{KL}@20$ .

We also observe that the GC model performs differently on the two datasets. On the ML-1m dataset, the GC model achieves the lowest  $C_{KL}$  value

**Table 3** Average time consumption for each sequence.

Response time (s)	MI-1m	Tsmall
SASRec	0.0015	0.0012
CaliRec	0.0644	0.0675
DACSR	0.0039	0.0026

among all models, including our proposed model (e.g., 0.3984 v.s. 0.7046 of  $C_{KL}@20$ ). While on the Tsmall dataset, the GC model cannot provide calibrated recommendation lists. For example, the  $C_{KL}@20$  of GC is 2.0435, which is close to the original SASRec model. We think this phenomenon results from two aspects. On one hand, the number of item categories of the Tsmall dataset is much more than that of the MI-1m dataset. The MI-1m dataset contains 18 different item categories, while the Tsmall dataset has 70 categories. On the other hand, the average length of the user behavior sequence of the Tsmall dataset is less than the MI-1m dataset, as shown in Table 1. The shorter sequence and larger item category set lead to the lower coverage of item categories. The GC model adopts an adaptive selection of the trade-off factor  $\lambda$  based on the coverage of item categories. Therefore, it performs differently on the two datasets.

**Time Consumption** In addition, we also compare the response time of our model against the post-ranking based CaliRec model and the original SASRec model. We conduct experiments on the same device, and remove the GPU acceleration for a fair comparison. The performance is listed in Table 3. Compared to the original SASRec model, our model requires more time to generate results. This is because our model includes individual sequence encoders and the aggregation module. Compared to the CaliRec model, our model costs much less time to generate recommendation lists. For a single sequence, our model only needs 0.0039 and 0.0026 seconds on the MI-1m and Tsmall datasets, respectively. In contrast, the CaliRec requires approximately 0.06 seconds for a sequence, which needs 15 to 20 times more time than our model. This is because CaliRec is a post-processing method, while our model directly computes scores of all items without ranking again. In addition, the ranking procedure which generates final recommendation lists step by step is also time-consuming.

## 5.2 Parameter Influence

In this section, we analyze influence of two hyperparameters  $\lambda$  and  $\tau$ . The trade-off parameter  $\lambda$  controls the importance of calibration during the optimization stage of our model. The parameter  $\tau$  reshapes the predicted scores of all items, which can affect the computation of the calibration loss function.

### 5.2.1 Trade-off Factor $\lambda$

We first analyze the influence of hyperparameter  $\lambda$  by changing it from 0.1 to 1.0. Since the CaliRec model also requires a parameter to control the importance of calibration and accuracy which is similar to our model, we make a comparison between our DACSR model and CaliRec with the parameter tuning. The performances on the two datasets are shown in Fig. 2, where red lines represent our model and blue lines represent the CaliRec model.

In general, the performances of Rec@20 and MRR@20 of our model increase at the beginning, and decrease when  $\lambda$  becomes close to 1.0. This shows that considering users' historical preference distributions can help predict the users' future behaviors. When  $\lambda$  has a high value (e.g.,  $\lambda = 0.7$ ), the performance of Rec@20 of our model decreases greatly, while the CaliRec model does not decrease as large as our model. A possible reason is the difference in the process of generating recommendation lists. The CaliRec re-ranks the candidate list generated by the SASRec model whose size is 100 and finally selects top-K ( $K = 10$  or  $20$ ) items as the final recommendation list. However, our model computes scores of all items, and directly selects top-K items. If we consider much more for calibration, the user's next item will be eliminated from the top-K items. While for post-processing methods, the range of items for re-ranking is narrowed. Therefore, it can preserve the performance of Rec@20. In contrast, our model outperforms CaliRec when considering recommendation accuracy with MRR, which considers the rank of user's next item. As shown in Fig. 2(c) and 2(d), the MRR@20 of our model is always higher than the CaliRec model.

In terms of calibration, our model achieves close performance compared to the CaliRec model under the same  $\lambda$ . As shown in Fig. 2(e), two lines that represent our DACSR model and CaliRec model almost overlap when  $\lambda$  becomes larger. When  $\lambda$  is close to 1, our DACSR model cannot perform as well as the CaliRec model, indicating that there is still room for our loss function to improve. However, a large  $\lambda$  leads to lower recommendation accuracy. Though it achieves better calibration, we do not suggest to use high value of  $\lambda$  because accurately predicting the user's next behavior is still an important concern.

### 5.2.2 Temperature Factor $\tau$

In this section, we analyze the influence of parameter  $\tau$ , which controls the sharpness of the distribution in the calibration loss function. We tune  $\tau$  in  $\{0.25, 0.5, 0.75, 1.0, 1.25, 1.5, 1.75, 2.0\}$ , and show the performances in Fig. 3. Red lines represent the performance of  $MRR@20$  and correspond to the right axis, and green lines stand for the  $C_{KL}@20$  performance which follows the left axis.

From the perspective of calibration, a relatively lower value of  $\tau$  can achieve lower  $C_{KL}@20$  performance. For example, on the MI-1m dataset, the  $C_{KL}@20$  performances are 0.6466 and 0.6915 when  $\tau$  equals to 0.25 and 1.0 respectively. This is because a lower value of  $\tau$  amplifies the scores of top items, and other

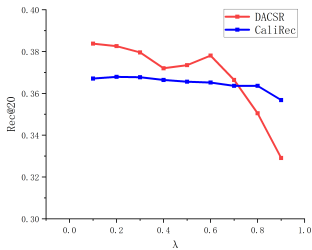

(a) Rec@20 on the ML-1m dataset

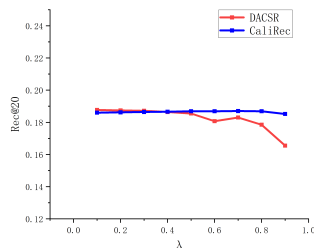

(b) Rec@20 on the Tmall dataset

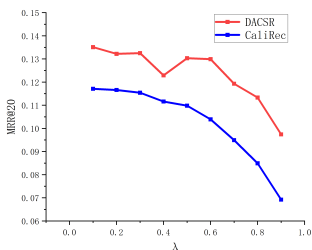

(c) MRR@20 on the ML-1m dataset

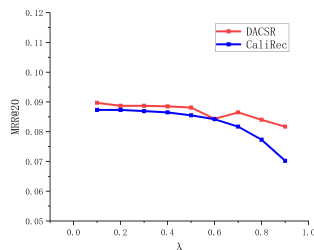

(d) MRR@20 on the Tmall dataset

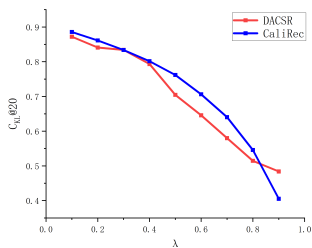
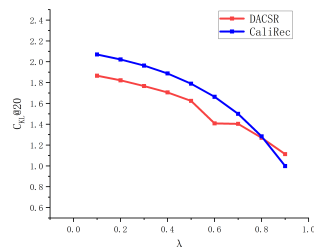
(e)  $C_{KL}@20$  on the ML-1m dataset(f)  $C_{KL}@20$  on the Tmall dataset**Fig. 2** Performance comparison when  $\lambda$  changes.

items are ignored because their scores are normalized to 0. The lower value of  $\tau$  increases the calibration, but decreases the recommendation accuracy as shown by blue lines in Fig. 3. In contrast, a higher value of  $\tau$  ( $\tau > 1$ ) causes a negative impact on calibration, because scores of all items are normalized to close values (i.e.,  $1/|I|$  for all items). Therefore, no useful information for calibration can be propagated to the model. In exchange, the recommendation accuracy is improved.

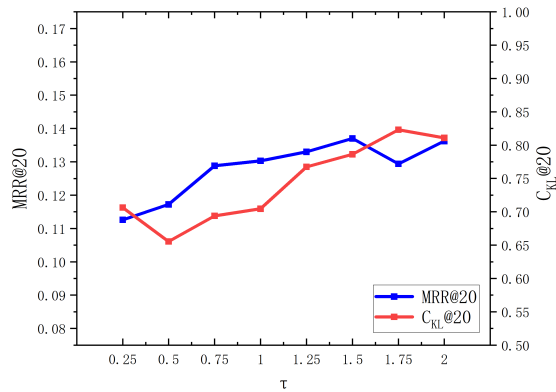

(a) Performance change on the ML-1m dataset

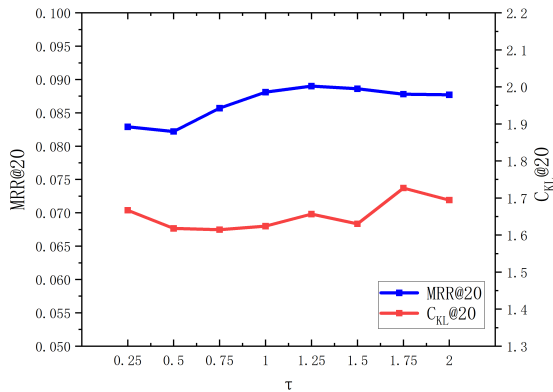

(b) Performance change on the Tmall dataset

**Fig. 3** Performance comparison when  $\tau$  changes.

### 5.3 Ablation Studies

We conduct ablation experiments in this section by comparing our model with two variants. The first variant is the original SASRec model optimized by the loss function  $L_w$ . The other one is the direct concatenation of sequence representations and item embedding matrices without extraction nets (namely DACSR-C). We compare our model with these variants by setting  $\lambda = 0.5$ . The performances are listed in Table 4.

The original SASRec model can provide calibrated recommendation lists by applying our proposed calibration loss function. The  $C_{KL}@20$  of SASRec decreases between Table 2 and 4 (e.g., 2.1092 v.s. 1.7810 on the Tmall



**Table 4** Performance comparisons between our DACSR model and its variants (best performances are marked in bold)

Datasets	Metrics	SASRec	DACSR-C	DACSR
Ml-1m	Rec@10	0.2551	0.271	<b>0.2758</b>
	MRR@10	0.1088	0.1187	<b>0.1236</b>
	CKL@10	1.0780	1.0909	<b>1.0303</b>
	Rec@20	0.3599	0.3719	<b>0.3735</b>
	MRR@20	0.1161	0.1257	<b>0.1303</b>
	CKL@20	0.7281	0.7433	<b>0.7046</b>
Tsmall	Rec@10	0.1508	0.1464	<b>0.1517</b>
	MRR@10	0.0854	0.0813	<b>0.0857</b>
	CKL@10	2.1490	<b>1.9816</b>	2.0114
	Rec@20	0.1830	0.1804	<b>0.1855</b>
	MRR@20	0.0876	0.0837	<b>0.0881</b>
	CKL@20	1.7810	<b>1.5960</b>	1.6240

dataset). This shows the effectiveness of our calibration loss function. However, it achieves a lower recommendation accuracy, especially on the Ml-1m dataset. For example, the  $Rec@10$  of the SASRec model is 0.2551, which is lower than the 0.2627 of the same model merely optimized by  $L_{Acc}$ . Also, the performance of calibration is worse than our model on the Tsmall dataset (1.7198 v.s. 1.6229).

Compared to the DACSR-C variant, our DACSR model also obtains better performance in terms of recommendation accuracy. For example, on the Ml-1m dataset, the  $MRR@20$  of our DACSR model is 0.1303, while it is 0.1257 on for the DACSR-C model. The performance comparison is similar on the Tsmall dataset. In terms of calibration, on the Ml-1m dataset, the  $C_{KL}@20$  of DACSR model is 0.7046, which is better than the 0.7433 of the DACSR-C model. While on the Tsmall dataset, our model achieves 1.6240, which is slightly worse than the 1.5960 of the DACSR-C model. The comparison shows that the extraction net is useful in capturing information for accurate and calibrated recommendation.

## 5.4 Generalization of DACSR Model

Previous sections analyzed the performances of our model with the SASRec sequence encoder. We are interested in whether our model is also effective when the sequence encoder changes. To demonstrate the effectiveness, we incorporate the GRU4Rec model as the sequence encoder, which is also a widely used

**Table 5** Performances of our DACSR model with the GRU4Rec sequence encoder (best performances are marked in bold).

Datasets	Metrics	Rec@20	MRR@20	$C_{KL}@20$
MI-1m	GRU4Rec	0.3329	0.1102	0.8520
	DACSR	<b>0.3478</b>	<b>0.1182</b>	<b>0.6830</b>
Tsmall	GRU4Rec	0.1705	0.0864	2.3517
	DACSR	<b>0.1750</b>	<b>0.0878</b>	<b>1.7266</b>

sequential recommendation model. The experimental settings are same to the SASRec model. The performances are listed in Table. 5.

As shown in the table, our model still achieves more calibrated recommendation lists when using GRU4Rec as the sequence encoder. On the MI-1m dataset, the performances of  $C_{KL}@20$  are 0.6830 and 0.8520 of our DACSR model and the GRU4Rec model, respectively. On the Tsmall dataset, our model also obtains an improvement of 26.58% in terms of calibration. Toward recommendation accuracy, the performances of our model are close to the original GRU4Rec model. Though our model performs slightly worse on the Tsmall dataset, we think that this is because the ability to model sequences of GRU4Rec is worse than the SASRec model. In addition, the item transitions on the Tsmall dataset is more complex than on the MI-1m dataset. Therefore, performances with the SASRec encoder are more stable than with the GRU4Rec encoder. The performance comparisons demonstrate that our model can be adopted to other sequence encoders.

## 5.5 Calibration and Diversity

In this section, we analyze the relation between calibration and diversity under our end-to-end sequential recommendation framework. We replace the user's historical distribution  $p(s)$  with the diversified distribution  $p_d(s)$  (see Eq. 8) when calculating the loss function  $L_w$ . We set the factor  $\tau_{div} = 0.2$  on the two datasets. We adopt the ILD metric [26] with Jaccard similarity to measure the diversity of the recommendation list:

$$ILD(s) = \frac{2}{|RL_s| (|RL_s| - 1)} \sum_{(i,j \in RL_s)} \left(1 - \frac{|Cate_i \cap Cate_j|}{|Cate_i \cup Cate_j|}\right)$$

where  $Cate_i$  is the item category set that the item  $i$  has. The larger ILD value represents the higher diversity of the recommendation list. We compare the  $p_d(s)$  distribution with the original SASRec model and the DACSR model, and list performances in Table 6.

On the MI-1m dataset, our DACSR model can obtain more calibrated and diversified recommendation lists than the original SASRec model. By adopting  $p_d(s)$ , our model can further improve the performances in terms of calibration

**Table 6** Performances of calibration and diversity (best performances are marked in bold)

Datasets	Models	ILD@10	CKL@10	ILD@20	CKL@20
MI-1m	SASRec	0.6356	1.3029	0.6584	0.9045
	DACSR- $p(s)$	0.6593	1.0303	0.6736	0.7046
	DACSR- $p_d(s)$	<b>0.7115</b>	<b>0.9028</b>	<b>0.7237</b>	<b>0.5595</b>
Tsmall	SASRec	<b>0.7086</b>	2.4871	<b>0.7405</b>	2.1092
	DACSR- $p(s)$	0.6714	<b>2.0114</b>	0.7045	<b>1.624</b>
	DACSR- $p_d(s)$	0.7060	2.3064	0.7324	1.9130

and diversity. However, on the Tsmall dataset, our DACSR model achieves worse performance in terms of diversity (e.g., 0.6714 v.s. 0.7086 of DACSR and SASRec model). When the  $p_d(s)$  distribution is applied, the performance of diversity is improved. However, it satisfies the calibration. We deem that this is because of the difference between two datasets, which also resulted in the different performance of the GC model. On the MI-1m dataset, the coverage of item categories is higher than the Tsmall dataset. On the Tsmall dataset, users always interacted with several types of items, while  $p(g | s)$  score of other categories equals to 0. The limited interest areas resulted in less diversified recommendation lists under the calibration objective.

## 6 Discussion

In this paper, we proposed the DACSR model to provide accurate and calibrated recommendation lists for end-to-end sequential recommendation. The performances on benchmark datasets have shown that our model outperforms the baseline models. We also analyzed the performance changes under different parameter settings. In addition, we compared our model with variants to demonstrate the effectiveness of our model. Though our model can achieve improvement to a certain extent, there are some limitations in our work:

- First, our work evaluates calibration by the consistency of distributions between users' historical behaviors and recommendation lists according to  $C_{KL}$  metric provided by [15]. However, this metric does not consider the calibration at each ranking position. Meanwhile, our model also does not take such a factor into account, because the calibration loss function we proposed only measured the distribution consistency of top-K recommendation lists.
- Next, our proposed model improved the sequence encoder via designing the calibration loss function and Decoupled-Aggregated framework, which is a performance-oriented solution. However, we did not investigate the reasons that cause the miscalibration and incorporate reasons to make a calibrated

recommendation. For example, previous work has shown there exists correlations between popularity bias and miscalibration [31]. This can be our future work.

- Finally, the fusion of calibration and sequential recommendation can be improved. Our DACSR model modified the prediction layer of the sequential recommendation model. However, the prediction layer are structured in a variety of ways in existing studies. Our work has improved on part of the representative studies. Therefore, it is worth designing models that can fit more existing sequential recommendation models.

## 7 Conclusion and Future Work

In this paper, we propose a DACSR model to provide accurate and calibrated results for end-to-end sequential recommendation. We propose a loss function that estimates the item category distribution of the recommendation list by predicted scores of all items. In addition, we propose a Decoupled-Aggregated framework to improve the recommendations. The framework includes two individual sequence encoders and is optimized by the goals of accuracy and calibration separately. Then we utilize an aggregation module to extract information from two sequence encoders for a better recommendation. Experiments on the two benchmark datasets demonstrate the effectiveness of our model. In addition, the time consumption of our model in prediction is much less than post-processing models.

For the future work, we first aim to investigate the evaluation protocol of calibrated recommendation, which considers performances at each ranking position. We are interested in designing loss functions and advanced model structures to improve the performance of calibration and accuracy. Meanwhile, we are also interested in the reasons for miscalibration. From the model perspective, causal inference is our future direction. We also plan to investigate the user's profile to find other factors that may cause miscalibration. Finally, we decide to propose new training paradigms for the calibrated sequential recommendation. Incorporating contrastive learning to debias in sequential recommendation is one of our future directions.

## References

- [1] Hidasi, B., Karatzoglou, A., Baltrunas, L., Tikk, D.: Session-based recommendations with recurrent neural networks. In: Proceedings of the International Conference on Learning Representations, ICLR 2016 (2016)
- [2] Chang, J., Gao, C., Zheng, Y., Hui, Y., Niu, Y., Song, Y., Jin, D., Li, Y.: Sequential recommendation with graph neural networks. In: Proceedings of the ACM SIGIR Conference on Research and Development in Information Retrieval, 2021, pp. 378–387 (2021). <https://doi.org/10.1145/3404835.3462968>

- [3] Wu, S., Tang, Y., Zhu, Y., Wang, L., Xie, X., Tan, T.: Session-based recommendation with graph neural networks. In: Proceedings of the AAAI Conference on Artificial Intelligence, AAAI 2019, pp. 346–353 (2019). <https://doi.org/10.1609/aaai.v33i01.3301346>
- [4] Huang, J., Zhao, W.X., Dou, H., Wen, J.-R., Chang, E.Y.: Improving sequential recommendation with knowledge-enhanced memory networks. In: The 41st International ACM SIGIR Conference on Research & Development in Information Retrieval, SIGIR 2018, pp. 505–514 (2018). <https://doi.org/10.1145/3209978.3210017>
- [5] Lu, Y., Zhang, S., Huang, Y., Wang, L., Yu, X., Zhao, Z., Wu, F.: Future-aware diverse trends framework for recommendation. In: The Web Conference, 2021, pp. 2992–3001 (2021). <https://doi.org/10.1145/3442381.3449791>
- [6] Cen, Y., Zhang, J., Zou, X., Zhou, C., Yang, H., Tang, J.: Controllable multi-interest framework for recommendation. In: The 26th ACM SIGKDD Conference on Knowledge Discovery and Data Mining, 2020, pp. 2942–2951 (2020). <https://doi.org/10.1145/3394486.3403344>
- [7] Zheng, Y., Gao, C., Chen, L., Jin, D., Li, Y.: DGCN: diversified recommendation with graph convolutional networks. In: Proceedings of The Web Conference, 2021, pp. 401–412 (2021). <https://doi.org/10.1145/3442381.3449835>
- [8] Parapar, J., Radlinski, F.: Towards unified metrics for accuracy and diversity for recommender systems. In: Proceedings of The Fifteenth ACM Conference on Recommender Systems, 2021, pp. 75–84 (2021). <https://doi.org/10.1145/3460231.3474234>
- [9] Liu, S., Zheng, Y.: Long-tail session-based recommendation. In: Proceedings of the ACM Conference on Recommender Systems, RecSys 2020, pp. 509–514 (2020). <https://doi.org/10.1145/3383313.3412222>
- [10] Kim, Y., Kim, K., Park, C., Yu, H.: Sequential and diverse recommendation with long tail. In: IJCAI 2019, pp. 2740–2746 (2019)
- [11] Sreepada, R.S., Patra, B.K.: Mitigating long tail effect in recommendations using few shot learning technique. *Expert Systems with Applications*. **140** (2020). <https://doi.org/10.1016/j.eswa.2019.112887>
- [12] Chen, L., Yang, Y., Wang, N., Yang, K., Yuan, Q.: How serendipity improves user satisfaction with recommendations? A large-scale user evaluation. In: Proceedings of The World Wide Web Conference, 2019, pp. 240–250 (2019). <https://doi.org/10.1145/3308558.3313469>

- [13] Xu, Y., Yang, Y., Wang, E., Han, J., Zhuang, F., Yu, Z., Xiong, H.: Neural serendipity recommendation: Exploring the balance between accuracy and novelty with sparse explicit feedback. *ACM Transactions on Knowledge Discovery from Data* **14**(4), 50–15025 (2020). <https://doi.org/10.1145/3396607>
- [14] Li, P., Que, M., Jiang, Z., Hu, Y., Tuzhilin, A.: PURS: personalized unexpected recommender system for improving user satisfaction. In: Fourteenth ACM Conference on Recommender Systems, 2020, pp. 279–288 (2020). <https://doi.org/10.1145/3383313.3412238>
- [15] Steck, H.: Calibrated recommendations. In: Proceedings of the ACM Conference on Recommender Systems, RecSys 2018, pp. 154–162 (2018). <https://doi.org/10.1145/3240323.3240372>
- [16] Kaya, M., Bridge, D.G.: A comparison of calibrated and intent-aware recommendations. In: Bogers, T., Said, A., Brusilovsky, P., Tikk, D. (eds.) Proceedings of the ACM Conference on Recommender Systems, 2019, pp. 151–159 (2019). <https://doi.org/10.1145/3298689.3347045>
- [17] Seymen, S., Abdollahpouri, H., Malthouse, E.C.: A constrained optimization approach for calibrated recommendations. In: Proceedings of the ACM Conference on Recommender Systems, 2021, pp. 607–612 (2021). <https://doi.org/10.1145/3460231.3478857>
- [18] da Silva, D.C., Manzato, M.G., Durão, F.A.: Exploiting personalized calibration and metrics for fairness recommendation. *Expert Syst. Appl.* **181**, 115112 (2021). <https://doi.org/10.1016/j.eswa.2021.115112>
- [19] Li, J., Ren, P., Chen, Z., Ren, Z., Lian, T., Ma, J.: Neural attentive session-based recommendation. In: Proceedings of the ACM on Conference on Information and Knowledge Management, CIKM 2017, pp. 1419–1428 (2017). <https://doi.org/10.1145/3132847.3132926>
- [20] Tang, J., Wang, K.: Personalized top-n sequential recommendation via convolutional sequence embedding. In: Proceedings of the ACM International Conference on Web Search and Data Mining, 2018, pp. 565–573 (2018). <https://doi.org/10.1145/3159652.3159656>
- [21] Kang, W., McAuley, J.J.: Self-attentive sequential recommendation. In: Proceedings of the IEEE International Conference on Data Mining, 2018, pp. 197–206 (2018). <https://doi.org/10.1109/ICDM.2018.00035>
- [22] Xu, C., Feng, J., Zhao, P., Zhuang, F., Wang, D., Liu, Y., Sheng, V.S.: Long- and short-term self-attention network for sequential recommendation. *Neurocomputing* **423**, 580–589 (2021). <https://doi.org/10.1016/j.neucom.2020.10.066>

- [23] Sun, F., Liu, J., Wu, J., Pei, C., Lin, X., Ou, W., Jiang, P.: Bert4rec: Sequential recommendation with bidirectional encoder representations from transformer. In: Proceedings of the International Conference on Information and Knowledge Management, 2019, pp. 1441–1450 (2019). <https://doi.org/10.1145/3357384.3357895>
- [24] de Souza Pereira Moreira, G., Rabhi, S., Lee, J.M., Ak, R., Oldridge, E.: Transformers4rec: Bridging the gap between NLP and sequential / session-based recommendation. In: Proceedings of the ACM Conference on Recommender Systems, 2021, pp. 143–153 (2021). <https://doi.org/10.1145/3460231.3474255>
- [25] Wang, Z., Wei, W., Cong, G., Li, X., Mao, X., Qiu, M.: Global context enhanced graph neural networks for session-based recommendation. In: Proceedings of the International ACM SIGIR Conference on Research and Development in Information Retrieval, SIGIR 2020, pp. 169–178 (2020). <https://doi.org/10.1145/3397271.3401142>
- [26] Chen, W., Ren, P., Cai, F., Sun, F., de Rijke, M.: Improving end-to-end sequential recommendations with intent-aware diversification. In: The International Conference on Information and Knowledge Management, 2020, pp. 175–184 (2020). <https://doi.org/10.1145/3340531.3411897>
- [27] Tan, Q., Zhang, J., Yao, J., Liu, N., Zhou, J., Yang, H., Hu, X.: In: Proceedings of the ACM International Conference on Web Search and Data Mining, 2021, pp. 598–606 (2021). <https://doi.org/10.1145/3437963.3441811>
- [28] Abdollahpouri, H., Mansoury, M., Burke, R., Mobasher, B.: The connection between popularity bias, calibration, and fairness in recommendation. In: Proceedings of the ACM Conference on Recommender Systems, 2020, pp. 726–731 (2020). <https://doi.org/10.1145/3383313.3418487>
- [29] Zhang, L., Wang, P., Li, J., Xiao, Z., Shi, H.: Attentive hybrid recurrent neural networks for sequential recommendation. *Neural Computing and Applications* **33**(17), 11091–11105 (2021). <https://doi.org/10.1007/s00521-020-05643-7>
- [30] Kingma, D.P., Ba, J.: Adam: A method for stochastic optimization. In: Proceedings of the International Conference on Learning Representations, ICLR 2015 (2015)
- [31] Abdollahpouri, H., Mansoury, M., Burke, R., Mobasher, B.: The connection between popularity bias, calibration, and fairness in recommendation. In: Proceedings of the ACM Conference on Recommender Systems, Recsys 2020, pp. 726–731 (2020). <https://doi.org/10.1145/3383313.3418487>