

DACSR: Dual-Aggregation End-to-End Calibrated Sequential Recommendation

Jiayi Chen¹, Wen Wu^{1*}, Liye Shi¹, Wei Zheng² and Liang He¹

¹School of Computer Science and Technology, East China Normal University, 200062, Shanghai, China.

²Party Working Committee, East China Normal University, 200062, Shanghai, China.

*Corresponding author(s). E-mail(s): wwu@cc.ecnu.edu.cn;
Contributing authors: jychen@ica.stc.sh.cn; lyshi@ica.stc.sh.cn;
wzheng@admin.ecnu.edu.cn; lhe@cs.ecnu.edu.cn;

Abstract

Recent years have witnessed the progress of sequential recommendation in accurately predicting users' future behaviors. However, only persuading accuracy leads to the risk of filter bubbles where recommenders only focus on users' main interest areas. Different from other studies which improves diversity or coverage, we investigate the calibration in sequential recommendation. However, existing calibrated methods followed a post-processing paradigm, which costs more computation time and sacrifices the recommendation accuracy. To this end, we propose an end-to-end framework to provide both accurate and calibrated recommendations. We propose a loss function to measure the divergence of distributions between recommendation lists and historical behaviors for sequential recommendation framework. In addition, we design a dual-aggregation model which extract information from two individual sequence encoders with different objectives to further improve the recommendation. Experiments on two benchmark datasets demonstrate the effectiveness and efficiency of our model.

Keywords: Sequential Recommendation, Calibrated Recommendation, End-to-End

1 Introduction

Recommender systems aim to help users find their interests among large-scale items. In recent years, sequential recommendation has achieved great attention, which predicts users' preference according to sequences of historical behaviors. Previous studies focused on how to model users' sequences and obtain better representations, and have progressed in sequential recommendation community. The major evaluations of sequential recommendation models are accuracy-based metrics, such as Recall and NDCG. However, only seeking for high accuracy may bring the risk of filter bubbles. The recommender systems tend to provide skewed recommendation lists which only focus on users' major interest area. Therefore, some studies measure the quality of recommendation lists from other perspectives, such as diversity [1–3], coverage [4] and unexpectedness [5].

The calibrated recommendation aims to provide recommendation lists which is consistent with the spectrum of items of the user's historical behaviors [6]. For example, if a user has watched 70% action movies and 30% comedies, a fully calibrated recommendation list should contain action and comedy movies with this ratio. Existing studies in calibrated recommendations followed a post-ranking paradigm, which rank items from a candidate list which is generated by a basic recommendation model. For example, Steck proposed a heuristic ranking model with a trade-off weight which controls the importance of accuracy and calibration [6]. Although such a method can achieve calibrated recommendation list by tuning the trade-off weight, there are two issues that can be investigated. One is that the re-ranking model takes extra computations, resulting in more response time. These models apply an extra ranking stage which generate results step by step. In each step, the model needs to compute gains of candidates. Another issue is that a high weight on calibration is harmful to recommendation accuracy. The ranking model considers more for calibration at each step where the user's next item obtains less score and has a lower ranking position. Therefore, the recommendation accuracy is affected, especially the ranking performance.

Therefore, we handle calibration in sequential recommendation from two aspects. Firstly, we provide a loss function for calibration. We combine the prediction scores of all items and the item category information to estimate the distribution of recommendation list. Then we use cosine similarity to measure the consistency of the recommendation and historical distribution. Next, we propose a dual-aggregation model, namely "DACSR", to provide accurate and calibrated recommendations. Concretely, we utilize two individual sequence encoders which only focus on accuracy and calibration, respectively. Then we apply an aggregation module to extract information from two sequence encoders, and make predictions optimized by a trade-off between calibration and accuracy.

The contributions of this paper are listed as follows:

- We propose end-to-end framework to provide accurate and calibrated recommendation lists for sequential recommendation.
- We design a calibration loss function for model optimization. In addition, we propose a dual-aggregation model which aggregates information from individual sequence encoders to ensure accuracy and improve the calibration.
- Experiments on benchmark datasets show that our model can achieve higher accuracy. In addition, recommendation lists of our model are more calibrated than baseline models.

The rest of this paper is organized as follows. We review the existing literature in Sec. 2. Then we introduce our model in Sec. 3 and the experimental details in Sec. 4. We show the experimental results and analysis in Sec. 5. Finally, we discuss our work in Sec. 6 and conclude our paper and indicate some future work in Sec. 7.

2 Related Work

2.1 Sequential Recommendation

Sequential recommendation relies on users' historical behavior sequences to predict their future behaviors. Existing studies focused on modeling sequences and obtain better sequence representations to achieve higher recommendation accuracy. Hidasi et al. first utilized Gate Recurrent Units for sequential recommendations and provided parallel training strategy [7]. Li et al. further proposed attention mechanism to capture main purposes of the sequence [8]. Caser utilized CNNs to extract information from short-term sequences [9]. With the development of self attention, self attentive based models were proposed to achieve better sequence representations. For example, SASRec applied self attentive mechanism to learn both long-term and short-term preference of user behavior sequences, which achieved satisfactory performance of recommendation accuracy [10]. In addition, transformer-based sequence encoders were proposed, such as BERT4Rec and Transformer4Rec [11, 12]. In recent years, graph neural networks were also utilized for sequential recommendation [13–15]. For example, Wu et al. applied GGNN to learn item transitions from historical behaviors which treated sequences as graphs [13]. In addition, multi-interest-based models were proposed that are different from above methods which encode sequence into a single vector [2, 3, 16, 17].

2.2 Calibrated Recommendation

Existing sequential recommendation models achieved satisfactory recommendation accuracy. However, these algorithms tended to generate skewed recommendation lists which focus on users' main interest area, leading to the risk of filter bubbles [4, 6]. Therefore, recent studies evaluated sequential recommendation algorithms by different metrics, such as diversity [2, 3, 16], coverage [4] and unexpectedness [5]. In recent years, calibration was proposed, which aimed to generate recommendation lists whose genre distribution are

less divergent with the users profile [6]. In [6], the author also provided a post-processing greedy re-ranking model which considered both accuracy and calibration at each step of generating results. Abdollahpouri et al. studied the connections between popularity bias and calibration [18]. They found that users who are affected more by popularity bias tend to achieve less calibrated recommendation lists. Kaya and Bridge compared intent-aware algorithms and calibration algorithms [19]. They found that the diversity-oriented intent-aware models can achieve calibrated recommendations and calibration-oriented models can obtain diversity to some extent. Seyman et al. proposed weighted total variation to measure the consistency between two distributions and a constrained optimization model to improve the ranking stage for calibration [20]. Silva et al. proposed new metrics to evaluate calibrated recommendations and adaptive selection strategies for the trade-off weight in the post-processing algorithms [21].

Although these calibration methods progressed in collaborative filtering, few studies focused on sequential recommendation. In addition, these methods requires a post-process stage, which needs more time consumption for recommendation. Therefore, we investigate the end-to-end framework for calibrated sequential recommendation, which does not require a post-processing stage. In addition, we attempt to propose models which can obtain satisfactory calibration and cause less reduction on recommendation accuracy.

3 Methodology

3.1 The Sequential Recommendation Paradigm

The sequential recommendation provide items based on users' historical behavior sequences. In general, it can be decomposed into two parts, the sequence encoder and the prediction layer. The sequence encoder takes the historical behavior sequence as the input, and represent it to vector. Formally, the procedure can be written as:

$$\begin{aligned} h &= f(s | E^I, \theta, L) \\ s &= \{x_1, x_2, \dots, x_T\} \end{aligned}$$

where $f(\cdot)$ is the sequence encoder and h is the sequence representation of sequence s . E^I represents the item embedding matrix of all items I , and θ stands for the parameters of the sequence encoder. L is the loss function which is used to optimize the sequence encoder f .

The sequence representation h is further used to predict the score of all items. The prediction layer is usually a linear transformation layer:

$$\hat{y} = Wh^T + b \tag{1}$$

where W and b are $|I| \times d$ and $|I|$ dimensional learnable parameters. A common setting is that W is the item embedding matrix which is used in f

and bias b is removed:

$$\hat{y} = E_I h^T \quad (2)$$

where E_I is the item embedding matrix. This prediction layer is widely used in existing studies [8, 10, 13], and we also follow this setting in our work.

3.2 Item Category Distributions

In our work, we use the same formulation proposed by [6] to define the distributions.

- $p(s)$ is the genre distribution from the sequence s . For each genre g , the distribution value is computed as:

$$p(g | s) = \frac{\sum_{x \in s} p(g | x)}{|s|} \quad (3)$$

where $p(g | x)$ is the indicator function of item x and category g , which satisfies $\sum_{g \in G} p(g | x) = 1$. If item x does not contain category g , the value of $p(g | x)$ is 0. If the item contains two categories, the value of $p(g | x)$ equals to 0.5 for each category g . Finally, the category distribution can be represented as a G -dimensional vector $\{p(g = 1 | x), p(g = 2 | x), \dots, p(g = G | x)\}$, where $|G|$ is the total amount of genres.

- $q(s)$ is the genre distribution of the recommendation list. For each genre g , the distribution value is computed as:

$$q(g | RL) = \frac{\sum_{x \in RL} p(g | x)}{K} \quad (4)$$

where RL is the recommendation list, and K is the size of RL . Similar to $p(s)$, the distribution $q(s)$ can also be represented as a G -dimensional vector $\{q(g = 1 | x), q(g = 2 | x), \dots, q(g = G | x)\}$.

Note that although [6] added a weight for each item in s and RL , the weight was equal to 1 in [6] and following studies, which is equivalent to our work.

3.3 The Proposed Model

We first introduce the loss function of our model, and show our model next.

3.3.1 The Calibration Loss

To generate a calibrated recommendation list, we design the loss function for the model training. The calibration measures the consistency between the recommendation list and the historical sequence. The distribution of historical sequence $p(s)$ can be computed as Eq. 3. We estimate the distribution of the

recommendation list $q(s)$ as follows:

$$\hat{q}(g | s) = \sum_i^{|I|} \hat{y}_i \cdot p(g | i) \quad (5)$$

$$\hat{y}_i = \text{softmax}(\hat{y}_i / \tau) \quad (6)$$

where \hat{y}_i is the score of the item i predicted by the model, and it is further processed by a softmax function. If an item have more prediction score, it contributes more to $\hat{q}(g | s)$. The softmax function also amplifies the difference in scores. Items with high scores will still be given higher weights, while weights of other items are close to 0. Therefore, we can use the above equation to estimate the category distribution $q(s)$ of the recommendation list with Top-K items. τ ($\tau > 0$) is the temperature parameter of softmax function. If $\tau < 1$, the score distribution becomes sharper and items with higher scores get more emphasis. In contrast, an extremely large value of τ will make the score distribution more uniform.

After estimating $q(s)$, we define the loss function of calibration as:

$$L_{Calib} = 1 - \text{cos}(\hat{q}(s), p(s)) \quad (7)$$

where $\hat{q}(s)$ is the estimated distribution vector $\{\hat{q}(g = 1 | s), \dots, \hat{q}(g = G | s)\}$ and cos is the cosine similarity between two vectors. If the two distributions are more consistency, the value of L_{Calib} will be lower.

3.4 The Dual-Aggregation Framework

In this section, we introduce the Dual-Aggregation framework in detail. The general framework is shown in Fig. 1.

3.4.1 Single Model with Weighted Loss Function

As shown in Fig. 1 (b), to obtain calibrated recommendation list, an intuitive way is to optimize the model by a weighted sum of accuracy-based and calibration-based loss functions:

$$L_w = (1 - \lambda) \cdot L_{Acc}(y, \hat{y}) + \lambda \cdot L_{Calib}(I, \hat{y}) \quad (8)$$

where λ is the trade-off factor. Larger λ means we consider more on calibration. $L_{Acc}(y, \hat{y})$ is the accuracy-based loss function. Following previous work, we use cross entropy as the loss function:

$$L_{Acc}(y, \hat{y}) = \sum_{i=0}^{|I|} y_i \log(\hat{y}_i) \quad (9)$$

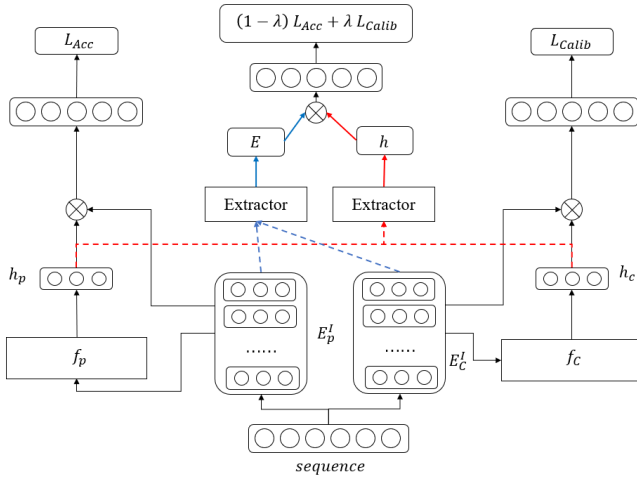

(a) The architecture of the DACSR model

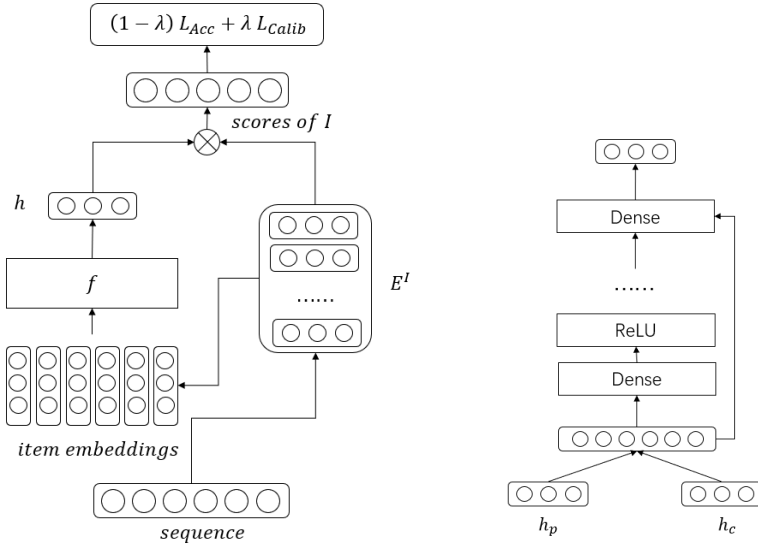

(b) The architecture of the direct optimization model

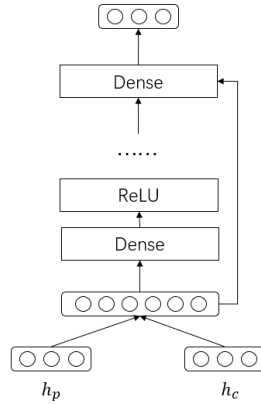

(c) The extractor

Fig. 1 The architecture of the DACSR model.

where $y_i = 1$ means item i is the next item of the sequence, and 0 otherwise. The sequence encoder can be written as:

$$h = f(s | E^I, \theta, L_w) \quad (10)$$

which means the sequence representation h is generated by sequence encoder f which has the item embedding matrix E^I and parameters θ , and is optimized

according to the loss function L_w . We follow Eq. 2 to generate the scores of all items by h and E^I .

3.4.2 Dual-Aggregation Framework

The single model with weighted loss function encodes the user's intentions for accurate prediction and calibration into a single vector. However, encoding into a vector is hard to represent the user's diverse intentions. Therefore, we propose our Dual-Aggregation model, which includes two basic sequence encoders, as shown in Fig. 1 (a). The two sequence encoders are optimized separately. One is to accurately predict the next behavior, while the other one is to provide fully calibrated recommendation list. Formally, this can be represented as:

$$h_p = f_p(s | E_p^I, \theta_p, L_{Acc}) \quad (11)$$

$$h_c = f_c(s | E_c^I, \theta_c, L_{Calib}) \quad (12)$$

where f_p and f_c are two different sequence encoders with different parameters and objective functions. E_p^I and E_c^I are item embedding matrices of the two sequence encoders. θ_p and θ_c are their parameters. Note that the two encoders do not share same parameters and item embedding matrices, and are optimized by their unique loss functions L_{Acc} and L_{Calib} .

Next, we use the sequence representations and item embeddings of the two encoders to provide calibrated recommendation list. The core idea is that we extract useful information from both sequence representations and item embedding matrices. The extraction layer is shown in Fig. 1 (c). We first concatenate the sequence representations h_p and h_c , and serve it with a Feed-forward network:

$$h^0 = W_u^0[h_p, h_c] + b_u^0 \quad (13)$$

$$h^1 = W_u^1\sigma(h^0) + b_u^1 \quad (14)$$

$$h^t = W_u^t\sigma(h^{t-1}) + b_u^t \quad (15)$$

where $W_u^0, W_u^1, \dots, W_u^t$ and $b_u^0, b_u^1, \dots, b_u^t$ are $d \times d$ and d dimensional parameters need to learn. $[h_p, h_c]$ is the concatenation execution for sequence representations h_p and h_c . σ is the activation function. In our work, we use ReLU as the activation function. Finally, we obtain the sequence representation as:

$$h = W_u(h^t + [h_p, h_c]) + b_u \quad (16)$$

where W_u and b_u are $2d \times d$ and d dimensional matrices which need to learn. Here we add the original concatenation $[h_p, h_c]$ and the output of FFN h^t as the input of the final layer.

We also aggregate the item embeddings from two sequence encoders similarly. For a certain item j , we first concatenate its embeddings from two

encoders, and feed it to the FFN network.

$$E_j^0 = W_i^0[E_p^j, E_c^j] + b_i^0 \quad (17)$$

$$E_j^1 = W_i^1\sigma(E_j^0) + b_i^1 \quad (18)$$

$$E_j^t = W_i^t\sigma(E_j^{t-1}) + b_i^t \quad (19)$$

$$E_j = W_i(E_j^t + [E_j^p, E_j^c]) + b_i \quad (20)$$

where $W_i^0, W_i^1, \dots, W_i^t$ and $b_u^0, b_u^1, \dots, b_u^t$ are parameters whose dimensions are same to the extraction layer for sequence representations. Finally, the score of item j is computed as:

$$\hat{y}_j = E_j h^T \quad (21)$$

Model Training As shown in Fig. 1 (a), the model aggregates the representations and embeddings from two individual sequence encoders f_p and f_c . During the training phase, the loss function of the aggregation module is Eq. 8, which considers both accuracy and calibration. However, parameters and embeddings of encoders f_p and f_c are not updated by Eq. 8, because they have own optimization objectives. To accelerate the training process, we pre-trained the sequence encoder f_p , and initialize the sequence encoder f_c with f_p .

4 Experiments

To demonstrate the effectiveness of our model, we conducted experiments on real-world datasets and compared our model with existing models.

4.1 Dataset

We adopted two commonly-used benchmark datasets to evaluate the performance of our model. The first one is *Movielens-1m*¹, which contains interaction logs of more than 6000 users and 3000 movies. The other is *Tmall*², which includes user behavior logs on an e-commerce platform. For both datasets, we sort each user's behaviors according to the timestamp. We follow a 5-core strategy that removes the users and items whose number of occurrence is less than 5. We also apply the leave-one-out evaluation protocol. The most latest clicked item of a user belongs to the testing set, and the previous one of this item belongs to the validation set. The remaining sequences construct the training set. To augment the training data, we extend the user's sequence following [8, 13]. The statistics are listed in Table 1.

4.2 Comparison Models

We selected the following methods as baselines:

¹<https://grouplens.org/datasets/movielens/1m>

²<https://tianchi.aliyun.com/dataset/dataDetail?dataId=53>

Table 1 Statistics of Datasets

Statistics	MI-1m	Tsmall
Number of users	6,040	31,854
Number of Items	3,883	58,343
Number of Training Sequences	981,504	832,603
Number of Testing Sequences	6,040	672,519
Number of Categories	18	71
Average Sequence Length	164.50	28.13

- **SASRec** [10] is a self-attentive based sequential recommendation model, and is a strong baseline. We apply the SASRec model as the sequence encoder for f_p and f_c , and compare our model with SASRec.
- **CaliRec** [6] is a post-processing model which re-ranks the results generated by the sequence encoder. It makes a trade-off between accuracy and calibration at each time step.
- **GC** [21] utilizes an adaptive selection for the trade-off factor. The higher coverage of item categories of the user historical sequence results in more consideration for calibration.

4.3 Evaluation Metrics

We evaluate models from accuracy and calibration perspectives. Following previous work[8, 13], we use Recall and MRR as evaluation metrics.

- **Recall@K** (Rec@K) is a widely used metric in recommendation and information retrieval areas. Recall@K computes the proportion of correct items in the top-N items of the list.

$$Recall@K = \frac{1}{N} \sum_s 1(x_{n+1} \in RL_s) \quad (22)$$

where $1(\cdot)$ is an indication function whose value equals 1 when the condition in brackets is satisfied and 0 otherwise.

- **MRR@K** is another important metric that considers the rank of correct items. The score is computed by the reciprocal rank when the rank is within N; otherwise the score is 0.

$$MRR@K = \frac{1}{\|N\|} \sum_s \frac{1}{rank(x_{n+1}, RL_s)} \quad (23)$$

To evaluate the effectiveness in terms of calibration, we adopt C_{KL} which is a common metric used for calibrated recommendation [6]. The C_{KL} compares the consistency between two distribution:

$$C_{KL}(RL, s) = \frac{1}{N} \sum_s \sum_{g \in G} q(g | s) \frac{q(g | s)}{p(g | s)} \quad (24)$$

where N is the number of testing cases. The lower C_{KL} value means we provide more calibrated recommendation lists.

4.4 Experimental Setup

We use grid search to find the optimal hyperparameters on the validation dataset. The dimension of hidden states is tuned from 32, 64, 128, 256, following. We tune the learning rate from $\{0.1, 0.01, 0.001\}$. We use the Adam [22] optimizer with a batch size of 128. We report the performance under the model parameters with the optimal prediction accuracy on the validation set. We make hyper-parameter $\lambda = 0.5$ and $\tau = 1$ as the default setting, and analyze the influence of them in following sections. For the top- K recommendation, we set $K = 10$ and 20 which is a common setting.

5 Results and Analysis

We aim to answer the following research questions by conducting the experiments:

- **RQ1:** Does our DACSR model outperform the baselines in terms of recommendation accuracy and calibration?
- **RQ2:** How well does the DACSR model perform when hyperparameters change?
- **RQ3:** How about the effectiveness of the Dual-Aggregation framework of our DACSR model?

5.1 RQ1: Overall Performance

The performances of baselines and our model are listed in Table ??, where the best performance is marked in bold. In general, our model achieves better prediction accuracy compared to the state-of-the-art SBR models, and outperforms these baseline models in terms of calibration.

We first analyze the performance from the perspective of accurate recommendation (i.e., Rec@20 and MRR@20). On both datasets, our model achieves best prediction accuracy in terms of Recall and MRR. On the ML-1m dataset, the Recall and MRR of our model are slightly higher than the original SAS-Rec model (e.g., 0.1179 v.s. 0.1137 in terms of MRR@10). Compared to the CaliRec model and GC model, our model can provide much more accurate recommendation results. For example, the MRR@20 of our model is 0.1252, while it is 0.1114 and 0.0813 for CaliRec and GC, with the improvement of 12.38% and 54.00%, respectively. On the Tmall dataset, our model can still achieve the best recommendation accuracy. This implies that considering calibration can contribute to accurate recommendation.

From the calibration perspective, our model can provide more calibrated recommendation lists compared to the original sequential recommendation model. On both datasets, $C_{KL}@10$ and $C_{KL}@20$ of our model are lower than

Table 2 The overall performance of our model and baselines.

Datasets	Metrics	SASRec	CaliRec	GC	DACSR
MI-1m	Rec@10	0.2647	0.2639	0.2325	0.2669
	MRR@10	0.1137	0.1062	0.0736	0.1179
	CKL@10	1.2189	0.9243	0.4844	1.0244
	Rec@20	0.3675	0.368	0.3447	0.3724
	MRR@20	0.1207	0.1133	0.0813	0.1252
	CKL@20	0.8398	0.706	0.4176	0.6846
Tmall	Rec@10	0.1512	0.1513	0.1513	0.1551
	MRR@10	0.0847	0.083	0.0851	0.0883
	CKL@10	2.4871	2.0604	2.402	2.2415
	Rec@20	0.186	0.1869	0.186	0.1877
	MRR@20	0.0871	0.0855	0.0875	0.0906
	CKL@20	2.1092	1.7894	2.0435	1.868

the original SASRec model, which demonstrates the effectiveness of our proposed model. For example, the $C_{KL}@20$ of our model is 0.6846, which is 18.48% lower than SASRec. On the Tmall dataset, our model also achieves approximately 11% improvement in terms of calibration. Compared to the state-of-the-art GC model, our model performs differently on the two datasets. On the MI-1m dataset, the GC model achieves the lowest C_{KL} value among all models, including our proposed model (e.g., 0.4176 v.s. 0.6846 of $C_{KL}@20$). While on the Tmall dataset, the GC model cannot achieve competitive performance against our model and CaliRec. For example, the $C_{KL}@20$ of GC is 2.0435, which is close to the original SASRec model. We think this phenomenon results from the numbers of item categories of the two datasets. The MI-1m dataset contains 18 different item categories, while the Tmall dataset has 71 categories, which is much more than the MI-1m dataset. The GC model adopts an adaptive selection of the trade-off factor based on the coverage of item categories in the whole sequences. If there are many categories, the user's sequence can only cover a small proportion of categories, leading to the low trade-off factor value for calibration. In contrast, the small number of the category set results in the relatively large consideration for calibration.

We also observe that the calibration performance of our model differs under different evaluation position (e.g., $K=10$ and $K=20$). For example, the $C_{KL}@20$ of our model is 0.6846, which is close to CaliRec. However, the $C_{KL}@10$ of our model is 1.0244, which is higher than 0.9243 of CaliRec. This is because the difference in the procedure of generating recommendation lists.

Table 3 Average time consumption for each sequence.

Response time (s)	MI-1m	Tmall
SASRec	0.0015	0.0012
CaliRec	0.0644	0.0675
Our Model	0.0039	0.0026

The CaliRec and GC model follow the greedy strategy, which generates recommendation lists step by step. At each time step, these models consider both accuracy and calibration. However, our model generates recommendation lists in an end-to-end way, which computes the scores of all items and select top-K items with highest scores. This strategy does not build connections between the rank and calibration, leading to the larger difference between $C_{KL}@10$ and $C_{KL}@20$.

In addition, we also compare the response time of our model and the CaliRec model. We conduct experiments on the same device, and remove the GPU acceleration for the fair comparison. The performance is listed in Table 3. Compared to the original SASRec model, our model requires more time in generating results. This is because our model includes individual sequence encoders and the aggregation module. Compared to the CaliRec model, our model costs much less time in generating recommendation lists. For a single sequence, our model only need 0.0039 and 0.0026 seconds on the MI-1m and Tmall datasets, respectively. In contrast, the CaliRec requires approximately 0.06 seconds for a sequence, which needs 15 to 20 times more time than our model. This is because CaliRec is a post-processing method, while our model directly computes scores over all items without ranking again. In addition, the ranking procedure which generates final recommendation lists step by step is also time-consuming.

5.2 RQ2: Parameter Influence

In this section, we analyze influence of two hyperparameters λ and τ .

5.2.1 Trade-off Factor λ

We first analyze the influence of hyperparameter λ by changing it from 0.1 to 1.0. Since CaliRec requires a parameter to control the importance of calibration and accuracy which is similar to our model, we also make a comparison between our model and CaliRec. The performances on the two datasets are shown in Fig. 2, where blue lines represent our model and red lines represent CaliRec.

We first analyze the recommendation accuracy when λ changes. In general, the performances of Rec@20 decrease when λ becomes higher. Our model improves the Rec@20 at the beginning, while the Rec@20 of CaliRec model remains stable. This showing that considering users' historical preference distributions can help predict the users' future behaviors. When $\lambda > 0.7$, the performance of our model decreases greatly, while the CaliRec model does not decrease as large as our model. A possible reason is that the difference

of the process of generating recommendation lists. The CaliRec re-ranks the candidate list generated by the SASRec model whose size is 100 and finally selects top-K ($K = 10$ or 20) items as the final recommendation list. However, our model computes scores of all items, and directly select top-K items. If we consider much more for calibration, the user's next item will be eliminated from the top-K items. While for post-processing methods, the range of items for re-ranking is much smaller than our model. Therefore, it can preserve the performance of Rec@20. In contrast, our model outperforms CaliRec when considering recommendation accuracy with ranking performance. As shown in Fig. 2 (c) and (d), our the MRR@20 of our model is always higher than the CaliRec model. This is also because of the re-ranking strategy of the CaliRec model. Higher importance for calibration influences each step of generating recommendation list. Therefore, the ground truth item of the user achieves a lower ranking position.

In terms of calibration, our model achieves close performance compared to the CaliRec model under same λ . As shown in Fig. 2 (e), two lines which represent our DACSR model and CaliRec model almost overlap when λ becomes larger. For example, on the ML-1m dataset, the $C_{KL}@20$ of our model and CaliRec model are 0.6259 and 0.6589 when λ equals to 0.6. When λ is close to 1, our DACSR model cannot perform as well as the CaliRec model, indicating that there is still room for our loss function to improve. However, a large λ leads to lower ranking performance. Though it achieves better calibration, we do not consider this because accurately predicting the user's next behavior is still an important concern.

To further illustrate that our model can provide calibrated and accurate recommendation lists, we select cases of the performances of our model and the CaliRec model under different settings but ensure the $C_{KL}@10$ performances are close. On the ML-1m dataset, we choose $\lambda = 0.35$ for the CaliRec model, and 0.5 for our DACSR model. On the Tmall dataset, we select 0.45 and 0.6 of λ for the CaliRec and DACSR model, respectively. The performances of cases are listed in Table 4.

On both datasets, performances of $C_{KL}@10$ are close. In terms of accuracy, our DACSR model outperforms the CaliRec model. Our model achieves an improvement of 6.60% and 4.78% of MRR@10 on the ML-1m and Tmall dataset, respectively. It is similar on MRR@20. This demonstrate that our model can achieve both accurate and calibrated recommendation lists. When performance of $C_{KL}@10$ is set close, our DACSR model can obtain better performance in terms of $C_{KL}@20$. For example, the $C_{KL}@20$ are 0.6846 and 0.7595 for our DACSR model and the CaliRec model, with the improvement of 10.94%. This can further demonstrate the effectiveness of our model.

5.2.2 Temperature Factor τ

In this section, we analyze the influence of parameter τ , which controls the sharpness of the distribution. We tune τ in $\{0.1, 0.3, 0.5, 0.8, 1.0, 1.5, 2.0, 5.0\}$, and show the performances in Fig. 3. Red lines represent the performance of

Table 4 Performance of cases when $C_{KL}@10$ are close.

Dataset	Model	MRR@10	CKL@10	MRR@20	CKL@20
MI-1m	CaliRec	0.1106	1.0417	0.1177	0.7595
	DACSR	0.1179	1.0244	0.1252	0.6846
Tmall	CaliRec	0.0836	2.1291	0.0861	1.8416
	DACSR	0.0876	2.1238	0.0900	1.7646

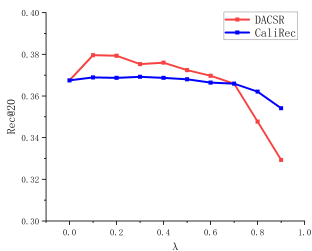

(a) Rec@20 on the MI-1m dataset

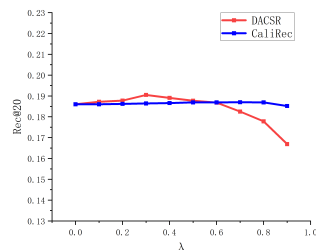

(b) Rec@20 on the Tmall dataset

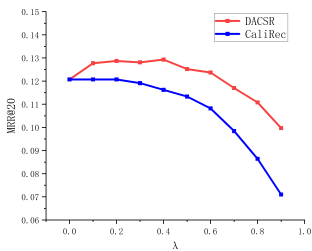

(c) MRR@20 on the MI-1m dataset

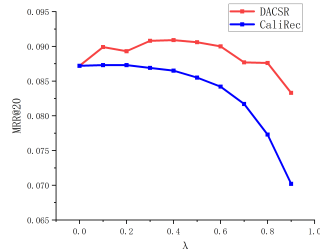

(d) MRR@20 on the Tmall dataset

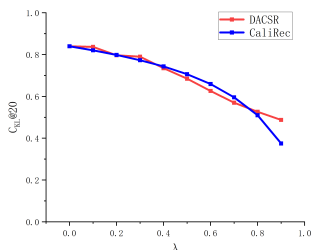
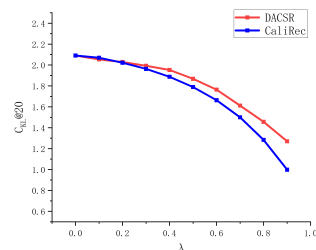
(e) $C_{KL}@20$ on the MI-1m dataset(f) $C_{KL}@20$ on the Tmall dataset**Fig. 2** Performance comparison when λ changes.

$MRR@20$ and are corresponding to the right axis, and green lines stand for the $C_{KL}@20$ performance which follow the left axis.

From the perspective of calibration, a relatively lower value of τ can achieve lower $C_{KL}@20$ performance. For example, on the MI-1m dataset, the $C_{KL}@20$ performances are 0.6379 and 0.6846 when τ equals to 0.5 and 1.0 respectively. However, too much lower value of τ does not always improve the calibration. As shown in Fig. 3, when τ equals to 0.1, the $C_{KL}@20$ becomes higher. This is because a extremely low value of τ makes model only focus on a small proportion of items with highest scores (e.g., top-1 or top-2 items), and other items are ignored because their scores are normalized to 0. On the other hand, higher value of τ also cause negative impact on calibration, because scores of all items are normalized to close values (i.e., $1/|I|$ for all items). Therefore, no useful information for calibration can be propagated to the model.

In terms of prediction accuracy, performance of $C_{KL}@20$ increased when τ becomes larger at the beginning. This is because calibration can also contribute to the recommendation accuracy, as analyzed before. When τ is set to a larger value, the calibration is no longer effective, and the performance of $MRR@20$ is close to the original sequence encoder.

5.3 RQ3: Effectiveness of Aggregation Module

5.3.1 Aggregation Variants

In this section, we analyze the performance to demonstrate the effectiveness of our dual-aggregation framework. In our work, we utilize an aggregation module to extract useful information from outputs of two sequence encoders. Therefore, we compare our model with its variants. The first variant removes the aggregation module, which directly concatenates the sequence representations and item embeddings. The other variant only uses one sequence encoder $f(s, E^I, \theta, L)$ and is optimized by the weighted sum of loss function. We also set the parameter $\lambda = 0.5$ for this variant. The performance is shown in Table 5.

The first variant achieves the best performance in terms of $C_{KL}@20$, while it sacrifices too much in prediction accuracy. For example, the $Rec@20$ are 0.2366 and 0.3724 for this variant and our model respectively, with the improvement of 57.40%. For the ranking performance, our model is twice better than this variant (0.1252 v.s. 0.0601). The performance comparison on the Tmall dataset is similar. This is because directly adding the outputs amplifies the effect of items whose attributes are consistency with the user's preference. However, these items are not always sequential correlated with the user's behavior sequence. Therefore, the recommendation accuracy is sacrificed.

Compared to the second variant, our model still achieves a better performance. On the MI-1m dataset, the $C_{KL}@20$ of our model is slightly better than this variant. However, in terms of prediction accuracy. The $MRR@20$ of our model is 0.1252, which is 7.10% better than this variant. On the Tmall dataset, although our model achieves slightly higher $C_{KL}@20$ value (1.7646

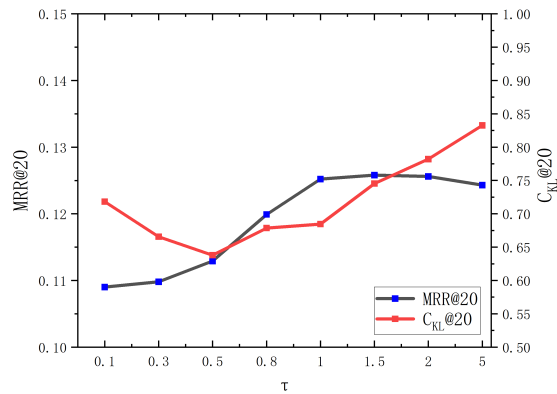

(a) Performance change on the MI-1m dataset

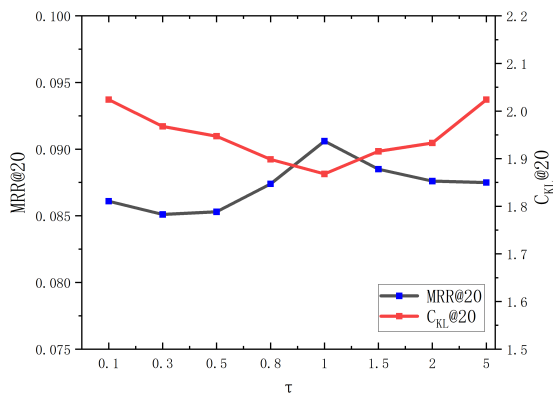

(b) Performance change on the Tmall dataset

Fig. 3 Performance comparison when τ changes.

v.s. 1.7198 with a difference of 2.60%), our model also has a better performance in terms of Rec@20 and MRR@20, with the improvement of 5.00% and 3.45%, respectively. By extracting from two different sequence encoders, our model can achieve better sequence representations and item embeddings, leading to the improvement of performance.

Table 5 Performances of our model and variants.

Dataset	Models	Rec@20	MRR@20	$C_{KL}@20$
MI-1m	DACSR	0.3724	0.1252	0.6846
	w/o Agg	0.2366	0.0601	0.4479
	One Seq	0.3642	0.1169	0.6909
Tmall	DACSR	0.1868	0.09	1.7646
	w/o Agg	0.1405	0.0757	1.3986
	One Seq	0.1779	0.087	1.7198

5.3.2 Pre-trained Model Influence

In our work, we initialize parameters of our model by a pre-trained SASRec sequence encoder. Therefore, we further train the sequence encoder to demonstrate the effectiveness of our model does not results from the training of the sequence encoder. The performances are shown in Fig. 4.

As shown in Fig. 4, the performance of the SASRec model with continual training remains stable when the number of training epoches becomes larger. Although the model gets more training epoches, the performance is still worse than our model. The blue dashed lines represent the performance of our DACSR model in terms of MRR@20, and the performance of SASRec model is always lower than our DACSR model. Similarly, red dashed lines are lower than the SASRec model, showing that continual training of the SASRec model does not improve the performance of calibration. The comparisons also demonstrate the effectiveness of our DACSR model.

6 Discussion

In this paper, we propose the DACSR model to provide accurate and calibrated recommendation lists for sequential recommendation with an end-to-end protocol. We also analyze the performance changes under different parameter settings. In addition, we compare our model with variants to demonstrate the effectiveness of our model. Though our model can achieve improvement to a certain extent, there are some limitations in our work:

- First, our work evaluates calibration by the consistency of distributions between users' historical behaviors and recommendation lists according to C_{KL} metric provide by [6]. However, this metric does not consider the calibration at each ranking position. Meanwhile, our model also does not take such a factor into account.
- Next, our proposed model improves the sequence encoder via designing the calibration loss function and dual-aggregation framework, which is a performance-oriented solution. However, we do not investigate reasons

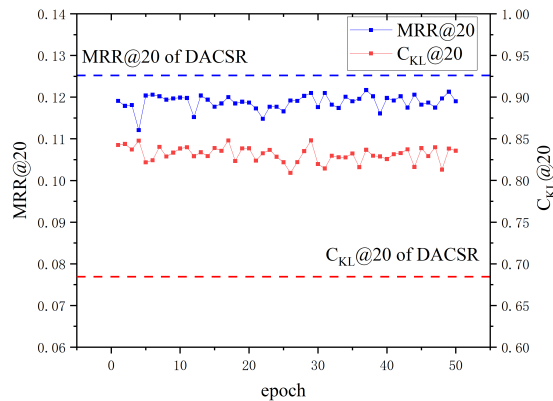

(a) Performance change on the MI-1m dataset

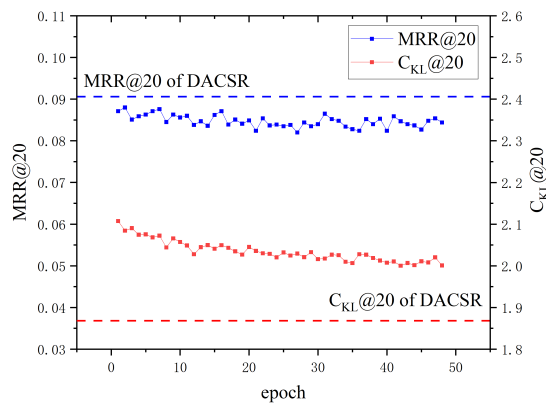

(b) Performance change on the Tmall dataset

Fig. 4 Performances of continual training of the original SASRec model within 50 epochs

that cause the miscalibration and incorporate reasons to make calibrated recommendation.

- Finally, we follow the traditional sequential recommendation training paradigm to optimize our model. It is worth investigating the bias that such paradigm brings.

7 Conclusion and Future Work

In this paper, we propose a DACSR model to provide accurate and calibrated results for sequential recommendation. We propose a loss function which estimates the item category distribution of the recommendation list by

predicted scores of all items. In addition, we propose a dual-aggregation framework to improve the recommendations. The framework includes two individual sequence encoders and optimized by the goals of accuracy and calibration separately. Then we utilize an aggregation module to extract information from two sequence encoders for better recommendation. Experiments on the two benchmark datasets demonstrate the effectiveness of our model. In addition, the time consumption of our model in prediction is much less than post-processing models.

For the future work, we first aim to investigate the evaluation protocol of calibrated recommendation, which considers performances at each ranking position. We are interested in designing loss functions for this protocol. Meanwhile, we are also interested in the reasons of miscalibration. From the model perspective, causal inference is our future direction. We also plan to investigate from the user's profile. Finally, we decide to propose new training paradigm for calibrated sequential recommendation, such as contrastive learning.

References

- [1] Huang, J., Zhao, W.X., Dou, H., Wen, J.-R., Chang, E.Y.: Improving sequential recommendation with knowledge-enhanced memory networks. In: The 41st International ACM SIGIR Conference on Research & Development in Information Retrieval, SIGIR 2018, pp. 505–514 (2018). <https://doi.org/10.1145/3209978.3210017>
- [2] Lu, Y., Zhang, S., Huang, Y., Wang, L., Yu, X., Zhao, Z., Wu, F.: Future-aware diverse trends framework for recommendation. In: The Web Conference, 2021, pp. 2992–3001 (2021). <https://doi.org/10.1145/3442381.3449791>
- [3] Cen, Y., Zhang, J., Zou, X., Zhou, C., Yang, H., Tang, J.: Controlable multi-interest framework for recommendation. In: The 26th ACM SIGKDD Conference on Knowledge Discovery and Data Mining, 2020, pp. 2942–2951 (2020). <https://doi.org/10.1145/3394486.3403344>
- [4] Liu, S., Zheng, Y.: Long-tail session-based recommendation. In: Proceedings of the ACM Conference on Recommender Systems, RecSys 2020, pp. 509–514 (2020). <https://doi.org/10.1145/3383313.3412222>
- [5] Li, P., Que, M., Jiang, Z., Hu, Y., Tuzhilin, A.: PURS: personalized unexpected recommender system for improving user satisfaction. In: Fourteenth ACM Conference on Recommender Systems, 2020, pp. 279–288 (2020). <https://doi.org/10.1145/3383313.3412238>
- [6] Steck, H.: Calibrated recommendations. In: Proceedings of the ACM Conference on Recommender Systems, RecSys 2018, pp. 154–162 (2018). <https://doi.org/10.1145/3240323.3240372>

- [7] Hidasi, B., Karatzoglou, A., Baltrunas, L., Tikk, D.: Session-based recommendations with recurrent neural networks. In: Proceedings of the International Conference on Learning Representations, ICLR 2016 (2016)
- [8] Li, J., Ren, P., Chen, Z., Ren, Z., Lian, T., Ma, J.: Neural attentive session-based recommendation. In: Proceedings of the ACM on Conference on Information and Knowledge Management, CIKM 2017, pp. 1419–1428 (2017). <https://doi.org/10.1145/3132847.3132926>
- [9] Tang, J., Wang, K.: Personalized top-n sequential recommendation via convolutional sequence embedding. In: Proceedings of the ACM International Conference on Web Search and Data Mining, 2018, pp. 565–573 (2018). <https://doi.org/10.1145/3159652.3159656>
- [10] Kang, W., McAuley, J.J.: Self-attentive sequential recommendation. In: Proceedings of the IEEE International Conference on Data Mining, 2018, pp. 197–206 (2018). <https://doi.org/10.1109/ICDM.2018.00035>
- [11] Sun, F., Liu, J., Wu, J., Pei, C., Lin, X., Ou, W., Jiang, P.: Bert4rec: Sequential recommendation with bidirectional encoder representations from transformer. In: Proceedings of the International Conference on Information and Knowledge Management, 2019, pp. 1441–1450 (2019). <https://doi.org/10.1145/3357384.3357895>
- [12] de Souza Pereira Moreira, G., Rabhi, S., Lee, J.M., Ak, R., Oldridge, E.: Transformers4rec: Bridging the gap between NLP and sequential / session-based recommendation. In: Proceedings of the ACM Conference on Recommender Systems, 2021, pp. 143–153 (2021). <https://doi.org/10.1145/3460231.3474255>
- [13] Wu, S., Tang, Y., Zhu, Y., Wang, L., Xie, X., Tan, T.: Session-based recommendation with graph neural networks. In: Proceedings of the AAAI Conference on Artificial Intelligence, AAAI 2019, pp. 346–353 (2019). <https://doi.org/10.1609/aaai.v33i01.3301346>
- [14] Chang, J., Gao, C., Zheng, Y., Hui, Y., Niu, Y., Song, Y., Jin, D., Li, Y.: Sequential recommendation with graph neural networks. In: Proceedings of the ACM SIGIR Conference on Research and Development in Information Retrieval, 2021, pp. 378–387 (2021). <https://doi.org/10.1145/3404835.3462968>
- [15] Wang, Z., Wei, W., Cong, G., Li, X., Mao, X., Qiu, M.: Global context enhanced graph neural networks for session-based recommendation. In: Proceedings of the International ACM SIGIR Conference on Research and Development in Information Retrieval, SIGIR 2020, pp. 169–178 (2020). <https://doi.org/10.1145/3397271.3401142>

- 22 *DACSR: Dual-Aggregation End-to-End Calibrated Sequential Recommendation*
- [16] Chen, W., Ren, P., Cai, F., Sun, F., de Rijke, M.: Improving end-to-end sequential recommendations with intent-aware diversification. In: The International Conference on Information and Knowledge Management, 2020, pp. 175–184 (2020). <https://doi.org/10.1145/3340531.3411897>
- [17] Tan, Q., Zhang, J., Yao, J., Liu, N., Zhou, J., Yang, H., Hu, X.: In: Proceedings of the ACM International Conference on Web Search and Data Mining, 2021, pp. 598–606 (2021). <https://doi.org/10.1145/3437963.3441811>
- [18] Abdollahpouri, H., Mansoury, M., Burke, R., Mobasher, B.: The connection between popularity bias, calibration, and fairness in recommendation. In: Proceedings of the ACM Conference on Recommender Systems, 2020, pp. 726–731 (2020). <https://doi.org/10.1145/3383313.3418487>
- [19] Kaya, M., Bridge, D.G.: A comparison of calibrated and intent-aware recommendations. In: Bogers, T., Said, A., Brusilovsky, P., Tikk, D. (eds.) Proceedings of the ACM Conference on Recommender Systems, 2019, pp. 151–159 (2019). <https://doi.org/10.1145/3298689.3347045>
- [20] Seymen, S., Abdollahpouri, H., Malthouse, E.C.: A constrained optimization approach for calibrated recommendations. In: Proceedings of the ACM Conference on Recommender Systems, 2021, pp. 607–612 (2021). <https://doi.org/10.1145/3460231.3478857>
- [21] da Silva, D.C., Manzato, M.G., Durão, F.A.: Exploiting personalized calibration and metrics for fairness recommendation. *Expert Syst. Appl.* **181**, 115112 (2021). <https://doi.org/10.1016/j.eswa.2021.115112>
- [22] Kingma, D.P., Ba, J.: Adam: A method for stochastic optimization. In: Proceedings of the International Conference on Learning Representations, ICLR 2015 (2015)