

Knowledge Equivalence in Digital Twins of Intelligent Systems

NAN ZHANG*, Southern University of Science and Technology (SUSTech), China and University of Birmingham, UK

RAMI BAHSOON, University of Birmingham, UK

NIKOS TZIRITAS, University of Thessaly, Greece

GEORGIOS THEODOROPOULOS*, Southern University of Science and Technology (SUSTech), China

A digital twin contains up-to-date data-driven models of the physical world being studied and can use simulation to optimise the physical world. However, the analysis made by the digital twin is valid and reliable only when the model is equivalent to the physical world. Maintaining such an equivalent model is challenging, especially when the physical systems being modelled are intelligent and autonomous. The paper focuses in particular on digital twin models of intelligent systems where the systems are knowledge-aware but with limited capability. The digital twin improves the acting of the physical system at a meta-level by accumulating more knowledge in the simulated environment. The modelling of such an intelligent physical system requires replicating the knowledge-awareness capability in the virtual space. Novel equivalence maintaining techniques are needed, especially in synchronising the knowledge between the model and the physical system. This paper proposes the notion of knowledge equivalence and an equivalence maintaining approach by knowledge comparison and updates. A quantitative analysis of the proposed approach confirms that compared to state equivalence, knowledge equivalence maintenance can tolerate deviation thus reducing unnecessary updates and achieve more Pareto efficient solutions for the trade-off between update overhead and simulation reliability.

CCS Concepts: • **Computer systems organization** → **Embedded and cyber-physical systems; Architectures**; • **Computing methodologies** → **Modeling and simulation; Knowledge representation and reasoning**.

Additional Key Words and Phrases: Knowledge Management, Digital Twins, Equivalence Checking, Multi-Agent System, DDDAS

ACM Reference Format:

Nan Zhang, Rami Bahsoon, Nikos Tziritas, and Georgios Theodoropoulos. 2022. Knowledge Equivalence in Digital Twins of Intelligent Systems. In . ACM, New York, NY, USA, 27 pages. <https://doi.org/XXXXXXX.XXXXXXX>

1 INTRODUCTION

Digital twin is a concept that comes from manufacturing and is now gaining attention in other fields including logistics, transportation, city and urban planning, infrastructure monitoring and smart agriculture [4, 17, 25, 32, 41] A representative and inclusive definition of Digital Twins, which is adopted in this paper, has been put forth in [3]: “A digital twin is the combination of a computational model and a real-world system, designed to monitor, control and optimise its functionality. Through data and feedback, both simulated and real, a digital twin can develop capacities for autonomy and to learn from and reason about its environment.” Research into digital twins is still in its infancy and much of the work has been for prototyping and proof-of-concept purposes, covering but not limited to modelling,

*Corresponding Author.

Permission to make digital or hard copies of all or part of this work for personal or classroom use is granted without fee provided that copies are not made or distributed for profit or commercial advantage and that copies bear this notice and the full citation on the first page. Copyrights for components of this work owned by others than ACM must be honored. Abstracting with credit is permitted. To copy otherwise, or republish, to post on servers or to redistribute to lists, requires prior specific permission and/or a fee. Request permissions from permissions@acm.org.

© 2022 Association for Computing Machinery.

Manuscript submitted to ACM

simulation, verification, validation, and/or assurance of the physical artefact using the virtual replica. The focus of the analysis has been geared towards simulations and what-if analysis to inform deployment and subsequent refinements of the physical product through continuous monitoring and data assimilation.

One class of systems that can benefit from digital twins is intelligent systems, where the digital twins can assist in empowering intelligence in the physical system [57]. An example would be that of a large-scale autonomous system consisting of connected computing nodes, each of which is managed by an onboard intelligent agent. Each node can accumulate knowledge to make its own decisions and to collaborate with other nodes in the network, where processing can be distributed and the control can be decentralised to each agent [8, 16, 54]. The degree of autonomy and level of intelligence of these agents may be limited by issues like energy consumption and computation capability of each node. To overcome these limitations and enable better autonomy in the physical system, the agents of the physical system can be assisted by digital twins. In [57] the authors have outlined an architecture for cognitive twins that can make informed decisions via predictive and prescriptive what-if analysis in the simulation environment leveraging knowledge awareness and cognition capabilities.

Predictions and analysis made by the digital twin can easily become obsolete when the physical world is highly dynamic and evolves in real-time, and when digital twins knowledge drifts, decays and/or not updated to reflect on changes in physical world. The requirement for high fidelity of the digital twin system poses an important challenge to decide at which point a twin can indeed be considered a replica and not a mere abstract representation model of the physical system. In other words, fidelity replication begs the question: when is a model be considered equivalent to the real system, and therefore the model can be trusted, and no further updates are required? Too frequent updates in the model introduce excessive communication and computation overheads, while large delays in updating the model force it to drifts from reality [17]. This paper aims to address this question in the context of digital twins for intelligent systems, from the perspective of knowledge.

Digital twins are essentially data-driven info-symbiotic systems, where data assimilated from the physical system(s) steer the computation and control of these systems to provide prescriptive, prognostic diagnostics and/or predictive analysis of the physical system [57]. The info-symbiotic relation of the two worlds, can generate a wealth of knowledge overtime. Knowledge synchronisation and equivalence become a paramount importance and prerequisite for meaningful, effective, and efficient control and analysis, as knowledge drift and decay can make the twining obsolete. Additionally, maintaining knowledge equivalence can subsume other fundamental issues that can be rooted in data sources, sensing, processing, actuating, and control, etc. This can be particularly important in digital twins, supporting intelligent systems that are grounded on knowledge, covering dimensions that relate to stimuli, time, interaction, goals, etc.

Current approaches for building Digital Twins do not provide explicit solutions to the problem of knowledge equivalence as a fundamental problem for ensuring fidelity between the physical and digital worlds. This paper specifically looks at knowledge equivalence in the design of intelligent systems, assisted by the digital twins. In particular, it investigates the challenge of real-time modelling of autonomous systems which can accumulate knowledge through digital twins to support intelligence and how knowledge equivalence can be engineered and/or reasoned about in this setting.

The work presented in the paper assumes that a digital twin is an imperfect artefact when attempting to “follow” the physical system, and calls for knowledge comparison between the digital and physical worlds [24]. The objective is (i) to inform when and how often to update the digital twins knowledge, and (ii) what is an acceptable tolerance and knowledge deviation levels between that of the digital and physical worlds. The paper posits that utilising knowledge equivalence as opposed to *state equivalence* can alleviate the overheads while improving simulation validity and can

be a more efficient and effective approach for digital twins of intelligent systems. The contribution of this paper is as follows:

- A novel reference models for the design of digital twins for intelligent systems, where knowledge equivalence is a key component.
- The formulation of the problem of knowledge equivalence for the digital twin of an intelligent physical system. This includes an outline of the threats to knowledge equivalence and their detection and impact as well as a set of metrics that measure the equivalence of fine-grained knowledge related to interaction.
- An online knowledge equivalence checking framework that identifies discrepancies and determines when to update the digital twin.
- Demonstration and quantitative evaluation of the proposed framework based on a smart camera network scenario.

The rest of the paper is organised as follows. Section 2 provides a reference architecture for digital twins of intelligent that can incorporate different levels of knowledge and self-awareness. Section 3 provides a theoretical formulation of the problem of knowledge equivalence, and outlines relevant threats and metrics. The proposed methodology for online knowledge equivalence checking is presented in Section 4. Section 5 presents a prototype implementation and experimental evaluation of the proposed approach. Relevant work is discussed in 6, while section 7 concludes the paper and outlines future research directions.

2 DIGITALLY TWINNING INTELLIGENT SYSTEMS

Twining intelligent systems pose challenges and opportunities. In particular, implementing intelligence in the physical world can be constrained by limitations in the physical environment, such as space, computation, power, memory, mobility, coordination and/or unavailability of knowledge. Henceforth, intelligence capability can be limited. Twining can be architected to provide support scenarios, for “empowering intelligence” to overcome these limitations. Consequently, knowledge management and equivalence in digital twins can become vital, to unlock new mode of intelligence.

2.1 Physical World Model

Consider a scenario where the physical system is composed of nodes with embedded intelligence. Each node is controlled by an onboard intelligent agent with its own local knowledge about itself and the environment. Agents collaborate and accumulate knowledge as shown in Figure 1.

2.1.1 Intelligent Agents. An agent program is a mapping from perception to action [46]. Inspired by the concept of *learning agents* [46] and *self-awareness* [39], we further formally specify the intermediate process between perception and action by explicitly incorporating the awareness and utilisation of knowledge.

An intelligent agent α is regarded as a tuple $\{A, P, K, \phi, \pi\}$, where:

- A is a set of all allowed actions of an agent. An agent affects the environment via actions. Communication between agents are also viewed as actions [56].
- P is the agent’s perception space of its environment and itself. The perception at time t is denoted as $p(t) \in P$, which consists of processed data from the sensors. Example content of the perception data may include the received messages from other agents or the positions of the agent’s surrounding objects in the environment.
- K is the space of the agent’s runtime knowledge, with $k(t) \in K$ signifying agent’s knowledge at time t ; Knowledge is represented according to the *computational self-awareness* architecture, explained in section 2.3.3.

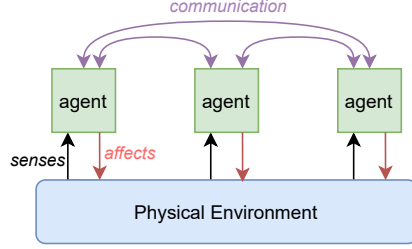

Fig. 1. Physical world

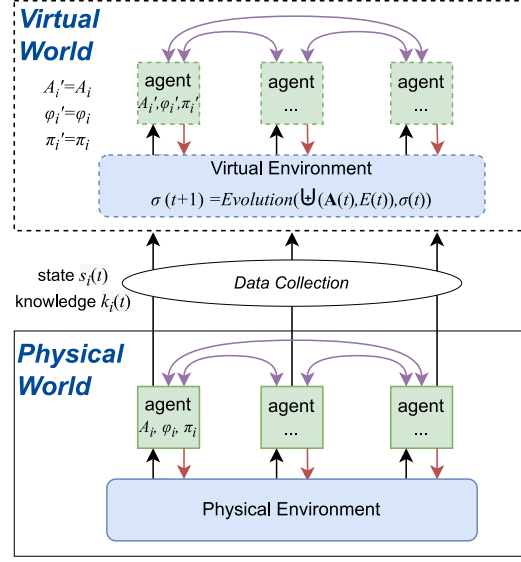

Fig. 2. Modelling of the physical world.

- ϕ is the agent's awareness function, which constructs the agent's runtime knowledge $k(t)$ based on the perception $p(t)$ and its previous knowledge $k(t-1)$ (supposing time is discrete). ϕ can be used to instantiate the learning process in which $p(t)$ is the feedback after utilising $k(t-1)$.

$$k(t) = \phi(p(t), k(t-1)) \quad (1)$$

- π is the agent's decision function. An agent utilises π to decide the next action $a(t)$ based on its perception $p(t)$ and current knowledge $k(t)$.

$$a(t) = \pi(p(t), k(t)) \quad (2)$$

Notice that the output $a(t)$ can be a single action or a probability distribution of different actions, which corresponds to deterministic and probabilistic decision making, respectively.

The agent follows a sense-think-act cycle. During *sensing*, the agent first obtain its perception $p(t)$ by sensing its environment and itself, including checking the messages it receives from other agents (e.g. through a mailbox [10]). In the *think* process, the agent uses the current $p(t)$ as a feedback to update its knowledge by ϕ . Then π will derive an action or a probability distribution of actions. Finally at the *act* stage, the action $a(t)$ is executed through actuators to affect the environment or/and other agents.

2.2 Virtual World

The modelling of the physical world involves replicating agents and the physical environment as *virtual agents* and *virtual environment*, as shown in Figure 2. The behaviour of agents and the dynamics of the environment are modelled as follows.

2.2.1 The Agent Model. Since agent is essentially a software system, the modelling towards a virtual agent can be realised by replicating the same software program of the physical agent. Specifically, a virtual agent possesses the same $\{A, \phi, \pi\}$ as its physical agent counterpart.

2.2.2 The Environment Model. To model the environment, we take a state-based perspective [38, 49]. The environment is considered as a two-tuple: $Environment = \langle State, Process \rangle$. The environment has its own endogenous dynamics denoted by $Process$ that can change its $State$, independent of the actions of agents. Let $\sigma \in \Sigma$ be the state of the environment. At any time t , the state of the environment can be characterised by a vector contains multiple variables:

$$\sigma(t) := (\sigma_1(t), \sigma_2(t), \dots, \sigma_k(t)) \quad (3)$$

For instance, in a spatial context, σ can be composed of the positions of all physical entities within the space. Variable σ_i represents the position of the i -th entity.

The environment not only is affected by the agents but also evolves according to its own endogenous dynamics. The coupling of the environment and agents results in the overall world dynamics, which is defined by a function $Evolution$ such that the transition from current moment t to the next time step $t + 1$ is the composite result of all the agent actions and the endogenous dynamics of the environment [40]:

$$\sigma(t + 1) = Evolution(\uplus(\mathbf{a}(t), E_n(t)), \sigma(t)) \quad (4)$$

$\mathbf{a}(t) = (a_1(t), a_2(t), \dots, a_m(t))$ is all the action made by each agent onto the environment at time t . $E_n(t)$ is the dynamics produced by the natural evolution of the environment (the $Process$). The symbol \uplus denotes the action composition operator, which defines how the actions and endogenous dynamics of the environment at t are composed to calculate the consequences on the previous environment state $\sigma(t)$ [40].

2.3 A Reference Architecture

Different reference models for Digital Twins have been proposed, e.g [45]. Based on the model abstractions in the previous section where the physical system is an intelligent multi-agent system, a reference model of a digital twin is shown in Figure 3. The digital twin and physical world interact through a communication layer. The data (perception and knowledge) sent from the agents in the physical world are first used to create the real-time virtual replica. Then these data are used to drive the model equivalence and decision support.

2.3.1 Cognitive Decision Support. In the reference model, a Cognitive Decision Maker is introduced, which can be enriched by human cognitive behaviour of self-awareness to support predictive and prescriptive analysis [57]. The cognitive decision maker monitors any event that is causing or may lead to sub-optimality of the physical world and then provide more informed decisions to optimise the behaviour of the physical system. The analysis towards decisions is enabled by a library of analysis tools, among which the what-if analysis is of paramount importance. With what-if analysis, the cognitive decision maker can obtain in-depth understanding and explanation of the mechanisms governing the system behaviour through simulation. By exploring different scenarios or experimenting alternative decisions, the cognitive decision maker can deliver actionable insights suggesting the best solution given a variety of choices [57].

The decision making for the intelligent multi-agent system is performed at a meta-level. Since agents already have a certain level of intelligence and autonomy as described in Section 2.1.1, the digital twin mainly assists the intelligence of the agents, for instance, on the agent's decision function π . An agent relies on its $\pi \in \Pi$ to derive an action, where Π contains all possible decision functions that this agent can be equipped with. With a digital twin, the outcome

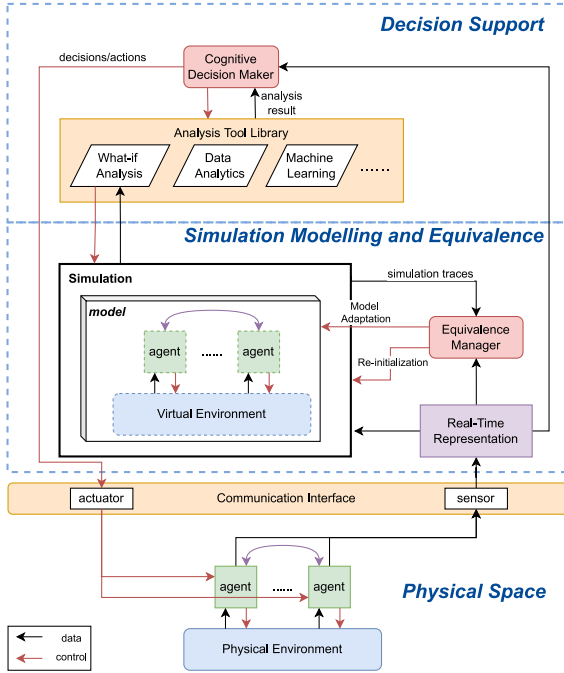

Fig. 3. A Reference model of intelligent systems digital twins.

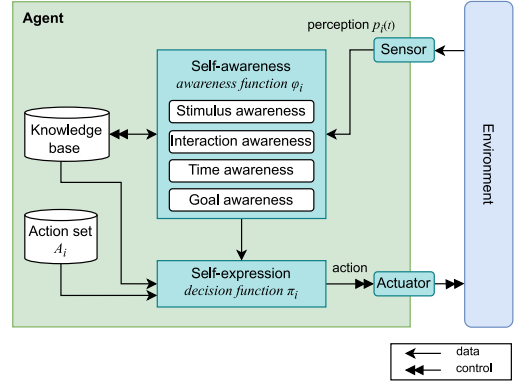

Fig. 4. A self-aware agent

of different candidates of π can be evaluated in the simulation before enacting any changes in the physical world. Furthermore, by switching the level of knowledge, the digital twin can serve as an instantiation for the notion of meta-self-awareness [20].

2.3.2 Model Equivalence and Adaptation. In the proposed framework, agents are assumed to be the only entities in the physical world that are able to transmit data to the virtual world. Each agent α_i pushes its perception p_i (or part thereof) and current knowledge k_i to the virtual world, such that each virtual agent is updated with the most recent perception and knowledge, and the current environment state σ can be interpreted by combining the perception from each agent. The equivalence manager continuously compares the model against the physical world and, in case of discrepancies, it initiates additional data absorption or adaptation of the model [36].

Traditionally, equivalence checking is largely based on state synchronisation and comparison between sensory data of the physical system and the output of the model or through the exhaustive exploration of transitions of states (see section 6). Such *state equivalence* checking methods can suffer from heavy computational overheads, making them difficult to scale to large scale settings, such as digital twins where equivalence should be maintained in real-time or near real-time. This is exacerbated in highly dynamic applications where model adaptation is expected to be performed frequently to capture the up-to-date dynamics of the fast evolving environment.

In systems encompassing intelligent agents, the dynamic non-deterministic behaviour of agents may also change the dynamics of the physical world and the world model. In such cases, the knowledge of the agents may become the determining factor affecting the deviation of these two respective components of the twin system as it is the knowledge of the agents that determine their decisions, their actions and their effect on their environment. Using knowledge as

a metric for equivalence checking such intelligent systems emerges therefore as a viable approach that could overcome the high overheads involved in using state, since knowledge is a task-related abstraction of state.

2.3.3 Levels of Knowledge. Knowledge involves different cognitive dimensions and can be captured in different representations. We adopt computational self-awareness, a paradigm which draws inspiration from human cognition and levels of awareness in human brain to represent knowledge of each agent [11, 39, 57]. A self-aware agent can pose four dimensions of knowledge and awareness: stimuli-, interaction-, time-, and goals-awareness to reason about and formulate its actions:

- *Stimulus-awareness*: Stimulus-awareness is the basis for all levels of self-awareness and describes the simple reactive behaviour of the agent. Stimulus-awareness is the ability to perceive the stimuli or events acting on the agent and can consequently evoke the agent to decide its next action.
- *Interaction-awareness*: An interaction-aware agent can perceive historical knowledge of state, behaviour, and type of relationships and communication of interacting system components; it can consequently use this knowledge to decide its subsequent actions. Interaction-related knowledge may be represented as a graph or network among other representations.
- *Time-awareness*: Being aware of time means the agent is able to use models that involve explicit memory, time-series modelling, or anticipation [39].
- *Goal-awareness*: Goal-awareness refers to the ability to know the system goals and reason about the goals. The awareness can be expressed as the utility or satisfaction of goals.

Different levels of self-awareness can exist in an agent at the same time, but stimulus-awareness (i.e. as the basic awareness level) is the pre-requisite and enabler for other awareness levels. It is worth noting that if the agent is only stimulus-aware, its awareness function ϕ will degenerate into $\phi : P \rightarrow K$, because stimulus-awareness alone cannot preserve history. The *self-expression* component expresses decisions and yields consequent actions entailed by the awareness level(s). The mapping of the agent modelling in this paper and self-awareness architecture is depicted in Figure 4.

2.3.4 Equivalence Manager . Since knowledge is divided into different levels in the agent's knowledge base, the equivalence manager should also maintain the equivalence of each dimension of fine-grained knowledge. Figure 5 shows the instantiation and refinement for the model equivalence of the generic reference model when the intelligence of the agents are modelled by self-awareness.

The Equivalence Manager is composed of an equivalence checker and an updater. The equivalence checker (EC) contains a state equivalence checker, a knowledge equivalence checker, and an aggregator. The state EC checks equivalence by comparing the state transition of the physical world and the model. The knowledge EC is further refined into four levels according to the levels of self-awareness: stimulus EC, interaction EC, time EC, and goal EC. Each fine-grained knowledge checker is responsible for the knowledge comparison of that level. For instance, the interaction EC monitors the interaction-related knowledge in the knowledge base of the physical agents and the virtual agents. When the interaction-related knowledge in the physical and virtual agents deviate from each other, the equivalence manager should update the interaction knowledge base of each virtual agent. The aggregator coordinates the different ECs to decide which EC(s) to utilise. Such coordination may require a more sophisticated design and is out of the scope of this paper. Finally, inequivalence detected by ECs will trigger the updater to update the model by simulation re-initialisation (on the states and/or knowledge) and/or model adaptation.

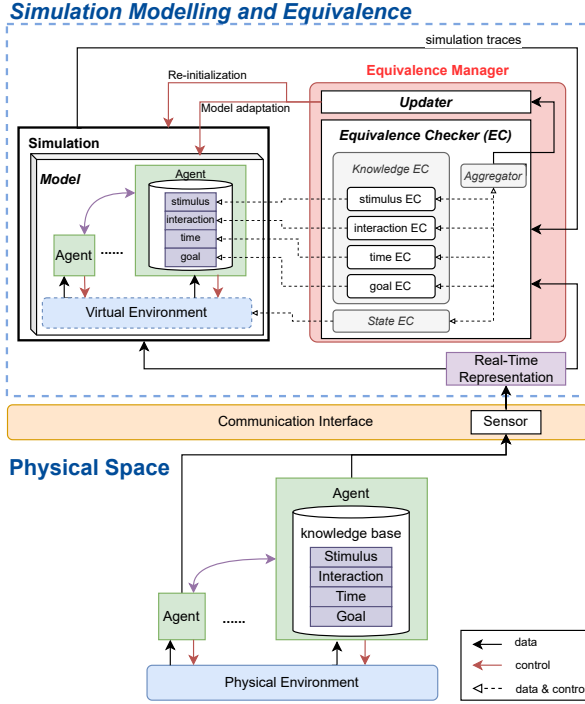

Fig. 5. Instantiation of Fig. 3 with Self-Awareness

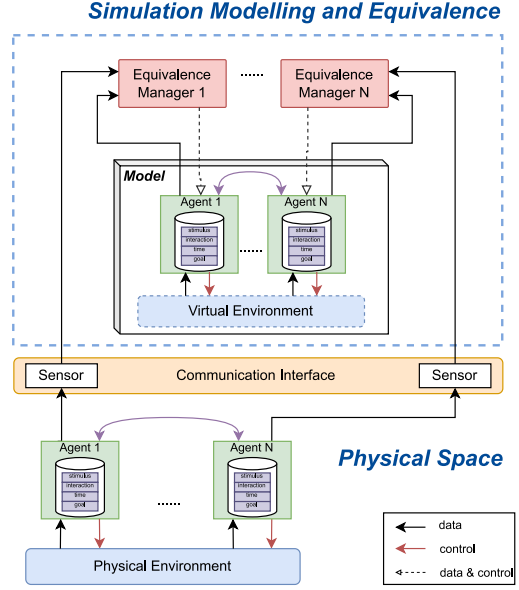

Fig. 6. Decentralisation of Equivalence Managers

The equivalence manager can be implemented as a central entity or decentralised to each virtual agents. In a centralised manner as shown in Figure 5, the manager checks the knowledge of all agents, and update them at the same time. For the decentralisation, each virtual agent is assigned with an equivalence manager as shown in Figure 6. Each equivalence manager only checks the knowledge and state of the agent that it is attached to. All equivalence managers also work asynchronously that each manager decides by itself when to update its virtual agent. In this paper, we particularly focus on the interaction-related knowledge, and the equivalence checking by the interaction equivalence checker. The equivalence manager is assumed to be centralised.

3 KNOWLEDGE EQUIVALENCE

The work presented in this paper focuses specifically on interaction-awareness. Though this awareness level deals with interactions, it backs itself up with both stimuli- and time-awareness knowledge in relation to these interactions. Knowledge can be implemented using different data structures. In this paper, knowledge of an agent is represented as a weighted graph to model interaction with other agents.

3.1 Defining Knowledge Equivalence

First consider a pair of physical and virtual agents with knowledge k_i and k_j respectively. The pair has identical $\{A, \phi, \pi\}$ as modelled in Section 2.1.1. If the two agents are said to exhibit equivalence in their knowledge, then given the same perception, they should output and express the same action. That is, the two agents are deemed to be knowledge

equivalent if and only if:

$$\pi(p, k_i) = \pi(p, k_j) \text{ for all } p \quad (5)$$

Notice that as mentioned in Section 2.1.1, the output of π can either be one single action or a probability distribution of multiple actions. The comparison between two probability distributions can be quantified by well-established statistical techniques (e.g. histograms [19]).

For a multi-agent system and its model, the pair of agents of the virtual and physical worlds should strictly exhibit knowledge equivalent, if: for every agent α_i and its model α'_i , equation (5) should hold.

However, exhaustively evaluating all possible perceptions is infeasible when the state space is too large or when the number of agents is also large. Additionally, it is equally time consuming to compare all possible perceptions at every wall clock time tick.

3.2 Threats to Knowledge Equivalence

Assuming a correct and validated model by design, equivalence between the digital twin and the physical world can be threatened due to various reasons, thus causing deviation between the knowledge or/and states of the two intelligent systems. Here we list some of the major threats to equivalence.

3.2.1 Temporal. Temporal deviation refers to changes in the physical environment not being timely reflected in the digital twin model. This type of deviation can be attributed to inadequate or suboptimal frequency of timely updates. The deviation is often noticed, when the time interval between two updates is long.

The updates can be infrequent and not timely for several reasons. Firstly, hardware bottleneck. The data processing capacity of the digital twin or network bandwidth may not, for example, sustain a high volume of incoming sensor data in a short period of time. Another reason is the need for minimising energy consumption of the sensors. Frequent sensing and data transmission to the digital twin will cause the sensor may consume excessive energy, limiting their dependability and usage lifetime in the long run. Thirdly, a sensor can be temporarily put into sleep mode when its data can be inferred by other sensors [41], but at the risk of inaccurate estimation. Fourthly, the user (human or application) of the model may not require fine-grained high-frequency timely information. Finally, sensors may fail to transmit data due to hardware failure.

The consequence of temporal deviation is that at any time step between two consecutive updates, the status of the physical world can be unknown to the digital twin. The digital twin may rely on data updated or estimates of previous runs, or may extrapolate its knowledge from other data sources. To detect such a deviation, comparison is needed at each updating time step.

3.2.2 Unpredictable Environment Changes. Deviation in knowledge can also happen due to unpredictable environmental changes that a running physical system may experience, and guards for triggering knowledge updates for these changes and surprises are missing in the design. For example, the physical environment can be highly dynamic such that the environment model may not fully model all possible unforeseen scenarios, especially emergency events like car accidents in traffic-related applications, the appearance of sudden objects obstructing the cars etc. Since agents interact with the environment, the deviation between the virtual and physical environment can cause the knowledge of virtual agents and physical agents to diverge, leading to different behaviours. Such a deviation will invalidate knowledge accumulated by the virtual system. To detect this type of deviation, continuous validation can be applied.

3.2.3 Model Drift. Similar to the discussion in [21], model drift refers to changes made in the digital twin not being reflected in the real world and vice versa. Note that model drift is not the same as the temporal deviation. The digital twin may modify the virtual system and synchronise the same changes in the physical system, but the synchronisation may fail, causing the two systems to drift apart. To give an example, the digital twin instructs a virtual robot to carry a parcel to a new location in the simulation, and then intends to synchronise the same action with the physical robot. However, during the operation of the physical robot, the parcel drops halfway during transportation. Without additional verification, the digital twin believes the parcel in the physical world has been transported successfully to the desired destination. The aggregation of this type of deviations over time will cause the model to drastically deviate from the physical world. To detect this deviation, we need data from various additional sources to verify the synchronisation. In the above example, a camera can be installed on the robot to monitor the condition of the parcel as a means of verification.

4 A METHODOLOGY FOR KNOWLEDGE EQUIVALENCE CHECKING

The key of knowledge equivalence checking is to identify potential knowledge drift through continuous online comparison. Two questions are: what to compare, and how to quantitatively identify knowledge drift. In this section, two ways of knowledge equivalence checking are proposed: knowledge comparison and action comparison.

4.1 Knowledge Comparison

Knowledge comparison refers to directly quantifying the similarity of knowledge possessed by the virtual agent and physical agent. The design of similarity metric is specific to the type and representation of knowledge. Therefore, we specifically focus on agents that are interaction-aware.

4.1.1 Knowledge Representation and Drift. For systems where agents interact and collaborate with each other, a common practice is to represent interaction awareness as undirected weighted graphs [19, 23]. This paper also adopts graph to represent interaction related knowledge. In the graph, each vertex represents an agent, and the edge weights are the knowledge of interaction between agents. An example is to use weights to represent the collaboration history and tendency between two agents, which can be modelled by artificial pheromones [23]. For any agent i , if it has a high weight value with a certain agent j , then the weight means agent i has been collaborating with j recently in the past, and i tends to collaborate more with j in the future, rather than other agents with lower weight values.

Globally for the entire system with m agents, there are at maximum $l = \binom{m}{2} = m \times (m - 1)/2$ edges. We use w_j to denote the weight value of the j th edge. The weights of all l edges between physical agents at time t are represented as a vector:

$$\mathbf{w}(t) = (w_1(t), w_2(t), w_3(t), \dots, w_l(t)) \quad (6)$$

Similarly, the edge weights between virtual agents at the current time step t are:

$$\mathbf{w}'(t) = (w'_1(t), w'_2(t), w'_3(t), \dots, w'_l(t)) \quad (7)$$

Then to measure the knowledge drift of interaction-awareness between the simulation and physical world at time step t , we define a metric $drift(t)$ as the Euclidean distance between $\mathbf{w}(t)$ and $\mathbf{w}'(t)$:

$$drift(\mathbf{w}(t), \mathbf{w}'(t)) = |\mathbf{w}(t) - \mathbf{w}'(t)| = \sqrt{\sum_{i=1}^l (w_i(t) - w'_i(t))^2} \quad (8)$$

Algorithm 1: Knowledge Comparison

Input: comparison time interval q , threshold θ , comparison time window l
Data: History of knowledge of all physical agents K , history of knowledge of all virtual agents K' , time t

```

1  $K \leftarrow []$ ;
2  $K' \leftarrow []$ ;
3  $t \leftarrow 0$ ;
4 while True do
5    $w'(t) \leftarrow$  sense knowledge from simulation;
6    $w(t) \leftarrow$  sense knowledge from real world;
7    $K'[t] \leftarrow w'(t)$ ;
8    $K[t] \leftarrow w(t)$ ;
9   // Compare every  $q$  time ticks
10  if  $t \bmod q == 0$  then
11     $d \leftarrow 0$ ;
12    for  $j = \max(0, t-l) \dots t$  do
13       $d \leftarrow d + \text{drift}(K[j], K'[j])$ ;
14    end
15    if  $d > \theta$  then
16       $\sigma(t) \leftarrow$  physical world state at  $t$ ;
17      Re-initialise simulation with  $\sigma(t), K[t]$ ;
18    end
19  end
20  wait for the next wall clock time tick;
21   $t \leftarrow t + 1$ ;
22 end

```

Algorithm 2: Action Comparison

Input: Comparison time interval q , threshold θ , comparison time window l
Data: History of actions by all physical agents A , history of actions by all virtual agents A' , time t

```

1  $A \leftarrow []$ ;
2  $A' \leftarrow []$ ;
3  $t \leftarrow 0$ ;
4 while True do
5    $a(t) \leftarrow$  sense actions from simulation;
6    $a'(t) \leftarrow$  sense actions from real world;
7    $A[t] \leftarrow a(t)$ ;
8    $A'[t] \leftarrow a'(t)$ ;
9   // Compare every  $q$  time ticks
10  if  $t \bmod q == 0$  then
11     $d \leftarrow 0$ ;
12    for  $j = \max(0, t-l) \dots t$  do
13       $d \leftarrow d + \text{deviation}(A'[j], A[j])$ ;
14    end
15    if  $d > \theta$  then
16       $k(t) \leftarrow$  sense knowledge of all physical agents;
17       $\sigma(t) \leftarrow$  sense physical world state;
18      Re-initialise simulation with  $\sigma(t), k(t)$ ;
19    end
20  end
21  wait for the next wall clock time tick;
22   $t \leftarrow t + 1$ ;
23 end

```

4.1.2 Workflow. A threshold-based comparison work flow is designed to identify inequivalence of knowledge, which is shown in Algorithm 1. It is assumed that the simulation proceeds in real-time at the same pace as the wall clock time. The algorithm continuously sense the knowledge bases in the simulated agents and physical agents at every wall clock time tick (lines 5-8). The time duration between two time ticks is specific to the application scenarios, and is out of the scope of this algorithm. The knowledge comparison is run every q time ticks. A time window of length l is used to calculate the cumulative knowledge drift within this window (lines 11-13), where the function $\text{drift}()$ is defined by Equation (8). Then if the drift value is larger than a threshold θ , the simulation is regarded as knowledge inequivalent to the physical world. The simulation then needs to be re-initialised with the latest world state and knowledge (lines 15, 16) as:

$$\sigma'(t) = \sigma(t), \text{ where } \sigma'_i(t) = \sigma_i(t) \quad (9)$$

$$w'(t) = w(t), \text{ where } w'_i(t) = w_i(t) \quad (10)$$

4.2 Action Comparison

Algorithm 1 is only applicable when the drift of knowledge is clearly defined. However, for more generalised situations where knowledge may not be represented as a graph or cannot be easily quantified, different approaches are needed. We propose an alternative approach that compares actions made by virtual and physical agents, since action is the direct result of knowledge, and varies based on the level of knowledge the agent has.

4.2.1 Action Deviation. In order to compare action, a metric that quantifies action deviation is proposed as follows. The main idea is to measure how the actions made by all the virtual agents are different from the physical agents.

First of all, all the agents is assumed to have the same action set A which contains finite number of elements. Then if the physical world is composed of m agents in total, the deviation is calculated as

$$deviation(\mathbf{a}', \mathbf{a}) = \frac{1}{m} \sum_i^m \mathbf{1}_{a'_i=a_i}, \text{ where } \mathbf{1}_{a'_i=a_i} = \begin{cases} 1 & a'_i = a_i \\ 0 & a'_i \neq a_i \end{cases} \quad (11)$$

where a_i and a'_i are the actions made by physical agent i and its virtual counterpart a'_i .

4.2.2 Workflow. Algorithm 2 illustrates the workflow of action comparison, which is similar to knowledge comparison. The main difference is at lines 5-8 and line 12, where the actions made by the physical agents and virtual agents are recorded and compared. In addition, instead of using \mathbf{w} to denote knowledge specifically represented as a graph, we use \mathbf{k} to represent knowledge in order to be generic.

5 EVALUATION

Knowledge equivalence involves two processes: first, checking for knowledge discrepancy and then updating the knowledge. We aim to evaluate both the effect of knowledge update and the performance of the proposed checking methods in dynamically identifying knowledge drift to guide updates. The evaluation will utilise the following metrics:

- *Number of Updates:* this metric corresponds to the total number of updates within a given time period. This metric is indicative of potential overheads that can be incurred as a result of the updates, where more updates may require frequent re-configuration and re-initialisation of the simulation. Once knowledge in-equivalence is identified, an update will follow; henceforth, the number of updates is equal to that of the number of in-equivalence checks.
- *Average utility deviation:* This metric relates to the difference between the task goal satisfaction (defined by a utility function) observed in the real system and simulated modelled system. This metric indicates simulation validity, averaged over the time of observations. The utility function is application-specific, but the metric of utility deviation within n consecutive time units can be defined as:

$$\text{Avg. utility deviation} = \frac{1}{n} \sum_{t=1}^n |u(t) - u'(t)| \quad (12)$$

where $u(t)$ is the utility of the real system at time t and $u'(t)$ is the utility of the modelled system at time t .

The minimisation of both metrics is essentially conflicting in objectives. When the model is updated more frequently, the simulation of the modelled system strives for fidelity with the real system. Conversely, less frequent updates, the simulation can easily drift away from the real system. To address this problem, we assess each of our proposed checking methods by the *Pareto efficiency* of the method's solution set. The solution set is obtained by various possible configurations of that method against the two objectives. Pareto efficiency is based on the *non-domination* relation between solutions. A solution point x dominates y if and only if x is at least as good as y in both objectives and better in at least one [55]. A point x is *non-dominated* if and only if no other points dominate x . The set of all mutually non-dominated solutions is called the *Pareto front*. The experimental analysis aims to answer the following two questions:

- Does knowledge update lead to a high fidelity replica, where the simulation model closely describes the real world and exhibits smaller utility deviation?
- Does knowledge equivalence checking achieve more Pareto efficient results than state equivalence checking under different uncertainties?

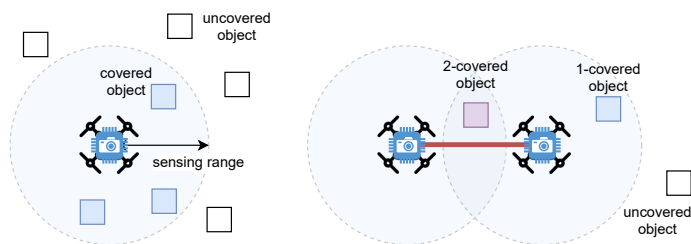
Fig. 7. k -coverage from the bird's-eye view

5.1 An Illustrative Example

The evaluation adopts a modified version of the smart mobile cameras example¹[22]. In the example, fixed number of objects and intelligent drones move in a bounded 2-D space. The drones are equipped with on-board cameras to collaboratively track and monitor objects for surveillance purposes. Each camera is assumed to have an omnidirectional (360-degree) view with a fixed sensing range. Each drone is controlled by an embedded autonomous self-aware agent which decides its actions. Each object moves towards a fixed direction at a constant speed, and will bounce back when it hits the boundary of the 2-D space. Objects can become important or unimportant spontaneously. The goal of the system of drones is to maximise k -coverage: trying to ensure every *important* object is monitored by at least k cameras. We further assume that as long as an object is located within the sensing range of any camera, the object is regarded covered by that camera. An object is k -covered if it is covered by at least k cameras at the same time (see Figure 7).

5.1.1 Utility of Task Goal. To measure the satisfaction of task goal (k -coverage) over time, a *utility function* is used [22]. Suppose there are N_{all} objects in the environment. Let $N_k(t)$ be the number of objects being k -covered at time t . Then the utility at moment t is defined as the ratio of k -covered objects: $u(t) = \frac{N_k(t)}{N_{all}}$.

5.1.2 Self-Aware Agent. Since no single agent has a global view of the world (due to limited sensing capability), each agent is assumed to collaborate with others based on message communication. An agent can request other agents to help tracking the same object by advertising the object ID and position. Other agents can then decide whether to accept the request and move towards the advertised object. To avoid broadcasting to all other agents which is costly in communication, each agent is assumed **interaction-aware** to intelligently decide which ones to send messages to and which request message to accept.

First of all, stimulus-awareness is the basis of self-awareness. The stimuli in our example are the local perception of the agent, which includes the received messages, current position of itself, as well as the current positions and importance of all objects within its camera range. An agent is able to use the stimuli to decide which direction to move to track a certain object.

Beyond stimuli, the knowledge of interaction in this example is the status of co-covering. A drone is able to identify the coverage of other drones of objects as itself in a given time; this can be achieved through short-range wireless sensing technology as assumed in the original example [22]. Such knowledge of interaction is modelled as artificial pheromones, represented as a weighted graph, and maintained by each agent in its local memory. Agents are vertices in the graph. The edge weights reflect the recency of co-covering collaboration. If any two agents are both covering

¹All elements used for the experimental analysis presented in this paper including the source code, parameters, data and results are available at <http://digitwins.github.io>

one or more same important objects, then the weight of the edge connecting the two agents will be “strengthened” by adding a constant value δ . All edge weights will also “evaporate” through time by multiplying a discount factor γ at the end of every time unit [22, 23].

With the knowledge of interaction, an agent tends to communicate with agents that it has collaborated with very often recently. When requesting for help, the agent shall only notify the $(k + 1)$ agents with which it has the strongest weights. When deciding which request to accept, the agent will rank the received messages first by edge weight then by the received time. The agent will only accept the most recent request sent by the agent that has the highest edge weight. A more detailed description about the behaviour of a single agent is shown in Algorithm 5 in appendix A which is based on [22]. Each agent in the system are all designed as Algorithm 5.

5.2 Prototype Implementation

We use two simulators to implement the example and its digital twin as shown in Figure 8. The two simulators runs in parallel, denoted as *Simulator P* and *Simulator D* to represent the **Physical world** and its **Digital twin** replication, respectively. Both simulators are implemented by the agent-based simulation engine Repast Symphony [43], and can simulate the behaviours of objects and drones. The two simulators are identical jar executables, but multiple types of uncertainties are introduced between the two, which is explained later in section 5.3.1. The simulator initialises its starting scene by loading an XML file, which contains the information of all drones and objects as shown in Table 1. The simulation state $\sigma(t)$ as defined by Equation 3 is composed of the positions (x-y coordinates) of all objects and drones at time t .

The equivalence manager is implemented in Python and uses Py4j² to interact with the two simulators. It is able to sense data listed in Table 1 from both simulators at every time step. When an update of the digital twin is needed, the equivalence manager re-initialises *Simulator D* by passing all data in Table 1 sensed from *Simulator P* as an XML file.

Table 1. Types of data accessible in simulation

Entity	Attribute Data
Drone	ID
	position
	received messages
	interaction graph
Object	ID
	position
	direction
	importance

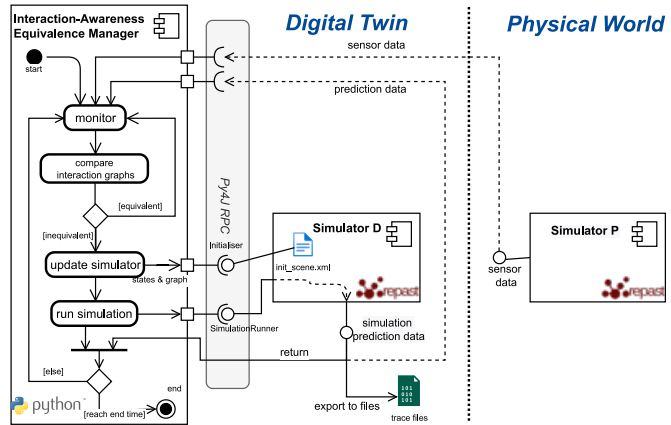

Fig. 8. The implementation architecture for the prototype.

5.3 Experimental Frame

5.3.1 *Evaluation Scenarios*. To emulate the situations in real-world settings, biases and uncertainties are considered. Following on the discussions of section 3.2, we consider the following three threats to equivalence:

²<https://www.py4j.org/>

- (T1) Inaccurate design time assumption: biased model parameters;
- (T2) Randomness in agent behaviours;
- (T3) Unpredictable environment: data out of the sensor range are unknown.

First, for **T1**, systematic deviation of an object could be encountered in the physical environment, but may not be considered in the model of the object. In the experiment, the simulation model assumes its objects to have experienced systematic deviation in movement, where each physical object moves with a systematic error angle of 3 degrees to its left, but the model is not aware of such a deviation. Such an error can be common. For instance, if the object moves with wheels, then the error could be caused by the manufacturing imprecision of the wheels.

Second, the virtual agents and physical agents may exhibit different behaviours. When randomly deciding which object to track at line 11 of Algorithm 5, the physical agent and its virtual counterpart may take different choices. In the experiments, the virtual agents and physical agents are provided with different random seeds.

Third, for **T3**, if the digital twin is only able to acquire data from the drones in the physical world, then the positions of objects that are not covered by any drone are deemed to be unknown. Therefore, the behaviour of the entire system cannot be simulated accurately. These unknown positions can be estimated (e.g. through past trajectories of objects), but the estimation techniques are out of the scope of this paper. In the experiments, we assume the digital twin can estimate these positions with a random error $[0, 5]$ on both x and y coordinates.

We construct two conditions combining two threats, where each of the conditions, 1 and condition 2 are applied to six different starting scenes (shown in Figure 9) respectively: (a) Condition I: **T1** and **T2** (b) Condition II: **T1** and **T3** Therefore, in total $2 \times 6 = 12$ different evaluation scenarios are designed. Each scenario is denoted by its condition and initial scene. For instance, scenario I-3 refers to the combination of Condition I and scene 3.

5.3.2 Simulation Setup. The simulation uses discrete logical time. The model parameters for the two simulators are set as follows. The environment is designed to be a 50×50 2-D world with boundary. The task goal is to maximise 2-coverage, with $k = 2$. Each object moves 1 unit distance every time step and becomes important or unimportant every 30 time steps. The sensing range of each camera is 10. The parameters of edge weights are $\gamma = 0.9$ and $\delta = 1$. At the beginning, the two simulators are initialised with identical state and zero knowledge. Each experiment configuration is run for 1000 simulation time steps and repeated 5 times if not specified otherwise.

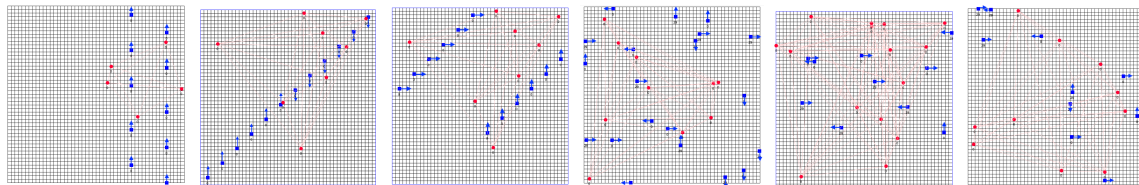

(a) Scene 1: 10 objects, 5 drones, (b) Scene 2: 12 objects, 8 drones, (c) Scene 3: 12 objects, 8 drones, (d) Scene 4: 20 objects, 10 drones, (e) Scene 5: 10 objects, 15 drones, (f) Scene 6: 10 objects, 10 drones

Fig. 9. The initial snapshot of the evaluation scenes. We consider a 2-D world of size $50 * 50$. The blue rectangles are the objects. The red circles are the drones. Scene 4, 5 and 6 are generated by randomly positioning the objects and drones and randomly assigning the initial moving direction of each object to be one of the four: east, north, west and south.

5.4 Simulation Validity of Knowledge Update

Firstly, the performance of knowledge update is evaluated. The aim is to investigate how different knowledge update strategies, when applied at different time steps of the simulation, can affect utility deviation over time. In particular, three knowledge update strategies are evaluated, each differs in how the knowledge is updated:

- *keep knowledge*: update all data listed in Table 1, except for the interaction graph, and keep the graph in the simulated system unchanged.
- *clear knowledge*: update all data in Table 1, except for the interaction graph, and set all edge weights to zero.
- *update knowledge*: update all data listed in Table 1

Each experiment is designed to run for 100 time steps, which contains two phases: *knowledge accumulation* phase and *evaluation* phase. Each phase lasts for 50 time steps. The beginning of *knowledge accumulation* is called *start time*, and the end is called *update time*. At *start time*, the simulated system is initialised by replicating the snapshot of the real system, which contains all data listed in Table 1. At *knowledge accumulation* phase, both systems run for 50 time steps to allow their knowledge to evolve. The two systems also gradually deviate from each other because of condition I. Next, at *update time*, the three update strategies are applied respectively to the simulated system by sensing the real system. Finally at the *evaluation* phase, both systems run another 50 time steps, and the utility deviation is evaluated.

To emulate updating at different points in time, for each of the scenarios I-1 to I-6, 30 time stamps are randomly sampled from 1 to 900. Each time stamp serves as the *start time* for one experiment. Each experiment is repeated 10 times.

The average results for $30 \times 10 = 300$ runs of each scenario are shown in Figure 10. The deviation of each bar is relatively large because even for one certain scenario, the system behaviours during different time periods are different. Then the performance of utility deviation may fluctuate among these 30 randomly sampled time periods. Nevertheless, by taking the average, the figure shows that for all the scenarios, the *update knowledge* strategy performs the best by achieving the lowest utility deviation. If knowledge is kept the same as before, the old knowledge can still take effect but the accuracy of utility is lower. If knowledge is reset at the update time, the simulation generally cannot guarantee the accuracy of utility as the other two strategies. Since different knowledge leads to different actions of the agent, the resultant task utility may also be affected. Therefore, when updating, in addition to maintaining the same state in the simulated system, the same knowledge should also be maintained.

In addition, Figure 11 shows the utility of scenario I-6 during the *evaluation phase*. The start time and update time are set as 270 and 320, respectively. The figure clearly shows that updating knowledge ensures the simulation most accurately “follow” the ground truth utility. Notice that the simulation starts to deviate only after time 333 in both three sub-figures. This is first because all objects switch their status of importance at time 330 (as assumed in Section 5.3.2). The important objects covered by drones then become unimportant. Therefore, the drones need to search and cover other objects that just became important, which leads to different movement patterns than patterns before time 330. Also, condition I causes the positions of objects in the simulation to deviate from the real objects. With different drone movement patterns and different object positions, the utility deviates after time 333.

5.5 Pareto Efficiency of Knowledge Equivalence Checking

Next, we evaluate our proposed knowledge equivalence checking methods: knowledge comparison and action comparison, which do not assume a fixed update frequency. When updating Simulator D, all data in Table 1 are replicated from Simulator P.

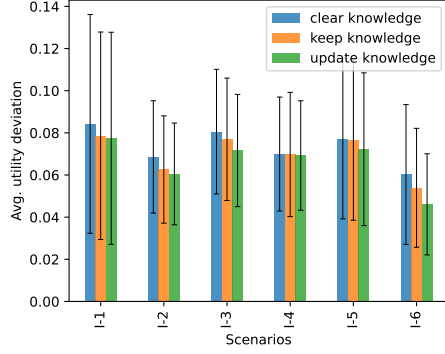

Fig. 10. Knowledge update strategies in 6 scenarios

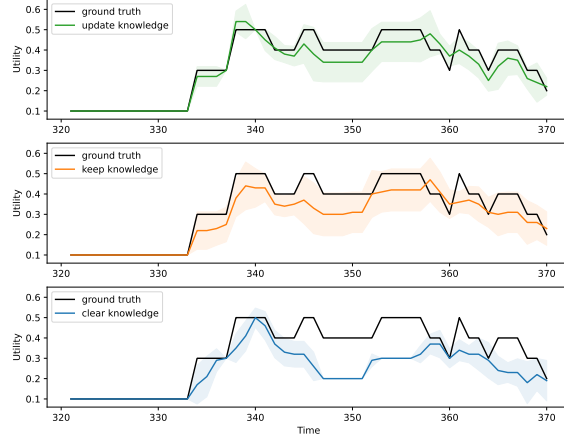

Fig. 11. 2-coverage utility of three knowledge update strategies, after updating at time 320 in Scenario I-6

Algorithm 3: State Comparison

Input: Comparison time interval q , threshold θ , comparison time window l
Data: History of physical world state Σ , history of virtual world state Σ' , time t

```

1  $\Sigma \leftarrow []$ ;
2  $\Sigma' \leftarrow []$ ;
3  $t \leftarrow 0$ ;
4 while True do
5    $\sigma(t) \leftarrow$  sense from simulation;
6    $\sigma'(t) \leftarrow$  sense from real world;
7    $\Sigma[t] \leftarrow \sigma(t)$ ;
8    $\Sigma'[t] \leftarrow \sigma'(t)$ ;
9   // Compare every  $q$  time ticks
10  if  $t \bmod q == 0$  then
11     $d \leftarrow 0$ ;
12    for  $j = \max(0, t-l) \dots t$  do
13       $d \leftarrow d + deviation(\Sigma'[j], \Sigma[j])$ ;
14    end
15    if  $d > \theta$  then
16       $k(t) \leftarrow$  sense knowledge of all physical agents;
17      Re-initialise simulation with  $\sigma(t), k(t)$ ;
18    end
19    wait for the next wall clock time tick;
20     $t \leftarrow t + 1$ ;
21 end

```

Algorithm 4: Fine-Grained Action Deviation

Input: The action made by a physical agent, the action made by the virtual agent
Output: The deviation of two actions

```

1 if both actions are random walk then return 0;
2 if both actions are follow then
3   if both agents follow the same object then
4     return 0;
5   else return 1;
6 if both actions are respond-and-follow then
7    $d \leftarrow 0.4$ ;
8   if both agents respond to the same agent then
9      $d \leftarrow d - 0.2$ ;
10  if both agents follow the same object then
11     $d \leftarrow d - 0.2$ ;
12  return  $d$ ;
13 if both actions are notify-and-follow then
14    $c \leftarrow$  the number of commonly notified agents by the two given agents;
15   if both agents follow the same object then
16     return  $0.5 \cdot (1 - \frac{c}{K-1})$ ;
17   else return  $0.5 \cdot (1 - \frac{c}{K-1}) + 0.5$ ;
18 if one action is follow and the other is notify-and-follow then
19   if both agents follow the same object then
20     return 0.5;
21   else return 1;
22 return 1;

```

We regard to *state comparison* as the baseline, which is shown in Algorithm 3. A state is composed of the positions of all the cameras and objects. The deviation of two states is also measured by their Euclidean distance as:

$$deviation(\sigma(t), \sigma'(t)) = |\sigma(t) - \sigma'(t)| = \sqrt{\sum_{i=1}^l (\sigma_i(t) - \sigma'_i(t))^2} \quad (13)$$

There are three parameters of each comparison method. We assume the comparison is made every time step $q = 1$ and the time window is $l = 1$. The performance of the comparison method is largely dependent on the threshold value θ , which defines the tolerance to deviation. We evaluate various different values of θ for each method, and contrast the three methods by their Pareto efficiency. Experiments for each threshold value is repeated 5 times.

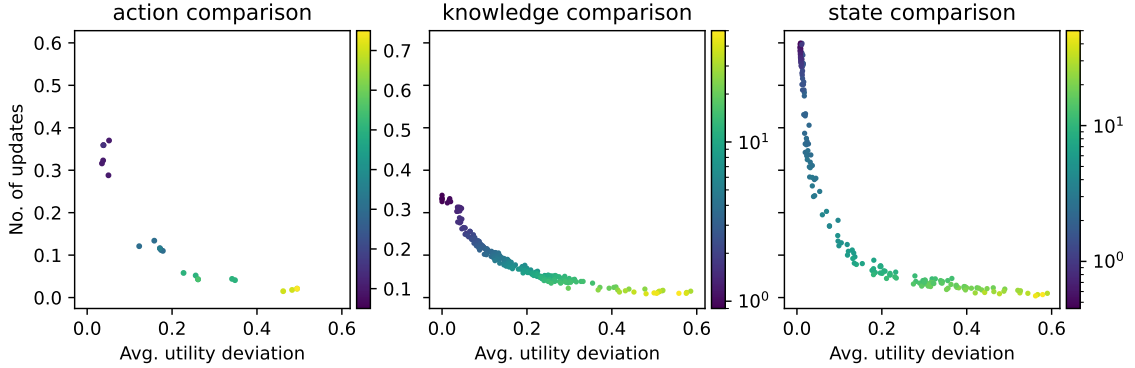

Fig. 12. Solutions (after normalisation) obtained by different threshold values in scenario I-1. Values of threshold are shown by different colors.

Knowledge comparison and state comparison are both applied to each of the 12 scenarios. Action comparison is applied to scenarios II-1 to II-6. In action comparison, we view action at a coarse grain and only distinguish 4 different actions: follow, notify-and-follow, respond-and-follow, and random walk.

5.5.1 Performance trade-off due to threshold values. The different solutions obtained by various threshold values can be seen in Figure 12, in which we apply the three comparison methods to scenario I-1. The trade-off between the two metrics can be observed for each of the method. When the threshold value is small, the number of updates is large and the utility deviation is small. Conversely, a larger threshold will lead to less number of updates but larger utility deviation. Therefore, Pareto efficiency is then used to compare between the solution sets of the three methods.

5.5.2 Analysis by Pareto Efficiency. The results for the experiments on all 12 scenarios are shown in Figure 13. In all the 12 scenarios, knowledge comparison shows more Pareto efficient results when the average utility deviation is small, which are shown in the highlighted area of each sub-figure. A clear divergence trend can be observed in the solutions that as the average utility deviation decreases, solutions of knowledge comparison start to dominate state comparison. Knowledge comparison also exhibits a flatter curve in contrast to state comparison. At the extreme case, knowledge comparison achieves 0 utility deviation with much less updates than state comparison. However, when the utility deviation is larger, state comparison can be sometimes better or similar to knowledge comparison. In addition, action comparison is generally slightly worse than both other methods.

Performance of knowledge comparison, as depicted in Figure 14 reveals a common situation under threats T1: though the utility and knowledge are correctly simulated, the drones of the simulated world shows complete deviation, as when compared to their real positions. In this situation, two drones are tracking one object. In both the real and simulated worlds, the two drones are always covering the given object. The utility of 2-coverage for this two-drone system is always 1 in both worlds during the 4th time steps. The knowledge in both systems are both incremented the same way thus being identical. However, since the positions of the two systems are different, state comparison will regard the simulation as "deviated" and then will trigger an update, but knowledge comparison will not. Therefore, this situation shows that even with no utility deviation, state comparison can still invoke unnecessary updates, as observed in the highlighted areas of Figure 13. Nevertheless, the advantage of knowledge comparison is only prominent when the tolerance by threshold is small. With larger thresholds, the simulation will evolve much further over time until the

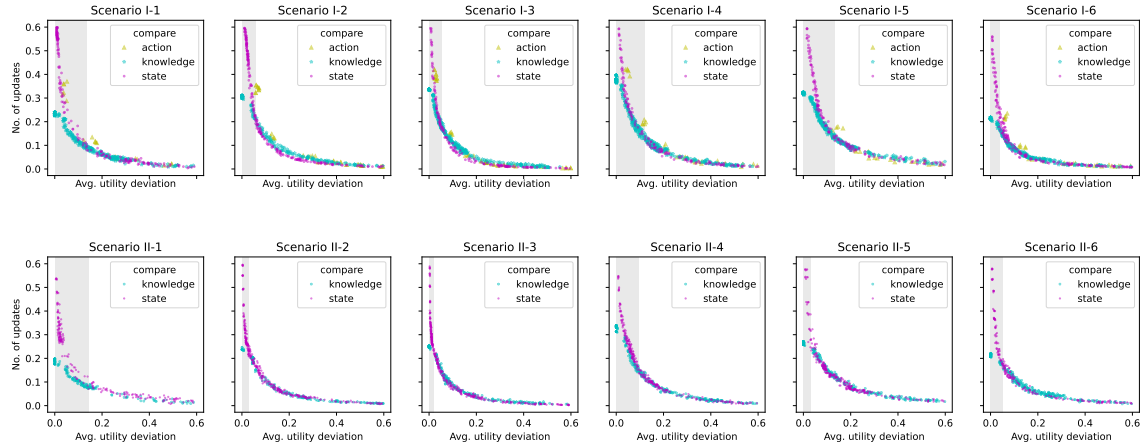

Fig. 13. Simulation results for all 12 scenarios. The x-axis is normalised by the value of average utility deviation obtained when no update is involved. The values are: 0.1436, 0.1452, 0.2224, 0.1343, 0.1165, 0.1416, 0.1519, 0.1519, 0.2167, 0.1449, 0.1250, 0.1475. The y-axis is normalised by 1000, which is the worst situation where the simulation should be updated each time unit. Within the highlighted area in grey, all solutions of state comparison are dominated by knowledge comparison.

accumulated deviation is greater than the threshold and triggers of the next updates. After evolving longer over time, the complex interaction with other drones and objects may lead to an entirely different system topology in the simulation, where the knowledge, state, and utility are all largely deviated. In this case, monitoring state (position) deviation might be more relevant to utility deviation, since the utility of coverage is calculated based on the relative position between objects and agents. This phenomenon is shown by the non-highlighted areas in Figure 13. Also, if contrasting conditions I and II, the highlighted areas in II are generally smaller than I. This is because the large inaccuracy of the positions of uncovered objects under condition II causes the knowledge and system topology to deviate faster than condition I. For condition II, only when the threshold is smaller when compared to I, knowledge comparison can outperform the state one.

Therefore, when the requirement of the digital twin application focuses on minimising the utility deviation of the simulation, knowledge comparison can reduce much more overheads caused by unnecessary updates. With the same number of updates, knowledge comparison also ensures more accurate simulation on the task utility as when compared to state comparison.

We then quantitatively compare the three approaches by the notion of *hypervolume*, which measures the quality of a Pareto front by the size of the space dominated by all nondominated solution points with respect to a reference point [55]. A larger hypervolume is better. In this paper, we use (1, 1) as the reference point for hypervolume calculation. The results are shown in Table 2. The values in the table confirm our observations above for the three approaches: in almost all the cases, knowledge comparison has a larger hypervolume than state comparison; action comparison has the smallest hypervolume.

Additionally, in action comparison, the action and its deviation can be quantified by viewing at different levels of granularity. The previously evaluated view of action is regarded as the coarse-grained view. A fine-grained view of action deviation is then further designed and evaluated. The calculation follows Algorithm 4, which defines the deviation of the actions of one physical agent and its virtual agent counterpart at a particular time step. The evaluation is based on

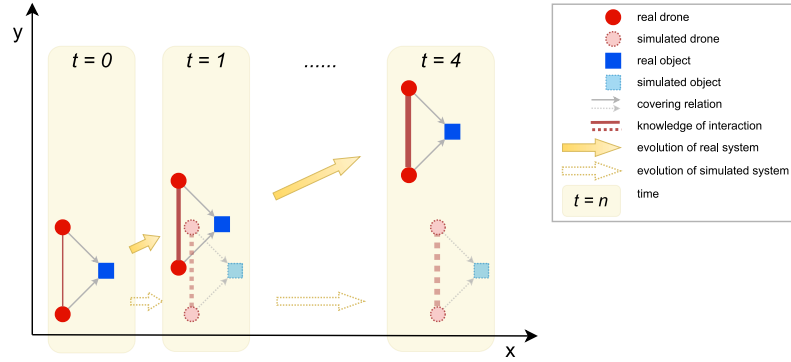

Fig. 14. A situation where state is deviated but knowledge and utility are not. At $t=0$, the simulated world and real world are identical, hence they overlap at the same position.

Table 2. Hypervolume of solutions

Methods	Test Scenarios					
	I-1	I-2	I-3	I-4	I-5	I-6
State	0.9503	0.9456	0.9638	0.9401	0.9231	0.9649
Knowledge	0.9629	0.9500	0.9643	0.9489	0.9385	0.9699
Action	0.9090	0.8910	0.9336	0.9013	0.8417	0.9104
Methods	Test Scenarios					
	II-1	II-2	II-3	II-4	II-5	II-6
State	0.9525	0.9607	0.9721	0.9458	0.9407	0.9562
Knowledge	0.9635	0.9638	0.9711	0.9542	0.9469	0.9646

scenarios I-1 to I-6 and follows the same procedure as Section 5.5. The results are shown in Figure 15, in which the newly introduced fine-grained view is denoted as `action2` and the coarse-grained view is denoted as `action`. According to the results, the coarse-grained view `action` is more Pareto efficient in all 6 scenarios. One possible reason is that the `action` is more related to the utility deviation. The utility is measured by the number of objects being covered at a global view, not who is covering which specific object. The four coarse actions used by `action` indicate whether an agent is covering any important objects, which directly contributes to the utility of `k-coverage`. For instance, if the virtual and physical agents are both doing the `action respond-and-follow`, then this means they have both not sensed any important object. Then `action` will regard them as equivalent, because responding to which particular drone and trying to follow which object do not make any difference in `k-coverage` at current moment. However, `action2` would distinguish in detail about the other drone and object, which can be too strict in specifying deviation.

5.6 Memory Usage of Knowledge Equivalence Checking

The memory usage of each method is evaluated and the results are shown in Figure 16. The y-axis of the figure is the total extra amount of sensor data that need to be loaded into the memory for the comparison. `Action` comparison uses much less memory as when compared to the other two, since an `action` can be encoded as one integer. Despite being a bit less Pareto efficient than the other two methods as in Figure 13, `action` comparison is the best choice when less memory consumption is preferred. Although `knowledge` comparison is more Pareto efficient in previous evaluation, its

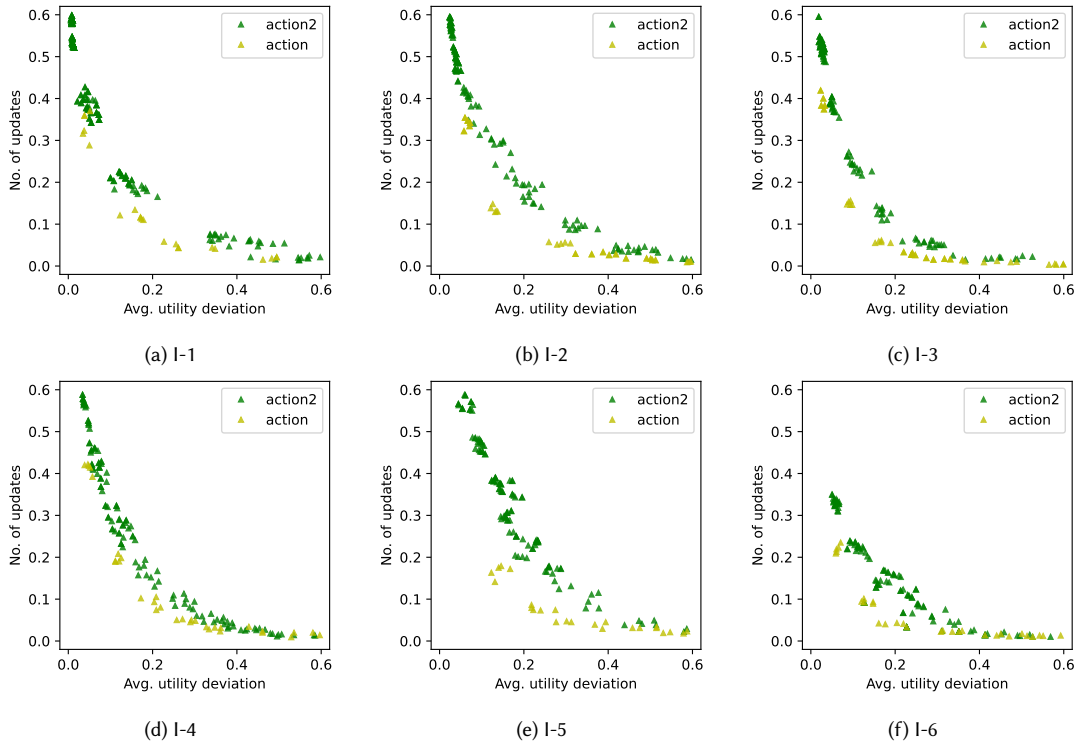

Fig. 15. Two different ways of quantifying actions applied to scenarios I-1 to I-6

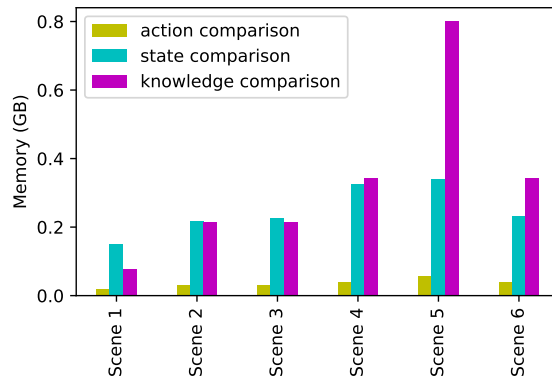

Fig. 16. Extra memory required for the comparison

memory consumption will increase exponentially as the graph size increases. For instance, scene 4 has 10 cameras and 45 graph edges, while scene 5 involves 15 cameras and 105 edges, causing memory consumption to double in scene 5 than scene 4.

5.7 Discussions

To summarise, when high utility of simulation validity is preferred, knowledge comparison achieves the best trade-offs of reducing update overhead and increasing accuracy. When less updates are preferred, the three methods are generally comparable; however, knowledge comparison is sometimes has proven to be slightly worse than the baseline approach. As for the hypervolume metric, knowledge comparison is generally comparable or better than the baseline. Although action comparison does not perform better than the other two methods, it can largely reduce memory consumption.

We have conducted controlled experiments using simulated data. Simulated data have provided us with cost-effective path for learning about the behaviour and performance of enacting knowledge equivalence in digital twins under a range of scenarios that can exemplify complex real settings. Nevertheless, further systematic studies will consider data from real-world systems and domain-specific properties to evaluate for knowledge equivalence. Additionally, only three types of threats to equivalence are considered in our experiments, further studies is needed to evaluate for the manifestation of multiple types and/or compounded threats that may exist at the same time, including the threats mentioned in section 3.2. Our controlled experiments assumes a situation where the configuration of the environment is known: the number of objects and how an object will become important is known. Further studies need to consider highly volatile dynamic and opportunistic scenarios.

6 RELATED WORK

The concept of equivalence has been investigated in different domains and problems including model verification and validation [9, 47, 50], dynamical systems [51], model checking [5, 13], program equivalence [12, 48], software evolution [53], knowledge representation [26], bisimulation of concurrent systems [15], agent-based model adaptation [27], VLSI design[7, 58], and industrial control systems [52]. Grounding models to data in an online feedback loop has been extensively investigated in the context of DDDAS systems, a comprehensive review of approaches to implement the feedback loop is provided in [6].

This section provides an overview of approaches and techniques that focus specifically on the issue of twinning addressing the problems of how to decide when the model needs to be updated and how the model is updated. Table 3 summarises these approaches. Three main classes of approaches are distinguished, namely replicate the sensor data without any comparison; explicitly identify discrepancies between the model and the real system; continuously model calibration. With regard to model adaptation four elements that may be updated are state variables, parameters, behavioural rules and input.

6.1 Sensor Data Replication

This approach aims at achieving equivalence by directly replicating sensor data into the model. The sensor data may be used to update the state of the model either at a fixed frequency [2] or dependent on the availability of data or event [14, 37]. The aim is to ensure the state of the model reflect that of the real system.

In [18] state is replicated by identifying and updating the stimuli inputs in industrial control systems. This work assumes the physical system and twin system run the same program defined by a finite state machine. However, the state transition of the program is fixed and does not evolve overtime.

Table 3. Related works for online equivalence

Category	Reference	Comparison entities	Update	Method
Replication	[2, 14, 37]	-	state	
Replication	[18]	-	input (stimuli)	Stimuli identification
Equivalence Checking	[35]	knowledge (rules of agents)	-	Association rule mining
Equivalence Checking	[24]	outputs given the same inputs	-	Gaussian Mixture Model & Hidden Markov Model
Equivalence Checking	[29]	state	parameter	Reinforcement learning
Online Calibration	[28, 44]	state	parameter	Optimisation
Online Calibration	[59]	output	input	Optimisation
Online Calibration	[30]	statistical test on state	parameter	Optimisation
Online Calibration	[33]	N/A	state	Bayesian inference
Online Calibration	[1]	N/A	N/A	Kalman filter or PID
Online Calibration	[31]	output	parameter	Error feedback
Online Calibration	[42]	state	parameter	Online training

6.2 Discrepancy Checking

This approach focuses on explicitly comparing the model and the real system to identify discrepancies and decide whether and when to update the model. The AIMSS system has investigated this problem in the context of info-symbiotic (DDDAS) agent-based social simulations[34–36]. The system utilises a SAT solver to detect inconsistencies of different rule sets from the model and the real world dynamically identified via associative rule mining. The rules can be viewed as knowledge of the agents, however this is performed offline.

The discrepancy detector in [24] utilises a Gaussian mixture model to compare the outputs of the real system and model given the same inputs and detect anomalies due to missing mode of the model.

Checking the inconsistency of states using reinforcement learning (RL) agents is described in [29]. The RL agents take the state difference as inputs and decide whether to update and which parameter to calibrate.

6.3 Continuous online calibration

Continuous online model calibration is also utilised for maintaining an equivalent model. Calibration focuses on continuously tuning the model parameters, typically at a fixed frequency. Approaches in this category include the use of: difference/error between observation and predicted values of the state variables as objective function to optimise the selection of parameters or inputs [28, 44, 59]; statistical tests on simulated and real traffic flows as calibration criteria [30]; Bayesian inference in the context of unmanned aerial vehicle applications [33]; Kalman filter [1]; the error between observed output and predicted output as feedback for the calibration of clock models [31]; and online calibration by training deep learning models with streaming data (state variables) [42].

7 SUMMARY AND FUTURE WORK

This paper has investigated the problem of knowledge equivalence in the context of digital twins of intelligent multi-agent systems. The objective of the work is to ensure that knowledge equivalence and self-awareness are kept up-to-date in the digital twin and synchronised with the physical world. Knowledge equivalence is particularly important for unlocking cognitive capabilities in the digital twin that can promote new opportunities for sophisticated analysis (e.g., what-if prognostic and diagnostic analysis) that can further support and enhance intelligence in the physical world. Additionally, our contribution shows that knowledge can provide an alternative equivalence metric for such a complex

setting, where using knowledge equivalence can alleviate overheads of continuous calibration of models, which leverage state, and/or input parameters comparison and updates.

The paper has presented a conceptual architecture for intelligent self-aware digital twins and an approach for checking knowledge equivalence at the interaction level. Our analysis of the proposed approach demonstrates that knowledge equivalence can tolerate deviation thus reducing unnecessary updates and unwanted overheads. When compared to discrepancy analysis based on state, knowledge equivalence can achieve more Pareto efficient results on the trade-off between overhead (number of updates) and effectiveness (utility deviation). This can significantly reduce update overheads, when lower utility deviation is preferred.

Our future work will consider incorporating more sophisticated statistical techniques like hypothesis tests to improve the knowledge discrepancy analysis process. Additionally, we are exploring new self-adaptive mechanisms for selective updates of the physical agent(s) in situations, where intelligence in digital twin exceeds that of the physical setting and mirroring the updates can be particularly important for harnessing intelligence in the physical world. In the current model, agents are homogeneous in their decision models. Our future work will consider scenarios with heterogeneous agents with more sophisticated utility functions and metrics that capture different properties of the system under analysis.

ACKNOWLEDGMENTS

This research was supported in part by: SUSTech-University of Birmingham Collaborative PhD Programme; Guangdong Province Innovative and Entrepreneurial Team Programme, China (No. 2017ZT07X386); Shenzhen Peacock Programme, China (No. Y01276105); SUSTech Research Institute for Trustworthy Autonomous Systems, China; and EPSRC/EverythingConnected Network project on Novel Cognitive Digital Twins for Compliance, UK.

REFERENCES

- [1] Fatemeh Akbarian, Emma Fitzgerald, and Maria Kihl. 2020. Synchronization in Digital Twins for Industrial Control Systems. (2020). arXiv:2006.03447
- [2] Tomas Ambra and Cathy Macharis. 2020. Agent-Based Digital Twins (ABM-DT) in Synchronodal Transport and Logistics: The Fusion of Virtual and Physical Spaces. In *Proceedings of the Winter Simulation Conference (WSC '20)*. IEEE Press, Orlando, FL, USA, 159–169.
- [3] ARUP. 2019. *Digital twin: towards a meaningful framework*. Technical Report. ARUP. www.arup.com/digitaltwinreport
- [4] Barbara Rita Barricelli, Elena Casiraghi, and Daniela Fogli. 2019. A survey on digital twin: Definitions, characteristics, applications, and design implications. *IEEE Access* 7 (2019), 167653–167671.
- [5] A. Biere, A. Cimatti, E.M. Clarke, M. Fujita, and Y. Zhu. 1999. Symbolic Model Checking using SAT procedures instead of BDDs. In *Proceedings 1999 Design Automation Conference (Cat. No. 99CH36361)*. ACM, New York, NY, USA, 317–320.
- [6] Erik Blasch. 2018. DDDAS Advantages from High-Dimensional Simulation. In *2018 Winter Simulation Conference (WSC)*. IEEE Press, Gothenburg, Sweden, 1418–1429.
- [7] Nicola Bombieri, Franco Fummi, Graziano Pravadelli, and Joao Marques-Silva. 2007. Towards Equivalence Checking Between TLM and RTL Models. In *2007 5th IEEE/ACM International Conference on Formal Methods and Models for Codesign (MEMOCODE 2007)*. IEEE Computer Society, USA, 113–122.
- [8] Valeria Cardellini, Francesco Lo Presti, Matteo Nardelli, and Gabriele Russo. 2018. Decentralized self-adaptation for elastic Data Stream Processing. *Future Generation Computer Systems* 87 (2018), 171–185.
- [9] John S. Carson. 2002. Model Verification and Validation. In *Proceedings of the Winter Simulation Conference*, Vol. 1. IEEE Press, San Diego, CA, USA, 52–58 vol.1.
- [10] Shuyi Chen, Masatoshi Hanai, Zhengchang Hua, Nikos Tziritas, and Georgios Theodoropoulos. 2020. Efficient Direct Agent Interaction in Optimistic Distributed Multi-Agent-System Simulations. In *Proceedings of the 2020 ACM SIGSIM Conference on Principles of Advanced Discrete Simulation (SIGSIM-PADS '20)*. ACM, Miami, FL, Spain, 123–128.
- [11] Tao Chen, Funmilade Faniyi, Rami Bahsoon, Peter R. Lewis, Xin Yao, Leandro L. Minku, and Lukas Esterle. 2015. The Handbook of Engineering Self-Aware and Self-Expressive Systems. (2015). arXiv:1409.1793v3
- [12] Berkeley Churchill, Oded Padon, Rahul Sharma, and Alex Aiken. 2019. Semantic Program Alignment for Equivalence Checking. In *Proceedings of the 40th ACM SIGPLAN Conference on Programming Language Design and Implementation (PLDI 2019)*. ACM, Phoenix, AZ, USA, 1027–1040.

- [13] Edmund M. Clarke, William Klieber, Miloš Nováček, and Paolo Zuliani. 2012. *Model Checking and the State Explosion Problem*. Springer Berlin Heidelberg, Berlin, Heidelberg, 1–30.
- [14] Thomas Clemen, Nima Ahmady-Moghaddam, Ulfia A Lenfers, Florian Ocker, Daniel Osterholz, Jonathan Ströbele, and Daniel Glake. 2021. Multi-Agent Systems and Digital Twins for Smarter Cities. In *Proceedings of the 2021 ACM SIGSIM Conference on Principles of Advanced Discrete Simulation (SIGSIM-PADS '21)*. ACM, New York, NY, USA, 45–55.
- [15] Nicoletta De Francesco, Giuseppe Lettieri, Antonella Santone, and Gigliola Vaglini. 2016. Heuristic Search for Equivalence Checking. *Software & Systems Modeling* 15, 2 (2016), 513–530.
- [16] Ada Diaconescu, Kirstie L. Bellman, Lukas Esterle, Holger Giese, Sebastian Götz, Peter Lewis, and Andrea Zisman. 2017. Architectures for Collective Self-aware Computing Systems. In *Self-Aware Computing Systems*. Springer International Publishing, Cham, Switzerland, 191–235.
- [17] Carlos Henrique dos Santos, José Arnaldo Barra Montevechi, José Antônio de Queiroz, Rafael de Carvalho Miranda, and Fabiano Leal. 2021. Decision support in productive processes through DES and ABS in the Digital Twin era: a systematic literature review. *International Journal of Production Research* (2021), 1–20.
- [18] Matthias Eckhart and Andreas Ekelhart. 2018. A Specification-based State Replication Approach for Digital Twins. In *Proceedings of the 2018 Workshop on Cyber-Physical Systems Security and Privacy (CPS-SPC '18)*. ACM Press, New York, New York, USA, 36–47.
- [19] Abdessalam Elhabbash, Rami Bahsoon, and Peter Tino. 2016. Interaction-Awareness for Self-Adaptive Volunteer Computing. In *2016 IEEE 10th International Conference on Self-Adaptive and Self-Organizing Systems (SASO)*. IEEE Press, Augsburg, Germany, 148–149.
- [20] A. Elhabbash, R. Bahsoon, P. Tino, P. R. Lewis, and Y. Elkhatib. 2021. Attaining Meta-self-awareness through Assessment of Quality-of-Knowledge. In *2021 IEEE International Conference on Web Services (ICWS)*. IEEE Computer Society, Los Alamitos, CA, USA, 712–723.
- [21] Naeem Esfahani and Sam Malek. 2013. *Uncertainty in Self-Adaptive Software Systems*. Vol. 7475 LNCS. Springer Berlin Heidelberg, Berlin, Heidelberg, 214–238.
- [22] Lukas Esterle and Peter R Lewis. 2017. Online Multi-Object k-Coverage with Mobile Smart Cameras. In *Proceedings of the 11th International Conference on Distributed Smart Cameras (ICDSC 2017)*. ACM, New York, NY, USA, 107–112.
- [23] Lukas Esterle, Peter R. Lewis, Xin Yao, and Bernhard Rinner. 2014. Socio-Economic Vision Graph Generation and Handover in Distributed Smart Camera Networks. *ACM Transactions on Sensor Networks* 10, 2 (2014), 1–24.
- [24] Chuanchao Gao, Heejong Park, and Arvind Easwaran. 2021. An Anomaly Detection Framework for Digital Twin Driven Cyber-Physical Systems. In *Proceedings of the ACM/IEEE 12th International Conference on Cyber-Physical Systems (ICCPs '21)*. ACM, New York, NY, USA, 44–54.
- [25] Adam Ghandar, Ayyaz Ahmed, Shahid Zulfiqar, Zhengchang Hua, Masatoshi Hanai, and Georgios Theodoropoulos. 2021. A Decision Support System for Urban Agriculture Using Digital Twin: A Case Study With Aquaponics. *IEEE Access* 9 (2021), 35691–35708.
- [26] C. Lee Giles, Christian W. Omlin, and Karvel K. Thornber. 1999. Equivalence in Knowledge Representation: Automata, Recurrent Neural Networks, and Dynamical Fuzzy Systems. *Proc. IEEE* 87, 9 (1999), 1623–1640.
- [27] Sven Gronauer and Klaus Diepold. 2022. Multi-agent deep reinforcement learning: a survey. *Artificial Intelligence Review* 55, 2 (Feb. 2022), 895–943.
- [28] Britton Hammit, Rachel James, and Mohamed Ahmed. 2018. A Case for Online Traffic Simulation: Systematic Procedure to Calibrate Car-Following Models Using Vehicle Data. In *2018 21st International Conference on Intelligent Transportation Systems (ITSC)*. IEEE Press, Maui, HI, USA, 3785–3790.
- [29] Hossein Hashemi, Khaled F. Abdelghany, and Ahmed F. Abdelghany. 2017. A Multi-Agent Learning Approach for Online Calibration and Consistency Checking of Real-Time Traffic Network Management Systems. *Transportmetrica B: Transport Dynamics* 5, 3 (July 2017), 364–384.
- [30] Dwayne Henclewood, Wonho Suh, Michael Rodgers, Michael Hunter, and Richard Fujimoto. 2012. A Case for Real-Time Calibration of Data-Driven Microscopic Traffic Simulation Tools. In *Proceedings of the 2012 Winter Simulation Conference (WSC)*. IEEE Press, Berlin, Germany, 1–12.
- [31] Pengyi Jia, Xianbin Wang, and Xuemin Shen. 2021. Digital-Twin-Enabled Intelligent Distributed Clock Synchronization in Industrial IoT Systems. *IEEE Internet of Things Journal* 8, 6 (2021), 4548–4559.
- [32] David Jones, Chris Snider, Aydin Nassehi, Jason Yon, and Ben Hicks. 2020. Characterising the Digital Twin: A Systematic Literature Review. *CIRP Journal of Manufacturing Science and Technology* 29 (2020), 36–52.
- [33] Michael G. Kapteyn, Jacob V. R. Pretorius, and Karen E. Willcox. 2021. A Probabilistic Graphical Model Foundation for Enabling Predictive Digital Twins at Scale. *Nature Computational Science* 1, 5 (May 2021), 337–347.
- [34] Catriona Kennedy and Georgios Theodoropoulos. 2006. Intelligent Management of Data Driven Simulations to Support Model Building in the Social Sciences. In *Computational Science – ICCS 2006*. Springer Berlin Heidelberg, Berlin, Heidelberg, 562–569.
- [35] Catriona Kennedy, Georgios Theodoropoulos, Volker Sorge, Edward Ferrari, Peter Lee, and Chris Skelcher. 2007. AIMSS: An Architecture for Data Driven Simulations in the Social Sciences. In *Computational Science – ICCS 2007 (Lecture Notes in Computer Science)*. Springer, Berlin, Heidelberg, 1098–1105.
- [36] Catriona Kennedy, Georgios Theodoropoulos, Volker Sorge, Edward Ferrari, Peter Lee, and Chris Skelcher. 2011. Data Driven Simulation to Support Model Building in the Social Sciences. *Journal of Algorithms & Computational Technology* 5, 4 (2011), 561–581.
- [37] B Korth, C Schwede, and M Zajac. 2018. Simulation-Ready Digital Twin for Realtime Management of Logistics Systems. In *2018 IEEE International Conference on Big Data (Big Data)*. IEEE Press, Seattle, WA, USA, 4194–4201.
- [38] Michael Lees, Brian Logan, Rob Minson, Ton Oguara, and Georgios Theodoropoulos. 2005. Modelling Environments for Distributed Simulation. In *Environments for Multi-Agent Systems*, Danny Weyns, H. Van Dyke Parunak, and Fabien Michel (Eds.). Springer Berlin Heidelberg, Berlin, Heidelberg, 150–167.

- [39] Peter R. Lewis, Arjun Chandra, Funmilade Faniyi, Kyrre Glette, Tao Chen, Rami Bahsoon, Jim Torresen, and Xin Yao. 2015. Architectural Aspects of Self-Aware and Self-Expressive Computing Systems: From Psychology to Engineering. *Computer* 48, 8 (8 2015), 62–70.
- [40] Fabien Michel, Jacques Ferber, and Alexis Drogoul. 2009. Multi-Agent Systems and Simulation: A Survey from the Agent Community's Perspective. In *Multi-Agent Systems: Simulation and Applications*, Adeline M. Uhrmacher and Danny Weyns (Eds.). CRC Press, Boca Raton, FL, USA, 3–51.
- [41] Roberto Minerva, Gyu Myoung Lee, and Noel Crespi. 2020. Digital Twin in the IoT Context: A Survey on Technical Features, Scenarios, and Architectural Models. *Proc. IEEE* 108, 10 (2020), 1785–1824.
- [42] Htet Naing, Wentong Cai, Nan Hu, Tiantian Wu, and Liang Yu. 2021. Data-Driven Microscopic Traffic Modelling and Simulation Using Dynamic LSTM. In *Proceedings of the 2021 ACM SIGSIM Conference on Principles of Advanced Discrete Simulation*. ACM, New York, NY, USA, 1–12.
- [43] Michael J North, Nicholson T Collier, Jonathan Ozik, Eric R Tataru, Charles M Macal, Mark Bragen, and Pam Sydelko. 2013. Complex Adaptive Systems Modeling with Repast Simphony. *Complex Adaptive Systems Modeling* 1, 1 (2013), 3.
- [44] Vasileia Papathanasopoulou, Ioulia Markou, and Constantinos Antoniou. 2016. Online Calibration for Microscopic Traffic simulation and Dynamic Multi-Step Prediction of Traffic Speed. *Transportation Research Part C: Emerging Technologies* 68 (July 2016), 144–159.
- [45] Luis F Rivera, Hausi A Müller, Norha M Villegas, Gabriel Tamura, and Miguel Jiménez. 2020. On the Engineering of IoT-Intensive Digital Twin Software Systems. In *Proceedings of the IEEE/ACM 42nd International Conference on Software Engineering Workshops (ICSEW'20)*. ACM, New York, NY, USA, 631–638.
- [46] Stuart Russell and Peter Norvig. 2009. *Artificial Intelligence: A Modern Approach* (3rd ed.). Prentice Hall Press, USA.
- [47] Robert G. Sargent. 2010. Verification and Validation of Simulation Models. In *Proceedings of the 2010 Winter Simulation Conference*. IEEE Press, Baltimore, MD, USA, 166–183.
- [48] Rahul Sharma, Eric Schkufza, Berkeley Churchill, and Alex Aiken. 2013. Data-Driven Equivalence Checking. In *Proceedings of the 2013 ACM SIGPLAN International Conference on Object Oriented Programming Systems Languages & Applications (OOPSLA '13)*. ACM, Indianapolis, Indiana, USA, 391–406.
- [49] Vinoth Suryanarayanan and Georgios Theodoropoulos. 2013. Synchronised Range Queries in Distributed Simulations of Multiagent Systems. *ACM Trans. Model. Comput. Simul.* 23, 4, Article 25 (Nov 2013), 25 pages.
- [50] US Department of Defense. 2009. *DoD Modeling and Simulation (M&S) Verification, Validation, and Accreditation (VV&A): DoD Instruction 5000.61*. Technical Report. US Department of Defense.
- [51] A.J. van der Schaft. 2004. Equivalence of Dynamical Systems by Bisimulation. *IEEE Trans. Automat. Control* 49, 12 (Dec 2004), 2160–2172.
- [52] Chi-Hsu Wang and Jung-Sheng Wen. 2008. On the Equivalence of a Table Lookup (TL) Technique and Fuzzy Neural Network (FNN) With Block Pulse Membership Functions (BPMFs) and Its Application to Water Injection Control of an Automobile. *IEEE Transactions on Systems, Man, and Cybernetics, Part C (Applications and Reviews)* 38, 4 (July 2008), 574–580.
- [53] Yuepeng Wang, Isil Dillig, Shuvendu K. Lahiri, and William R. Cook. 2018. Verifying Equivalence of Database-Driven Applications. *Proceedings of the ACM on Programming Languages* 2, POPL (1 2018), 1–29.
- [54] Danny Weyns, Bradley Schmerl, Vincenzo Grassi, Sam Malek, Raffaella Mirandola, Christian Prehofer, Jochen Wuttke, Jesper Andersson, Holger Giese, and Karl M Göschka. 2013. On Patterns for Decentralized Control in Self-Adaptive Systems. In *Software Engineering for Self-Adaptive Systems II: International Seminar, Dagstuhl Castle, Germany, October 24–29, 2010 Revised Selected and Invited Papers*. Springer Berlin Heidelberg, Berlin, Heidelberg, 76–107.
- [55] Lyndon While, Phil Hingston, Luigi Barone, and Simon Huband. 2006. A Faster Algorithm for Calculating Hypervolume. *IEEE Transactions on Evolutionary Computation* 10, 1 (2006), 29–38.
- [56] Michael Wooldridge and Nicholas R. Jennings. 1995. Intelligent Agents: Theory and Practice. *The Knowledge Engineering Review* 10, 2 (1995), 115–152.
- [57] Nan Zhang, Rami Bahsoon, and Georgios Theodoropoulos. 2020. Towards Engineering Cognitive Digital Twins with Self-Awareness. In *2020 IEEE International Conference on Systems, Man, and Cybernetics (SMC)*. IEEE, Toronto, ON, Canada, 3891–3891.
- [58] Q.K. Zhu. 2008. Logic Equivalence Check in SOC Design: Solution and Issues. In *IET Conference Proceedings*. Institution of Engineering and Technology, Beijing, China, 623–626(3).
- [59] H Zipper and C Diedrich. 2019. Synchronization of Industrial Plant and Digital Twin. In *2019 24th IEEE International Conference on Emerging Technologies and Factory Automation (ETFA)*. IEEE Press, Zaragoza, Spain, 1678–1681.

A AGENT BEHAVIOUR IN THE MOTIVATING EXAMPLE

Algorithm 5: Drone Agent Behaviour**Data:** Knowledge of interaction *graph*, drone sensing range *range*, list of all received messages *msgList*,

```

1 for every time step do
  /* SENSE */
2  objList ← sense all objects within range;
3  imptObjList ← filter important objects from objList;
4  msgList.append(messages received at previous time step);
5  Clear outdated messages in msgList;
  /* THINK and ACT */
6  if limptObjList.isEmpty() then
7    obj ← randomly select from imptObjList;
8    if !obj.isKCovered() then
9      // notify
10     notifiedDrones ← the top ( $k - 1$ ) drones ranked by the strengths of their links with this drone,
11     which are recorded as the edge weights in graph;
12     foreach drone ∈ notifiedDrones do
13       | Send message to drone;
14     end
15     // follow
16     Move towards obj by 1 unit;
17   else if !msgList.isEmpty() then
18     // respond-and-follow
19     Sort messages in msgList in descending order first by the weight of edge between the sender drone and
20     this drone, then by the receiving time;
21     msg ← the message at the highest rank after sorting;
22     obj ← the object advertised in msg;
23     Move towards obj by 2 unit;
24   else // random walk
25     | Move towards a random angle by 5 units;
26   end
27   /* UPDATE KNOWLEDGE */
28   foreach edge ∈ graph.allEdges do
29     | edge.weight ←  $\gamma \cdot edge.weight$ ;
30   end
31   foreach obj ∈ ObjList do
32     foreach d ∈ all surrounding drones do
33       if d.isCovering(obj) then
34         | edge ← the graph edge between drone d and this drone;
35         | edge.weight ← edge.weight +  $\delta$ ;
36       end
37     end
38   end
39 end

```
