

Econometric Modeling of Intraday Electricity Market Price with Inadequate Historical Data

Saeed Mohammadi¹ and Mohammad Reza Hesamzadeh¹, School of Electrical and Computer Engineering, KTH Royal Institute of Technology, Stockholm, Sweden, {saeedmoh, mrhesamzadeh}@kth.se

Abstract—The intraday (ID) electricity market has received an increasing attention in the recent EU electricity-market discussions. This is partly because the uncertainty in the underlying power system is growing and the ID market provides an adjustment platform to deal with such uncertainties. Hence, market participants need a proper ID market price model to optimally adjust their positions by trading in the market. Inadequate historical data for ID market price makes it more challenging to model. This paper proposes long short-term memory, deep convolutional generative adversarial networks, and No-U-Turn sampler algorithms to model ID market prices. Our proposed econometric ID market price models are applied to the Nordic ID price data and their promising performance are illustrated.

Index Terms—Deep convolutional generative adversarial networks, intraday electricity market, intraday price modeling, long short term memory, No-U-Turn sampler.

I. INTRODUCTION

PURCHASING electricity for a specific bidding zone involves a considerable risk due to the price risk. One delicate arrangement is to go to a forward market, e.g. financial transmission right (FTR) or day-ahead (DA) market, and buy a forward contract [1]. Then we would be able to guard ourselves against this risk with an option/binding contract for a specific delivery time. Although wholesale electricity markets operate as a multi-settlement system (i.e. DA and intraday (ID) electricity markets), the DA markets conventionally lead providing economic dispatch. To facilitate integration of renewable energy resources in these multi-settlement systems, ID markets play a significant role in delivering electricity by offering the opportunity to trade power shortly before the start of delivery time. DA prices and renewable energy generation are not continually coherent due to lack of flexibility in DA markets. Therefore, liquid ID markets, energy storage systems, and demand flexibility are beneficial to avoid price peaks. This requires a reliable price modeling for these multi-settlement systems which is the main focus of this paper.

A. Motivation

The ID market plays an increasing role in handling the power system uncertainties and accordingly facilitating integration of renewable energy resources. The ID market provides an adjustment platform to trade power shortly before start of the delivery time and hence liquid ID markets are beneficial to avoid real-time price spikes. Still, optimal trading in the ID market requires a proper ID market price modeling.

This work was financially supported by the Swedish Energy Agency (Energimyndigheten) under Grant 3233. The required computation is performed by computing resources from the Swedish National Infrastructure for Computing (SNIC) at PDC center for high performance computing at KTH Royal Institute of Technology which was supported by the Swedish Research Council under Grant 2018-05973. (Corresponding author: Saeed Mohammadi.)

To deal with the liquidity and trading risks, we need to deal with the existing and growing uncertainties in the electricity markets. Uncertainty in ID markets are caused by several factors such as changes in regulations, higher trading risk, volume-dependent prices, and etc. Compared to DA market prices, ID market prices are often more volatile. This variation is very clear by looking into historical data, e.g., it is shown for 2020-12-14 in Fig. 1 (up). Intraday prices vary in the presented ranges for minimum and maximum prices. For instance, average ID market price at 3 pm is 43.67EUR which alters between 39.12EUR (-10.4%) and 57.40EUR (23.9%) in just one hour, i.e. 18.28EUR (41.8%) variation in one hour. In addition, these changes are not similar in different periods of time. ID market price variation is shown in Fig. 1 (down) for 2015 to 2021 which is higher in recent years. The ID market price variation calculated using the following equation can go up to 200%.

$$\text{ID market price variation} = \frac{\text{Max. price} - \text{Min. price}}{\text{Avg. price}} \times 100$$

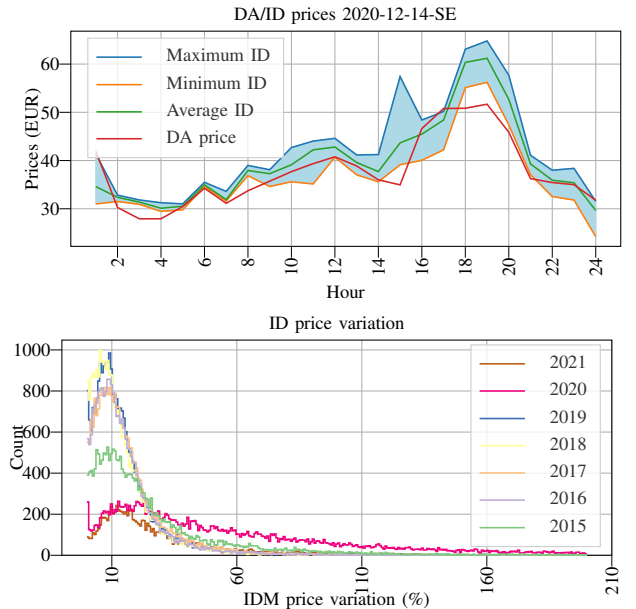

Fig. 1. The DA and ID market prices in 2020-12-14 (up) and ID market price variation (down). Data source: [2] Sweden is divided into four bidding zones i.e. SE1-SE4. Sometimes, prices in these bidding zones are the same. To study this, percentage of time steps when the prices are the same in entire Sweden is shown in Table I for 2015 to 2021. For instance, in 2019, DA market prices in 78.77% of the time (6826 data points) prices in four bidding zones of Sweden are the same, while this is 5.3% (459 data points) in ID average prices. Therefore, ID prices change more in different bidding zones. Overtime, from 2015 to 2020, this percentage

is decreased in DA market and increased in ID market. This shows the growing importance of modeling ID prices in recent years.

TABLE I
PERCENTAGE OF SIMILAR PRICES IN SWEDEN

DA	High	Low	Last	Avg	Year
85.81	2.98	2.82	3.66	1.21	2015
92.94	2.18	2.24	3.36	0.58	2016
85.45	2.67	2.84	3.63	1.82	2017
81.99	1.72	1.62	3.04	1.14	2018
78.77	5.69	5.70	5.84	5.3	2019
47.66	15.22	15.11	14.89	14.77	2020
60.26	0.32	0.16	0.16	0.00	2021

Also there is a strong correlation between prices in DA and ID markets, the ID market prices may vary significantly. For instance, in 2020-03-28 in bidding zone SE2, DA prices are almost constant while the ID prices vary from -10 to 20 EUR/MWh as shown in Fig. 2.

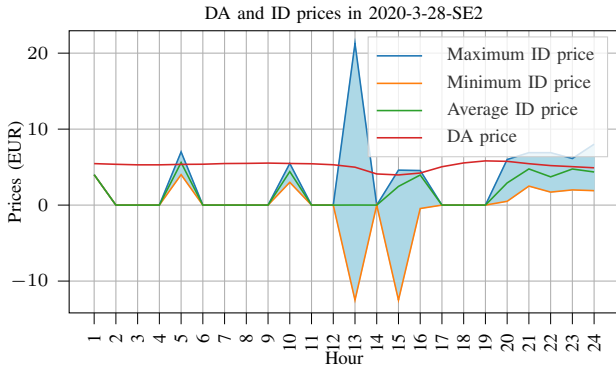

Fig. 2. Compare DA and ID prices

Also international ID markets are established from 1999 [3], launching several new projects lead to more changes in market regulations. For instance, European Cross-Border Intraday (XBID) and European Single Intraday Coupling (SIDC) solution (from 2018) and Local Implementation Projects are implemented in 2018 and expanded in 2019 [4]. As expected, dynamics of the market changes when new regulations or new projects are implemented. Therefore, there is a continuous lack of sufficient data to implement uncertainties in ID markets. We address this by proposing three approaches to model multi-settlement prices (i.e. DA and ID prices).

Schematic of DA and ID electricity markets, in Nord Pool electricity exchange, [2] is shown in Fig. 3. DA market operates as an auction which opens at 08:00 the day before the delivery. Available capacities for DA market are published at 10:00 and the auction is closed at 12:00. Then the DA market is cleared and prices are announced at 12:42. On the other hand, ID market is a continuous pay as bid market which is always open for new bids. Capacities for the new day are published at 14:00 the day before the delivery. Market participants have up to one hour before the time of delivery to use ID market for that specific time of delivery. ID markets are continuously open for bids. Therefore, market participants can use announced prices at 12:42 in D-1 (the day before delivery)

and published capacities at 14:00 in D-1 to bid in the market to maximize their profits.

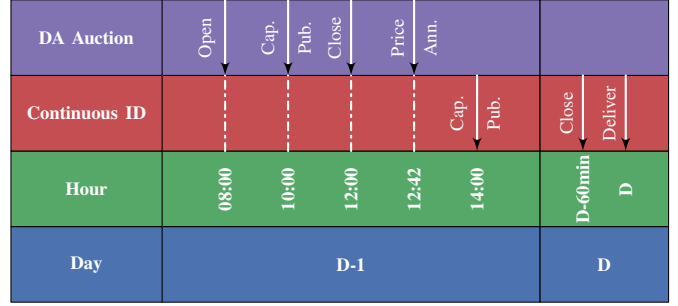

Fig. 3. Schematic of DA and ID electricity markets

B. Background Research

Studies on price modeling and scenario generation are reviewed in this section. Scenario-generation methods can be categorized under price modeling approaches where different scenarios are considered for uncertain parameters which is widely used in literature for stochastic programming, i.e. [5] and [6] and [7] and [8]. Scenario generation algorithms can be divided into two general categories: (1) Fitting/training a model: These algorithms aim to fit/train a model to the available historical data for the uncertain parameter. Then, these models are used to generate scenarios. These models mostly look at each single data point independently. Some of the literatures in this category are [9]–[11], [11], [12]. This category is also known as data-driven based scenario generation [9] in literature. (2) Probabilistic scenario generation: These algorithms aim to generate scenarios based on predicting probability distribution function (PDF). Later, the predicted PDF is used to generate scenarios for the uncertain parameters. Some of the literatures in this category are [9], [13]–[17]. This category is also known as statistical-based scenario generation [9] in literature. Literature on price modeling are reviewed in Table II. Recent scenario generation methods are reviewed in more details in papers such as [18], [19].

TABLE II
LITERATURE ON PRICE MODELING APPROACHES

Reference	Method	Application	Model	Drawbacks
[5]	MMSG	portfolio management	ST	more than 1000 scenarios required
[6]	Probabilistic	Wind power	ECDF, IT	Employ wind power forecast
[7]	Regression	Performance management	SLR	limited forecasting capability
[8]	Spatiotemporal	Road network traffic flow	LSTM, GANs	hyper tuning parameter
[20]	Spatiotemporal	Wind and solar generation	GANs	hyper tuning parameter

ECDF: empirical cumulative distribution function, GANs: generative adversarial networks, IT: inverse transform, LSTM: long short term memory, MMSG: moment-matching scenario-generation, SLR: simple linear regression, ST: Scenario tree,

C. Contributions

ID markets are facing structural changes and lack of insufficient data as explained in Section I-A which are addressed in this paper. In particular, we propose *long short term memory (LSTM)*, *deep convolutional generative adversarial networks (DCGAN)*, and *No-U-Turn sampler (NUTS)* algorithms to model ID market price. The main contributions of this paper are the followings: (1) We have explored the DA and ID market data. We have looked into effect of time, area, and bidding zone, and volume on behavior of these markets. (2) We have considered time series of the ID market prices. Then, we employed an LSTM-based algorithm to model the ID prices by generating different scenarios based on the latest update in the time series which is effective in capturing temporal dynamics. Advantage of this algorithm is to generate time series for prices similar to the actual data which makes it more suitable for the system operation. (3) In the second approach, we consider the ID prices as unknown functions (e.g. black boxes) with 24 inputs (one for each hour). Then, we look at the available information for each time step as inputs. In the DCGANs-based approach, we develop an ID price model based on this assumption. Advantage of this approach is to generate prices without fitting a PDF to the historical data, e.g. without knowledge about the probabilistic features. As a result, the prices are able to directly adapt to the changes in the market. (4) In the third approach, e.g. NUTS-based algorithm, the ID market prices are considered as unknown random numbers. Then, we converge to a target PDF for these prices. Then, we can sample from the PDF for further market studies. Advantage of this algorithm is to generate prices with more similar PDFs by fitting a PDF to the actual data which is required in more long-term studies. In this paper, ID prices are modeled with each approach and results are compared.

II. THE PROPOSED ID PRICE MODELS

The proposed approaches for ID price modeling are explained in this section.

A. Long Short Term Memory (LSTM) based model

Recurrent neural networks always suffered with vanishing gradient which cause different inputs to have high/low influence on the calculated gradient when we are training these networks. LSTM networks are introduced in 1997 in [21] with the aim of solving this problem. Advantages of LSTM networks are long duration memory (capable of learning long-term dependencies) and a state vector which is separate from output. As discussed before, ID market prices have both short and long term dependencies. Therefore, LSTM networks are suitable for modeling ID market prices.

Schematic of an LSTM network cell is shown in Fig. 4. Initial idea is to determine results from both the current input x_t and previous output y_{t-1} using hyperbolic tangent as activation function $\tanh(Wx_t + Vy_{t-1})$. Then the current output is established by three switches SW1 to SW3. W^I and V^I determine whether or not we consider the effect of the input and the previous output of the network y_{t-1} which applied by SW1. Similarly, W^S and V^S determine whether to skip the previous state of the network s_{t-1} or keep looking at the previous state which is applied by SW2. The ability to skip

the previous state is the main advantage of LSTM networks. Finally, W^O and V^O decide which parts of the current state are going to the output y_t .

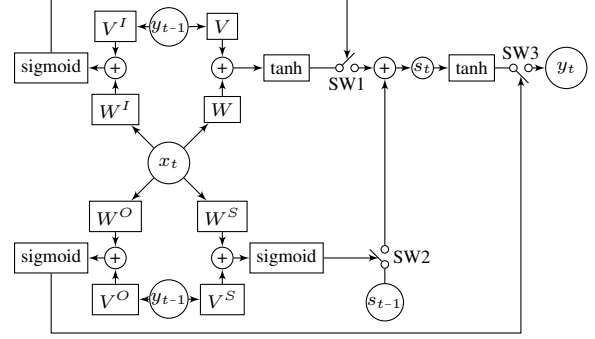

Fig. 4. Schematic of an LSTM network cell

This LSTM network cell is formulated in (1). \circ is Hadamard product or element-wise product of two matrices. Output y_t and current state s_t are calculated in (1a) and (1b), respectively. The weight parameters W , W^I , W^O , W^S , V , V^I , V^O , and V^S are tuned during training of this network. We are looking to minimize $MSE = E(y_t - \hat{y}_t)^T (y_t - \hat{y}_t)$ when the constraints in (1) hold. It is a nonlinear problem but it is possible to find local optimal values for the weights using the back propagation algorithm [22].

$$y_t = \text{sigmoid}(W^O y_{t-1} + V^O x_t + b_t^O) \circ \tanh(s_t) \quad (1a)$$

$$s_t = \text{sigmoid}(W^S y_{t-1} + V^S x_t + b_t^S) \circ s_{t-1} + \text{sigmoid}(W^I y_{t-1} + V^I x_t + b_t^I) \circ \tanh(W y_{t-1} + V x_t + b_t) \quad (1b)$$

B. Deep Convolutional Generative Adversarial Networks (DCGANs) based model

Generative adversarial networks (GANs) are a kind of generative models based on game theory which introduced in [23] as a two-model system (generator and discriminator). Each model performs a contradictory but accompanying tasks. In [23], simple multi-layer perceptrons are employed to model the generator and discriminator. Later deep convolutional generative adversarial networks (DCGANs) are introduced in [24] where CNNs are employed for both the generator and discriminator models.

Generative modeling problems aim to learn the PDF which generates a training data set. Later, the estimated PDFs are employed to generate more data [25]. GANs are one of the most outstanding generative models which is based on game theory. This game is between two models (generator G and discriminator D) which play a mini-max game where players minimize their loss for the worst cases.

Schematic of the DCGANs network is shown in Fig 5. The generator network G provides \hat{x} for a given latent variable vector l . Objective of the generator is to produce \hat{x} very much alike x . To reach this objective, parameters in the network model N^G are adjusted during training when a noise with normal distribution is given as the latent l . The discriminator network D provides an output y which is one for real data ($N^D(x) = 1$) and zero for generated data ($N^D(N^G(l)) = 0$). Objective of the discriminator is to distinguish real inputs x

from generated inputs \hat{x} . To reach this objective, parameters in the network model N^D are adjusted during training for given output of the generator network.

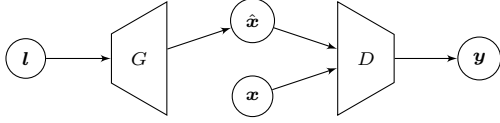

Fig. 5. Schematic of the DCGANs-based model

Training problem of the DCGANs-based model is formulated in (2). In the global optimal point, $N^D(x) = 1$ and $N^D(N^G(l)) = 0$ which leads to $\log N^D(x) = 0$ and $\log(1 - N^D(N^G(l))) = 0$. The objective is always negative except in the global optimal point where it is zero. The discriminator tries to maximize the objective by detecting all generated data from real data. While the generator tries to minimize the objective by generating \hat{x} in such a way that it is not possible to identify by the discriminator network.

$$\underset{N^G}{\text{Minimize}} \underset{N^D}{\text{Maximize}} E_x[\log N^D(x)] + E_l[\log(1 - N^D(N^G(l)))] \quad (2)$$

C. No-U-Turn Sampler (NUTS) -based model

In this approach, we fit a distribution function to the real data. Therefore, we need to know overall structure of PDF of the real data from historical data which is available in ID price modeling. Then, we need to find parameters of the target PDF which will be used to take samples from. When we can not have direct samples or we do not have enough direct samples (i.e. ID market prices), this approach is especially useful. Markov Chain Monte Carlo (MCMC) method can be employed to obtain a sequence of samples from the target PDF [26]. Hamiltonian Monte Carlo (HMC) algorithm is an MCMC method with the advantage to avoid the random-walk behavior of MCMC and to rely less on the correlated variables [27]. HMC is responsive to proper tuning of step-size and number of steps [28]. Recently, NUTS algorithm is introduced which improves the HMC algorithm by finding the step-size and number of steps internally [29].

III. EXPLORING THE MARKETS

DA and ID prices are explored in this section. We look at the effect of time in long-term and short-term periods. Then, we investigate the effect of area, bidding zones, and volume.

A. Long-time period

To study effect of long-time periods on the markets, we look at ID and DA prices in different years in Fig. 6. Mostly distribution of these markets are similar. But, difference between these distributions is higher in 2015, 2020, and 2021 compared to other years.

B. Short-time period

To study effect of short-time periods on ID prices, we look at the average ID prices in different months from 2018 to 2021 in Fig. 7. Distribution of the prices are significantly changed at each year. For instance, prices in July were about 45, 30, and 15 EUR/MWh in 2018, 2019, and 2020 respectively.

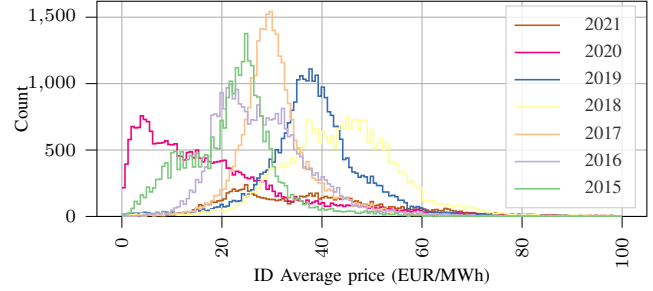
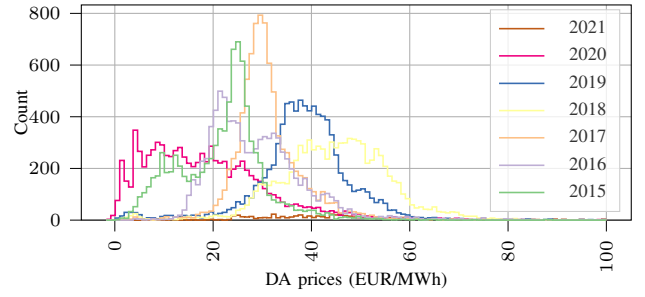

Fig. 6. ID and DA market average prices from 2015 to 2021 in Sweden

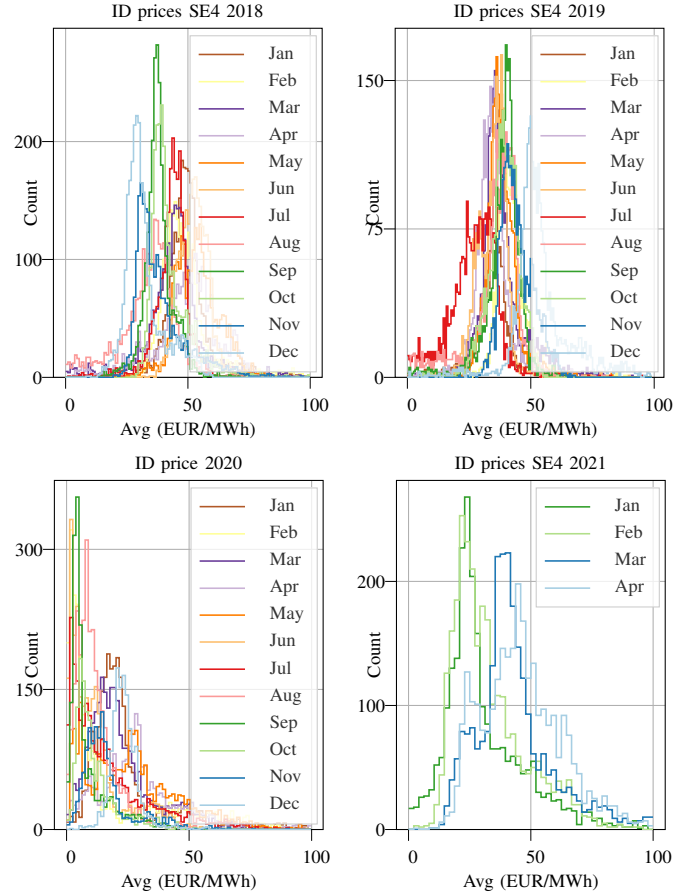

Fig. 7. ID average prices in different months from 2018 to 2021

C. Area

Sweden is divided into four area SE1 to SE4. Here effect of location is studied for both DA and ID electricity markets. Average DA market prices (EUR/MWh) are shown in Fig. 8

(left) in SE1 to SE4 in Sweden. Distribution of the prices are mainly similar in Sweden DA market. Average ID market prices (EUR/MWh) are shown in Fig. 8 (right) in SE1 to SE4 in Sweden. Distribution of the prices is different in SE4 where prices are higher compared to other three zones. Therefore, prices in ID electricity market depend more on the location compared to the DA electricity markets.

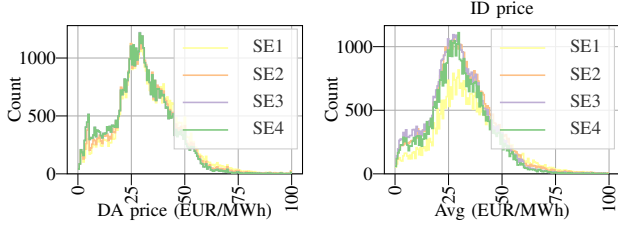

Fig. 8. DA (left) and ID (right) price (EUR/MWh) in four bidding zones of Sweden (EUR/MWh)

D. Bidding zones

Here we look at four zones of Sweden (SE1 to SE4) and variation of ID prices. In Fig. 9, variation of ID prices is shown for SE1 to SE4 from 2015 to 2021. ID market prices were similar in different zones from 2015 to 2018. While, distribution of these prices vary in different zones in later years (2019 to 2021).

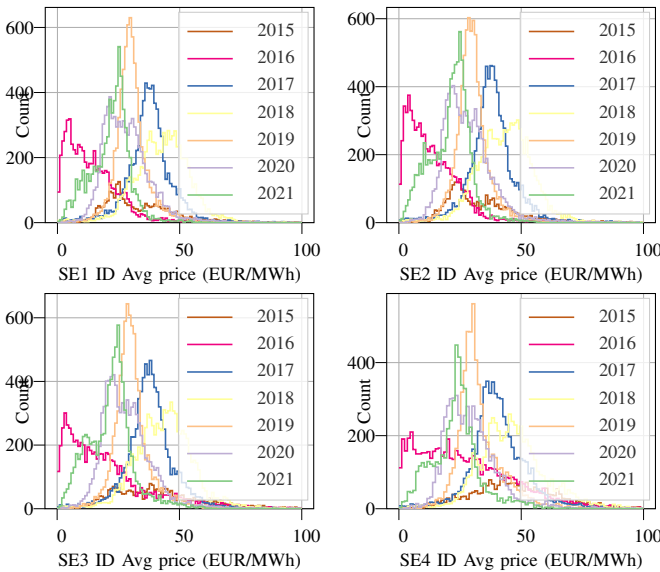

Fig. 9. ID average price in SE1 to SE4 in Sweden from 2015 to 2021

E. Volume

Up to now, we have focused on the market prices. We have looked dynamics of volume in ID market in Fig. 10 in four regions of Sweden which are between 0 and 400 (volumes=0 is removed from this figure). It is shown that transactions with smaller volume are popular in this market. Volumes less than 50MW are more common in SE4. That could be due to better connection to the rest of Europe in this region. On the other hand, volumes more than 200MW

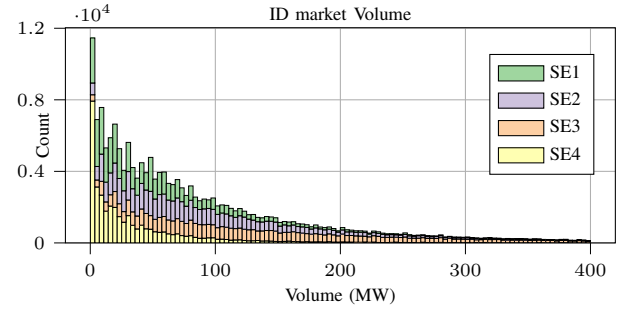

Fig. 10. ID market volumes in four regions of Sweden ($0 < \text{volume} < 400\text{MW}$)

are more more common in SE3 which can be a result of connection to Norway.

Summation of volumes in DA and ID markets are compared in Table III from 2021-04-24 to 2021-05-24. ID market volumes are between 1.9% to 6.6% of volumes in DA market in the same time period.

TABLE III
BUY AND SELL VOLUMES IN DA AND ID ELECTRICITY MARKETS FROM 2021-04-24 TO 2021-05-24

Zone	Type	DA volume (MW)	ID volume (MW)	ID volume (%)
SE1	Buy	865 237.5	18 832.4	2.2
SE1	Sell	2 086 117.5	40 491.2	1.9
SE2	Buy	915 577.1	60 801.5	6.6
SE2	Sell	3 403 113.4	81 473.3	2.4
SE3	Buy	5 638 029.1	72 795.2	1.3
SE3	Sell	4 570 174.9	66 343.0	1.5
SE4	Buy	1 578 820.0	35 793.1	2.3
SE4	Sell	280 141.5	11 692.8	4.2

IV. RESULTS

Our proposed algorithms have been applied to the recent ID market data. Here we are looking at more recent data (i.e. 2020 and 2021).

A. Long Short Term Memory (LSTM)

PDF of the ID average prices are shown in Fig. 11 for the LSTM-based approach. Here the market data for 2020 and 2021 are employed for training and testing of the LSTM network respectively. In this approach, we look at the previous ID average prices as input and develop a model to generate prices for the next time step. The LSTM-based model is trained first with the training data (2020). Then, we generate prices for the test data (2021). PDF of the actual ID average prices and PDF of the generated ID average prices are shown in Fig. 11 which shows proper performance of the LSTM-based model in generating prices with similar PDFs.

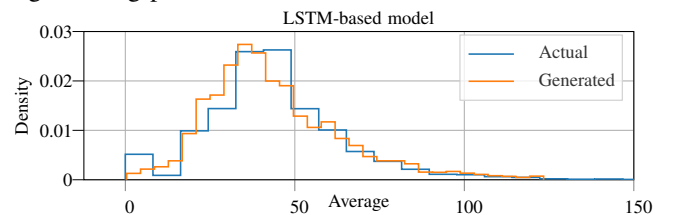

Fig. 11. PDF of average ID prices (EUR/MWh) in LSTM-based approach

Generated ID market average prices employing the LSTM-based approach are shown in Fig. 12 for 2021-01-13. Profile the generated prices follow the real prices in the 24 hour example. The main advantage of the LSTM-based approach is good performance of this approach in generating similar profile of prices. Training the proposed LSTM-based model is an iterative approach. Fig. 13 shows mean square error (MSE) for both training and test data for 500 iterations. Both errors are in their minimum after 200 iterations.

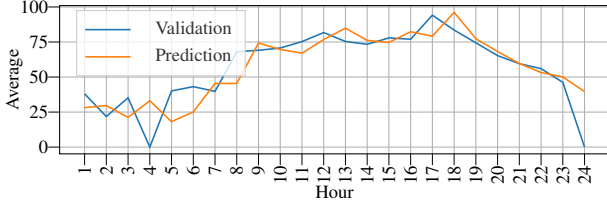

Fig. 12. Generated ID market average prices (EUR/MWh) in the LSTM-based approach for 2021-01-13

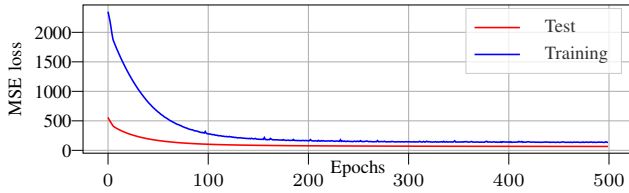

Fig. 13. MSE loss in LSTM-based approach for training and testing data of average ID prices

B. Deep Convolutional Generative Adversarial Networks (DCGANs)

PDF of the ID average prices are shown in Fig. 14 for the DCGANs-based approach. Similarly, the market data for 2020 and 2021 are employed for training and testing, respectively. This approach does not perform well in generating negative prices. Statistics of generated ID average prices and the actual data are compared in Table IV. Generated prices in the DCGANs-based approach have similar minimum, maximum, mean, and median (50% percentile) compared to the actual data. Therefore, this approach is doing well in terms of statistic measures.

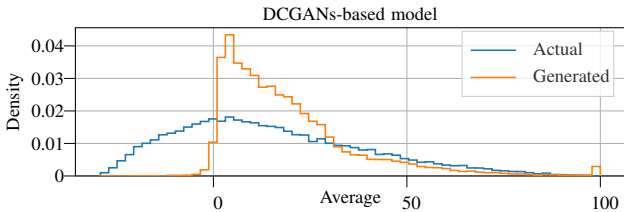

Fig. 14. PDF of average ID prices (EUR/MWh) in DCGANs-based approach

C. No-U-Turn Sampler (NUTS)

PDF of the ID average prices are shown in Fig. 15 for the NUTS-based approach. This figure shows very good performance this approach in generating samples with the similar PDF as actual prices. Which is significantly better than the DCGANs approach.

TABLE IV
STATISTIC SUMMARY OF AVERAGE ID PRICES IN DCGANs-BASED APPROACH

Statistic	Actual	Generated
mean	15.33	15.08
standard deviation	17.37	24.26
minimum	-29.21	-29.21
25%	1.83	-3.30
50%	10.31	11.34
75%	22.50	30.25
maximum	100.00	100.00

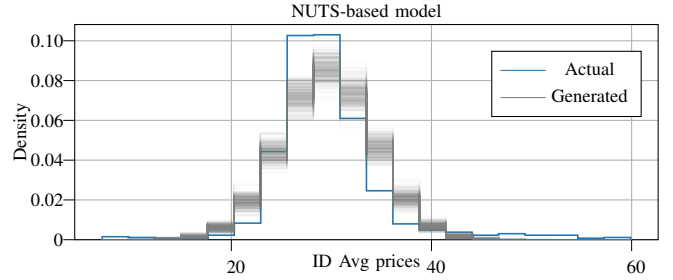

Fig. 15. PDF of ID average price (EUR/MWh) for observed data (actual) and posterior predictive distributions (generated) in NUTS approach

All of the proposed approaches in this paper are practical depending on the type of study and its context. For instance, in operational and short-term studies of power system with right amount of data, the LSTM-based approach is the best choice, as shown in Section II-A and Section IV-A. On other hand, for more long-term studies with right amount of data, the DCGANs-based approach is a good choice as shown in Section II-B and Section IV-B. Finally, for studies with limited access to data, the NUTS-based approach is the best choice as shown in Section II-C and Section IV-C. Therefore, we suggest to the market participants to implement different ID price models. Then, depending on changes in the ID market regulations, choose the most precise model. For instance, after each changes in the market regulations, DCGANs-based and NUTS-based models are more accurate. Gradually more historical data is available with the updated regulations and the market participants may use the LSTM-based model. In addition, the market participants should always be updated with the upcoming changes in the market regulations.

D. Implementation

LSTM and DCGANs algorithms are implemented in Keras [30] with backend of Tensorflow [31]. NUTS algorithm is implemented in PyMC3 [32]. Source ID market data source is Nord Pool [2].

V. CONCLUSION

Uncertainties in electricity markets, e.g. Day-ahead (DA) and intraday (ID) markets, are increasing and they are continuously changing by introducing new regulations. In this paper, we have explored DA and ID markets by looking at the historical data and studied effect of time, area, bidding zones, and volume. It showed excessive and expanding importance of ID market price modeling. With the constant ID market changes, less historical data are available with the current ID market

regulations. Therefore, a good price model for ID markets is crucial for the market participants. In the literature, there are not many practical models for electricity market price modeling, e.g. DA market price with sufficient data. We have proposed three approaches for price modeling based on long short term memory, deep convolutional generative adversarial networks, and No-U-Turn sampler which are all for ID market price modeling. To the best of our knowledge, this paper is the first in proposing several practical models for ID price modeling which is specially essential for ID markets. Finding the best approach depends on the participants theoretical knowledge about the distribution function of ID prices, their access to accurate and up-to-date data, and how valuable precise price is for the consumers. Our reflection is that the market participants need to employ a combination of the proposed price models and make operational decisions based on their context and the changes in the electricity markets.

VI. NOMENCLATURE

NOMENCLATURE

Indices

$t \in \mathbb{T}$ Time index;

Operators and functions

N^G, N^D Network model for generator and discriminator in DCGANs algorithm;

$E(\cdot)$ Expected value of (\cdot) ;

\circ Hadamard product of two matrices;

Parameters (upper-case)

W/V Weights in LSTM algorithm;

W^I/V^I Weights for inputs in LSTM algorithm;

W^O/V^O Weights for outputs in LSTM algorithm;

W^S/V^S Weights for skips in LSTM algorithm;

Variables (lower-case)

l Latent space variable vector in DCGANs algorithm;

x Input variable vector in DCGANs algorithm;

\hat{x} Generated input vector in DCGANs algorithm;

y Output variable vector in DCGANs algorithm;

b_t Bias in LSTM algorithm;

b_t^I Input bias in LSTM algorithm;

b_t^O Output bias in LSTM algorithm;

b_t^S Skip bias in LSTM algorithm;

s_t State in LSTM algorithm;

x_t Input in LSTM algorithm;

y_t Output in LSTM algorithm;

REFERENCES

- [1] T. Björk, *Arbitrage Theory in Continuous Time*, 4th ed., ser. Oxford Finance Series. Oxford: Oxford University Press, 2019.
- [2] NordPool. Market data.
- [3] ——. History.
- [4] ENTSO-E, the European Network of Transmission System Operators for Electricity. Single intraday coupling (sidc).
- [5] M. Kaut and S. W. Wallace, *Evaluation of scenario-generation methods for stochastic programming*, J. L. Higle, W. Römisich, and S. Sen, Eds. Humboldt-Universität zu Berlin, Mathematisch-Naturwissenschaftliche Fakultät II, Institut für Mathematik, 2003.
- [6] X.-Y. Ma, Y.-Z. Sun, and H.-L. Fang, "Scenario generation of wind power based on statistical uncertainty and variability," *IEEE Transactions on Sustainable Energy*, vol. 4, no. 4, pp. 894–904, Oct 2013.
- [7] S. Mitra, S. Lim, and A. Karathanasopoulos, "Regression based scenario generation: Applications for performance management," *Operations Research Perspectives*, vol. 6, p. 100095, 2019.
- [8] C. Wu, L. Chen, G. Wang, S. Chai, H. Jiang, J. Peng, and Z. Hong, "Spatiotemporal scenario generation of traffic flow based on lstm-gan," *IEEE Access*, vol. 8, pp. 186 191–186 198, 2020.
- [9] M. Kaffash and G. Deconinck, "Comparison of statistical-based and data-driven-based scenario generation of pv power for stochastic day-ahead battery scheduling," in *2020 IEEE PES Innovative Smart Grid Technologies Europe (ISGT-Europe)*, Oct 2020, pp. 730–734.
- [10] G. Marcjasz, B. Uniejewski, and R. Weron, "Beating the naïve—combining lasso with naïve intraday electricity price forecasts," *Energies*, vol. 13, no. 7, 2020.
- [11] J. Liang and W. Tang, "Sequence generative adversarial networks for wind power scenario generation," *IEEE Journal on Selected Areas in Communications*, vol. 38, no. 1, pp. 110–118, Jan 2020.
- [12] J. Qiao, T. Pu, and X. Wang, "Renewable scenario generation using controllable generative adversarial networks with transparent latent space," *CSEE Journal of Power and Energy Systems*, vol. 7, no. 1, pp. 66–77, Jan 2021.
- [13] N. Di Domenica, C. Lucas, G. Mitra, and P. Valente, "Scenario generation for stochastic programming and simulation: a modelling perspective," *IMA Journal of Management Mathematics*, vol. 20, no. 1, pp. 1–38, Jan 2009.
- [14] J. Xie and T. Hong, "Temperature scenario generation for probabilistic load forecasting," *IEEE Transactions on Smart Grid*, vol. 9, no. 3, pp. 1680–1687, May 2018.
- [15] F. Ziel and R. Steinert, "Probabilistic mid- and long-term electricity price forecasting," *Renewable and Sustainable Energy Reviews*, vol. 94, pp. 251–266, 2018.
- [16] J. Hu, H. Li, and Z. Liu, "A novel scenario generation framework based on the knowledge of existing wind power plants," *IEEE Transactions on Sustainable Energy*, vol. 12, no. 2, pp. 1229–1241, April 2021.
- [17] K. B. Kirui, A. Pichler, and G. C. Pflug, "Scentrees. jl: A julia package for generating scenario trees and scenario lattices for multistage stochastic programming," *Journal of Open Source Software*, vol. 5, no. 46, p. 1912, 2020.
- [18] J. Li, J. Zhou, and B. Chen, "Review of wind power scenario generation methods for optimal operation of renewable energy systems," *Applied Energy*, vol. 280, p. 115992, 2020.
- [19] S. Paul, T. Dey, P. Saha, S. Dey, and R. Sen, "Review on the development scenario of renewable energy in different country," in *2021 Innovations in Energy Management and Renewable Resources(52042)*, Feb 2021, pp. 1–2.
- [20] Y. Chen, Y. Wang, D. Kirschen, and B. Zhang, "Model-free renewable scenario generation using generative adversarial networks," *IEEE Transactions on Power Systems*, vol. 33, no. 3, pp. 3265–3275, May 2018.
- [21] S. Hochreiter and J. Schmidhuber, "Long short-term memory," *Neural Computation*, vol. 9, no. 8, pp. 1735–1780, Nov 1997.
- [22] D. E. Rumelhart, G. E. Hinton, and R. J. Williams, "Learning representations by back-propagating errors," *Nature*, vol. 323, no. 6088, pp. 533–536, Oct 1986.
- [23] I. J. Goodfellow, J. Pouget-Abadie, M. Mirza, B. Xu, D. Warde-Farley, S. Ozair, A. Courville, and Y. Bengio, "Generative adversarial networks," *arXiv preprint arXiv:1406.2661*, 2014.
- [24] A. Radford, L. Metz, and S. Chintala, "Unsupervised representation learning with deep convolutional generative adversarial networks," *arXiv preprint arXiv:1511.06434*, 2015.
- [25] I. Goodfellow, J. Pouget-Abadie, M. Mirza, B. Xu, D. Warde-Farley, S. Ozair, A. Courville, and Y. Bengio, "Generative adversarial networks," *Commun. ACM*, vol. 63, no. 11, p. 139–144, Oct. 2020. [Online]. Available: <https://doi.org/10.1145/3422622>
- [26] R. M. Neal *et al.*, "MCMC using hamiltonian dynamics," *Handbook of Markov Chain Monte Carlo*, vol. 2, no. 11, p. 2, 2011.
- [27] M. Nishio and A. Arakawa, "Performance of Hamiltonian Monte Carlo and No-U-Turn Sampler for estimating genetic parameters and breeding values," *Genetics Selection Evolution*, vol. 51, no. 1, p. 73, 2019.
- [28] C. Andrieu and J. Thoms, "A tutorial on adaptive MCMC," *Statistics and Computing*, vol. 18, no. 4, pp. 343–373, 2008.
- [29] M. D. Hoffman and A. Gelman, "The No-U-Turn sampler: adaptively setting path lengths in hamiltonian monte carlo." *J. Mach. Learn. Res.*, vol. 15, no. 1, pp. 1593–1623, 2014.
- [30] F. Chollet *et al.*, "Keras," 2015.
- [31] M. A. *et al.*, "TensorFlow: Large-scale machine learning on heterogeneous systems," 2015, software available from tensorflow.org.
- [32] J. Salvatier, T. V. Wiecki, and C. Fonnesbeck, "PyMC3: Python probabilistic programming framework," *ascl*, pp. ascl–1610, 2016.