

BEATS: An Open-Source, High-Precision, Multi-Channel EEG Acquisition Tool System

Bing Zou, Yubo Zheng, Mu Shen, Yingying Luo, Lei Li, and Lin Zhang

Abstract—Stable and accurate electroencephalogram (EEG) signal acquisition is fundamental in non-invasive brain-computer interface (BCI) technology. Commonly used EEG acquisition system's hardware and software are usually closed-source. Its inability to flexible expansion and secondary development is a major obstacle to real-time BCI research. This paper presents an open-source, high-precision, multi-channel EEG Acquisition Tool System developed by Beijing University of Posts and Telecommunications named BEATS. It implements a comprehensive system from hardware to software, composes of analog front-end, microprocessor, and software platform. BEATS is capable of collecting multi-channel micro-volt EEG signals up to 4000 Hz with wireless transmission. And it adopts a pluggable structure and easy-to-access materials, which can easily support rapid prototyping, portability, and scalability. Some underlying techniques like direct memory access, interrupt, first in first out are used to ensure the precision and stability of the program at the microsecond level. Compared to state-of-the-art systems, BEATS maintains a relatively high channel number when acquiring data at a high sampling rate, while being quick to set up and use, making it ideal for a wide range of BCI scenarios or long-term daily monitoring. Schematics, source code, and other materials of BEATS are available at <https://github.com/bingzant/BEATS>.

Index Terms—acquisition, brain-computer interface, electroencephalogram, open-source, rapid prototyping.

I. INTRODUCTION

ELECTROENCEPHALOGRAPH (EEG) is a typical and potential non-invasive brain-computer interface (BCI) technology due to its good time resolution, ease of use, portability, and relatively low price [1]. It is one of the most important signals of the human body, which contains extensive information for clinical diagnosis and scientific research. With the rapid development of frontier theories and technologies in biomedical engineering, the application of EEG has expanded from medical health to intelligent control, sleep stage classification, emotion recognition [2], workload detection [1], and other fields. EEG acquisition is a primary and fundamental procedure of BCI, which usually includes the amplification, filtering, analog-to-digital conversion (ADC) of the acquired signals [3]. However, the EEG signal is weak and unstable, generally accompanied by strong background noises. Thus, how to steadily and precisely acquire EEG signals is an important issue and worth investigating.

B. Zou, Y. Zheng, M. Shen, Y. Luo, L. Li, L. Zhang are with the School of Artificial Intelligence, Beijing University of Posts and Telecommunications, Beijing 100876, China (e-mail: leili@bupt.edu.cn).

At present, most EEG-related researches depend on commercial EEG acquisition systems. Commercial acquisition systems can be quickly deployed and speed up the progress of research. However, they still have the following problems [4], [5]. 1) The hardware and software cannot be accessed publicly. Thus, the EEG signals cannot be obtained in real-time for the calculation of indicators defined by researchers. For EEG-related research, this is a major obstacle. 2) The system structure is fixed, and the iteration cycle is long. It is difficult to expand functions, and also lacks the ability to combine with the latest research findings. 3) The commercial acquisition system is expensive and bulky. The high price hinders the large-scale use of the system and the huge size makes it difficult to deploy flexibly in various scenarios.

In the last few years, there are some research about self-developed EEG acquisition systems. Some researches focus on the study of electrodes [6], [7]. Others focus on analog-to-digital conversion and transmission of EEG signals [8], [9], [10], [11], [12], [13], [14], [15]. Some of them also design a graphical user interface (GUI) for signal processing and analysis [16], [17]. Creamino [5] is capable of processing multiple EEG channels in real-time and has the characteristics of cost-effectiveness. In [18], the ability to capture 16 to 64 EEG channels at sample rates from 250 Hz to 1000 Hz and to transfer raw EEG signal over a Bluetooth or Wi-Fi interface is implemented. [19] proposes a lightweight and affordable read-out circuit with low-power, high sampling rates, and low-noise design for the acquisition, amplification, and transmission of EEG signals named CochIEEG. The self-developed system has good scalabilities and can greatly reduce the cost. But there are still some deficiencies as follows. 1) The insufficient sampling rate limits the usage scenarios. The EEG signals acquired under a high sampling rate contain more detailed information than signals acquired under a low sampling rate. Moreover, some studies can only be carried out under a high sampling rate, such as the detection of high-frequency oscillations in epilepsy [20]. 2) The insufficient number of channels leads to the loss of spatial information between channels. The different channels for EEG acquisition contain position information, while EEG signals acquired from different positions exhibit different characteristics. Using more channels to acquire EEG can improve the spatial resolution and preserve the potential information between channels. 3) The connection between the acquisition front end and signal processing host computer still uses wired serial communication, which can not meet the needs of mobility.

To address these situations, this paper proposes an open-

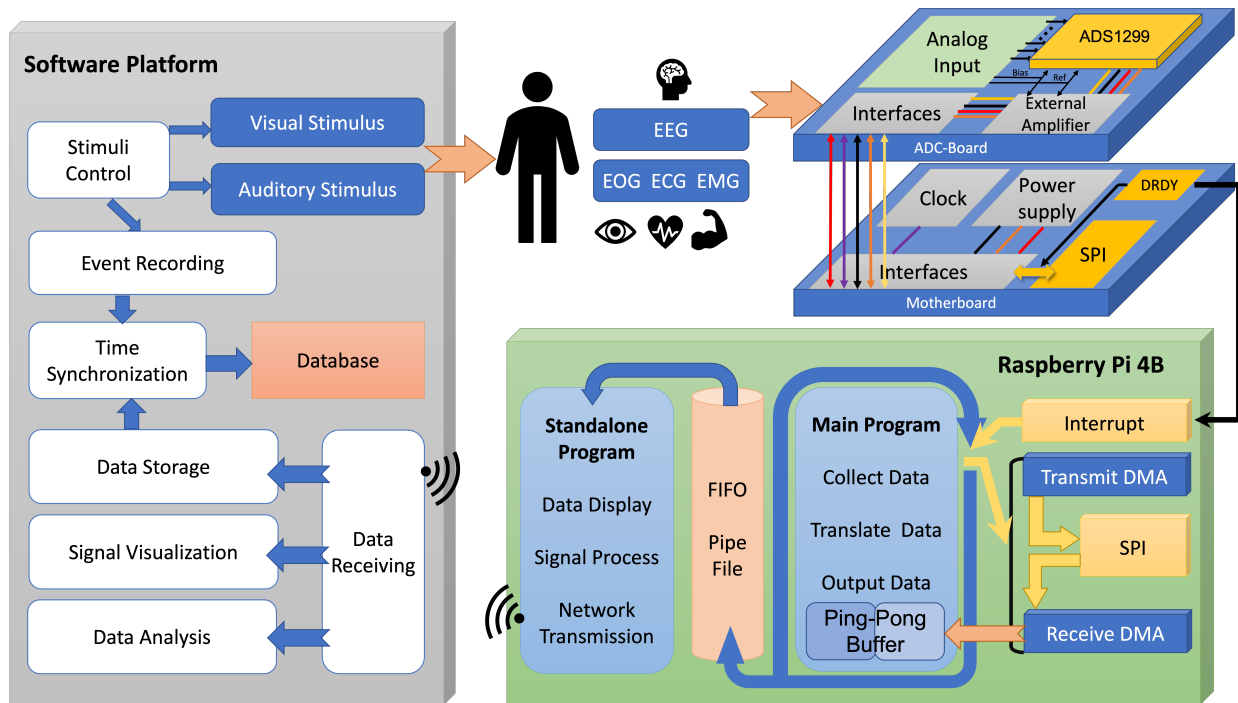

Fig. 1. The architecture of BEATS. Electrodes are firstly attached to appropriate positions according to the electrophysiological signals to be acquired. Then, these electrodes are connected to the ADC-board to perform the analog-to-digital conversion. The converted signals are further processed by Raspberry Pi and transmitted to the software platform. Meanwhile, Raspberry Pi also controls the process of acquisition and ensures stability and precision. After receiving the data transmitted from Raspberry Pi, the software platform visualizes and stores the signals in real-time. Also, the software platform can generate visual and auditory stimuli to participants and record the corresponding time. After time synchronization between signals and experiments, the data with specific events can be stored for subsequent analysis.

source, high-precision, multi-channel EEG Acquisition Tool System developed by Beijing University of Posts and Telecommunications named BEATS. Portable, stable, high sampling rate EEG acquisition, and wireless data transmission can be carried out by using BEATS. The architecture of BEATS is shown in Fig. 1. BEATS mainly consists of three parts: analog front-end (AFE), microprocessor, and software platform. The AFE is conducted around the ADC chip ADS1299 to convert analog EEG signals to digital signals. In the microprocessor part, Raspberry Pi (RPI) 4B is applied to link AFE with the software platform. On the one hand, RPI takes charge of ADS1299's configuration and control. On the other hand, RPI is used to transmit the converted digital EEG signals to the software platform wirelessly. The software platform deployed in a host computer is developed to realize signal visualization, data storage, stimuli generation, and other functions. Compared with other electrophysiological signals, EEG has higher acquisition requirements due to its weak amplitude. Therefore, BEATS can also be able to acquire electrocardiogram (ECG), electrooculogram (EOG), electromyogram (EMG), and other signals. BEATS and other state-of-the-art implementations achieve similar features and functions, and the comparison between different implementations is given in Table I. In addition to similar features, BEATS mainly has the contributions as follows:

- Using the underlying technology, a mechanism to ensure accuracy and stability in high-speed acquisition conditions is designed to achieve high-sample rate multi-

channel EEG acquisition. It meets the vast majority of EEG acquisition needs, including the scalp and intracranial.

- The AFE adopts a pluggable structure. The core components and common modules are placed separately, which can easily expand the number of channels. And system adopts a modular design. Each modular is relatively independent and can be flexibly expanded.
- The system realizes a complete system from hardware to software and is open-sourced. The PCB uses easily accessible materials and can be easily made for usage with open source files.

TABLE I
COMPARISON WITH EXISTING BOARDS

	BEATS (ours)	Creamino [5]	Uktveris et al. [18]	CochIEEG [19]
Modular	Yes	Yes	Yes	No
Channels	24	32	32	8
Sampling rate, Hz	4000	500	1000	4000
Resolution, bits	24	24	24	24
I/O	Wi-Fi	USB	Wi-Fi	USB
Max gain	24	12	12	24
CMRR, dB	111	108	110	-
Local processing	Yes	No	No	No
Open Source	Yes	Yes	No	No

The rest of this paper is organized as follows. Section II, section III and section IV provides the details of the analog front-end, the microprocessor, and the software platform, respectively. And some application cases are introduced in

section V. Finally, the discussion is presented in Section VI and the conclusion is drawn in Section VII.

II. ANGLOG FRONT-END

AFE is designed to enable the initial acquisition of analog signals by connecting electrodes and eventually converting them into digital signals. In order to make effective use of some common modules, two printed circuit boards (PCBs) are designed, named the ADC-board and the motherboard. The ADC-board is designed to realize the data conversation including analog to digital converter, external amplifier, and analog input modules, while the motherboard is designed to support the operation of the ADC-board including power supply and clock modules. These two PCBs are designed to be a pluggable structure. Multiple ADC-boards can be plugged into the same motherboard to achieve more channels.

A. ADC-Board Design

1) *Analog-to-Digital Converter Module*: The core of the analog-to-digital converter module is ADS1299. ADS1299 is a low-noise, 8-channel, 24-bit, analog-to-digital converter for EEG and biopotential measurements. In this scenario, the RPi used to implement control of the ADS1299 is called the master device, and the ADS1299 receives commands to perform operations called the slave device. Serial peripheral interface (SPI) is a synchronous serial communication interface and is used to communicate between ADS1299 and RPi. ADS1299 has four SPI pins, including CS (Chip Select), SCLK (Serial Clock), DIN (Serial Digital Input), and DOUT (Serial Digital Output). Generally, SPI consists of four signals: CS, SCLK, MOSI (Master Out Slave In), and MISO (Master In Slave Out). As ADS1299 is a slave device, the DIN pin is equivalent to the MOSI pin and the DOUT pin is equivalent to the MISO pin. DRDY (Data Ready) is a digital output pin of ADS1299 which uses as a status signal to indicate when data are ready. These five pins are led out to a header for a convenient connection with RPi. Most functions of ADS1299 can be realized by these five pins, including chip configuration and control through registers, digital data transmission, etc.

2) *External Amplifier Module*: In addition to the electrodes that collect signals, there are another two important electrodes named the reference electrode and the bias electrode. Two external operational amplifiers named OPA376 are used to buffer these electrodes. The one is connected to the reference electrode to improve the driving ability of the reference signal. And the other one is connected to the bias electrode to make the signal baseline in the center of the acquisition range of the ADS1299. The bias electrode uses to sense the common-mode voltage of input electrodes and create a negative feedback loop by driving the body with an inverted common-mode signal. Then, the bias drive signal is generated by the feedback circuit and then output to the human body through the bias electrode to suppress the common-mode noise.

3) *Analog Input Module*: The ADS1299 analog inputs are fully differential. When collecting EEG signals, the common reference signal is usually used. Optional SRB pins in ADS1299 are available to route a common signal to multiple

inputs for a referential montage configuration. By connecting the reference electrode to the SRB1 pin and configuring the register, all input channels can share a command reference voltage as a negative input. In this way, only one common reference electrode is needed while half of the reference electrodes can be saved. For each analog input channel, an RC filter circuit is designed to suppress high-frequency interference, and anti-static components are added to avoid damage to the circuit.

B. Motherboard Design

1) *Power Supply Module*: To support the stable operation of ADS1299, the power supply module is designed. The power supply module includes a voltage reverser and high-precision voltage regulator with reverse current protection. The power supply voltage of ADS1299 is divided into analog high level (AVDD), analog low level (AVSS), and digital high level (DVDD). And in this work, the power supply module is configured to 5 V, 0 V, and 3.3 V respectively. The AVDD and AVSS can also be optionally set to ± 2.5 V. The ground pin of the chip is connected to the digital ground (DGND).

2) *Clock Module*: To ensure clock consistency in the case of multiple ADS1299 operating simultaneously, the clock module is designed. The clock module uses a high-precision clock chip to provide a 2.048 MHz external clock instead of the built-in clock. It provides a much more convenient way to connect multiple devices' clocks together. Here an external clock named FXO-HC735 with precision within 50 ppm and 2.048 MHz clock output is selected.

C. Pluggable Interface Design

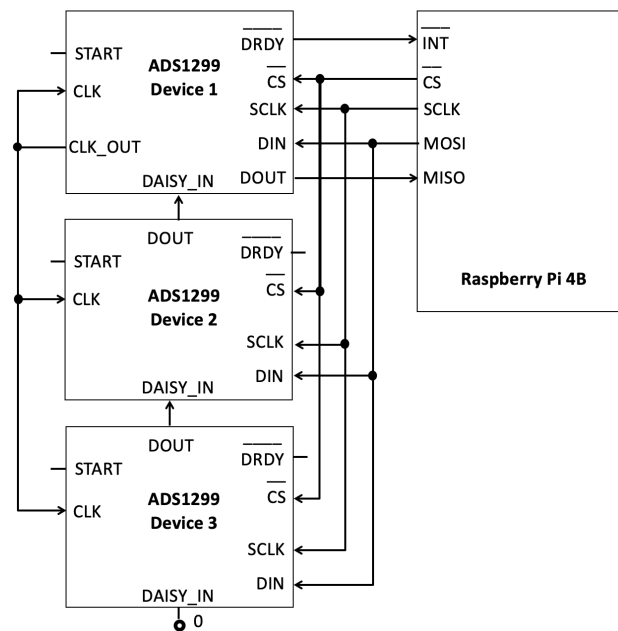

Fig. 2. The scheme of connecting three ADC-boards for 24-channel EEG acquisition.

A single ADC-board can achieve 8 channels of EEG acquisition. Multiple ADC-boards can be plugged together to

expand the channel number in a daisy chain configuration. The pin named DAISY_IN is used for data transmission of multi-chip in daisy chain mode. When using multiple devices, the devices can be synchronized with the START signal. In this mode, SCLK, DIN, and CS pins are shared across multiple ADS1299 devices and connected with SCLK, MOSI, and CS of RPi. The DOUT of the first device is connected to the MISO of RPi, while the DOUT of the second device is connected to the DAISY_IN of the first device, thereby creating a chain. The scheme of connecting three ADC-boards for 24-channel EEG acquisition is presented in Fig. 2. The DOUT of the third device is connected to DAISY_IN of the second device. If an additional ADC board is needed, the DOUT of the latter device should be connected to the DAISY_IN pin of the former device. And the DAISY_IN pin should be shorted to digital ground if not used. In addition, only the DRDY pin of the first board is needed to connect with the RPi, and the DRDY pins of the other boards do not need to be connected. To ensure clock consistency, all PCBs use the same external clock. When using daisy chain mode, the multiple readback feature is not available. Data from the first device appear first on DOUT, followed by the data from the second device.

D. PCB Design and Production

The motherboard adopts a 2-layer PCB structure design. The top layer and bottom layer are signal layers, which are used to place components and wiring. While the ADC-board has more two internal planes: the ground plane and the power plane. The copper at the circuit drawn by the plane mode is etched to divide it into several smaller planes to place different voltage sources. The purpose of dividing the internal plane is to connect the device port and chip pins directly with the corresponding network by using via holes. The power plane is divided into three parts, corresponding to AVDD, AVSS, and DVDD respectively. The ground plane layer is also divided into digital ground and analog ground. Digital ground and analog ground are connected by 0Ω resistance to ensure the consistency of their potential. An etch line is added between the clock chip and the analog input to reduce the interference caused by clock oscillation. The PCBs of the motherboard and the ADC-board are shown in Fig. 3. The size of the ADC-board is $54.61 \text{ mm} \times 44.20 \text{ mm}$, and the motherboard is $55.95 \text{ mm} \times 43.38 \text{ mm}$.

E. Circuit Evaluation

1) *Noise Evaluation*: PCB input short circuit noise is an index to measure the internal characteristics of the circuit. In this evaluation, the input electrode of each channel is short-circuited to the reference electrode by configuring registers, and the input short circuit noise of ADC is measured. Root mean square of noise V_{RMS} , peak-to-peak value V_{PP} , effective number of bits (ENOB) and dynamic range test results are shown in table II. ENOB is calculated by formula 1 and dynamic range is calculated by formula 2. The results show that the parameters meet the standards of the acquisition.

$$ENOB = \log_2\left(\frac{V_{REF}}{\sqrt{2} \times Gain \times V_{RMS}}\right) \quad (1)$$

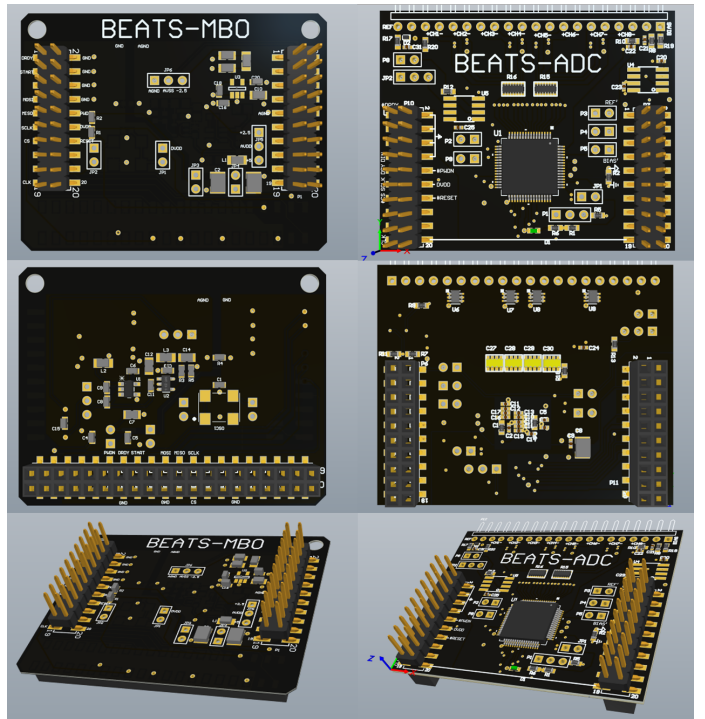

Fig. 3. The PCB designs of the motherboard and the ADC-board. The first column is the front, back and general view of the motherboard and the second column is of the ADC-board.

$$Dynamic\ Range = 20 \times \log_{10}\left(\frac{V_{REF}}{\sqrt{2} \times Gain \times V_{RMS}}\right) \quad (2)$$

TABLE II
THE RESULTS OF INPUT SHORT CIRCUIT NOISE

Sampling Rate (Hz)	V_{RMS} (μV)	V_{PP} (μV)	ENOB	Dynamic Range (dB)
250	0.15	1.00	19.75	118.93
500	0.20	1.54	19.34	116.43
1000	0.28	2.21	18.85	113.51
2000	0.40	2.97	18.34	110.41
4000	0.57	4.51	17.83	107.33

2) *Common-Mode Rejection Ratio (CMRR) Evaluation*: CMRR is an index to measure the performance of electro-physiological acquisition equipment. Its calculation method is shown in formula 3, which can show the suppression ability of the circuit to the common-mode signal. The frequency response of the common-mode signal and differential mode signal is tested by the signal generator. The differential mode signal is a 5 mV , 0 Hz to 45 Hz sine wave signal, and the common-mode signal's peak-to-peak value is 4.4 V , 0 Hz to 45 Hz sine signal with a DC bias of 2.5 V . The test results of CMRR are shown in Fig. 4. CMRR decreases with the increase of frequency. The best CMRR of a single channel in this frequency range reaches 111 dB and the average CMRR of multiple channels is higher than 80 dB which meets the requirement of EEG equipment.

$$CMRR = 10 \times \log_{10}\left(\frac{A_d}{A_{cm}}\right)^2 = 20 \times \log_{10}\left(\frac{A_d}{A_{cm}}\right) \quad (3)$$

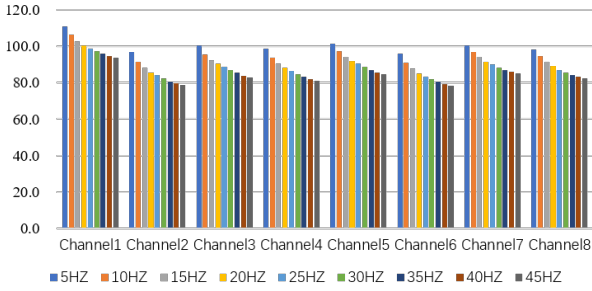

Fig. 4. The results of CMRR in different frequencies.

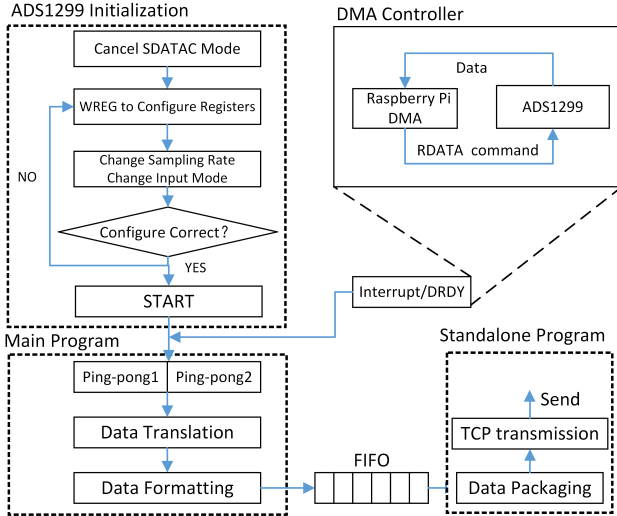

Fig. 5. The program flowchart of the microprocessor.

III. MICROPROCESSOR

In the microprocessor part, Raspberry Pi 4B is used to realize the initialization and configuration of ADS1299, signal conversion, data transmission, and the other operations of BEATS. RPi has rich peripheral interfaces, which can directly communicate with ADS1299 through SPI on board and carry out network transmission. Therefore, RPi is used as a bridge between the AFE and the software platform. SPI is used to communicate with ADS1299 for programming control and the collected data are transmitted to the software platform for further operation through transfer control protocol (TCP). A brief microprocessor program framework is shown in Fig. 5.

A. ADS1299 Initialization and Configuration

ADS1299 is a programmable ADC chip that can be programmed by configuring its registers. By modifying the registers, the sampling rate, gain, working mode, and other settings can be configured. Some key registers' configurations are shown in Table III. BEATS applies totally commands control to establish communication with ADS1299. In this way, a lot of circuit connections can be saved. The ADS1299 provides flexible configuration control through SPI. Commands to configure registers can be sent by RPi and received by ADS1299. Once the registers of the ADS1299 are modified, its operating state and parameters are also changed.

The ADS1299 defaults to the read data continuous (RDATAC) mode after power-up. Issuing the stop read data continuous (SDATAC) command to cancel this mode allows ADS1299 to accept and decode other commands. Then, according to the configuration needed, the registers should be modified through the write to register (WREG) command and confirmed whether as expected through the read from register (RREG) command. After configuring correctly, the start conversions (START) command is sent to enable data conversion for ADS1299. When detecting that DRDY goes low, the read data (RDATAC) command is used to fetch the latest converted signals. The RDATAC command provides a more stable and precise scheme to read data, especially in a high-speed acquisition situation. As the acquisition is complete, the further data conversion of ADS1299 is terminated by using the stop conversions (STOP) command. If ADS1299 does not operate as expected, the reset registers to default values (RESET) command can also be issued to reset devices.

B. Underlying Techniques

In the signal acquisition process, RPi needs to take fetching data from ADS1299 and transmit data to the software these two tasks simultaneously. However, the central processing unit (CPU) of the microprocessor will be distracted by other high-priority tasks. Therefore, there is a jitter in the time, which makes the signal discontinuous. Thus, interrupt, first in first out (FIFO), and Direct memory access (DMA) techniques are introduced to address these situations and ensure the stability and precision of the system.

1) *Interrupt*: The interrupt is commonly used by hardware devices to indicate electronic state changes. As an interrupt is triggered, the CPU will halt the action currently executed, instead perform the interrupt response, and then resume the previous action after the interrupt response is complete. During the signal acquisition, an interrupt is set to listen for the transitions of DRDY. Once DRDY goes low, the interrupt response is triggered to send the RDATAC command and retrieve data immediately. Since interrupt has the highest priority in the RPi program, RPi can retrieve data from ADS1299 timely without causing data loss and time discontinuities.

2) *First In First Out*: The named pipe which is usually called FIFO is an important and frequently used communication mechanism in the operation system of RPi. FIFO can be read and written by multiple processes independently at the same time. Contents firstly written into FIFO will be read out first. When the acquisition begins, a FIFO is established to buffer data. The data fetched from ADS1299 is put into the FIFO while the data to be transmitted to the software platform is taken out from the other side of FIFO. This technique plays a major significance in the speed mismatch between data conversion and data transmission.

3) *Direct Memory Access*: DMA is a memory access technique in RPi systems that allows the DMA controller to access memory independently of the CPU. Typical usage of DMA is to move or copy data from one memory address to another. This transmission action is initialized by the CPU, while performed and completed by the DMA controller. The

TABLE III
KEY REGISTER CONFIGURATION

Address	Register	Default Setting	Configuration	Description
0x01	CONFIG1	0x96	0x96	Set sampling rate from 250 Hz to 4000 Hz
0x02	CONFIG2	0xC0	0xC0	Configure test signal amplitude and frequency
0x03	CONFIG3	0xE0	0xEC	Start bias driver
0x05-0x0C	CH1SET-CH8SET	0x61	0x60	8-channel input mode selection
0x0F	LOFF_SENSP	0x00	0x00	Turn off positive input lead shedding detection function
0x10	LOFF_SENSN	0x00	0x00	Turn off negative input lead shedding detection function
0x15	MISC1	0x00	0x20	SRB1 is used as the common reference signal

CPU can perform other tasks in the DMA data transmission process. In RPi, the SPI communications are configured by underlying registers. DMA can perform SPI communication by moving specific values to the associated registers. Thus, the DMA controller is assigned to fetch data from ADS1299 through SPI regularly while the CPU can process data and transmit it to the software platform through TCP in real-time.

C. Program Framework

There are two programs in this framework, named the main program and the standalone program. The main program takes charge of a series of tasks related to ADS1299, including data acquisition, data translation, data formatting. The standalone program is responsible for the data packaging and transmission to the software platform.

The initialization of ADS1299 is implemented first when the main program starts running. As the data conversion starts, an interrupt to detect the transition of DRDY is enabled. Once DRDY goes low, which indicates the latest conversion is done, RPi drives the DMA controller to fetch data from ADS1299. DMA controller completes the sending of RDATA command by moving specific values to SPI registers, thereby completing the fetch of the data. The fetched data is cached in a ping-pong buffer first. The ping-pong buffer is a structure of two buffers where one buffer is being written while the other is processing at the same time. The two buffers work alternately to make data acquisition and subsequent translation and formatting will not block each other, which makes the process of data acquisition from ADS1299 continuous. The original data fetched from ADS1299 is in binary twos complement format. The main program then converts the fetched data into decimal form, which calls data translation. For a better identify and process of data by standalone program, the decimal data is arranged in a certain format and outputted to FIFO finally. The main program executes the data translation and formatting continuously, and turns to data acquisition once the interrupt is triggered. The data outputted to FIFO is further processed by the standalone program.

The standalone program takes out the data being translated and formatted from the other side of FIFO. The main program and the standalone program operate independently and will not jam each other due to the FIFO mechanism. In the standalone program, the decimal data, timestamp, channel status, and other information are packaged in JavaScript Object Notation (JSON) packet. Then, a TCP connection is established between RPi and the software platform. After the successful connection, data is sent to the software platform wirelessly.

IV. SOFTWARE PLATFORM

Based on a series of functions developed in the software platform, the signals can be processed and analyzed. Data storage and signal visualization in real-time is a basic function of the software, and an online signal analytical algorithm can also be realized to give real-time feedback. In addition, a stimuli generation function is implemented to conduct neurophysiological experiments, which is able to create visual, auditory, and other stimuli. Through the time synchronization between stimuli events and signal acquisition, the data and experiments can be mapped to each other for further analysis.

A. Data Processing and Analysis

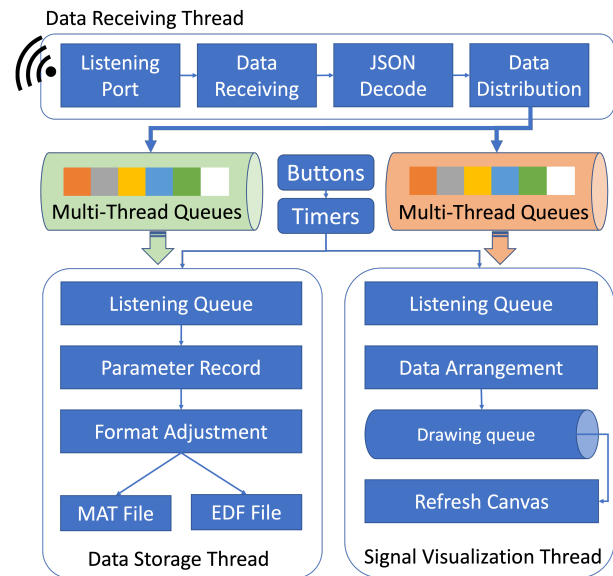

Fig. 6. The framework of the data processing and analysis.

In the data processing and analysis part, the idea of multi-thread is adopted, which can be divided into data receiving thread, data storage thread, signal visualization thread. The overall architecture of the data processing and analysis part is shown in Fig. 6. If the real-time analysis function is required, it is convenient to add the corresponding analysis function such as signal processing, statistical analysis, and machine learning algorithms. Three multi-thread FIFO queues are initialized for asynchronous communication between threads. The data put into a multi-thread queue can be got asynchronously in the data storage thread, signal visualization thread, and data analysis thread respectively which optimize the value and object sharing and ensure concurrent execution.

1) *Data Receiving*: Data receiving is the primary step of data processing. It opens the port for TCP connection firstly and listens to the port status, so as to determine whether the data acquisition program on RPi has sent data. When the port detects that there is data to be received, it collects the length of data packet first, and then receives data according to the data length, so as to solve the common packet sticking problem of TCP transmission. Besides, packet sticking and packet breaking which may destroy the independence of the data packet and affect the continuity of subsequent decoding need to be paid special attention to. A buffer is set manually to solve these problems. After receiving the complete JSON packet, the thread decodes the JSON string and puts them into the multi-thread queues.

2) *Data Storage*: The task of the storage thread is to save the data accurately while not affecting the precise execution of the data receiving thread. When the queue of data storage is not empty, the thread gets data from the queue of data storage. It is known that the system input and output (IO) rate is usually slower than the network transmission rate. Due to the use of the multi-thread library and its queue, data receiving and data storage are relatively independent threads, which can solve the rate mismatch between network transmission and system IO.

3) *Visualization and Interaction*: Signal visualization thread is to visualize the collected electrophysiological signals in real-time and to interact with users through buttons or tips. The pyqtgraph is chosen as the basic framework. A timer based on QTimer is set according to the waveform refresh time to draw the waveform of electrophysiological signals. The refresh function will be triggered to update the waveform in the graphical window once the timer is up which can avoid the additional resource consumption caused by polling. The software has four buttons to control the program, namely "Start Receiving", "Stop Receiving", "Stimulus Recording" and "Revoke". Start Receiving button starts the data receiving thread and listening to the client access. The stop Receiving button stops the data receiving storage threads. The stimulus Recording button is used to record the time when a stimulus happens. The recall button can be used to revoke the former stimulus record to avoid misuse. Tips are designed to show the initialization results and information of threads and processes.

B. Stimuli Generation and Time Synchronization

In order to observe the response of EEG signals to certain events, stimuli generation is a frequently used function. Its main function is to generate stimuli and record the timestamps of corresponding events. Many psychologies, cognitive neuroscience rely on electrophysiological experiments. Especially in psychological experiments and brain cognitive experiments, experiments with stimuli are often designed. When conducting experiments, stimuli with specified meaning are generated, and then record the EEG signals during stimuli taking effect. Stimuli refer to an external input used to induce a certain state of the human body, usually including visual stimulus, auditory stimulus, and so on, such as picture stimulation with different colors, textures, and shapes, video stimulation, music stimulation. During the experiment, events are recorded in

Coordinated Universal Time (UTC). Through UTC time, the events in the experiment can be corresponding to the time stamp in the data collection. Thus, the correlation analysis of experimental data can be carried out.

V. APPLICATION CASES

BEATS implements a complete system from hardware to software, which can be used for EEG and other electrophysiological signal acquisition in various scenarios. In this section, two application cases are described and discussed. The multi-electrophysiological signal acquisition case introduces how to utilize BEATS for EEG, ECG, EOG, and EMG acquisition. And the emotion induction experiment takes emotion computing as an example to describe the construction of the neural electrophysiology experiment process.

A. Multi-electrophysiological Signal Acquisition

For the EEG signal acquisition, three ADC-boards and a motherboard are plugged together for 19-channel EEG acquisition. The placement of 19-channel EEG signals is consistent with the standard 10-20 system. After BEATS is correctly set up, the EEG cap with electrodes can be worn for EEG acquisition. The EEG cap used has 23 electrodes, two of which are reference and ground electrodes, two of which are additional reference electrodes, and the remaining of which are EEG electrodes.

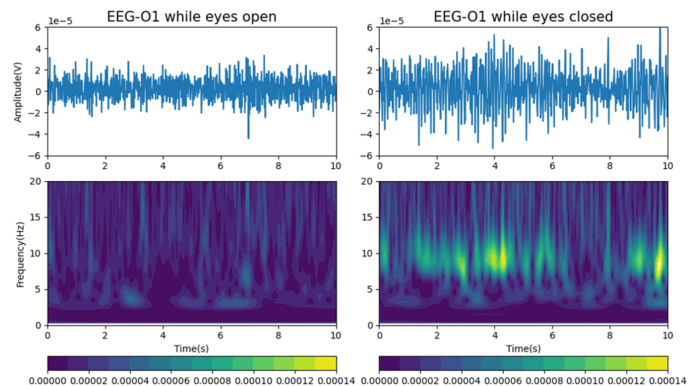

Fig. 7. Alpha wave blockage phenomenon. The left images are the time-domain spectrogram and the time-domain diagram of the EEG in the O1 when the eyes are opened, and the right images are with the eyes closed. When the eyes are open, the activity of the alpha waves is not obvious. When the eyes are closed, the energy of the alpha wave is significantly higher than the other frequency bands.

EEG signals can be divided into different bands according to different frequency ranges. A common technique for EEG acquisition system validation is to analyze alpha waves. Alpha wave is one of the basic waves of EEG, its frequency is 8-13 Hz, which is most obvious in the occipital lobe and posterior parietal lobe. Alpha wave disappears when eyes open, and reappears when eyes close, which is called alpha wave blockage phenomenon. Therefore, in the process of EEG acquisition, the experiment with eyes closed is conducted to observe the phenomenon of alpha wave blockage. In the EEG signals collected at the O1 position, the data collected is intercepted when the eyes were opened and closed for 10

seconds respectively. The time-frequency analysis of these two sections of data is carried out respectively. The time-domain waveform and time-frequency spectrum obtained are shown in Fig. 7. In this figure, the obvious Alpha wave about 12Hz at the moment of closing eyes can be seen.

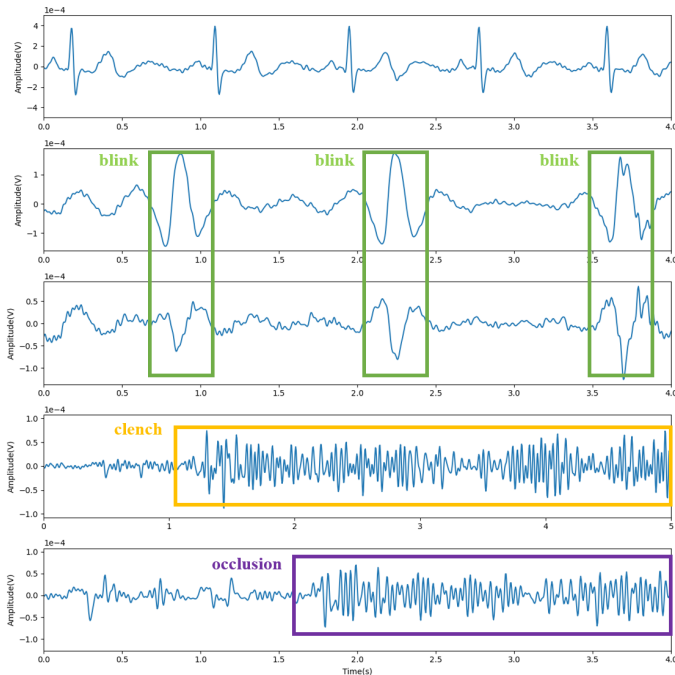

Fig. 8. The ECG, EOG, and EMG signals acquired. Regular ECG signals can be clearly observed in the first row. The second and third rows are EOG. After intercepting a period of data before and after blinking, the inverse state of EOG can be observed. The fourth row is the EMG collected from the muscles of the arm. When muscles work, the amplitude and the frequency of the signal increase. The fifth row is the EMG collected from the mandibular muscles. During occlusion, the amplitude and frequency of this signal increase.

For other electrophysiological signals acquisition, an 8-channel BEATS with an ADC-board and a motherboard is used, including ECG, EOG, and EMG. There are actually 10 electrodes connected in the system because two extra electrodes are needed as reference and bias electrodes. In this scenario, the electrodes used are the patch electrodes with a snap connector. Specifically, the ECG electrodes are placed on the wrist of the left hand. EOG electrodes were placed at the upper and lower positions of the eyes respectively. EMG electrodes were connected to the right forearm at near positions and the mandibular muscles. The mastoid processes of the left and right ears were used as the reference electrode and the bias electrode respectively. The collected signals are shown in Fig. 8. Obvious and regular ECG signals can be seen and the PQRST wave in ECG waveform can also be clearly seen. Because the EOG signals are collected at the upper and lower positions of the eyes, the upper and lower EOG should be inverted at the same time. After intercepting a period of data before and after blinking, the inverse state of EOG can be observed. Since the reference electrode and the position of EMG acquisition cross the heart, there will be a pulse signal in the original EMG signal. Using the two EMG signals as a reference to each other, the pulse signal can be offset, and

the current position EMG signal can be obtained. From the EMG signal, the muscle contraction and relaxation states can also be seen. Intercepting the EMG signal before and after clenching and occlusion, it can be seen that the composition of the signal is obviously different.

B. Emotion induction Experiment

Neurophysiological experiments are a very important component of scientific research. Only through specific experiments can EEG signals be endowed with meanings. Through this case, the procedure of building a complete experiment through BEATS is introduced. Here, an example of an emotion induction experiment is given. And the acquisition scheme is the 10-20 system multi-channel EEG signal acquisition case mentioned before. In the emotion induction experiment, emotion is induced by watching video clips that are full of certain emotions. EEG signals are recorded while the participant is watching video clips. The overall flow of the experiment is shown in Fig. 9.

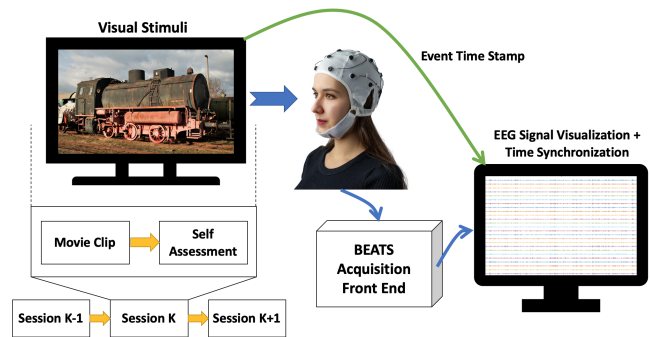

Fig. 9. The emotion induction experiment. The emotions of the subjects are induced by letting the subjects watch audio and video with specific emotions. After the video ended, the subjects assess and give feedback on their own emotional state. During the emotional induction experiment, the EEG signals are recorded in real-time using BEATS.

First of all, some video clips with strong certain emotions are selected. Here, clips with positive, neutral, negative emotions are selected. These clips are cut to the same duration. Then, volunteers are asked to watch these clips and confirm whether these clips can induce corresponding emotions or not. Clips that cannot induce certain emotions are rejected. Healthy participants are selected to conduct the experiment. During the experiment, the participant is asked to watch the selected videos in turn to induce specific emotions. Each time after watching the video, there is a period of time for the participant to evaluate the emotional state when watching the video. In this process, the stimuli generation in the software platform is used to play the video and record the timestamp of the video stimulus events. At the same time, the acquisition front-end also records the corresponding EEG signals and timestamps. By aligning the stimulus event with the timestamp in the EEG signal, the corresponding participant's state can be determined and a dataset can be constructed. Using the constructed dataset, algorithms can be further developed.

VI. DISCUSSION

In the past decades, EEG signals have played an important role in medicine. With the development of technology, many innovative solutions for the BCI have emerged. In the next few years, the application fields based on EEG will further expand. BEATS aims to help this expansion. Based on RPi 4B and ADS1299, the acquisition front-end is developed, and then the software platform is implemented to form a complete system. As an open-source system, and with the characteristics of rapid prototyping, users can quickly deploy this system into use. In addition, modularization is adopted to reduce the dependence of each part of the system, which makes BEATS easy to customize at all levels. At present, the commonly used EEG acquisition systems are either expensive and difficult to deploy on a large scale, or the system is fixed and difficult to expand, or the performance and the usage scenarios are limited. This paper can solve these problems to a certain extent. ADS1299 is a low-noise and high-precision analog-to-digital converter for bioelectrical potential measurement. Compared with other ADC chips, ADS1299 can collect weak electrophysiological signals well. The ADC chip communicates with the external devices through SPI, but the computer often does not have an SPI interface directly connected with the peripheral devices. RPi has rich peripheral interfaces, which can serve as a bridge between ADC chips and computers. Compared with Arduino, STM32, and other microcontrollers, RPi can directly communicate with the computer through wireless communication instead of serial communication through a wired connection. In RPi, the programming language of C is used to develop the underlying DMA, interrupt, pipeline, and other technologies. Python is also tried to use for system development, but the accuracy and reliability of the system are not guaranteed. Compared with Python, using C for the underlying development takes longer cycles, but it is an inevitable choice to ensure the reliability of the system. On the software platform, Python is used for development. In more complex application scenarios, using Python for application software development is a better choice to improve efficiency. And users can also use C/C++ for custom development, which can greatly improve the efficiency of the program. However, the trade-off between the development cycle and operation efficiency may be a considerable problem.

VII. CONCLUSION

This paper presents an open-source, high-precision, multi-channel EEG acquisition tool system named BEATS. With circuit schematics, source code, and instructions, BEATS can be used for research and education purposes freely at <https://github.com/bingzant/BEATS>. Using BEATS can collect weak EEG signals and a variety of electrophysiological signals, such as ECG, EOG, EMG as well. In addition, BEATS can ensure the reliability of multi-channel, high sampling rate data acquisition. Based on Raspberry Pi 4B and ADS1299, the acquisition front-end is developed, and then a series of software functions are written to form a complete system. Hardware front-end and host computers use wireless data transmission to support the portability of the system. Each

part of the system has low interdependence, which supports the scalability of the system. In addition, two application cases are given to illustrate how to utilize BEATS. In the application, the process of 10-20 system multi-channel EEG signal acquisition, multi-electrophysiological signal acquisition, and emotion induction experiment is introduced, which enables users to quickly build the system and customize the expansion. Due to the excellent familiarity of BEATS, the provided BEATS can be widely used in many biomedical engineering research.

REFERENCES

- [1] C. -T. Lin and T. -T. N. Do, "Direct-Sense Brain-Computer Interfaces and Wearable Computers," *IEEE Trans. Syst. Man Cybern. -Syst.*, vol. 51, no. 1, pp. 298-312, Jan. 2021.
- [2] H. A. Gonzalez et al., "Hardware Acceleration of EEG-Based Emotion Classification Systems: A Comprehensive Survey," *IEEE Trans. Biomed. Circuits Syst.*, vol. 15, no. 3, pp. 412-442, June 2021.
- [3] B. Li, T. Cheng and Z. Guo. "A review of EEG acquisition, processing and application." *J. Phys. Conf. Ser.*, vol. 1907, no. 1, 2021.
- [4] M. Soufneyestani, D. Dowling, and A. Khan. "Electroencephalography (eeg) technology applications and available devices," *Appl. Sci.*, vol. 10, no. 21, 2020.
- [5] M. Chiesi, M. Guermadi, S. Placati, E. F. Scarselli and R. Guerrieri, "Creamino: A Cost-Effective, Open-Source EEG-Based BCI System," *IEEE Trans. Biomed. Eng.*, vol. 66, no. 4, pp. 900-909, April 2019.
- [6] Z. Wang et al., "A Multichannel EEG Acquisition System With Novel Ag NWs/PDMS Flexible Dry Electrodes," in *Proc. Annu. Int. Conf. IEEE Eng. Med. Biol. Soc. EMBS*, 2018, pp. 1299-1302.
- [7] H. Hinrichs, M. Scholz, A. K. Baum, J. W. Kam, R. T. Knight and H. J. Heinze, "Comparison between a wireless dry electrode EEG system with a conventional wired wet electrode EEG system for clinical applications," *Sci. Rep.*, vol. 10, no. 1, pp. 1-14, 2020.
- [8] Y. Yu, N. Li, Y. Li and W. Liu. "A Portable Waterproof EEG Acquisition Device for Dolphins," *Sensors*, vol. 21, no. 10, 2021.
- [9] M. Moradi, M. Dousti and P. Torzkadeh, "Designing a Low-Power LNA and Filter for Portable EEG Acquisition Applications," *IEEE Access*, vol. 9, pp. 71968-71978, 2021.
- [10] K. Rai, K. K. Thakur, P. K. Mane and N. Panigrahi, "Designing Low Cost Yet Robust EEG Acquisition System," in *Proc. - IEEE Int. Symp. Smart Electron. Syst., iSES*, 2019, pp. 390-395.
- [11] P. Tawheed, J. Mollick, N. Sakib and M. K. Islam, "Development of a Low-cost PC-based Single-channel EEG Acquisition System for Educational and Research Purpose," in *IEEE Reg. Humanit. Technol. Conf.: Sustain. Technol. Humanit., R10-HTC*, 2021, pp. 1-6.
- [12] D. Liu, Q. Wang, Y. Zhang, X. Liu, J. Lu and J. Sun, "FPGA-based real-time compressed sensing of multichannel EEG signals for wireless body area networks," *Biomed Signal Process Control*, vol. 49, pp. 221-230, 2019.
- [13] S. A. Memon, A. Waheed, T. Başaklar and Y. z. Ider Ider, "Low-Cost Portable 4-Channel Wireless EEG Data Acquisition System for BCI Applications," in *Med. Technol. National Congr., TIPTEKNO*, 2018.
- [14] M. Tohidi, J. Kargaard Madsen and F. Moradi, "Low-Power High-Input-Impedance EEG Signal Acquisition SoC With Fully Integrated IA and Signal-Specific ADC for Wearable Applications," *IEEE Trans. Biomed. Circuits Syst.*, vol. 13, no. 6, pp. 1437-1450, Dec. 2019.
- [15] M. Güner and B. Erkmen, "Real-Time, Portable EEG Signal Acquisition System," in *Med. Technol. National Congr., TIPTEKNO*, 2018.
- [16] R. Arif, S. K. Wijaya, Prawito and H. S. Gani, "Design of EEG data acquisition system based on Raspberry Pi 3 for acute ischemic stroke identification," in *Int. Conf. Signals Syst., ICSigSys - Proc.*, 2018, pp. 271-275.
- [17] A. Kassab et al. "Multichannel wearable fNIRS-EEG system for long-term clinical monitoring," vol. 39, no. 1. 2018.
- [18] T. Uktveris and V. Jusas, "Development of a modular board for EEG signal acquisition," *Sensors*, vol. 18, no. 7, pp. 2140, 2018.
- [19] O. Valentin et al., "Validation and Benchmarking of a Wearable EEG Acquisition Platform for Real-World Applications," *IEEE Trans. Biomed. Circuits Syst.*, vol. 13, no. 1, pp. 103-111, Feb. 2019.
- [20] M. Wu, T. Wan, M. Ding, X. Wan, Y. Du and J. She, "A New Unsupervised Detector of High-Frequency Oscillations in Accurate Localization of Epileptic Seizure Onset Zones," *IEEE Trans. Neural Syst. Rehabil. Eng.*, vol. 26, no. 12, pp. 2280-2289, Dec. 2018.