

# The Hitchhiker's Guide to Fused Twins: A Review of Access to Digital Twins in situ in Smart Cities

Jascha Grübel<sup>1,2,3,4,5†\*</sup>, Tyler Thrash<sup>6</sup>, Leonel Aguilar<sup>1,7</sup>, Michal Gath-Morad<sup>8,9</sup>, Julia Chatain<sup>2,10</sup>, Robert W. Sumner<sup>2</sup>, Christoph Hölscher<sup>1</sup> and Victor R. Schinazi<sup>11</sup>

- <sup>1</sup> Chair of Cognitive Science, ETH Zurich
  - <sup>2</sup> Game Technology Center, ETH Zurich
  - <sup>3</sup> Visual Computing Group, Harvard University
  - <sup>4</sup> Center for Sustainable Future Mobility, ETH Zurich
  - <sup>5</sup> Chair of Geoinformation Engineering, ETH Zurich
  - <sup>6</sup> Department of Biology, Saint Louis University
  - <sup>7</sup> Data Science, Systems and Services Group, ETH Zurich
  - <sup>8</sup> Department of Architecture, University of Cambridge
  - <sup>9</sup> Bartlett School of Architecture, University College London
  - <sup>10</sup> Professorship for Learning Sciences and Higher Education, ETH Zurich
  - <sup>11</sup> Department of Psychology, Bond University
- \* Correspondence: jgruebel@ethz.ch  
† Current address: Visual Computing Group, Harvard University

**Abstract:** *Smart Cities* already surround us, and yet they are still incomprehensibly far from directly impacting everyday life. While current Smart Cities are often inaccessible, the experience of everyday citizens may be enhanced with a combination of the emerging technologies Digital Twins (DTs) and Situated Analytics. DTs represent their Physical Twin (PT) in the real world via models, simulations, (remotely) sensed data, context awareness, and interactions. However, interaction requires appropriate interfaces to address the complexity of the city. Ultimately, leveraging the potential of Smart Cities requires going beyond assembling the DT to be comprehensive and accessible. Situated Analytics allows for the anchoring of city information in its spatial context. We advance the concept of embedding the DT into the PT through Situated Analytics to form Fused Twins (FTs). This fusion allows access to data in the location that it is generated in an embodied context that can make the data more understandable. Prototypes of FTs are rapidly emerging from different domains, but Smart Cities represent the context with the most potential for FTs in the future. This paper reviews DTs, Situated Analytics, and Smart Cities as the foundations of FTs. Regarding DTs, we define five components (Physical, Data, Analytical, Virtual, and Connection environments) that we relate to several cognates (i.e., similar but different terms) from existing literature. Regarding Situated Analytics, we review the effects of user embodiment on cognition and cognitive load. Finally, we classify existing partial examples of FTs from the literature and address their construction from Augmented Reality, Geographic Information Systems, Building/City Information Models, and DTs and provide an overview of future directions.

**Keywords:** Digital Twin; Smart Cities; Internet of Things; Sensor Networks; Remote Sensing; Fused Twins; Immersive Analytics; Embodiment; Visualisation



**Citation:** Grübel, J.; Thrash, T.; Aguilar, L.; Gath-Morad, M.; Chatain, J.; Sumner, R.W.; Hölscher, C.; Schinazi, V.R. Access to Digital Twins in situ in Smart Cities: A Review. *Preprints* 2022, 1, 1.

<https://doi.org/10.48550/arXiv.2202.07104>

Received:  
Accepted:  
Published:

**Publisher's Note:** MDPI stays neutral with regard to jurisdictional claims in published maps and institutional affiliations.

## 1. Introduction

Can Digital Twins (DTs)[6,7] really make cities smart? The pressure to transform cities into *Smart Cities* is mounting amongst urban policymakers worldwide [8]. Initially, the hope was that *smartification* would be instilled in cities by simply creating citywide Internet of Things (IoT) installations and remote sensing applications [9–11]. The idea behind this thinking is simple yet alluring: to have everything in the city attached to the Internet and make it proclaim its own state as if it were a smart object [12] remotely observing everything [9,11].

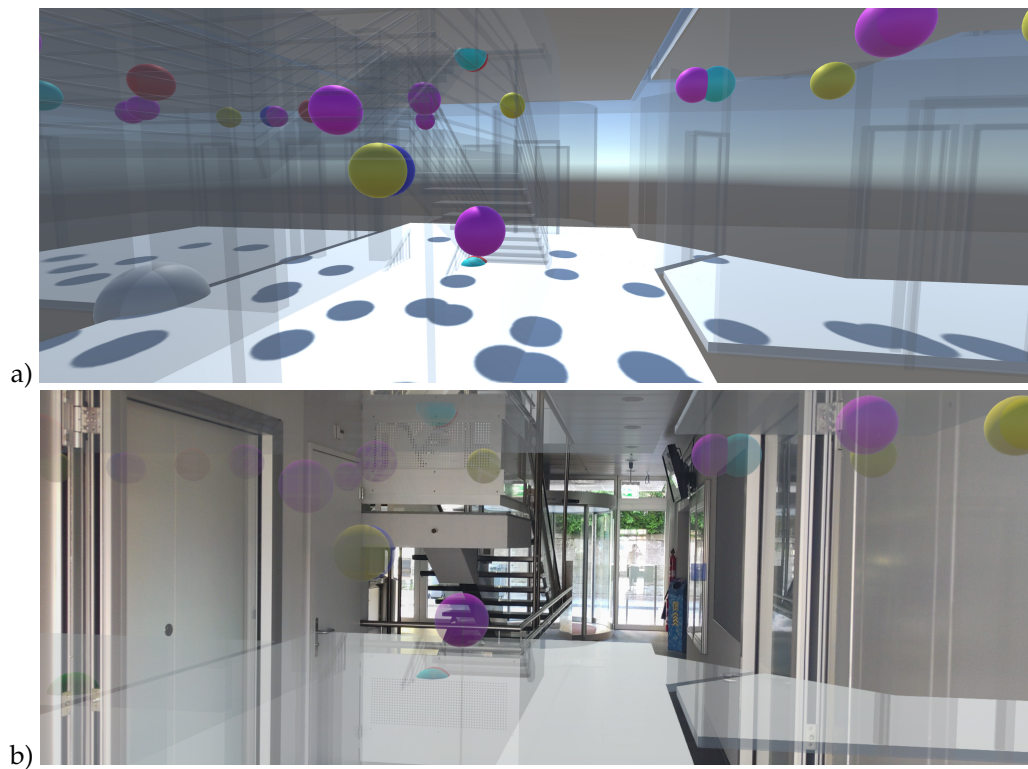

**Figure 1. Comparison of a Digital Twin and Fused Twins.** In both rows, the same lobby of a building is shown. a) the DT of a sensor system with 390 nodes is visualised in Virtual Reality (VR) [1,2]. The white areas visualise the areas of observation and the coloured sphere encode the type of sensor that is located at the respective position in the building. b) the FTs [3] are visualised in Mixed Reality (MR) [4] by embedding the DT *in situ* in its PT thus fusing the two. The fused representation enables Situated Analytics [5] that facilitates the user understanding of analysis through spatial cues of the environment.

Once observed and connected, everything should become measurable. In such a smart city, every minute detail, if measured, can be included in the analysis. This would allow for the uncovering of new insights [13] and give stakeholders a deeper understanding of processes that were previously thought to be fully understood.

However, the complexity of the collected data, the observed processes, and the city itself requires a unifying view. A DT [14] provides a platform on which cities can become really smart by shifting attention from data collection to data use. Here, a digital representation of the city allows for modelling and predicting its ever-changing state via simulations [15–19]. Unfortunately, until now, the virtual and physical environments of cities remain insufficiently interconnected [20]. At best, DTs are remotely displayed in city administration offices to obtain insights [14,21]. However, DTs have the potential beyond administration to inform decision-making on all levels from citizens to politicians and planners [3]. To realise such a wide-ranging implementation of a DT for a Smart City, its data must be accessible *in situ* within its physical context. Situated visualisations [5,22] enable sensing and actuating in the environment with which it is combined.

We introduce the Fused Twins (FTs)<sup>1</sup> paradigm (see Figure 1) paradigm to enable the conceptualisation of an accessible Smart City. We argue that there is a need to clarify the definitions of DTs, Situated Analytics, and Smart cities with an emphasis on the visualisation and development of a practical interface. The FTs concept aims to embed the DT in its Physical Twin (PT), fusing them via Extended Reality (XR) applications [3]. Throughout this paper, we follow the working hypothesis that *DTs combined with Situated Analytics enable lower cognitive load, enhanced cognition, and easier embodiment; and therefore, FTs can make Smart Cities more accessible to users ranging from managers and policy makers to citizens*. Ultimately, only when data is accessible where it is most needed and understandable to those who consult it, can DTs fulfil the promise that IoT alone could not: to power Smart City developments by interlinking the physical and virtual environments.

This review is structured in four main sections. To define the term FTs, we need a thorough understanding of Smart Cities, Situated Analytics, and DTs. The first three sections cover the necessary background to develop, understand, and apply the FTs paradigm. We dedicate the Section 2 to gain an understanding of how Smart Cities arose as a research field and why they converge towards DT research. Section 3 covers Situated Analytics as a novel data exploration approach for Smart Cities. The similarity in the implementation structure leads us to the following section on DTs. The Section 4 elaborates on DTs. We provide a definition following [Tao and Zhang](#), where a DT is constructed using five components (see Figure 2). DTs are a vague term that requires multiple clarifications in terms of composability (Subsection 4.1), servicisation (Subsection 4.2), and differences among cognate terms (i.e., functionally and historically related but slightly different terms [24]; Subsection 4.3). Finally, in Section 5, we cover the FTs concept in depth including the required steps to implement FTs and classify examples of *de facto* FTs in the recent literature. Section 6 provides an in-depth discussion on Smart Cities (Subsection 6.1), Situated Analytics (Subsection 6.2), DTs (Subsection 6.3), and the newly introduced FTs paradigm (Subsection 6.4).

Beyond the definition for FTs, we also provide several new points on a wide range of topics. These topics have often been covered shallowly in shorter research papers which has left a great potential for confusion. In this review, we try to discern some of these, especially in the context of DTs.

<sup>1</sup> On a grammatical side note, FTs are always plural because they consist of both the Physical Twin and the Digital Twin and their interaction.

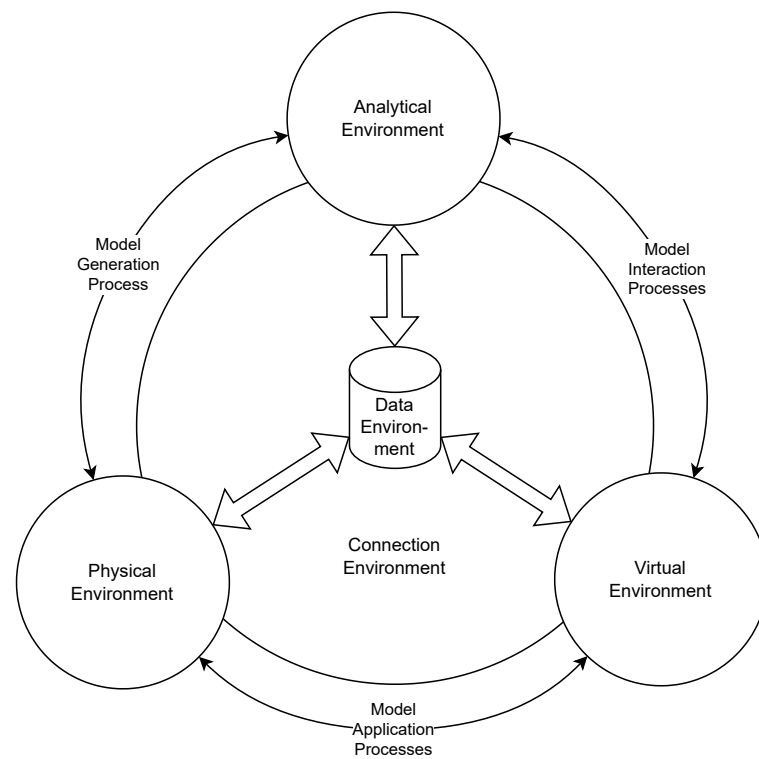

**Figure 2. Components of a Digital Twin.** A DT is often thought of as the interaction between the PT and the DT [7], but any DT implements five core components, even if only partially. These components are the Physical Environment, the Data Environment, the Analytical Environment, the Virtual Environment, and the Connection Environment [23]. The PT is measured through the Physical Environment of the DT, and the raw data is stored in the Data Environment. The Analytical Environment provides simulations, services and automatization. Users often only perceive the DT represented in the Virtual Environment as a model of the PT without being aware of the involvement of all the other components. The Connection Environment is the invisible glue that holds the different components together and enables composition with other DTs if properly implemented. Generated with <http://draw.io>.

## 2. Smart Cities

Smart Cities are an inherently technological approach to resolve urban issues that spawn economic, social, environmental, and governmental aspects [25] (see Figure 3). Smart cities are constituted using bench-marking indicators that can be constructed from technological sources [26]. This technologist approach only provides a narrow perspective [27] that is often divided along disciplinary boundaries [28]. The weakness in the Smart City concept is juxtaposed by its necessity because technological advances are one of the few options to manage the complexity of modern cities [25]. However, at the same time, it must be acknowledged that there are other perspectives or “urban imaginaries” [29] beyond Smart Cities such as resilient cities [30], intelligent cities [26], and sustainable cities [31]. In the remainder of this section, we will expand on the evolution of “smart cities” from the nineteenth century all the way to its portrayal in contemporary urban discourse.

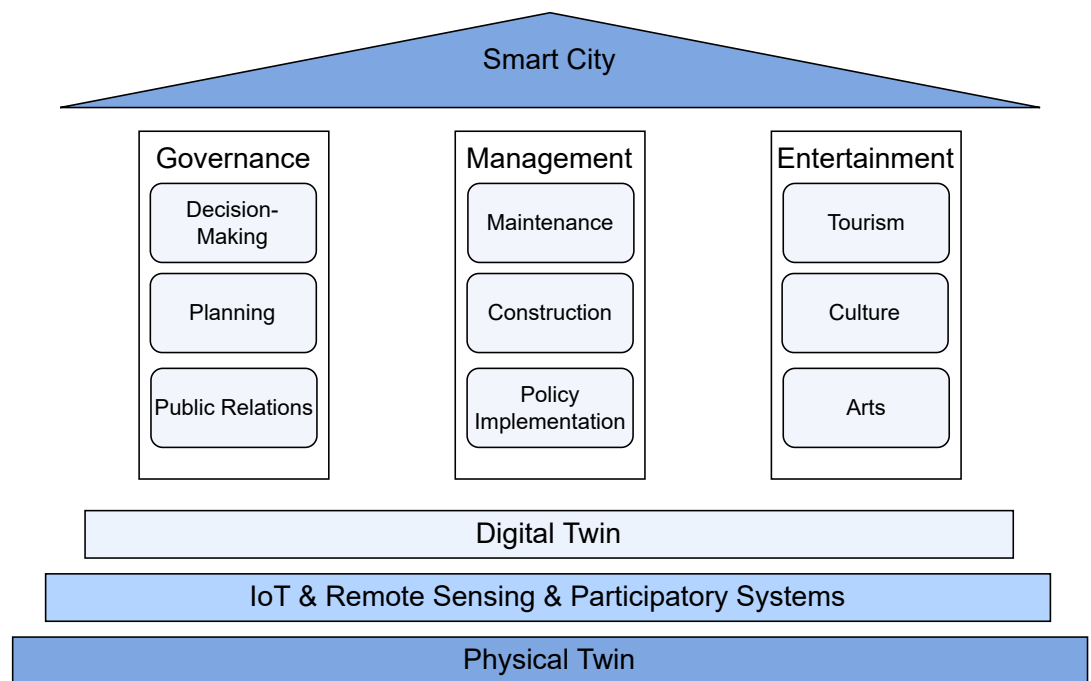

**Figure 3. The Smart City with a Digital Twin Foundation.** Smart Cities rely on effective data collection, analysis, and communication to work. A DT can provide the required processing of the data collection systems to formalise the PT. In a Smart City, a DT provides analysis for governance, management, and entertainment. While governance refers to directing the city’s future, management refers to the present state of the city, and entertainment refers to the use of the city. Generated with <http://draw.io>.

Throughout their evolution, advances in ICT have repeatedly helped cities to cope with growing complexity [32–34]. During the nineteenth century, industrial cities were faced with the management challenges of large industrial enterprises as well as new administration challenges due to unprecedented population growth. The need to process information and communicate it quickly over great distances led to the invention of the telegraph, which enabled the industrial city to keep growing [32,35].

This transformation, from a society in which communication was impeded by distance to a society in which distance is addressed using ICTs, has forever changed humanity and cities [35]. On the one hand, critical obstacles to the growth of cities were removed with the integration of technologies that enabled businesses to flourish and municipalities to govern more effectively. On the other hand, futurists such as Toffler [36] and Negroponte [37]

predicted that these technologies will lead to the “death of distance” because it is possible that improved telecommunications technologies will make cities, and space itself, obsolete. Their basic proposition was that electronics will eliminate the need for face-to-face interactions and that the cities at their core facilitate those interactions and thus would themselves become obsolete [36,37]. Clearly, this is not yet the case. Major cities have become points of intense investment in ICT because the production, exchange, and dissemination of information were and still are critical to their function. Paraphrasing [Abler](#), the shift from goods handling to service and information industries has made cities into communication systems that are central to information flow in the global economy [38].

Today, the integration of ICTs into Smart Cities has become a complex man-made creation that is unparalleled in its cascading effects on every aspect of the city and its citizens [32,33]. Two innovations in the 20<sup>th</sup> and 21<sup>st</sup> centuries have enabled this evolution: the rise of the Internet infrastructure for networked computers and mobile personal computing. In the words of [Townsend](#), “The democrati[s]ation of computing power that started with the PC in the 1970s and leap[t] onto the Internet in the 1990s is now spilling out into the streets [33]” which can be interpreted as the rise of IoT as part of the Smart City landscape.

Contemporary ICTs have restored the importance of space to the previous discourse on urban telecommunication [39]. Everything and everyone in cities generate geo-tagable information which can reveal the position of a multitude of stationary or moving objects in real time [39,40]. Geo-tags enrich space with contextualised electronic content and are a fundamental dimension of a sort of return to space, or *spatial turn*, to use the expression coined by urban geographer [Soja](#) [41]. This spatial turn of digital technologies has been reinforced by the proliferation of electronic interfaces and wireless communications, which realise the notion of Ubiquitous Computing or Ambient Intelligence [33,39,42–45] and ultimately underpin a DT.

Sometimes visible, but more often hidden, countless chips and sensors allow objects, people, and vehicles to be located; consumption levels and transactions to be recorded; and temperatures, pollution levels, population densities and flows to be measured [46–48]. The possibility of transforming every Thing in the built environment into something more “smart” appears more feasible than ever before. Low cost, miniature sensors enable everything to sense and be sensed. The ability to perform analytics over the data collected has become ubiquitous, enabling Things to “think”, while wireless communication technology enables Things to “talk” to one another as part of the Internet of Things (IoT) [33,37,39,40]. However, as note earlier, this dream of Smartification has not been realised due to the increasing complexity of cities. It increasingly looks as if a DT is required to provide the necessary abstractions to enable the Smart City.

Ambient Intelligence has taken on many forms that resemble the functionality of DTs, but they remain disconnected and often disjoint. This leaves it up to the observer to connect the dots, forming the meta-analysis on the city level. Examples of Ambient Intelligence range from trash cans and parking lots to streetlights. Smart waste disposal containers in Barcelona are able to know when they have reached their maximum capacity and must be serviced [49]. Smart parking uses sensors to know if a parking lot is free or not. Citizens can then be directed to available parking in the London borough of Westminster [50]. In the Future City Glasgow project [51], streetlights can be equipped to sense and analyse what is happening below them. Sensors collect data on temperature, humidity, noise, and movement, and interpret the data into a functional “information-scape”. The streetlights can then respond in real time by adapting their light intensity or by communicating the interpreted data to the nearby police station, reporting any ongoing crime.

There are also even more ambitious approaches towards constructing a DT. The Spanish city of Santander with 180,000 inhabitants placed 20,000 sensors to monitor temperature,



luminosity, ground humidity, and available parking slots [52]. Paris’s 120,000 trees have each been equipped with a radio-frequency identification (RFID) chip [53]. In a large number of towns, vehicular traffic is monitored in real time through technology ranging from induction loops, to wireless sensors, to video cameras. In Singapore, this monitoring enabled the introduction of one of the first dynamic pricing systems, which consists of making drivers paying in proportion to the desirability and, more importantly, the congestion levels of thoroughfares [39]. This new capacity of cities to detect, measure, and record what is happening within them is truly unprecedented in their history [33,39,40] and yet requires new infrastructure to manage the sheer complexity [54,55]. In the words of Foth: “If aerial photography revealed the skeletal structure of the city during the nineteenth century, the revolution brought about by contemporary ICTs is likely to reveal its circulatory and nervous systems – as it reveals the “real-time city”. For the first time in history, cities can be understood as a whole, the way biologists see a cell – instantaneously and in excruciating detail, but also alive [56]”.

This new understanding of real-time urban dynamics is not (yet) centralised, nor is it ensured to be the property of city governments and planners. If serviced properly and arranged as DT components, it may remain distributed in nature with a low barrier to entrance and can be accessed from nearly everywhere at nearly any time. The ongoing rise in personal mobile computing, especially smartphones, is transforming how individuals perceive and interact with the urban space that surrounds them. Situated Analytics powered by DT infrastructure would provide citizens, tourists, and other users unprecedented insights into the city to help them in their every day life and in planning how to use the city in the future. Using DTs to power Smart Cities will make analytical tools available to everybody and will make them accessible in a spatial context that will democratise the understanding and use of the city. To realise this vision of a Smart City and deal with the complexity that is already plaguing current implementations of Smart Cities, DTs offer a bedrock. The composability of separate DTs into a city-wide DT, underpinning the Smart City, is a promising approach (see Figure 4).

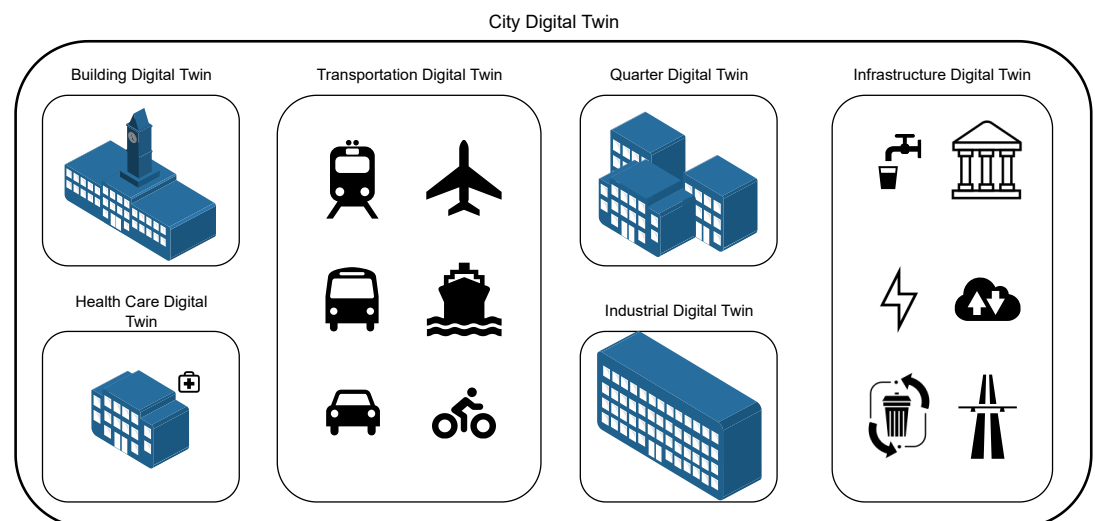

**Figure 4. Composition of Digital Twins to describe higher order complex systems.** Multiple DTs are composed into higher order systems such as cities. Here an open stationary city DT is composed of different open or closed and mobile or stationary DTs such as building DTs, transportation DTs and Infrastructure DTs. Each of the DTs contains complex nested DTs of different types such as for healthcare or industrial settings. The complexity level can be arbitrarily increased through nesting. Generated with <http://draw.io>.

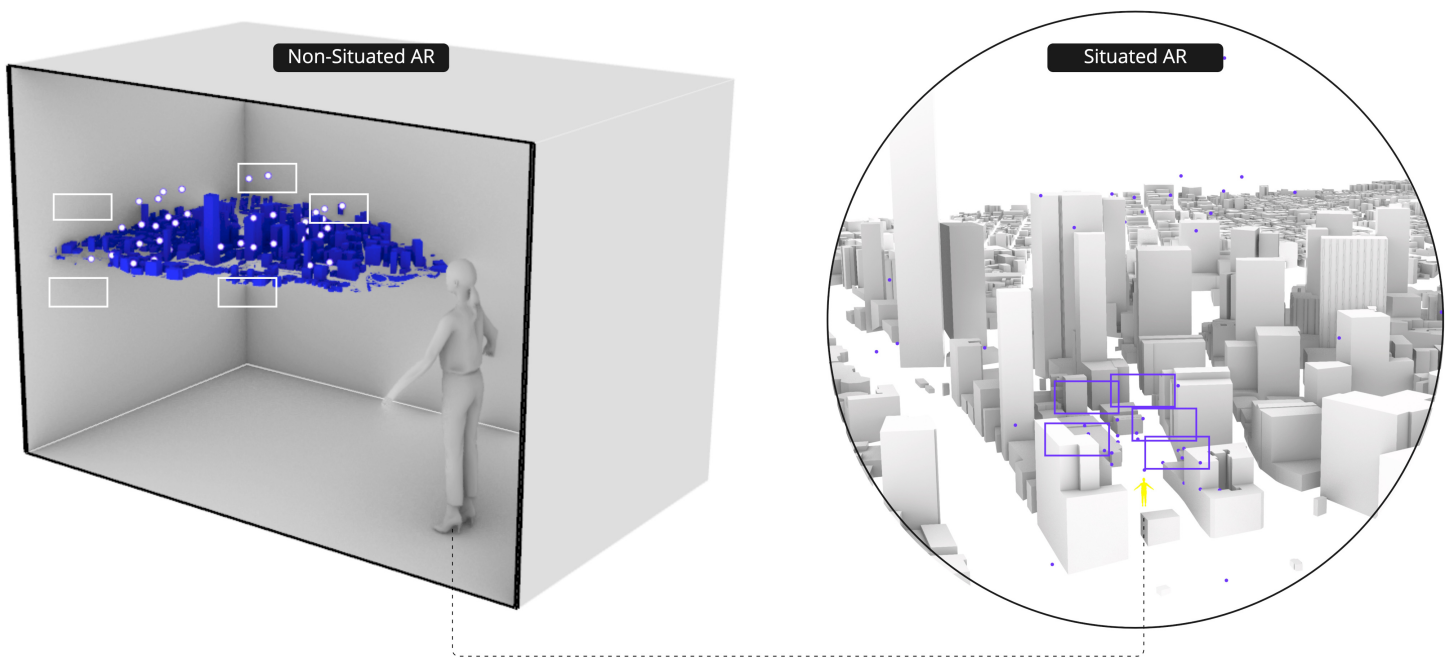

**Figure 5. Immersive Analytics compared to Situated Analytics.** The real world is schematically represented in grey. AR content is shown in blue. On the left side, a user is displaying a smart city environment (blue model) in non-situated AR. Interactables are highlighted in white, and several pop-ups showing information (white squares) are opened. Immersive Analytics make use of 3D space to visualise content but can be independent of the spatial context surrounding them. On the right side, a user (in yellow) is walking through the physical environment of the smart city. In Situated Analytics, interactables are AR content that is displayed in situ of the physical environment that they describe. Similarly to a), pop-ups (blue squares) are showing content to the user in AR space. Generated with <https://miro.com> and <https://rhino3d.com> with royalty-free models from <https://cgtrader.com>.



### 3. Situated Analytics

Augmented Reality (AR) combines computer-generated visual content in 3D with the real world by superimposing virtual content onto a view of the real world [57,58]. The principles of an AR system are three-fold, combining real and virtual elements, registering in three dimensions, and, importantly, providing interactions in real-time [57]. There are at least two categories of approaches to produce AR. First, screen-based approaches, or “see-through AR”, can be divided into the optical combination of a screen with the user’s perception of the real world or 2D displays that replay a live recording of the real world and superimposes virtual content [57,59]. Second, projector-based approaches, or “spatial AR”, consist of projecting the virtual content directly onto the real-world, benefiting from projection mapping algorithms and hardware [59–61]. The last decades have refined see-through AR and, today, the main lines of AR systems are either based on the HoloLens for optical systems and ARKit or ARCore for display-based AR on smartphones and tablets. With the systems maturing to the point where it is both easy to use and easy to generate content, AR applications are going mainstream [62] and find applications across all industries [63], commerce [64], entertainment [65], education [66], and medicine [67].

As AR becomes more than a gadget, it opens the door for immersive analytics [68] of data and information either in situ or remotely (see Figure 5). Whereas the systems to display AR have been developed over the last decades, the visualisation of information in this new media is still in its infancy and yet rapidly evolving [69]. For example, traditional visualisation on 2D screens and print is a well-established field with many well-known representations, toolboxes, and high literacy among producers and consumers. However, most spatial 3D visualisation are still hand-coded and often imitate 2D visualisations. 3D visualisations also offer the opportunity for interaction and embedding in the augmented space [70,71], possibly easing cognitive load and enhancing cognition [72] through externalisation [73].

The development of AR technologies also enables new types of interaction with digital content. Specifically, embodied interaction is a concept that reconnects the fields of tangible and social computing and argues that interaction is fundamentally physical and social. Thus, failing to consider these aspect for design interaction would be a fallacy [74,75]. Embodied interaction is defined as “the creation, manipulation, and sharing of meaning through engaged interaction with artifacts” and places the responsibility of meaning-making on users rather than designers [74]. The level of responsibility for meaning-making at the object’s level is driven by different definitions of affordances across research fields that have yet to be reconciled [76]. There is an epistemological difference between affordances as properties of the object or interaction [77] and affordances as properties of the users’ mental representation [78]. From both Normanian [78] and Gibsonian [77] perspectives, AR can be viewed as deeply anchored in the physical world and therefore demonstrate strong affordances for embodied interaction [57]. Moreover, AR supports a higher amount of embodiment compared to 2D displays by enabling high levels of sensorimotor engagement and immersion [79].

For example, anchoring and embedding visualisations in the physical 3D world can offer tangible ways to explore one’s physiological data [80] and, to some extent, one’s own “personal” DT. For example, Tobe is an AR tangible humanoid DT to explore one’s physiological data such as heart rate and breathing patterns and was used in a social context to let two users relax together via data observation [81]. Similarly, Teegi is an AR tangible humanoid DT used to explore one’s brain activity via electroencephalogram visualisations [82]. Non-humanoid representations have also been explored. Inner Garden is an augmented sandbox embodying one’s physiological state, representing breathing patterns as waves and cardiac coherence as weather [83]. In the wider context of embodied interaction, users’ bodies have also been explored as canvases for digital content [84], for example, by co-locating display and interaction on the users’ hands [85] or utilising embodied metaphors, such as mimicking scissors with



one's hand to cut through digital content [86]. Tests of embodied AR approaches have also been initiated for data exploration in the context of geographical data for visually-impaired users [87–89].

The integration of users' bodies and their physical context has been conceptualised during interaction with digital content. Towards that end, different physicalities of embodiment have been described: body-centred, object-centred, and environment-centred embodiment [90, 91]. We offer examples of embodied DTs and FTs following this categorisation in Figure 6. These categories themselves include direct-embodied, enacted, manipulated, surrogate, and augmented approaches [90,91]. The direct-embodied approach considers the users' bodies as primary constituents of cognition and therefore the body state is used to convey information. In the enacted approach, bodily actions are considered a form of enacting knowledge through movement. The manipulated approach uses the body to directly manipulate a representative object. The surrogate approach uses a physical avatar that performs an interaction with the object. Finally, in the augmented approach, the body is used to manipulate an avatar to interact with the larger environment. The impact of the physicality of embodiment on interaction and cognition is not yet clear. However, these considerations are of importance because a mismatch between activity design and type of embodiment can result in decreased movements, persistence, and learning outcomes [92].

When discussing the spatial context of data visualisation and data embodiment, we also ought to consider the role of the users' bodies in the interaction. Often, the users' bodies are solely considered as physical entities (i.e., *Körper*) utilised to push buttons and perform actions, rather than feeling entities (i.e., *Leib*) [93]. Novel approaches such as somaesthetic appreciation design [94,95] describe the manner in which users' bodies may be integrated in the design process as well as in the experience with digital content and data. Empirical evidence suggests that bodies' representations impact the sense of embodiment [96,97], as well as the types of gestures performed to interact with a system and the time spent observing and interacting with data [98]. In this regard, the challenge of FTs extends beyond meaningfully anchoring virtual data onto a physical context to include the design of the interaction with the augmentation from an embodied, somaesthetic perspective [74,94,95].

Two further problems arise when visualising embodied information in augmented space. First, most traditional authoring tools are focused on 2D visualisations, and new toolkits such as DXR [99] and RagRug [100] have only provided the basis to display 2D visualisations of data in 3D. Second, the benefit of the third dimension is difficult to grasp and even more difficult to implement. Most modern immersive analytics actually rely on embedding 2D displays into the real world [3,99–101]. Visualisations in 3D are typically derived from the previous 2D media, but there is a trend towards exploring new possibilities. For example, multiple 2D visualisations can be arranged to use the third dimension to filter information and visualise this filtration [102].

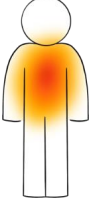
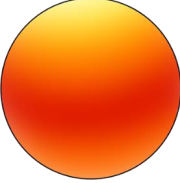
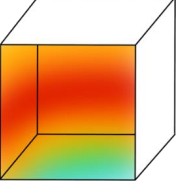
Situated visualisations is less represented in the literature. Recently, there has been some defining work that characterised the types of enhancements that immersive analytics may provide through enhanced vision and visual synesthesia [72]. Addressing the question of how situated visualisations might improve cognition is an ongoing research area. The supposition has been put forth that cognition may be improved by enhanced attention, enhanced numeracy, enhanced recall, enhanced comparison, and enhanced prediction [72]. Moreover, theoretical frameworks such as embodied, situated, and socially situated cognition support the idea that cognition is deeply rooted in its physical and social context [104–106]. However, there are no empirical evaluations yet because, so far, researchers have not focused on the embodiment of the user in the analytics or understanding how the spatial context can reduce cognitive load or enhance cognition.

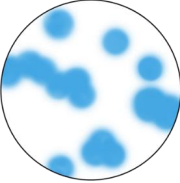
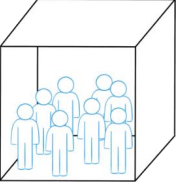
Digital Twin	Body anchor		Object anchor		Environment anchor	
	Planet	User	Planet	Sphere	Planet	Room
Non-situated AR Non-homologous mapping		History of the planet's temperature is represented on the user		History of the planet's temperature is represented on the sphere		History of the planet's temperature is represented on the room
Fused Twin Situated AR Homologous mapping	User	User	Sphere	Sphere	Room	Room
		Breathing of the user is represented on the user		History of the touches on the sphere is represented on the sphere		Visitor density in the room is represented in the room

**Figure 6. Examples of Embodied Digital Twins and Fused Twins.** We observe the difference between non-situated AR (top row) and situated AR (bottom row) for anchoring content at the body of the user, an object, or the immediate environment. The distinction between body-, object-, and environment-centred AR is inspired by the classification of different physicalities of embodiment offered by [90,91]. With a body anchor, the DT is anchored on the users' bodies, similar to the directly-embodied approach. With an object anchor, the DT is anchored on an object with which the user can interact, similar to the manipulated approach. With an environment anchor, the DT is anchored in a room, similar to the augmented approach. In the situated environment (implementing the FTs paradigm), the relationship between the DT and the representation is homologous such that the body, object, or environment is used to anchor its own DT in a one-to-one correspondence. However, in the non-situated environment, this relationship is non-homologous because the mapping from the DT to the representation is transformation instead of a one-to-one correspondence.

Some research is starting to address the impact of the third immersive dimension on visualisation possibilities [107]. For example, one small study demonstrated that a toolkit to create new immersive visualisations helped to keep users engaged for longer and produce more elaborate immersed visualisations. We have a clear understanding of how 2D visualisation improve cognitive load through externalisation [73], but for AR, the evidence is less clear [108–112]. Previous work has proposed the following mechanisms for how 3D visualisations can improve cognition by reducing task switching with visual cues [113,114] and context-sensitive displays [115]. Moreover, recent work also explores the potential of AR to reduce negative split-attention effects in multimedia activities [85,116,117]. Split attention effects [118] occur when two related sources of information are spatially or temporally distant. However, split-attention is not always negative. For example, indexing (i.e., connecting multiple data representations through pointing gestures) is investigated as a mechanism for sense-making [119]. The distance between information sources can also be reduced using AR, in particular the FTs paradigm, because it co-locates physical and virtual entities in real-time [57,116,117,120,121]. In addition, overwhelming displays of information have been shown to decrease performance [122]. There is no definite answer as to how immersive analytics ultimately improves users' performance, but theoretic arguments keep this research area active.

Furthermore, the spatial context in the augmented space has often been used as an empty canvas [99] instead of a source of information [123]. Most commonly, this spatial context has been used for geographic representations to show the built environment either in the past through remote sensing or as planned in the future [123]. The subfield of Situated Analytics [5] combines data with its spatial context to achieve a form of virtual data physicalisation [124] and embodied interaction [70,74,75,85,86] that enables humans to maximise the use of all

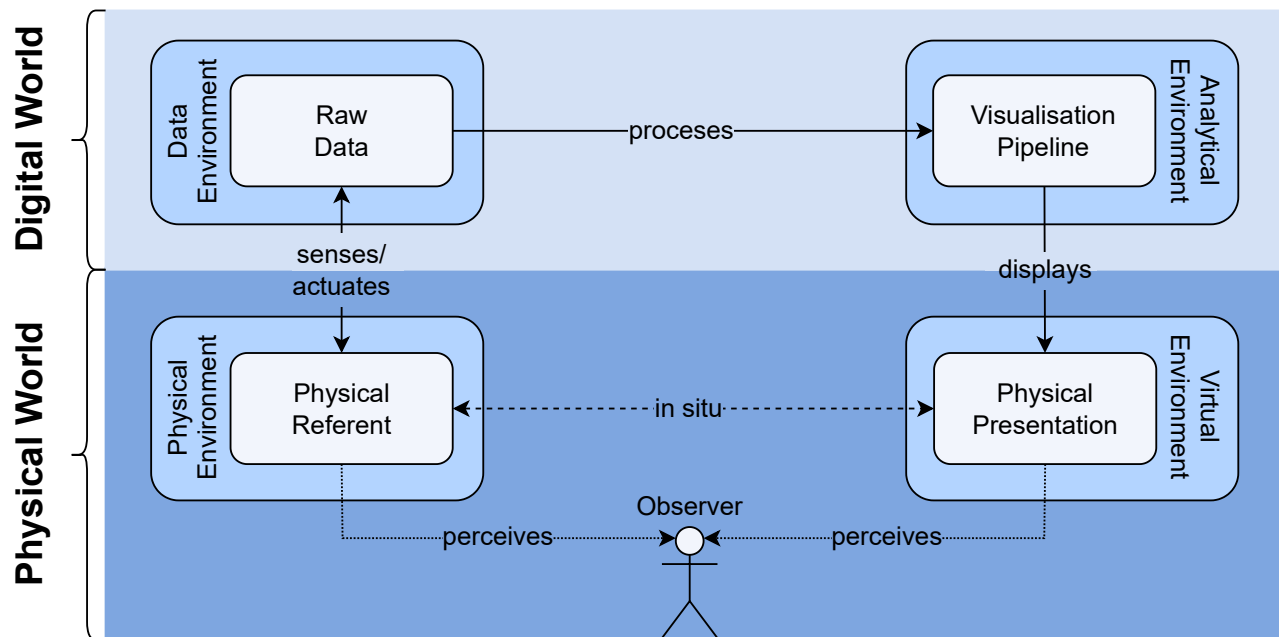

**Figure 7. Situated Analytics [5,103] within a DT context.** Situated Analytics use the Digital/Physical Divide to define the generative steps in situ immersive analytics in the physical world (bottom row) or digital world (top row). There is a remarkable similarity between the components of DTs (blue boxes) and the generation of situated analytics (white boxes). The mapping is visually nested to be highlight. A observer in the physical world sees the physical referent or PT (in the DT context). The observer also sees the physical presentation of information (Virtual Environment of a DT). In the digital world, the raw data is received from the referent, which covers the processes of gathering data by the Physical Environment and storing data by the Data Environment. The Visualisation Pipeline produces a visual output (Analytical Environment of a DT). Lastly, the data is placed into the physical presentation (Virtual Environment). Generated with <http://draw.io>.

senses to perceive the data (see Figure 7). Indeed, information on cities can be embedded in the situated context with meaningful 3D representations that users can explore. The real world can become the canvas to help users make sense of the information *in situ* [125].

#### 4. The Digital Twin

Before we explore how FTs can make DTs more accessible, we will review DTs, their historical background, and their relations to other adjacent technologies and the wide range of definitions that accompany them. Historically, the conceptualisation of DTs originated from the industrial branch of IoT developments in 2003 [6]. The concept was loosely defined at the time but already included the most important components: a physical object, a virtual object, and their connections [7]. Throughout this section, we will expand this understanding to reach our definition of a DT based on composability and the five components the Physical Environment, the Data Environment, the Analytical Environment, the Virtual Environment, and the Connection Environment (see Figure 2).

Historically, there was a lag in the adoption of DTs because the technologies necessary to effectively implement a DT were not yet developed [13]. In the 2010s, the DT concept outgrew its industrial roots by capturing cyber-physical integration as well as representing the physical world virtually [126,127]. As DTs grow in size from factories and cities [128] to the globe [129], remote sensing with drones and satellites plays an increasingly important role to keep DT representations up-to-date but also offer an opportunity for interactions with the city through interactive mobile displays technology [61]. For a full review on current DT applications, we refer to [54]. Here, we will elaborate the definitions of DTs to form a common basis from where we can develop the concept of FTs.

DTs have been “hyped” according to Gartner as one of the top-ten most promising technological trends of the previous decade [13,130–133]. Beyond the hype, across many different definitions, DTs fuzzily describe any software aiming to closely represent something in reality [134]. These qualities are in line with common and older definitions such as Cyber-Physical Systems (CPS) [135], Ubiquitous Computing (UC) [46], and Mirror Worlds [136], which begs the question of whether we can (and should) draw a line between DTs and these concepts. Here, we argue that DTs should be approached as an analogy to a mental model that helps to structure information and actions and to attach them to the real world through appropriate mechanisms such as the FTs concept.

In this review, we next situate DTs in the context of its predecessors. DTs are a specialised form of Cyber-Physical Systems (CPS) [135] because they focus on the accurate representation and manipulation of processes in the real world with a model. DTs are similar to Ubiquitous Computing [46] because they attach computations to real world objects, but without the FTs paradigm, DTs are ultimately not Ubiquitous Computing because the computations are detached from the embodiment of the represented object. Fusing the PT and DT [3,101] joins CPS properties with the PT to produce truly Ubiquitous Computing as envisioned by Weiser [46].

Whereas Ubiquitous Computing has no clear requirements for the kind of computations to be performed, there is a common theme across different definitions of DTs with respect to the need for simulations to predict a system’s response to critical events. The aim to predict often goes beyond simulating known events towards understanding deviations between the actual observations and the predictions to indicate unknown issues [137,138]. Furthermore, DTs are often expected, not only to report on the state of the system, but to also actively manipulate the system through actuators [7,54,138]. The tension between the accuracy of DT predictions and computational capacity is captured by the idea of Mirror Worlds [136], which perfectly imitate reality similar to a mirror. Early ideations of the DT therefore required the underlying model to support similitude [137], while similitude requires the implementation

of a multi-physics, multi-scale, probabilistic, ultra-fidelity simulation that mirrors the PT based on historical data, real-time sensor data, and a physical model. The “ideal DT” requires similitude to become as close as physically possible to mirroring the real world. Indeed, DTs need to model the mutual dependency of hardware and software to tightly couple the PT and the DT, producing high-quality simulations. Until recently, most simulations were feasible only for certain sub-components of complex systems that relied on scientific knowledge and real observations to produce a more accurate offline simulation. Therefore, the requirements of similitude have only been satisfied in specialised cases such as with the components of flying vehicles [137]. New computational methods increase simulation performance such that events in the DT can be simulated fast enough for predictive purposes in the real world [139]. However, even with respect to aircraft, there are only plans to produce a DT of a whole vehicle [140,141] which are expected to be completed in the coming decade. Regarding the sheer scale of cities, the mirror worlds that would underlie a smart city seems to be a distant dream. Due to the simulation complexity of large-scale systems such as cities, researchers have since called for a less rigorous model definition to make DTs relevant to real world applications [14].

In other words, stepping away from ideal DTs to “practical DTs” can allow for more practical applications. Easing any of the core aspects of similitude allows for the implementation of many useful concepts such as analytical assessment, predictive diagnosis, and performance optimisation [13], even in large-scale systems. Limiting the functionality of DTs to a synchronous representation of reality can also allow for the monitoring of complex production processes, adjust these processes, and possibly optimise them [142]. Ideally, the model underlying a DT is complex enough to enable a system to continuously react to dynamic changes in physical space [143], including unforeseen/unexpected changes [144]. DTs also open the door to continuous design improvement through data feedback loops [145] enabling data assimilation into a model [146,147]. These incomplete but practical DTs can become especially useful if they are composable to cover more features of the PT. Next, we will introduce specialised, practical DTs which answer questions on particular topics and can be composed to resemble ideal DTs.

In our definition, we side-step the discussions surrounding ideal DTs by focusing on structural features of practical DTs. We refine the definition of a DT based on earlier work [13] as a five component system: the Physical Environment, the Data Environment, the Analytical Environment, the Virtual Environment, and the Connection Environment (see Figure 2). In the Physical Environment, IoT systems [47] and remote sensing units [148] try to capture the PT and provide interactions with the PT through actuators. The Data Environment contains the DT’s memory and is usually located somewhere in the cloud but may also be stored locally or at the edge [149,150]. For the Analytical Environment, the processes and models of the DT are computed [151], often in the cloud, and insights and predictions are communicated back to the Data Environment. The Virtual Environment makes the DT accessible to human users and possibly other machines [3,101,152]. Finally, the Connection Environment provides an Application Programming Interface (API) to transfer data as required between the components. We consider two ways of designing the connection environment, 1) from a service perspective, where the Connection Environment is not an independent component but refers to the APIs exposed by the different components, and 2) from a compatibility/hypervisor layer perspective where the connection environment is an independent component that mediates between the other different components in the system. Each component could be implemented in many different ways, and making a sensible choice may be overwhelming. This review gives an overview to guide newcomers through the most important components and decisions that are required to implement the FTs concept with a DT.



To understand DTs, it is necessary to comprehend the function and goal of the core components in relation to the literature. Specifically, we connect our definition of the Physical Environment to research on IoT and remote sensing, as well as our definitions of Analytical and Virtual Environments to research on simulation and interaction with DTs. Our definitions of the Data and Connection Environments are not broadly covered in previous research because previous implementations have used case specific data solutions and had were not focused on interoperability.

The Physical Environment component captures the PT and associated interactions via IoT and remote sensing infrastructure. The composition of IoT stack is regularly repeated but rarely analytically decomposed with respect to its trade offs. For most applications, the stack is designed with the purpose of underlining where and why a specific new technology is needed [153–156]. Technically, this is a useful approach to help experts situate a technology in the literature. However, these stacks typically make many unspecified assumptions that we disentangle here. We start with the notion that the DT perspective can be mapped to aspects of IoT and remote sensing. Following the semantic decomposition of the term IoT [157], Things themselves are not actually *in* the Internet, but information about them is perceived either with attached sensing units or with remote sensing and then shared via the Internet. The DT can be used as the necessary representation of the perceived Thing in the Internet.

Previous resource-oriented and service-oriented architectures have represented IoT hardware as practical DTs without using this particular nomenclature [156,158–163]. In contrast to IoT definitions, the DT perspective does not necessitate the digital information to be shared globally as may be implied by the term Internet. The potential local scope of DTs is reflected in their origins in cyber-physical systems [7,135] where the application scope is usually limited to an industrial production site. Nonetheless, the DT perspective provides us with a useful definition of the properties that a Thing should have when represented digitally. A broad range of example IoT applications have been addressed in previous publications [12,45,47,164–166] and can be generalised to DT solutions.

The Analytical and Virtual Environments in DTs are difficult to precisely define because their development is multi-disciplinary and reaches beyond the simulation perspective. These paradigms have been advanced by independent research in the areas of information science, production engineering, data science, and computer science [13] as well as electrical engineering [167]. A DT is a highly complex system that combines infrastructure, simulation, data processing, human-computer interaction, and services [13]. These approaches give rise to another understanding of DTs as an advanced digitalisation of a system that extends representation of the PT with operations. This produces a rich digital model that has many desired properties such as scalability, interoperability, extensibility, and high fidelity [168]. To arrive at a digital model, digitalisation in a space can also be understood as a virtualisation process [169]. Here, the system is represented in 3D space via modelling and remote sensing. First, behaviours are extracted and knowledge representations are created. Second, the interactions between its constituent elements are modelled and integrated into the knowledge representations. Third, operations and their effects are modelled. Lastly, everything is assembled in a simulation to make the system match the PT as close as possible. Because digitalisation/virtualisation only creates the Analytical Environment (see Figure 2), most research has clearly focused on the analysis and not interaction with the DT. Most research on DTs also follows the simple physical-digital split into PT and DT components [7,134], but this split often fails to capture the difference between the Analytical Environment for computation and the Virtual Environment for interaction (but see [23]). The FTs paradigm offers a new perspective that highlights the unique contribution of the Virtual Environment, resulting in a more intuitive use of the DT in nearly every application domain.

There may also be issues with many definitions of DTs because of the unrecognised difference between an universal ideal DT and a partial practical DT. Ultimately, universal ideal DTs are unachievable because of the need to integrate the complex requirements of similitude and to comply with the many definitions across different literatures. Therefore, any practical DT is only partially implemented compared to ideal DTs. Confusion regarding this distinction has led to a heated debate and has resulted in the differentiation of DTs according to their degree of completeness from digital models and digital shadows to (ideal) DTs [151,170], see Figure 8.

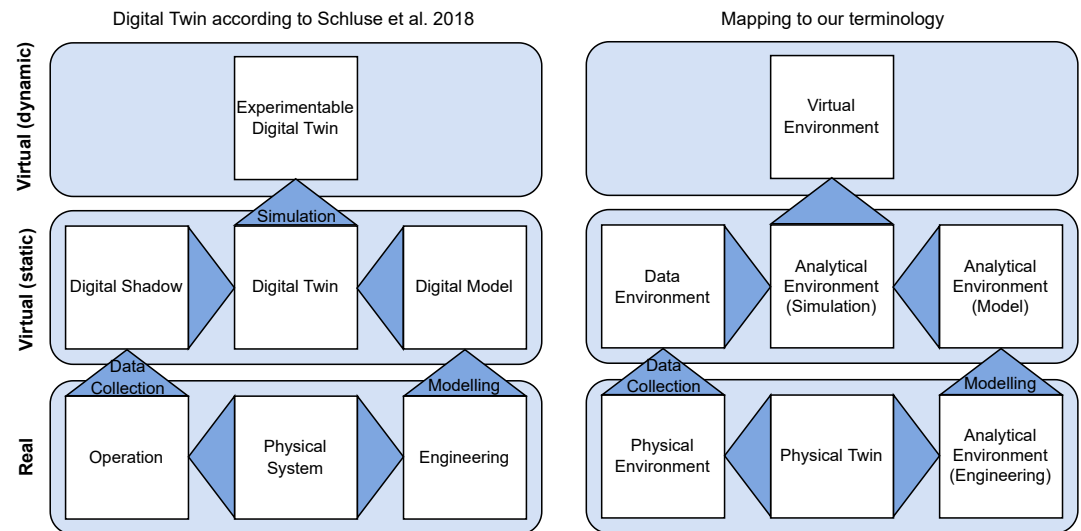
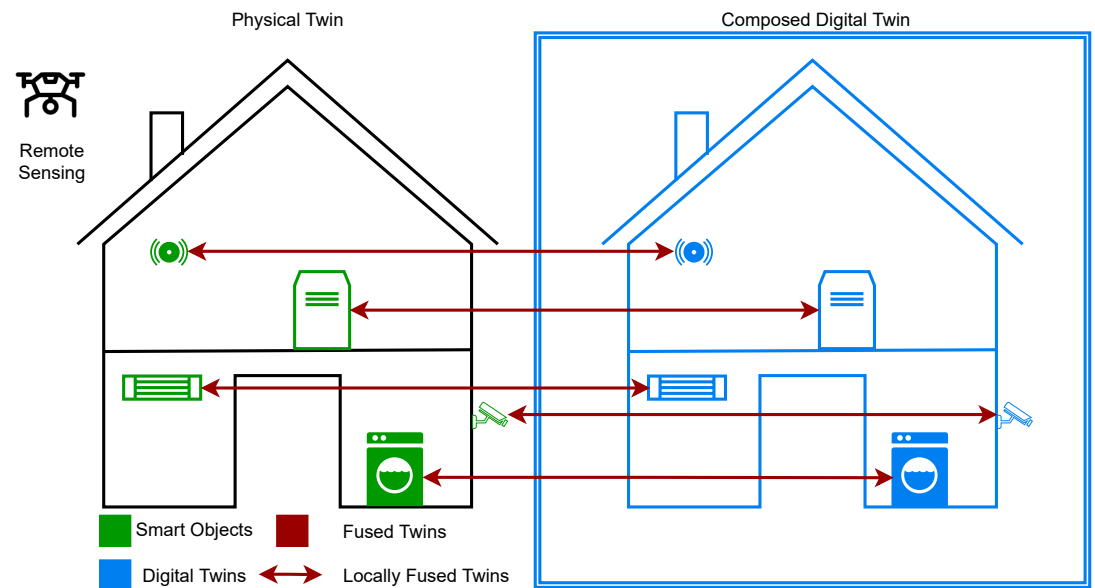

**Figure 8. Digital Shadows and Digital Models in the context of Digital Twins.** The left side demonstrates the relations between a digital shadow, a digital model and a DT [151]. The right side demonstrates the mapping to our definition. The Digital Shadow corresponds to the Data Environment and relies on the Physical Environment to collect data. The Engineering, Digital Model and their DT simulation corresponds to the Analytical Environment. The experimentable DT is akin to the Virtual Environment. In our definition, all blocks are components of the DT whereas in the other definition, the DT is a piece in the diagram. The reduction of the DT to a simulations removes the HCI from the system and requires terms such as digital shadow and digital models to differentiate DTs. Under our definition, these terms reflect different aspects of a DT and map to different components. Generated with <http://draw.io>.

A digital model is an independent representation of a real-world system that may be used in simulations but that is generally not fed real-time data. According to our interpretation, a digital model reflects the implementation of the Analytical Environment. A Digital Shadow is the assembly of data from the real-world system for descriptive purposes. By our interpretation, a digital shadow reflects the Physical Environment of the DT. Thus, our definitions can shift the discussion on digital shadows and digital models from whether something is a DT to what component of a DT is implemented. While a completely implemented, ideal DT at the urban scale is probably out of scope for now, it is feasible to implement and compose partial practical DTs that are capable of performing important tasks for Smart Cities. To elucidate IoT, DTs, and Smart Cities, the present paper adopts the FTs perspective because it unites three views on DTs that are often confounded: Why to generate the DT (i.e., business case for the Analytical Environment), how to generate the DT (i.e., technological implementation of the Physical Environment), and how to use the DT (i.e., end user interaction of the Virtual Environment).

#### 4.1. Composition of Digital Twins

Composed DTs offers an integrative perspective to understand and address the complexity of the PT by using multiple abstractions and performing different tasks on each abstraction (see Figure 9). Towards this end, DTs are composable through their Connection Environment allowing both for the nesting and recombination of components. This approach allows us to re-conceptualise any sensors in the Physical Environment as virtually belonging to all associated composites of the DTs. Composites of the DTs can be produced to offer previously unavailable information via new virtual sensors [171] or virtual sensor networks [172] [173].



**Figure 9. Example Composition of DTs.** Multiple Smart Objects (SOs) and their DTs are composed into a DT of a Household. Remote sensing provides the external context to the building. Locally FTs (SOs) provide physical user interfaces enabling end users to directly interact with the DT in a natural way. Generated with <http://draw.io>.

For DTs to be composable, interoperability between components is the most important feature [168,174–177]. An example composition of the different components is shown across associated DTs in Figure 10. The Physical Environment contains sensory equipment within arbitrary boundaries to capture properties of the PT, which is immutable and equally anchors all overlapping DTs. The Data Environment is a heterogeneous composition of storage architectures that best benefits the data requirements. The Analytical Environment is usually defined per task per DT. In addition, it may also have feedback loops to other DTs via the Data Environment. Outputs of the Analytical Environment are fed back into the Data Environment as virtual sensors to provide the information for display and interaction at a later time. The Virtual Environment forms a local Mirror World [136] that allows for the visual inspection of information in the DTs. The scope of the Virtual Environment is limited to the current composition of DTs and allows for access to and interaction with both the data from the Physical Environment and the data from the Analytical Environment. The Connection Environment manages access rights between components and ensures that users (both humans and other DTs) have the appropriate access rights to use the respective environments, addressing concerns regarding trust, security, and privacy [177–191].

In practice, DTs are applicable to all fields in which IoT has been applied [47,164,192], including industry [158,193], health care [43,44,165,194–197], urban management [48,198,199], vehicular application [200], and mobile end-user applications [201]. However, the

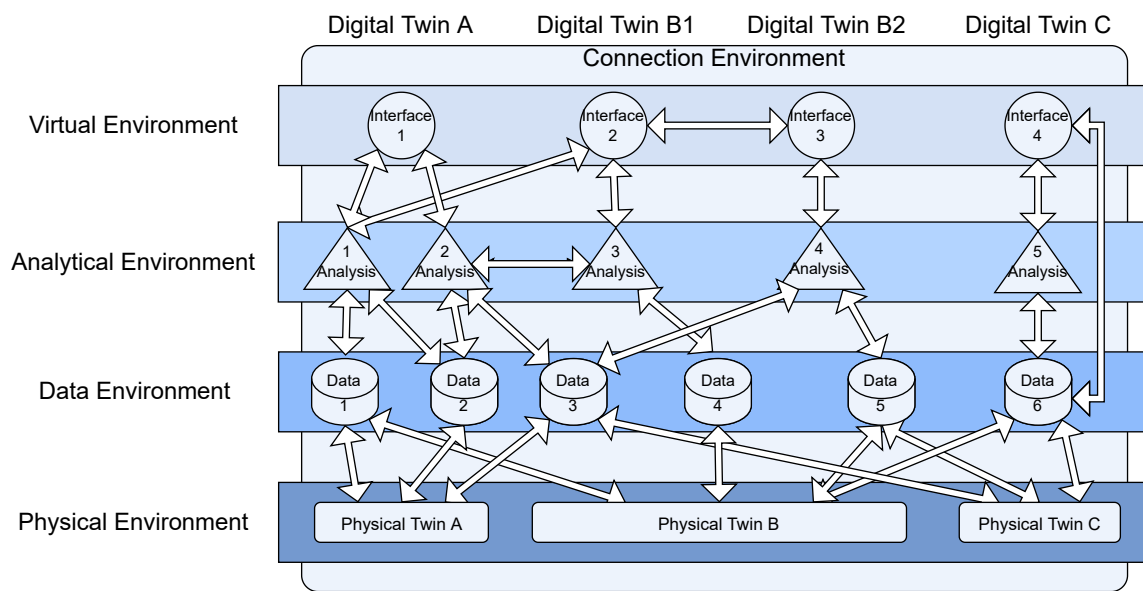

**Figure 10. Composition of Components to form Digital Twins.** Each DT is represented as a column. The Connection Environment (represented by arrows) connects instances in all environments across DTs. The other environments are aligned in rows to show the implementation across DTs. Instances are shown in each environment as rectangles, cylinders, triangles or circles. Data from the Data Environment can be processed in the Analytical Environment or displayed directly in the Virtual Environment. DTs can also be siloed (e.g., DT C) but more often will use the Connection Environment with complex dependencies across all environments. For example, DT A uses Data 3 and Analysis 3 from PT B. PT B has two DTs where DT B2 is composed into DT B1 in the Virtual Environment by combining interface 2 and 3. DT B1 & B2 are using data that is collected from all PTs. Despite DT C being siloed, PT C is evaluated in DT A through Data 3 and Analysis 2. Note that this abstraction makes no claims about the mode of data collection in the Physical Environment that may be with either local sensors or remote sensing. Generated with <http://draw.io>.

composability of DTs suggests that, by extension, these applications should be composable, too. For example, DTs in industry, health care, and transportation could exchange vital information to improve their effectiveness, but, to the best of our knowledge, this has not been accomplished in practice. To understand how DTs of these varied systems could be composed in the context of truly smart cities, we categorise each application by its system type and location type to form a taxonomy of DT contexts (see Table 1).

**Table 1.** Taxonomy of Digital Twin Context Types

		System Type	
		Open	Closed
Location Type	Stationary	Cities, Economies & Countries	Industrial processes
	Mobile	End users, goods & vehicles	Body (health) & machines (internal)

The system type of a DT is either open or closed [202]. Open systems are characterised by an exchange with the wider environment in which they are embedded, whereas closed systems do not directly exchange with the environment and are usually observed in isolation. In addition, closed systems usually supervise well-defined processes, whereas open systems try to characterise ill-defined processes. Obviously, no system is entirely isolated, but industrial processes or health applications can be considered relatively closed systems with usually well-defined interactions with the environment. In contrast, cities and traffic [177] have no clear limit to what is entering from the surrounding environment, and congestion may be a side effect of this ill-defined boundary.

The location type of a DT describes the relation between the unit of observation and the sensors as active or passive sensing [203]. In stationary systems, the sensors are fixed in the environment and observe throughput. In mobile systems, the sensors are moving around either with the observed unit or independent of it. They may also capture environmental conditions around the observed unit such as in human navigation [204] and health monitoring [205].

When composing different types of DTs, it is important to understand their characteristics. Mobile DTs may only temporarily compose with Stationary DTs, while Closed DTs often form units within Open DTs. Open Stationary DTs often form the overarching type of DT that contains other types of DTs, whereas Mobile Closed DTs usually describe atomic units in composed DTs. Typically, Mobile Closed DTs can be part of Mobile Open DTs when a person has a Body Area Network (BAN) [206] for health care applications and a Personal Area Network (PAN) [207] to interact with the environment. In this example, the PAN will provide a wide range of interactions that can be composed with the Open Stationary DT of a Smart City, whereas the BAN will only share limited information. Similarly, a Closed Stationary DT for a Smart Factory within Open Stationary DT of a Smart City will only share limited information.

#### 4.2. Servicisation of Digital Twins

While the word DT suggests some form of unitary entity, it would be more accurate to understand DTs as context-aware representations of Things in the cloud composed of services that act upon the abstraction. Services can range from interacting with the environment to representing the sensed and form the bedrock of ubiquitous computing [46]. Basic services again can be composed into higher-order services to address more complex issues.

With digital representation by the DT, it is possible to turn everything into a service—or *servicise* [208–211]. In other words, the customer buys the temporary use of a service associated with a product instead of the product itself. The cost of developing and maintaining a DT's infrastructure justifies this approach because it is more efficient to reuse resources rather than

to duplicate functionalities [211]. Therefore, DTs can be freely composed of services that conform to the requirements of the Connection Environment .

The three most common themes in “as a Service” (\*aaS) are Infrastructure as a Service (IaaS), Platform as a Service (PaaS) and Software as a Service (SaaS). Newer types of services can be subsumed in these categories, including Sensing as a Services (SenaaS) [212,213], Semantics as a Service (Semaas) [175], and Robots as a Service (RaaS) [214]. Notably, Infrastructure, Platform, and Software “as a Service” form an interesting interaction with the DT components because they can provide abstractions for particular components (see Figure 2). From an abstraction perspective, each replaces the lower layers of the stack with an interface that hides implementation complexity. In this section, we will use the example of weather services as part of a smart city to explain how IaaS, PaaS, and SaaS can map to the components of a DT (see Figure 11).

#### 4.2.1. Infrastructure as a Service (IaaS)

A DT requires the creation of a Physical Environment as the representation of the PT. The Physical Environment provides access to and measurement of the PT using infrastructure to collect raw data (see Figure 2). Creating and maintaining the DT infrastructure is the most physically laborious part of developing a DT. This severely limits the number of entities that can afford to create a DT on a city scale. However, provided as a service, it may be possible to finance the required infrastructure in aggregate and reuse it across multiple DTs. When creating a DT, the IaaS approach allows for the reuse of a service provider’s communication network, sensor network, and remote sensing units rather than having to build one’s own system from scratch. Therefore, IaaS enables to have alternative competing and composable DTs based on the same or different data source(s). There are also more specialised infrastructure services that are available such as Sensing as a Services (SenaaS) [212,213], Remote Sensing as a Service (RSaaS) [215], and Robots as a Service (RaaS) [214].

In our weather service example (see Figure 11), the sensors, network, and remote sensing units in a smart city could be servicised. The city government or a private provider could implement a policy to maintain such an IaaS to make digital services in a city more accessible, enabling the creation of different city DTs. This would allow new entrants to easily develop their own DTs that provide large-scale digital services without having to build physical hardware with redundant functionality [209].

At the same time, IaaS may raise some concerns regarding security. The IoT used for IaaS consists of billions of locatable, addressable, and readable devices [190]. There are three avenues by which security in IoT must be enforced: information, physical infrastructure, and management practices [188]. Security breaches from unexpected behaviour may arise from data collection and management via privacy protection problems, heterogeneous network authentication, and access control problems [188–190,216]. The fundamental challenges for all of these topics are questions of trust: how to give whom access for what purpose and for what duration. Over the last decade, the IEEE and IETF have laid the foundations to build a security infrastructure along the IEEE 802.15.4 standard [217,218] and the IETF LLN stack [207]. These efforts include sensor network security [183], wireless sensor network security [182], and dedicated secure protocols such as CoAP/Lithe [219,220], 6LowPsec [221] and RPL [222]. Ultimately, such as with the Internet, security will be an ongoing process that must be attended at all times.

#### 4.2.2. Platform as a Service (PaaS)

PaaS extends access to hardware by simplifying interfaces. PaaS usually packages digital representations into a Data Environment and thus reduces the complexity of accessing the data. Platforms vary largely and are usually tied to one of the five IoT application areas



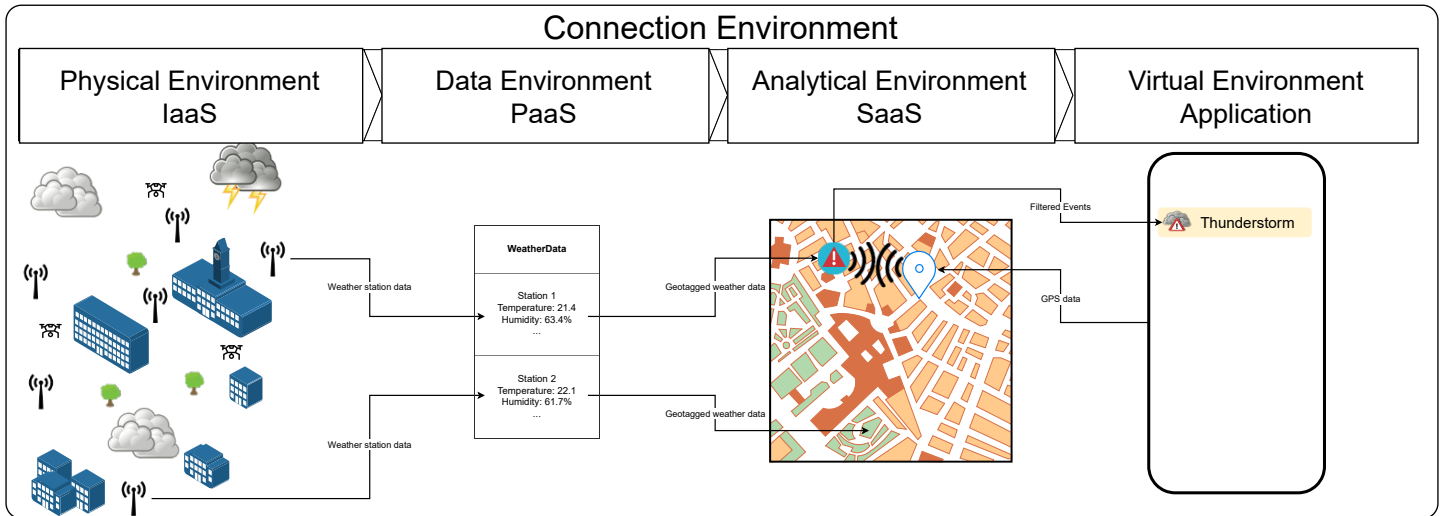

**Figure 11. Mapping of the “as a Service” paradigm to the components of a Digital Twin and the weather services example.** This example application is an alert for a nearby weather event. Presented from left to right, the PT forms the Physical Environment of the DT and is captured by local sensors and networks and remote sensing as IaaS. The Data Environment of the DT serves as a PaaS. The Analytical Environment of the DT models the weather and calculates the proximity to the predicted event as a SaaS. The Virtual Environment is implemented as a smartphone application that provides an alert on an abstract dashboard (see Figure 14 for more details). The Connection Environment spans across all services and environments providing an API that allows for one environment to be replaced by another. This makes the DT both modular and composable. Generated with <http://draw.io>.

industry [158,193], health care [43,44,165,194–197], urban management [48,198,199], vehicular applications [200], and end-user applications [201]. The concept of PaaS can be vague, and its use may sometimes be difficult to differentiate from IaaS or SaaS. In the context of a DT, a PaaS ought to provide only *access to data* as a Data Environment in contrast to an IaaS that collects *raw data* from the physical world as a Physical Environment and a SaaS that *derives higher-order data* from previously collected data as a Analytical Environment.

A DT probably cannot rely on a single PaaS to source all of the required data. More often, a DT will mix and match PaaS sources [223] to fulfil its task. The Data Environment is more complex than simply making data available and needs to be curated, indexed, and integrated into a knowledge graph based on context-awareness [155], ontologies [224–226], and middleware [227–229]. In reality, IaaS and PaaS are often mixed and sometimes offer a subset of services that should be associated with SaaS [230].

In our weather service example, the PaaS stores the information of the weather-related sensor data from sensing units throughout the city, including their spatiotemporal context. Specifically, the PaaS does not include any analytical components but offers a raw data source upon which higher-order data services may be built. A clear distinction is necessary between services to disambiguate their different responsibilities in the DT and ensure composability.

#### 4.2.3. Software as a Service (SaaS)

According to the classical SaaS literature, SaaS is often exposed directly to an end user [201] and ought to follow a singular use case. However, in the context of the DT, SaaS could be mapped to both the Analytical Environment and the Virtual Environment. Following the “as a service” paradigm, we suggest limiting the use of SaaS to the Analytical Environment in DTs to reduce redundant functionality and to enable more servicisation in end-user applications (see Figure 2). Conventionally, one may consider SaaS as built upon PaaS, but the relationship between the Data and Analytical Environments may actually be

bidirectional. The results of the analyses may be written back to the Data Environment before being forwarded to the Virtual Environment for user interaction. Thus, there may be an ambiguity that makes it difficult to separate SaaS from PaaS. The difference lies in whether one considers the results of an analysis to be newly computed as a SaaS or retrieved from memory as a PaaS.

In our weather service example, the classification of the predictive weather data to an end user could be qualified as SaaS if it is being calculated directly. However, if the predictive weather data is provided as a component of a smart city environmental observation system, it would be qualified as a PaaS. In general, a SaaS conducts some analytical task and represents the Analytical Environment of DTs because it generates the models to mirror reality in the DT.

#### 4.3. The Cognates of Digital Twins

DTs are a relatively new perspective that shares a common but amorphous root with a variety of other perspectives. While this root may be difficult to trace precisely and may differ from the intent of the author, it may have originated with various thinkers such as Wiener [135], Weiser [46], or even Tesla [231, p. 122]. Given this complexity, we borrowed the term “cognate” from linguistics [24] that refers to words with a formal resemblance or a common historical root. The confusing overlap among DT cognates is driven by developments across a diversity of research backgrounds such as information science, production engineering, data science, and computer science [13]. The different components of the DT are prioritised differently in each field, which results in similar yet slightly different meanings. For instance, the cognate term IoT is dominating the public sphere according to search word trends (see Figure 12). However, as hype gives way to pragmatism, simply having the physical infrastructure necessary for the creation of DTs is insufficient by itself. The two cognates IoT and DTs are often confused, but IoT may form the basis of DTs in a similar manner that the Internet forms the basis of the Web. Although it is too early to determine, search word trends may eventually place DTs or another cognate as the ultimate concept to describe these systems. The following sections clarify the nuances associated with DTs and their cognates across different disciplines.

##### 4.3.1. Cyber-Physical Systems

A Cyber-Physical System (CPS) represents physical objects as virtual objects. Users can with either physical or virtual objects to change the state of both. A DT is a special instance of a CPS that includes a model of the PT for predictive operations.

The terms DT is relatively new because the original idea of digital representation was first described in detail by Wiener [135] in the field of control theory. Later, the term Cyber-Physical Systems (CPSs) Theory [232,233] was coined to describe a *physical* object, homologous to a “Thing” [157] in the IoT context and the PT in the DT context. This physical object has a *cyber* correspondence, which is homologous to the “Digital Twin” [7]. *A priori*, CPSs have no predetermined (physical) scope and are an idealised form to describe possible interactions with entities [45,234]. Therefore, the CPS literature is rarely linked directly to DTs, remote sensing, or the IoT (but see [235,236]). CPSs are increasingly used to capture social data as well [237]. Their high level of abstraction makes CPS a suitable paradigm to theorise DTs, and findings in the CPS literature are very relevant to DTs.

##### 4.3.2. (Wireless) Sensor (and Actuator) Networks

(Wireless) Sensor (and Actuator) Networks (WSN/SN/SAN/WSAN) provide sensing and actuating infrastructure that processes the signals to and from the physical world to enable a CPS or DT.

A DT cannot be conceptualised without having first digitised the PT. While the DT is usually presented as agnostic with respect to its underlying hardware, the DT cannot be constructed

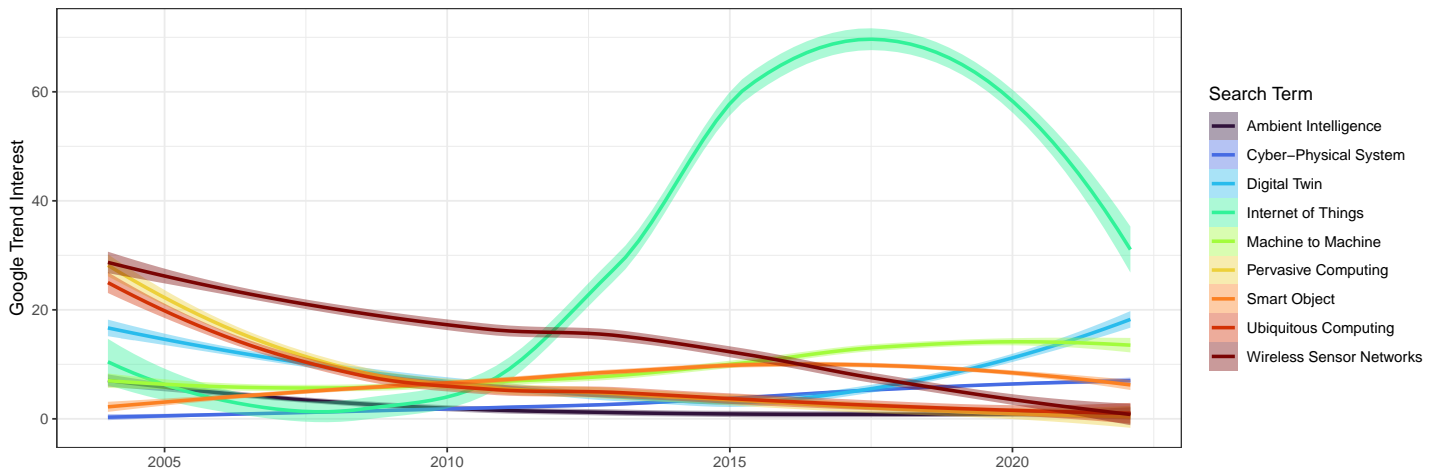

**Figure 12. Google search trends by search term in web searches.** Interests are averaged with LOESS across months from 2003 to early 2022. In general, Internet of Things has been falling since 2017, and Digital Twin has been steadily rising. This year, Digital Twin has become the most searched term among the cognates other than Internet of Things. Terms for underlying technologies and previous system names are stagnating or declining in use. Data collected from <https://trends.google.com> on the 8<sup>th</sup> of February 2022.

without it. Creating this representation requires sensing to comprehend the physical world and actuating to change the physical world [167,192]. Sensor networks ground any Cyber-Physical System in the physical world by provided readings thereof. For each device, questions of how to implement “autonomicity, scalability, energy efficiency, heterogeneity in terms of user equipment capabilities, complexity and environments” [238] need to be answered. Sensor networks have been researched long before the origination of the terms IoT or DT. However, contemporary research focuses more on how sensor networks are seen as a component of an IoT system [239].

In a sensor network context, there are active and passive devices that can be placed in the environment. Passive devices called Radio Frequency Identification (RFID) harvest energy from the transmission signal via induction to return a signal [240]. The signal can be used as an identification of an object in order to trigger a software-based service or to determine its location depending on the RFID reader [241]. Typically, RFID cannot return environmental information (but see [242]). Active devices are usually battery powered and have actual computational infrastructure, sensory equipment, and possibly actuators to interact with the environment. Whether active or passive devices are required depends on the task. A DT will often require a combination of both active and passive devices to efficiently represent the PT and the processes therein. A comparison of tasks and the technology that best captures them can be found in Table 2.

**Table 2.** Task Classification for Active and Passive Devices

Task	Description	Active	Passive
Accessing	Accessing information on an object linked to the device.	✓	✓
Actuating	Triggering an action of the object linked to the device.	✓	
Locating	Identifying the location of an object linked to the device.	✓	✓
Sensing	Measure characteristic of the object linked to the device.	✓	

Without using the term DT, RFID implement a similar abstraction because a “physical object is accompanied by a rich, globally accessible virtual object that contains both current and historical information on that object’s physical properties, origin, ownership, and sensory context [240]”. RFID helps to embed access to knowledge in the environment and can make access to the DT context-driven [240]. For example, if users and environment are both tagged, the appropriate DT services can be called to facilitate the users’ task. At the same time, the system can track such interactions to help model activity for the DT. However, RFID tags could reveal sensitive information, and it is important to manage access control [243].

In contrast to passive devices, active devices usually have local computational power but may be constrained, which should be classified according to usability. Resource constraints on active devices can be grouped into six categories: battery, communication range, bandwidth, memory storage, processing capability, half duplex communication [177]. The IETF has classified devices based on hardware capabilities [244], and each class requires different operating systems (OS) to function optimally [245,246]. They range from Class 0 devices to Class 2 devices. Class 0 devices have a tailored OS that provides no functionality beyond the required features. In contrast, Class 1 devices and above may already run a generalised if bare OS fulfilling the criteria of a small memory footprint, support for heterogeneous hardware, network connectivity, energy efficiency, real-time capabilities, security, and opportune scheduling policies [245,246]. Active devices can be fully integrated into DTs and can be managed from within the DT, whereas passive devices currently only provide anchor points for DTs.

#### 4.3.3. Smart Objects

Smart Objects are physical objects that have embedded computational power to provide interactions for its virtual object to make it more interesting and may represent the fusion of the PT and DT.

A DT can be understood as a highly accurate model of a physical system [7,14,134], whereas a Smart Object (SO) offers interesting interactions with a particular object through embedded or remote computing power [12]. Both DTs and SOs represent a CPS [233]. It could be argued that the concept of an SO either incorporate or encapsulate the concept of a DT. However, a DT is usually required to mirror the role of an actual object in a larger context, whereas SOs only provide end-users with interactions with the particular object [12]. Nonetheless, many SOs will represent the underlying physical object sufficiently close to use them interchangeably for a DT. Assuming that an SO qualifies as a DT and that the SO can offer physical access to its digital representation, it can be considered a dual *embodiment* for both the object (i.e., PT) and the DT, providing a physical instance of the FTs paradigm (see Figure 9).

However, a DT may also describe an entity that is composed of multiple SOs, other Things, processes, and high-order entities. These entities may entail buildings, cities, or regions [9,247–249] modelled through remote sensing [54,128,250]. Moreover, a DT may also be formed of Things that are immaterial or at least incomprehensible in the physical world such as phantom traffic jams [251]. These can be considered purely virtual objects in contrast to virtualised objects [252], which would have a mapping back to a physical object. Composition allows for the formation of even higher order virtual objects that form the basis of a DT in a complex system such as the processes or aggregates representing a city [15,253], traffic flow [254], or production line [23]. Furthermore, a DT may also be produced exclusively by remote sensing without having local sensors attached to the PT [54]. A DT is thus a more encompassing concept than a SO.

#### 4.3.4. Ubiquitous and Pervasive Computing / Ambient Intelligence

Ubiquitous Computing is a paradigm that expects computation to be available for all objects to form a CPS, whereas Pervasive Computing specifies the computation

to occur at the object or close to it. SO and Ambient Intelligence are instances of Ubiquitous Computing in CPSs in which the sensing and actuating capacity is directly embedded into the object that is described by the corresponding DT.

Ubiquitous and pervasive computing are usually considered interchangeable. The former is an older term to link computations to any object in the physical world [46]. The latter is a younger term and associated with placing computing power within (or close to) any object in the physical world [255]. Without loss of generality, we will only refer to Ubiquitous Computing in the remainder of the present paper. For a DT, any data collected in the physical world must be represented in “cyberspace” and thus requires computation. Many ubiquitous computing applications pre-date the IoT paradigm but have been subsumed by it (see [256]).

The closeness between the Thing and computations performed on sensor data from the Thing has often resulted in them being regarded as equivalent to each other [47]. Similarly, the concept of a DT is often used as a synonym for both the PT (homologous to the Thing) and the Physical Environment with WSA (homologous to computations on sensor data from the Thing) from which the DT is created. Ubiquitous computing offers us a lens to distinguish between PT and DT by considering the difference between computations on the state of an object and the actual object. SOs [12,257–259] are a typical example where the distinctions between PT, DT, sensors, actuators, and computations are blurred. SOs are expected to have awareness of their environment and have some model of the ongoing activities, policies, and processes around them. At the same time, SOs should represent functions, rules, and flows that allow for interactivity [12,257]. This formulation clearly indicates that the SOs have a Physical Environment in which they are embedded, an Analytical Environment to model their behaviour, a Data Environment to maintain their state, and a Virtual Environment in which their interactivity can be triggered. When the computations on the object or Thing become unrecognisable to humans because they are “woven into the background”, as predicted by Weiser [46], the term Ambient Intelligence becomes more relevant [42–45]. Making a clear distinction between a Thing, a SO, and Ambient Intelligence is probably neither possible nor desirable.

#### 4.3.5. Internet of Things

The IoT is an amalgam of competing technologies with the goal of digitally representing the physical world. It interconnects WSANs to be combined into local CPSs that in turn compose larger DTs.

The idea behind IoT was first hyped [260–262], then overestimated, and then slowly became practical [263]. The term IoT was probably coined towards the end of the last millennia [264], but its roots are older, albeit unnamed. The functional similarity of CPSs [135] and ubiquitous computing [46], as well as stipulations from early thinkers such as Nikolai Tesla [231, p. 122], make its historical provenance a question of choosing a remotely related cognate. Following Atzori and colleagues [231], we take the probable origin of the term “Internet of Things” by Ashton in 1999 [264] as a starting point to limit ourselves to cases where the general idea of IoT was already the goal of research.

Nearly anything remotely related to Information and Communication Technologies (ICT) [263] is included in modern IoT research [47,164,246,265–276] because IoT promises to be the invisible glue to digitally represent the world and offers new means of analysing and understanding [46]. In part, this may be due to the well-known term *Internet* that immediately allows people to associate it with global information infrastructure [157]. On the other side, a *Thing* is vague enough to label any entity that can be distinguished by some measure [157]. The Intranet of Things in a WSA has been transformed through ICT [276–278] and cloud-centric processing [267,279,280] to the IoT. This loose description is what allowed the IoT to soak up many kinds of ICT developments for the last decade (see Figure 12).



While the term IoT has recently become the most common term for the linkage between the virtual and the real, it was not always the case. Previously, a set of competing ideas (e.g., CPS, WSN, and Ubiquitous Computing) co-created the ecosystem that today is generously labelled IoT and which laid the hardware foundation for DTs. These ideas were closely related but ultimately based on different assumptions because they originated from different fields. According to public perception, the terminology has settled on IoT even as the underlying technology is still quickly diversifying and expanding. With current trends, DTs appear to be a concept that is set to overtake the IoT in terms of public perception (see Figure 12).

Another issue is that IoT is a buzzword that is difficult to grasp because it is overloaded with meaning. Simply tapping into the literature is overwhelming and, at the same time, highly specific. The many technologies peddled under the umbrella-term IoT would be more distinctive if labelled specifically according to their function. While the technological umbrella-term is now well-established, if ill-defined, there is still a lingering sense that different fields of application are uniquely distinct and require special attention. Research and development is thus heavily directed towards five distinct real-world applications that promise the biggest gains: industrial application, urban management, health care, vehicular applications, and end-user applications [47,164,201]. This ingrained belief regarding the distinction leads to difficulties in synthesising common knowledge across applications. Overcoming this barrier could help the interdisciplinary fields of IoT and DTs in many ways. Not only would it enable learning from each other to clarify their theoretical backgrounds, but it would also make the use of IoT as a basis for DTs more accessible. Indeed, a clearly communicated and unified approach to IoT would lower the barriers of entry tremendously.

Weiser [46] postulated the goal of Ubiquitous Computing to make the computations disappear in the mundane of the environment. To obtain services that hide in plain sight, three categories of design considerations have been brought forward that need to be considered for IoT to work: fundamental properties of a Thing, network communication properties, and real-time interaction properties. The fundamental properties of a Thing include existence, sense of self, connectivity, interactivity, dynamicity and sometimes environmental awareness [177,190,238]. Much research has also been conducted on properties to make network communication more efficient, including energy, latency, throughput, modular design for improved scalability, topology, security of information, safety [42,177,238], deployment, mobility, cost, efficient resource usage, heterogeneity, communication modality, infrastructure, coverage, network size, and lifetime [177,238]. Real-time requirements in industrial and healthcare settings have brought forth another set of properties that need to be considered to enable real-time interaction with IoT networks: predictable delays and latencies, congestion free communication, accurate time synchronisation, real-time assurance, interoperability with existing infrastructure, and prioritised communication [177].

The historic development IoT and the evolution of definitions has been addressed in detail by Atzori *et al.* [231]. The work identified three generations of IoT development with different foci that have resulted in the current diffusive definitions (see Table 3). An additional new generation is identified in this review paper that exemplifies the most current trends of DT research in IoT that was not reported in [231]. Notably, while these four generations focus on distinctive features, they are effectively contemporary because these generations are still actively researched. To make sense of these concurrent generations, it is best to understand each generation as a necessary condition to start work on the following generations.

The first generation is driven by the rise of RFID tags [264] to digitally distinguish Things. At this time, IoT was often taken to be synonymous with RFID. This generation is tightly coupled to Ubiquitous Computing [46], Machine-to-Machine (M2M), and CPSs as the RFID technologies ultimately derive from these research fields. However, by the late 2000s, most of these technologies had been tagged IoT. The second generation is driven by



**Table 3.** Waves of IoT generations

	Generation I	Generation II	Generation III	Generation IV
Earliest Mention	1999	2010	2011	2012
Technologies	RFID	Inter-networking	Cloud computing	Fog Computing
	M2M	Web of Things	ICN	DTs
	Object integrations	Constrained devices	Semantic IoT	Opportunistic IoT
Focus	Digitalisation	Networking	Centralisation	Decentralisation
Source	[231,264]	[231,281]	[231,267]	own definition, [7,282,283]

interconnecting Things instead of just centralising the information flow. It focuses on the network component of IoT devices and realistically brings the *Internet* into the IoT [281]. Control of information becomes more central as well, reinforcing the connections to its roots in CPSs [135]. The third generation is driven by a re-centralisation around cloud technologies that matured meanwhile [267,279,280]. This generation focuses on processing data and generating knowledge. The fourth generation is driven by a second wave of decentralisation due to time-sensitivity of applications, fog computing [282], and the rise of DTs [7] and servicisation [211]. As questions of processing have been addressed, the newest generation brings more efficiency to IoT. IoT is often mentioned as a multiplier that makes other technologies more attractive [231], contributing to the diffusion of the term.

#### 4.3.6. M2M

Machine-to-Machine (M2M) communication allows Things and network components to interact automatically with each other without human actions, thus enabling automated formation of CPSs or DTs on different scales.

The complexity of an IoT system underpinning a DT requires much communication between each involved Thing and the network infrastructure to support a control system [135,233,284]. These communication protocols have been aggregated and named M2M communication. M2M is an ongoing research field and is usually required for all other IoT-related and DT-related activities [285–288]. Essentially, M2M describes how IoT components interact with each other and can be understood as part of the implementation of the Connection Environment of a DT. As such, M2M, IoT, and DTs cannot be meaningfully separated, although they do not constitute the same concept. Before IoT became the defining word for ICT, M2M was a contender for being the umbrella-term for these technologies.

The number of devices connected to IoT today surpasses the number of devices manually connected to the Internet. Thus, it is impossible to manually manage the communication between devices by connecting them or maintaining them [177,289–291]. This aspect triggered the development of the M2M concept in the early 2000s [287,292] followed by standardisations such as oneM2M [152] in the 2010s. At the centre of M2M activities are the protocols that are used to exchange information between devices. Protocols describe predefined procedures of how to initiate, maintain, and reestablish communication [152]. While some protocols are high-level, they are often bound by the physical limitations of the communication capabilities of the constrained devices. The complexity of the classical standard Internet Protocol (IP) was quickly disqualified as a platform [293] because of the assumptions that the computing infrastructure was powerful, wired, and connected and that communication was a negligible overhead. However, constrained devices have been highly optimised in terms of energy consumption, size, and costs such that communication has become the major bottleneck [294].

The physical infrastructure to connect constrained devices to the network is usually referred to as physical / PHY [180], and the data link / MAC address is used to uniquely identify single units [295–297]. These terms originate from the OSI model and refer to the physical and data link layers between devices [298]. Originally, a link would be a copper or fibre cable. However, wireless transmission has adopted the same terminology, so PHY usually refers to some kind of antenna that uses a pattern of signals to encode information [250]. To enable a more efficient use of bandwidth and potentially allow for more devices, Cognitive Radios allow secondary users to use communication channels while primary users are idle [286,299,300]. The main trade-off for the PHY connection is between data rates, connection distances, and energy consumption. Currently, technology can be approximately grouped into four application areas: Body Area Networks (BAN), Personal Area Networks (PAN), Local Area Networks (LAN), and Wide Area Networks (WAN) (see Table 4 for an overview).

**Table 4.** Communication technologies for PHY layer

Scope	Abbreviation	Technologies	Reviews
Body Area	BAN	BLE, Zigbee	[206,301–304]
Personal Area	PAN	UWB, Bluetooth, WiFi	[305,306]
Local Area	LAN	WiFi, LTE	[306,307]
Wide Area	WAN	LoRaWAN, Sigfox, NB-IoT	[1,308–313]

The large standardising bodies, IEEE and IETF, approach protocols in constrained environments based on expansion of the IEEE Standard 802.15 [314,315] and the IETF LLN protocol [293,294] to handle IP. In addition, there are technological niches that have not been fully covered by those standardising organisations such as the Low Power Wide Area Networks (LPWAN) where protocols vary and are highly incompatible, representing a low level of industry cooperation [308–311]. However, several consortia have developed around the different core technologies associated with each protocol, and only subsequent years will show how prevalent each WAN technology has become.

The commonality among all protocols is that they are simplified to move data from the constrained devices to some kind of translation unit that transfers the data into the IP protocol, making it widely available on the Internet [316–318]. This translation is necessary to cope with the reduced computing capacity of constrained devices as well as questions of how to transmit data and scale local IoT networks for use in a DT. A difficulty arises for these protocols because the translation unit of constrained devices do not only send data (such as with sensors) but may also receive data (such as with actuators). This aspect requires a bidirectional translation protocol that can uniquely address every node from the outside [319].

#### 4.3.7. Computation-on-the-wire / Dew / Mist / Fog / Cloud and Edge Computing

Computation-on-the-wire computes all necessary transformations on data at the best possible point in the network according to the *subsidiarity principle* to deliver Ubiquitous Computing for CPSs such as DTs.

The trend to locally compute, distribute, and store data in end-user devices and local clusters rather than centralised data centres [282,320] is a reaction to the third Generation of IoT's *cloudification* [231]. At the same time, the trend away from cloudification is the foundational moment for the fourth Generation of IoT. Furthermore, sensors generally pose a trade-off between computational power, latency, cost, accuracy, energy consumption, and security [42,190,321,322]. To balance these trade-offs, additional computational power was introduced physically *closer*

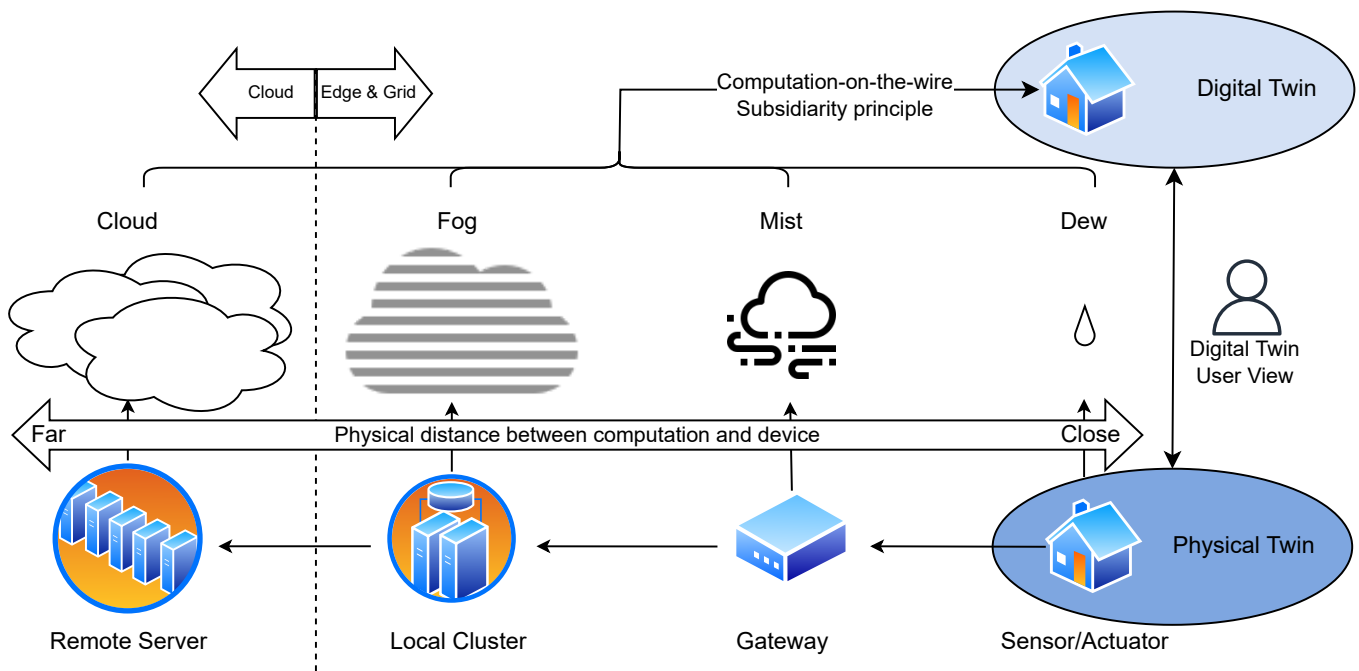

**Figure 13. Computing Hydrology of Computation-on-the-wire.** Computing power can be located locally at the sensor/actuator or more remotely at the gateway, a local cluster, or remote server. The computations form the basis for a DT. Computing in IoT and smart cities is often conceptualised with a hydrological terminology (i.e., cloud, fog, mist, and dew) that maps to the computing location and encapsulates different trade-offs in computational intensity, traffic, latency, accuracy, energy consumption, and security [42,190]. These trade-offs are best evaluated under the subsidiarity principle to decide where to place the computation physically. Edge or grid computing [149,150] is another terminology to covers all non-cloud computing. DTs rely heavily on these different data and computing sources while at the same time abstracting away their existence in the end users' view. Generated with <http://draw.io>.

to the sensors, which also limited data transmission and reduced the load on the network. The placement of computational units in the physical world to provide the necessary computing capacity for Ubiquitous Computing produced a set of *hydrologically* inspired terms to describe different trade-offs. The division of remote computing into cloud [185,235,323–327], fog (also edge or grid) [149,150,282,321,326–339], mist [340,341], and dew [340,342–345] is an attempt to follow this principle (see Figure 13). While the analogy may have been taken a bit too far, this simile is quite adept at equating the distance from the observer to the water droplet and the distance from the device to the computation location. At the same time, the high level of differentiation and the unclear boundaries between these concepts—sometimes used interchangeably—makes the discussion more complicated. For example, fog, mist, and dew computing are often used interchangeably across papers, and edge and grid computing often fit partial definitions of the hydrological terminology.

Another, less metaphorically laden, view focuses on *Computation-on-the-wire* to describe the same phenomena [346]. This perspective assumes that data needs to be manipulated between the data generation point (i.e., a Thing at a physical location) and the data consumption point (i.e., a user inquiring about something related to the PT via its DT). To be the most cost-effective, the computation is required to take place as close to the generation and consumption points as sufficient and as far away as necessary. Therefore, the computation-on-the-wire concept is essentially the application of the subsidiarity principle. Taken from political science, subsidiarity implies that a central authority should only perform tasks that cannot be performed more locally [347]. The principle is most famously applied in the European Union and should be taken as the guiding principle for IoT as well. On a more abstract level, it implies that actions regarding an entity should be taken *a)* as close as possible to an entity and at the same time *b)* as far as necessary to successfully execute the action. Applied to Computation-on-the-wire and DTs, this principle implies that computations for DTs should occur *a)* as close to a device, a requester, or the PT as possible and *b)* as far into the cloud as necessary to successfully compute the output. The concept elegantly joins the hydrological simile and the underlying trade-offs by applying the subsidiarity principle [347].

#### 4.3.8. Remote Sensing

Remote sensing has two meanings. First, it provides observations recorded by a distant measurement device with some form of camera. Second, remote sensing refers to distant access to a local measurement device. Both can be processed to represent the physical environment around a CPS (such as a DT) and to possibly interact with the physical environment.

Remote sensing can be easily misunderstood as either exclusively meaning distant measurements based on some kind of camera [348] or using remote access to sensing units [349,350] to measure local properties from afar such as in agriculture [351], healthcare [352], smart cities [353], or everywhere [354]. Traditionally, remote sensing exclusively refers to camera-based, often airborne, approaches [348]. However, the secondary meaning of remote sensing as a shorthand for “remote access to local sensing units” has become prevalent across nearly all applications that do not apply traditional remote sensing. Whereas there is a clear difference in the meanings of remote and sensing in both interpretations, recent applications combining the two such as sensor networks on Unmanned Aerial Vehicles (UAV) often linked to ground stations and the Internet [355,356] may make the difference irrelevant in the long term. More recently, for the context of the DT, the precise sourcing of information from the Physical Environment is not important. Instead, the accuracy of the measurements must be reported to allow for a decision-making process that accounts for uncertainty. Throughout this review, we understand remote sensing in both its meanings as the main source for information from the

Physical Environment. Furthermore, we assume that any form of traditional remote sensing can be made available in real-time as a virtual sensor in an IoT network [148,357,358].

## 5. The Fused Twins Concept

DTs require visualisation to unfold their potential. Naturally, it is the Virtual Environment [1,2,101] of a DT through which information be accessed. To make sense of the different forms of visualisations, we use the Reality-Virtuality-Continuum [359], see Figure 14 to classify a broad range of human interface devices.

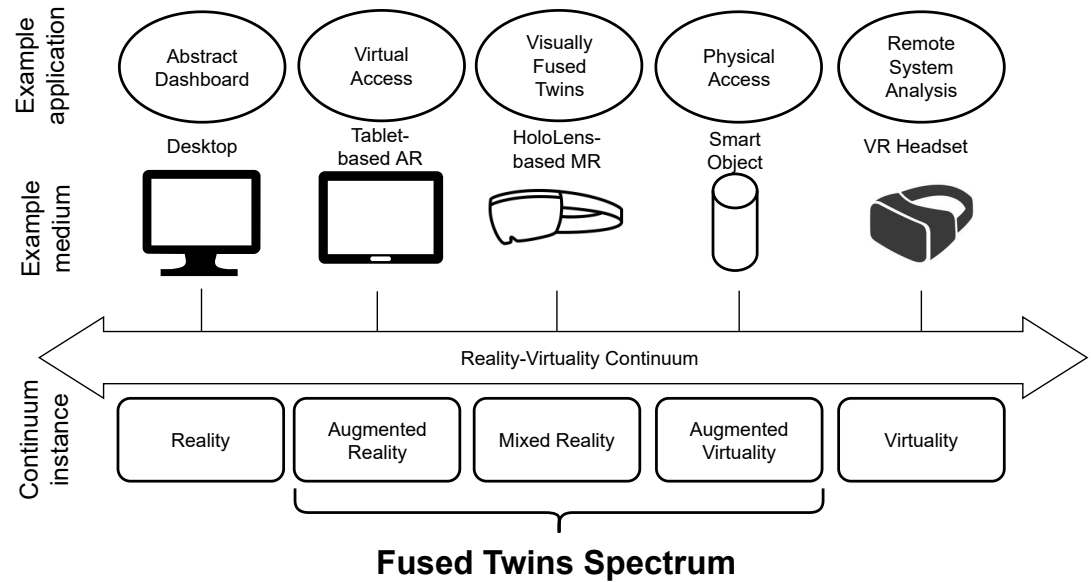

**Figure 14. Devices to access Digital Twins on the Reality-Virtuality-Continuum [359].** On the Continuum, FTs span instances of Extended Reality (XR) input modalities and media from Augmented Reality (AR) via Mixed Reality (MR) to Augmented Virtuality (AV). Typical media include tablets, phones but also holographic displays and smart objects. Reality-embedded access to DT focuses on abstract dashboards whereas Virtuality-embedded access focuses on remote analysis of the DT. The FTs Spectrum covers direct interaction with the PT that is fused with augmentations from the DT either displayed via AR on tablet, MR on HoloLens or haptically through AV smart objects. Generated with <http://draw.io>.

Commonly used implementations of DTs make use of visualisation types on both ends of the continuum which includes the Dashboard and Virtual Reality (VR)-based digital models. Dashboards [360] reside on the Reality end of the spectrum because they display information independent of the physical world on screens which display numeric visualisations<sup>2</sup>. The visualisation is not embedded directly in reality and is accessed in a non-immersive context. On the other end of the spectrum, remote monitoring [361,362] is located in the Virtuality end and can be implemented both as VR and non-local AR. The information usually has a digital model that is displayed in the virtual space with no direct relations to the physical space in which the data is consumed.

The FTs concept captures the situation where the DT is queried from within the PT allowing for a fused *in situ* representation. A media is used to connect the PT with the DT through the display of Situated Analytics [100]. Possible media range from tablet-based (AR) and HoloLens (MR) to SOs (AV). AR and MR devices can be used to overlay immersive

<sup>2</sup> Note that reality here is the continuum instance in which the user is located and not the medium through with the application is experienced.

analytics of the PT with the DT. In contrast, SOs [12] are interactables in the environment that allow users to manipulate the state of both the PT and the DT.

Despite the similarities, FTs are different from situated visualisations [5]. FTs require a fully-fleshed DT behind the situated visualisation that includes all five types of environments and the ability to compose the underlying DT with other DTs that may be spatially or logically connected. FTs use the situated visualisation as an entry point to interact with all systems that are connected to that particular point in the PT to provide access to the whole PT through the DT. In contrast, many situated visualisations focus on local applications such as smart switches for IoT devices [363]. However, at first sight, the situated visualisation is often indistinguishable from FTs for end users. Nonetheless, continuous interaction with the tool eventually reveals the limited functionality. Thus, any situated visualisation can be expanded to implement the FTs paradigm by integrating it into a DT model.

This section will outline the DT Requirements to implement the FTs paradigm. The particular features of the main environments are discussed, but the Data Environment and the Connection Environment are not discussed in detail. The Connection Environment has not been implemented as interoperability between DTs or their components is as of yet uncharted territory. Consequently, the Data Environment is usually a proprietary implementation that requires no further discussion here. An open standard for DTs would open up the research on the Connection Environment and the Data Environment. Lastly, while discussing the Virtual Environment, we reflect upon current situated visualisations that are close to implement the full FTs concept.

### 5.1. *The Physical Environment of the Digital Twin*

The Physical Environment encapsulates the infrastructure to cast the digital shadow [151] of the PT (see Figure 8) into the Data Environment. When assembling an IoT or remote sensing system for a DT, it is important to be able to determine the dimensions which matter most for the functioning of the DT and choose an architecture accordingly. Most research on architecture has been done in the context of IoT. However, as the time progressed, architectures focused more on how to deal with the data and consequently today, these architectures are also used in DT cognates and DTs themselves.

International institutions have developed IoT reference architectures [365–367]. Architectures are usually presented as layers. However, multiple architectures exist with a similar number of layers but different functional goals. Going into detail of how each layer is supposed to work sometimes contradicts other architectures with the same number of layers (see Figure 15). On the one hand, there is no unified architecture and due to the sheer endless number of application scenarios across different branches of research. On the other hand, architectures are sometimes compatible, and we provide a mapping of the different components in Figure 15. These architectures may appear as fully-fleshed DTs at first glance but on closer inspection will reveal themselves to be mostly concerned with the Physical Environment and the Data Environment. However, depending on the overall goal of the architecture, the upper layers may actually contain features of the Analytical Environment and the Virtual Environment. IoT architectures are the basis for most current DT applications and will probably morph into fully-fleshed DTs in the coming decade.

Architectures aim to be somewhat self-explanatory and ideally each layer covers exactly one functionality on transforming the data. Realistically, layers help conceptually to assign tasks to different parts of the real system. However, most implementations rely on a messier, less clean interaction that takes place between the components. To choose the layer, it is typical to consider aspects of security, energy consumption, data collection density (spatial and temporal), maintenance, availability (real time vs long-term evaluation), interactivity (explicit reaction versus implicit reaction), and heterogeneity [42,177,190,238]. Lastly, management



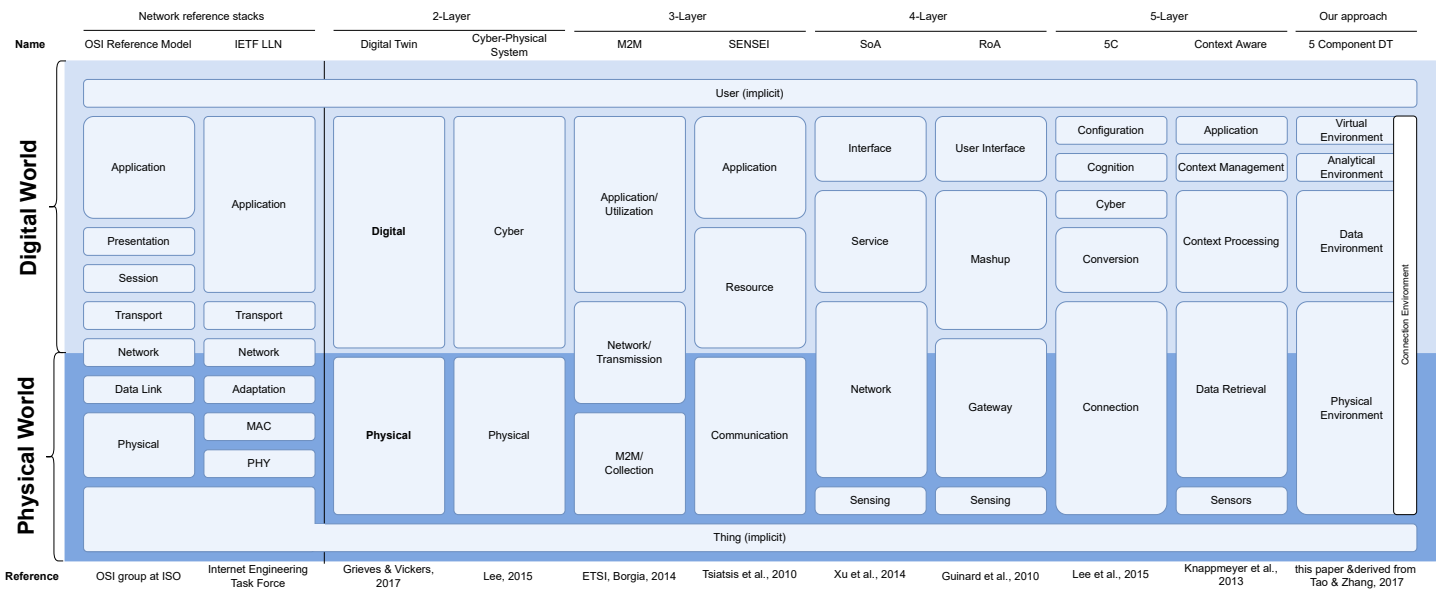

**Figure 15. Comparison of Digital Twin Architectures.** Data flows from the bottom (Thing) to the top (User). The functionality of each layer is displayed in comparison to other architectures where possible by spawning each layer vertically such that it contains all functionality that similar layers in other architectures provide. For example, Presentation and Session in the OSI Reference Model are subsumed in Application in the IETF LLN Stack. The labels at the top provide the name of the models, and the labels at the bottom references the origin of the respective model. *From left to right:* OSI Reference Model, Variation of IETF Internet Model [315], Digital Twin [7], CPS [233], ETSI M2M [164] & SENSEI [364], SoA [153], 5C [154], and Context Aware [155]. Generally, management and security columns spawning all layers are not shown. Our own definition is mapped to these architectures in the last column. Generated with <http://draw.io>.

of the infrastructure and security concerns relate to every layer and are often represented as vertical columns to the side of the layers [47,164,246], but they are not shown in Figure 15 for brevity. When comparing this to our DT design, it is those management layers that map to the Connection Environment that would ultimately allow to compose DTs given appropriate permissions.

While the number of architectures is infinite, we will focus on a few of the most common approaches in more detail here. The simplest architecture divides the world into two layers, the Physical layer and some abstract layer such as Digital [7] or Cyber [233,235]. Mapping these realms to our DT model, the Physical covers the Physical Environments and the Digital/Cyber covers the Data, Analytical, and Virtual Environments. The Connection Environment maps most closely to the Management and Security columns in previous architectures but the focus is more on interoperability while also satisfying management and security requirements. This architecture has no representation of how data is collected, transported, transformed, and attributed in the DT. Nonetheless, it is a powerful vision that is easily understood despite the technological intricacies necessary to make such a vision possible. This perspective strengthens ontological approaches to describe processes and qualities of objects in such a way that allows for interaction. This concept is often applied in Industrial IoT (IIoT) where it is usually used as an end-user perspective on a Service-Oriented Architecture (SOA) [153].

For practical implementations, often a three-layer architecture is used that describes the detailed work in the middle [164,364]. These architectures are already able to address how the DT arises and as such a third layer is brought to attention: the middleware. The physical world is sensed in a perception layer mapping to the Physical Environment. Then, the data is structured into semantically meaningful units in the middleware layer mapping to the Data Environment and the Analytical Environment and finally presented to end-users in

an application layer mapping to the Virtual Environment. This architecture belongs to the earlier models and is focused more on the process of how to create basic IoT infrastructure. The perception layer describes the process of data acquisition usually provided from sensors, actuators, and tags. The middleware layer aggregates the data and provides APIs to access necessary information. When comparing the three-layer model to the two-layer model, middleware is the hidden layer that converts the real world's PT into its DT. However, most real systems stop short of complex analysis based on simulation and often limit itself to present raw data or aggregates.

The application layer offers useful services on top of the data. In a sense, those services are offered in the Virtual Environment of the DT (see Figure 2), but they heavily rely on the Analytical Environment to produce interesting services. Naming conventions for the three layers vary, but their basic functionality remains the same such as in ETSI M2M [164], SEN-SEI [364]. Additional layers always focus on very specific features and mostly subdivided the Application layer for Service-oriented Architecture [153], Resource-oriented Architecture [161] business applications [154], or Context Awareness [155].

### 5.2. The Analytical Environment of the Digital Twin - Models and Services

The Analytical Environment is often considered to be the DT itself [151] because it simulates the PTs behaviour. However, throughout this review paper, we have outlined more specific tasks for the Analytical Environment such as running simulations, producing aggregations, and providing services. We also have elaborated why a DT is more than just a simple simulation with real-world data. Nonetheless, it is the Analytical Environment that usually gives DTs and their Cognates the Smart label such as in Smart City.

The word *smart* generally allures to the superiority of a (connected, digitised) Thing compared to its dumb (unconnected, analogue) counterpart. Since connectivity and digitalisation on their own do not make anything *smart* but only provide accessibility, the smartness implies easy interaction with the Thing, new insights into the Thing, and new applications of the Thing. To attain any of these goals, models are required to represent reality, predict the future, and monitor ongoing processes. For DTs, this means that services [368,369] are provided on top of the data through the Analytical Environment to enrich a PT's functionality and simplify interactions. In general, most Things will require a DT to become smart.

However, the term *smart* has been miss-used. The previous description of *smart* is applicable to any meaningful service. The use of "*Smart*" as a prefix for services has proliferated to the point where it has become superfluous. Following the above argument, the prefix has been attached to anything that could have a DT or has implemented features that are indistinguishable from a DT. In the simplest case, a Smart Object provides Awareness, Representation, Interactivity, and Identity [12,257]. Smart Objects are concrete implementations of a DT (and even the FTs paradigm), but they limit the Thing to be a small-scale object with a fixed use. Smart Objects are also a form of data physicalisation [124] that provides the opportunity to interact with data beyond a visual medium.

As objects increase in size and become places, the terminology adapts to Smart Environment [320], Smart Home [370,371], Smart Office [371], Smart Museum [372], Smart City [9,15,48,198,199,253,323,370,373–375] and even Smart Regions [376] and Smart Communities [247,377]. Conceptually, these Smart Places [378] do not differ from Smart Objects [12] but only generalise it to sets of Things. This scaling aligns with the composability of DTs and allows for these concepts to be nested.

However, there is a difference to be made between physical Things and non-physical Things such as processes. The Thing in this context is a non-physical entity but interacts with physical entities in a defined way allowing to define smart processes such as Smart

Governance [379], Smart Manufacturing [380,381], Smart Construction [382], Smart Health Care Services [383], Smart Mobility [384], and Smart Experiences (for touristic activities)[385].

With everything labelled smart, it becomes more meaningful to talk about the kind of actions a Smart Thing can provide. Interestingly, it is these interactions that are also sought after in the immersive analytics context [68]. We locate actions on a scale of how independently they can react to external input:

1. Sensing: Only produce data
2. Reacting: Use threshold *on collected data* to trigger action
3. Interacting: Use *additional input* beyond collected data to change behaviour
4. Analysing: Use a *model to interpret collected data* when choosing actions
5. Proposing: Use a *decision model* to propose actions based on data models
6. Deciding: *Autonomously perform* all necessary action to interact with data.

The action space of Smart Things is constantly expanded and we cannot enumerate everything here. However, all of these developments can be understood as the Analytical Environment of a DT. Research has covered many approaches to provide the Analytical Environment needed to transform data into insights (see Table 5).

**Table 5.** Research Areas for Digital Twin Analytics

Domain	Description	Review
Ontologies	Make semantic sense of the data and produce knowledge and context	[155,224–226,386–388]
Middleware	Infrastructure to identify, process, store, secure and present information	[227–229,389,390]
Data preprocessing	Data aggregation and data fusion	[303,391–397]
Data mining	Cloud-based Big Data analysis on unstructured data	[398–405]
AI&ML	Machine learning and deep learning	[395,406–408]
Blockchain	Security, trust, and privacy through smart contracts	[409–413]
HCI	Human-Computer Interaction for improved access	[70,85,86,259,414–416]
ABM	Agent-based modelling Objects	[417–420]

### 5.3. The Virtual Environment of the Digital Twin - Access, Interaction and Representation through the Fused Twins Paradigm

The last environment we discuss provides the Human-Computer Interaction [421,422] with the DT. When implementing the FTs paradigm for a DT, the main focus lies on AR interactions with the DT. AR is only beginning to arrive in the world of SOs, the IoT, remote sensing, and DTs but has already been accepted as a crucial feature in the near future [423]. AR is of interest for FTs as it explicitly supports embodied interaction: interaction that is not agnostic to its physical and social context [74,80]. AR can also reduce negative split-attention effects [118,120], and appropriate visualisations of data can lower cognitive load [73] and enhance cognition [72]. The expectation is that AR will offer a new avenue to simplify interaction with SOs, the IoT, and DTs [3]. The FTs paradigm is a formalisation of the interaction between AR and DTs in a situated context.

Because the combination of technologies is only emergent now, most published material towards this end is either a prototype [3,101,363,424,425] or a proposal for future research directions [426–429]. The main reason is that applying AR on top of the already complex combination of SO, IoT, remote sensing, and DT stacks requires many software systems to run smoothly that are currently only being prototyped.

The Fusion of the the digital representation and the physical entity lies at the core of the FTs paradigm [3] but also of the more general Situated Analytics [5]. Interestingly, other research on the topic of Situated Analytics has often implemented FTs to some degree

but without the explicit mentioning of the DT aspect [363,424,425]. A notable exception is the ‘Corsican Twins’ [101] implementation of a FTs platform with an explicit DT powering the Situated Analytics. Short papers on future research directions in Situated Analytics clearly point towards FTs-like implementations [426–429]. We summarise ongoing and future research that is already covering a wide variety of topics (see Table 6). Some of the research explicitly mentioned the DT Approach or an Situated Analytics approach but often simply uses the available technology to demonstrate that their problem can be addressed [427,429,430], implicitly developing a DT and applying Situated Analytics.

**Table 6.** Recent and Ongoing Research Applying the Fused Twins Paradigm

Application Type	Year	Environments				
		Physical	Data	Analytical	Virtual	Connection
Infrastructure Management [431]	2009	*	✓	*	✓	-
City Information [22]	2009	*	✓	✓	✓	-
History [430]	2013	*	✓	-	✓	-
City Information (concept) [432]	2014	*	*	*	*	*
Shopping [433]	2015	*	✓	✓	*	-
IoT device interaction [424]	2016	✓	✓	-	✓	*
City Information [434]	2016	*	✓	*	✓	-
Shopping [435]	2018	*	✓	✓	*	-
Smart Campus [436]	2018	✓	✓	✓	✓	✓
Evacuation [437]	2018	*	-	-	✓	-
Medicine [438]	2018	✓	✓	-	✓	-
Facility Management [439]	2018	✓	✓	✓	✓	-
Rehabilitation [440]	2019	✓	✓	*	✓	-
IoT device visualisation [425]	2019	✓	-	-	✓	-
Seat Selection [441]	2020	*	✓	✓	*	-
Equipment Maintenance [442]	2020	*	✓	-	✓	-
In situ visualisation [101]	2020	*	✓	*	✓	*
Education [443]	2020	✓	✓	✓	✓	*
Training & Assistance [444]	2020	*	*	-	✓	*
Firefighting [429]	2021	-	-	✓	✓	-
General [3]	2021	✓	✓	✓	✓	*
IoT device interaction [363]	2021	✓	✓	✓	✓	-
General [100]	2022	✓	✓	✓	✓	*

Note:

\* Partially implemented or insufficient information

Since the FTs concept in particular and DT concept in general is not well defined yet, we analysed the literature for traces of it. To construct Table 6, we analysed the papers for the presence of implementations of any of the five components. For the Physical Environment,

we considered it as fully implemented (i.e., we gave it a check-mark [✓] in Table 6) if active sensor data collection was reported, or we considered it as partially implemented (i.e., we gave it a star [\*] in Table 6) if passive sensors or markers were reported (e.g., QR code stickers). For the Data Environment, we considered it fully implemented when explicit data collection and storage was reported (e.g. SQL databases or BIM models), and we accepted partial implementation if data was streamed but not permanently stored. For the Analytical Environment, we considered it fully implemented if there was an element of only analysis, and we considered it partially implemented if simple data transformation were performed. For the Virtual Environment, we considered it fully implemented if some digital model was reported (e.g., 3D models of rooms or machines) or partially implemented if a digital representation could be inferred but was not explicitly reported (e.g., spatial representation of labels). For the Connection Environment, we considered it fully implemented if it was possible to add or compose elements in different environments such as adding new sensors, changing the virtual environment, or using different analysis and partially implemented if it was theoretically extendable or if the reports hinted to extendability of a single component (e.g. adding more sensors).

Across all partial implementations of the FTs paradigm, we find the recurrent theme of how to tightly couple the PT and the DT. All DTs require an effective representation of the PT to convey meaningful information to the user. For the built environment, this commonly involves Building Information Models (BIM) [3,427,429,436,445], or City Information Models (CIM), and Geographic Information System (GIS) [427,432]. In a city context, usually, BIM/CIM is used for the local model, whereas GIS provides a global reference frame. However, if BIM/CIM is not available, remote sensing offers methods to produce placeholder models [439]. Both GIS and BIM/CIM have a long research tradition and have been used in a variety of ways in industry, academia, and governance. It could be argued that they provided DTs before the word was created. However, in the DT literature, a consensus has built up that they rather provide a digital model [151,170] and are at best the basis for a DT.

The reason that these opinions have developed is that BIM/CIM and GIS are often seen as a rather static representation of DTs and that, for dynamism, it is required to continuously measure from sources such as IoT [3,424,427,429]. These measurements are often called the Digital Shadow [151,170]. Additionally, the raw data provided by sensors is often classified as Big Data [446,447]. Visualising the data becomes nearly impossible without analytical tools. This highlights the strong interaction between the Analytical Environment and the Virtual Environment. At the same time, a DT is characterised by the bi-directional interaction between the PT and DT. Therefore, there is an expectation for actuators [448] to be able to be triggered from within the Virtual Environment to implement the full functionality of a DT.

Beyond an accurate model, data acquisition, and actions, FTs require a mapping between the virtual world and the physical world. Many approaches are available, and they commonly identify features in the physical world that can be used as anchors for the virtual world. These location services are based on different technologies such as Bluetooth-based [363], image-marker-based [101], vision-based [3,424], or signal-based [425]. Consequently, it is possible to display content in the Virtual Environment as an overlay in physical world. Depending on the medium, it is possible to interact with the augmented content through poses, gestures, mid-air interfaces, tangibles, touch, voice, face, or gaze [449–451]. Immersive and Situated Analytics [5,68] provide the research field in which most of the visualisations that will be used in FTs will be developed.

Implementing FTs requires some expansion of an existing DT. In the Virtual Environment, services for the digital model, the Human-Computer Interaction, and the location model must be integrated to be able to effectively display the measurements from the IoT and remote sensing in situ. The services first locate data in relation to the BIM/CIM [436,445] and then

locate the BIM/CIM in the physical world through Computer Vision and GIS [452]. The result is displayed in AR (see Figure 16) and offers Situated Analytics to the observer.

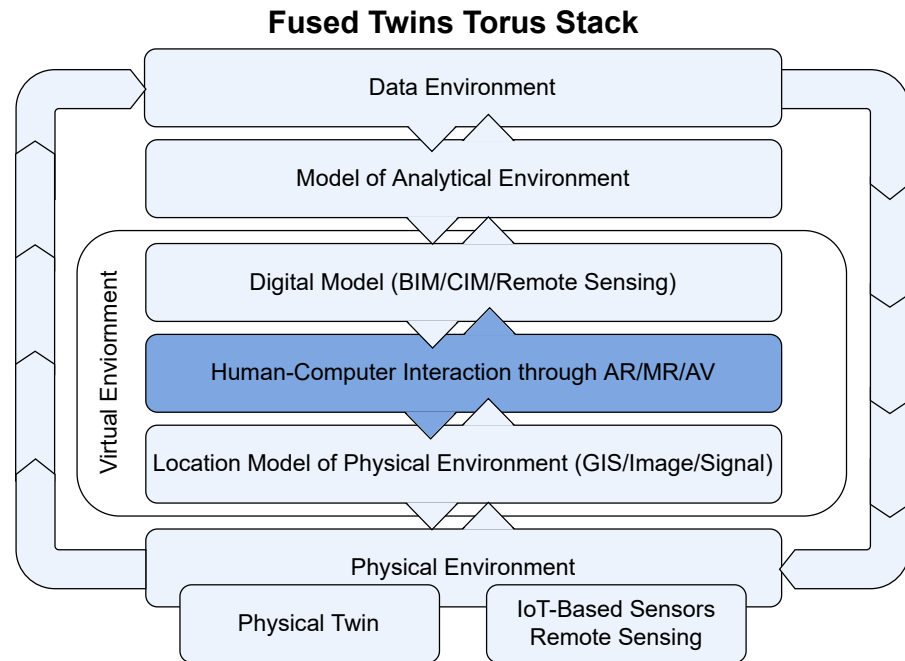

**Figure 16. Fused Twins Torus Stack.** Generalised technology stack for the FTs Paradigm based on [3]. The stack implements a full DT and expands the Virtual Environment to accommodate the FTs. Data flow is shown through the arrows. The stack becomes a torus because the chain of technologies and environments requires circular links of the data. Changes to a DT in the Virtual Environment flow back to the PT through the Data Environment. Generated with <http://draw.io>.

## 6. Discussion

To understand FTs, we have reviewed three distinct but connected literatures. First, this review has focused heavily on how to understand DTs today. The fuzziness around their definition has contributed to the continued vagueness of nearly any ICT being labelled or associated with IoT and DTs. However, with the rising practicability of DTs, no aspect of life will be beyond digitalisation for good and bad. Second, we looked at AR technology as a mean to interact with information and Situated Analytics in particular to cover the interaction with a DT in situ of its PT. This combination is forming the basis to fuse the twins. Third, we explored the tightly connected topic of Smart Cities which often has been a canvas for testing ICT, IoT, DT, and AR applications. We expect the FTs concept to be applied often in this context, even under a different name or no name at all. We have enumerated a large number of FTs applications that partially qualify already today to give an idea of what is to come.

### 6.1. Smart Cities Discussion

Smart Cities are still a far way from being smart. In particular, because most “smart services” are not accessible. DTs offer an organisational paradigm that could make the complex Analytical Environment of cities accessible by flattening the hierarchy from the user perspective. The DT abstracts the heterogeneous technological structure of a city into semantically meaningful units that can be queried for information extracted from the underlying networks. At the same time, the DT also offers an opportunity to overcome the heterogeneity



of sources from IoT to remote sensing without loss of accuracy. Lastly, DTs building on top of heterogeneous sources can represent abstract concepts that have no physical counterpart such as the livability and sustainability of a city [453] or the spatial movement of traffic jams [251].

A fully implemented DT would impact the management, planning, and use of a city. It would allow its economy to become more efficient, markets to be more transparent, processes to be explorable and problems possibly to be more addressable. If a DT of a city is made accessible to the general public, it could even serve as a participatory tool and integrate the city's population. At the same time, concerns of privacy and security won't be easily resolved and a delicate balance between gains and losses has to be struck to realise DTs of cities.

### 6.2. *Situated Analytics Discussion*

AR combines real and virtual elements registered in three dimensions and provides interaction in real-time. Despite decades of development, immersive analytics are still in their infancy, and no standard user interfaces have been established [125,454]. Recent reviews have further found that, for Situated Analytics, there is still a lack of an overarching definition, data representation is not unified, and the target audience is not defined [125]. Broad adoption is only now within reach, and the future will bring many new developments.

Interestingly, the description of how to assemble a Situated Analytics system maps closely to our layout of a DT (see Figure 7). There is a synergy between AR and the FTs concept: the FTs concept offers one of the most promising applications of AR, while AR supports an implementation of FTs that reduces split-attention effects and cognitive load. In this context, the FTs paradigm combining a DT of Smart Cities with Situated Analytics in AR integrates the physical and social aspects of the DT and thus aligns with the theories of embodied interaction, embodied cognition, situated cognition, and socially situated cognition [74,104–106]. Therefore, we argue that the FTs concept may become the largest application of Situated Analytics to be seen, used, and even embodied, by most people on the planet.

### 6.3. *Digital Twins Discussion*

We have reviewed the history of the DT to disambiguate the concept from its cognates. There is a fine line between DTs and CPSs, M2M, WSAWs, SOs, Ubiquitous Computing, IoT, Computation-on-the-wire, and Remote Sensing. In the context of this review, we have shown that most cognates are actually underlying technological approaches or perspectives that constitute components of the DT. The sole exception is a CPS which is a more general approach with the DT being a specialised instance thereof. We believe that DTs have the potential to subsume current cognates similar to how the IoT has been previously considered the most encompassing term in this area. At the same time, each cognate carries an important meaning that is worth maintaining, and we strongly recommend to understand these differences in order to gain a deeper understanding of DTs.

Most DTs “in the wild” are prototypes that were created as novel approaches to particular problems but whose theoretical background is underdeveloped. Indeed, DTs lack theoretisation beyond the assembly of the system. This is beginning to change with the theoretical work of [Tao et al.](#) that first developed a more sound differentiation of DT components. We follow the initial ideas from [Tao and Zhang](#) but diverge in some details. We generalise the theoretisation into five general components (see Figure 2) that we rename the Physical, Data, Analytical, Virtual, and Connection environments of the DT. Ideally, these environments work in isolation and are interoperable to enable the composition of DTs on the level of components as well as nesting. Furthermore, our definition covers most DTs and DT-like applications by assuming partial or implicit implementations of its components. Throughout this review, we have gathered evidence that cognates, other DTs models, Smart Cities, and even Situated Analytics have theoretical correspondences to the components in our DT model.

At the same time, it is difficult to assemble the different environments. The servicisation of IoT has provided an interesting foundation upon which DTs could be quickly assembled with very little overhead. However, Iaas, PaaS, and SaaS are not sufficiently separate in the real world and, under current implementations, would require a Connection Environment that leans towards a hypervisor to compensate for the unreliable interfaces between services. It would be preferable to develop DTs and their components in a more standardised way via isolated and interoperable environments. If Iaas, PaaS, and SaaS were optimised to strictly map to DT components, then DT components “as a service” could democratise the use of DTs by enabling people to quickly bring DT services together. Two open questions that remain are whether the services should be provided in a centralised or decentralised manner and whether the services are provided as a government service or a market product. These services could be more accessible with an open standard for DTs that clearly define how the different components interact.

#### 6.4. Fused Twins Discussion

Without appropriate Human-Computer Interaction, the data in the DT will remain insurmountably complex and thus incomprehensible. The composability of DTs underpinned by interoperable IoT and remote sensing will enable a smoother interaction between people and the environment. In this context, the FTs concept will allow for an intuitive interface to access data, information, knowledge, and understanding where it is most needed and useful. The FTs Paradigm attains this with AR/MR/AV interaction between the DT and the PT to identify opportunities for simple interactions on the complex data *in situ* where the data is generated and collected. It is paramount to align the user interfaces, data formats, general interoperability, and creative services that eventually converge towards real Smart Cities for its users.

The idea underlying FTs has been around for some time, albeit under a different or no specific name. DTs and their cognates Ambient Intelligence and Smart Objects, as well as sometimes the more general Things, can all be understood as different embodied FTs. At the same time, FTs and Situated Analytics are very similar, which opens the question of whether a new term adds clarification. We do believe that a new term is necessary because we are currently observing the confluence of two topics, and the new terms expand beyond each individual conceptualisation. These two topics are the aforementioned research in AR that does not necessarily rely on DTs (but may possibly implement FTs without mentioning it) and the expanding applications of DTs in nearly every research area and field. The necessity to visualise the DT, and the capability to do it in augmented space rather than on a display, ushers in a new era in which data can be made visually and spatially accessible at the time of creation and across its consumption. FTs play a special role in this context where the data is fused to its spatial context which differs from classical AR that merely uses the real world space as an empty canvas devoid of any context (in most cases).

FTs are not unique to Smart Cities, but they are especially applicable in Smart Cities. Some application areas for FTs include healthcare and industry. For example, in healthcare, human DTs have been proposed to improve individual diagnosis and care. Monitoring patients with FTs allow practitioners to locate medically relevant information on the human body. This may be especially helpful in the context of surgery during which representations of bones and other tissues may be superimposed to facilitate the surgeon’s decision-making. In an industrial context, the inner workings of machines can be overlaid onto the real machines and augmented with analytical information. While healthcare and industrial application are most useful for specialists, FTs in a Smart Cities context may be an accessible form of FTs for the average citizen. For example, the augmented reality maps from Google already embed navigation information in the physical city and arguably employ a DT in the background, making it a

simple and accessible example of FTs. Similarly, in the context of tourism, museums have created DTs of specific exhibits but could be expanded to include the entire exhibition to create an FTs. In the future, FTs could also be expanded to communicate city planning initiatives to the public.

## 7. Conclusion

In this review paper, the relevant technologies and terminology behind the FTs concept for interacting with the DT of Smart Cities have been presented. Suitable examples of FTs applications across different literatures have been highlighted (see Table 6). Nonetheless, a stable and applicable out-of-the-box solution to fulfil the promised FTs for Smart Cities remains to be developed. DTs are also remain to be well-specified, which may cause delays in developing FTs. Here, we provided a thorough review of DTs and their cognates to address open points and a concrete definition that can be applied in retrospect to nearly all DTs. Compared to previous research that employed dashboards and other interfaces for Non-situated Analytics, FTs represent a special application of the Virtual Environment of a DT to provide Situated Analytics. The key technologies behind the FTs Paradigm for DTs are IoT, remote sensing, BIM/CIM, GIS, and Location services. The IoT, remote sensing, BIM/CIM, and GIS are used to assemble a DT and provide analytics, and Location services are used to place the Situated Analytics in the PT. Each of these technologies on its own is well-developed, but only now are they being combined into prototypes that can be classified as FTs. While many researchers have theorised about similar systems that could be built, few FTs full-fledged systems have been implemented. Given the plurality of fields that have converged on this general idea, we expect that the FTs paradigm will be a common theme in future technologies and may eventually be as common as a smartphone today.

**Author Contributions:** Conceptualisation, J.G.; methodology, J.G.; validation, J.G., T.T.; investigation, J.G., L.A., M.M., J.C.; resources, J.G., C.H., V.S., R.S.; writing—original draft preparation, J.G.; writing—review and editing, J.G., T.T., L.A., J.C., M.M., V.S., R.S., C.H.; visualisation, J.G., M. M., J.C.; supervision, V.S., C.H., R.S; project administration, J.G., V.S., C.H.; funding acquisition, T.T., V.S., C.H., J.G. All authors have read and agreed to the published version of the manuscript.

**Funding:** This research was funded by ETH Zurich grant number ETH-15 16-2 and J.G. was supported by an ETH Zurich Doc.Mobility Fellowship.

**Institutional Review Board Statement:** Not applicable

**Informed Consent Statement:** Not applicable

**Acknowledgments:** The authors thank Johanna Beyer and Zhu-Tian Chen for the feedback on the AR section. All diagrams were generated with templates from <http://draw.io>. And don't forget your towel.

**Conflicts of Interest:** The authors declare no conflict of interest.

## Abbreviations

The following abbreviations are used in this manuscript:

IoT	Internet of Things
DT	Digital Twin
PT	Physical Twin
FTs	Fused Twins
XR	Extended Reality
CPS	Cyber-Physical System
UC	Ubiquitous Computing
SO	Smart Object
WSN	Wireless Sensor Network
SN	Sensor Network
SAN	Sensor and Actuator Network
WSAN	Wireless Sensor and Actuator Networks
MR	Mixed Reality
AR	Augmented Reality
VR	Virtual Reality
AV	Augmented Virtuality
IaaS	Infrastructure as a Service
PaaS	Platform as a Service
SaaS	Software as a Service
SenaaS	Sensing as a Services
SemaaS	Semantics as a Service
RaaS	Robots as a Service
RSaaS	Remote Sensing as a Service
RFID	Radio Frequency Identification
OS	Operating System
ICT	Information and Communication Technologies
M2M	Machine-to-Machine
BAN	Body Area Networks
PAN	Personal Area Networks
LAN	Local Area Networks
WAN	Wide Area Networks
LPWAN	Low Power Wide Area Networks
BIM	Building Information Model
CIM	City Information Model
GIS	Geographic Information System
UAV	Unmanned Aerial Vehicles

## References

1. Grübel, J.; Thrash, T.; H elal, D.; Sumner, R.W.; H olscher, C.; Schinazi, V.R. The Feasibility of Dense Indoor LoRaWAN Towards Passively Sensing Human Presence. 2021 IEEE International Conference on Pervasive Computing and Communications (PerCom), 2021, pp. 1–11. doi:10.1109/PERCOM50583.2021.9439137.
2. Gr ubel, J.; Weibel, R.; Jiang, M.H.; H olscher, C.; Hackman, D.A.; Schinazi, V.R. EVE: A Framework for Experiments in Virtual Environments. In *Spatial Cogn. X*; Springer: Heidelberg, Germany, 2016; pp. 159–176.
3. Gr ubel, J.; Gath-Morad, M.; Aguilar, L.; Thrash, T.; Sumner, R.W.; H olscher, C.; Schinazi, V.R. Fused Twins: A Cognitive Approach to Augmented Reality Media Architecture. MAB '20: Proceedings of the 5th Media Architecture Biennale Conference, 2021.
4. Speicher, M.; Hall, B.D.; Nebeling, M. What is mixed reality? Proceedings of the 2019 CHI conference on human factors in computing systems, 2019, pp. 1–15.
5. Thomas, B.H.; Welch, G.F.; Dragicevic, P.; Elmqvist, N.; Irani, P.; Jansen, Y.; Schmalstieg, D.; Tabard, A.; ElSayed, N.A.; Smith, R.T.; others. Situated Analytics. *Immersive analytics* **2018**, *11190*, 185–220.
6. Grieves, M. Digital twin: manufacturing excellence through virtual factory replication. *White paper* **2014**.
7. Grieves, M.; Vickers, J. Digital twin: Mitigating unpredictable, undesirable emergent behavior in complex systems. In *Transdisciplinary Perspectives on Complex Systems*; Springer, 2017; pp. 85–113.
8. Deakin, M.; Al Waer, H. From intelligent to smart cities. *Intelligent Buildings International* **2011**, *3*, 140–152.

9. Su, K.; Li, J.; Fu, H. Smart city and the applications. *Electronics, Communications and Control (ICECC), Proceedings of the 2011 International Conference on*. IEEE, 2011, pp. 1028–1031.
10. Hung, M. Leading the IoT, Gartner insights on how to lead in a connected world. Technical report, Gartner Research, 2017.
11. Deng, T.; Zhang, K.; Shen, Z.J.M. A systematic review of a digital twin city: A new pattern of urban governance toward smart cities. *Journal of Management Science and Engineering* **2021**, *6*, 125–134.
12. Sánchez López, T.; Ranasinghe, D.C.; Harrison, M.; McFarlane, D. Adding sense to the Internet of Things. *Personal and Ubiquitous Computing* **2012**, *16*, 291–308.
13. Tao, F.; Zhang, H.; Liu, A.; Nee, A. Digital Twin in Industry: State-of-the-Art. *IEEE Transactions on Industrial Informatics* **2018**.
14. Batty, M. Digital twins. *Environment and Planning B* **2018**, *45*, 817–820.
15. Kaur, M.J.; Mishra, V.P.; Maheshwari, P., The Convergence of Digital Twin, IoT, and Machine Learning: Transforming Data into Action. In *Digital Twin Technologies and Smart Cities*; Springer International Publishing: Cham, 2020; pp. 3–17. doi:10.1007/978-3-030-18732-3\_1.
16. Melgar, L.E.A.; Lalith, M.; Hori, M.; Ichimura, T.; Tanaka, S. A scalable workbench for large urban area simulations, comprised of resources for behavioural models, interactions and dynamic environments. *International Conference on Principles and Practice of Multi-Agent Systems*. Springer, 2014, pp. 166–181.
17. Jacob, S.; Aguilar, L.; Wijerathne, L.; Hori, M.; Ichimura, T.; Tanaka, S. Agent based modeling and simulation of tsunami triggered mass evacuation considering changes of environment due to earthquake and inundation. *Proceedings of the Civil Society A2 (Applied mechanics)* **2014**, *70*, I\_671–I\_680.
18. Aguilar, L.; Lalith, M.; Ichimura, T.; Hori, M. On the performance and scalability of an HPC enhanced multi agent system based evacuation simulator. *Procedia Computer Science* **2017**, *108*, 937–947.
19. Aguilar, L.; Wijerathne, L.; Jacob, S.; Hori, M.; Ichimura, T. Mass evacuation simulation considering detailed models: behavioral profiles, environmental effects, and mixed-mode evacuation. *Asia Pacific Management Review* **2019**, *24*, 114–123.
20. Are digital twins the future of urban planning? <https://www.smartcitiesdive.com/news/are-digital-twins-the-future-of-urban-planning/609232/>. Accessed: 2022-09-20.
21. Lock, O.; Bednarz, T.; Pettit, C. HoloCity – Exploring the Use of Augmented Reality Cityscapes for Collaborative Understanding of High-Volume Urban Sensor Data. The 17th International Conference on Virtual-Reality Continuum and Its Applications in Industry; Association for Computing Machinery: New York, NY, USA, 2019; VRCAI '19. doi:10.1145/3359997.3365734.
22. White, S.; Feiner, S. SiteLens: situated visualization techniques for urban site visits. *Proceedings of the SIGCHI conference on human factors in computing systems*, 2009, pp. 1117–1120.
23. Tao, F.; Zhang, M. Digital twin shop-floor: a new shop-floor paradigm towards smart manufacturing. *Ieee Access* **2017**, *5*, 20418–20427.
24. Carroll, S.E. On cognates. *Interlanguage studies bulletin (Utrecht)* **1992**, *8*, 93–119.
25. Tompson, T. Understanding the contextual development of smart city initiatives: A pragmatist methodology. *She Ji: The Journal of Design, Economics, and Innovation* **2017**, *3*, 210–228.
26. Vanolo, A. Smartmentality: The smart city as disciplinary strategy. *Urban studies* **2014**, *51*, 883–898.
27. Mattern, S. A city is not a computer. *Places Journal* **2017**, *18*.
28. Luque-Ayala, A.; Marvin, S. Developing a critical understanding of smart urbanism. In *Handbook of Urban Geography*; Edward Elgar Publishing, 2019.
29. Huyssen, A. *Other cities, other worlds: urban imaginaries in a globalizing age*; Duke University Press, 2008.
30. Newman, P.; Beatley, T.; Boyer, H. *Resilient cities: Responding to peak oil and climate change*; Taylor & Francis, 2009.
31. Haughton, G.; Hunter, C. *Sustainable cities*; Routledge, 2004.
32. Castells, M. *The rise of the network society: The information age: Economy, society, and culture*; Vol. 1, John Wiley & Sons, 2011.
33. Townsend, A.M. *Smart cities: Big data, civic hackers, and the quest for a new utopia*; WW Norton & Company, 2013.
34. Gath-Morad, M.; Schaumann, D.; Zinger, E.; Plaut, P.O.; Kalay, Y.E. How smart is the Smart City? Assessing the impact of ICT on cities. *International Workshop on Agent Based Modelling of Urban Systems*. Springer, 2016, pp. 189–207.
35. Gottmann, J. Megalopolis and antipolis: The telephone and the structure of the city. *The social impact of the telephone* **1977**, pp. 303–317.
36. Toffler, A.; Alvin, T. *The third wave*; Bantam books New York, 1981.
37. Negroponte, N. Being Digital, Vintage Books. London. *Neustadt, RM (1985)'Electronic Politics'*. In Forester, T.(ed.) *The Information Technology* **1995**.
38. Abler, R. What makes cities important. *Bell Telephone Magazine* **1970**, *49*, 10–15.
39. Picon, A. *Smart cities: a spatialised intelligence*; John Wiley & Sons, 2015.
40. Goodchild, M.F. Citizens as sensors: the world of volunteered geography. *GeoJournal* **2007**, *69*, 211–221.
41. Soja, E.W. *Postmodern geographies: The reassertion of space in critical social theory*; Verso, 1989.
42. Flügel, C.; Gehrmann, V. Scientific Workshop 4: Intelligent Objects for the Internet of Things: Internet of Things–Application of Sensor Networks in Logistics. *Constructing Ambient Intelligence* **2009**, pp. 16–26.
43. Dohr, A.; Modre-Oprian, R.; Drobnic, M.; Hayn, D.; Schreier, G. The internet of things for ambient assisted living. *Information Technology: New Generations (ITNG), Proceedings of the 2010 7th International Conference on*. Ieee, 2010, pp. 804–809.

44. Cubo, J.; Nieto, A.; Pimentel, E. A cloud-based Internet of Things platform for ambient assisted living. *Sensors* **2014**, *14*, 14070–14105.
45. Darwish, A.; Hassaniien, A.E. Cyber physical systems design, methodology, and integration: the current status and future outlook. *Journal of Ambient Intelligence and Humanized Computing* **2018**, *9*, 1541–1556.
46. Weiser, M. The Computer for the 21st Century. *Scientific American* **1991**, *265*, 94–105.
47. Atzori, L.; Iera, A.; Morabito, G. The internet of things: A survey. *Computer Networks* **2010**, *54*, 2787–2805.
48. Puiu, D.; Barnaghi, P.; Tönjes, R.; Kümper, D.; Ali, M.I.; Mileo, A.; Parreira, J.X.; Fischer, M.; Koložali, S.; Farajidavar, N.; Others. Citypulse: Large scale data analytics framework for smart cities. *IEEE Access* **2016**, *4*, 1086–1108.
49. Nikitin, K.; Lantsev, N.; Nugaev, A.; Yakovleva, A. Data-driven cities: from concept to applied solutions. *PricewaterhouseCoopers (PwC) <http://docplayer.net/50140321-From-concept-to-applied-solutions-data-driven-cities.html>* **2016**.
50. Westminster City Council. Westminster City Council Annual Parking Review 2013/2014. Technical report, Westminster City Council, 2014.
51. Leleux, C.; Webster, W. Delivering smart governance in a future city: The case of Glasgow. *Media and Communication* **2018**, *6*, 163–174.
52. Sánchez, L.; Gutiérrez, V.; Galache, J.A.; Sotres, P.; Santana, J.R.; Casanueva, J.; Muñoz, L. SmartSantander: Experimentation and service provision in the smart city. 2013 16th International Symposium on Wireless Personal Multimedia Communications (WPMC). IEEE, 2013, pp. 1–6.
53. La Ville de Paris gère ses arbres avec des puces RFID.
54. Botín-Sanabria, D.M.; Mihaita, A.S.; Peimbert-García, R.E.; Ramírez-Moreno, M.A.; Ramírez-Mendoza, R.A.; Lozoya-Santos, J.d.J. Digital Twin Technology Challenges and Applications: A Comprehensive Review. *Remote Sensing* **2022**, *14*, 1335.
55. Bilal, M.; Usmani, R.S.A.; Tayyab, M.; Mahmoud, A.A.; Abdalla, R.M.; Marjani, M.; Pillai, T.R.; Targio Hashem, I.A. Smart cities data: Framework, applications, and challenges. *Handbook of smart cities* **2020**, pp. 1–29.
56. Foth, M. *Handbook of research on urban informatics: the practice and promise of the real-time city: the practice and promise of the real-time city*; IGI Global, 2008.
57. Azuma, R.T. A survey of augmented reality. *Presence: teleoperators & virtual environments* **1997**, *6*, 355–385.
58. Milgram, P.; Takemura, H.; Utsumi, A.; Kishino, F. Augmented reality: A class of displays on the reality-virtuality continuum. Telemanipulator and telepresence technologies. International Society for Optics and Photonics, 1995, Vol. 2351, pp. 282–292.
59. Van Krevelen, D.; Poelman, R. Augmented reality: Technologies, applications, and limitations Vrije Univ. *Amsterdam, Dep. Comput. Sci* **2007**.
60. Grundhöfer, A.; Iwai, D. Recent advances in projection mapping algorithms, hardware and applications. *Computer Graphics Forum*. Wiley Online Library, 2018, Vol. 37, pp. 653–675.
61. Brock, A.M.; Chatain, J.; Park, M.; Fang, T.; Hachet, M.; Landay, J.A.; Cauchard, J.R. Flymap: Interacting with maps projected from a drone. Proceedings of the 7th ACM International Symposium on Pervasive Displays, 2018, pp. 1–9.
62. Carmigniani, J.; Furht, B.; Anisetti, M.; Ceravolo, P.; Damiani, E.; Ivkovic, M. Augmented reality technologies, systems and applications. *Multimedia tools and applications* **2011**, *51*, 341–377.
63. Lavingia, K.; Tanwar, S. Augmented reality and industry 4.0. In *A Roadmap to Industry 4.0: Smart Production, Sharp Business and Sustainable Development*; Springer, 2020; pp. 143–155.
64. Scholz, J.; Smith, A.N. Augmented reality: Designing immersive experiences that maximize consumer engagement. *Business Horizons* **2016**, *59*, 149–161.
65. Stapleton, C.; Hughes, C.; Moshell, M.; Micikevicius, P.; Altman, M. Applying mixed reality to entertainment. *Computer* **2002**, *35*, 122–124.
66. Elmqaddem, N. Augmented reality and virtual reality in education. Myth or reality? *International journal of emerging technologies in learning* **2019**, *14*.
67. Eckert, M.; Volmerg, J.S.; Friedrich, C.M.; others. Augmented reality in medicine: systematic and bibliographic review. *JMIR mHealth and uHealth* **2019**, *7*, e10967.
68. Marriott, K.; Schreiber, F.; Dwyer, T.; Klein, K.; Riche, N.H.; Itoh, T.; Stuerzlinger, W.; Thomas, B.H. *Immersive analytics*; Vol. 11190, Springer, 2018.
69. Dwyer, T.; Marriott, K.; Isenberg, T.; Klein, K.; Riche, N.; Schreiber, F.; Stuerzlinger, W.; Thomas, B.H. Immersive analytics: An introduction. In *Immersive analytics*; Springer, 2018; pp. 1–23.
70. Genay, A.C.S.; Lécuyer, A.; Hachet, M. Being an Avatar" for Real": a Survey on Virtual Embodiment in Augmented Reality. *IEEE Transactions on Visualization and Computer Graphics* **2021**.
71. Gervais, R.; Roo, J.S.; Hachet, M. Tangible viewports: Getting out of flatland in desktop environments. Proceedings of the TEI'16: Tenth International Conference on Tangible, Embedded, and Embodied Interaction, 2016, pp. 176–184.
72. Willett, W.; Aseniero, B.A.; Carpendale, S.; Dragicevic, P.; Jansen, Y.; Oehlberg, L.; Isenberg, P. Superpowers as Inspiration for Visualization. *IEEE TVCG* **2021**, *2021*.
73. Scaife, M.; Rogers, Y. External cognition: how do graphical representations work? *International journal of human-computer studies* **1996**, *45*, 185–213.



74. Dourish, P. *Where the action is: the foundations of embodied interaction*; MIT press, 2004.
75. Kirsh, D. Embodied cognition and the magical future of interaction design. *ACM Transactions on Computer-Human Interaction (TOCHI)* **2013**, *20*, 1–30.
76. Michaels, C.F. Affordances: Four points of debate. *Ecological psychology* **2003**, *15*, 135–148.
77. Gibson, J.J. *The ecological approach to visual perception: classic edition*; Psychology Press, 2014.
78. Norman, D. *The design of everyday things: Revised and expanded edition*; Basic books, 2013.
79. Johnson-Glenberg, M.C.; Megowan-Romanowicz, C. Embodied science and mixed reality: How gesture and motion capture affect physics education. *Cognitive research: principles and implications* **2017**, *2*, 1–28.
80. Gervais, R.; Roo, J.S.; Frey, J.; Hachet, M. Introspectibles: tangible interaction to foster introspection. *arXiv preprint arXiv:1603.04581* **2016**.
81. Gervais, R.; Frey, J.; Gay, A.; Lotte, F.; Hachet, M. Tobe: Tangible out-of-body experience. Proceedings of the TEI'16: Tenth International Conference on Tangible, Embedded, and Embodied Interaction, 2016, pp. 227–235.
82. Frey, J.; Gervais, R.; Fleck, S.; Lotte, F.; Hachet, M. Teegi: tangible EEG interface. Proceedings of the 27th annual ACM symposium on User interface software and technology, 2014, pp. 301–308.
83. Roo, J.S.; Gervais, R.; Frey, J.; Hachet, M. Inner garden: Connecting inner states to a mixed reality sandbox for mindfulness. Proceedings of the 2017 CHI Conference on Human Factors in Computing Systems, 2017, pp. 1459–1470.
84. Spiel, K. The bodies of tei—investigating norms and assumptions in the design of embodied interaction. Proceedings of the Fifteenth International Conference on Tangible, Embedded, and Embodied Interaction, 2021, pp. 1–19.
85. Chatain, J.; Sisserman, D.M.; Reichardt, L.; Fayolle, V.; Kapur, M.; Sumner, R.W.; Zünd, F.; Bermano, A.H. DigiGlo: Exploring the Palm as an Input and Display Mechanism through Digital Gloves. Proceedings of the Annual Symposium on Computer-Human Interaction in Play, 2020, pp. 374–385.
86. Pei, S.; Chen, A.; Lee, J.; Zhang, Y. Hand Interfaces: Using Hands to Imitate Objects in AR/VR for Expressive Interactions. CHI Conference on Human Factors in Computing Systems, 2022, pp. 1–16.
87. Thevin, L.; Brock, A.M. Augmented reality for people with visual impairments: Designing and creating audio-tactile content from existing objects. International Conference on Computers Helping People with Special Needs. Springer, 2018, pp. 193–200.
88. Brulé, E.; Bailly, G.; Brock, A.; Gentès, A.; Jouffrais, C. An exploratory study of the uses of a multisensory map—with visually impaired children. *Multimodal Technologies and Interaction* **2018**, *2*, 36.
89. Albouys-Perrois, J.; Laviole, J.; Briant, C.; Brock, A.M. Towards a multisensory augmented reality map for blind and low vision people: A participatory design approach. Proceedings of the 2018 CHI conference on human factors in computing systems, 2018, pp. 1–14.
90. Melcer, E.F.; Isbister, K. Bridging the Physical Divide: A Design Framework for Embodied Learning Games and Simulations. Proceedings of the 2016 CHI Conference Extended Abstracts on Human Factors in Computing Systems; Association for Computing Machinery: New York, NY, USA, 2016; CHI EA '16, p. 2225–2233. doi:10.1145/2851581.2892455.
91. Ottmar, E.R.; Walkington, C.; Abrahamson, D.; Nathan, M.J.; Harrison, A.; Smith, C. Embodied Mathematical Imagination and Cognition (EMIC) Working Group. *North American Chapter of the International Group for the Psychology of Mathematics Education* **2019**.
92. Chatain, J.; Ramp, V.; Gashaj, V.; Fayolle, V.; Kapur, M.; Sumner, B.; Magnenat, S. Grasping Derivatives: Teaching Mathematics through Embodied Interactions using Tablets and Virtual Reality. *Interaction Design and Children (IDC'22)*, 2022.
93. Mueller, F.; Byrne, R.; Andres, J.; Patibanda, R. Experiencing the body as play. Proceedings of the 2018 CHI Conference on Human Factors in Computing Systems, 2018, pp. 1–13.
94. Höök, K.; Jonsson, M.P.; Ståhl, A.; Mercurio, J. Somaesthetic appreciation design. Proceedings of the 2016 CHI Conference on Human Factors in Computing Systems, 2016, pp. 3131–3142.
95. Hook, K. *Designing with the body: Somaesthetic interaction design*; MIT Press, 2018.
96. Kilteni, K.; Groten, R.; Slater, M. The sense of embodiment in virtual reality. *Presence: Teleoperators and Virtual Environments* **2012**, *21*, 373–387.
97. Nimcharoen, C.; Zollmann, S.; Collins, J.; Regenbrecht, H. Is that me?—Embodiment and body perception with an augmented reality mirror. 2018 IEEE International Symposium on Mixed and Augmented Reality Adjunct (ISMAR-Adjunct). IEEE, 2018, pp. 158–163.
98. Trajkova, M.; Alhakamy, A.; Cafaro, F.; Mallappa, R.; Kankara, S.R. Move your body: Engaging museum visitors with human-data interaction. Proceedings of the 2020 CHI Conference on Human Factors in Computing Systems, 2020, pp. 1–13.
99. Sicat, R.; Li, J.; Choi, J.; Cordeil, M.; Jeong, W.K.; Bach, B.; Pfister, H. DXR: A toolkit for building immersive data visualizations. *IEEE transactions on visualization and computer graphics* **2018**, *25*, 715–725.
100. Fleck, P.; Calepso, A.S.; Hubenschmid, S.; Sedlmair, M.; Schmalstieg, D. RagRug: A Toolkit for Situated Analytics. *IEEE Transactions on Visualization and Computer Graphics* **2022**.
101. Prouzeau, A.; Wang, Y.; Ens, B.; Willett, W.; Dwyer, T. Corsican twin: Authoring in situ augmented reality visualisations in virtual reality. Proceedings of the International Conference on Advanced Visual Interfaces, 2020, pp. 1–9.

102. Hubenschmid, S.; Zagermann, J.; Butscher, S.; Reiterer, H. Stream: Exploring the combination of spatially-aware tablets with augmented reality head-mounted displays for immersive analytics. *Proceedings of the 2021 CHI Conference on Human Factors in Computing Systems*, 2021, pp. 1–14.
103. Willett, W.; Jansen, Y.; Dragicevic, P. Embedded data representations. *IEEE transactions on visualization and computer graphics* **2016**, *23*, 461–470.
104. Wilson, A.D.; Golonka, S. Embodied cognition is not what you think it is. *Frontiers in psychology* **2013**, *4*, 58.
105. Brown, J.S.; Collins, A.; Duguid, P. Situated cognition and the culture of learning. *Educational researcher* **1989**, *18*, 32–42.
106. Smith, E.R.; Semin, G.R., Socially Situated Cognition: Cognition in its Social Context. In *Advances in experimental social psychology*, Vol. 36.; Elsevier Academic Press: San Diego, CA, US, 2004; pp. 53–117. doi:10.1016/S0065-2601(04)36002-8.
107. Merino, L.; Sotomayor-Gómez, B.; Yu, X.; Salgado, R.; Bergel, A.; Sedlmair, M.; Weiskopf, D. Toward agile situated visualization: An exploratory user study. *Extended Abstracts of the 2020 CHI Conference on Human Factors in Computing Systems*, 2020, pp. 1–7.
108. Turan, Z.; Meral, E.; Sahin, I.F. The impact of mobile augmented reality in geography education: achievements, cognitive loads and views of university students. *Journal of Geography in Higher Education* **2018**, *42*, 427–441.
109. İbili, E. Effect of Augmented Reality Environments on Cognitive Load: Pedagogical Effect, Instructional Design, Motivation and Interaction Interfaces. *International Journal of Progressive Education* **2019**, *15*, 42–57.
110. Thees, M.; Kapp, S.; Strzys, M.P.; Beil, F.; Lukowicz, P.; Kuhn, J. Effects of augmented reality on learning and cognitive load in university physics laboratory courses. *Computers in Human Behavior* **2020**, *108*, 106316.
111. Buchner, J.; Buntins, K.; Kerres, M. A systematic map of research characteristics in studies on augmented reality and cognitive load. *Computers and Education Open* **2021**, *2*, 100036.
112. Buchner, J.; Buntins, K.; Kerres, M. The impact of augmented reality on cognitive load and performance: A systematic review. *Journal of Computer Assisted Learning* **2022**, *38*, 285–303.
113. Neumann, U.; Majoros, A. Cognitive, performance, and systems issues for augmented reality applications in manufacturing and maintenance. *Proceedings. IEEE 1998 Virtual Reality Annual International Symposium (Cat. No. 98CB36180)*. IEEE, 1998, pp. 4–11.
114. Bonanni, L.; Lee, C.H.; Selker, T. Attention-based design of augmented reality interfaces. *CHI'05 extended abstracts on Human factors in computing systems*, 2005, pp. 1228–1231.
115. Kim, S.; Dey, A.K. Simulated augmented reality windshield display as a cognitive mapping aid for elder driver navigation. *Proceedings of the SIGCHI Conference on Human Factors in Computing Systems*, 2009, pp. 133–142.
116. Altmeyer, K.; Kapp, S.; Thees, M.; Malone, S.; Kuhn, J.; Brünken, R. The use of augmented reality to foster conceptual knowledge acquisition in STEM laboratory courses—Theoretical background and empirical results. *British Journal of Educational Technology* **2020**, *51*, 611–628.
117. Altmeyer, K.; Malone, S.; Kapp, S.; Barz, M.; Lauer, L.; Thees, M.; Kuhn, J.; Peschel, M.; Sonntag, D.; Brünken, R. The effect of augmented reality on global coherence formation processes during STEM laboratory work in elementary school children. *International Cognitive Load Theory Conference*, 2021.
118. Mayer, R.E.; Moreno, R. A split-attention effect in multimedia learning: Evidence for dual processing systems in working memory. *Journal of educational psychology* **1998**, *90*, 312.
119. Hornecker, E. The to-and-fro of sense making: Supporting users' active indexing in museums. *ACM Transactions on Computer-Human Interaction (TOCHI)* **2016**, *23*, 1–48.
120. Sweller, J.; Ayres, P.; Kalyuga, S. The split-attention effect. In *Cognitive load theory*; Springer, 2011; pp. 111–128.
121. Kapp, S.; Thees, M.; Beil, F.; Weatherby, T.; Burde, J.P.; Wilhelm, T.; Kuhn, J. The Effects of Augmented Reality: A Comparative Study in an Undergraduate Physics Laboratory Course. *CSEDU (2)*, 2020, pp. 197–206.
122. Tang, A.; Owen, C.; Biocca, F.; Mou, W. Comparative effectiveness of augmented reality in object assembly. *Proceedings of the SIGCHI conference on Human factors in computing systems*, 2003, pp. 73–80.
123. Lobo, M.J.; Christophe, S. OPPORTUNITIES AND CHALLENGES FOR AUGMENTED REALITY SITUATED GEOGRAPHICAL VISUALIZATION. *ISPRS Annals of Photogrammetry, Remote Sensing & Spatial Information Sciences* **2020**, *5*.
124. Dragicevic, P.; Jansen, Y.; Vande Moere, A. Data physicalization. *Handbook of Human Computer Interaction* **2020**, pp. 1–51.
125. Bressa, N.; Korsgaard, H.; Tabard, A.; Houben, S.; Vermeulen, J. What's the Situation with Situated Visualization? A Survey and Perspectives on Situatedness. *IEEE Transactions on Visualization and Computer Graphics* **2021**, *28*, 107–117.
126. Lee, E.A. Cyber physical systems: Design challenges. *11th IEEE Symposium on Object Oriented Real-Time Distributed Computing (ISORC)*. IEEE, 2008, pp. 363–369.
127. Rajkumar, R.; Lee, I.; Sha, L.; Stankovic, J. Cyber-physical systems: the next computing revolution. *Design Automation Conference (DAC)*, 2010 47th ACM/IEEE. IEEE, 2010, pp. 731–736.
128. Lee, A.; Lee, K.W.; Kim, K.H.; Shin, S.W. A Geospatial Platform to Manage Large-Scale Individual Mobility for an Urban Digital Twin Platform. *Remote Sensing* **2022**, *14*, 723.
129. Nativi, S.; Mazzetti, P.; Craglia, M. Digital ecosystems for developing digital twins of the earth: The destination earth case. *Remote Sensing* **2021**, *13*, 2119.

130. Pettey, C. Prepare for the Impact of Digital Twins. *Gartner: Stamford, CT, USA 2017*.
131. Cearley, D.; Velosa, A.; Walker, M. Top 10 Strategic Technology Trends for 2017: Digital Twins. *Gartner: Stamford, CT, USA 2017*.
132. Cearley, D.; Velosa, A.; Kerremans, M.; Walker, M.; Burke, B. Top 10 Strategic Technology Trends for 2018: Digital Twins. *Gartner: Stamford, CT, USA 2018*.
133. Panetta, K. Gartner Top 10 Strategic Technology Trends for 2019. *Gartner: Stamford, CT, USA 2018*.
134. Boschert, S.; Rosen, R. Digital twin—the simulation aspect. In *Mechatronic futures*; Springer, 2016; pp. 59–74.
135. Wiener, N. *Cybernetics or Control and Communication in the Animal and the Machine*; Vol. 25, MIT Press, 1961.
136. Gelernter, D. *Mirror worlds: Or the day software puts the universe in a shoebox... How it will happen and what it will mean*; Oxford University Press, 1993.
137. Glaessgen, E.; Stargel, D. The digital twin paradigm for future NASA and US Air Force vehicles. 53rd AIAA / ASME / ASCE / AHS / ASC Structures, Structural Dynamics and Materials Conference 20th AIAA / ASME / AHS Adaptive Structures Conference 14th AIAA, 2012, p. 1818.
138. Aguilar, L.; Lalith, M.; Ichimura, T.; Hori, M. Automatic evacuation management using a multi agent system and parallel meta-heuristic search. International Conference on Principles and Practice of Multi-Agent Systems. Springer, 2016, pp. 387–396.
139. Gabor, T.; Belzner, L.; Kiermeier, M.; Beck, M.T.; Neitz, A. A simulation-based architecture for smart cyber-physical systems. Autonomic Computing (ICAC), 2016 IEEE International Conference on. IEEE, 2016, pp. 374–379.
140. Chowdhury, S.H.; Ali, F.; Jennions, I.K. A methodology for the experimental validation of an aircraft ECS digital twin targeting system level diagnostics. Annual Conference of the PHM Society, 2019, Vol. 11, pp. 21–26.
141. The Economist. Digital twins in cockpits will help planes look after themselves, 2022.
142. Weyer, S.; Meyer, T.; Ohmer, M.; Gorecky, D.; Zühlke, D. Future modeling and simulation of CPS-based factories: an example from the automotive industry. *IFAC-PapersOnLine* **2016**, *49*, 97–102.
143. Rosen, R.; Von Wichert, G.; Lo, G.; Bettenhausen, K.D. About the importance of autonomy and digital twins for the future of manufacturing. *IFAC-PapersOnLine* **2015**, *48*, 567–572.
144. Vachálek, J.; Bartalský, L.; Rovný, O.; Šišmišová, D.; Morháč, M.; Lokšík, M. The digital twin of an industrial production line within the industry 4.0 concept. 2017 21st International Conference on Process Control (PC). IEEE, 2017, pp. 258–262.
145. Canedo, A. Industrial IoT lifecycle via digital twins. 2016 International Conference on Hardware/Software Codesign and System Synthesis (CODES+ ISSS). IEEE, 2016, pp. 1–1.
146. Wikle, C.K.; Berliner, L.M. A Bayesian tutorial for data assimilation. *Physica D: Nonlinear Phenomena* **2007**, *230*, 1 – 16. Data Assimilation, doi:<https://doi.org/10.1016/j.physd.2006.09.017>.
147. Reichle, R.H. Data assimilation methods in the Earth sciences. *Advances in Water Resources* **2008**, *31*, 1411 – 1418. Hydrologic Remote Sensing, doi:<https://doi.org/10.1016/j.advwatres.2008.01.001>.
148. Xiao, J.; Zhu, R.; Hu, R.; Wang, M.; Zhu, Y.; Chen, D.; Li, D. Towards real-time service from remote sensing: Compression of earth observatory video data via long-term background referencing. *Remote Sensing* **2018**, *10*, 876.
149. Shi, W.; Cao, J.; Zhang, Q.; Li, Y.; Xu, L. Edge computing: Vision and challenges. *IEEE Internet of Things Journal* **2016**, *3*, 637–646.
150. Hossain, S.K.A.; Rahman, M.A.; Hossain, M.A. Edge computing framework for enabling situation awareness in IoT based smart city. *Journal of Parallel and Distributed Computing* **2018**, *122*, 226–237.
151. Schluse, M.; Priggemeyer, M.; Atorf, L.; Rossmann, J. Experimentable digital twins—Streamlining simulation-based systems engineering for industry 4.0. *IEEE Transactions on industrial informatics* **2018**, *14*, 1722–1731.
152. Swetina, J.; Lu, G.; Jacobs, P.; Ennesser, F.; Song, J. Toward a standardized common M2M service layer platform: Introduction to oneM2M. *IEEE Wireless Communications* **2014**, *21*, 20–26.
153. Xu, D.L.; He, W.; Li, S. Internet of things in industries: A survey. *IEEE Transactions on Industrial Informatics* **2014**, *10*, 2233–2243.
154. Lee, J.; Bagheri, B.; Kao, H.A. A cyber-physical systems architecture for industry 4.0-based manufacturing systems. *Manufacturing Letters* **2015**, *3*, 18–23.
155. Knappmeyer, M.; Kiani, S.L.; Reetz, E.S.; Baker, N.; Tonjes, R. Survey of context provisioning middleware. *IEEE Communications Surveys & Tutorials* **2013**, *15*, 1492–1519.
156. Guinard, D.; Trifa, V.; Mattern, F.; Wilde, E. From the internet of things to the web of things: Resource-oriented architecture and best practices. In *Architecting the Internet of Things*; Springer, 2011; pp. 97–129.
157. Huang, Y.; Li, G. Descriptive models for Internet of Things. Intelligent Control and Information Processing (ICICIP), Proceedings of the 2010 International Conference on. IEEE, 2010, pp. 483–486.
158. Spiess, P.; Karnouskos, S.; Guinard, D.; Savio, D.; Baecker, O.; De Souza, L.M.S.; Trifa, V. SOA-based integration of the internet of things in enterprise services. Web Services (ICWS), Proceedings of the 2009 IEEE International Conference on. IEEE, 2009, pp. 968–975.
159. Guinard, D.; Trifa, V.M.; Wilde, E. Architecting a mashable open world wide web of things. Technical report, Department of Computer Science, Swiss Federal Institute of Technology Zurich, Zürich, 2010.

160. Guinard, D.; Trifa, V.; Karnouskos, S.; Spiess, P.; Savio, D. Interacting with the soa-based internet of things: Discovery, query, selection, and on-demand provisioning of web services. *IEEE Transactions on Services Computing* **2010**, *3*, 223–235.
161. Guinard, D.; Trifa, V.; Wilde, E. A resource oriented architecture for the web of things. Internet of Things (IOT), Proceedings of the 2010 1st International Conference on. IEEE, 2010, pp. 1–8.
162. Kindberg, T.; Barton, J.; Morgan, J.; Becker, G.; Caswell, D.; Debaty, P.; Gopal, G.; Frid, M.; Krishnan, V.; Morris, H.; Others. People, places, things: Web presence for the real world. *Mobile Networks and Applications* **2002**, *7*, 365–376.
163. Blackstock, M.; Lea, R. IoT mashups with the WoTKit. Internet of Things (IOT), Proceedings of the 2012 3rd International Conference on the. IEEE, 2012, pp. 159–166.
164. Borgia, E. The Internet of Things vision: Key features, applications and open issues. *Computer Communications* **2014**, *54*, 1–31.
165. Islam, S.M.R.; Kwak, D.; Kabir, M.D.H.; Hossain, M.; Kwak, K.S. The internet of things for health care: a comprehensive survey. *IEEE Access* **2015**, *3*, 678–708.
166. Wang, S.; Wan, J.; Zhang, D.; Li, D.; Zhang, C. Towards smart factory for industry 4.0: a self-organized multi-agent system with big data based feedback and coordination. *Computer Networks* **2016**, *101*, 158–168.
167. Akyildiz, I.F.; Su, W.; Sankarasubramaniam, Y.; Cayirci, E. Wireless sensor networks: a survey. *Computer Networks* **2002**, *38*, 393–422.
168. Schleich, B.; Anwer, N.; Mathieu, L.; Wartzack, S. Shaping the digital twin for design and production engineering. *CIRP Annals* **2017**, *66*, 141–144.
169. Moreno, A.; Velez, G.; Ardanza, A.; Barandiaran, I.; de Infante, Á.R.; Chopitea, R. Virtualisation process of a sheet metal punching machine within the Industry 4.0 vision. *International Journal on Interactive Design and Manufacturing (IJIDeM)* **2017**, *11*, 365–373.
170. Sepasgozar, S.M. Differentiating digital twin from digital shadow: Elucidating a paradigm shift to expedite a smart, sustainable built environment. *Buildings* **2021**, *11*, 151.
171. Madria, S.; Kumar, V.; Dalvi, R. Sensor cloud: A cloud of virtual sensors. *IEEE Software* **2014**, *31*, 70–77.
172. Ocean, M.J.; Bestavros, A.; Kfoury, A.J. snBench: Programming and virtualization framework for distributed multitasking sensor networks. Virtual Execution Environments, Proceedings of the 2006 2nd International Conference on. ACM, 2006, pp. 89–99.
173. Khan, I.; Belqasmi, F.; Glitho, R.; Crespi, N.; Morrow, M.; Polakos, P. Wireless sensor network virtualization: A survey. *IEEE Communications Surveys & Tutorials* **2016**, *18*, 553–576.
174. Bröring, A.; Schmid, S.; Schindhelm, C.K.; Khelil, A.; Kabisch, S.; Kramer, D.; Le Phuoc, D.; Mitic, J.; Anicic, D.; Teniente López, E. Enabling IoT ecosystems through platform interoperability. *IEEE Software* **2017**, *34*, 54–61.
175. Desai, P.; Sheth, A.; Anantharam, P. Semantic gateway as a service architecture for iot interoperability. Mobile Services (MS), Proceedings of the 2015 IEEE International Conference on. IEEE, 2015, pp. 313–319.
176. Al-Fuqaha, A.; Khreishah, A.; Guizani, M.; Rayes, A.; Mohammadi, M. Toward better horizontal integration among IoT services. *IEEE Communications Magazine* **2015**, *53*, 72–79.
177. Raza, M.; Aslam, N.; Le-Minh, H.; Hussain, S.; Cao, Y.; Khan, N.M. A Critical Analysis of Research Potential, Challenges, and Future Directives in Industrial Wireless Sensor Networks. *IEEE Communications Surveys & Tutorials* **2018**, *20*, 39–95.
178. Das, A.K.; Zeadally, S.; He, D. Taxonomy and analysis of security protocols for Internet of Things. *Future Generation Computer Systems* **2018**, *89*, 110–125.
179. Keoh, S.L.; Kumar, S.S.; Tschofenig, H. Securing the internet of things: A standardization perspective. *IEEE Internet of Things Journal* **2014**, *1*, 265–275.
180. Granjal, J.; Monteiro, E.; Silva, J.S. Security for the internet of things: a survey of existing protocols and open research issues. *IEEE Communications Surveys & Tutorials* **2015**, *17*, 1294–1312.
181. Kouicem, D.E.; Bouabdallah, A.; Lakhlef, H. Internet of Things Security: a top-down survey. *Computer Networks* **2018**, *141*, 199–221.
182. Zhou, Y.; Fang, Y.; Zhang, Y. Securing wireless sensor networks: a survey. *IEEE Communications Surveys & Tutorials* **2008**, *10*.
183. Chen, X.; Makki, K.; Yen, K.; Pissinou, N. Sensor network security: A survey. *IEEE Communications Surveys & Tutorials* **2009**, *11*, 52–73.
184. Zhang, Z.K.; Cho, M.C.Y.; Wang, C.W.; Hsu, C.W.; Chen, C.K.; Shieh, S. IoT security: ongoing challenges and research opportunities. Service-Oriented Computing and Applications (SOCA), Proceedings of the 2014 IEEE 7th International Conference on. IEEE, 2014, pp. 230–234.
185. Singh, J.; Pasquier, T.; Bacon, J.; Ko, H.; Eyers, D. Twenty Security Considerations for Cloud-Supported Internet of Things. *IEEE Internet of Things Journal* **2016**, *3*, 269–284.
186. Heer, T.; Garcia-Morchon, O.; Hummen, R.; Keoh, S.L.; Kumar, S.S.; Wehrle, K. Security Challenges in the IP-based Internet of Things. *Wireless Personal Communications* **2011**, *61*, 527–542.
187. Yaqoob, I.; Ahmed, E.; ur Rehman, M.H.; Ahmed, A.I.A.; Al-garadi, M.A.; Imran, M.; Guizani, M. The rise of ransomware and emerging security challenges in the Internet of Things. *Computer Networks* **2017**, *129*, 444–458.
188. Zhao, K.; Ge, L. A survey on the internet of things security. Computational Intelligence and Security (CIS), 2013 9th International Conference on. IEEE, 2013, pp. 663–667.
189. Sarma, A.C.; Girão, J. Identities in the future internet of things. *Wireless personal communications* **2009**, *49*, 353–363.
190. Roman, R.; Najera, P.; Lopez, J. Securing the internet of things. *Computer* **2011**, *44*, 51–58.

191. Sadeghi, A.R.; Wachsmann, C.; Waidner, M. Security and privacy challenges in industrial internet of things. Design Automation Conference (DAC), Proceedings of the 2015 52nd ACM/EDAC/IEEE. IEEE, 2015, pp. 1–6.
192. Akyildiz, I.F.; Su, W.; Sankarasubramaniam, Y.; Cayirci, E. A survey on sensor networks. *IEEE Communications Magazine* **2002**, *40*, 102–114.
193. Bi, Z.; Da Xu, L.; Wang, C. Internet of things for enterprise systems of modern manufacturing. *IEEE Transactions on industrial informatics* **2014**, *10*, 1537–1546.
194. Doukas, C.; Maglogiannis, I. Bringing IoT and cloud computing towards pervasive healthcare. Innovative Mobile and Internet Services in Ubiquitous Computing (IMIS), Proceedings of the 2012 6th International Conference on. IEEE, 2012, pp. 922–926.
195. Amendola, S.; Lodato, R.; Manzari, S.; Occhiuzzi, C.; Marrocco, G. RFID technology for IoT-based personal healthcare in smart spaces. *IEEE Internet of Things Journal* **2014**, *1*, 144–152.
196. Catarinucci, L.; De Donno, D.; Mainetti, L.; Palano, L.; Patrono, L.; Stefanizzi, M.L.; Tarricone, L. An IoT-aware architecture for smart healthcare systems. *IEEE Internet of Things Journal* **2015**, *2*, 515–526.
197. Kumari, A.; Tanwar, S.; Tyagi, S.; Kumar, N. Fog computing for Healthcare 4.0 environment: Opportunities and challenges. *Computers & Electrical Engineering* **2018**, *72*, 1–13.
198. Vlacheas, P.; Giaffreda, R.; Stavroulaki, V.; Kelaidonis, D.; Foteinos, V.; Poullos, G.; Demestichas, P.; Somov, A.; Biswas, A.R.; Moessner, K. Enabling smart cities through a cognitive management framework for the internet of things. *IEEE Communications Magazine* **2013**, *51*, 102–111.
199. Krylovskiy, A.; Jahn, M.; Patti, E. Designing a smart city internet of things platform with microservice architecture. Future Internet of Things and Cloud (FiCloud), Proceedings of the 2015 3rd International Conference on. IEEE, 2015, pp. 25–30.
200. Al-Turjman, F.; Lemayian, J.P. Intelligence, security, and vehicular sensor networks in internet of things (IoT)-enabled smart-cities: An overview. *Computers & Electrical Engineering* **2020**, *87*, 106776.
201. Kamilaris, A.; Pitsillides, A. Mobile phone computing and the internet of things: A survey. *IEEE Internet of Things Journal* **2016**, *3*, 885–898.
202. Bertalanffy, L.v. *General system theory: Foundations, development, applications*; G. Braziller, 1969.
203. Moussaïd, M.; Schinazi, V.R.; Kapadia, M.; Thrash, T. Virtual Sensing and Virtual Reality: How New Technologies Can Boost Research on Crowd Dynamics. *Front. Robot. and AI* **2018**, *5*. doi:10.3389/frobt.2018.00082.
204. Kiefer, P.; Giannopoulos, I.; Raubal, M. Where am I? Investigating map matching during self-localization with mobile eye tracking in an urban environment. *Trans. GIS* **2014**, *18*, 660–686.
205. Petäjärvi, J.; Mikhaylov, K.; Yasmin, R.; Hämäläinen, M.; Iinatti, J. Evaluation of LoRa LPWAN technology for indoor remote health and wellbeing monitoring. *Int. J. of Wireless Inf. Netw.* **2017**, *24*, 153–165.
206. Singh, S.; Prasad, D. Wireless body area network (WBAN): A review of schemes and protocols. *Materials Today: Proceedings* **2021**.
207. Kushalnagar, N.; Montenegro, G.; Schumacher, C. IPv6 over low-power wireless personal area networks (6LoWPANs): overview, assumptions, problem statement, and goals. Technical report, IETF, 2007.
208. White, A.L.; Stoughton, M.; Feng, L. Servicizing: the quiet transition to extended product responsibility. *Tellus Institute, Boston* **1999**, 97.
209. Toffel, M.W. Contracting for servicizing. No. 08-063.
210. Plepys, A.; Heiskanen, E.; Mont, O. European policy approaches to promote servicizing. *Journal of Cleaner Production* **2015**, *97*, 117–123.
211. Agrawal, V.V.; Bellos, I. The potential of servicizing as a green business model. *Management Science* **2016**, *63*, 1545–1562.
212. Alam, S.; Chowdhury, M.M.R.; Noll, J. Senaas: An event-driven sensor virtualization approach for internet of things cloud. Networked Embedded Systems for Enterprise Applications (NESEA), Proceedings of the 2010 IEEE International Conference on. IEEE, 2010, pp. 1–6.
213. Distefano, S.; Merlino, G.; Puliafito, A. A utility paradigm for IoT: The sensing Cloud. *Pervasive and Mobile Computing* **2015**, *20*, 127–144.
214. Chen, Y.; Hu, H. Internet of intelligent things and robot as a service. *Simulation Modelling Practice and Theory* **2013**, *34*, 159–171.
215. Toullos, L. Remote sensing as a service tool for the detection of water resources and crop conditions monitoring. *Hellenic Agricultural organization DEMETER, Institute of Soil classification & Mapping, Greece* **2015**.
216. Ouaddah, A.; Mousannif, H.; Elkalam, A.A.; Ouahman, A.A. Access control in the Internet of Things: Big challenges and new opportunities. *Computer Networks* **2017**, *112*, 237–262.
217. Association, I.S.; others. Ieee standard for local and metropolitan area networks—Part 15.4: Low-rate wireless personal area networks (LR-WPANs). IEEE Std 802.15.4-2011. *IEEE Computer Society: New York, NY, USA* **2011**.
218. Association, I.S.; others. IEEE Standard for Local and metropolitan area networks—Part 15.4: Low-Rate Wireless Personal Area Networks (LR-WPANs) Amendment 1: MAC sublayer. IEEE Std 802.15.4e-2012 (Amendment to IEEE Std 802.15.4-2011). *IEEE Computer Society: New York, NY, USA* **2012**.
219. Bormann, C.; Castellani, A.P.; Shelby, Z. Coap: An application protocol for billions of tiny internet nodes. *IEEE Internet Computing* **2012**, *16*, 62–67.

- 
220. Raza, S.; Shafagh, H.; Hewage, K.; Hummen, R.; Voigt, T.; Others. Lite: Lightweight secure CoAP for the internet of things. *IEEE Sensors Journal* **2013**, *13*, 3711–3720.
  221. Glissa, G.; Meddeb, A. 6LoWPan: An end-to-end security protocol for 6LoWPAN. *Ad Hoc Networks* **2019**, *82*, 100–112.
  222. Mayzaud, A.; Badonnel, R.; Chrisment, I. A Taxonomy of Attacks in RPL-based Internet of Things. *International Journal of Network Security* **2016**, *18*, 459–473.
  223. Villegas, D.; Bobroff, N.; Rodero, I.; Delgado, J.; Liu, Y.; Devarakonda, A.; Fong, L.; Sadjadi, S.M.; Parashar, M. Cloud federation in a layered service model. *Journal of Computer and System Sciences* **2012**, *78*, 1330–1344.
  224. Hachem, S.; Teixeira, T.; Issarny, V. Ontologies for the internet of things. *Middleware Doctoral Symposium, Proceedings of the 2011 8th. ACM*, 2011, p. 3.
  225. Wang, W.; De, S.; Toenjes, R.; Reetz, E.; Moessner, K. A comprehensive ontology for knowledge representation in the internet of things. *Trust, Security and Privacy in Computing and Communications (TrustCom), 2012 IEEE 11th International Conference on. IEEE*, 2012, pp. 1793–1798.
  226. Song, Z.; Cárdenas, A.A.; Masuoka, R. Semantic middleware for the internet of things. *Internet of Things (IOT), Proceedings of the 2010 1st International Conference on. IEEE*, 2010, pp. 1–8.
  227. Ngu, A.H.; Gutierrez, M.; Metsis, V.; Nepal, S.; Sheng, Q.Z. IoT middleware: A survey on issues and enabling technologies. *IEEE Internet of Things Journal* **2017**, *4*, 1–20.
  228. Razzaque, M.A.; Milojevic-Jevric, M.; Palade, A.; Clarke, S. Middleware for Internet of Things: A survey. *IEEE Internet of Things Journal* **2016**, *3*, 70–95.
  229. Mineraud, J.; Mazhelis, O.; Su, X.; Tarkoma, S. A gap analysis of Internet-of-Things platforms. *Computer Communications* **2016**, *89*, 5–16.
  230. Linthicum, D.S. PaaS death watch? *IEEE Cloud Computing* **2017**, *4*, 6–9.
  231. Atzori, L.; Iera, A.; Morabito, G. Understanding the Internet of Things: definition, potentials, and societal role of a fast evolving paradigm. *Ad Hoc Networks* **2017**, *56*, 122–140.
  232. Baheti, R.; Gill, H. Cyber-physical systems. *The impact of control technology* **2011**, *12*, 161–166.
  233. Lee, E.A. The past, present and future of cyber-physical systems: A focus on models. *Sensors* **2015**, *15*, 4837–4869.
  234. Rho, S.; Vasilakos, A.V.; Chen, W. Cyber physical systems technologies and applications. *Future Generation Computer Systems* **2016**, *56*, 436–437.
  235. Alam, K.M.; El Saddik, A. C2ps: A digital twin architecture reference model for the cloud-based cyber-physical systems. *IEEE Access* **2017**, *5*, 2050–2062.
  236. Um, J.S. *Drones as cyber-physical systems*; Springer, 2019.
  237. Sheth, A. Internet of things to smart iot through semantic, cognitive, and perceptual computing. *IEEE Intelligent Systems* **2016**, *31*, 108–112.
  238. Rawat, P.; Singh, K.D.; Bonnin, J.M. Cognitive radio for M2M and Internet of Things: A survey. *Computer Communications* **2016**, *94*, 1–29.
  239. Mainetti, L.; Patrono, L.; Vilei, A. Evolution of wireless sensor networks towards the internet of things: A survey. *Software, Telecommunications and Computer Networks (SoftCOM), 2011 19th International Conference on. IEEE*, 2011, pp. 1–6.
  240. Welbourne, E.; Battle, L.; Cole, G.; Gould, K.; Rector, K.; Raymer, S.; Balazinska, M.; Borriello, G. Building the internet of things using RFID: the RFID ecosystem experience. *IEEE Internet Computing* **2009**, *13*.
  241. Li, C.; Mo, L.; Zhang, D. Review on UHF RFID localization methods. *IEEE Journal of Radio Frequency Identification* **2019**, *3*, 205–215.
  242. Shao, C.; Roh, H.; Lee, W. Next-generation RF-powered networks for Internet of Things: Architecture and research perspectives. *Journal of Network and Computer Applications* **2018**, *123*, 23–31.
  243. Rastogi, V.; Suci, D.; Welbourne, E. Access control over uncertain data. *Proceedings of the VLDB Endowment* **2008**, *1*, 821–832.
  244. Bormann, C.; Ersue, M.; Keranen, A. Terminology for constrained-node networks. Technical report, Internet Engineering Task Force (IETF), 2014.
  245. Hahm, O.; Baccelli, E.; Petersen, H.; Tsiftes, N. Operating systems for low-end devices in the internet of things: a survey. *IEEE Internet of Things Journal* **2016**, *3*, 720–734.
  246. Javed, F.; Afzal, M.K.; Sharif, M.; Kim, B.S. Internet of Things (IoTs) Operating Systems Support, Networking Technologies, Applications, and Challenges: A Comparative Review. *IEEE Communications Surveys & Tutorials* **2018**.
  247. Li, X.; Lu, R.; Liang, X.; Shen, X.; Chen, J.; Lin, X. Smart community: an internet of things application. *IEEE Communications Magazine* **2011**, *49*.
  248. Sanchez, L.; Muñoz, L.; Galache, J.A.; Sotres, P.; Santana, J.R.; Gutierrez, V.; Ramdhany, R.; Gluhak, A.; Krco, S.; Theodoridis, E.; Others. SmartSantander: IoT experimentation over a smart city testbed. *Computer Networks* **2014**, *61*, 217–238.
  249. Perera, C.; Liu, C.H.; Jayawardena, S.; Chen, M. A survey on internet of things from industrial market perspective. *IEEE Access* **2014**, *2*, 1660 – 1679.



- 
250. Kothari, M.; Mistry, Z.; Kamat, A.; Ragavendran, U. Multi-antenna-Enabled Technologies for IoT-Driven Smart Cities. In *IoT and IoE Driven Smart Cities*; Springer, 2022; pp. 45–72.
251. Gazis, D.C.; Herman, R. The moving and “phantom” bottlenecks. *Transportation Science* **1992**, *26*, 223–229.
252. Nitti, M.; Pilloni, V.; Colistra, G.; Atzori, L. The virtual object as a major element of the internet of things: a survey. *IEEE Communications Surveys & Tutorials* **2016**, *18*, 1228–1240.
253. Rathore, M.M.; Ahmad, A.; Paul, A.; Rho, S. Urban planning and building smart cities based on the internet of things using big data analytics. *Computer Networks* **2016**, *101*, 63–80.
254. Anda, C.; Medina, S.A.O.; Axhausen, K.W. Synthesising digital twin travellers: Individual travel demand from aggregated mobile phone data. *Transportation Research Part C: Emerging Technologies* **2021**, *128*, 103118.
255. Satyanarayanan, M.; Others. Pervasive computing: Vision and challenges. *IEEE Personal communications* **2001**, *8*, 10–17.
256. Ma, J.; Yang, L.T.; Apduhan, B.O.; Huang, R.; Barolli, L.; Takizawa, M. Towards a smart world and ubiquitous intelligence: a walkthrough from smart things to smart hyperspaces and UbiKids. *International Journal of Pervasive Computing and Communications* **2005**, *1*, 53–68.
257. Kortuem, G.; Kawsar, F.; Sundramoorthy, V.; Fitton, D. Smart objects as building blocks for the internet of things. *IEEE Internet Computing* **2010**, *14*, 44–51.
258. Fortino, G.; Guerrieri, A.; Russo, W. Agent-oriented smart objects development. Computer Supported Cooperative Work in Design (CSCWD), Proceedings of the 2012 IEEE 16th International Conference on. IEEE, 2012, pp. 907–912.
259. Atzori, L.; Iera, A.; Morabito, G. From “smart objects” to “social objects”: The next evolutionary step of the internet of things. *IEEE Communications Magazine* **2014**, *52*, 97–105.
260. Tan, L.; Wang, N. Future internet: The internet of things. Advanced Computer Theory and Engineering (ICACTE), 2010 3rd International Conference on. IEEE, 2010, Vol. 5, pp. V5—376.
261. Khan, R.; Khan, S.U.; Zaheer, R.; Khan, S. Future internet: the internet of things architecture, possible applications and key challenges. Frontiers of Information Technology (FIT), Proceedings of the 2012 10th International Conference on. IEEE, 2012, pp. 257–260.
262. Stankovic, J.A. Research directions for the internet of things. *IEEE Internet of Things Journal* **2014**, *1*, 3–9.
263. Hurlburt, G.F.; Voas, J.; Miller, K.W. The internet of things: A reality check. *IT Professional* **2012**, *14*, 56–59.
264. Ashton, K.; Others. That ‘internet of things’ thing. *RFID journal* **2009**, *22*, 97–114.
265. Gluhak, A.; Krco, S.; Nati, M.; Pfisterer, D.; Mitton, N.; Razafindralambo, T. A survey on facilities for experimental internet of things research. *IEEE Communications Magazine* **2011**, *49*, 58–67.
266. Chen, Y.K. Challenges and opportunities of internet of things. Design Automation Conference (ASP-DAC), Proceedings of the 2012 17th Asia and South Pacific. Citeseer, 2012, pp. 383–388.
267. Gubbi, J.; Buyya, R.; Marusic, S.; Palaniswami, M. Internet of Things (IoT): A vision, architectural elements, and future directions. *Future Generation Computer systems* **2013**, *29*, 1645–1660.
268. Singh, D.; Tripathi, G.; Jara, A.J. A survey of Internet-of-Things: Future vision, architecture, challenges and services. Internet of Things (WF-IoT), 2014 IEEE World Forum on. IEEE, 2014, pp. 287–292.
269. Want, R.; Schilit, B.N.; Jenson, S. Enabling the internet of things. *Computer* **2015**, *48*, 28–35.
270. Al-Fuqaha, A.; Guizani, M.; Mohammadi, M.; Aledhari, M.; Ayyash, M. Internet of things: A survey on enabling technologies, protocols, and applications. *IEEE Communications Surveys & Tutorials* **2015**, *17*, 2347–2376.
271. Whitmore, A.; Agarwal, A.; Da Xu, L. The Internet of Things—A survey of topics and trends. *Information Systems Frontiers* **2015**, *17*, 261–274.
272. Madakam, S.; Ramaswamy, R.; Tripathi, S. Internet of Things (IoT): A literature review. *Journal of Computer and Communications* **2015**, *3*, 164.
273. Palattella, M.R.; Dohler, M.; Grieco, A.; Rizzo, G.; Torsner, J.; Engel, T.; Ladid, L. Internet of things in the 5G era: Enablers, architecture, and business models. *IEEE Journal on Selected Areas in Communications* **2016**, *34*, 510–527.
274. Lin, J.; Yu, W.; Zhang, N.; Yang, X.; Zhang, H.; Zhao, W. A survey on internet of things: Architecture, enabling technologies, security and privacy, and applications. *IEEE Internet of Things Journal* **2017**, *4*, 1125–1142.
275. Qiu, T.; Chen, N.; Li, K.; Atiquzzaman, M.; Zhao, W. How can heterogeneous internet of things build our future: A survey. *IEEE Communications Surveys & Tutorials* **2018**.
276. Shafique, K.; Khawaja, B.A.; Sabir, F.; Qazi, S.; Mustaqim, M. Internet of things (IoT) for next-generation smart systems: A review of current challenges, future trends and prospects for emerging 5G-IoT scenarios. *Ieee Access* **2020**, *8*, 23022–23040.
277. Zorzi, M.; Gluhak, A.; Lange, S.; Bassi, A. From today’s intranet of things to a future internet of things: a wireless-and mobility-related view. *IEEE Wireless communications* **2010**, *17*.
278. Wu, J.; Zhao, W. Design and realization of winternet: From net of things to internet of things. *ACM Transactions on Cyber-Physical Systems* **2017**, *1*, 2.
279. Alamri, A.; Ansari, W.S.; Hassan, M.M.; Hossain, M.S.; Alelaiwi, A.; Hossain, M.A. A survey on sensor-cloud: architecture, applications, and approaches. *International Journal of Distributed Sensor Networks* **2013**, *9*, 917923.

280. Misra, S.; Chatterjee, S.; Obaidat, M.S. On theoretical modeling of sensor cloud: A paradigm shift from wireless sensor network. *IEEE Systems journal* **2017**, *11*, 1084–1093.
281. Pfisterer, D.; Romer, K.; Bimschas, D.; Kleine, O.; Mietz, R.; Truong, C.; Hasemann, H.; Kröllner, A.; Pagel, M.; Hauswirth, M.; Others. SPITFIRE: toward a semantic web of things. *IEEE Communications Magazine* **2011**, *49*, 40–48.
282. Bonomi, F.; Milito, R.; Zhu, J.; Addepalli, S. Fog computing and its role in the internet of things. Mobile cloud computing (MCC), Proceedings of the 2012 1st workshop on. ACM, 2012, pp. 13–16.
283. Guo, B.; Zhang, D.; Wang, Z.; Yu, Z.; Zhou, X. Opportunistic IoT: Exploring the harmonious interaction between human and the internet of things. *Journal of Network and Computer Applications* **2013**, *36*, 1531–1539.
284. Paraskevakos, T. Apparatus for generating and transmitting digital information, 1974. US Patent 3,812,296.
285. Datta, S.K.; Bonnet, C.; Nikaiein, N. An IoT gateway centric architecture to provide novel M2M services. Internet of Things (WF-IoT), 2014 IEEE World Forum on. IEEE, 2014, pp. 514–519.
286. Andreev, S.; Galinina, O.; Pyattaev, A.; Gerasimenko, M.; Tirronen, T.; Torsner, J.; Sachs, J.; Dohler, M.; Koucheryavy, Y. Understanding the IoT connectivity landscape: a contemporary M2M radio technology roadmap. *IEEE Communications Magazine* **2015**, *53*, 32–40.
287. Gazis, V. A Survey of Standards for Machine-to-Machine and the Internet of Things. *IEEE Communications Surveys & Tutorials* **2017**, *19*, 482–511.
288. Patil, S.; Gokhale, P. Systematic Review of Resource Allocation Methods Using Scheduling for M2M (Machine to Machine Communication) in IoT Network. *Security Issues and Privacy Threats in Smart Ubiquitous Computing* **2021**, pp. 213–224.
289. Baronti, P.; Pillai, P.; Chook, V.W.C.; Chessa, S.; Gotta, A.; Hu, Y.F. Wireless sensor networks: A survey on the state of the art and the 802.15. 4 and ZigBee standards. *Computer Communications* **2007**, *30*, 1655–1695.
290. Yick, J.; Mukherjee, B.; Ghosal, D. Wireless sensor network survey. *Computer Networks* **2008**, *52*, 2292–2330.
291. Khorov, E.; Lyakhov, A.; Krotov, A.; Guschin, A. A survey on IEEE 802.11 ah: An enabling networking technology for smart cities. *Computer Communications* **2015**, *58*, 53–69.
292. Wang, H.; Fapojuwo, A.O. A survey of enabling technologies of low power and long range machine-to-machine communications. *IEEE Communications Surveys & Tutorials* **2017**, *19*, 2621–2639.
293. Ishaq, I.; Carels, D.; Teklemariam, G.K.; Hoebeke, J.; den Abeele, F.V.; Poorter, E.D.; Moerman, I.; Demeester, P. IETF standardization in the field of the internet of things (IoT): a survey. *Journal of Sensor and Actuator Networks* **2013**, *2*, 235–287.
294. Sheng, Z.; Yang, S.; Yu, Y.; Vasilakos, A.; Mccann, J.; Leung, K. A survey on the ietf protocol suite for the internet of things: Standards, challenges, and opportunities. *IEEE Wireless Communications* **2013**, *20*, 91–98.
295. Bachir, A.; Dohler, M.; Watteyne, T.; Leung, K.K. MAC essentials for wireless sensor networks. *IEEE Communications Surveys & Tutorials* **2010**, *12*, 222–248.
296. Rajandekar, A.; Sikdar, B. A survey of MAC layer issues and protocols for machine-to-machine communications. *IEEE Internet of Things Journal* **2015**, *2*, 175–186.
297. Sotenga, P.Z.; Djouani, K.; Kurien, A.M. Media access control in large-scale Internet of Things: a review. *IEEE Access* **2020**, *8*, 55834–55859.
298. International Organization for Standardization. The Basic Reference Model for Open Systems Interconnection (ISO/IEC Standard No. 7498-1), 2016.
299. Chen, K.C.; Lien, S.Y. Machine-to-machine communications: Technologies and challenges. *Ad Hoc Networks* **2014**, *18*, 3–23.
300. Aijaz, A.; Aghvami, A.H. Cognitive machine-to-machine communications for Internet-of-Things: A protocol stack perspective. *IEEE Internet of Things Journal* **2015**, *2*, 103–112.
301. Akyildiz, I.F.; Jornet, J.M. The internet of nano-things. *IEEE Wireless Communications* **2010**, *17*.
302. Akyildiz, I.F.; Pierobon, M.; Balasubramaniam, S.; Koucheryavy, Y. The internet of bio-nano things. *IEEE Communications Magazine* **2015**, *53*, 32–40.
303. Gravina, R.; Alinia, P.; Ghasemzadeh, H.; Fortino, G. Multi-sensor fusion in body sensor networks: State-of-the-art and research challenges. *Information Fusion* **2017**, *35*, 68–80.
304. Miraz, M.; Ali, M.; Excell, P.; Picking, R. Internet of nano-things, things and everything: future growth trends. *Future Internet* **2018**, *10*, 68.
305. Arslan, H.; Chen, Z.N.; Di Benedetto, M.G. *Ultra wideband wireless communication*; John Wiley & Sons, 2006.
306. Tozlu, S.; Senel, M.; Mao, W.; Keshavarzian, A. Wi-Fi enabled sensors for internet of things: A practical approach. *IEEE Communications Magazine* **2012**, *50*.
307. Ratasuk, R.; Mangalvedhe, N.; Zhang, Y.; Robert, M.; Koskinen, J.P. Overview of narrowband IoT in LTE Rel-13. Standards for Communications and Networking (CSCN), Proceedings of the 2016 IEEE Conference on. IEEE, 2016, pp. 1–7.
308. Raza, U.; Kulkarni, P.; Sooriyabandara, M. Low power wide area networks: An overview. *IEEE Communications Surveys & Tutorials* **2017**, *19*, 855–873.
309. Nolan, K.E.; Guibene, W.; Kelly, M.Y. An evaluation of low power wide area network technologies for the Internet of Things. Wireless Communications and Mobile Computing Conference (IWCMC), Proceedings of the 2016 International. IEEE, 2016, pp. 439–444.

310. Oliveira, L.M.L.; De Sousa, A.F.; Rodrigues, J.J.P.C. Routing and mobility approaches in IPv6 over LoWPAN mesh networks. *International Journal of Communication Systems* **2011**, *24*, 1445–1466.
311. Bor, M.C.; Roedig, U.; Voigt, T.; Alonso, J.M. Do LoRa low-power wide-area networks scale? Modeling, Analysis and Simulation of Wireless and Mobile Systems (MASWMS), Proceedings of the 2016 19th ACM International Conference on. ACM, 2016, pp. 59–67.
312. Petäjälä, J.; Mikhaylov, K.; Pettissalo, M.; Janhunen, J.; Linatti, J. Performance of a low-power wide-area network based on LoRa technology: Doppler robustness, scalability, and coverage. *International Journal of Distributed Sensor Networks* **2017**, *13*, 1550147717699412.
313. Georgiou, O.; Raza, U. Low power wide area network analysis: Can LoRa scale? *IEEE Wireless Communications Letters* **2017**, *6*, 162–165.
314. Palattella, M.R.; Accettura, N.; Vilajosana, X.; Watteyne, T.; Grieco, L.A.; Boggia, G.; Dohler, M. Standardized protocol stack for the internet of (important) things. *IEEE communications surveys & tutorials* **2013**, *15*, 1389–1406.
315. Kurunathan, H.; Severino, R.; Koubaa, A.; Tovar, E. IEEE 802.15. 4e in a Nutshell: Survey and Performance Evaluation. *IEEE Communications Surveys & Tutorials* **2018**.
316. Hui, J.W.; Culler, D.E. IP is dead, long live IP for wireless sensor networks. Embedded Network Sensor Systems (ENSS), Proceedings of the 2008 6th ACM conference on. ACM, 2008, pp. 15–28.
317. Hong, S.; Kim, D.; Ha, M.; Bae, S.; Park, S.J.; Jung, W.; Kim, J.E. SNAIL: an IP-based wireless sensor network approach to the internet of things. *IEEE Wireless Communications* **2010**, *17*.
318. Rodrigues, J.J.P.C.; Neves, P.A.C.S. A survey on IP-based wireless sensor network solutions. *International Journal of Communication Systems* **2010**, *23*, 963–981.
319. Imani, M.; Moghadam, A.Q.; Zarif, N.; Noshiri, O.; Faramarzi, K.; Arabnia, H.; Joudaki, M. A Comprehensive Survey on Addressing Methods in the Internet of Things. *arXiv preprint arXiv:1807.02173* **2018**.
320. Bonomi, F.; Milito, R.; Natarajan, P.; Zhu, J. Fog computing: A platform for internet of things and analytics. In *Big data and internet of things: A roadmap for smart environments*; Springer, 2014; pp. 169–186.
321. Stojmenovic, I.; Wen, S. The fog computing paradigm: Scenarios and security issues. Computer Science and Information Systems (FedCSIS), 2014 Federated Conference on. IEEE, 2014, pp. 1–8.
322. Jalali, F.; Hinton, K.; Ayre, R.; Alpcan, T.; Tucker, R.S. Fog computing may help to save energy in cloud computing. *IEEE Journal on Selected Areas in Communications* **2016**, *34*, 1728–1739.
323. Soliman, M.; Abiodun, T.; Hamouda, T.; Zhou, J.; Lung, C.H. Smart home: Integrating internet of things with web services and cloud computing. 2013 IEEE 5th International Conference on Cloud Computing Technology and Science (CloudCom). IEEE, 2013, pp. 317–320.
324. Botta, A.; De Donato, W.; Persico, V.; Pescapé, A. On the integration of cloud computing and internet of things. Future Internet of Things and Cloud (FiCloud), Proceedings of the 2014 2nd International Conference on. IEEE, 2014, pp. 23–30.
325. Fortino, G.; Guerrieri, A.; Russo, W.; Savaglio, C. Integration of agent-based and cloud computing for the smart objects-oriented IoT. Computer Supported Cooperative Work in Design (CSCWD), Proceedings of the 2014 IEEE 18th International Conference on. IEEE, 2014, pp. 493–498.
326. Cavalcante, E.; Pereira, J.; Alves, M.P.; Maia, P.; Moura, R.; Batista, T.; Delicato, F.C.; Pires, P.F. On the interplay of Internet of Things and Cloud Computing: A systematic mapping study. *Computer Communications* **2016**, *89*, 17–33.
327. Bittencourt, L.; Immich, R.; Sakellariou, R.; Fonseca, N.; Madeira, E.; Curado, M.; Villas, L.; da Silva, L.; Lee, C.; Rana, O. The Internet of Things, Fog and Cloud Continuum: Integration and Challenges. *Internet of Things (IOT), Proceedings of the 2018 8th International Conference on* **2018**.
328. Aazam, M.; Huh, E.N. Fog computing and smart gateway based communication for cloud of things. Future Internet of Things and Cloud (FiCloud), Proceedings of the 2014 2nd International Conference on. IEEE, 2014, pp. 464–470.
329. Satyanarayanan, M.; Simoens, P.; Xiao, Y.; Pillai, P.; Chen, Z.; Ha, K.; Hu, W.; Amos, B. Edge analytics in the internet of things. *IEEE Pervasive Computing* **2015**, *14*, 24–31.
330. Chiang, M.; Zhang, T. Fog and IoT: An overview of research opportunities. *IEEE Internet of Things Journal* **2016**, *3*, 854–864.
331. Mao, Y.; You, C.; Zhang, J.; Huang, K.; Letaief, K.B. A survey on mobile edge computing: The communication perspective. *IEEE Communications Surveys & Tutorials* **2017**, *19*, 2322–2358.
332. Naha, R.K.; Garg, S.; Georgakopoulos, D.; Jayaraman, P.P.; Gao, L.; Xiang, Y.; Ranjan, R. Fog Computing: Survey of Trends, Architectures, Requirements, and Research Directions. *IEEE Access* **2018**.
333. Vaquero, L.M.; Roderio-Merino, L. Finding your way in the fog: Towards a comprehensive definition of fog computing. *ACM SIGCOMM Computer Communication Review* **2014**, *44*, 27–32.
334. Giang, N.K.; Blackstock, M.; Lea, R.; Leung, V.C.M. Developing IoT applications in the fog: a distributed dataflow approach. Internet of Things (IOT), 2015 5th International Conference on the. IEEE, 2015, pp. 155–162.
335. Dastjerdi, A.V.; Buyya, R. Fog computing: Helping the Internet of Things realize its potential. *Computer* **2016**, *49*, 112–116.
336. Aazam, M.; Zeadally, S.; Harras, K.A. Offloading in fog computing for IoT: Review, enabling technologies, and research opportunities. *Future Generation Computer Systems* **2018**, *87*, 278–289.

337. Sarkar, S.; Chatterjee, S.; Misra, S. Assessment of the Suitability of Fog Computing in the Context of Internet of Things. *IEEE Transactions on Cloud Computing* **2018**, *6*, 46–59.
338. Negash, B.; Westerlund, T.; Tenhunen, H. Towards an interoperable Internet of Things through a web of virtual things at the Fog layer. *Future Generation Computer Systems* **2019**, *91*, 96–107.
339. Alam, M.G.R.; Hassan, M.M.; Uddin, M.Z.; Almogren, A.; Fortino, G. Autonomic computation offloading in mobile edge for IoT applications. *Future Generation Computer Systems* **2019**, *90*, 149–157.
340. Liyanage, M.; Chang, C.; Srirama, S.N. mepaas: Mobile-embedded platform as a service for distributing fog computing to edge nodes. Parallel and Distributed Computing, Applications and Technologies (PDCAT), Proceedings of the 2016 17th International Conference on. IEEE, 2016, pp. 73–80.
341. Dogo, E.M.; Salami, A.F.; Aigbavboa, C.O.; Nkonyana, T. Taking cloud computing to the extreme edge: A review of mist computing for smart cities and industry 4.0 in Africa. *Edge computing* **2019**, pp. 107–132.
342. Hong, K.; Lillethun, D.; Ramachandran, U.; Ottenwalder, B.; Koldehofe, B. Mobile fog: A programming model for large-scale applications on the internet of things. Mobile Cloud Computing (MCC), Proceedings of the 2013 2nd ACM SIGCOMM workshop on. ACM, 2013, pp. 15–20.
343. Rindos, A.; Wang, Y. Dew computing: The complementary piece of cloud computing. Big Data and Cloud Computing (BDCloud), Social Computing and Networking (SocialCom), Sustainable Computing and Communications (SustainCom)(BDCloud-SocialCom-SustainCom), 2016 IEEE International Conferences on. IEEE, 2016, pp. 15–20.
344. Ray, P.P. An introduction to dew computing: definition, concept and implications. *IEEE Access* **2017**, *6*, 723–737.
345. Gushev, M. Dew computing architecture for cyber-physical systems and IoT. *Internet of things* **2020**, *11*, 100186.
346. Bhattacharyya, S.; Katramatos, D.; Yoo, S. Why wait? Let us start computing while the data is still on the wire. *Future Generation Computer Systems* **2018**, *89*, 563–574.
347. Oxford Living Dictionary. Subsidiarity, 2018.
348. Campbell, J.B.; Wynne, R.H. *Introduction to remote sensing*; Guilford Press, 2011.
349. Viani, F.; Rocca, P.; Oliveri, G.; Massa, A. Pervasive remote sensing through WSNs. 2012 6th European Conference on Antennas and Propagation (EUCAP). IEEE, 2012, pp. 49–50.
350. Sutaria, R.; Govindachari, R. Making sense of interoperability: Protocols and Standardization initiatives in IOT. 2nd International Workshop on Computing and Networking for Internet of Things, 2013, p. 7.
351. Triantafyllou, A.; Sarigiannidis, P.; Bibi, S. Precision agriculture: A remote sensing monitoring system architecture. *Information* **2019**, *10*, 348.
352. Ruiz-Fernandez, D.; Marcos-Jorquera, D.; Gilart-Iglesias, V.; Vives-Boix, V.; Ramerez-Navarro, J. Empowerment of patients with hypertension through BPM, IoT and remote sensing. *Sensors* **2017**, *17*, 2273.
353. Demetri, S.; Zuniga, M.; Picco, G.P.; Kuipers, F.; Bruzzone, L.; Telkamp, T. Automated estimation of link quality for LoRa: A remote sensing approach. 2019 18th ACM/IEEE International Conference on Information Processing in Sensor Networks (IPSN). IEEE, 2019, pp. 145–156.
354. Abdelwahab, S.; Hamdaoui, B.; Guizani, M.; Rayes, A. Enabling smart cloud services through remote sensing: An internet of everything enabler. *IEEE Internet of Things Journal* **2014**, *1*, 276–288.
355. Ismail, A.; Bagula, B.A.; Tuyishimire, E. Internet-of-things in motion: A uav coalition model for remote sensing in smart cities. *Sensors* **2018**, *18*, 2184.
356. Fraga-Lamas, P.; Ramos, L.; Mondejar-Guerra, V.; Fernandez-Carames, T.M. A review on IoT deep learning UAV systems for autonomous obstacle detection and collision avoidance. *Remote Sensing* **2019**, *11*, 2144.
357. Srivastava, A.N.; Oza, N.C.; Stroeve, J. Virtual sensors: Using data mining techniques to efficiently estimate remote sensing spectra. *IEEE Transactions on Geoscience and Remote Sensing* **2005**, *43*, 590–600.
358. Wang, W.; He, Z.; Huang, D.; Zhang, X. Research on service platform of internet of things for smart city. *The International Archives of Photogrammetry, Remote Sensing and Spatial Information Sciences* **2014**, *40*, 301.
359. Milgram, P.; Kishino, F. A taxonomy of mixed reality visual displays. *IEICE TRANSACTIONS on Information and Systems* **1994**, *77*, 1321–1329.
360. Batty, M. A perspective on city dashboards. *Regional Studies, Regional Science* **2015**, *2*, 29–32.
361. Bednarz, T.; Branchaud, D.; Wang, F.; Baker, J.; Marquarding, M. Digital Twin of the Australian Square Kilometre Array (ASKAP). SIG-GRAPH Asia 2020 Posters; Association for Computing Machinery: New York, NY, USA, 2020; SA '20. doi:10.1145/3415264.3425462.
362. Spielhofer, R.; Thrash, T.; Wissen Hayek, U.; Gret-Regamey, A.; Salak, B.; Grubel, Jascha.; Schinazi, V.R. Physiological and behavioral reactions to renewable energy systems in various landscape types. *Renewable and Sustainable Energy Reviews* **2021**, *135*, 110410. doi:https://doi.org/10.1016/j.rser.2020.110410.
363. Hua, J.; Lee, S.; Roman, G.C.; Julien, C. Arciot: Enabling intuitive device control in the internet of things through augmented reality. 2021 IEEE International Conference on Pervasive Computing and Communications Workshops and other Affiliated Events (PerCom Workshops). IEEE, 2021, pp. 558–564.

364. Tsiatsis, V.; Gluhak, A.; Bauge, T.; Montagut, F.; Bernat, J.; Bauer, M.; Villalonga, C.; Barnaghi, P.; Krco, S. The SENSEI Real World Internet Architecture. In *Towards the Future Internet: Emerging Trends from European Research*; IOS Press, 2010; pp. 247–256.
365. Weyrich, M.; Ebert, C. Reference architectures for the internet of things. *IEEE Software* **2016**, *33*, 112–116.
366. Di Martino, B.; Rak, M.; Ficco, M.; Esposito, A.; Maisto, S.A.; Nacchia, S. Internet of things reference architectures, security and interoperability: A survey. *Internet of Things* **2018**, *1*, 99–112.
367. Lynn, T.; Endo, P.T.; Ribeiro, A.M.N.; Barbosa, G.B.; Rosati, P. The internet of things: definitions, key concepts, and reference architectures. In *The Cloud-to-Thing Continuum*; Palgrave Macmillan, Cham, 2020; pp. 1–22.
368. De, S.; Barnaghi, P.; Bauer, M.; Meissner, S. Service modelling for the Internet of Things. *Computer Science and Information Systems (FedCSIS), 2011 Federated Conference on*. IEEE, 2011, pp. 949–955.
369. Asghari, P.; Rahmani, A.M.; Javadi, H.H.S. Service composition approaches in IoT: A systematic review. *Journal of Network and Computer Applications* **2018**, *120*, 61–77.
370. Hui, T.K.L.; Sherratt, R.S.; Sánchez, D.D. Major requirements for building Smart Homes in Smart Cities based on Internet of Things technologies. *Future Generation Computer Systems* **2017**, *76*, 358–369.
371. Laput, G.; Harrison, C. Exploring the efficacy of sparse, general-purpose sensor constellations for wide-area activity sensing. *Proceedings of the ACM on Interactive, Mobile, Wearable and Ubiquitous Technologies* **2019**, *3*, 1–19.
372. Chianese, A.; Piccialli, F. Designing a smart museum: When cultural heritage joins IoT. *Next Generation Mobile Apps, Services and Technologies (NGMAST), Proceedings of the 2014 8th International Conference on*. IEEE, 2014, pp. 300–306.
373. Suciu, G.; Vulpe, A.; Halunga, S.; Fratu, O.; Todoran, G.; Suciu, V. Smart cities built on resilient cloud computing and secure internet of things. *Control Systems and Computer Science (CSCS), Proceedings of the 2013 19th International Conference on*. IEEE, 2013, pp. 513–518.
374. Zanella, A.; Bui, N.; Castellani, A.; Vangelista, L.; Zorzi, M. Internet of things for smart cities. *IEEE Internet of Things Journal* **2014**, *1*, 22–32.
375. Alavi, A.H.; Jiao, P.; Buttlar, W.G.; Lajnef, N. Internet of Things-enabled smart cities: State-of-the-art and future trends. *Measurement* **2018**, *129*, 589–606.
376. Matern, A.; Binder, J.; Noack, A. Smart regions: insights from hybridization and peripheralization research. *European Planning Studies* **2020**, *28*, 2060–2077.
377. Sun, Y.; Song, H.; Jara, A.J.; Bie, R. Internet of things and big data analytics for smart and connected communities. *IEEE Access* **2016**, *4*, 766–773.
378. Glaeser, E.L.; Berry, C.R. Why are smart places getting smarter. *Rappaport Institute/Taubman Center Policy Brief* **2006**, *2*.
379. Meijer, A.; Bolívar, M.P.R. Governing the smart city: a review of the literature on smart urban governance. *international review of administrative sciences* **2016**, *82*, 392–408.
380. Shrouf, F.; Ordieres, J.; Miragliotta, G. Smart factories in Industry 4.0: A review of the concept and of energy management approached in production based on the Internet of Things paradigm. *2014 IEEE international conference on industrial engineering and engineering management*. IEEE, 2014, pp. 697–701.
381. Lu, Y.; Xu, X.; Wang, L. Smart manufacturing process and system automation—a critical review of the standards and envisioned scenarios. *Journal of Manufacturing Systems* **2020**, *56*, 312–325.
382. Kochovski, P.; Stankovski, V. Supporting smart construction with dependable edge computing infrastructures and applications. *Automation in Construction* **2018**, *85*, 182–192.
383. Rohokale, V.M.; Prasad, N.R.; Prasad, R. A cooperative Internet of Things (IoT) for rural healthcare monitoring and control. *Wireless Communication, Vehicular Technology, Information Theory and Aerospace & Electronic Systems Technology (Wireless VITAE), Proceedings of the 2011 2nd International Conference on*. IEEE, 2011, pp. 1–6.
384. Faria, R.; Brito, L.; Baras, K.; Silva, J. Smart mobility: A survey. *2017 International Conference on Internet of Things for the Global Community (IoTGC)*. IEEE, 2017, pp. 1–8.
385. Kontogianni, A.; Alepis, E. Smart tourism: State of the art and literature review for the last six years. *Array* **2020**, *6*, 100020.
386. Szilagyi, I.; Wira, P. Ontologies and Semantic Web for the Internet of Things—a survey. *IECON 2016-42nd Annual Conference of the IEEE Industrial Electronics Society*. IEEE, 2016, pp. 6949–6954.
387. de Matos, E.; Tiburski, R.T.; Moratelli, C.R.; Johann Filho, S.; Amaral, L.A.; Ramachandran, G.; Krishnamachari, B.; Hessel, F. Context information sharing for the Internet of Things: A survey. *Computer Networks* **2020**, *166*, 106988.
388. Perera, C.; Zaslavsky, A.; Christen, P.; Georgakopoulos, D. Context aware computing for the internet of things: A survey. *IEEE Communications Surveys & Tutorials* **2014**, *16*, 414–454.
389. Fremantle, P.; Scott, P. A survey of secure middleware for the Internet of Things. *PeerJ Computer Science* **2017**, *3*, e114.
390. Almusaylim, Z.A.; Zaman, N. A review on smart home present state and challenges: linked to context-awareness internet of things (IoT). *Wireless networks* **2019**, *25*, 3193–3204.
391. Rajagopalan, R.; Varshney, P.K. Data aggregation techniques in sensor networks: A survey. *IEEE Communications Surveys & Tutorials* **2006**.

- 
392. Wang, F.; Liu, J. Networked wireless sensor data collection: issues, challenges, and approaches. *IEEE Communications Surveys & Tutorials* **2011**, *13*, 673–687.
393. Li, S.; Xu, L.D.; Wang, X. Compressed sensing signal and data acquisition in wireless sensor networks and internet of things. *IEEE Transactions on Industrial Informatics* **2013**, *9*, 2177–2186.
394. Zhang, Y.; Meratnia, N.; Havinga, P.J.M. Outlier detection techniques for wireless sensor networks: A survey. *IEEE Communications Surveys & Tutorials* **2010**, *12*, 159–170.
395. Alsheikh, M.A.; Lin, S.; Niyato, D.; Tan, H.P. Machine learning in wireless sensor networks: Algorithms, strategies, and applications. *IEEE Communications Surveys & Tutorials* **2014**, *16*, 1996–2018.
396. Bagaa, M.; Challal, Y.; Ksentini, A.; Derhab, A.; Badache, N. Data aggregation scheduling algorithms in wireless sensor networks: Solutions and challenges. *IEEE Communications Surveys & Tutorials* **2014**, *16*, 1339–1368.
397. Al-Turjman, F.M. Information-centric sensor networks for cognitive IoT: an overview. *Annals of Telecommunications* **2017**, *72*, 3–18.
398. Bin, S.; Yuan, L.; Xiaoyi, W. Research on data mining models for the internet of things. Image Analysis and Signal Processing (IASP), Proceedings of the 2010 International Conference on. IEEE, 2010, pp. 127–132.
399. Tsai, C.W.; Lai, C.F.; Chiang, M.C.; Yang, L.T.; Others. Data mining for Internet of Things: A survey. *IEEE Communications Surveys & Tutorials* **2014**, *16*, 77–97.
400. Ganz, F.; Puschmann, D.; Barnaghi, P.; Carrez, F. A practical evaluation of information processing and abstraction techniques for the internet of things. *IEEE Internet of Things journal* **2015**, *2*, 340–354.
401. Chen, F.; Deng, P.; Wan, J.; Zhang, D.; Vasilakos, A.V.; Rong, X. Data mining for the internet of things: literature review and challenges. *International Journal of Distributed Sensor Networks* **2015**, *11*, 431047.
402. Ahmed, E.; Yaqoob, I.; Hashem, I.A.T.; Khan, I.; Ahmed, A.I.A.; Imran, M.; Vasilakos, A.V. The role of big data analytics in Internet of Things. *Computer Networks* **2017**, *129*, 459–471.
403. Shadroo, S.; Rahmani, A.M. Systematic survey of big data and data mining in internet of things. *Computer Networks* **2018**, *139*, 19–47.
404. Ge, M.; Bangui, H.; Buhnova, B. Big Data for Internet of Things: A Survey. *Future Generation Computer Systems* **2018**, *87*, 601–614.
405. Hadi, M.S.; Lawey, A.Q.; El-Gorashi, T.E.H.; Elmoghani, J.M.H. Big data analytics for wireless and wired network design: A survey. *Computer Networks* **2018**, *132*, 180–199.
406. Kulkarni, R.V.; Forster, A.; Venayagamoorthy, G.K. Computational intelligence in wireless sensor networks: A survey. *IEEE Communications Surveys & Tutorials* **2011**, *13*, 68–96.
407. Al-Garadi, M.A.; Mohamed, A.; Al-Ali, A.K.; Du, X.; Ali, I.; Guizani, M. A survey of machine and deep learning methods for internet of things (IoT) security. *IEEE Communications Surveys & Tutorials* **2020**, *22*, 1646–1685.
408. Atitallah, S.B.; Driss, M.; Boulila, W.; Ghézala, H.B. Leveraging Deep Learning and IoT big data analytics to support the smart cities development: Review and future directions. *Computer Science Review* **2020**, *38*, 100303.
409. Christidis, K.; Devetsikiotis, M. Blockchains and smart contracts for the internet of things. *IEEE Access* **2016**, *4*, 2292–2303.
410. Zheng, Z.; Xie, S.; Dai, H.; Chen, X.; Wang, H. An overview of blockchain technology: Architecture, consensus, and future trends. Big Data (BigData Congress), 2017 IEEE International Congress on. IEEE, 2017, pp. 557–564.
411. Dorri, A.; Kanhere, S.S.; Jurdak, R.; Gauravaram, P. Blockchain for IoT security and privacy: The case study of a smart home. Pervasive Computing and Communications Workshops (PerCom Workshops), Proceedings of the 2017 IEEE International Conference on. IEEE, 2017, pp. 618–623.
412. Khan, M.A.; Salah, K. IoT security: Review, blockchain solutions, and open challenges. *Future generation computer systems* **2018**, *82*, 395–411.
413. Mistry, I.; Tanwar, S.; Tyagi, S.; Kumar, N. Blockchain for 5G-enabled IoT for industrial automation: A systematic review, solutions, and challenges. *Mechanical systems and signal processing* **2020**, *135*, 106382.
414. Kranz, M.; Holleis, P.; Schmidt, A. Embedded interaction: Interacting with the internet of things. *IEEE Internet Computing* **2010**, *14*, 46–53.
415. Koreshoff, T.L.; Leong, T.W.; Robertson, T. Approaching a human-centred internet of things. Proceedings of the 25th Australian Computer-Human Interaction Conference: Augmentation, Application, Innovation, Collaboration, 2013, pp. 363–366.
416. Atzori, L.; Iera, A.; Morabito, G. Siot: Giving a social structure to the internet of things. *IEEE Communications Letters* **2011**, *15*, 1193–1195.
417. Vinyals, M.; Rodriguez-Aguilar, J.A.; Cerquides, J. A survey on sensor networks from a multiagent perspective. *The Computer Journal* **2011**, *54*, 455–470.
418. Wu, Q.; Ding, G.; Xu, Y.; Feng, S.; Du, Z.; Wang, J.; Long, K. Cognitive internet of things: a new paradigm beyond connection. *IEEE Internet of Things Journal* **2014**, *1*, 129–143.
419. Kataria, P. Towards a Semantic Classification of Possible Human-to-Environment Interactions in IoT. International Conference on Human-Computer Interaction. Springer, 2021, pp. 135–152.
420. Gath-Morad, M.; Aguilar, L.; Dalton, R.C.; Hölscher, C. cogarch: Simulating wayfinding by architecture in multilevel buildings. Proceedings of the 11th Annual Symposium on Simulation for Architecture and Urban Design, 2020, pp. 1–8.



421. Jacko, J.A. *Human computer interaction handbook: Fundamentals, evolving technologies, and emerging applications*; CRC press, 2012.
422. Helander, M.G. *Handbook of human-computer interaction*; Elsevier, 2014.
423. Chettri, L.; Bera, R. A comprehensive survey on Internet of Things (IoT) toward 5G wireless systems. *IEEE Internet of Things Journal* **2019**, *7*, 16–32.
424. Jo, D.; Kim, G.J. ARIoT: scalable augmented reality framework for interacting with Internet of Things appliances everywhere. *IEEE Transactions on Consumer Electronics* **2016**, *62*, 334–340.
425. Park, Y.; Yun, S.; Kim, K.H. When IoT met augmented reality: Visualizing the source of the wireless signal in AR view. Proceedings of the 17th Annual International Conference on Mobile Systems, Applications, and Services, 2019, pp. 117–129.
426. Michalakakis, K.; Aliprantis, J.; Caridakis, G. Visualizing the internet of things: naturalizing human-computer interaction by incorporating AR features. *IEEE Consumer Electronics Magazine* **2018**, *7*, 64–72.
427. Carneiro, J.; Rossetti, R.J.; Silva, D.C.; Oliveira, E.C. BIM, GIS, IoT, and AR/VR integration for smart maintenance and management of road networks: a review. 2018 IEEE international smart cities conference (ISC2). IEEE, 2018, pp. 1–7.
428. Jo, D.; Kim, G.J. AR enabled IoT for a smart and interactive environment: A survey and future directions. *Sensors* **2019**, *19*, 4330.
429. Chen, H.; Hou, L.; Zhang, G.K.; Moon, S. Development of BIM, IoT and AR/VR technologies for fire safety and upskilling. *Automation in Construction* **2021**, *125*, 103631.
430. Madsen, J.B.; Madsen, C.B. An interactive visualization of the past using a situated simulation approach. 2013 Digital Heritage International Congress (DigitalHeritage). IEEE, 2013, Vol. 1, pp. 307–314.
431. Schall, G.; Mendez, E.; Kruijff, E.; Veas, E.; Junghanns, S.; Reitinger, B.; Schmalstieg, D. Handheld augmented reality for underground infrastructure visualization. *Personal and ubiquitous computing* **2009**, *13*, 281–291.
432. Xu, X.; Ding, L.; Luo, H.; Ma, L. From building information modeling to city information modeling. *Journal of information technology in construction* **2014**, *19*, 292–307.
433. ElSayed, N.; Thomas, B.; Marriotti, K.; Piantadosi, J.; Smith, R. Situated analytics. 2015 Big Data Visual Analytics (BDVA). IEEE, 2015, pp. 1–8.
434. Zollmann, S.; Poglitsch, C.; Ventura, J. VISGIS: Dynamic situated visualization for geographic information systems. 2016 international conference on image and vision computing New Zealand (IVCNZ). IEEE, 2016, pp. 1–6.
435. Abao, R.P.; Malabanan, C.V.; Galido, A.P. Design and development of foodgo: A mobile application using situated analytics to augment product information. *Procedia Computer Science* **2018**, *135*, 186–193.
436. Dave, B.; Buda, A.; Nurminen, A.; Främling, K. A framework for integrating BIM and IoT through open standards. *Automation in Construction* **2018**, *95*, 35–45.
437. Lochhead, I.; Hedley, N. COMMUNICATING MULTILEVEL EVACUATION CONTEXT USING SITUATED AUGMENTED REALITY. *ISPRS Annals of Photogrammetry, Remote Sensing & Spatial Information Sciences* **2018**, *4*.
438. Pratt, P.; Ives, M.; Lawton, G.; Simmons, J.; Radev, N.; Spyropoulou, L.; Amiras, D. Through the HoloLens™ looking glass: augmented reality for extremity reconstruction surgery using 3D vascular models with perforating vessels. *European radiology experimental* **2018**, *2*, 1–7.
439. Stojanovic, V.; Trapp, M.; Richter, R.; Hagedorn, B.; Döllner, J. Towards the generation of digital twins for facility management based on 3D point clouds. *Management* **2018**, *270*, 279.
440. Lee, E.Y.; Tran, V.T.; Kim, D.; others. A novel head mounted display based methodology for balance evaluation and rehabilitation. *Sustainability* **2019**, *11*, 6453.
441. Guarese, R.; Becker, J.; Fensterseifer, H.; Walter, M.; Freitas, C.; Nedel, L.; Maciel, A. Augmented situated visualization for spatial and context-aware decision-making. Proceedings of the International Conference on Advanced Visual Interfaces, 2020, pp. 1–5.
442. Mourtzis, D.; Siatras, V.; Angelopoulos, J. Real-time remote maintenance support based on Augmented Reality (AR). *Applied Sciences* **2020**, *10*, 1855.
443. Vidal-Balea, A.; Blanco-Novoa, O.; Picallo-Guembe, I.; Celaya-Echarri, M.; Fraga-Lamas, P.; Lopez-Iturri, P.; Azpilicueta, L.; Falcone, F.; Fernández-Caramés, T.M. Analysis, design and practical validation of an augmented reality teaching system based on microsoft HoloLens 2 and edge computing. Engineering Proceedings. Multidisciplinary Digital Publishing Institute, 2020, Vol. 2, p. 52.
444. Vidal-Balea, A.; Blanco-Novoa, O.; Fraga-Lamas, P.; Vilar-Montesinos, M.; Fernández-Caramés, T.M. Creating collaborative augmented reality experiences for industry 4.0 training and assistance applications: Performance evaluation in the shipyard of the future. *Applied Sciences* **2020**, *10*, 9073.
445. Tang, S.; Shelden, D.R.; Eastman, C.M.; Pishdad-Bozorgi, P.; Gao, X. A review of building information modeling (BIM) and the internet of things (IoT) devices integration: Present status and future trends. *Automation in Construction* **2019**, *101*, 127–139.
446. Ang, L.M.; Seng, K.P. Big sensor data applications in urban environments. *Big Data Research* **2016**, *4*, 1–12.
447. Boubiche, S.; Boubiche, D.E.; Bilami, A.; Toral-Cruz, H. Big data challenges and data aggregation strategies in wireless sensor networks. *IEEE access* **2018**, *6*, 20558–20571.
448. Jones, D.; Snider, C.; Nassehi, A.; Yon, J.; Hicks, B. Characterising the Digital Twin: A systematic literature review. *CIRP Journal of Manufacturing Science and Technology* **2020**, *29*, 36–52.

449. Zhou, F.; Duh, H.B.L.; Billinghurst, M. Trends in augmented reality tracking, interaction and display: A review of ten years of ISMAR. 2008 7th IEEE/ACM International Symposium on Mixed and Augmented Reality. IEEE, 2008, pp. 193–202.
450. Nizam, S.M.; Abidin, R.Z.; Hashim, N.C.; Lam, M.C.; Arshad, H.; Majid, N. A review of multimodal interaction technique in augmented reality environment. *Int. J. Adv. Sci. Eng. Inf. Technol* **2018**, *8*, 8–4.
451. Kim, K.; Billinghurst, M.; Bruder, G.; Duh, H.B.L.; Welch, G.F. Revisiting trends in augmented reality research: A review of the 2nd decade of ISMAR (2008–2017). *IEEE transactions on visualization and computer graphics* **2018**, *24*, 2947–2962.
452. Liu, X.; Wang, X.; Wright, G.; Cheng, J.C.; Li, X.; Liu, R. A state-of-the-art review on the integration of Building Information Modeling (BIM) and Geographic Information System (GIS). *ISPRS International Journal of Geo-Information* **2017**, *6*, 53.
453. Helbing, D.; Fanitabasi, F.; Giannotti, F.; Hänggli, R.; Hausladen, C.I.; van den Hoven, J.; Mahajan, S.; Pedreschi, D.; Pournaras, E. Ethics of smart cities: Towards value-sensitive design and co-evolving city life. *Sustainability* **2021**, *13*, 11162.
454. Fonnet, A.; Prie, Y. Survey of immersive analytics. *IEEE transactions on visualization and computer graphics* **2019**, *27*, 2101–2122.

### Short Biography of Authors



**Jascha Grübel** is a doctoral student in Computer Science at ETH Zurich and a visiting fellow at Harvard University's Visual Computing Group. He is working at the intersection with Cognitive Science and City Science at the Chair of Cognitive Science at ETH Zurich. In his thesis, he is investigating human behaviour in public spaces with DT. In addition, his thesis is focusing on the visualisation of data in VR and AR such as through FTs and the analysis of Big Data as presented in this article. Jascha is also maintaining a framework to run VR experiments for scientific purposes called EVE that is intended to be intertwined in the future with this work to enable augmented reality experiments. This summer, Jascha will start work as a senior researcher at the Center for Sustainable Future Mobility at ETH Zurich on a Digital Twin of the Swiss Mobility System.

**Tyler Thrash** is currently a PhD student in Biology at Saint Louis University. Previously, he was a postdoctoral research in cognitive science and geography at ETH Zurich and the University of Zurich, respectively. His work has focused on spatial cognition and navigation from a largely ecological/Gibsonian perspective. With this approach, he attempts to explain higher-level cognition (e.g., biases in spatial memory) in terms of lower-level, perceptual processes (e.g., visual exposure to environmental structure). Dr. Thrash also develops simulations for interactive virtual environments and mathematical models for understanding human behaviour.



**Leonel Aguilar** is a Lecturer and Senior Researcher in Applied Artificial Intelligence at the Data Science, Systems and Services laboratory (DS3), ETH Zurich. He held postdoctoral appointments at the Cognitive Science (COG) and Computational Social Science (COSS) groups, ETH Zurich, and the Earthquake Research Institute of the University of Tokyo, Japan. Leonel obtained his PhD at the Computational Science and High-Performance Computing Laboratory at the University of Tokyo. His research focuses on modelling, simulating, and analysing social phenomena and the development and deployment of AI/ML-based systems to support this. He has worked on quantifying human behaviour through experiments and has leveraged these insights in AI-driven software for applications such as evacuation planning and education.

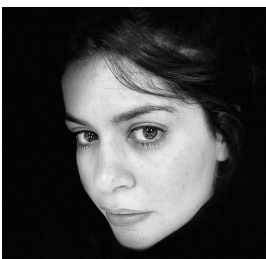

**Michal Gath-Morad** is an SNSF postdoctoral fellow at the University of Cambridge and at University College London, as well as a lecturer at the Chair of Cognitive Science at ETH Zurich. Michal is an architect by training and a cognitive scientist with a doctoral degree from ETH Zurich. Michal's interdisciplinary research and teaching seeks to develop, critically evaluate, and creatively experiment with methods of evidence-based co-design in architectural design pedagogy and praxis to promote health and well-being by architecture.



**Julia Chatain** is a doctoral student at ETH Zurich with the ETH Game Technology Center and the Professorship for Learning Sciences and Higher Education. Her work focuses on embodiment, and, in particular, the role of embodied interaction and embodied concreteness in learning abstract concepts and making mathematics graspable. In this context, she explores AR and VR as means to implement embodied interaction supporting embodied cognition. Her work is supported by the Future Learning Initiative of ETH Zurich.



**Robert W. Sumner** is the Director of Research and Development at the Walt Disney Studios and an Adjunct Professor at ETH Zurich. Robert received a B.S. degree in computer science from the Georgia Institute of Technology and his M.S. and Ph.D. degrees from the Massachusetts Institute of Technology. At ETH, Prof. Sumner teaches a course called the Game Programming Laboratory in which students from ETH and the Zurich University of the Arts work in small teams to design and implement novel video games. In 2015, Prof. Sumner founded the ETH Game Technology Center, which explores the unique way game technology can advance ETH's mission in research, education, and outreach. Prof. Sumner was featured on BBC Click and Ars Technica for his work on Unfolding the 8-Bit Era as well as Reuters for his augmented reality research.



**Christoph Hölscher** is Full Professor of Cognitive Science in the D-GESS at ETH Zurich since 2013, with an emphasis on Applied Cognitive Science. Since 2016 Christoph is a Principal Investigator at the Singapore ETH Center (SEC) Future Cities Laboratory, heading a research group on 'Cognition, Perception and Behaviour in Urban Environments'. Christoph is the Program Director of Future Resilient Systems FRS at the SEC since 2019, leading the current FRS 2 phase (2020-2025). He holds a PhD in Psychology from University of Freiburg, served as honorary senior research fellow at UCL, Bartlett School of Architecture, and as a visiting Professor at Northumbria University Newcastle. Christoph has several years of industry experience in Human-Computer Interaction and usability consulting.



**Victor R. Schinazi** is Assistant Professor at the Psychology Department of Bond University and PI of the Early Detection of Health Risks and Prevention module in the Future Health Technologies programme in Singapore. Previously, Victor was a Senior Lecturer at the Chair of Cognitive Science and the GeoGazeLab at the ETH Zurich. He also served as co-PI for the Cognition, Perception and Behaviour in Urban Environments project at the Future Cities Laboratory in Singapore. Victor holds a PhD from the Centre for Advanced Spatial Analysis (CASA, UCL). He also was a Postdoctoral Fellow at the Center for Cognitive Neuroscience (UPenn) and served as Chief Science Officer for Strategic Spatial Solutions, Inc. Victor has published high impact articles and book chapters in psychology, cognitive neuroscience, geography and computer science.