

Learning Wave Propagation with Attention-Based Convolutional Recurrent Autoencoder Net

Indu Kant Deo^{a)} and Rajeev Jaiman^{b)}

Department of Mechanical Engineering, University of British Columbia, V6T 1Z4, Canada

(Dated: 11 February 2022)

In this paper, we present an end-to-end attention-based convolutional recurrent autoencoder network (AB-CRAN) for data-driven modeling of wave propagation phenomena. To construct the low-dimensional learning model, we employ a denoising-based convolutional autoencoder from the full-order snapshots of wave propagation generated by solving hyperbolic partial differential equations. The proposed deep neural network architecture relies on the attention-based recurrent neural network (RNN) with long short-term memory (LSTM) cells for constructing the trajectory in the latent space. We assess the proposed AB-CRAN framework against the standard RNN-LSTM for the low-dimensional learning of wave propagation. To demonstrate the effectiveness of the AB-CRAN model, we consider three benchmark problems namely one-dimensional linear convection, nonlinear viscous Burgers and two-dimensional Saint-Venant shallow water system. Using the time-series datasets from the benchmark problems, our novel AB-CRAN architecture accurately captures the wave amplitude and preserves the wave characteristics of the solution for long time horizons. The attention-based sequence-to-sequence network increases the time-horizon of prediction by five times compared to the standard RNN-LSTM. Denoising autoencoder further reduces the mean squared error of prediction and improves the generalization capability in the parameter space.

Keywords: Wave propagation; Hyperbolic PDEs; Reduced order modeling; Convolutional recurrent net; Denoising autoencoders; Attention mechanism; Sequence-to-sequence modeling;

I. INTRODUCTION

A wide range of physical phenomena involving wave motion and convective transport process can be modeled via hyperbolic systems of partial differential equations²⁸. Efficient and accurate solutions to these high-dimensional PDEs are critical in various scientific and engineering disciplines ranging from gravitational waves, electromagnetic waves, shock waves in fluids, shallow water waves to underwater noise propagation. However, solving these high-dimensional PDEs using numerical discretization can be computationally expensive and they are not attractive for parametric analysis, design optimization and control-related tasks. For example, there is a pressing need for efficient large-scale prediction, better decision making and effective mitigation strategies for underwater radiated noise caused by various human activities such as ship traffic, sonar and seismic air gun blasts¹⁴. Anthropogenic noise is shown to adversely impact marine animals¹², which is a major concern for both environmentalists and the offshore/shipbuilding industry. End-to-end prediction of noise radiation from widely varying distributed sources forms a multiquery problem which necessitates a data-driven modeling capability to scan a large parameter space for nearly real-time prediction and decision making. Specifically, this work is primarily motivated by the development a framework for parametric data-driven predictions of wave propagation and convection-dominated physical phenomena.

Using state-of-the-art discretization techniques such as finite volume or finite element, one can solve a parametric

system of hyperbolic partial differential equations over arbitrary geometries and obtain a full-order solution that is high-fidelity. When dealing with multiquery problems, the full-order model becomes prohibitively expensive for large-scale settings. To address such limitations of full-order model (FOM) based on the discretized PDEs in engineering applications, reduced-order modeling techniques are being used, which seek to replace the full-order model with a lower dimension reduced-order model (ROM) capable of expressing the physical properties of the problem described by the FOM. The fundamental assumption underlying the design of such a ROM comes from the manifold hypothesis¹⁵, which states that any set of real-world high-dimensional data is spanned by an optimal subspace embedded in R^N , where N is large. The above hypothesis serves as the foundation of data-driven dimensionality reduction, in which an approximate low-dimensional representation is built to describe the dynamics of high-dimensional data. Through a suitable approximate model, the goal of a ROM is then to construct the solution manifold that follows the PDE solutions in the parameter space. The ultimate goal of this study is to create a data-driven reduced-order model for hyperbolic PDEs.

However, it is challenging to reduce the dimensionality of convection-dominated problems governed by hyperbolic PDEs using traditional projection-based ROMs. Snapshot matrices of hyperbolic PDEs have slowly decaying Kolmogorov n -widths^{16,19}, thus posing severe difficulties in reducing the solution effectively on a linear subspace. To address this difficulty, several nonlinear manifolds learning methods are being developed such as iso-map⁴⁴, kernel principal component analysis^{30,38}, and diffeomorphic dimensionality reduction^{34,41}. These models attempt to reduce the dimensionality of the convection-dominated problem (i.e., wave propagation) and construct nonlinear ROM. Although

^{a)}Electronic mail: indukant@mail.ubc.ca

^{b)}Electronic mail: rjaiman@mech.ubc.ca

nonlinear manifold learning approaches have been demonstrated with some success in reducing the dimensionality of data with a relatively large Kolmogorov n -width, they often lack simplicity and generality mapping the data from the reduced dimension to the high-dimensional physical space. As a result, many of these methods are usually not the preferred choice in the engineering community when it comes to reduced-order modeling of hyperbolic PDE systems. To overcome such limitations, nonlinear dimensionality reduction based on neural networks²² are explored (e.g., autoencoders), which allow projecting the input physical data to a latent low-dimension space and back to the original physical dimension^{8,16,18,27,29,42,47}. Instead of the projection, the low-dimensional model in the latent space can be achieved by generating the trainable layers of the encoder and decoder space such that the error function is minimized. Using a series of convolutional and nonlinear mapping processes, autoencoders can provide an efficient construction of a compressed latent space to characterize the reduced dynamics of a given nonlinear system. The autoencoders can be interpreted as a flexible and nonlinear generalization of POD^{7,37}.

In recent years, deep learning has witnessed a resurgence with groundbreaking successes in a wide range of technological and engineering applications²⁶. Reduced-order modeling is one of such applications, in which a deep learning model can be used as a black box technique to approximate a physical system in low-dimension and to use for inference. For example, using deep learning algorithms, one can construct data-driven reduced-order models of fluid flow^{31,33} and nonlinear dynamical systems e.g., fluid-structure interaction³². By extracting features and underlying dynamics from data, deep learning models can learn complex relationships and patterns for the purpose of inference. Deep neural networks are one of the most popular deep learning models, have proven to be an extremely effective method for a low-dimensional representation of a wide range of physical systems such as Navier-Stokes equations⁴⁸, turbulence modelling¹⁷, and among others. However, it is widely acknowledged that the training of deep learning models may require a substantial amount of data and computational time. There is also a growing interest to incorporate prior knowledge into these models to improve interpretability. Some prior knowledge and inductive biases can provide interpretability and help reducing the amount of data required in these deep learning models. This intent has resulted into the development of physics-guided neural networks, which incorporate domain-specific physical information into deep learning architectures⁴⁶.

The construction of heavily over-parametrized functions by deep neural networks rely on the foundations of the Kolmogorov–Arnold representation theorem⁴⁰ and the universal approximation of functions via neural networks^{11,24}. For the data-driven modeling of nonlinear PDEs, deep neural network architectures such as convolutional recurrent autoencoder (CRAN) can be efficient and useful for constructing low-dimensional learning models^{7,18,21}. CRAN is a fully data-driven approach in which both the low-dimensional representation of the state and its time evolution are learned using deep learning algorithms. Convolutional recurrent autoencoders

have been shown to perform well for unsteady flow and fluid-structure phenomenon^{7,8,21}. However, the CRAN architecture may suffer difficulties to learn PDEs with a dominant hyperbolic character and wave-like behavior. In particular, there are challenges to build a low-dimensional manifold by convolutional autoencoder and to evolve these low-dimensional latent representations via RNN-LSTM for a longer time horizon. Evolving these low-dimensional data in time with an RNN-LSTM presents the challenge of having a large data set that incorporates various physical events in the training set⁴².

The current work builds upon our previous work on the convolutional recurrent autoencoder net for the unsteady flow dynamics and fluid-structure interaction^{7,21}. By employing the CRAN architecture, our objective is to develop reduced-order model for hyperbolic PDEs and convection-dominated phenomena. To deal with the fundamental n -width deficiency of linear subspaces, we employ a denoising-based convolutional autoencoder for convection-dominated phenomena that can be effective learning a low-dimensional manifold for large Kolmogorov n -width data. We propose a new deep learning architecture for a low-dimensional learning model of nonlinear hyperbolic PDEs. We integrate the knowledge of numerical integration into the deep neural architecture by introducing attention-based sequence-to-sequence modeling in the evolver function. The evolver layer incorporates the knowledge of weighting multiple input time-steps via an attention-based sequence-to-sequence modeling and summarises the input sequence into a vector stream that predicts the future evolution of spatial patterns over long time horizons. In a nutshell, the vital contributions of the current work are as follows:

- Synchronous multi-time stepping prediction procedure via attention-based sequence-to-sequence modeling;
- Assessment of a denoising-based convolutional autoencoder to learn low-dimensional manifold for hyperbolic partial differential equations;
- Incorporation of a novel hybrid supervised-unsupervised training strategy for training denoising convolutional autoencoder and evolver network simultaneously;
- Demonstration the effectiveness of the proposed formulation for convection-dominated (i.e., wave propagation) physics obtained from the linear convection, nonlinear viscous Burgers, and 2D Saint-Venant shallow water equations.

The rest of the paper is organized as follows. Section 2 briefly presents the mathematical preliminaries. The details of the proposed attention-based convolutional recurrent autoencoder net are discussed in Section 3. In Section 4, we introduce the hybrid supervised-unsupervised training strategy and explain the key aspects of the AB-CRAN architecture. Section 5 presents the numerical assessment of the AB-CRAN for the one-dimensional linear convection, the viscous Burgers equation and two-dimensional Saint-Venant shallow water problem. Finally, Section 6 concludes with a brief discussion of our findings and some directions for future research.

II. MATHEMATICAL BACKGROUND

In this section, we review the reduced-order modeling methodology, starting with a full-order numerical solution of the time-dependent parametric partial differential equation (PPDE). The numerical solution of a parametric PDE provides the framework to generate data for a reduced-order model. A generic parametric partial differential equation can be presented in an abstract form:

$$\begin{aligned} \frac{\partial}{\partial t} \mathbf{U}(\mathbf{X}, t; \mu) &= \mathcal{F}(\mathbf{U}(\mathbf{X}, t; \mu)) && \text{on } \Omega \times [0, T] \times \mathcal{M}, \\ \mathbf{U}(\mathbf{X}, 0; \mu) &= \mathbf{U}_0(\mathbf{X}, \mu) && \text{on } \Omega \times \mathcal{M}, \\ \mathbf{U}(\mathbf{X}, t; \mu) &= \mathbf{U}_{\partial\Omega}(\mathbf{X}, \mathbf{t}, \mu) && \text{on } \partial\Omega \times [0, T] \times \mathcal{M}, \end{aligned} \quad (1)$$

where $\Omega \subset \mathbb{R}^i$ ($i = 1, 2, 3$) denotes the spatial domain, $\mathcal{M} \subset \mathbb{R}^m$ and \mathcal{F} is a generic nonlinear operator describing the dynamics of the system. The solution field of the system is represented by $\mathbf{U}: \Omega \times [0, T] \times \mathcal{M} \rightarrow \mathbb{R}$ and appropriately chosen initial $\mathbf{U}_0(\mathbf{X}, \mu)$ and boundary conditions $\mathbf{U}_{\partial\Omega}(\mathbf{X}, \mathbf{t}, \mu)$. Here μ is the number of control parameters in the problem and may represent the material properties or shape parameters of interest. Using numerical discretization techniques (e.g., finite volume or finite element), the PPDE can be discretized in the spatial domain, yielding a set of parametric nonlinear semi-discrete ordinary differential equations (ODEs) as follows:

$$\begin{aligned} \frac{d}{dt} \mathbf{U}_N(\mathbf{X}_N, t; \mu) &= \mathcal{F}_N(\mathbf{U}_N(\mathbf{X}_N, t; \mu)) && \text{on } \Omega_N \times [0, T] \times \mathcal{M}, \\ \mathbf{U}_N(\mathbf{X}_N, 0; \mu) &= \mathbf{U}_0(\mathbf{X}_N, \mu) && \text{on } \Omega_N \times \mathcal{M}, \\ \mathbf{U}_N(\mathbf{X}_N, t; \mu) &= \mathbf{U}_{\partial\Omega}(\mathbf{X}_N, \mathbf{t}, \mu) && \text{on } \partial\Omega_N \times [0, T] \times \mathcal{M}, \end{aligned} \quad (2)$$

where $\Omega_N \subset \mathbb{R}^N$, $\mathbf{U}_N: \Omega_N \times [0, T] \times \mathcal{M} \rightarrow \mathbb{R}^N$ is a discrete solution and N is the number of spatial degrees of freedom. In order to solve Eq. (2), suitable time discretizations techniques are employed to evolve the spatially discretized solution in time. The above nonlinear semi-discrete system is common in computational physics e.g., the numerical solutions of the Euler equations and compressible Navier-Stokes equations will lead to such a nonlinear semi-discrete system.

For given $(t; \mu)$ varying in $[0, T] \times \mathcal{M}$, the set of solution fields of Eq. (1) is known as solution manifold represented by \mathbf{S}_U as:

$$\mathbf{S}_U = \left[\mathbf{U}_{N, \mu_1}^{(t_1)} | \dots | \mathbf{U}_{N, \mu_1}^{(N_T)} | \dots | \mathbf{U}_{N, \mu_{N_{\text{train}}}}^{(t_1)} | \dots | \mathbf{U}_{N, \mu_{N_{\text{train}}}}^{(N_T)} \right]. \quad (3)$$

When $\mu \in \mathcal{M}$, the solution field of Eq. (1) admits a unique solution for each $t \in [0, T]$. The intrinsic dimension of solution field belonging in the solution manifold is at most $n_\mu + 1 \ll N$, where n_μ is the number of parameters. Time also plays an important role of additional coordinate. This means that each point $\mathbf{U}_{N, \mu}^{(t)}$ belonging to \mathbf{S}_U is completely defined in terms of at most $n_\mu + 1$ intrinsic coordinates. In this problem, we want to avoid solving Eq. (1) by constructing a low dimensional manifold whose dimension is as close to intrinsic coordinates as possible and a time advancement strategy on this manifold exclusively from training data. Therefore, our objective is to achieve the low-dimensional approximation of the entire set of solutions to the parametric PDE given by Eq. (1).

A. Projection-based Reduced Order Modeling

Projection-based reduced-order models aim to generate a low-dimensional representation that approximates the original system over a specified parameter range. We consider the task of finding a low-dimensional model of the system of ODEs in Eq. (2) with a ROM as:

$$\frac{d}{dt} \mathbf{U}_r(\mathbf{X}_r, t; \mu) = \mathcal{F}_r(\mathbf{U}_r(\mathbf{X}_r, t; \mu)) \text{ on } \Omega_r \times [0, T] \times \mathcal{M}, \quad (4)$$

where $\dim(\mathbf{U}_r) \ll \dim(\mathbf{U}_N)$. One approach for creating such a ROM is to introduce a reduced linear trial manifold¹. A linear ROM seeks to approximate the full dimension solution in the following form:

$$\mathbf{U}_{N, \mu}^{(t)} \approx \mathbf{V} \mathbf{U}_{r, \mu}^{(t)}, \quad (5)$$

where $\mathbf{U}_{N, \mu}^{(t)} \in \mathbb{R}^N$ denotes the full state vector, the columns of the matrix $\mathbf{V} \in \mathbb{R}^{N \times r}$ contain r basis vectors. The basis vector \mathbf{V} is assumed to be time-invariant. Here $\mathbf{U}_{r, \mu}^{(t)} \in \mathbb{R}^r$ denotes the low-dimensional representation often called generalized coordinates. By substituting the above subspace approximation in Eq. (2) will lead to:

$$\begin{aligned} \frac{d}{dt} \mathbf{V} \mathbf{U}_r(\mathbf{X}_r, t; \mu) - \mathcal{F}_N(\mathbf{V} \mathbf{U}_r(\mathbf{X}_r, t; \mu)) &= \mathbf{r}(t) \text{ on } \Omega_N \times [0, T] \\ &\times \mathcal{M}, \end{aligned} \quad (6)$$

where $\mathbf{r}(t) \in \mathbb{R}^N$ is the residual due to the subspace approximation³⁹. This residual is constrained to be orthogonal to a subspace \mathcal{W} . The subspace \mathcal{W} is defined by a test basis $\mathbf{W} \in \mathbb{R}^{N \times r}$, this leads to compute $\mathbf{U}_{r, \mu}^{(t)}$ such that:

$$\mathbf{W}^T \mathbf{r}(t) = 0. \quad (7)$$

Assuming $\mathbf{W}^T \mathbf{V}$ is non-singular, if $\mathbf{W} = \mathbf{V}$ and \mathbf{V} is orthogonal, the projection method is called a Galerkin projection⁴ and the resulting ROM can be written as:

$$\begin{aligned} \frac{d}{dt} \mathbf{U}_r(\mathbf{X}_r, t; \mu) - (\mathbf{W}^T \mathbf{V})^{-1} \mathbf{W}^T \mathcal{F}_N(\mathbf{V} \mathbf{U}_r(\mathbf{X}_r, t; \mu)) &= 0 \text{ on } \Omega_r \\ &\times [0, T] \times \mathcal{M}, \end{aligned} \quad (8)$$

which will yield:

$$\begin{aligned} \frac{d}{dt} \mathbf{U}_r(\mathbf{X}_r, t; \mu) - \mathbf{V}^T \mathcal{F}_N(\mathbf{V} \mathbf{U}_r(\mathbf{X}_r, t; \mu)) &= 0 \text{ on } \Omega_r \times [0, T] \\ &\times \mathcal{M}. \end{aligned} \quad (9)$$

For constructing efficient test bases (\mathbf{W}), proper orthogonal decomposition has been widely used. POD basis vectors are computed empirically using a set of data that samples the range of relevant system dynamics. POD in conjunction with the Galerkin projection technique is commonly used to build

such ROMs⁵. One of the main disadvantages of such techniques is that they need access to the operator of the governing differential equation for evolving the basis functions.

In order to quantify the optimality of the test subspace²⁰, Kolmogorov n -width is used which can be stated as follows:

$$d_n(\mathcal{M}) := \inf_{\mathcal{S}_r} \sup_{\mathbf{U}_N \in \mathcal{M}} \inf_{\mathbf{U}_r \in \mathcal{S}_r} \|\mathbf{U}_{N,\mu}^{(t)} - \mathbf{V}\mathbf{U}_{r,\mu}^{(t)}\|, \quad (10)$$

where the first infimum is taken over all r -dimensional subspaces of the state space, and \mathcal{M} denotes the manifold of solutions over time and parameters³⁶. For problems governed by hyperbolic PDEs (e.g., convection-dominated problems), the snapshot matrix exhibits slowly decaying Kolmogorov n -width. In such cases, the use of low-dimensional linear trial subspaces often produces inaccurate results; the ROM dimensionality must be significantly increased to yield acceptable accuracy³⁵. Indeed, the Kolmogorov n -width with n equal to the intrinsic solution-manifold dimensionality is often quite large for such problems. To address the n -width limitation of linear trial subspaces, several approaches have been pursued. One approach involves learning a nonlinear manifold to improve its approximation properties for convection-dominated problems.

III. ATTENTION-BASED CONVOLUTIONAL RECURRENT AUTOENCODER NET

A. Review of Convolutional Autoencoders

To learn a nonlinear manifold, we employ a denoising-based convolutional autoencoder to train an encoder network that projects high-dimensional data onto a low-dimensional manifold. Using an encoder-to-decoder network with activation functions, one can learn a mapping from a low-dimension manifold to physical space via autoencoders, similar to projection-based ROM such as proper orthogonal decomposition. Through autoencoders, the input data can be encoded to a reduced latent space which can be recovered back to the original input data via a decoder network. Similar to POD, autoencoders perform the minimization of L_2 -norm of the error to construct the weights via backpropagation. Once converged, it can be shown that the latent dimension of autoencoders span the same subspace as the proper orthogonal decomposition^{2,37}. In contrast to the POD-based reduced-order model, autoencoders can provide greater flexibility for dimensionality reduction. We use a denoising-based convolutional autoencoder as a nonlinear generalization of the POD⁷. A nonlinear ROM can be used to construct the approximation $\tilde{\mathbf{U}}_{N,\mu}^{(t)}$ using the full state solutions $\mathbf{U}_{N,\mu}^{(t)}$ as follows:

$$\left. \begin{aligned} \mathbf{U}_{r,\mu}^{(t)} &= \Psi_E(\mathbf{U}_{N,\mu}^{(t)}; \theta_E), \\ \tilde{\mathbf{U}}_{N,\mu}^{(t)} &= \Psi_D(\mathbf{U}_{r,\mu}^{(t)}; \theta_D), \end{aligned} \right\} \quad (11)$$

where $\tilde{\mathbf{U}}_{N,\mu}^{(t)} \in \mathbb{R}^N$ denotes the approximation of the full state, $\mathbf{U}_{N,\mu}^{(t)} \in \mathbb{R}^N$ represents the full state, $\Psi_E(\cdot; \theta_E)$ stands for the

encoder network that maps the full state to a low-dimensional manifold, and $\Psi_D(\cdot; \theta_D)$ denotes the decoder network that maps the low-dimensional data back to the high-dimensional physical state. By backpropagating the L_2 error, the weights of the network can be trained. Here $\mathbf{U}_{r,\mu}^{(t)} \in \mathbb{R}^r$ represents the solution on low-dimensional manifold. Our objective is to create a ROM with a dimension r that is as close to the intrinsic dimension $n_\mu + 1$ of the solution manifold \mathbf{S}_U as possible.

We employ an autoencoder as a convolutional autoencoder for the following reasons. To begin, autoencoders need flattening multi-dimensional input data into a one-dimensional array, which can be a significant bottleneck when applied to spatio-temporal data. Flattening leads to a loss in local spatial relationships between the data. As a result, we want the convolution filters to extract the spatially dominant structures from the multi-dimensional data. Second, because the solution of hyperbolic PDEs is wave-like, initial disturbance propagates through the domain with a finite speed. They travel along with the characteristics of the equations. We exploit the convolutional neural network's translational invariant property to model the hyperbolic PDE's disturbance propagation.

To illustrate further, consider a linear convection equation as a model of hyperbolic PDE:

$$\left. \begin{aligned} \frac{\partial U}{\partial t} + C \frac{\partial U}{\partial x} &= 0, \\ U(X, 0) &= U_0, \end{aligned} \right\} \quad (12)$$

where C denotes the wave speed. The solution of the above equation is given by shifting the initial solution at time $t = 0$, which can be expressed analytically at time t as

$$U(X, t) = U_0(X - Ct). \quad (13)$$

This is illustrated in the Fig. 1 as well. With regard to the data-driven prediction of this simple process, convolutional neural networks incorporate inherent translation invariance, making them more suitable for dealing with hyperbolic PDEs data. The convolutional neural network achieves translation invariance through the use of a combination of convolutional and max-pooling layers. The convolutional layer condenses the input into a set of features and their positions. Using the max-pooling layer, the convolutional layer's output is reduced in dimension. It accomplishes this by outputting only the maximum value from a grid. As a result, the information regarding the exact location of the maximum value within the grid is discarded. This is generally referred to as the translation invariance in the convolutional neural networks. Layers of convolutional neural networks are arranged into feature maps, with each unit in a feature map linked to a prior layer's local domain through a filter. Consider a two-dimensional input, $U \in \mathbb{R}^{N_x \times N_y}$, where a convolutional layer is composed of a collection of F filters $K^f \in \mathbb{R}^{a \times b}$, each of which creates a feature map $Y^f \in \mathbb{R}^{n_x \times n_y}$ through a two-dimensional discrete convolution, and nonlinearity σ , which can be expressed as follows:

$$\mathbf{Y}_{i,j}^f = \sigma \left(\sum_k \sum_l \mathbf{K}_{k,l}^f \mathbf{U}_{(i-k),(j-l)} \right). \quad (14)$$

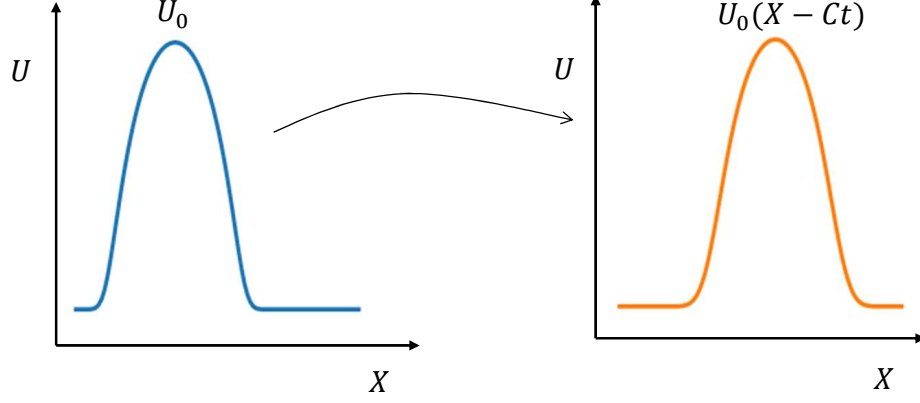

FIG. 1. A simple illustration of the solution of linear convection at time t by shifting initial solution U_0 .

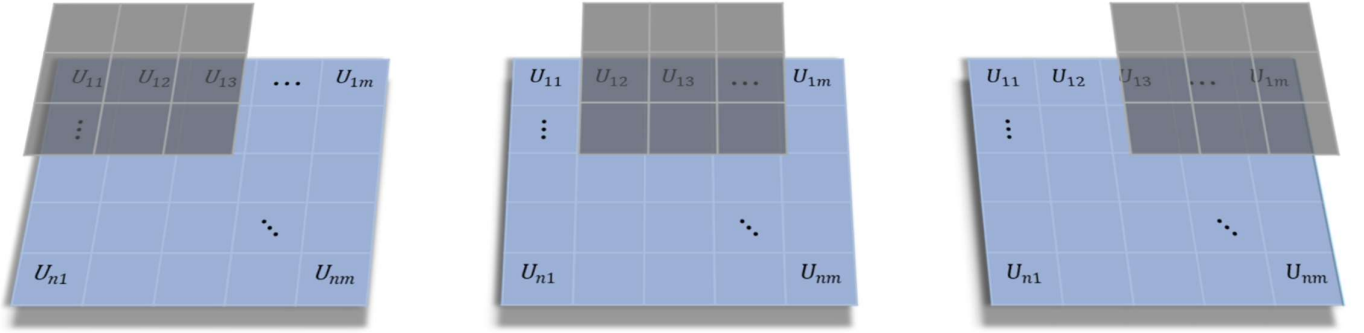

FIG. 2. A simple illustration of the convolution operation with stride one and dilation rate one.

Figure 2 shows the discrete convolution process. This operation produces a F -dimensional output $\mathbf{Y}(\mathbf{x}) = (y_1(\mathbf{x}), \dots, y_F(\mathbf{x}))$ often referred to as the feature maps or convolutional maps. To extract the local features from a Euclidean space, the standard convolutional process can be given by:

$$(\mathbf{U} * \gamma)(\mathbf{x}) = \int_{\Omega} \mathbf{U}(\mathbf{x} - \mathbf{x}') k(\mathbf{x}') d\mathbf{x}'. \quad (15)$$

For introducing point-wise nonlinearity, one can employ various activation functions such as sigmoid activation $\sigma(z) = (1 + e^{-z})^{-1}$. Activation function allows nonlinear flow features to be captured in the discrete convolutional process. Furthermore, a pooling or downsampling layer $\mathbf{g} = P(\mathbf{U})$ may be used, defined as

$$g_l(\mathbf{x}) = P(\{\mathbf{U}_l(\mathbf{x}') : \mathbf{x}' \in \mathcal{N}(\mathbf{x})\}), l = 1, \dots, F, \quad (16)$$

where $\mathcal{N}(\mathbf{x}) \subset \Omega_N$ is a neighborhood around \mathbf{x} and P is a pooling operation such as L_1 , L_2 or L_∞ norm. A convolutional network is constructed by composing several convolutional and pooling layers, obtaining a generic compositional representation as follows:

$$\theta_{\text{CNN}}(\mathbf{U}) = (C_{K^{(L)}} \cdots P \cdots C_{K^{(2)}} \circ C_{K^{(1)}})(\mathbf{U}) \quad (17)$$

where $\theta_{\text{CNN}} = \{K^{(1)}, \dots, K^{(L)}\}$ is the hyper-vector of the network parameters consisting of all the filter banks. The model is said to be deep if it comprises multiple CNN layers. Notably, Eq. (14) is modified slightly if the convolutional blocks are skipped on more than one element of the input function along any Cartesian direction. The skipping lengths along the three directions of the input is termed as the stride $s_L = [s_x \ s_y \ s_z]$ and is an important hyperparameter for the dimensionality reduction. CNNs possess multi-scale characteristics which allow them to scale easily to multi-dimensional Euclidean space. The output features enjoy translation invariance, which makes CNN ideal for processing hyperbolic PDEs data. Stationarity and stability to local translations in the dataset are leveraged by CNNs⁶. A representative sketch of the convolutional autoencoder architecture for the linear convection problem is shown in Fig. 3. Training this convolutional autoencoder then consists of finding the parameters that minimize the expected reconstruction error over all training examples given by

$$\theta_E^*, \theta_D^* = \arg \min_{\theta_E, \theta_D} \mathcal{L}[\mathbf{U}_{N,\mu}^{(t)}, \Psi_D(\Psi_E(\mathbf{U}_{N,\mu}^{(t)}))], \quad (18)$$

where $\mathcal{L}(\mathbf{U}_{N,\mu}^{(t)}, \Psi_D(\Psi_E(\mathbf{U}_{N,\mu}^{(t)})))$ is a loss function in the L^2 norm, which minimizes the difference between $\Psi_D(\Psi_E(\mathbf{U}_{N,\mu}^{(t)}))$ and $\mathbf{U}_{N,\mu}^{(t)}$. This minimization promotes $\Psi_D \circ$

Ψ_E to merely learn to copy input to output. In order to learn the latent representation of the data, under-complete autoencoders are used in which the latent dimension is less than the input dimension of the data. There are several other regularised autoencoders that includes contractive autoencoders, denoising autoencoders or sparse autoencoders, which utilize different techniques to learn robust latent representation which generalizes better for the testing data.

To learn a general latent representation instead of loss in Eq. (18), a denoising autoencoder minimizes the following loss:

$$\mathcal{L}[\mathbf{U}_{N,\mu}^{(t)}, \Psi_D(\Psi_E(\bar{\mathbf{U}}_{N,\mu}^{(t)}))], \quad (19)$$

where $\bar{\mathbf{U}}_{N,\mu}^{(t)}$ is a copy of $\mathbf{U}_{N,\mu}^{(t)}$ that has been added with some form of noise. Denoising autoencoders must therefore undo this corruption rather than simply copying their input. Denoising training forces Ψ_E and Ψ_D to implicitly learn the structure of data. A denoising based convolutional-autoencoder⁴⁵ is explored in the current architecture which helps in discovering robust representation of the spatio-temporal data. As a result, the denoising based convolutional-autoencoder can be viewed as a method for defining and learning a manifold. The low dimension representation from the encoder layer, $\mathbf{U}_{r,\mu}^{(t)} = \Psi_E(\mathbf{U}_{N,\mu}^{(t)}; \theta_E)$ can be thought of as a coordinate system for manifold points. More generally, one can think of $\mathbf{U}_{r,\mu}^{(t)}$ as a representation of $\mathbf{U}_{N,\mu}^{(t)}$ which is well suited to capture the main variations in the data.

B. Time marching via sequence-to-sequence modeling

Next we turn our attention to time marching problem via sequence-to-sequence modeling. To learn the system dynamics on the reduced nonlinear trial manifold in terms of the generalized coordinates, we use the mapping of the form:

$$\mathbf{U}_{r,\mu}^{(t+1)} = \Phi(\mathbf{U}_{r,\mu}^{(t)}; \theta_\Phi). \quad (20)$$

Using deep learning, one can address the difficulty of the evolution of generalized coordinates in the projection-based model reduction where access to operators in the governing laws are needed to evolve the basis functions.

Recurrent neural networks have traditionally been used in the deep learning community to model the time evolution of a state variable. At each step, the RNNs compute a m -dimensional summary vector $\mathbf{h}(\mathbf{t})$ of all input steps up to and including t . This partial summary is computed using a shared update function, $\mathcal{R} : \mathbb{R}^r \times \mathbb{R}^m \rightarrow \mathbb{R}^m$, based on the current step's features and the previous step's summary as follows:

$$\mathbf{h}^{(t)} = \mathcal{R}(\mathbf{U}_{r,\mu}^{(t)}, \mathbf{h}^{(t-1)}). \quad (21)$$

In simple RNN model¹³, one can consider $\mathbf{U}_{r,\mu}^{(t)}$ and $\mathbf{h}^{(t-1)}$ as flat vector representation and \mathcal{R} can be expressed as a single fully-connected neural network layer which can be written as:

$$\mathbf{h}^{(t)} = \sigma(\mathbf{W}\mathbf{U}_{r,\mu}^{(t)} + \mathbf{Q}\mathbf{h}^{(t-1)} + \mathbf{b}), \quad (22)$$

where $\mathbf{W} \in \mathbb{R}^{m \times r}$, $\mathbf{Q} \in \mathbb{R}^{m \times m}$ and $\mathbf{b} \in \mathbb{R}^m$ are learnable parameters and σ is an activation function. The summary vectors can then be used appropriately for the downstream task whenever a prediction is needed at each step of the sequence, then a shared predictor can be applied to each $\mathbf{h}^{(t)}$ individually. The initial summary vector, in particular, is usually either set to the zero-vector, i.e. $\mathbf{h}^{(0)} = \mathbf{0}$, or made learnable. To address the issues in time-series modeling such as long-term dependency in the data, and vanishing gradients, long short-term memory (LSTM) cells²³ are utilized in the present work. Learning the system dynamics of hyperbolic PDEs with an RNN-LSTM evolver is difficult to generalize for unforeseen input conditions and predict outputs for large time horizons.

In deep learning, sequence-to-sequence modeling has recently seen widespread application in sequential data processing and natural language processing¹⁰. Sequence-to-sequence architecture is a general end-to-end approach for learning sequence data that makes few assumptions about the sequence structure. It also often employs an encoder-decoder structure to encode the input sequence to a fixed-dimensionality vector and then decode the target sequence from the vector⁴³. A stack of LSTM cells serves as the encoder. The encoder summarises the information into a context vector. The final states produced by the model's encoder are utilized in initializing the decoder stack. The context vector is used as an input to the decoder stack to generate the output sequence synchronously. A stack of LSTM cells also makes up the decoder. Each LSTM cell in the decoder takes a hidden state and cell state from the previous cell and the context vector as input and produces the output. Figure 4 depicts the entire sequence-to-sequence procedure via RNN-LSTM evolver.

1. Temporal attention mechanism

The aim of a model for multi-step time series prediction is to implement a mapping from a sequence of input data, $(\mathbf{U}_{r,\mu}^{(1)}, \mathbf{U}_{r,\mu}^{(2)}, \dots, \mathbf{U}_{r,\mu}^{(t)})$, to a output sequence:

$$\{\mathbf{U}_{r,\mu}^{t+1}, \mathbf{U}_{r,\mu}^{t+2}, \dots, \mathbf{U}_{r,\mu}^{2t}\} = \Phi(\mathbf{U}_{r,\mu}^{(1)}, \mathbf{U}_{r,\mu}^{(2)}, \dots, \mathbf{U}_{r,\mu}^{(t)}). \quad (23)$$

Using a collection of training data and respective labels, the model Φ is usually estimated through supervised learning with a direct strategy for multi-step prediction. While the sequence-to-sequence model works reasonably well for short sequences, it becomes increasingly difficult to summarize a long sequence of vectors into a single vector. When the length of the sequence grows, the model frequently forgets the earlier parts of the input sequence when processing the last parts. An attention mechanism can solve this problem. An attention layer assigns proper weight to each hidden state output from the encoder and maps them to the output sequence.

The interface between the encoder and the decoder is constructed and marked as a temporal attention layer. We use LSTM as the encoder, which can take a time-series sequence $\mathbf{U}_{r,\mu} = (\mathbf{U}_{r,\mu}^{(1)}, \mathbf{U}_{r,\mu}^{(2)}, \dots, \mathbf{U}_{r,\mu}^{(t)})$ as the input data and process it recursively while maintaining its internal hidden states $\mathbf{h}^{(t)}$. At

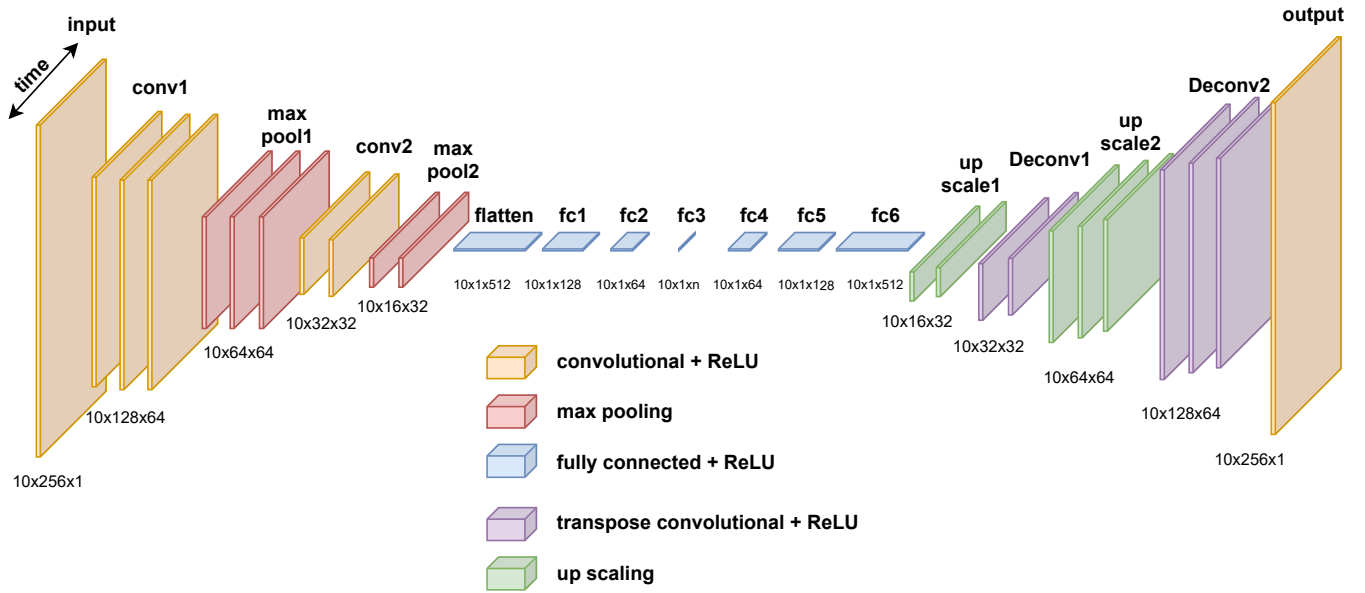

FIG. 3. Visualization of the convolutional autoencoder architecture used in the linear convection problem.

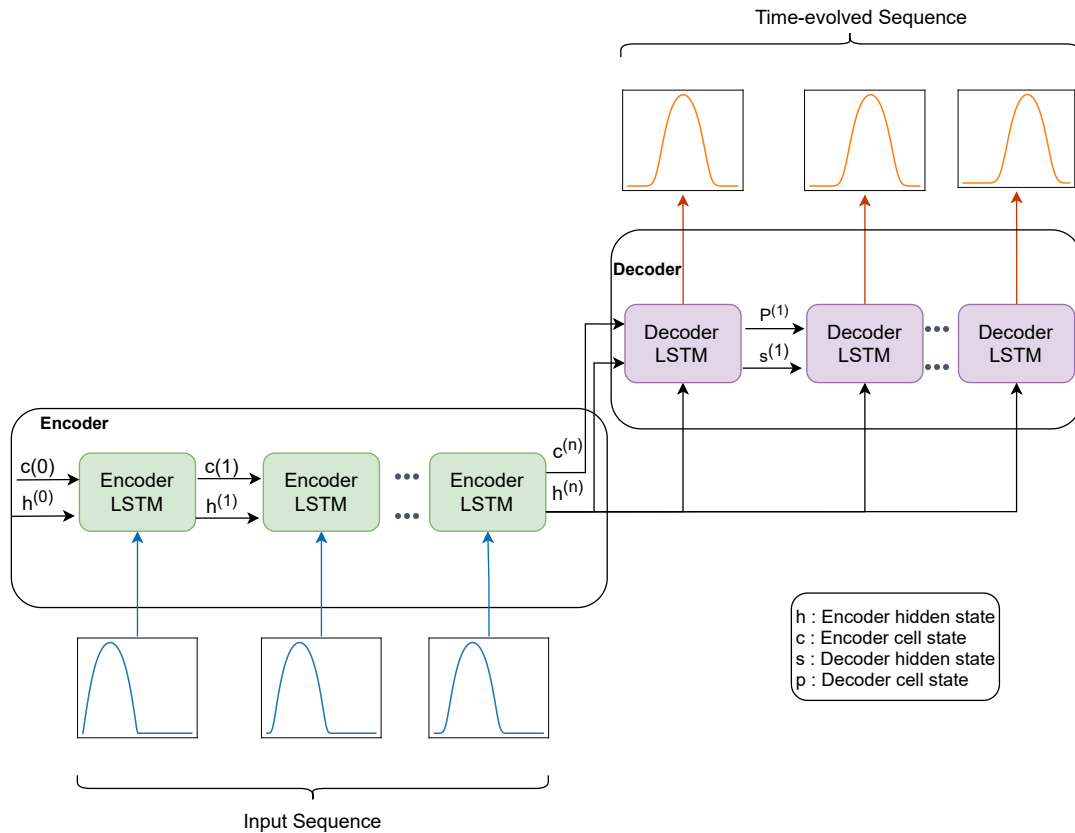

FIG. 4. Illustration of sequence-to-sequence RNN-LSTM evolver. The input sequence of spatial distribution is processed through the encoder RNN-LSTM, which summarises the input sequence. The computation of decoder is initialized with final encoder RNN-LSTM cell states, the encoder final hidden cell state is used as input for the decoder, the decoder iterates over these hidden cell states and generates the time evolved sequence.

each time step t , the LSTM reads $\mathbf{U}_{r,\mu}^{(t)}$ and updates its hidden state $\mathbf{h}^{(t)}$ as follows:

$$h^{(t)} = \text{LSTM}\left(\mathbf{U}_{r,\mu}^{(t)}, \mathbf{h}^{(t-1)}, c^{(t-1)}\right). \quad (24)$$

Subsequently, as a weighted sum of the encoder network's hidden states, temporal attention context vectors are formed, which are being used to identify the encoder's hidden representation and redirect the decoder to attend to these hidden states. The following is a description of the temporal attention layer computing process:

$$\left. \begin{aligned} e_{i,t} &= \mathbf{S}^{(t)} \odot \mathbf{H}^{(t)}, \\ \beta_{i,t} &= \frac{\exp(e_{i,t})}{\sum_{k=1}^T \exp(e_{i,k})}, \\ h_a &= \sum_{t=1}^T \beta_{i,t} h^{(t)}, \end{aligned} \right\} \quad (25)$$

$e_{i,t}$ represents the soft align computation between the hidden state $s^{(t)}$ of the decoder layer and the hidden state $\mathbf{h}^{(t)}$ of the encoder layer. Herein, $\beta_{i,t}$ indicates the attention weights that correspond to the importance of the input time series frame at time-step t to predict the output value at time-step i , which employs the softmax function to normalize the vector e_i of length T as the attention mask over the input time series sequence. The variable h_a is the final state of the attention layer. The whole process of temporal attention mechanism is demonstrated in Fig. 5.

2. Time integration analogous in AB-CRAN

To emulate the behavior of hyperbolic PDEs, an architecture must be adaptable enough to capture both the temporal evolution of the initial disturbance and the spatial variation. For this purpose, we develop an attention-based sequence-to-sequence RNN-LSTM for evolving latent dimensions in time over a long time horizon. The state-of-the-art numerical methods such as Euler-Forward difference in time utilize information from the neighboring cells at a time level n with $\mathbf{U}_{i-1}^n, \dots, \mathbf{U}_i^n, \dots, \mathbf{U}_{i+1}^n$ to calculate the solution \mathbf{U}_i^{n+1} at time level $n+1$. To illustrate this, let us consider a semi-discretized form of the differential system:

$$\frac{d\mathbf{U}_i}{dt} = f_i(\mathbf{U}_0, \mathbf{U}_1, \dots, \mathbf{U}_{n_x-1}), \quad i = 0, \dots, n_x-1. \quad (26)$$

To estimate the value at time level $n+1$, the forward Euler time integration can be written as:

$$\mathbf{U}_i^{n+1} = \mathbf{U}_i^n + h f_i(\mathbf{U}_0, \mathbf{U}_1, \dots, \mathbf{U}_{n_x-1}), \quad i = 0, \dots, n_x-1. \quad (27)$$

Our architecture utilizes the entire spatial grid and extracts the dominant features using the feature maps from the convolutional layer. After that, the architecture projects the data onto a low dimensional manifold via denoising-based convolution autoencoder, $\mathbf{U}_{r,\mu}^{(t)} = \Psi_E\left(\mathbf{U}_{r,\mu}^{(t)}; \theta_E\right)$. The input sequence of

data is transformed to the generalized coordinates and the attention mechanism is employed to weight the generalized coordinates and create a summary vector of the entire sequence. To predict solution at multiple time levels ($\mathbf{U}^t, \dots, \mathbf{U}^{t+k}$), the encoded context vector is passed through the decoder RNN-LSTM which allows to capture the propagation of disturbance over a time horizon:

$$\left. \begin{aligned} \{h^{(t)}, \dots, h^{(t+k)}\} &= \text{LSTM}\left(\mathbf{U}_{r,\mu}^{(t)}, \dots, \mathbf{U}_{r,\mu}^{(t+k)}, h^{(0)}, c^{(0)}\right), \\ h_a &= \sum_{t=1}^k \beta_{i,t} h^{(t)}, \end{aligned} \right\} \quad (28)$$

where β is a weighting coefficient for different input time-steps. The proposed novel attention-based convolutional recurrent autoencoder incorporates the biases required to solve hyperbolic PDEs in the network architecture. The denoising-based convolutional autoencoder takes advantage of translational invariance to capture the shifting of the initial solution in all spatial locations. The attention-based sequence-to-sequence RNN-LSTM can encode the input sequence and predict multiple time steps in the future. Figure 6 shows a representative architecture of the proposed AB-CRAN for the linear convection problem.

IV. TRAINING STRATEGY FOR AB-CRAN

The training of the denoising convolutional autoencoder and attention-based sequence to sequence RNN-LSTM in tandem is a critical component of this work. The main challenge is preventing either the convolutional autoencoder or the evolver portion of the model from overfitting. The construction of the training dataset, as well as the training is discussed in this section.

Consider the following data: $\mathcal{U} = \{\mathbf{U}_{N,\mu_1}^{(1)}, \dots, \mathbf{U}_{N,\mu_1}^{(N_T)}, \dots, \mathbf{U}_{N,\mu_N}^{(1)}, \dots, \mathbf{U}_{N,\mu_N}^{(N_T)}\} \in \mathbb{R}^{N_\mu \times N_T \times N}$. The spatio-temporal data $\mathbf{U}_{N,\mu_i} \in \mathbb{R}^{N_T \times N}$ is referred to as a snapshot matrix of the PPDE for a specific parameter μ_i . The data is divided into two matrices $\mathbf{X}_{\text{Train}}$ and $\mathbf{Y}_{\text{Train}}$, one of which serves as an input and the other as ground truth for the AB-CRAN framework. To make $\mathbf{X}_{\text{Train}}$ matrix, N_T time-steps of each snapshot matrix is divided into N_s sets, where $N_s = N_T - 2N_t + 1$, and each set containing N_t time-steps. N_t denotes the length of the input sequence for the attention-based sequence to sequence RNN-LSTM. The overlapping rolling time window technique is used to create these N_s sets. Initial N_t time-steps of the snapshot matrix are taken, forming the first of N_s sets. The time sequence is shifted by one step forward to create the subsequent sets. The matrix $\mathbf{Y}_{\text{Train}}$ is created in a similar manner, starting with N_{t+1} time step, taking the next N_t time steps, and constructing the first set of N_s sets. The following sets are generated by shifting the sequence one step forward. The entire procedure for creating $\mathbf{X}_{\text{Train}}$ and $\mathbf{Y}_{\text{Train}}$ matrices is depicted in Fig. 7. Finally, for training $\mathbf{X}_{\text{Train}}$ and $\mathbf{Y}_{\text{Train}}$ matrices are reshaped into $N_m \times N_t \times N$ with $N_m = N_\mu \times N_s$.

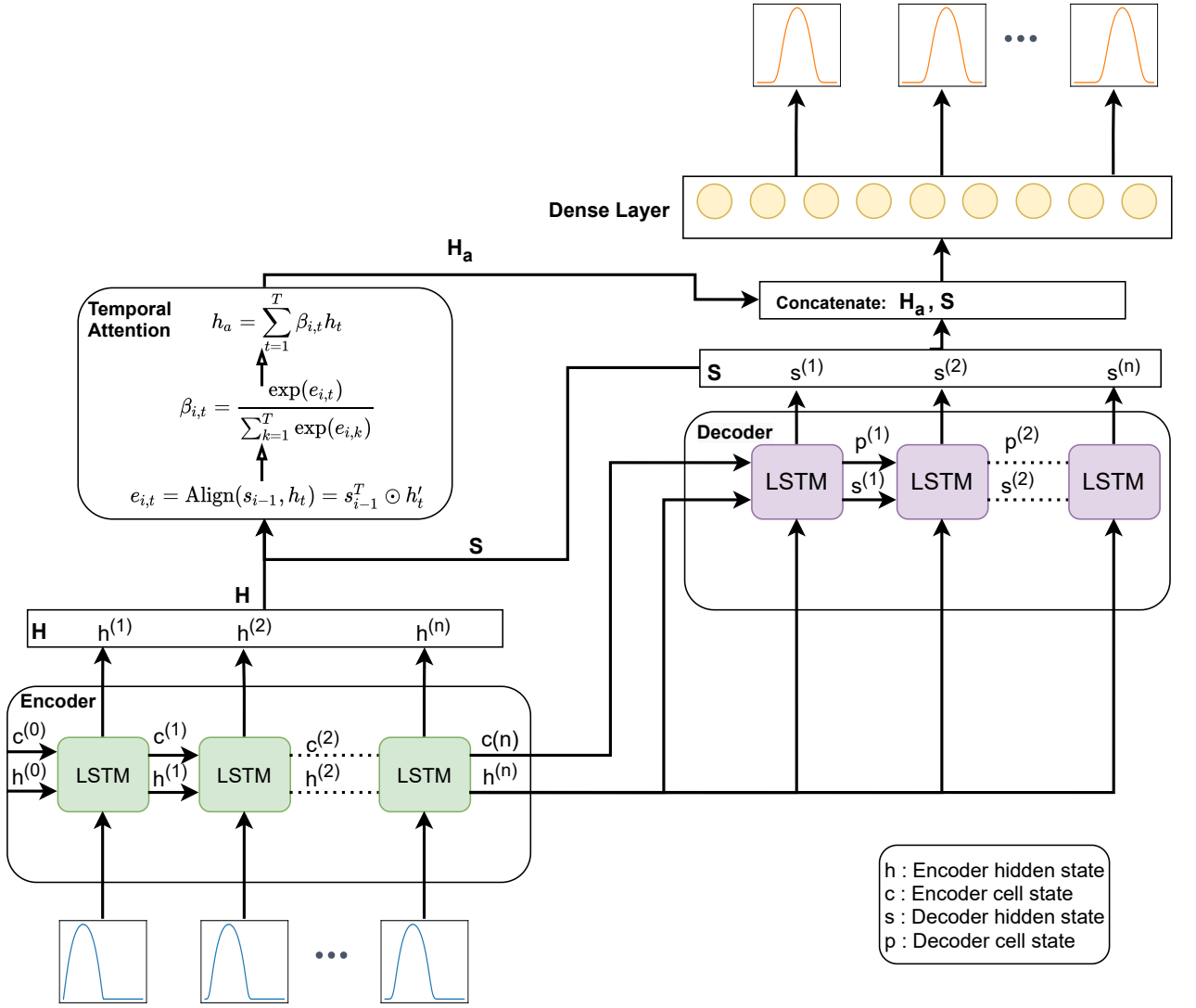

FIG. 5. Attention-based sequence-to-sequence RNN-LSTM evolver.

For an improved neural network training and preventing over saturation of any particular feature, data are scaled appropriately as follows:

$$\left. \begin{aligned} \bar{X}_{\text{Train}} &= \frac{\bar{X}_{\text{Train}} - \bar{X}_{\text{Train, min}}}{\bar{X}_{\text{Train, max}} - \bar{X}_{\text{Train, min}}}, \\ \bar{Y}_{\text{Train}} &= \frac{\bar{Y}_{\text{Train}} - \bar{Y}_{\text{Train, min}}}{\bar{Y}_{\text{Train, max}} - \bar{Y}_{\text{Train, min}}}, \end{aligned} \right\} \quad (29)$$

where $\bar{X}_{\text{Train}}, \bar{Y}_{\text{Train}} \in [0, 1]^{N_m \times N_t \times N}$. To train the autoencoder and evolver parts of the network simultaneously, a hybrid supervised-unsupervised training strategy is devised in the present work. For unsupervised training of the denoising convolutional autoencoder, the training dataset is added with Gaussian noise: $\tilde{X}_{\text{Train}} = \bar{X}_{\text{Train}} + \mathcal{N}(\mu, \sigma) \in \mathbb{R}^{N_m \times N_t \times N}$. The autoencoder loss is computed by comparing reconstruction $(\Psi_D(\Psi_E(\tilde{X}_{\text{Train}}; \theta_E); \theta_D))$ with the uncorrupted normalized data input \bar{X}_{Train} . For supervised training of evolver net-

work output is compared with the ground truth $\mathcal{Y} \in \mathbb{R}^{N_m \times N_t \times N}$ where each sequence is shifted in time by N_t time-steps with respect to the input sequence to emulate the temporal evolution.

To train both the components of the convolutional recurrent autoencoder model, our strategy is to split the forward pass into two stages. In the first stage, the encoder takes an N_b -sized batch of the Gaussian training data $\tilde{X}_{\text{Train}}^b \subset \tilde{X}_{\text{Train}}$, where $\tilde{X}_{\text{Train}}^b \in [0, 1]^{N_b \times N_t \times N}$, and outputs the current N_b -sized batch of low-dimensional representations of the training sequence $(\tilde{H}^b \in \mathbb{R}^{N_b \times N_t \times r})$. The decoder takes this low-dimensional representation and builds a reconstruction from it. The normalized input $(\bar{X}_{\text{Train}}^b)$ is compared with the reconstruction to generate the autoencoder loss. In the second stage of the forward pass, we evolve the low-dimensional representation (\tilde{H}^b) by passing through the attention-based sequence-to-sequence model via RNN-LSTM. To obtain the low-dimensional representation in the physical domain, the evolved low-dimensional

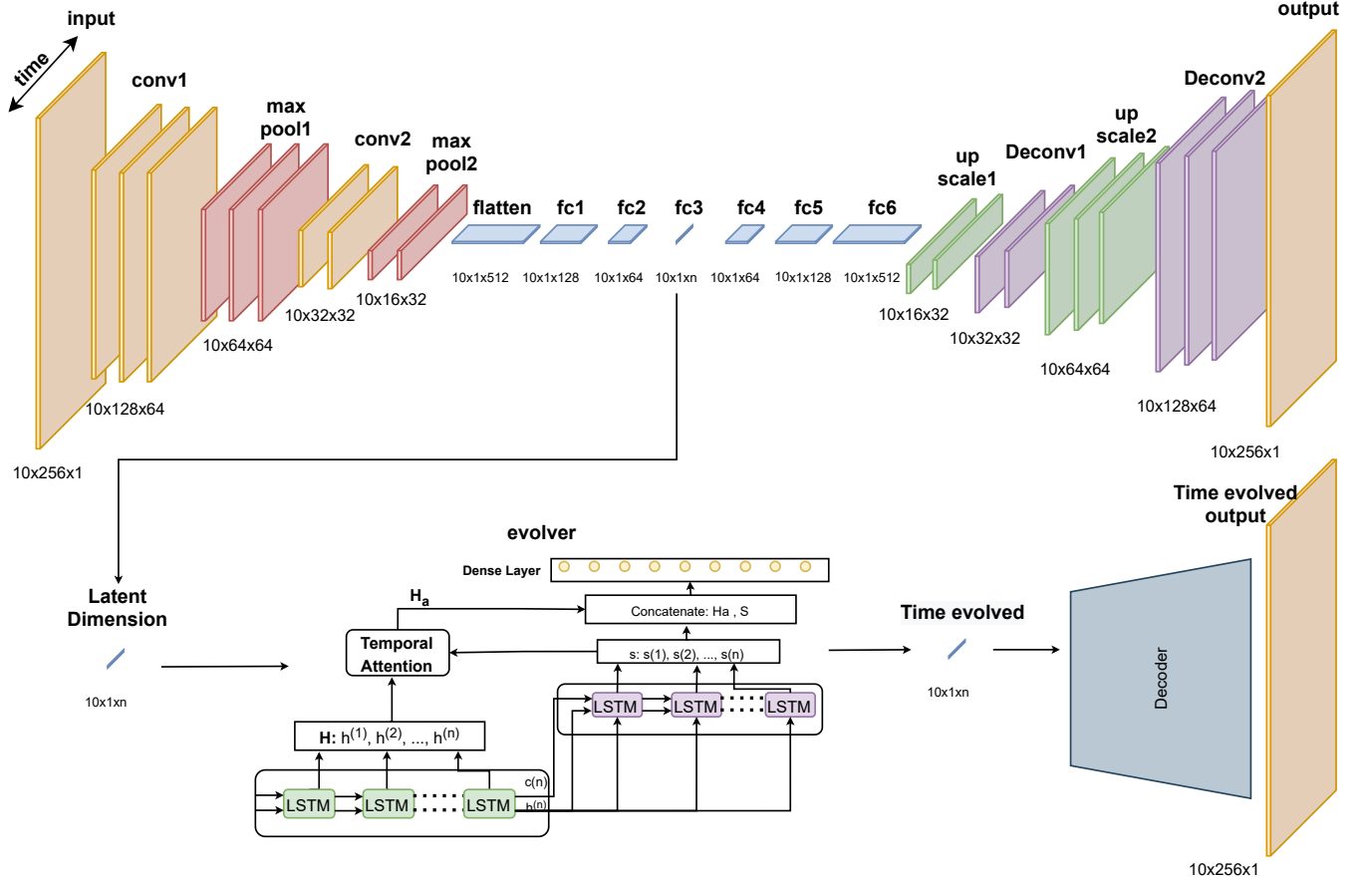

FIG. 6. Visualization of a representative architecture for attention-based convolutional recurrent autoencoder network.

representation is transmitted through a decoder network to recover the physical dimensions. The evolved physical dimension is compared with the ground truth to form the evolver loss. We seek to construct a loss function that weights the error in the full-state reconstruction and the evolution of the low-dimensional representations. In general, we would like to find the model parameters $\theta^* = \{\theta_E^*, \theta_D^*, \theta_\Phi^*\}$ such that for any sequence $\mathbf{U}_s = [\mathbf{U}_s^1, \dots, \mathbf{U}_s^{N_T}]$, and its corresponding low-dimensional representation $\hat{\mathbf{U}} = [\hat{\mathbf{U}}^1, \dots, \hat{\mathbf{U}}^{N_T}]$ minimizes the following expected error between the model and the data

$$\mathcal{J}(\theta) = \mathcal{L}(\tilde{\mathcal{U}}, \mathcal{U}, \mathcal{U}', \mathcal{Y}) = \frac{1}{N_m} \sum_{j=1}^{N_m} \left(\frac{\alpha}{N_t} \sum_{i=1}^{N_t} \left\| \tilde{U}_{s,i}^j - U_{s,i}^j \right\|_2^2 + \frac{(1-\alpha)}{N_t} \sum_{i=1}^{N_t} \left\| U_{s,i}^j - Y_{s,i}^j \right\|_2^2 \right), \quad (30)$$

where α is hyperparameter. Here $\mathcal{U}, \tilde{\mathcal{U}}, \mathcal{U}', \mathcal{Y}$ denote the input data matrix, the Gaussian data matrix, the time evolved data matrix and the ground truth matrix, respectively. The proposed hybrid loss function is further illustrated in Fig. 8. At every training step, the autoencoder performs a regular forward pass while constructing a new batch of low-dimensional

representation. The low-dimensional representations are subsequently used to train the evolver. In the present work, we utilize a step-based learning rate scheduler which reduces the initial learning rate by a decay factor on every predetermined number of steps³. Twenty percent of the training data are chosen and set aside for the purpose of validation. The validation data set is being used for the purpose of early stopping⁴⁹. We use the ADAM optimizer²⁵, a version of stochastic gradient descent that employs momentum for updating the parameters. Algorithm 1 provides the complete training procedure for our AB-CRAN architecture.

Prediction becomes simple once the model has been trained. The encoder network is used to generate a low-dimensional representation of the input sequence \bar{X}_{in} using the trained parameters θ^* . This low-dimensional representation (\mathcal{H}) is then evolved for n time-horizons (N_{th}) by iterative application of evolver network. The user can rebuild the full-dimensional state from \mathcal{H} at any time-horizon using the decoder part of the AB-CRAN framework. Algorithm 2 explains how to make a prediction using our proposed AB-CRAN framework.

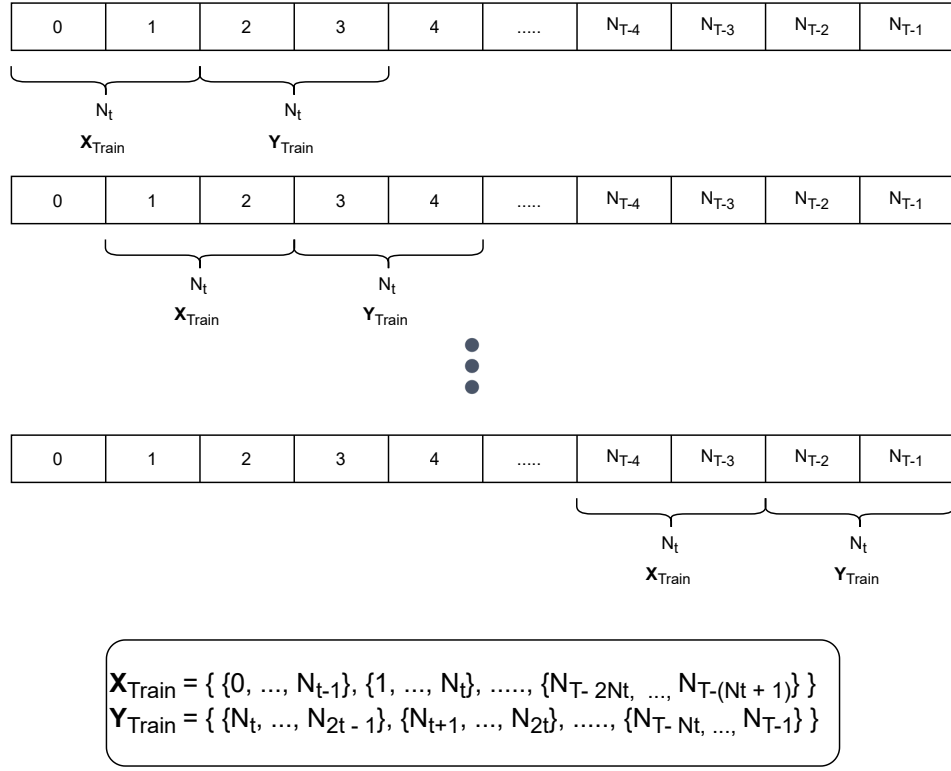

FIG. 7. An illustration of training set generation from FOM data in the AB-CRAN procedure.

Algorithm 1: AB-CRAN Training Algorithm

Input: $\bar{X}_{\text{Train}}, \bar{Y}_{\text{Train}}, N_{\text{epochs}}, N_b, \eta, \alpha$
Output: $\theta^* = \{\theta_E^*, \theta_D^*, \theta_\Phi^*\}$
Initialize θ ;
while $epoch < N_{\text{epochs}}$ **do**
 Randomly sample batch from training data:
 $\bar{X}_{\text{Train}}^b \subset \bar{X}_{\text{Train}}$;
 Encoder forward pass: $\tilde{\mathcal{H}}^b \leftarrow \Psi_E(\mathcal{X}^{b_{AE}}; \theta_E)$,
 $\tilde{\mathcal{H}}^b \in \mathbb{R}^{N_b \times N_t \times r}$;
 Decoder forward pass: $\hat{\mathcal{X}}^{b_{AE}} \leftarrow \Psi_D(\tilde{\mathcal{H}}^b; \theta_D)$,
 $\hat{\mathcal{X}}^{b_{AE}} \in \mathbb{R}^{N_b \times N_t \times N}$;
 Evolver forward pass: $\bar{\mathcal{H}}^b \leftarrow \Phi(\hat{\mathcal{X}}^b; \theta_\Phi)$,
 $\bar{\mathcal{H}}^b \in \mathbb{R}^{N_b \times N_t \times r}$;
 Evolved physical space: $\hat{\mathcal{X}}^{b_{Pr}} \leftarrow \Psi_D(\bar{\mathcal{H}}^b; \theta_D)$,
 $\hat{\mathcal{X}}^{b_{Pr}} \in \mathbb{R}^{N_b \times N_t \times N}$;
 Calculate loss \mathcal{L} via Eq. (30);
 Estimate gradients $\hat{\mathbf{g}}$ using automatic differentiation;
 Update parameters: $\theta \leftarrow \text{ADAM}(\hat{\mathbf{g}})$;
end
Updated parameters: $\{\theta^* = \theta_E^*, \theta_D^*, \theta_\Phi^*\}$

Algorithm 2: AB-CRAN Prediction Algorithm

Input: $\bar{X}_{\text{in}}, N_{th}$
Result: Model prediction \hat{X}_{out}
Load trained parameter $\theta^* = \{\theta_E^*, \theta_\Phi^*, \theta_D^*\}$;
Encoder forward pass: $\tilde{\mathcal{H}} \leftarrow \Psi_E(\mathcal{X}^{b_{AE}}; \theta_E^*)$;
while $i < N_{th}$ **do**
 Evolver forward pass: $\bar{\mathcal{H}} \leftarrow \Phi(\tilde{\mathcal{H}}; \theta_\Phi^*)$;
 Evolved physical space: $\hat{\mathcal{X}} \leftarrow \Psi_D(\bar{\mathcal{H}}; \theta_D^*)$;
 Append: $\hat{X}_{\text{out}} \leftarrow \hat{\mathcal{X}}$;
end
Output: \hat{X}_{out}

strated by solving (i) a one-dimensional linear convection equation, and (ii) a one-dimensional nonlinear viscous Burgers equation, and (iii) a two-dimensional Saint-Venant shallow water equation.

A. Linear convection equation

As a first test case, let us consider the linear convection equation, whose solution U in the domain $\Omega \equiv [0, 1]$ satisfies the parametric partial differential equation given by:

$$\frac{\partial U}{\partial t} + \mu \frac{\partial U}{\partial X} = 0 \quad \text{in } \Omega, \quad (31)$$

V. NUMERICAL RESULTS

In this section, we show how the proposed architecture can predict the evolutionary behavior of hyperbolic PDEs. The effectiveness of the proposed methodology will be demon-

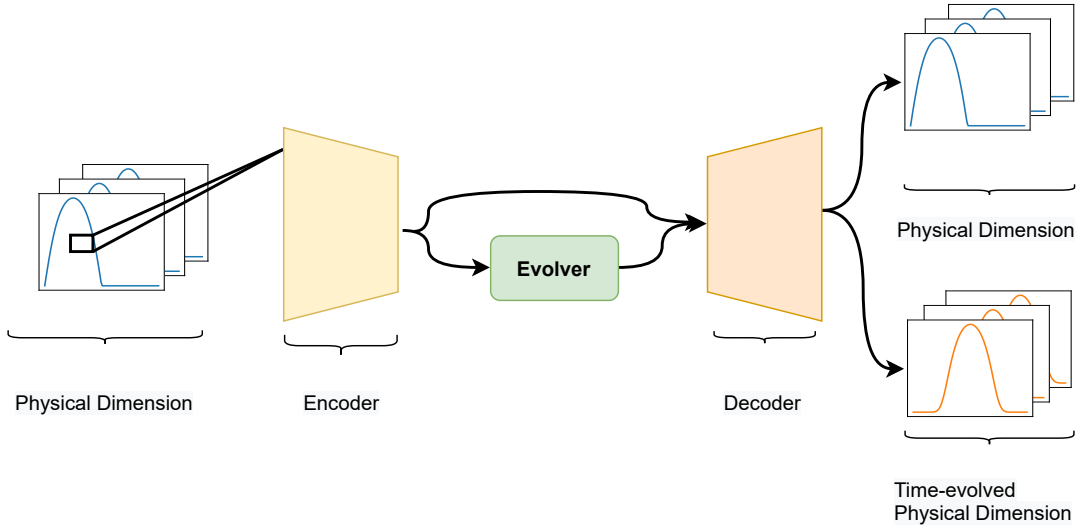

(a)

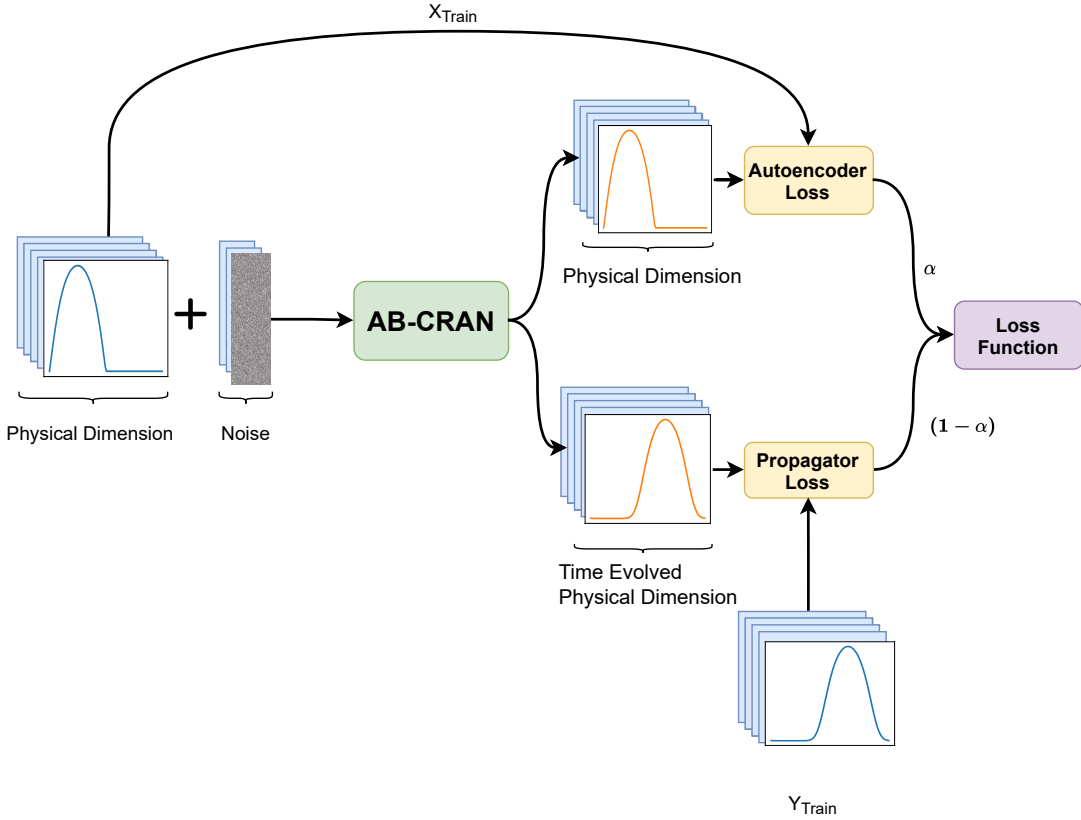

(b)

FIG. 8. Illustration of two forward stages and the evaluation of the loss function for AB-CRAN: (a) outputs from two forward passes, and (b) hybrid loss function.

with the following initial condition:

$$U(x, 0) = U_0(x) \equiv f(x), \quad (32)$$

where $\mu \in [0.775, 1.25]$ denotes the wave phase speed. Here, $f(x) = (1/\sqrt{2\pi\sigma})e^{-x^2/2\sigma}$, and we set $\sigma = 10^{-4}$. The exact solution is simply $U(x, t) = f(x - \mu t)$ which is used to gener-

ate the ground truth data. The dataset is built by using the exact solution in the space-time domain $[0, L] \times [0, T]$, by setting $L = 1$ and $T = 1$. In this problem, a one-dimensional spatial discretization of 256 grid nodes and 200 time steps are used. We consider $N_\mu = 20$ training-parameter instances uniformly distributed over μ and $N_{\text{test}} = 19$ testing-parameter instances such that $\mu_{\text{test}, i} = (\mu_{\text{train}, i} + \mu_{\text{train}, i+1})/2$, for $i = 1, \dots, N_{\text{test}}$.

The details of the architecture of this test case are as follows. We choose a 15-layers AB-CRAN net. The encoder consists of a convolutional layer, maxpooling and fully connected layers. There are n neurons in the output layer of the encoder function, where n corresponds to the dimension of the reduced trial manifold. Specific details of the encoder, the decoder and the evolver functions are summarized in Table I, II and III. The total number of trainable parameters (i.e., weights and biases) of the neural network for this case is 199,461.

The first ten time steps of data from the linear convection equation with $\mu = 0.7875$ are fed into the AB-CRAN architecture, and the dimension of the nonlinear trial manifold is set to $n = 2$. Figure 9 illustrates both the exact solution and the AB-CRAN approximation for this instance of the testing parameter. Denoising AB-CRAN solution with $n = 2$ accurately captures the amplitude and predicts the wave phase velocity.

1. Impact of AB-CRAN on time series prediction

We first examine the AB-CRAN's time series prediction capability to that of the CRAN network. We consider a value of 0.7875 for the wave phase speed and aim to accurately predict wave propagation for this parameter case. We consider the mean squared error (MSE), and the maximum error (L_∞) criterion to assess the accuracy of the predictions. While the MSE is given by:

$$\text{MSE}(\mathbf{u}, \hat{\mathbf{u}}) = \sum_{i=1}^N \frac{(\hat{\mathbf{u}}_i^j - \mathbf{u}_i^j)^2}{N}, \quad (33)$$

the error L_∞ is:

$$L_\infty(\mathbf{u}, \hat{\mathbf{u}}) = \max(|\hat{\mathbf{u}}_i^j - \mathbf{u}_i^j|), \quad (34)$$

where N is the spatial degrees of freedom. Figure 10 illustrates the predictions for non-dimensional time ($t^* = \frac{t\mu}{L}$) values of 0.036, 0.194, and 0.392. We predict ten-time steps using a sequence-to-sequence mapping model and refer to a sequence of ten-time steps as one-time horizon. Thus, the first, fifth, and tenth time horizons correspond to the tenth, fiftieth, and hundredth time steps forward, respectively. The results in Fig. 10 demonstrate that the AB-CRAN precisely captures the peak amplitude and wave speed for the testing time steps. On the other hand, CRAN architecture with plain RNN-LSTM evolver struggles to capture wave propagation phenomenon beyond first time horizon. In Fig. 11, the mean squared error (MSE) and L_∞ error norm of the CRAN and AB-CRAN predictions are compared. In comparison to the CRAN, the AB-CRAN models have a lower MSE and L_∞ . The results indicate that the AB-CRAN network can significantly reduce the error of CRAN predictions for the linear convection equation. MSE error is negligible in AB-CRAN prediction when compared to the CRAN procedure over the entire time period. The MSE and the maximum error from the CRAN procedure increase with the time horizon, indicating that the error accumulates, whereas the error from our proposed AB-CRAN remains negligible and less than the threshold value. This confirms that the AB-CRAN procedure learns the linear convection equation more effectively than the CRAN.

2. Effect of denoising-based autoencoder

In this section, we will examine the effect of a denoising autoencoder in the AB-CRAN on the generalization of predictions for different parameter values. One of the main advantages of using a denoising-based autoencoder is the inherent regularization it provides, which prevents overfitting and improves generalization on the test dataset. To study the effects of the denoising autoencoder, predictions for three test cases were obtained from the network with denoising training. Test Case 1 considers a case where $\mu = 0.7875$, wave phase speed is less than one, Test Case 2 considers a case where $\mu = 1.0125$, wave phase speed is close to one, and Test Case 3 considers a case where $\mu = 1.2375$, wave phase speed is greater than one. Figure (12) shows that the MSE and L_∞ error norm for all three test cases are less for AB-CRAN compared to CRAN which shows that the AB-CRAN generalizes better for different parameter instances. The denoising autoencoder as expected provides better results on the entire parameter space and is a more general model.

In addition to the MSE error (Eq. (33)) and the maximum error (Eq. (34)), we consider the time average value of the MSE and the maximum errors as an alternative metric to assess the accuracy of the predictions for different parameters, which are given by

$$\langle \text{MSE}(\mathbf{u}, \hat{\mathbf{u}}) \rangle = \sum_{j=1}^{N_t} \left(\sum_{i=1}^N \frac{(\hat{\mathbf{u}}_i^j - \mathbf{u}_i^j)^2}{N} \right) / (N_t), \quad (35)$$

and

$$\langle L_\infty(\mathbf{u}, \hat{\mathbf{u}}) \rangle = \sum_{j=1}^{N_t} \frac{\max(|\hat{\mathbf{u}}_i^j - \mathbf{u}_i^j|)}{N_t}, \quad (36)$$

where N is the spatial degrees of freedom, and N_t is number of time steps, and $\langle \rangle$ denotes the time averaging. In a nutshell, it can be seen in Table IV that the AB-CRAN reduces the mean squared error by an order of magnitude in comparison to CRAN while it reduces the maximum error by four times.

B. Viscous Burgers equation

In this section, we consider the viscous Burgers' equation as a model for nonlinear wave propagation. Consider the following parametric partial differential equation:

$$\frac{\partial u}{\partial t} + u \frac{\partial u}{\partial x} = \nu \frac{\partial^2 u}{\partial x^2}, \quad (37)$$

with Dirichlet boundary conditions and following initial condition.

$$u(x, 0) = \frac{x}{1 + \sqrt{\frac{1}{t_0}} \exp\left(\text{Re} \frac{x^2}{4}\right)} \quad \text{on } [0, L], \quad (38)$$

$$u(0, t) = u(L, t) = 0, \quad (39)$$

TABLE I. Attributes of convolutional and dense layers in the encoder $\Psi_E(\cdot; \theta_E)$.

Layer	Layer Type	Input Dimension	Output Dimension	Kernel Size	# filters/ # neurons	Stride
1	Conv 1D	[10,256,1]	[10,128,64]	[5]	64	2
	MaxPool 1D	[10,128,64]	[10, 64, 64]	-	-	-
2	Conv 1D	[10,64,64]	[10,32,32]	[5]	32	2
	MaxPool 1D	[10,32,32]	[10, 16, 32]	-	-	-
	Flatten	[10,16,32]	[10, 512]	-	-	-
3	Dense	[10,512]	[10,128]	-	128	-
4	Dense	[10,128]	[10,64]	-	64	-
5	Dense	[10,64]	[10,n]	-	n	-

TABLE II. Attributes of evolver functions $\Phi(\cdot; \theta)$.

Layer	Layer Type	Input Dimension	Output Dimension	Hidden State	Input	# Neurons
6	RNN-LSTM	[10,n]	[10,p]	None	Latent Dimension	p
7	RNN-LSTM	[10,p]	[10,p]	None	Layer 6 output	p
8	RNN-LSTM	[10,p]	[10,p]	Layer 6 internal state	Layer 7 output	p
9	RNN-LSTM	[10,p]	[10,p]	Layer 7 internal state	Layer 8 output	p
10	Attention	[10,p],[10,p]	[10,2p]	-	Layer 7&9 output	p
11	Dense	[10,2p]	[10,n]	-	Layer 10 output	n

We define $Re = \frac{1}{\nu}$, which varies from 1000 to 4000, and consider $N_{Re} = 7$ training parameter instances distributed uniformly over this range. We set the physical domain length $L \in [0, 1]$ and discretize it into 256 spatial points. We set $t_{max} = 2$ and discretize it into 200 time steps. The analytical solution for the viscous Burgers' equation with the specified initial condition is given by

$$u(x, t) = \frac{\frac{x}{t+1}}{1 + \sqrt{\frac{t+1}{t_0} \exp\left(\text{Re} \frac{x^2}{4t+4}\right)}}, \quad (40)$$

where $t_0 = \exp(Re/8)$. Because of convection-dominated behavior, the viscous Burgers equation can produce discontinuous solutions.

In this test case of nonlinear convection, the same neural network architecture with 15-layers of AB-CRAN is used. We also set the dimension of the reduced manifold to two. As input, the first ten time steps of the viscous Burgers' equation with $Re = 1100$ are used. Figure 13 shows both the exact solution and the AB-CRAN approximation for this particular instance of the testing parameter. Denoising AB-CRAN solution with $n = 2$ accurately captures the nonlinear wave propagation.

1. AB-CRAN predictions for varying Reynolds number

In this section, we will examine the AB-CRAN network's predictions for varying Reynolds numbers between 1000 and 4000. We will consider two test cases in particular: Test Case 1 corresponding to a Reynolds number of 1100 and Test Case 2 with a Reynolds number of 3600. Figure 14 illustrates the predicted value and errors for Test Case 1 with Reynolds number 1100. The AB-CRAN accurately captures both nonlinear

wave propagation and discontinuity. The CRAN network exhibits oscillation near the discontinuity, indicating that AB-CRAN is more effective at learning the physics of viscous Burgers' equation.

The mean squared error (MSE) and the maximum error (L_∞) of the AB-CRAN and CRAN predictions are compared in Fig. 14. The AB-CRAN provides a relatively smaller error compared to the CRAN architecture. The results show that the AB-CRAN network reduces the error of CRAN predictions by approximately 50% for the testing parameter of Re_{1100} .

The predicted value and errors for Test Case 2, with Reynolds number 3600 exhibit the same trend. as the Test Case 1. The AB-CRAN network accurately models nonlinear wave propagation and discontinuity, whereas the CRAN network exhibits oscillation near the discontinuity. Moreover, for the testing parameter Re_{3600} , fig. 15 shows that the AB-CRAN network reduces the error of CRAN predictions by approximately 50%. The errors listed in the table V show that AB-CRAN reduces the mean squared error by an order of magnitude in comparison to CRAN, and it reduces the maximum error by three times.

TABLE V. Nonlinear viscous Burgers problem: Comparison of time averaged mean squared error and maximum error between AB-CRAN and CRAN for various parameter cases.

Parameter Re	$\langle MSE \rangle$		$\langle L_\infty \rangle$	
	CRAN	AB-CRAN	CRAN	AB-CRAN
1100	4.873×10^{-4}	8.118×10^{-5}	0.192	0.073
3600	3.068×10^{-4}	7.433×10^{-5}	0.202	0.096

TABLE III. Attributes of transpose convolutional and dense layers in the decoder $\Psi_D(\cdot; \theta_D)$.

Layer	Layer Type	Input Dimension	Output Dimension	Kernel Size	# filters/ # neurons	Stride
11	Dense	[10,n]	[10,64]	-	64	-
12	Dense	[10,64]	[10, 128]	-	128	-
13	Dense	[10,128]	[10,512]	-	512	-
	Reshape	[10,512]	[10,16,32]	-	-	-
	UpSampling 1D	[10,16,32]	[10,32,32]	-	-	-
14	Conv 1D Transpose	[10,32,32]	[10,64,64]	[5]	64	2
	UpSampling 1D	[10,64,64]	[10,128,64]	-	-	-
15	Conv 1D Transpose	[10,128,64]	[10,256,1]	[5]	1	2

FIG. 9. Linear convection problem: Exact solution (left), AB-CRAN solution with $n = 2$ (center) and error $e = |\hat{u} - u|$ (right) for the testing parameter $\mu_{test} = 0.7875$ in the space-time domain.

TABLE IV. Linear convection problem: Comparison of the time averaged mean squared error and the maximum error between AB-CRAN and CRAN for various parameter cases.

Parameter μ	$\langle MSE \rangle$		$\langle L_\infty \rangle$	
	CRAN	AB-CRAN	CRAN	AB-CRAN
0.7875	0.0254	0.0012	0.9009	0.1776
1.0125	0.0254	0.0017	0.8926	0.2215
1.2375	0.0229	0.0034	0.7203	0.2692

C. 2D Shallow Water Wave Propagation

We now consider the 2D shallow water model given by Saint-Venant equations. The PDE system provides a hydrodynamic model that calculates the flow velocity and the water level over a two-dimensional domain. It takes into account the various forces influencing and accelerating the flow. The 2D horizontal Saint-Venant mathematical model arises from the vertical integration of the 3D Navier-Stokes equations with

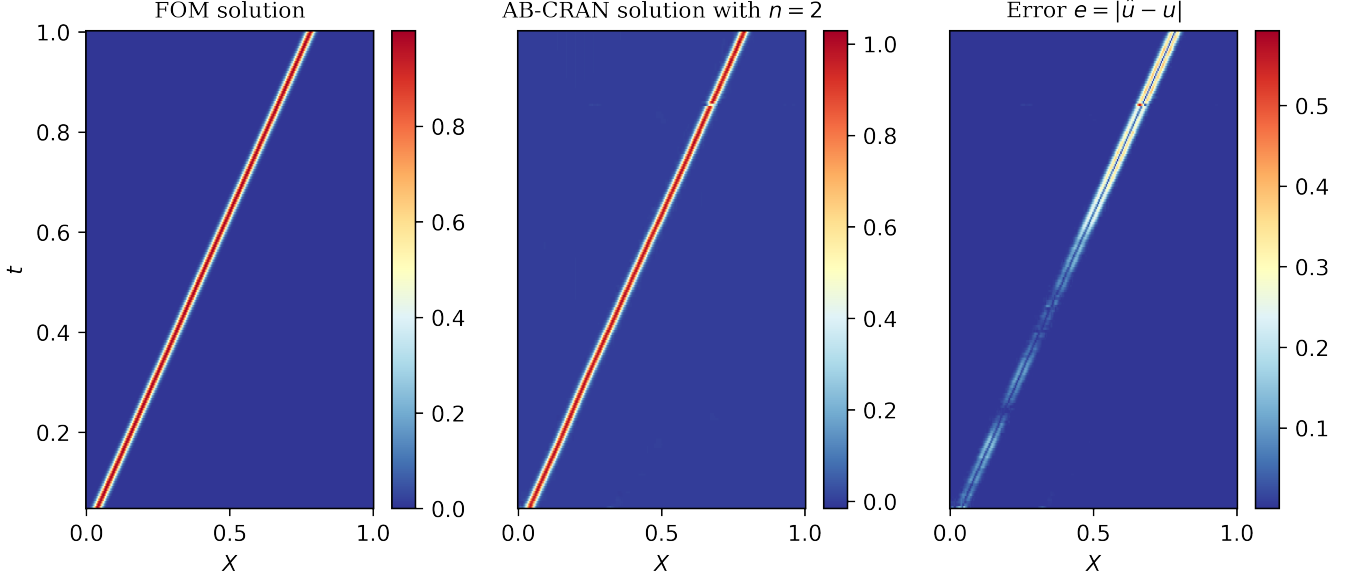
various assumptions such as the vertical pressure gradient is nearly hydrostatic (i.e., long waves) and the horizontal length scale is much larger than the vertical length scale.

The Saint-Venant model comprises the equation for mass conservation and the two equations of momentum conservation and can be written in a non-conservative form as:

$$\left. \begin{aligned} \frac{\partial h}{\partial t} + \frac{\partial}{\partial x}((H+h)u) + \frac{\partial}{\partial y}((H+h)v) &= 0, \\ \frac{\partial u}{\partial t} + u \frac{\partial u}{\partial x} + v \frac{\partial u}{\partial y} + g \frac{\partial h}{\partial x} - \nu \left(\frac{\partial^2 u}{\partial x^2} + \frac{\partial^2 u}{\partial y^2} \right) &= 0, \\ \frac{\partial v}{\partial t} + u \frac{\partial v}{\partial x} + v \frac{\partial v}{\partial y} + g \frac{\partial h}{\partial y} - \nu \left(\frac{\partial^2 v}{\partial x^2} + \frac{\partial^2 v}{\partial y^2} \right) &= 0, \end{aligned} \right\} \quad (41)$$

here, u and v are the velocities in the x and y direction, respectively, H denotes the reference water height and h is the deviation from this reference, g is the acceleration due to gravity, ν is the kinematic viscosity. The solid wall boundary conditions are used along its perimeter. We use a plane wave as the initial condition. The data were generated using Python package

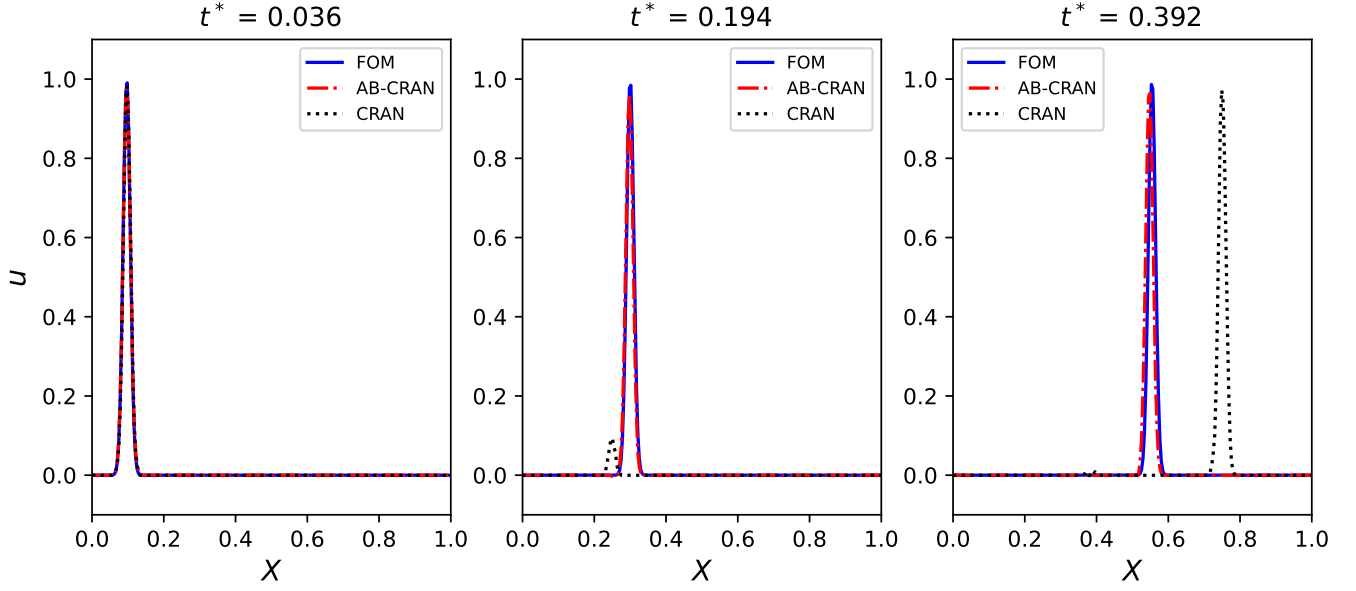

FIG. 10. Linear convection problem: Comparison of FOM solution, CRAN, and AB-CRAN solution at three time instants ($t^* = [0.036, 0.194, 0.392]$), where non-dimensional time $t^* = t\mu/L$.

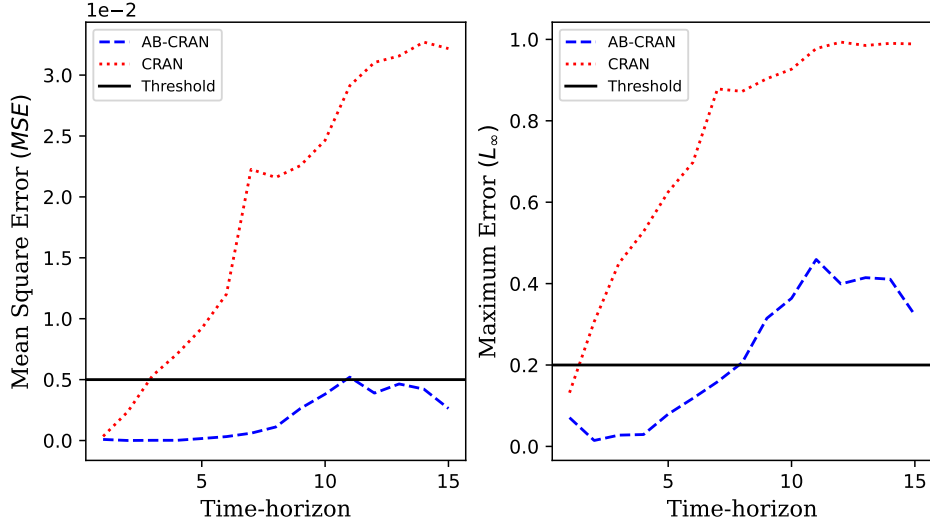

FIG. 11. Linear convection problem: Comparison of MSE and maximum error of AB-CRAN with CRAN

TriFlow⁹. An example of wave pattern evolution generated by the numerical solver is illustrated in Fig. 16. The dataset was generated by varying the initial location of the plane wave. We set $t_{max} = 1$ and discretize it into 100 time steps. The images were rendered with 184×184 pixels.

1. Data-driven predictions via AB-CRAN

The architecture of the neural network used for this test case is similar to the first two cases. We choose a 15-layers convolutional recurrent autoencoder. The architecture of the

network is identical to the one-dimensional case, only two-dimensional convolution and max-pooling are used instead of one-dimensional operations. The total number of trainable parameters (i.e., weights and biases) of the neural network is 4,504,785. We generate 10 wave solution from the FOM and used them as the input. Figure 17 shows the solution from FOM and AB-CRAN. It can be seen that the AB-CRAN framework can predict the spatial pattern and the wave amplitude for the Saint-Venant equations at a reasonable accuracy.

In Fig. 18, the mean squared error of the CRAN and AB-CRAN predictions are compared. In comparison to the CRAN, the AB-CRAN models exhibit consistently lower

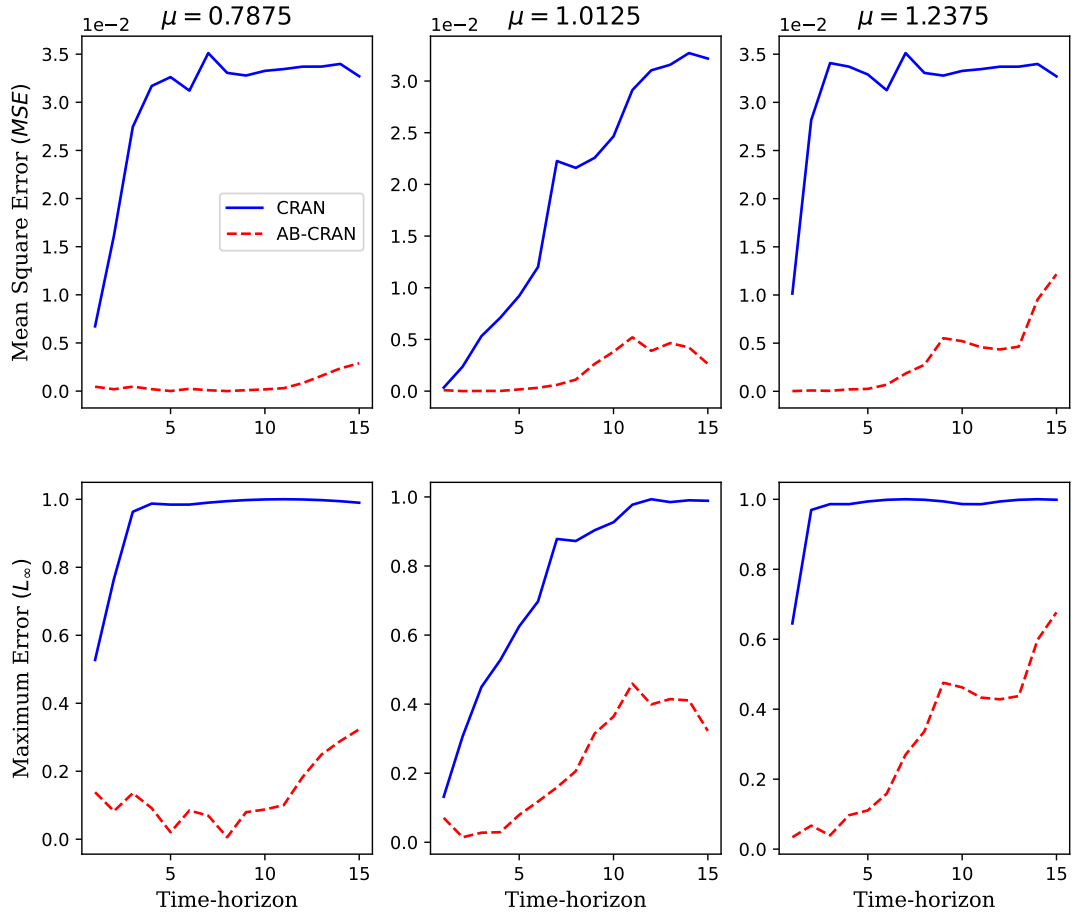

FIG. 12. Linear convection problem: Comparison of generalisation error across the parameter space $\mu \in [0.7875, 1.2375]$.

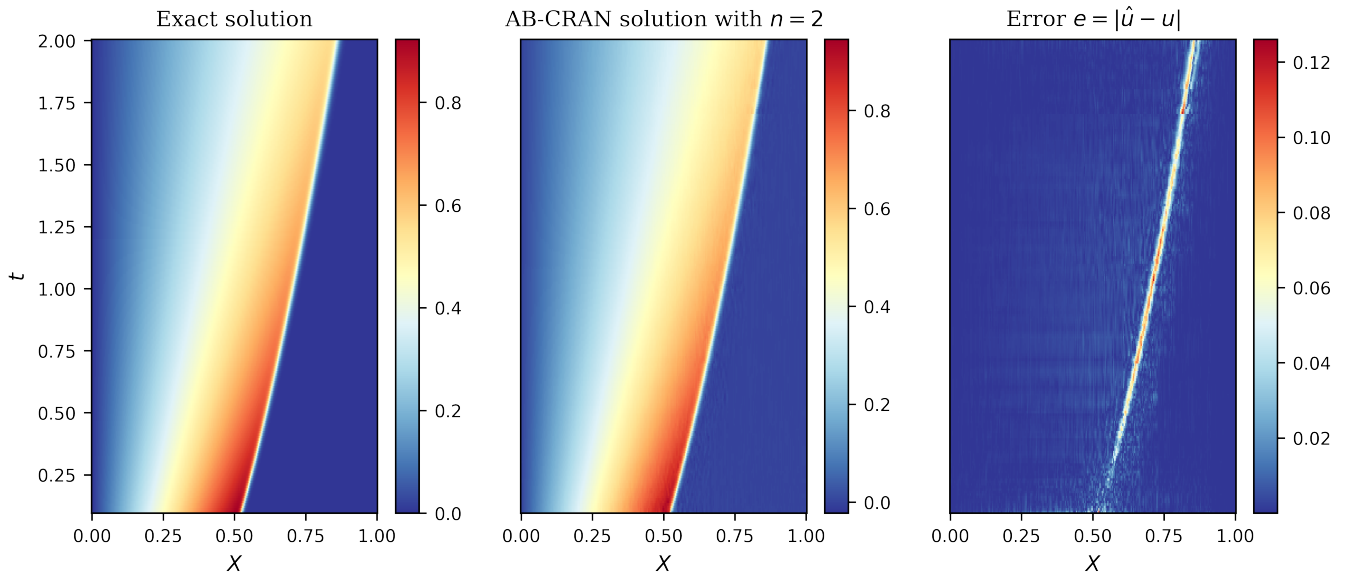

FIG. 13. Nonlinear viscous Burgers problem: Exact solution (left), AB-CRAN solution with $n = 2$ (center) and error $e = |\hat{u} - u|$ (right) for the testing-parameter instance $Re = 1100$ in the space-time domain

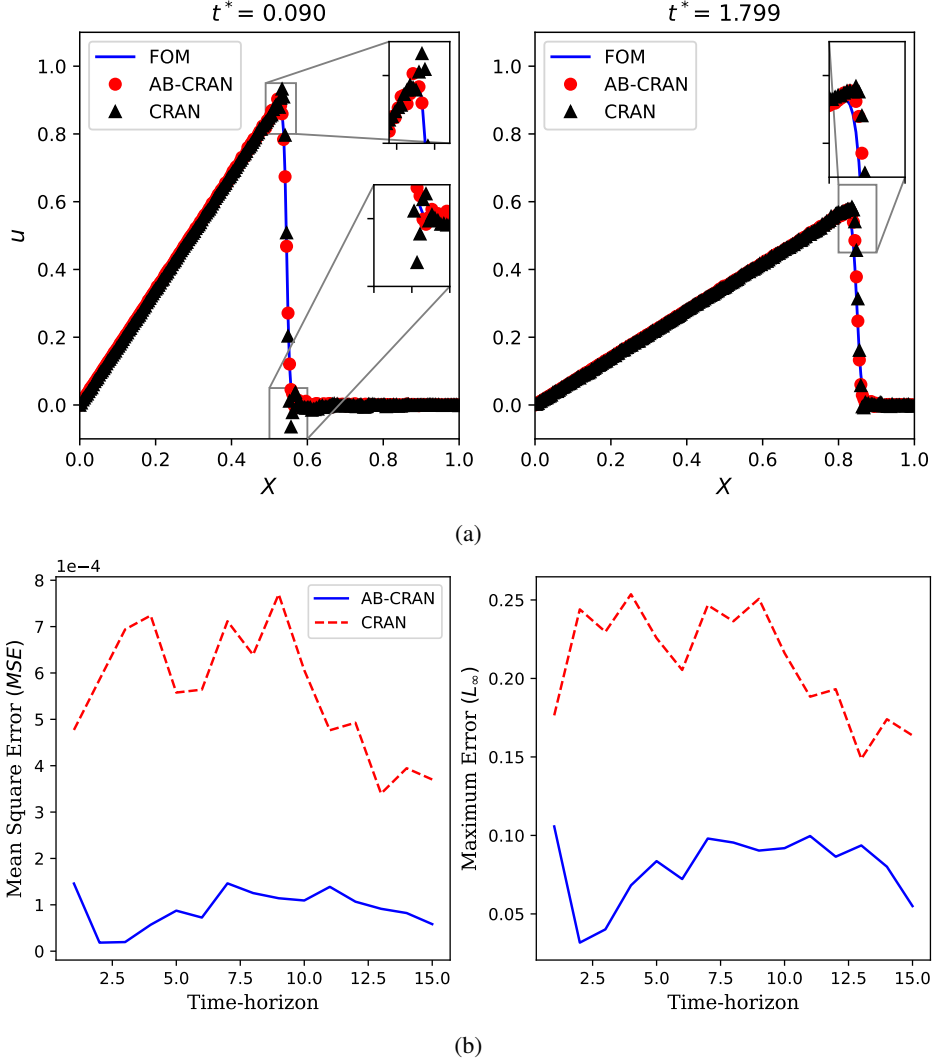

FIG. 14. Error plots and predictions from AB-CRAN and CRAN for $Re = 1100$. (a) Shows AB-CRAN and CRAN predictions for $Re = 1100$ at time steps $t^* = \{0.09, 1.79\}$. (b) Illustrates MSE and maximum error from AB-CRAN and CRAN for $Re = 1100$.

mean square error. The results indicate that the AB-CRAN network can significantly reduce the error of CRAN predictions for the two-dimensional cases as well. The results suggest that our trained network can perform the wave propagation for the two-dimensional case without hyperparameter tuning hence that the present algorithm confirms the scalability to multi-dimensions.

D. Discussion

The solution of a hyperbolic partial differential equation can be integrated in time along the integral curves the so called characteristics. Information propagates at finite speeds along these low-dimensional characteristic curves and the solution is a superposition of simple wave-like characteristics. Loosely speaking, characteristic curves allow to reduce the hyperbolic PDE solution into an ordinary differential equation.

The data matrix generated from the hyperbolic PDEs contains the essential information about the characteristic curves and the underlying physics of the problem. Passing this data matrix through a deep neural network architecture successively transforms the data matrix and hierarchically extracts the significant spatial and temporal features. Particular deep neural network architectures have certain biases to extract a certain type of features, e.g. CNN with max-pooling extracts translational invariant features. The stochastic and randomness in the denoising convolutional autoencoder allows the AB-CRAN architecture to further identify the translational invariant low-dimensional manifold similar to projecting the hyperbolic PDE along the characteristic curves. Attention-based sequence-to-sequence modeling attempts to learn the trajectory along these curves and transposes convolution projects the solution back to physical space. The physical priors endowed in the AB-CRAN neural network architecture allow it to predict wave propagation for large time horizons.

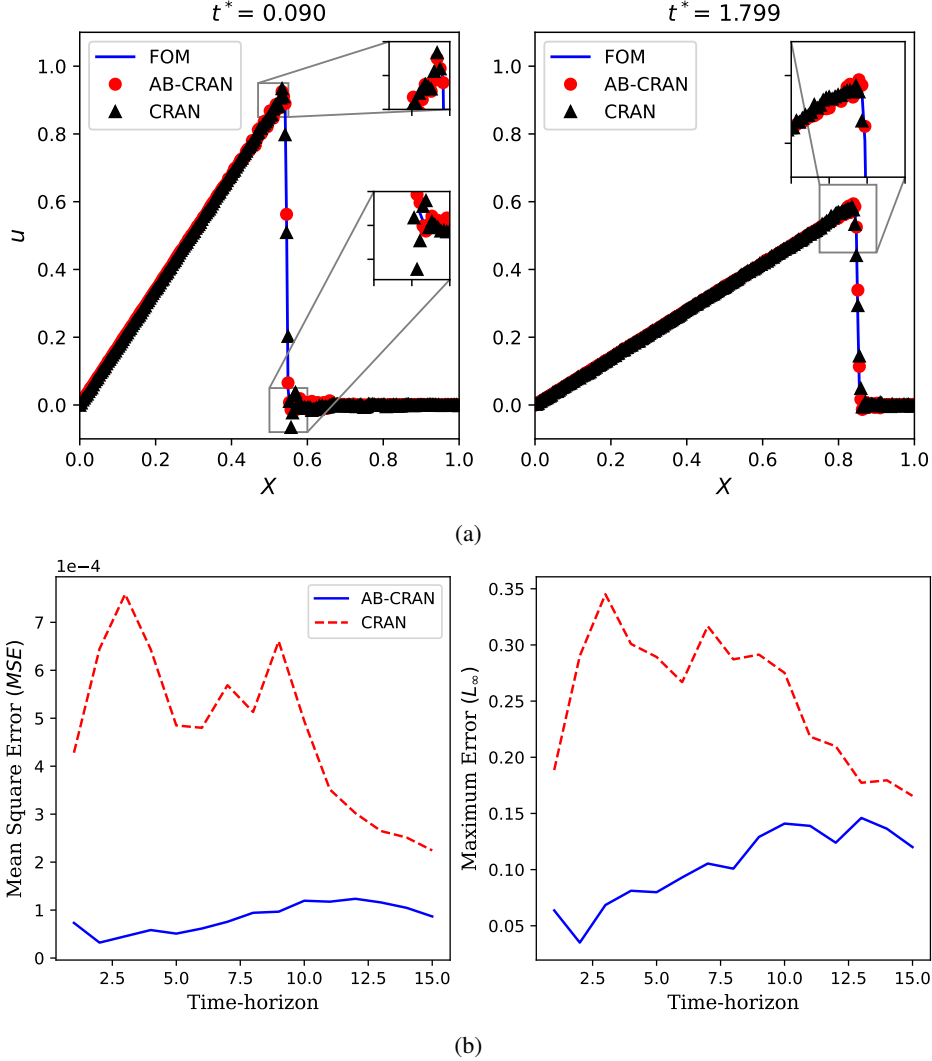

FIG. 15. Nonlinear viscous Burger problem: Error plots and predictions from AB-CRAN and CRAN at $Re = 3600$. (a) Shows AB-CRAN and CRAN predictions for $Re = 3600$ at time steps $t^* = \{0.09, 1.79\}$. (b) Illustrates MSE and maximum error from AB-CRAN and CRAN for $Re = 3600$.

The AB-CRAN architecture is capable enough to capture the temporal evolution of the initial disturbance and the different spatial behaviors of the solution across the domain. The attention-based sequence-to-sequence RNN-LSTM for evolving latent dimension in time captures dependency in long-term sequences and preserves the information for long-time horizons. The numerical integration methods such as Euler-Forward difference in time which uses information from the neighboring cells at present time level n ($U_{i-1}^n, \dots, U_i^n, \dots, U_{i+1}^n$) to evolve the solution at time level $n+1$ (U_i^{n+1}), our architecture uses the entire grid input sequence and encodes it to a context vector and pass it through decoder RNN-LSTM to predict solution at multiple time levels in future (U^t, \dots, U^{t+k}). This facilitates to capture of the propagation of disturbance over long time horizons. The AB-CRAN architecture resembles the time marching capabilities of multi-point ODE integrators and employs multiple past points to predict the future evolution. Instead of using the

fixed weighting coefficient for the past time-steps, the AB-CRAN architecture dynamically learns the weighting coefficient through the data that provides the capability to predict the solution for a longer time horizon.

VI. CONCLUSIONS

In this work, we have presented a novel attention-based sequence-to-sequence convolutional recurrent autoencoder network for learning wave propagation. The challenges of reducing the dimensionality of data coming from hyperbolic PDEs were discussed and the idea of incorporating knowledge within the network architecture has been demonstrated. The proposed AB-CRAN networks serve as an end-to-end nonlinear model reduction tool for wave propagation and convection-dominated flow predictions. The denoising-based convolutional autoencoder together with the attention-based

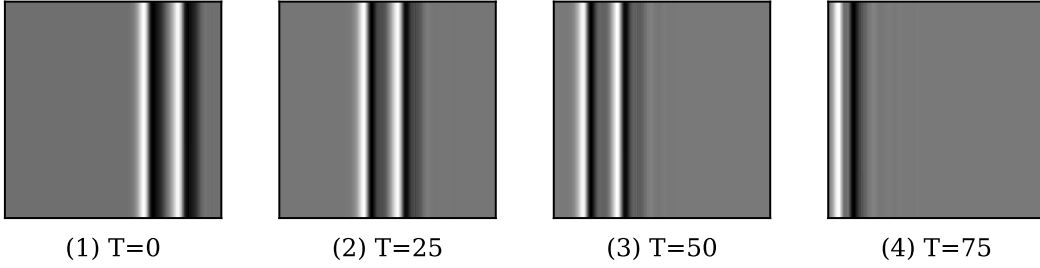

FIG. 16. 2D Saint-Venant problem: Illustration of the propagation of a plane wave. T represents the number of time steps from the initial condition.

TABLE VI. Saint-Venant shallow water problem: Network architecture.

Encoder						
Layer	Layer Type	Input Dimension	Output Dimension	Kernel Size	# filters/ # neurons	Stride
1	Conv 2D	[10, 184, 184, 1]	[10, 92, 92, 64]	[5]	64	2
	MaxPool 2D	[10, 92, 92, 64]	[10, 46, 46, 64]	-	-	-
2	Conv 2D	[10, 46, 46, 64]	[10, 23, 23, 32]	[5]	32	2
	Flatten	[10, 23, 23, 32]	[10, 16928]	-	-	-
3	Dense	[10, 16928]	[10, 128]	-	128	-
4	Dense	[10, 128]	[10, 64]	-	64	-
5	Dense	[10, 64]	[10, n]	-	n	-
Evolver						
Layer	Layer Type	Input Dimension	Output Dimension	Hidden State	Input	# Neurons
6	RNN-LSTM	[10,n]	[10,p]	None	Latent Dimension	p
7	RNN-LSTM	[10,p]	[10,p]	None	Layer 6 output	p
8	RNN-LSTM	[10,p]	[10,p]	Layer 6 internal state	Layer 7 output	p
9	RNN-LSTM	[10,p]	[10,p]	Layer 7 internal state	Layer 8 output	p
10	Attention	[10,p],[10,p]	[10,2p]	-	Layer 7&9 output	p
11	Dense	[10,2p]	[10,n]	-	Layer 10 output	n
Decoder						
Layer	Layer Type	Input Dimension	Output Dimension	Kernel Size	# filters/ # neurons	Stride
11	Dense	[10,n]	[10,64]	-	64	-
12	Dense	[10,64]	[10, 128]	-	128	-
13	Dense	[10,128]	[10,16928]	-	512	-
	Reshape	[10,16928]	[10,23,23,32]	-	-	-
14	Conv 2D Transpose	[10,23,23,32]	[10,46,46,64]	[5]	64	2
	UpSampling 2D	[10,46,46,64]	[10,92,92,64]	-	-	-
15	Conv 2D Transpose	[10,92,92,64]	[10,184,184,1]	[5]	1	2

sequence-to-sequence via RNN-LSTM has been employed as the generalized nonlinear manifold for time marching. In relation to the predictive capability, we have demonstrated a remarkable increase in the time-horizon of AB-CRAN in contrast to the standard RNN-LSTM counterpart on wave propagation problems. Three test problems of increasing complexity namely the 1D linear convection, the 1D nonlinear viscous Burger and 2D shallow water wave problem were considered to demonstrate the various aspects of the proposed attention-based sequence-to-sequence RNN-LSTM and the denoising-based convolutional autoencoder. We have first assessed the effectiveness of our AB-CRAN algorithm for the linear convection equation. The generality of the present algorithm for

the nonlinear phenomenon was successfully demonstrated via the nonlinear viscous Burgers equation. The scalability of our AB-CRAN framework has been successfully shown by solving the 2D Saint-Venant shallow water wave problem. On both 1D and 2D datasets of hyperbolic PDEs, our novel AB-CRAN with sequence-to-sequence learning accurately captures the wave amplitude and efficiently learns the wave propagation in time. The proposed AB-CRAN framework is general and has the potential to be used for predicting large-scale 3D convection-dominated problems of practical importance.

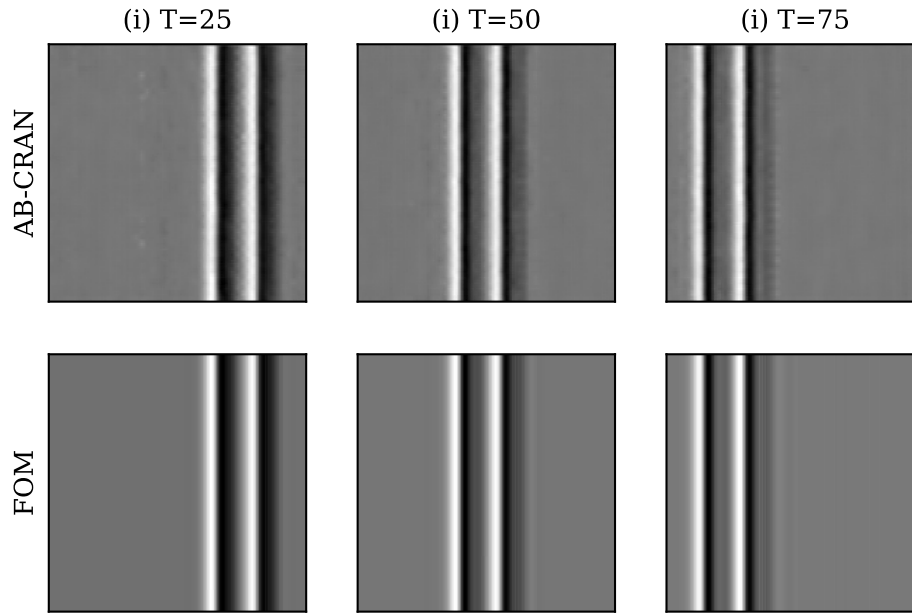

FIG. 17. 2D Saint-Venant shallow water problem: predicted two-dimensional spatial patterns from AB-CRAN and FOM solution from a high-fidelity numerical solver.

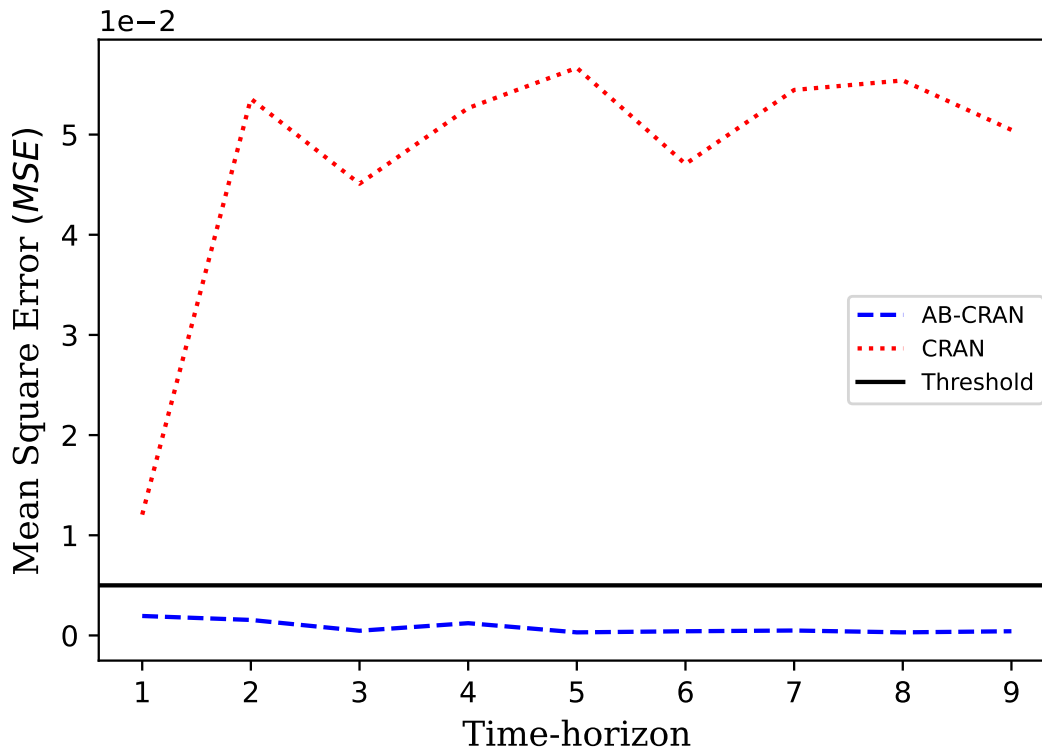

FIG. 18. 2D Saint-Venant shallow water problem: Comparison of mean square error vs time-horizon for the predictive capability of AB-CRAN and CRAN. While blue curve is the prediction from AB-CRAN, red curve shows the prediction from CRAN. Herein, a sequence of ten time steps is termed as one time-horizon.

ACKNOWLEDGEMENTS

The authors would like to acknowledge the funding support from the University of British Columbia (UBC) and the Natural Sciences and Engineering Research Council of Canada (NSERC). This research was supported in part through computational resources and services provided by Advanced Research Computing (ARC) at the University of British Columbia and Compute Canada.

DATA AVAILABILITY

The data that support the findings of this study are available from the corresponding author upon reasonable request.

CONFLICT OF INTEREST

The authors declare that they have no conflict of interest.

REFERENCES

- ¹Athanasios C Antoulas. *Approximation of large-scale dynamical systems*. SIAM, 2005.
- ²P. Baldi and K. Hornik. Neural networks and principal component analysis: Learning from examples without local minima. *Neural networks*, 2(1):53–58, 1989.
- ³Yoshua Bengio. Practical recommendations for gradient-based training of deep architectures. In *Neural networks: Tricks of the trade*, pages 437–478. Springer, 2012.
- ⁴Peter Benner, Wil Schilders, Stefano Grivet-Talocia, Alfio Quarteroni, Gianluigi Rozza, and Luís Miguel Silveira. *Model Order Reduction: Volume 2: Snapshot-Based Methods and Algorithms*. De Gruyter, 2020.
- ⁵Peter Benner, Wil Schilders, Stefano Grivet-Talocia, Alfio Quarteroni, Gianluigi Rozza, and Luís Miguel Silveira. *Model Order Reduction: Volume 3 Applications*. De Gruyter, 2020.
- ⁶Michael M. Bronstein, Joan Bruna, Yann LeCun, Arthur Szlam, and Pierre Vandergheynst. Geometric deep learning: Going beyond Euclidean data. *IEEE Signal Processing Magazine*, 34(4):18–42, Jul 2017.
- ⁷Sandeep Reddy Bukka, Rachit Gupta, Allan Ross Magee, and Rajeev Kumar Jaiman. Assessment of unsteady flow predictions using hybrid deep learning based reduced-order models. *Physics of Fluids*, 33(1):013601, 2021.
- ⁸Sandeep Reddy Bukka, Allan Ross Magee, and Rajeev Kumar Jaiman. Deep convolutional recurrent autoencoders for flow field prediction, 2020.
- ⁹Nicolas CELLIER. locie/triflow: v0.4.3, May 2017.
- ¹⁰Kyunghyun Cho, Bart Van Merriënboer, Caglar Gulcehre, Dzmitry Bahdanau, Fethi Bougares, Holger Schwenk, and Yoshua Bengio. Learning phrase representations using rnn encoder-decoder for statistical machine translation. *arXiv preprint arXiv:1406.1078*, 2014.
- ¹¹G. Cybenko. Approximation by superpositions of a sigmoidal function. *Mathematics of Control, Signals, and Systems*, 2(4):303–314, 1989.
- ¹²Carlos M Duarte, Lucille Chapuis, Shaun P Collin, Daniel P Costa, Reny P Devassy, Victor M Eguiluz, Christine Erbe, Timothy AC Gordon, Benjamin S Halpern, Harry R Harding, et al. The soundscape of the anthropocene ocean. *Science*, 371(6529), 2021.
- ¹³Jeffrey L Elman. Finding structure in time. *Cognitive science*, 14(2):179–211, 1990.
- ¹⁴C. Erbe, S. A. Marley, R. P. Schoeman, J. N. Smith, L. E. Trigg, and C. B. Embling. The effects of ship noise on marine mammals—a review. *Frontiers in Marine Science*, 6:606, 2019.
- ¹⁵Charles Fefferman, Sanjoy Mitter, and Hariharan Narayanan. Testing the manifold hypothesis. *Journal of the American Mathematical Society*, 29(4):983–1049, 2016.
- ¹⁶Stefania Fresca, Andrea Manzoni, et al. A comprehensive deep learning-based approach to reduced order modeling of nonlinear time-dependent parametrized pdes. *Journal of Scientific Computing*, 87(2):1–36, 2021.
- ¹⁷Nicholas Geneva and Nicholas Zabaras. Quantifying model form uncertainty in reynolds-averaged turbulence models with bayesian deep neural networks. *Journal of Computational Physics*, 383:125–147, 2019.
- ¹⁸Francisco J Gonzalez and Maciej Balajewicz. Deep convolutional recurrent autoencoders for learning low-dimensional feature dynamics of fluid systems. *arXiv preprint arXiv:1808.01346*, 2018.
- ¹⁹Constantin Greif and Karsten Urban. Decay of the kolmogorov n-width for wave problems. *Applied Mathematics Letters*, 96:216–222, 2019.
- ²⁰Constantin Greif and Karsten Urban. Decay of the kolmogorov n-width for wave problems. *Applied Mathematics Letters*, 96:216–222, 2019.
- ²¹R. Gupta and R. Jaiman. A hybrid partitioned deep learning methodology for moving interface and fluid–structure interaction. *Computers & Fluids*, 233:105239, 2022.
- ²²Geoffrey E Hinton and Ruslan R Salakhutdinov. Reducing the dimensionality of data with neural networks. *science*, 313(5786):504–507, 2006.
- ²³Sepp Hochreiter and Jürgen Schmidhuber. Long short-term memory. *Neural computation*, 9(8):1735–1780, 1997.
- ²⁴K. Hornik, M. Stinchcombe, and H. White. Universal approximation of an unknown mapping and its derivatives using multilayer feedforward networks. *Neural networks*, 3(5):551–560, 1990.
- ²⁵Diederik P. Kingma and Jimmy Ba. Adam: A method for stochastic optimization, 2017.
- ²⁶Yann LeCun, Yoshua Bengio, and Geoffrey Hinton. Deep learning. *nature*, 521(7553):436–444, 2015.
- ²⁷Kookjin Lee and Kevin T Carlberg. Model reduction of dynamical systems on nonlinear manifolds using deep convolutional autoencoders. *Journal of Computational Physics*, 404:108973, 2020.
- ²⁸Randall J LeVeque et al. *Finite volume methods for hyperbolic problems*, volume 31. Cambridge university press, 2002.
- ²⁹Romit Maulik, Bethany Lusch, and Prasanna Balaprakash. Reduced-order modeling of advection-dominated systems with recurrent neural networks and convolutional autoencoders. *Physics of Fluids*, 33(3):037106, 2021.
- ³⁰Sebastian Mika, Bernhard Schölkopf, Alexander J Smola, Klaus-Robert Müller, Matthias Scholz, and Gunnar Rätsch. Kernel pca and de-noising in feature spaces. In *NIPS*, volume 11, pages 536–542, 1998.
- ³¹T. P. Miyanawala and R. K. Jaiman. An efficient deep learning technique for the navier-stokes equations: Application to unsteady wake flow dynamics. *arXiv preprint arXiv:1710.09099*, 2017.
- ³²T. P. Miyanawala and R. K. Jaiman. A low-dimensional learning model via convolutional neural networks for unsteady wake-body interaction. *arXiv preprint arXiv:1807.09591*, 2018.
- ³³T. P. Miyanawala and R. K. Jaiman. A novel deep learning method for the predictions of current forces on bluff bodies. In *International Conference on Offshore Mechanics and Arctic Engineering*, volume 51210, page V002T08A003. American Society of Mechanical Engineers, 2018.
- ³⁴Rambod Mojjani and Maciej Balajewicz. Physics-aware registration based auto-encoder for convection dominated pdes. *arXiv preprint arXiv:2006.15655*, 2020.
- ³⁵Mario Ohlberger and Stephan Rave. Reduced basis methods: Success, limitations and future challenges. *arXiv preprint arXiv:1511.02021*, 2015.
- ³⁶Allan Pinkus. *N-widths in Approximation Theory*, volume 7. Springer Science & Business Media, 2012.
- ³⁷E. Plaut. From principal subspaces to principal components with linear autoencoders. *arXiv preprint arXiv:1804.10253*, 2018.
- ³⁸Matteo Salvador, Luca Dede, and Andrea Manzoni. Non intrusive reduced order modeling of parametrized pdes by kernel pod and neural networks. *arXiv preprint arXiv:2103.17152*, 2021.
- ³⁹Wilhelmus HA Schilders, Henk A Van der Vorst, and Joost Rommes. *Model order reduction: theory, research aspects and applications*, volume 13. Springer, 2008.
- ⁴⁰J. Schmidt-Hieber. The kolmogorov–arnold representation theorem revisited. *Neural Networks*, 137:119–126, 2021.
- ⁴¹M Seeger, H Nickisch, R Pohmann, and B Schölkopf. Advances in neural information processing systems vol 21 ed koller d, schuurmans d, bengio y

- and bottou I, 2009.
- ⁴²Wilhelm E Sorteberg, Stef Garasto, Alison S Pouplin, Chris D Cantwell, and Anil A Bharath. Approximating the solution to wave propagation using deep neural networks. *arXiv preprint arXiv:1812.01609*, 2018.
- ⁴³Ilya Sutskever, Oriol Vinyals, and Quoc V Le. Sequence to sequence learning with neural networks. In *Advances in neural information processing systems*, pages 3104–3112, 2014.
- ⁴⁴Joshua B Tenenbaum et al. Mapping a manifold of perceptual observations. *Advances in neural information processing systems*, 10:682–688, 1998.
- ⁴⁵Pascal Vincent, Hugo Larochelle, Yoshua Bengio, and Pierre-Antoine Manzagol. Extracting and composing robust features with denoising autoencoders. In *Proceedings of the 25th international conference on Machine learning*, pages 1096–1103, 2008.
- ⁴⁶Jared Willard, Xiaowei Jia, Shaoming Xu, Michael Steinbach, and Vipin Kumar. Integrating scientific knowledge with machine learning for engineering and environmental systems, 2021.
- ⁴⁷Jiayang Xu and Karthik Duraisamy. Multi-level convolutional autoencoder networks for parametric prediction of spatio-temporal dynamics. *Computer Methods in Applied Mechanics and Engineering*, 372:113379, 2020.
- ⁴⁸Cheng Yang, Xubo Yang, and Xiangyun Xiao. Data-driven projection method in fluid simulation. *Computer Animation and Virtual Worlds*, 27(3-4):415–424, 2016.
- ⁴⁹Yuan Yao, Lorenzo Rosasco, and Andrea Caponnetto. On early stopping in gradient descent learning. *Constructive Approximation*, 26(2):289–315, 2007.