

# TWO MEASURES OF NON-PROBABILISTIC UNCERTAINTY

This work has been submitted to the IEEE for possible publication. Copyright may be transferred without notice, after which this version may no longer be accessible.

Florian Ellsaesser  
Frankfurt School of Economics and Finance

Guido Fioretti  
University of Bologna

Gail E. James  
Independent researcher

## Abstract

There are two reasons why uncertainty about the future yield of investments may not be adequately described by Probability Theory. The first one is due to unique or nearly-unique events, that either never realized or occurred too seldom for probabilities to be reliable. The second one arises when one fears that something may happen, that one is not even able to figure out, e.g., if one asks: “Climate change, financial crises, pandemic, war, what next?”

In both cases, simple one-to-one causal mappings between available alternatives and possible consequences eventually melt down. However, such destructions reflect into the changing narratives of business executives, employees and other stakeholders in specific, identifiable and differential ways. In particular, texts such as consultants’ reports or letters to shareholders can be analysed in order to detect the impact of both sorts of uncertainty onto the causal relations that normally guide decision-making.

We propose structural measures of causal mappings as a means to measure non-probabilistic uncertainty, eventually suggesting that automated text analysis can greatly augment the possibilities offered by these techniques. Prospective applications may concern statistical institutes, stock market traders, as well as businesses wishing to compare their own vision to those prevailing in their industry.

**Keywords:** Uncertainty, Cognitive Maps, Machine Learning, Scenario Planning, Sense-Making, Bounded Rationality

**JEL Classification:** B49, D99, C02

We wish to thank Jochen Runde and Jean Czerlinki for helpful comments and remarks on previous versions of this manuscript.

## Introduction

While most of the times uncertainty is nicely expressed by means of some probability distribution, there exist two sorts of problems where this is not the case. The first one occurs when probabilities must be measured on too small a sample, or no sample at all in the limit case of unique events. The second one occurs after some event has happened, that one had not been able to figure out. One may suspect that other surprising, currently unconceivable events may occur, a circumstance which generates uncertainty about the possibilities being envisaged rather than the relations between them. With possibly awkward, but certainly impressive expressions these two sorts of uncertainty have been ascribed to “known unknowns” and “unknown unknowns,” respectively (Rumsfeld, 2011; Feduzi and Runde, 2014; Faulkner *et al.*, 2017).

The first case is exemplified by Ellsberg’s conceptual experiment. Ellsberg (1961) asked to consider two urns, A and B. Urn A entails black and white balls in equal proportions, whereas all you know about urn B is that it entails black and white balls. Ellsberg remarked that, although the Principle of Sufficient Reason suggests to attach probability  $\frac{1}{2}$  to extract a white (or a black) ball from either urn, no-one would experience the same amount of uncertainty with B as with A.

From a purely conceptual point of view, two solutions exist for this conundrum, which correspond to the frequentist and the subjectivist interpretation of probability, respectively. According to the frequentist interpretation case A is equivalent to tossing a coin infinitely many times, whereas B amounts to expressing oneself on a sample of size zero. Thus, sample size marks the difference between A and B.

By contrast, within a subjectivist interpretation either this is not an issue (De Finetti, 1931) or, in more recent versions, sub-additive probabilities would be called to rescue (Gilboa, 1987; Schmeidler, 1989). According to this extension of the basic theory, probabilities are allowed not to sum up to unity if information is less than perfect. Thus, in the case of Ellsberg’s paradox one would assign  $\frac{1}{2}$  to the probability of either extracting a black or a white ball from urn A, but zero probability to extract either a white or a black ball from B. Taking expectations would suggest that decision-makers prefer urn A, which conforms to common sense.

However, both the frequentist and the subjectivist solution show their limits if one is confronted with urns of type B only. If all options are such that little or no experience is

available, measuring probabilities on nearly-zero samples or attaching very low sub-additive probabilities to all consequences is of little help. This is, indeed, the case of uninsurable risk (Knight, 1921). Possibilities are known, but probabilities are unknowns. It's the case of "known unknowns."

Henceforth we shall submit that, in this case, decision-makers can analyse the structure of their mental representations of possibilities, looking for areas where alternative courses of action do not fan out into widely different consequences. In particular we shall document this practice in the context of Scenario Planning, pointing to the existence of geometrical representations of the intricacy of bi-partite graphs that can be used to assess this sort of uncertainty.

The second case has a more profound origin and involves more destructive consequences. The corresponding sort of uncertainty, which has been eventually qualified as "Keynesian," "fundamental," "true," "epistemic," "ontological" or "radical" uncertainty<sup>1</sup> (Runde, 1990; Davidson, 1991; Dunn, 2001; Dequech, 2004; Lane and Maxfield, 2005; Kay and King, 2020) arises when decision-makers fear that something may happen, that they are not even able to figure out. This sort of uncertainty is likely to be there if something that had not been conceived actually materialized, turning an "unknown unknown" – a possibility whose very existence is unknown (Rumsfeld, 2011; Feduzi and Runde, 2014; Faulkner *et al.*, 2017) – into a so-called "black swan," that is, *ex post*, a very rare event.

Just like measures of sample size or sub-additive probabilities can formally extend utility maximization to include the case of imperfect information, incomplete preferences are eventually called in in order to deal with unknown unknowns (Eliaz and Ok, 2006; Ok, Ortoleva and Riella, 2012; Galaabaatar and Karni, 2013). We do not question the technical perfection of this solution, but we stress that, just as it happened with sub-additive probabilities, technical perfection does not imply usefulness. With sub-additive probabilities and incomplete preferences utility maximization can be formally extended to encompass exotic types of uncertainty, but if those sub-additive probabilities are all close to zero and if no preference exists because alternatives cannot be formulated, expected utility maximization reduces to a hollow shell.

We rather propose an alternative route out of the observation that no uncertainty is there insofar as the unknown remains unknown. This sort of uncertainty rather arises at the

---

<sup>1</sup> While Davidson (1991) contrasts "epistemic" to "ontological" uncertainty, taking the latter as a synonymous of probabilistic uncertainty, Lane and Maxfield (2005) employ the term "ontological uncertainty" in pretty much the same sense as Davidson's "epistemic" uncertainty.

point in time when something that had not been imagined suddenly enters the set of possibilities envisaged by a decision-maker, particularly if this novel possibility is such that it upsets her network of causal relations (Locke *et al.*, 2008; Altmann, 2016; Steiner Sætre and Van de Ven, 2021). This observation is key to our reasoning.

We submit that also the uncertainty deriving from the surprising, destructive arrival of “unknown unknowns” can be observed on mental representations of possibility sets. More specifically, we submit that occasional disruption of the graph of causal relations that link alternatives to consequences can reveal the emergence of this second sort of uncertainty. In particular, we shall illustrate this sort of disruption in the self-representation of the BioTech industry with respect to “Big Pharmas.”

Cognitive maps are essential in order to define measures for both sorts of non-probabilistic uncertainty. In their simplest version (Axelrod, 1976; Sigismund Huff, 1990; Sigismund Huff, Huff and Barr, 2000; Sigismund Huff and Jenkins, 2002), cognitive maps are network representations of world views whose nodes are concepts linked to one another by causal relations. Cognitive maps are traditionally obtained by analysing texts or recorded speeches, such as letters to shareholders, technical reports, or interviews, but we shall point also to the possibility of automatically extracting them by means of algorithms that can be potentially applied to very large amounts of data. While strategy studies are struggling to include “known” and “unknown” unknowns in their formal game-theoretical models (Heifetz *et al.*, 2006, 2013a, 2013b; Bryan *et al.*, 2021), we aim at developing tools to extract data.

We develop our arguments in the ensuing two sections. In the first one, we propose structural measures that can be applied to causal relations of given alternatives and consequences when too little empirical evidence is available to measure probabilities (known unknowns). In the second one, we propose structural measures that can be applied when a novel, unexpected “unknown unknown” appears. In the first case, we point to Scenario Planning as a decision-making tool to which, in certain circumstances, our techniques could be applied. In the second case we point to disruptions of cognitive maps. The ensuing section illustrates machine learning algorithms that are able to speed up measurement by several orders of magnitude. A final section concludes with a general assessment of the prospects of our measurement techniques.

## The Complexity of Scenarios

Scenario Planning emerged among business strategists as a procedure to become aware of available options through extensive discussion and intentional search for non-obvious possibilities that may upset the received conventional wisdom (Schoemaker, 1995; Van der Heijden, 2000; Chermack, 2004; Roxburgh, 2009; Ramírez, Österman and Grönquist, 2013; Erdmann, Sichel and Yeung, 2015). The outcome of this exercise is a set of scenarios that have the purpose of preparing strategists for non-trivial future contingencies.

Scenarios constitute a network of concepts linked to one another by causal relations. Indeed, the network representation of scenarios is nothing but their authors' cognitive map (Goodier et al., 2010; Amer, Jetter and Daim, 2011; Jetter and Schweinfort, 2011; Alipour et al., 2017).<sup>2</sup> Although in many instances probabilities can be attached to the causal relations that lead to alternative scenarios and the exercise becomes indistinguishable from taking expectations, Scenario Planning is most valuable when probabilities are unknown (Wilson, 2000; Goodwin and Wright, 2001; Wright and Goodwin, 2009; Ramirez and Selin, 2014). In this case, Scenario Planning is valuable insofar as it allows an analysis of the structure of causal relations that link known possibilities to one another, whose probabilities are unknown. We are, in other words, in the case of “known unknowns.”

For instance, the scenarios described in Figure (1) illustrate a possible cognitive map of the consequences of the Jan 2016 UN decision to lift sanctions on Iran in terms of oil exports (loosely inspired by Alipour et al., 2017). This cognitive map does not simply take account of the presumably larger offer of oil on the world market with the ensuing price dynamics, but also less obvious factors such as the availability of shale oil as well as renewable energy sources. Due to these factors, a non-obvious Scenario 2 appears along with the obvious Scenario 1 according to which Iran's production and revenues will both increase. According to Scenario 2, in spite of lifting sanctions both production and revenues will stagnate, which is just the opposite of what one would expect.

---

<sup>2</sup> These Authors generally adopt a probabilistic interpretation of scenarios. However, the connection they make between scenarios and cognitive maps remains equally valid if probabilities are not used.

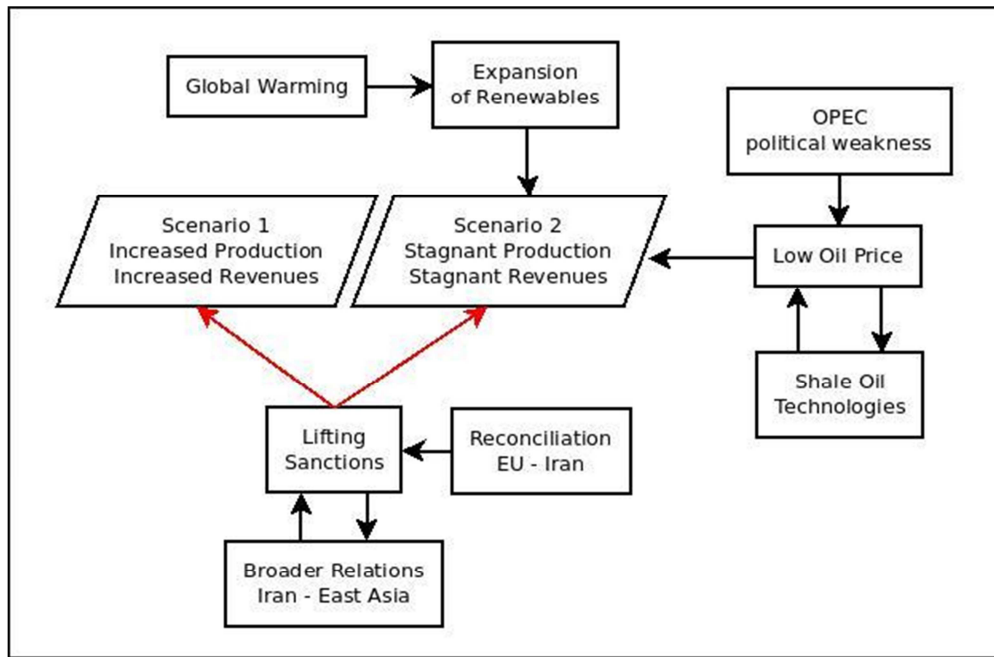

Figure 1. One and the same action - lifting sanctions on Iran - may lead to quite different outcomes depending on many other factors, such as growing availability of renewable energy sources or shale oil. One-to-many causal relations are highlighted in red. Loosely inspired by (Alipour et al., 2017).

Notably, the authors of the Scenarios illustrated in Figure (1) could not attach any probability to the causal relations that would either yield Scenario 1 or Scenario 2. Novel technologies and unprecedented political alliances made it impossible to provide a numerical estimation that would be anything beyond a personal guess. Just like Ellsberg's urn B (Ellsberg, 1961), also in this case it all depends on the lack of samples where probabilities could be reliably measured.

However, in spite of uncertainty on probability values, this exercise in Scenario Planning is not useless. Indeed, it is even more useful than in the case probabilities could be attached to it. Without probabilities being made available, Scenario Planning is a technique for eliciting possibilities out of multiple points of view instead of rushing to select one and stick to it (Stirling, 2010). In the above example, becoming aware that the non-obvious Scenario 2 exists is the goal of the exercise illustrated in Figure (1).

From a structural point of view, the interesting portion of Figure (1) is the one-to-many relation from "Lifting sanctions" to either Scenario 1 or Scenario 2. We maintain that it makes sense to analyse the structure of causal relations in exercises such as Scenario Planning in order to assess the uncertainty generated by such one-to-many causal relations.

In order to keep matters tractable let us assume that cognitive maps are made of *Evoked Alternatives* (EA), *Perceived Consequences* (PC), and causal relations from EA to PC (March and Simon, 1958). For instance, the relevant portion of the cognitive map of Figure (1) is made of one evoked alternative (lifting sanctions) and two perceived consequences (increasing or stagnant oil production, respectively).

Figure (2) illustrates three arrangements of causal relations between evoked alternatives and perceived consequences. On the left (a), all causal relations are one-to-one. This is the simple world where one perceives exactly which consequence follows from each of the evoked alternatives. In the middle (b) is the extremely complex world where one perceives that any consequence can follow from each of the evoked alternatives. On the right (c), is the somehow intermediate situation where, in spite of several one-to-many relations, one knows that certain evoked alternatives can only lead to a subset of the perceived consequences.

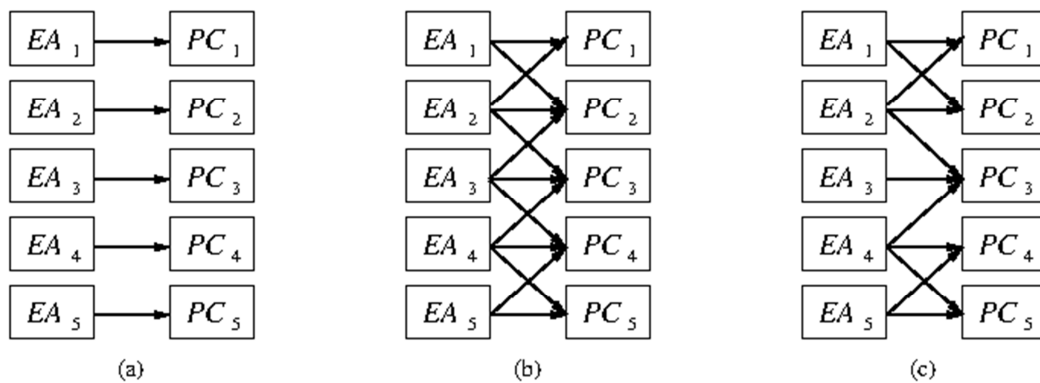

Figure 2. Three stylized cognitive maps linking evoked alternatives (EAs) to perceived consequences (PCs). In (a), a one-to-one mapping with complexity . In (b), the most confusing a one-to-many mapping where anything may happen. In this case, . In (c), an intermediate case where .

The case illustrated in (c) is the most interesting one, because in this case the network of causal relations between evoked alternatives and perceived consequences exhibits a structure. One feature of this structure is that although certain areas are tightly connected (EA<sub>1</sub> and EA<sub>2</sub> with PC<sub>1</sub> and PC<sub>2</sub>; EA<sub>4</sub> and EA<sub>5</sub> with PC<sub>4</sub> and PC<sub>5</sub>), these areas are loosely connected with one another and therefore, even though it may be difficult to tell the difference between selecting EA<sub>1</sub> and EA<sub>2</sub>, it is possible to state that either choice is different from either selecting EA<sub>4</sub> or EA<sub>5</sub>. One other feature is that there are groups of perceived

consequences that are unlikely to occur in isolation from one another (for instance  $PC_2$  and  $PC_3$  if one selects  $EA_2$ ), and therefore these groups constitute entities in themselves.

The schemes illustrated in Figure (2) are bipartite graphs. Their structure can be analysed and subsumed by quantitative indicators based on  $q$ -analysis (see Appendix A). In a nutshell, applying  $q$ -analysis to decision problems implies the construction of a *simplicial complex* whose simplices correspond to the evoked alternatives  $EA_i$ . Each simplex  $EA_i$  has as many vertices as the perceived consequences  $PC_{ij}$  to which it is connected. Thus, the simplices that constitute the simplicial complexes have common faces whose dimensions depend on the number of perceived consequences that they have in common. Consequently, the simplicial complex has a structure where the areas of the decision problem where each of a few evoked alternatives correspond to very many perceived consequences are represented by clusters of simplices connected along high-dimensional faces. These are the areas that generate the highest uncertainty, yet the uncertainty that they generate is not extremely high if these areas are connected by low-dimensional simplices as in the case (c) of Figure (2). Thus,  $q$ -analysis defines a *structure vector* whose components are the number of classes of simplices connected at each dimensional level. The higher the dimensional level, the more difficult a decision problem, but the greater the number of disjoint classes at the highest levels, the more tractable it becomes.

Decision problems where simplices share high-dimensional faces obtain the greatest benefits from  $q$ -analysis. In non-mathematical terms, this category includes all decision problems where different alternatives imply partially similar consequences, such as diagnoses of rare diseases whose symptoms appear in variable clusters of indicators and partially overlap with those of other diseases (Rucco *et al.*, 2015), or alternative environmental policies that, through complex feed-backs in the ecosystem, may yield partially overlapping negative consequences (Eder *et al.*, 1997; Forrester *et al.*, 2015). Note that in the case of rare diseases, as well as with policies that have a long-lasting impact on the environment, no reliable probability is available.

Several measures can be defined on the structure vector. In particular, it is possible to define suitable measures of the *Complexity* of such graphs (Casti, 1989; Fioretti, 2001). For instance, one such measure (Casti, 1989) ascribes zero complexity to case (a), maximum complexity to case (b) and intermediate complexity to case (c) (see Appendix A). In a modelling exercise, boundedly rational agents could be assumed not to make any decision if complexity exceeds a threshold.



## **When Unexpected, Novel, Destructive Possibilities Materialize**

Let us now focus on the reason why human beings may really decide not to decide, namely when they become aware that some destructive possibility may materialise, that is not among those they are currently envisaging. Such sentiments make perfect sense once unexpected and destructive events have been experienced, which suggest that unthinkable novelties may appear in a world that is governed by unknown laws, if it is governed at all. We submit that a series of cognitive maps taken before, at the time of, and after one such disruptive event allows us to observe such states of mind.

We illustrate our point with a series of cognitive maps in the BioTech industry extracted from the technical reports of dedicated consultant Ernst & Young (James, 1996; See also Appendix B). In the shared vision of BioTech companies, a disruptive possibility materialized in 1990. Up to 1989 most BioTech companies were convinced that they would grow up to become able to produce and market their own drugs. For the time being they had to stipulate strategic alliances with pharmaceutical companies, but this was seen as a temporary arrangement. In reality, their long-term goal was becoming “Big Pharmas.” By contrast, pharmaceutical companies were entering strategic alliances with biotech companies in order to acquire their technology. Their long-term goal was that of generating biotech-based new drugs in-house. In 1990, biotech companies suddenly realized that many contracts that they had signed entailed “poison pills” designed to squeeze their knowledge and profits (James, 1996).

Figures (3) and (4) illustrate a portion of the biotech companies’ cognitive maps in 1989 and 1990, respectively (James, 1996). Note that in 1990 the block *Poison Pills* entered the map, destroying previous linkages.

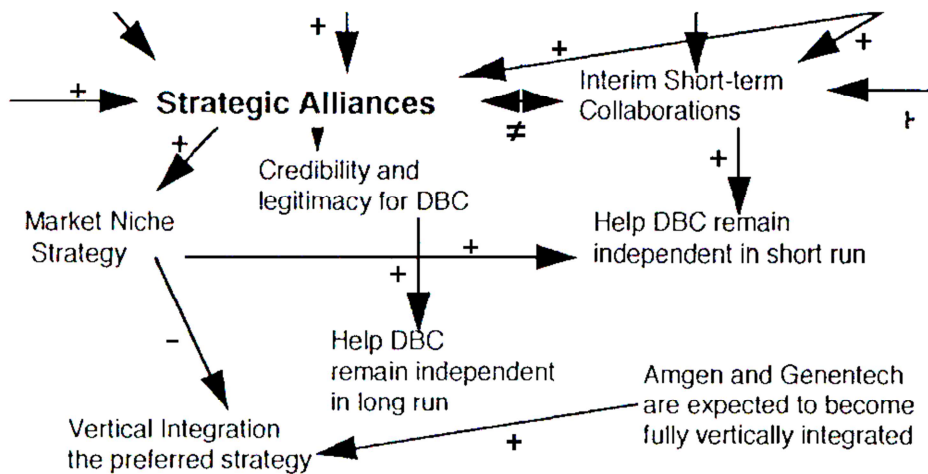

Figure 3. A portion of biotech companies' cognitive maps in 1989 (James, 1996). Incoming arrows stem from parts of the map not shown in this figure.

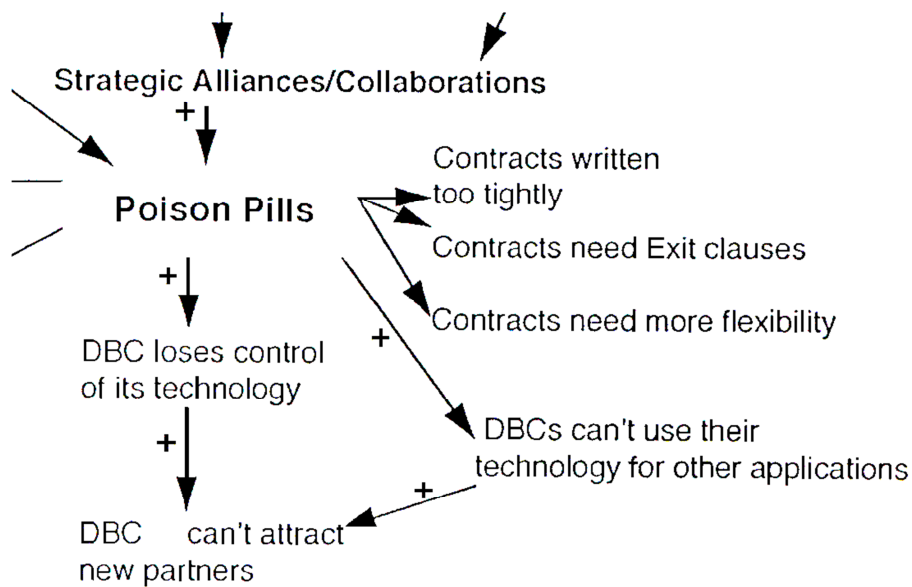

Figure 4. A portion of biotech companies' cognitive maps in 1990 (James, 1996). Incoming arrows stem from parts of the map not shown in this figure.

However, since 1991 biotech companies started caring about legal details, and at the same time started to understand the difficulties involved in drug production and distribution. Conversely, pharmaceutical companies realized that small and independent BioTech companies would guarantee a degree of exploration that in-house, hierarchically organized

research could not attain (James, 1996). Thus, since 1991 the cognitive maps of biotech companies stabilized, providing again a reliable orientation to decision-making. Figure (5) illustrates a portion of the 1991 cognitive map.

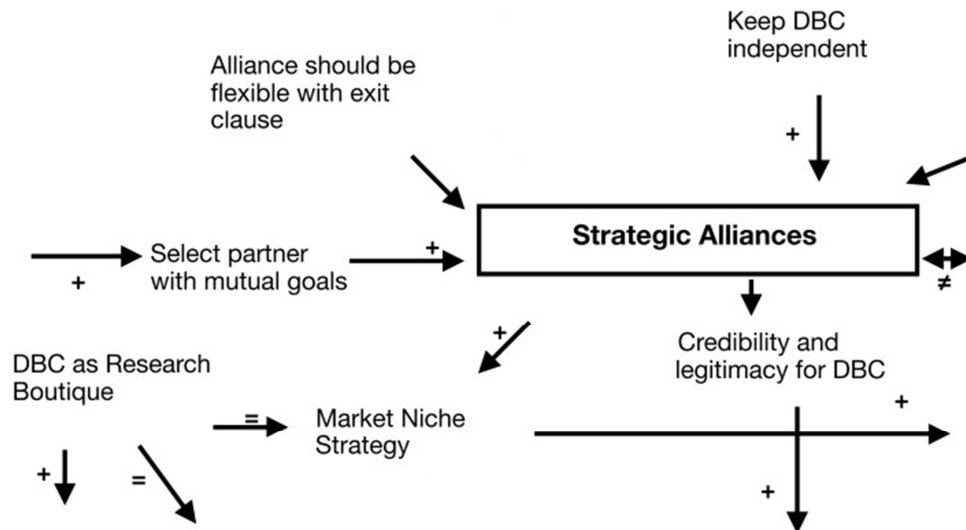

Figure 5. A portion of biotech companies' cognitive maps in 1991 (James, 1996). Incoming and outgoing arrows concern parts of the map not shown in this figure.

In the end, we have a series of eight cognitive maps 1986 to 1993, with one stable period 1986-1989, one stable period 1991-1993, and a disrupted cognitive map in 1990. A few simple metrics can be explored in order to identify indicators that are able to single out the disrupted 1990 map from those of the stable periods that precede and follow it (Eden *et al.*, 1992).

Figure (6) illustrates the number of concepts and its average (black), the number of linkages and its average (green) as well as the ratio between the number of linkages and the number of concepts (bottom line), which is remarkably constant over time. Notably, the number of linkages (green) exhibits a marked drop with respect to its average in 1990. Also the number of concepts (black) dropped in 1990, though possibly less sharply.

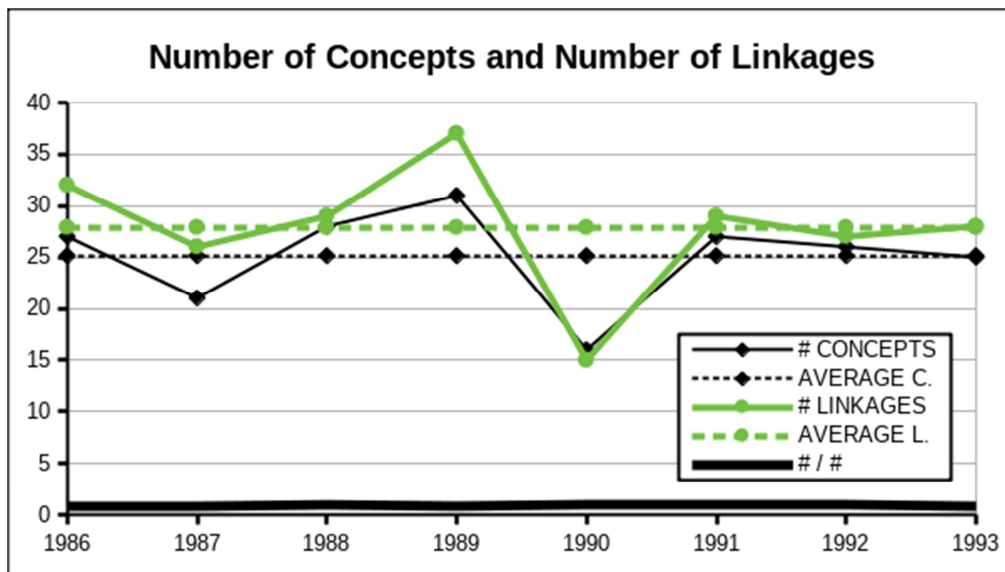

Figure 6. A few metrics of James (1996) series of cognitive maps. The number of concepts (solid black) compared to its average (dotted black), the number of linkages (solid green) compared to its average (dotted green), as well as their ratio (thick black). Notably, the ratio of these two metrics is extremely stable.

To our knowledge, the cognitive maps collected by James (1996) are unique in their ability to capture the magic moment of despair caused by “unknown unknowns” becoming true. The reason is that James (1996) extracted her cognitive maps from the technical reports of Ernst & Young, a dedicated consultant who was keen to express views that, possibly, no single BioTech company had ever confessed. To our knowledge, no other document has ever revealed a comparable richness of details, doubts and surprise. In general, managers portrait rosy pictures and indeed take great care to avoid anything that might unleash panic among shareholders.

Lacking other empirical examples, the proposed metrics – number of concepts, number of linkages – should be understood as a tentative, though sensible starting point. It seems sensible to assume, however, that collapsing cognitive maps display macroscopic structural changes such as a sudden decrease of the number of concepts and linkages.

## **Machine Learning**

Eliciting cognitive maps out of texts is a lengthy, painstaking activity. However, we submit that Machine Learning (ML) can open up novel possibilities in this respect.

ML is a rapidly expanding field that allow processing huge numbers of documents that are available on the Internet and elsewhere. While the simplest algorithms may simply identify a few keywords, more recent developments are creating the possibility to algorithmically extract knowledge graphs (See Appendix C).

A knowledge graph, also known as linked data, can be broadly defined as a knowledge base arranged into nodes and relations between them. Nodes can represent data of any sort, and relations can be of any sort as well, but if we focus on knowledge graphs whose nodes are concepts and relations are causal relations, then we obtain a cognitive map. In other words, if ML techniques are applied to texts that expound a view based on causal relations, and if these techniques are employed to focus on concepts and causal relations linking them to one another, then we obtain a cognitive map. Cognitive maps are a subset of knowledge graphs.

As an example, Figure (7) illustrates a knowledge graph extracted from a medical text suggesting that a disease can be treated by means of two different drugs acting on a gene and a protein, respectively. It is based on concepts (a disease, a drug, a gene, a protein) linked to one another by causal relations (need to administer drugs, drug inhibiting a gene or a protein). Thus, this text provides medical doctors with a cognitive map they should have in mind whenever they meet such a disease. Henceforth, we shall take ML as a technique to elicit cognitive maps.

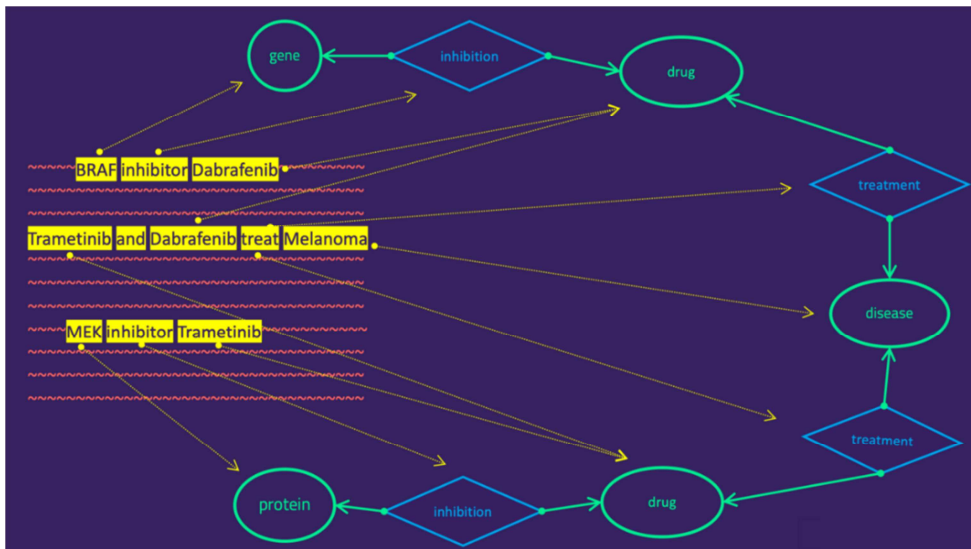

Figure 7. The knowledge graph (cognitive map) extracted from a medical text. The words highlighted on the left correspond to the concepts depicted to the right: protein MEK is inhibited by drug Trametinib, whereas gene BRAF is inhibited by drug Dabrafenib. Both are used to treat Melanoma, the disease. By courtesy of Syed Irtaza Raza (2019), TypeDB.

ML algorithms can be used to extract relevant graphs for decision problems where possibilities are known, but their probabilities are not (known unknowns), as well as for decision problems where doubts exist regarding the composition of the possibility set (unknown unknowns). In the first case, ML algorithms limit themselves to procuring raw data to which the standard tools of  $q$ -analysis can be applied, whereas in the second case some work on defining the correct indicators is still waiting to be done.

One instance of the first sort is the usage of ML algorithms to mine data on newspaper articles in order to group them according to relatedness to one another (Rodrigues, 2014). Newspaper articles can be related to one another according to multiple dimensions, hence a structural  $q$ -analysis is in order. However, procuring data without resorting to ML algorithms would have been extremely time-consuming.

The case of “unknown unknowns” is more complex. As a first step in this direction, we analysed the speeches held by Lufthansa CEO Carsten Spohr at their annual general meeting (AGM) before and after Covid-19, which has been a disruptive, unexpected and unthinkable event for airlines worldwide. In 2020, two indicators called *Density* and *Average Centrality* (see Appendix C) dropped by 43% and 53% compared to 2019. Since no comparable figure occurred in previous or subsequent years, we tentatively hypothesize that this drop was caused by Covid-19. This analysis is at best preliminary, but it suggests that it

may be possible to carry out massive evaluations of documents that are available on the Internet and elsewhere in order to detect the decision not to decide.

Furthermore, this possibility may open up interesting perspectives insofar as it concerns the availability of proper texts. Generally speaking, it is rather difficult to find texts where some decision-maker admits to have been in a desperate situation where their cognitive map had been disrupted. The 2020 Lufthansa AGM is probably an exception due to the fact that (i) the impact of Covid-19 was undeniable, (ii) beyond the CEO's responsibility and, last but not least, (iii) the European Union had provided compensations that largely offset the impact of the pandemic on airlines. Figure (8) illustrates a few key passages of Mr. Spohr's speech along with portions of the corresponding automatically generated cognitive map.

*However, our success story was abruptly interrupted at the beginning of the year by the outbreak of the Corona pandemic and its consequences.*

*Ladies and Gentlemen, Lufthansa's insolvency – also in the special form of protective shield proceedings – would lead to an almost complete loss of your share capital.*

*The competition authorities of the EU Commission have just today approved this package.*

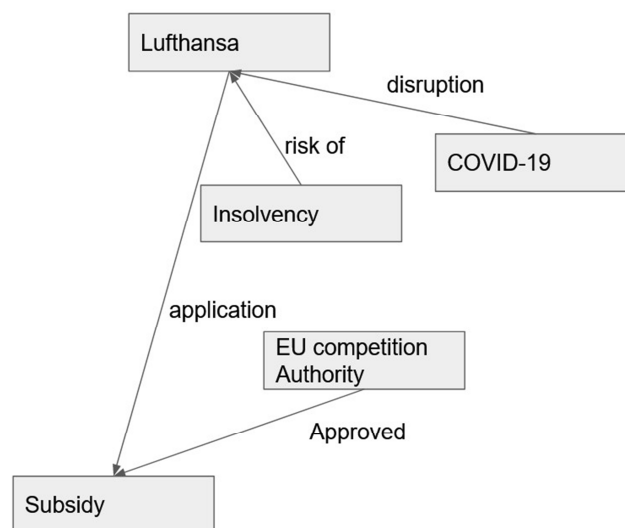

Figure 8. Lufthansa 2020 AGM. A portion of the ML-generated cognitive map, along with key portions of the speech held by Lufthansa CEO Carsten Spohr.

However, ML can positively contribute to this problem by exploring the Internet looking for non-official sources such as blogs and social media where people eventually express themselves without the straitjackets imposed by the organizations to which they belong. While this is still purely speculative for the time being, we are confident that the exploration of the Internet on a large scale – which can be carried out by machines themselves – can potentially yield substantial improvements in the data we are able to access.

One advantage of ML-based cognitive maps is that concepts and links are always extracted exactly in the same way, no matter which text is submitted or which researcher is doing the job. When manual extraction of cognitive maps is carried out, uniformity is sought by assigning the same text to several human coders and using only those concepts and causal relations that all coders identified (Sigismund Huff, 1990). With machine-based extraction, uniformity is achieved by design.

However, precisely uniformity constrains the quality of ML-based cognitive maps. Consider for instance the choice of a parameter such as entropy, which determines the coarseness of concept identification. If this parameter is set too loosely, concepts that are not appropriate for the text may be identified, whereas if it is too strict relevant concepts may be missed. By contrast, human researchers are capable to adapt to the text they are analysing, making human extraction more detailed, accurate and fine-grained.

We do not expect human-based extraction of cognitive maps to disappear altogether. In our opinion, one likely future is that human extraction will be used in order to calibrate the parameters of machine-based extraction.

## **Conclusions**

For decades, non-probabilistic uncertainty has been the domain of critical economists who used it in order to criticize fundamental assumptions with respect to general economic equilibrium theory, the ability of market economies to reach full employment, and the role of Government. Mainstream economists generally neglected its existence, assuming that all uncertainty could be captured by probabilistic expectations.

This picture has changed in recent years, possibly because the technological, environmental and political stage has become uncertain in non-probabilistic terms. Non-probabilistic uncertainty is no longer a niche topic for a few rebellious economists but rather a very practical issue, one with which both economists and practitioners have to deal.

We contributed measurement tools to this more practical stream, but we are aware that action tools must be developed, too. Albeit the measurement problem is sufficiently complex to require a whole paper, we wish to point to possible research directions. In particular, since the problem of “known unknowns” and the problem of “unknown



unknowns” are qualitatively and logically different from one another, we envisage two separate avenues for future research.

For decision problems where possibilities are known, but either because they are unique or other contingent reasons probabilities cannot be reliably measured, we suggest that *q*-analysis can be complemented with practical knowledge of ways in which bounded rationality constrains and directs human behaviour (Kazakova and Geiger, 2016). We mean instances such as “Take the Best” and other fast-and-frugal heuristics (Gigerenzer and Todd, 1999), winning thumb rules in the iterated Prisoner’s Dilemma (Axelrod, 1984; Stewart and Plotkin, 2013), the maximum size of unstructured human groups (James, 1951; Dunbar, 1995), the maximum number of acquaintances (Dunbar, 1998), fixed travel time (Zahavi, 1977), the size of short-term memory (Miller, 1956; Cowan, 2000), the modes of irrational group behaviour (Bion, 1961) and certainly many other instances waiting to be discovered. An inventory of thumb rules along instincts that have evolved with our species through millions of years could help us predict what humans do when they face situations too unique to have probabilities attached to their possible consequences.

Decision problems where the cognitive map has been destroyed by an “unknown unknown” are more complex. A thin but profound stream of literature approaches this sort of problems highlighting that humans construct a novel cognitive map by seeking coherence between apparently disconnected clues, sometimes at the cost of distorting the previous reconstruction of events. It starts with an intuition by March and Olsen (1976), proceeds with the theoretical insights of Karl Weick (1979, 1995), goes through beautiful case-studies (Lane and Maxfield, 2005; Hobsbawm and Ranger, 2012), and arrives at approaches that highlight the intentionality with which relevant actors influence the construction and acceptance of cognitive maps by the general public (Beckert and Bronk, 2018).

Both mathematical and computational tools are already available to capture the mechanisms by which novel cognitive maps emerge. On the one hand, Evidence Theory provides formulas to compute the extent by which novel clues overlap in a “frame of discernment” that differs from the possibility set precisely because it allows for unknown unknowns to be considered (Shafer, 1976; Fioretti, 2009). On the other hand, Constraint Satisfaction Networks reproduce the ability of human brains to stress or downplay specific clues in order to arrange them into a coherent whole (Thagard, 1989; Holyoak and Simon, 1999). We hope, with a small step towards establishing measurement tools, to have contributed to the applicability of otherwise exotic pieces of mathematics.

## Appendix A: $q$ -Analysis

This appendix illustrates the basics of  $q$ -analysis (Atkin, 1974; Legrand *et al.*, 2002; Battiston *et al.*, 2020). Please consult the original references for further details.

A *simplex* is the convex hull of a set of  $(n + 1)$  independent points in some Euclidean space of dimension  $n$  or higher. These points are its *vertices*. A 0-dimensional simplex is a point, a 1-dimensional simplex is a segment, a 2-dimensional simplex is a triangle. Henceforth, higher-dimensional simplices will not be considered.

The convex hull of any non-empty subset of the points that define a simplex is called a *face* of the simplex. In particular, 0-dimensional faces are the vertices of a simplex, 1-dimensional faces are segments that connect vertices. Two simplices are connected if they have a common face. A set of (at least) pairwise connected simplices is a *simplicial complex*.

Henceforth, a cognitive map is graphically represented as a simplicial complex. Evoked Alternatives are simplices whose vertices are the Perceived Consequences to which each Evoked Alternative is connected. Figure (A1) illustrates the simplicial complexes that correspond to cases (b) and (c) in Figure (2).

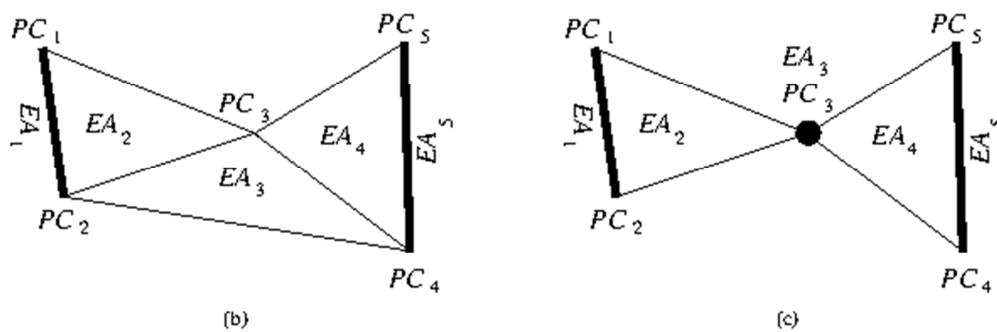

Figure A1. Left, the simplicial complex corresponding to case (b) of Figure (2). Right, the simplicial complex corresponding to case (c) of Figure (2). Segments representing 1-dimensional simplices are thicker than segments representing the faces of 2-dimensional simplices (triangles).

If the connections between categories of actions and categories of results are all one-to-one as in case (a) of Figure (2), then the simplices are isolated points so no simplicial complex exists. In this case, complexity is zero. By contrast, in case (b) and (c) the simplicial complexes illustrated in Figure (A1) yield a complexity greater than zero.

Two simplices are connected if they have at least one common vertex. Two simplices that have no common vertex may nonetheless be connected by a chain of simplices having common vertices with one another. Let us say that simplices  $EA_i$  and  $EA_j$  are  $q$ -connected if there exists a chain of simplices  $EA_u, EA_v, \dots, EA_w$  such that  $q = \min\{l_{i,u}, l_{u,v}, \dots, l_{w,j}\} \geq 0$ , where  $l_{x,y}$  is the dimension of the common face between  $EA_x$  and  $EA_y$ . In particular, two contiguous simplices are connected at level  $q$  if they have a common face of dimension  $q$ .

Let us consider the common faces between simplices and let us focus on the face of largest dimension. Let  $Q$  denote the dimension of this face. It is necessarily  $Q \leq n - 1$ , where  $Q = n - 1$  means that there are at least two overlapping simplices that include all possible vertices.

Let us partition the set of simplices that compose the simplicial complex according to their connection level  $q$ . In general, for  $\forall q$  there exist several classes of simplices such that the simplices belonging to a class are connected at level  $q$ . Let us introduce a *structure vector*  $\mathbf{s}$  whose  $q$ -th component  $s_q$  denotes the number of disjoint classes of simplices that are connected at level  $q$ . Since  $q = 0, 1, \dots, Q$ , vector  $\mathbf{s}$  has  $Q + 1$  rows.

Let us define *Complexity* (Casti, 1989) as:

$$C = \begin{cases} 0 & \text{if all connections are one-to-one} \\ \sum_{q=0}^Q \frac{q+1}{s_q} & \text{otherwise} \end{cases}$$

where the sum extends only to all terms such that  $s_q \neq 0$ . The complexity of two or more disconnected simplicial complexes is the sum of their complexities.

This expression takes account of two opposite effects. On the one hand, the numerator increases with the number of connections between Evoked Alternatives and Perceived Consequences. Thus, it simply measures the extent to which novel connections confuse the cognitive map. On the other hand, the denominator makes complexity decrease to the extent that cross-connections are clustered in distinct groups.

In case (b) of Figures (2) and (A1) there exists one single class of simplices connected at level  $q = 0$  and one single class of simplices connected at level  $q = 1$ , hence  $C = \frac{(0+1)}{1} + \frac{(1+1)}{1} = 3$ . By contrast, in case (c) there exists one class of simplices connected at level  $q = 0$  but two classes of simplices connected at level  $q = 1$ , hence  $C = \frac{(0+1)}{1} + \frac{(1+1)}{2} = 2$ .

## Appendix B: The Series of Cognitive Maps

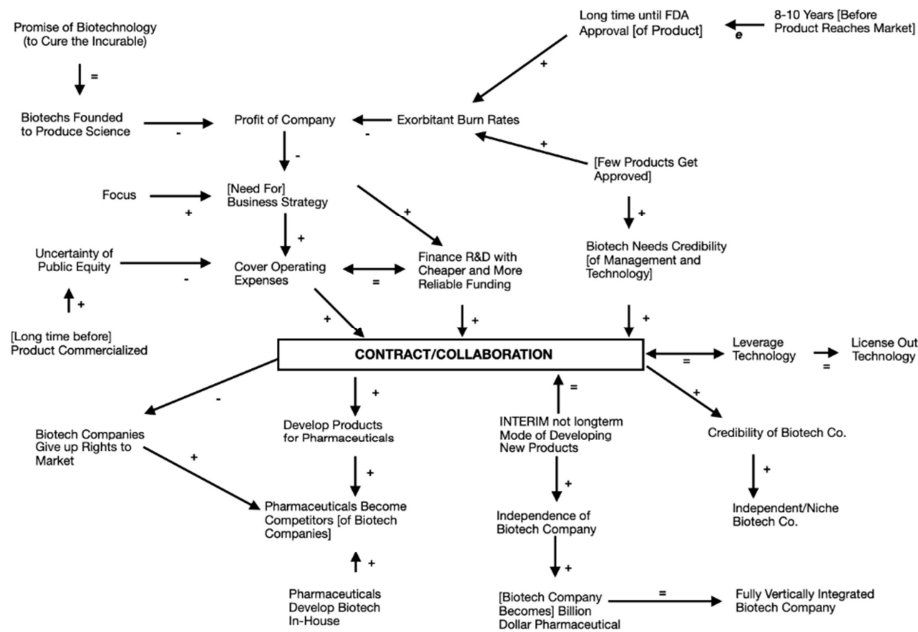

Figure B1. Biotech companies' cognitive map, 1986 (James, 1996).

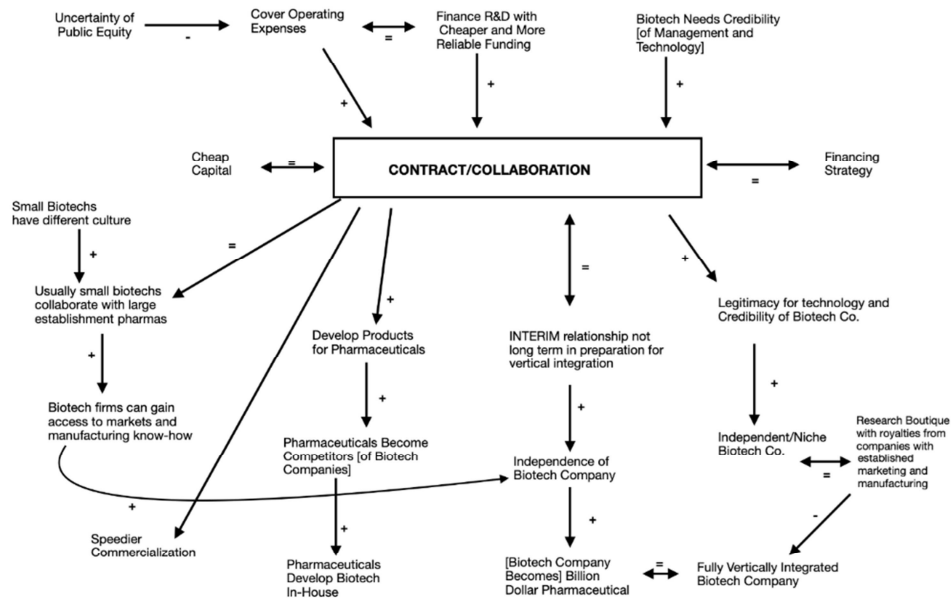

Figure B2. Biotech companies' cognitive map, 1987 (James, 1996).

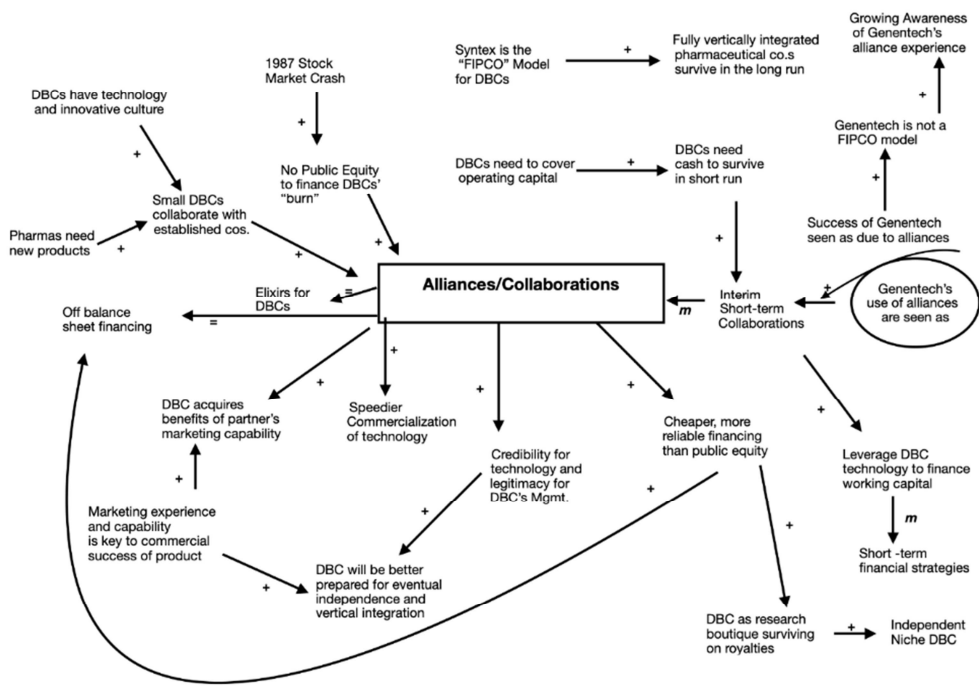

Figure B3. Biotech companies' cognitive map, 1988 (James, 1996).

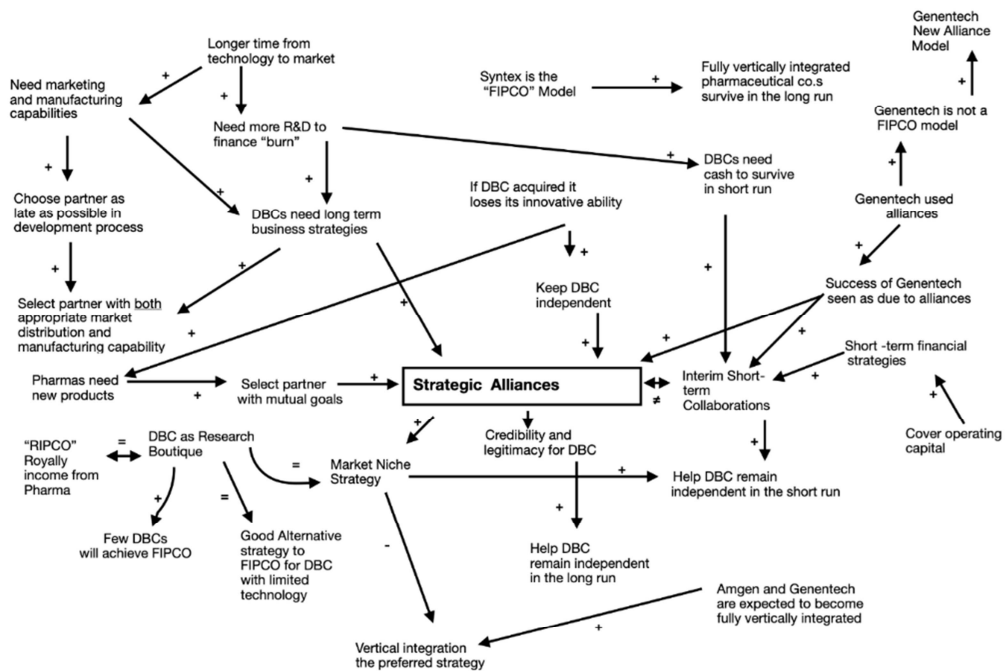

Figure B4. Biotech companies' cognitive map, 1989 (James, 1996).

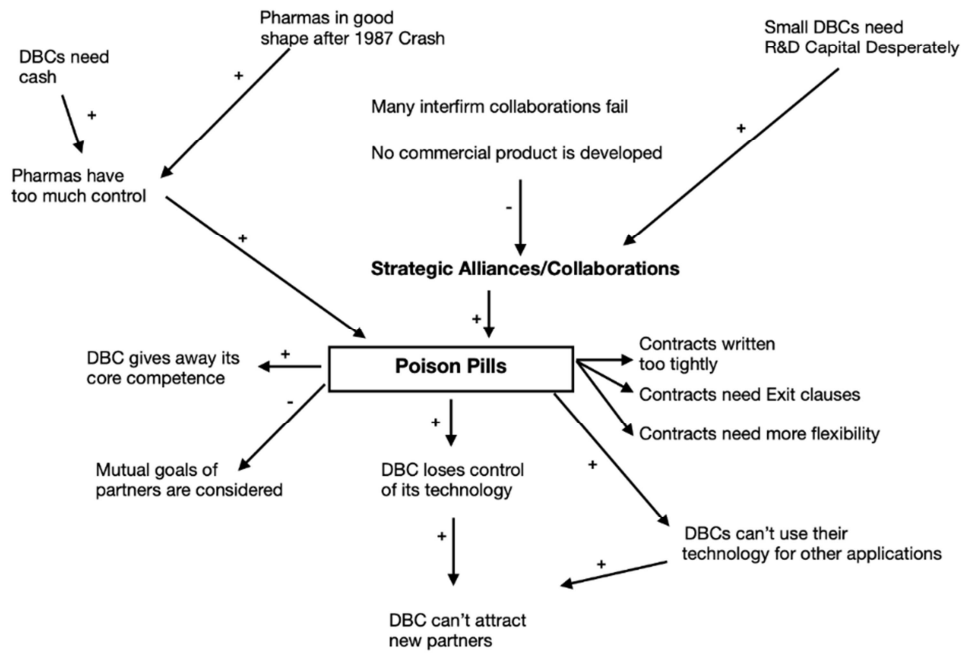

Figure B5. Biotech companies' cognitive map, 1990 (James, 1996).

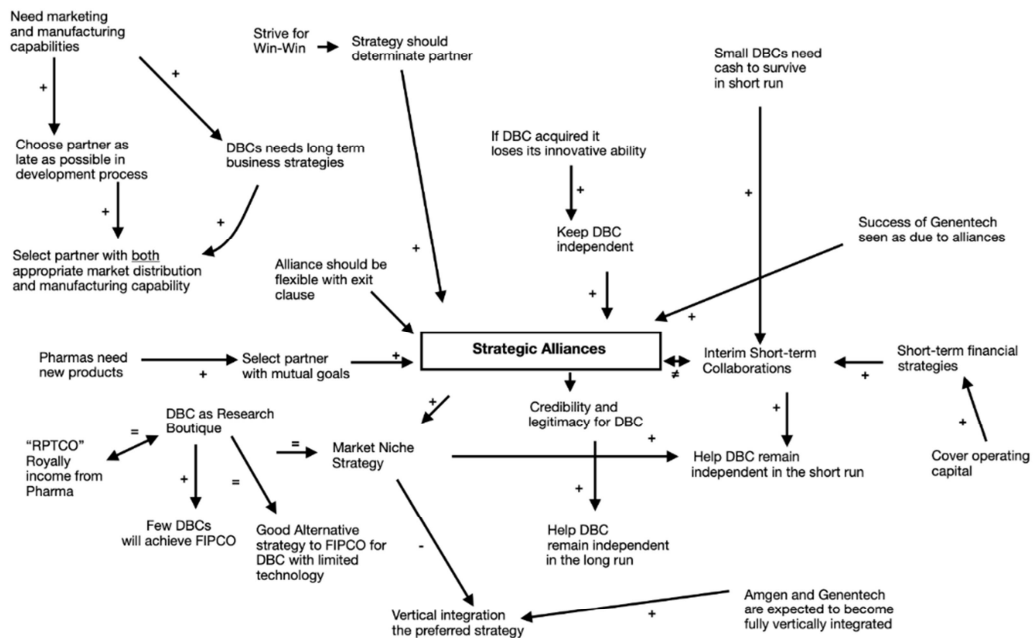

Figure B6. Biotech companies' cognitive map, 1991 (James, 1996).

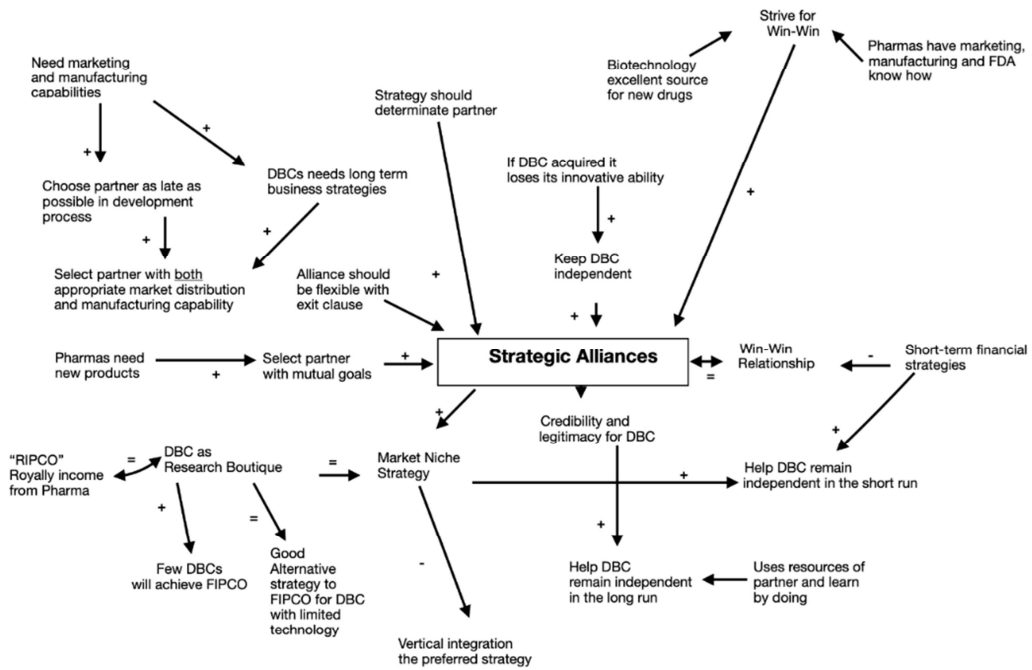

Figure B7. Biotech companies' cognitive map, 1992 (James, 1996).

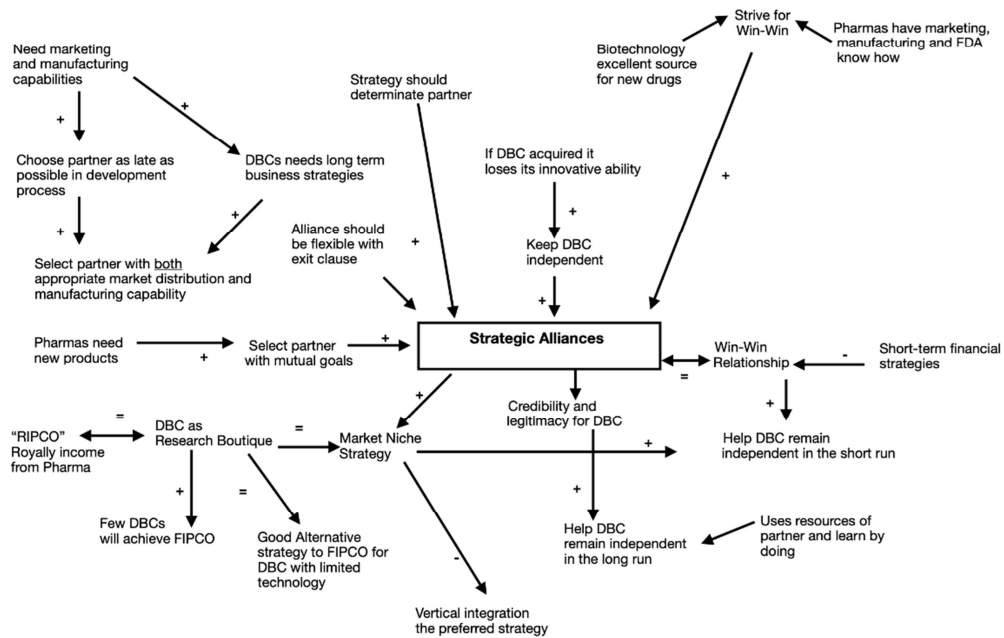

Figure B8. Biotech companies' cognitive map, 1993 (James, 1996).

## Appendix C: Machine Learning

The last 10 years witnessed a rapid development in Natural Language Processing (NLP), which uses Machine Learning (ML) algorithms to allow computers to process and “understand” text semantics (Ruder, 2022). As a result, ML algorithms have surpassed human performance on a number of NLP tasks such as aspects of speech tagging or question and answering (Stanford NLP Group, 2022).

These developments build on previous advances in knowledge representation, which historically had been one of the key purposes of “good old fashioned” Artificial Intelligence (AI) with the aim of building general or domain-specific cognitive maps.

Cognitive maps can be built from texts to represent knowledge in terms of relations between entities. Once knowledge has been represented as a cognitive map, the graph can be traversed to draw relevant conclusions such as, e.g., whether *WhatsApp* belongs to *Facebook* or *Joe Biden* is the *President of the United States*. However, we focus on the graph structure instead of its traversal. Since 2019 there has been a revival of the attempt to combine statistical models that extract the meaning of texts with automatic knowledge representation in the form of graph neural networks (Zhang *et al.*, 2020).

We implement machine generation of cognitive maps from text through a pipeline composed by seven main steps, as illustrated in Figure C1. The first step is pre-processing. The second step is concept recognition, which focuses on identifying the concepts which will be connected in the cognitive map. The third and last step is relational identification, where the linkages are determined.

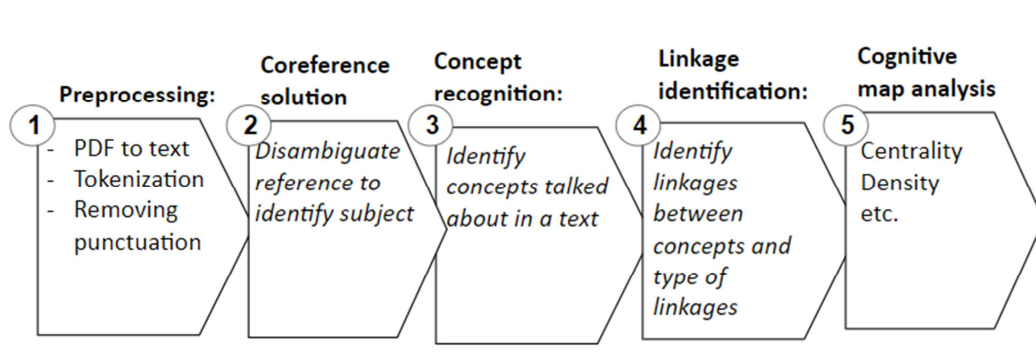

Figure C1. The pipeline for automatically generating cognitive maps from texts.



### *Step 1: pre-processing.*

First of all the original source is converted into a raw text file, which is then split into individual sentences and tokenized. Tokenization involves splitting up the entities of a sentence, words and punctuation into individual components. In our case, these components are embedded as vectors and punctuation is removed. Using word embeddings is a typical process in natural language processing, where each word is represented as e.g. a 124 dimensional vector in a latent space (Mikolov *et al.*, 2013). The vector represents the meaning of the word. The advantage of such word embedding is that words such as *Cappuccino* and *Latte Macchiato*, for example, are related in their meaning (cosine distance between their embedding vectors), when such relatedness cannot be recognized by a computer from their surface form (i.e., the letters of the words).

### *Step 2: Coreference solution.*

Next the problem of co-reference is addressed, which is the task of finding all the expressions that refer to the same entity in the text (Clark and Manning, 2016). For instance, pronouns must be substituted by the nouns they refer to: “X is a public company. It made a loss in 2021” becomes “X is a public company. X made a loss in 2021”. This task is achieved by a neural network which has been trained on a dataset where coreference has been resolved by human annotators.

### *Step 3: Concept recognition.*

In order to recognize concepts, a machine must be trained on a meaningful network of concepts. In this step the concepts talked about in the text are matched to concepts covered on Wikipedia. We take a neural network pretrained on 6.4 million concepts entailed in Wikipedia (Brank, Leban and Grobelnik, 2017). Whilst not every concept a CEO could talk about might be entailed in Wikipedia, the concepts described on Wikipedia are generally regarded as a reasonable baseline. The ground truth on which the model is trained is again a dataset of texts where human annotators have classified which concept on Wikipedia they are related to.

### *Step 4: Linkage extraction*

Once the concepts have been identified, the linkages between them must be identified. The algorithm needs to identify what concept is related to another concept according to the text and how they are related. For this purpose, we take a pre-trained model. The BERT

transformer is currently the model with the highest accuracy (Devlin *et al.*, 2019) for this task.

#### *Step 5: Cognitive map analysis*

Having established the cognitive map, we need to be able to systematically measure how it changes over time or between companies in order to detect the effects of non- probabilistic uncertainty. One way of doing so is to measure the number of concepts and linkages in a text. However, the number of concepts and linkages dependent on the length of the text. A ratio of the number of links per concept can normalize for differences in the length of the text.

If cognitive maps are disrupted, the connectedness of concepts should change. Such change can be measured in two metrics. The first one is the cognitive map density, which is the ratio of the number of linkages in the network to the maximum number of possible - linkages:

$$Density = \frac{|L|}{|L|_{max}}$$

where  $|L|$  denotes the number of linkages. The maximum number of linkages for a directed graph is defined as follows:

$$|L|_{max} = \frac{|C| * (|C| - 1)}{2}$$

where  $C$  is the set of concepts and  $|C|$  denotes the number of concepts.

Another way in which the evolution of cognitive maps can be measured over time is in terms of closeness centrality, which is the average distance of a concept to all other concepts. It is measured as the number of linkages one needs to travel to reach any other concept:

$$\bar{U} = \frac{|C| - 1}{\sum_{C_i} \sum_{C_j \in \{C - C_i\}} dist(C_i, C_j)}$$

## References

- Alipour, M., Hafezi, R., Amer, M. and A.N. Akhavan, 2017, "A new hybrid fuzzy cognitive map-based scenario planning approach for Iran's oil production pathways in the post-sanction period". *Energy*, 135, 851-864.
- Altmann, P., 2016, "When Shared Frames Become Contested: Environmental dynamism and capability (re)configuration as a trigger of organizational framing contests". In K.J. Sund, R.J. Galavan and A. Sigismund Huff (Eds.), *Uncertainty and Strategic Decision Making*, pp. 33-56. Howard House (UK), Emerald Group Publishing Limited.
- Amer, M., Jetter, A. and T. Daim, 2011, "Development of fuzzy cognitive map (FCM)-based scenarios for wind energy". *International Journal for Energy Sector Management*, 5, 564-584.
- Atkin, R.H., 1974, *Mathematical Structure in Human Affairs*. New York: Crane, Russak & Company.
- Axelrod, R., 1976, *Structure of Decision*. Princeton: Princeton University Press.
- Axelrod, R., 1984, *The Evolution of Cooperation*. New York: Basic Books.
- Battiston, F., Cencetti, G., Iacopini, I., Latora, V., Lucas, M., Patania, A., Young, J.G. and Petri, G., 2020, "Networks Beyond Pairwise Interactions: Structure and dynamics". *Physics Reports*, 874, 1-92.
- Beckert, J., and R. Bronk, Eds., 2018, *Uncertain Futures: Imagineries, Narratives, and Calculation in the Economy*. Oxford, Oxford University Press.
- Bion, W.R., 1961, *Experiences in Groups*. London, Tavistock Publications.
- Brank, J., Leban, G. and Grobelnik, M., 2017, Annotating Documents with Relevant Wikipedia Concepts. *Proceedings of the Slovenian Conference on Data Mining and Data Warehouses (SiKDD 2017)*, Ljubljana, Slovenia, 9 October 2017.
- Bryan, K.A., Ryall, M.D. and B.C. Schipper, 2021, "Value Capture in the Face of Known and Unknown Unknowns". *Strategy Science*, published online in *Articles in Advance* on August 2<sup>nd</sup>.
- Chermack, T.J., 2004, "Improving decision-making with scenario planning". *Futures*, 295-309.
- Clark, K.C., and Manning, C.D., 2016, Deep Reinforcement Learning for Mention-Ranking Coreference Models. Working Paper arXiv:1609.08667.
- Cowan, N., 2000, "The Magical Number 4 in Short-Term Memory: A reconsideration of mental storage capacity". *Behavioral and Brain Sciences*, 24, 87-185.

- Davidson, P., 1991, "Is probability theory relevant for uncertainty? A post-keynesian perspective". *Journal of Economic Perspectives*, 5, 129-143.
- De Finetti, B., 1931, "Sul significato soggettivo della probabilità". *Fundamenta Mathematicae*, 17: 298-329.
- Devlin, J., Chang, M.W., Lee, K. and Toutanova, K., 2019, "BERT: Pre-training of Deep Bidirectional Transformers for Language Understanding". Working Paper [arXiv:1810.04805](https://arxiv.org/abs/1810.04805).
- Dunbar, R.I.M., Duncan, N.D.C., and D. Nettle, 1995, "Size and Structure of Freely Forming Conversational Groups". *Human Nature*, 6, 67-78.
- Dunbar, R.I.M., 1998, The Social Brain Hypothesis. *Evolutionary Anthropology*, 178-190.
- Dunn, S.P., 2001, "Bounded rationality is not fundamental uncertainty: A post-keynesian perspective". *Journal of Post Keynesian Economics*, 23, 567-587.
- Eden, C., Ackermann, F. and S. Cropper, 1992, "The Analysis of Cause Maps". *Journal of Management Studies*, 29, 309-324.
- Eder, G., Duckstein, L. and H.P. Nachtnebel, 1997, "Ranking Water Resource Projects and Evaluating Criteria by Multicriterion Q-Analysis: An Austrian Case Study". *Journal of Multi-Criteria Decision Analysis*, 6, 259-271.
- Eliaz, K. and E.A. Ok, 2006, "Indifference or indecisiveness? Choice-theoretic foundations of incomplete preferences". *Games and Economic Behavior*, 56, 61-86.
- Ellsberg, D., 1961, "Risk, ambiguity and the Savage axioms". *The Quarterly Journal of Economics*, 75: 643-669.
- Erdmann, D., Sichel, B. and L. Yeung, 2015, "Overcoming obstacles to effective scenario planning". *Mc Kinsey & Company, Strategy & Corporate Finance Insights*, Jun.
- Faulkner, P., Feduzi, A. and J. Runde, 2017, "Unknowns, black swans, and the risk / uncertainty distinction". *Cambridge Journal of Economics*, 41, 1279-1302.
- Feduzi, A., and J. Runde, 2014, "Uncovering Unknown Unknowns: Towards a Baconian approach to management decision-making". *Organizational Behavior and Human Decision Processes*, 124, 268-283.
- Fioretti, G., 2001, "A Subjective Measure of Complexity". *Advances in Complex Systems*, 4, 349-370.
- Fioretti, G., 2009, "Evidence Theory as a Procedure for Handling Novel Events". *Metroeconomica*, 60, 283-301.

- Forrester, J., Cook, B., Bracken, L., Cinderby, S. and A. Donaldson, 2015, "Combining Participatory Mapping with Q-Methodology to Map Stakeholder Perceptions of Complex Environmental Problems". *Applied Geography*, 56, 199-208.
- Galaabaatar, T. and E. Karni, 2013, "Subjective expected utility with incomplete preferences". *Econometrica*, 81, 255-284.
- Gigerenzer, G., and P.M. Todd, 1999, *Simple Heuristics that Make Us Smart*. New York, Oxford University Press.
- Gilboa, I., 1987, "Expected utility with purely subjective non-additive probabilities". *Journal of Mathematical Economics*, 16: 65-88.
- Goodier, C., Austin, S., Soetanto, R. and A. Dainty, 2010, "Causal mapping and scenario building with multiple organizations". *Futures*, 42, 219-229.
- Goodwin, P. and G. Wright, 2001, "Enhancing strategy evaluation in scenario planning: A role for decision analysis". *Journal of Management Studies*, 38, 1-16.
- Heifetz, A., Meier, M. and B.C. Schipper, 2006, "Interactive Unawareness". *Journal of Economic Theory*, 130: 78-94.
- Heifetz, A., Meier, M. and B.C. Schipper, 2013a, "Dynamic Unawareness and Rationalizable Behavior". *Games and Economic Behavior*, 81: 50-68.
- Heifetz, A., Meier, M. and B.C. Schipper, 2013b, "Unawareness, Beliefs, and Speculative Trade". *Games and Economic Behavior*, 77: 100-121.
- Hobsbawm, E. and T. Ranger, 2012, "The Invention of Tradition". Cambridge: Cambridge University Press.
- Holyoak, K.J. and D. Simon, 1999, "Bidirectional Reasoning in Decision Making by Constraint Satisfaction". *Journal of Experimental Psychology: General*, 128, 3-31.
- Irtaza Raza, S., 2019, "Text Mined Knowledge Graphs: Beyond Text Mining". Vaticle, April 21<sup>st</sup>. Available at <https://blog.vaticle.com/text-mined-knowledge-graphs-beyond-text-mining-1ff207a7d850>.
- James, G.E., 1996, *Strategic Alliances: Elixirs, Poison Pills or Virtual Integration? A Longitudinal Exploration of Industry-Level Learning in Biotech*. University of Colorado at Boulder, Graduate School of Business, PhD Thesis.
- James, J., 1951, "A Preliminary Study of the Size Determinant in Small Group Interaction". *American Sociological Review*, 474-477.
- Jetter, A. and W. Schweinfort, 2011, "Building scenarios with fuzzy cognitive maps: An exploratory study of solar energy". *Futures*, 43, 52-66.

- Kay, J. and M. King, 2020, *Radical Uncertainty: Decision-making beyond the numbers*. New York: W.W. Norton & Company.
- Kazakova, T.V., and D. Geiger, 2016, "The Complexity of Simple Rules in Strategic Decision Making: Toward an understanding of organizational heuristics". In K.J. Sund, R.J. Galavan and A. Sigismund Huff (Eds.), *Uncertainty and Strategic Decision Making*, pp. 127-146. Howard House (UK), Emerald Group Publishing Limited.
- Knight, F.H., 1921, *Risk, Uncertainty and Profit*. Boston: Houghton Mifflin Company.
- Lane, D.A. and R.R. Maxfield, 2005, "Ontological uncertainty and innovation". *Journal of Evolutionary Economics*, 15, 3-50.
- Legrand, J., 2002, "How far can Q-Analysis go into social systems understanding?" Paper presented at the Fifth European Systems Science Congress. Available at <https://citeseerx.ist.psu.edu/viewdoc/download?doi=10.1.1.200.6000&rep=rep1&type=pdf>. Retrieved on July 20<sup>th</sup>, 2022.
- Locke, K., Golden-Biddle, K., and M.S. Feldman, 2008, "Making Doubt Generative: Rethinking the role of doubt in the research process". *Organization Science*, 19, 907-918.
- March, J.G. and J.P. Olsen, 1976, "Organizational Learning and the Ambiguity of the Past" pp. 54-68. In J.G. March and J.P. Olsen, *Ambiguity and Choice in Organizations*. Bergen, Universitetsforlaget.
- March, J.G. and H.A. Simon, 1958, *Organizations*. New York: John Wiley & Sons.
- Mikolov, T., Chen, K., Corrado, G. and J. Dean, 2013, "Efficient Estimation of Word Representation in Vector Space". Working Paper arXiv: 1301.3781. Available at <https://arxiv.org/abs/1301.3781?context=cs.CL>.
- Miller, G.A., 1956, "The Magical Number Seven, Plus or Minus Two: Some limits on our capacity for processing information". *The Psychological Review*, 63, 81-97.
- Ok, E.A., Ortoleva, P. and G. Riella, 2012, "Incomplete preferences under uncertainty: Indecisiveness in beliefs versus tastes". *Econometrica*, 80, 1791-1808.
- Ramírez, R., Österman, R., and D. Grönquist, 2013, "Scenarios and early warnings as dynamic capabilities to frame managerial attention". *Technological Forecasting & Social Change*, 80, 825-838.
- Ramírez, R. and C. Selin, 2014, "Plausibility and probability in scenario planning". *Foresight*, 16, 54-74.
- Rodrigues, D.M.S., 2014, "Q-Analysis Based Clustering of Online News". *Discontinuity, Nonlinearity, and Complexity*, 3, 227-236.

- Roxburgh, C., 2009, "The use and abuse of scenarios". Mc Kinsey & Company, Strategy & Corporate Finance Insights, Nov.
- Rucco, M., Sousa-Rodrigues, D., Merelli, E., Johnson, J.H., Falsetti, L., Nitti, C. and A. Salvi, 2015, "Neural Hypernetwork Approach for Pulmonary Embolism Diagnosis". BMC Research Notes, 8: 617.
- Ruder, S., 2022, "NLP-progress". Retrievable at <http://nlpprogress.com>. Accessed on Jan 8<sup>th</sup>, 2022.
- Rumsfeld, D.H., 2011, Known and Unknown: A memoir. New York, Sentinel.
- Runde, J., 1990, "Keynesian Uncertainty and the Weight of Arguments". Economics and Philosophy, 6, 275-292.
- Schmeidler, D., 1989, "Subjective probability and expected utility without additivity". Econometrica, 57: 571-587.
- Schoemaker, P.J.H., 1995, "Scenario Planning: A tool for strategic thinking". Sloan Management Review, 36: 25-40.
- Shafer, G.R., 1976, A Mathematical Theory of Evidence. Princeton, Princeton University Press.
- Sigismund Huff, A., 1990, Mapping Strategic Thought. Chichester: John Wiley & Sons.
- Sigismund Huff, A., Huff, J.O. and P.S. Barr, 2000, When Firms Change Direction. Oxford: Oxford University Press.
- Sigismund Huff, A. and M. Jenkins, 2002, Mapping Strategic Knowledge. London: Sage Publications.
- Stanford NLP Group, 2022, "SQuAD 2.0: The Stanford Question Answering Dataset". Retrievable at <https://rajpurkar.github.io/SQuAD-explorer>. Accessed on Jan 8<sup>th</sup>, 2022.
- Steiner Sætre, A., and A. Van de Ven, 2021, "Generating Theory by Abduction". Academy of Management Review, 46, 684-701.
- Stewart, A.J., and J.B. Plotkin, 2013, "From Extortion to Generosity, Evolution in the Iterated Prisoner's Dilemma". Proceedings of the National Academy of Sciences, 110, 15348-15353.
- Stirling, A., 2010, "Keep it Complex". Nature, 468, 1029-1031.
- Thagard, P., 1989, "Explanatory Coherence". Behavioral and Brain Sciences, 12, 435-502.
- Van der Heijden, K., 2000, "Scenarios and forecasting: Two perspectives". Technological Forecasting & Social Change, 65: 31-36.
- Weick, K.E., 1979, The Social Psychology of Organizing. New York, Random House.
- Weick, K.E., 1995, Sensemaking in Organizations. Thousand Oaks, Sage Publications.

- Wilson, I., 2000, "From scenario thinking to strategic action". *Technological Forecasting and Social Change*, 65, 23-29.
- Wright, G. and P. Goodwin, 2009, "Decision making and planning under low levels of predictability: Enhancing the scenario method". *International Journal of Forecasting*, 25, 813-825.
- Zahavi, Y., 1977, "Equilibrium Between Travel Demand System Supply and Urban Structure", in E.J. Visser (Ed.), *Transport Decisions in an Age of Uncertainty*. Dordrecht, Springer.
- Zhang, Z., Zhuang, F., Zhu, H., Shi, Z., Xiong, H., and He, Q., 2020, "Relational Graph Neural Network with Hierarchical Attention for Knowledge Graph Completion". *Proceedings of the AAAI Conference on Artificial Intelligence*, 34, 9612-9619. Retrievable at <https://doi.org/10.1609/aaai.v34i05.6508>.