

CFU Playground: Full-Stack Open-Source Framework for Tiny Machine Learning (tinyML) Acceleration on FPGAs

Shvetank Prakash* Tim Callahan[†] Joseph Bushagour[§] Colby Banbury*
 Alan V. Green[†] Pete Warden[†] Tim Ansell[†] Vijay Janapa Reddi*
[†]Google [§]Purdue University *Harvard University

Abstract

We present CFU Playground, a full-stack open-source framework that enables rapid and iterative design of machine learning (ML) accelerators for embedded ML systems. Our toolchain tightly integrates open-source software, RTL generators, and FPGA tools for synthesis, place, and route. This full-stack development framework gives engineers access to explore bespoke architectures that are customized and co-optimized for embedded ML. The rapid, deploy-profile-optimization feedback loop lets ML hardware and software developers achieve significant returns out of a relatively small investment in customization. Using CFU Playground’s design loop, we show substantial speedups (55×-75×) and design space exploration between the CPU and accelerator.

1 Introduction

Running machine learning (ML) on embedded edge devices, as opposed to in the cloud, is gaining increased attention for multiple reasons such as privacy, latency, security, and accessibility [26]. Given the need for energy efficiency when running ML on these embedded platforms, custom processor support and hardware accelerators for such systems could present the needed solutions.

However, the field of ML is still in its infancy and fast-changing. Thus, it is desirable to avoid a massive non-recurring engineering (NRE) cost upfront, especially for low-cost embedded ML systems. Building ASICs is both costly and time-consuming. Moreover, since embedded systems are often task-specific, there is an opportunity to avoid general-purpose ML accelerators and instead explore task and model-specific ML acceleration methods. This setting presents the need for an agile design space exploration tool that allows us to adapt to the changing landscape of ML and hardware accelerators.

In this paper, we present CFU Playground,¹ a full-stack open-source framework for iteratively (deploy→profile→optimize) exploring the design space of lightweight accelerators in an agile manner (Figure 1). The framework can be used to design custom function units (CFUs) for distinct ML operations. CFUs represent a novel design space that balances acceleration with flexibility and reduces the overhead associated with discrete accelerators. The full-stack solution presented with our hardware-in-the-loop evaluation process not only works out-of-the-box, but also accounts for end-to-end bottlenecks that may arise elsewhere in the computing stack but are often ignored when designing in isolation. From an initial working, non-customized solution, the user can incrementally specialize individual components to improve the performance

¹Source code for CFU Playground is available at <https://anonymous.4open.science/r/CFU-Playground-BFB2>. It is maintained by XXX, publicly available and downloadable.

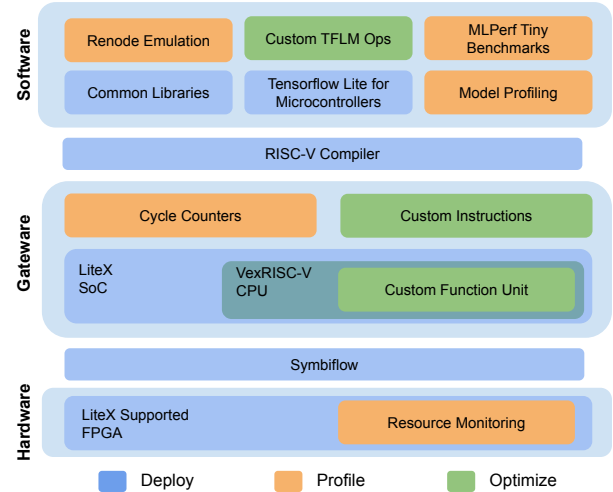

Figure 1: CFU Playground allows users to design and evaluate model-specific ML enhancements to a “soft” CPU core.

of their application. Due to the lightweight nature of CFUs, one can develop quickly and make changes as compilation and deployment to an FPGA targeting embedded ML takes under six minutes.

Our framework’s open-source toolchain bundles together open-source software (TensorFlow Lite Micro, GCC), open-source RTL generation IP and toolkits (LiteX, VexRiscv, Migen, nMigen), and open-source FPGA tools for synthesis, place, and route (yosys, nextpnr, vpr, etc.). By using open source for the entire stack, we give the user access to customize and co-optimize hardware and software, resulting in a specialized solution unencumbered by potential licensing restrictions and not tied to a particular FPGA, board, or vendor. This rapid, lightweight framework lets the user achieve large returns out of a relatively small investment in customized hardware and is particularly useful for the long tail of low-volume applications, which emerge in embedded ML use cases.

We use the framework to demonstrate how to design CFUs, extending an FPGA-based RISC-V core. The primary reason CFUs are suitable for ML inference is that there are often a few small yet critical hotspots. A small amount of custom hardware that exploits the bit-level flexibility of an FPGA can help accelerate large portions of execution time. A tightly integrated CFU allows us to leave complexity, setup, and outer loops in the software while efficiently tackling the core computational bottlenecks in the datapath. Moreover, as we demonstrate, CFUs allow us to incrementally grow the unit until it almost becomes a full-blown ML accelerator.

Using our agile CFU design flow, we were able to accelerate the convolution operation of MobileNetV2 via a combination of

optimizations such as loop unrolling, SIMD multiply-accumulate, and pipelining to obtain a 55× speedup over five weeks by a senior engineer only working part-time on the project. Additionally, with a Keyword Spotting application, we demonstrate how, due to the nature of the RISC-V soft CPU, the core can not only be extended (new instructions added through the use of a CFU) but also tailored (e.g. cache sizes modified) to meet the platform’s constraints given limited resources. This also enables the user to perform a design space exploration between resources allocated to the CFU, CPU, or memory system. Exploitation of this ability along with strategic use of parallelism and pipelining led to a cumulative speedup of 75× under four weeks by an undergraduate-level intern with minimal FPGA and hardware experience, owing to the various abstraction layers. Lastly, we show that the framework enables exploration of bespoke architectures for the growing field of Tiny Machine Learning (tinyML) given the unique architectural niche of CFUs.

In summary, our contributions within this paper are as follows:

- An out-of-the-box, full-stack framework that fully integrates open-source tools across the entire stack to facilitate rich community-driven ecosystem development.
- An agile methodology for developers to progressively and iteratively design tightly-coupled, bespoke accelerators for resource-constrained, latency-bound tinyML applications.
- Through cross-stack insights, enabled by a fully open-source stack, we demonstrate novel model-specific resource allocation trade-offs between the CFU, CPU, and memory system that enable optimal ML performance on resource-constrained FPGA platforms for two important use cases.

2 Background & Motivation

ML acceleration on microcontroller-class hardware is a new area, so we motivate the need for agile hardware customization for tinyML.

2.1 Hardware Customization on FPGAs

The opportunity exists with an FPGA platform to customize the processor to adapt it to perform the application’s computation efficiently. In particular, ML computations tend to be regular and repetitive, the same sequence of operations repeated millions of times. We can focus on improving the execution of this “hot” computation while using standard instructions to perform the rest. A small amount of custom hardware for these hotspots that exploit the bit-level flexibility of FPGAs can translate to large improvements.

A custom function unit (CFU) can improve upon standard execution in many ways. A CFU can specialize operations for constant operands, perform multiple operations per cycle through parallel computation of independent operations, perform a fusion of successive operations within a cycle, or pipeline the computations across multiple cycles. Flexible, configurable storage allows data to be stored and reused locally. We can add and perform a combination of these *iteratively* to progressively improve performance.

An FPGA platform also allows for an accelerator unit to be tightly coupled into the CPU pipeline that can be easily invoked by adding new custom instructions that complement the CPU’s standard functions. It is an alternative to treating ML accelerators as discrete processing units, which suffer from “AI Tax” [3, 16].

Along with the ease of programming, tight coupling is beneficial for latency-bound applications [9] as needed for tinyML [2].

Furthermore, the bit-level flexibility of FPGAs allows efficient implementation of operations on small data sizes and non-standard data representations, and even just packing, unpacking, and converting between different data types. As such, FPGAs open up the complex design space exploration for customized microarchitectures that extend beyond the ML accelerator and include the CPU.

2.2 Agile Full-Stack Design Flows

Hardware customization is an iterative process, especially for ML development in which the model itself typically undergoes refinement. For example, there is often a back and forth between the ML team and the processor implementation team—“what if we quantize this layer to 4b?”—to achieve a solution that meets both the performance goals, as well as the embedded system’s resource constraints.

While simulators are useful and good for functional correctness, getting accurate performance estimates is difficult. Modeling all features of a system (e.g. multiple clocks, asynchronous interfaces, mixes of memories with different bandwidth and latency, etc.) accurately can result in a slow simulation also. When running with hardware-in-the-loop, users know that measurements collected are not overlooking a key performance factor.

Moreover, if one is successful speeding up computation, the system often becomes memory or I/O limited. Therefore, modeling and evaluating the ML accelerator’s performance from a full-stack system perspective is also important. Modeling bus latencies including contention and arbitration is inexact at best using simulators. Full-system cycle-accurate simulations are too slow for agile design.

3 CFU Playground

As shown in Figure 1, CFU Playground is a collection of software, gateway, and hardware pieces which we describe in detail here.

3.1 Gateway

CFU Playground runs a complete System-on-Chip (SoC) on an FPGA to capture the full-stack system effects of accelerating ML models. See Figure 2. Its gateway is built upon the LiteX framework [11]. LiteX provides a convenient and efficient infrastructure to create FPGA soft cores and SoCs. For any board to be used in CFU Playground, it must first have a LiteX description. Most popular commercially-available boards already have a description in the crowd-sourced LiteX boards library [12]. For a private prototype board, the description can be created and maintained locally.

The soft core used in CFU Playground is VexRiscv, an implementation of a RISC-V CPU in SpinalHDL [15]. The design of the VexRiscv is highly configurable, providing the ability to easily plugin or remove many different features for performance and functionality such as pipelining stages, caches, and floating point units. This customization ability lends itself well to enabling the design space exploration of CPU vs. CFU. Currently VexRiscv is the only soft CPU that supports the specific CFU interface used. Future work aims to add the CFU interface to other soft CPUs. Nonetheless, this still gives us a wide array of VexRiscv designs to explore [15].

The CFU is a small piece of custom logic added in hardware to extend the CPU’s datapath to accelerate a discrete function determined by the developer. It follows the RISC-V R-format in which it

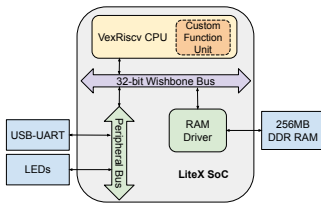

Figure 2: LiteX SoC.

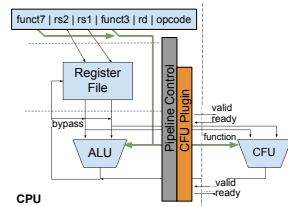

Figure 3: Custom Func. Unit.

receives two operands from the register file and writes one result back. A CFU can support state, multiple custom instructions, and pipelining. Figure 3 depicts the architecture of the CFU in relation to the rest of the CPU. A notable feature of this architecture is that the CFU does not have direct memory access. It relies on the CPU to move data back and forth. The merits of a direct CFU-memory connection are being considered and may be added in the future.

The boundary between CPU and CFU is strictly logical. The implementation flattens the design and optimizes, places, and routes it all together. The Verilog is compiled to a bitstream by an FPGA toolchain, either open sourced (e.g. SymbiFlow [20] or yosys/nextpnr [17]) or vendor-supplied.

3.2 Hardware

The gateway for CFU Playground is adaptable to a wide range of FPGA hardware platforms. It can fit on a board as small as Fomu [10], which is 1 cm^2 and fits entirely within a USB port. But when more resources are available, a larger more powerful soft CPU and CFU can be built, and with more memory, larger models can be run.

The minimum requirements for the board and its FPGA include the following. There must be some means of creating a TTY / UART connection to interact with the software on the board. The FPGA must have enough resources to build variations of VexRiscv CPU cores. The system must have enough RAM (either on the FPGA, or externally on the board) to provide working memory for the software. There must be sufficient RAM and/or ROM to hold the code and any constant data such as the TensorFlow Lite model.

We currently support the Xilinx 7-Series as well as the Lattice iCE40, ECP5, and CrossLink FPGAs. The Fomu with the iCE40UP5k FPGA is close to the smallest usable board; it features 5280 logic cells, 128kB on-chip large RAM, 30 512-byte block RAMs, and 8 16b x 16b DSP/multiplier blocks and is small enough to slot into a USB.

3.3 Software

To invoke the CFU, custom instructions must be added to the CPU's instruction set. However, it is not the compiler's responsibility to find uses for the instructions. It only needs to generate them when requested by the user. Therefore, we can use a stock RISC-V GCC toolchain, coupled with a macro we provide that expands to "asm" directives to generate the encoded custom instructions where necessary. The macro takes 4 arguments, and returns one result:

```
q = cfu_op(func7, funct3, a, b);
```

The macro directly generates the encoded 32b value, so not even the assembler needs modification. "func7" and "funct3" are 7-bit and 3-bit fields respectively that specify the opcode of the custom instruction. They must be compile-time constant expressions. "a" and "b" are the C/C++ 32b integer variables used as operands for the

instruction, and a 32b result is returned. The macro gets information from the compiler regarding the register locations of operands and result (a, b, and q in this example) to generate the correct bit fields for register sources and destination in the encoded instruction, so extra register-to-register copies are not needed. For readability, the user may define a macro for each custom instruction, in terms of the base `cfu_op()` macro as shown below:

```
#define simd_add(a, b) cfu_op(1, 3, (a), (b))
```

It is the user's responsibility to call the custom operations in their code. The custom instruction macros can be intermixed with regular C code, similar to any other C/C++ operation. TensorFlow Lite for Microcontrollers (TFLite Micro) [5] is the inference framework that CFU Playground uses for the deployment of the neural network. The user must provide an optimized kernel that uses the new custom instructions to realize the runtime performance improvements.

3.4 Testing, Simulation, and Debugging

The menu-driven software contains kernel-level unit tests from the TFLite Micro library. It also contains full-inference golden tests, with set inputs and expected outputs for each provided model. CFU Playground comes packaged with stock models from MLPerf Tiny deep learning workloads for benchmarking [2]. Additional models can be added as desired, as we also demonstrate in the evaluation.

To support debugging and testing, users write a software emulation of their CFU, using C, that is functionally equivalent but of course much slower, which can be swapped in for the real CFU.

The application running on the FPGA board has access to `printf()` and terminal output, so printing variable values during execution can be done as an alternative debugging method. Some boards support a debug bridge to connect a debugger to the running system. In this case, a debug-enabled VexRiscv variant must be used.

CFU Playground also supports the Renode emulator [1], which emulates the physical hardware system. While following a hardware-in-the-loop process and running on a physical board is recommended by CFU Playground, a Renode emulation can be used to test CFUs on other boards without having them. Renode performs ISA simulation of the CPU, combined with cycle-accurate Verilog simulation of the CFU. It also simulates the RAM, ROM, and UART. The Renode emulator also allows us to capture the waveforms from the CFU operation, which is extremely useful for tracking down errors in the hardware design of the CFU.

4 Evaluation

CFU Playground enables a `deploy`→`profile`→`optimize` loop that enables iterative, guided optimization of resource-constrained ML systems (Figure 4). The toolchain allows a developer to quickly focus their design effort at any layer of the stack, measure its performance at a fine granularity, implement custom optimizations, and repeat. Figure 4 highlights components of CFU Playground from Figure 1 that fulfill a role in the design cycle across the deployment stack: Software, Gateway, and Hardware. An FPGA platform is assumed to be the final deployment, although this process could also be considered to be a prototyping step for ASIC deployment, in which case the last few cycles of performance and power optimization would include the target ASIC implementation flow.

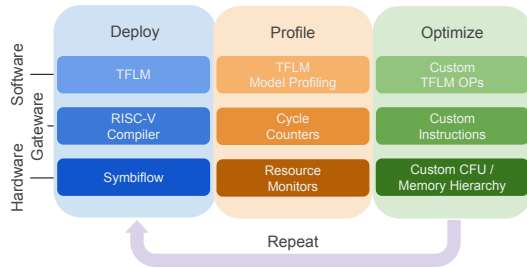

Figure 4: The developer workflow of CFU Playground.

We show the iterative development methodology using two common tinyML use cases: image classification (IC) and keyword spotting (KWS). The IC example allows us to showcase how CFU Playground allows iterative developer improvements with ease. The KWS example shows how we can easily co-optimize the CPU and the CFU together in severely resource-constrained environments. We focus on performance but the methods can also extend to energy.

4.1 Image Classification Acceleration on Arty

Image classification is a common task for low-power, always-on cameras, such as those in a smart doorbell. We present the experience of one of the authors, with limited prior hardware development experience, utilizing the CFU Playground deploy→profile→optimize loop, spending approximately 50% of their time over five weeks. They achieved a speedup of 55× for the most time-consuming TFLite operator in the model, bringing the contribution of that operator down from 5.5 seconds to 0.10 seconds per inference.

Deploy: For this study, we targeted a MobileNetV2 (MNV2) model, which is commonly used for efficient image classification, and optimized its performance on an Arty A7-35T board, which has a Xilinx XC7A35T FPGA with 256 MB of external DDR3 memory. The model was quantized down to 8-bit integers (int8) as this is what the inference framework used (TFLite Micro) supports.

Profile: Profiling of MNV2 on the Arty board showed that the unaccelerated baseline application takes about 900 M cycles. About 95% of its execution time is spread across three different types of convolutions: 1x1 2D Convolution (63%), Depthwise Convolution (22.5%), 3x3 2D Convolution (11%). Since most of the cycles were consumed by the CONV_2D 1x1 layers, our primary focus was on accelerating that particular operator. In the computation for a 1x1 convolution, for each x, y spatial coordinate, an input vector (the input tensor’s column at x, y with the length determined by the number of input channels) is multiplied by a matrix to produce an output vector (the output tensor’s column at x, y with length equal to the number of output channels). The matrix contains the filter weights, has size input channels \times output channels, and is the same for every x, y . Post-processing (applying bias, activation function, and requantization) is applied to each output element.

Optimizations: Figure 5 shows the speedup progression as we stepped through each of the optimizations. We start with software optimizations and move on to hardware support using the CFU. The CFU is implemented using nMigen [14], an open-source Python-based toolkit for RTL design, and it helps manage the complexity.

Software Optimizations and Specialization: We started by creating a new CONV_2D kernel *specialized* for the 1x1 case, that

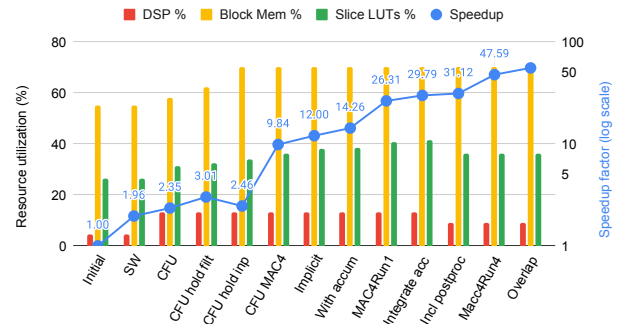

Figure 5: MobileNetV2— 1x1 CONV_2D speedup.

is, when filter_width and filter_height are both equal to 1. A check in the general kernel branches to the specialized kernel when this is the case. Then in the specialized kernel, filter_width and filter_height can be assumed to be 1, and we can remove two levels of looping as well as replace other uses of those parameters with constant 1. For example, a padding out-of-bounds check can be also be removed. These specializations in addition to other optimizations such as loop unrolling reduced the execution time by 49%, gaining almost a factor of 2.0× in performance (*SW specialize*).

CFU Optimizations: Our first custom instruction accelerated the post-processing of each output element. Figure 6 shows the CFU microarchitecture. Per-output channel values for bias, multiplicand, and shift amount were stored in the CFU. This saved approximately 55 cycles per output, bringing the speedup to 2.3× (*CFU postproc*).

Next, moving filter values into the CFU (using the CFU as a small scratchpad memory) resulted in a small speed improvement—approximately 2 cycles per multiply-accumulate (MAC) (*CFU hold filt*). However, moving input values into the CFU cost about 2 cycles per MAC. Since the CFU stores values by word instead of byte, the CPU must perform bit shifts and sign extensions to use values retrieved from the CFU. This canceled the speed up from reduced memory access and better data cache behavior (*CFU hold inp*).

However, the payoff came in the next major step when we built a 4x4 multiply-accumulate (MAC4) instruction that directly operates on the packed filter and input values retrieved from the CFU buffers. Even though the CPU is still involved in this data movement, the cumulative speedup reached 9.8× (*CFU MAC4*).

The next step was to change the MAC4 instruction to pull its input parameters directly from the previously constructed buffers and move the whole inner accumulation loop into the CFU. These changes got us down to less than one cycle per multiply-accumulate, a cumulative speedup of 26× (*MAC4Run1*). We then connected the accumulation result directly to post-processing in the CFU without CPU intervention to reach 31.1× speedup (*Incl postproc*).

Profiling the optimized version we have thus far showed that calculating and writing back 8b output channel values one at a time was not making efficient use of memory bandwidth, so we restructured the CFU to pack four of these outputs into a single 32b word for the CPU to write back to memory (*Macc4Run4*). Finally, we pipelined the CFU such that it could calculate while loading inputs, which hides the input loading overhead (*Overlap input*).

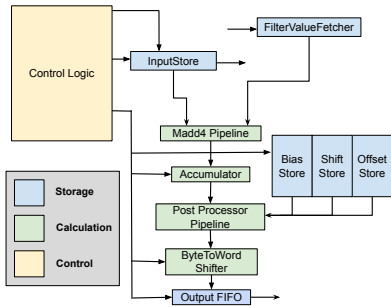

Figure 6: MNV2 CFU control logic and datapath design.

Overall, the MNV2-specialized design achieved a 55× speedup for 1x1 CONV_2D over the original implementation.² The final design is shown in Figure 7. It stores the filter weights and current input vector internally and an internal sequencer is used to compute a complete output column from an input column. This allows each value transferred into the CFU storage to be used repeatedly. Also, the input and output vectors are double-buffered: while one output vector is being computed, the previously computed output vector is being copied out, and the next input vector is being copied in.

Resource Usage: Throughout the iterative development, we were never close to running out of any FPGA resources (as we show in Figure 5). Resource usage peaked midway through development, when the different processing steps were individually implemented on the CFU. As the processing became more integrated on the CFU, pathways for moving values back and forth to the CPU were removed, resulting in a resource usage reduction.

4.2 Keyword Spotting Acceleration on Fomu

The Keyword Spotting (KWS) application is ubiquitous and an always-on embedded ML use case, making it a perfect candidate for acceleration. This example took under four weeks to implement. We describe how an author (different than in the previous example) utilized CFU Playground to accelerate quantized (int8) inference of the MLPerf Tiny [2] KWS model that included model-specific software optimizations and a custom CFU, by over 75×.

Deploy: We deployed the system to the tiny Fomu FPGA board, which is roughly the size of a penny and fits inside a USB slot. It combines an iCE40UP5k FPGA (with 5280 logic cells and 128 kB of on-chip RAM) with a 2 MB flash memory. This example demonstrates resource allocation optimization among the CPU, memory system, and CFU on a resource-constrained tinyML device.

Profile: The minimal VexRiscv configuration—without caches, hardware multiplication, branch prediction, or bypassing—does not fit on the Fomu. To squeeze VexRiscv onto the FPGA we needed to remove features from the LiteX SoC (such as the hardware timer and reset registers) and reallocate logic cell usage in the VexRiscv core by removing hardware error checking (e.g. for misaligned addresses). Iterative hardware multiplication was added for performance reasons, but not hardware division, which was instead handled by software emulation. These modifications were feasible due to the open source nature of VexRiscv and LiteX. Detailed knowledge

²For an overall speedup of this magnitude, we would also need to speed up the other significant operator types by a similar amount, which we have not yet implemented.

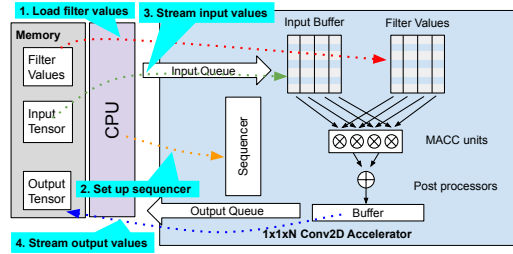

Figure 7: MNV2 input/output interface to the CFU.

of the CPU design was not required as all of these changes were performed simply by changing configuration options.

Also, the CFU Playground compiled binary image would not fit in 128kB, considering that much of this RAM is needed by TFLite Micro for working data. We modified the linker script to place the code (.text section) and read-only data (.rodata section—mostly weights from the ML models) into flash memory. The KWS application now finally fit but took 2.5 minutes to run. We now describe how we optimized it to run in 2 seconds.

Memory System Optimizations: Profiling showed that the flash ROM accesses were slower than they should be. This pointed to some potential improvements in the SPI flash interface. First, we upgraded the ROM interface from a Serial Peripheral Interface (SPI) to a Quad SPI, substantially improving the ROM read bandwidth, giving a 3.04× speedup over the baseline (*QuadSPI* in Figure 8).

Next, we moved critical sections from the ROM to the SRAM. Since SRAM capacity was severely limited (128kB) we selected the primary bottlenecks, determined via profiling. These included the code for CONV-2D, Depthwise-CONV-2D, and model weights. This optimization led to a total speedup of 7.84× (*SRAM Ops and Model*).

We then removed unnecessary control & status registers and SoC features intended for debugging to make space for a larger I-Cache that decreased the average instruction fetch time. This led to a cumulative performance speedup of 8.3× (*Larger Icache*).

CFU Optimizations: Owing to the previous resource savings, we now had room to add single-cycle multiplication, rather than use our iterative ~30 cycle multiplication in our CPU. This used four of Fomu’s eight DSP tiles and increased performance by 15.35× (*Fast Mult*). The savings also created room to add a 4-way parallel MAC CFU to address the convolution bottleneck (*MAC Conv*), which required the remaining four DSP tiles. Depthwise convolution was the second runtime contributor. It has a different memory access pattern and therefore could use the 4-way multiply-accumulate that we built for the convolution. Ideally, we could build separate CFU gateware for depthwise convolution, but there were no remaining resources to extend the CFU this way. Instead, we utilized a single lane of the 4-way multiply-accumulate CFU in depthwise convolution to achieve a cumulative speedup of 32.10×.

After implementing the SIMD MAC operation in the CFU, there were still logic cells remaining (although no DSP tiles were left). With these logic cells, extra functionality was added to the CFU to perform accumulator post-processing (consisting of saturating multiplication, rounding division, and output clamping) 14× faster deep inside the convolution and depthwise convolution operations, which led to a cumulative 37.64× speedup (*Post Proc*).

Software Optimizations: The convolution operators in TensorFlow Lite are quite generalized. Therefore, we inform the compiler

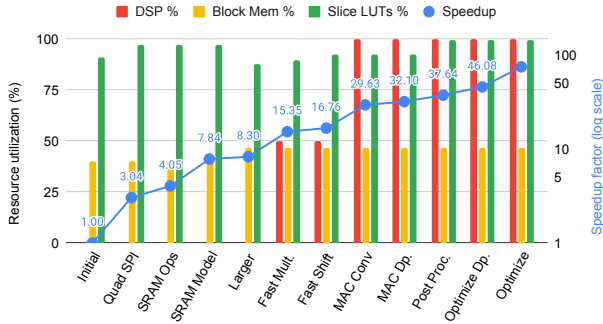

Figure 8: Speedup and resource usage for the KWS use case.

about constants and invariants (our `filter_width` is always 3, our `depth_multiplier` is always 1, etc.). This lets the compiler generate more efficient assembly, notably decreasing the number of branches (which are expensive because our microcontroller-class CPU does not have sufficient room for a branch predictor).

Summary: Overall, performance improved by a factor of 75 \times . The time for one inference reduced from 2.5 minutes to under 2 seconds on the FPGA. An ASIC implementation of the design would be an order of magnitude faster, but that is outside the scope of this work. Only 3 \times of the speedup was directly attributed to the small CFU. The other 25 \times was derived from optimizing the CPU configuration, software, memory accesses, and system interfaces & drivers. This illustrates the usefulness of CFU Playground’s `deploy`→`profile`→`optimize` loop running on a live system.

The final optimized Fomu KWS results, if normalized for the differing clock rates, are roughly comparable to the MLPerf Tiny results [2] for the much more complex Cortex-M4 with hand-optimized CMSIS-NN kernels utilizing the M4 SIMD instructions.

5 Related Work

Tightly coupled, specialized ISAs have been explored for accelerating DNNs using application-specific instruction-set processors (ASIPs) [13, 25]. These approaches developed fixed, domain-specific ISAs for more diverse and generalized DNN acceleration, in contrast to our extreme model-specific customization which is useful for embedded systems as they are often task-specific and less aimed at general-purpose computation. Also, the tools used for ASIP accelerators are often commercial [4, 21] and require costly ramp-up.

There have been other open-source workflows for accelerating embedded ML. Table 1 compares the features supported by some of the existing frameworks compared to CFU Playground but comprehensive and extensive surveys of existing flows can be found in the references [8, 19, 23]. The extent to which prior art supports end-to-end open-source development varies and that is where CFU Playground brings new value. It is extremely common to not tightly couple the accelerator with the CPU and most of the workflows follow this design pattern [6, 7, 22, 24, 27]. Due to this decoupling, most flows design the accelerators in isolation *before* integrating with the rest of the system and stack. This can cause a failure post-design due to the lack of accounting for effects that arise elsewhere in the computing stack or at the system level, such as the cost of offloading, scheduling, etc. Gemini uses an architectural template to generate efficient accelerators together with a software stack and integrated SoC to capture system-level effects and also discusses

	Open Source	Tightly Coupled/ Specialized ISA	Full Stack	Full SoC	Processor Customization	Discrete ML Ops	Stock Compiler	TinyML Focus
CFU Playground	✓	✓	✓	✓	✓	✓	✓	✓
Gemmini[7]	✓	x	✓	✓	✓	x	✓	x
hls4ml[6]	✓	x	x	✓	x	x	x	✓
DNNWeaver[18]	✓	✓	x	x	x	x	x	x
Deepburning[24]	✓	x	✓	x	x	x	x	x
DNNBuilder[27]	✓	x	x	x	x	x	x	x
FINN[22]	✓	x	x	x	x	x	x	x

Table 1: Comparison with other FPGA toolchains for ML.

design trade-offs between the accelerator and CPU [7]. However similar to the majority of accelerator workflows, it is designed to optimize and run the entire model in hardware. For example, hls4ml is a complete tool for deploying different models to FPGAs [6], but the accelerators are designed to speed up the entire model rather than individually selected operations or kernels. CFUs are designed to accelerate specific ML operations while supporting the rest of the system stack that would normally be deployed on-device. Finally, most design flows auto-generate hardware implementations of the accelerators using specialized compilers that are less flexible than CFU Playground’s use of RISC-V’s.

There is no “one size fits all” approach for designing custom ML accelerators. CFU Playground adds a dimension of flexibility on top of prior art, especially useful in resource-constrained embedded systems where discrete accelerators are not always feasible. The best choice of workflow is task-dependent and up to the developer.

6 Conclusion and Future Work

CFU Playground is a full-stack framework that exposes developers to a fast and iterative open-source design flow to obtain significant speedups by exploring the design space between the CPU and a tightly-coupled CFU. Future work involves studying the optimization space for power and energy efficiency. Given CFU Playground’s ability to quickly iterate through the `deploy`, `profile`, and `optimize` feedback loop, there is an opportunity to integrate CFU Playground into a closed-loop learning-based system that uses machine learning methods to optimize the system automatically.

References

- [1] Antmicro. 2018. Renode. <https://renode.io/>
- [2] C. Banbury, and others. 2021. MLPerf Tiny Benchmark. *arXiv* (2021).
- [3] M. Buch, and others. 2021. AI Tax in Mobile SoCs: End-to-end Performance Analysis of Machine Learning in Smartphones. In *2021 ISPASS*.
- [4] Cadence. 1997. Tensilica Processor IP. https://www.cadence.com/en_US/home/tools/ip/tensilica-ip.html
- [5] R. David, and others. 2020. Tensorflow lite micro: Embedded machine learning on tinyml systems. *arXiv* (2020).
- [6] F. Fahim, and others. 2021. hls4ml: An Open-Source Codesign Workflow to Empower Scientific Low-Power Machine Learning Devices. *CoRR* (2021).
- [7] H. Genc, and others. 2021. Gemmini: Enabling systematic deep-learning architecture evaluation via full-stack integration. In *Proceedings of 58th DAC*.
- [8] K. Guo, and others. 2019. A survey of FPGA-based neural network inference accelerators. *ACM TRETS* (2019).
- [9] T. Hanawa, and others. 2013. Tightly coupled accelerators architecture for minimizing communication latency among accelerators. In *2013 IEEE IPDPS*.
- [10] Im-tomu. 2018. Fomu-hardware. <https://github.com/im-tomu/fomu-hardware>
- [11] Florent K., and others. 2020. LiteX: an open-source SoC builder and library based on Migen Python DSL. *CoRR* (2020).
- [12] LiteX-Hub. 2012. LiteX-Boards. <https://github.com/litex-hub/litex-boards>
- [13] S. Liu, and others. 2016. Cambricon: An instruction set architecture for neural networks. In *2016 ISCA*.
- [14] M-Labs. 2018. nMigen. <https://github.com/>
- [15] Charles Papon. 2107. VexRiscv. <https://github.com/SpinalHDL/VexRiscv>
- [16] D. Richins, and others. 2021. AI tax: The hidden cost of AI data center applications. *ACM TOCS* (2021).

- [17] D. Shah, and others. 2019. Yosys+nextpnr: An Open Source Framework from Verilog to Bitstream for Commercial FPGAs. *IEEE 27th FCCM* (2019).
- [18] H. Sharma, and others. 2016. Dnnweaver: From high-level deep network models to fpga acceleration. In *Workshop on Cognitive Architectures*.
- [19] A. Shawahna, and others. 2018. FPGA-based accelerators of deep learning networks for learning and classification: A review. *IEEE Access* (2018).
- [20] SymbiFlow. 2018. <https://symbiflow.github.io/>
- [21] Synopsys. 2017. ASIP Designer. <https://www.synopsys.com/designware-ip/processor-solutions/asips-tools.html>
- [22] Y. Umuroglu, and others. 2017. Finn: A framework for fast, scalable binarized neural network inference. In *International Symposium on FPGAs*.
- [23] S. Venieris, and others. 2018. Toolflows for mapping convolutional neural networks on FPGAs: A survey and future directions. *arXiv* (2018).
- [24] Y. Wang, and others. 2016. DeepBurning: Automatic generation of FPGA-based learning accelerators for the neural network family. In *DAC*.
- [25] E. Yang, and others. 2021. FlexACC: A Programmable Accelerator with Application-Specific ISA for Flexible DNN Inference. In *IEEE 32nd ASAP*.
- [26] T. Yang, and others. 2017. A method to estimate the energy consumption of deep neural networks. In *Asilomar conference on signals, systems, and computers*.
- [27] X. Zhang, and others. 2018. DNNBuilder: an Automated Tool for Building High-Performance DNN Hardware Accelerators for FPGAs. In *ICCAD*.