

---

# MARVIN: INNOVATIVE OMNI-DIRECTIONAL ROBOTIC ASSISTANT FOR DOMESTIC ENVIRONMENTS

---

**Andrea Eirale, Mauro Martini, Marcello Chiaberge**

DET

Politecnico di Torino

Torino, Italy

{andrea.eirale, mauro.martini, marcello.chiaberge}@polito.it

**Luigi Tagliavini, Giuseppe Quaglia**

DIMEAS

Politecnico di Torino

Torino, Italy

{luigi.tagliavini, giuseppe.quaglia}@polito.it

## ABSTRACT

Technology is progressively reshaping the domestic environment as we know it, enhancing home security and the overall ambient quality through smart connected devices. However, demographic shift and pandemics recently demonstrate to cause isolation of elderly people in their houses, generating the need for a reliable assistive figure. Robotic assistants are the new frontier of innovation for domestic welfare. Elderly monitoring is only one of the possible service applications an intelligent robotic platform can handle for collective wellbeing. In this paper, we present Marvin, a novel assistive robot we developed with a modular layer-based architecture, merging a flexible mechanical design with state-of-the-art Artificial Intelligence for perception and vocal control. With respect to previous works on robotic assistants, we propose an omnidirectional platform provided with four mecanum wheels, which enable autonomous navigation in conjunction with efficient obstacle avoidance in cluttered environments. Moreover, we design a controllable positioning device to extend the visual range of sensors and to improve the access to the user interface for telepresence and connectivity. Lightweight deep learning solutions for visual perception, person pose classification and vocal command completely run on the embedded hardware of the robot, avoiding privacy issues arising from private data collection on cloud services.

**Keywords** mobile robotics · assistive indoor robotics · modularity · Artificial Intelligence · vocal assistant · system design

## 1 Introduction

Population is living worldwide a demographic shift, and in particular, besides overpopulation, the population aging is a social problem that needs to be seriously taken into account. Indeed, according to the World Population Prospects 2019 [1], life expectancy reached 72.6 years in 2019, and it is forecast to grow to 77.1 years by 2050. In 2018, the amount of persons with an age of 65 or higher reached for the first time the number of children under 5 years. In addition, United Nations also declare that by 2050 the number of persons aged 65 years or over will overcome the number of youth aged 15 to 24 years. These projections suggest that healthcare systems and the overall organization of society will be drastically affected by such new demographic distribution. Moreover, emergency situations such as the COVID-19 pandemic raises critical issues in monitoring isolated people in their houses, which normally need dedicated assistive operators. Socially assistive robots (SAR) have recently emerged as a possible solution for elderly care and monitoring in the domestic environment [2]. Although the specific role and objectives of a robotic assistant for elderly care need to be concurrently discussed from an ethical perspective, according to Abdi et al. [3] diverse robotic platforms for social

assistance already exist. These studies often brought researchers to limit their study to the human-machine interaction, realizing companion robots with humanoid [4] or pets-like architectures [5], [6]. Such robots have been particularly studied for what concerns dementia, aging, and loneliness problems [7, 8]. Different studies specifically focus on detailed monitoring tasks, for example, heat strokes [9] and fall detection [10].

Besides the healthcare and elderly monitoring purposes, the potential scope of application of an indoor robot assistant is wide, having as general goal the enhancement of the domestic welfare. Indeed, the awareness about air quality risks is rapidly increasing with the spreading of COVID-19. Moreover, following the Internet of Things (IoT) the paradigm of house as we know it is changing with the introduction of multiple connected devices. According to this, recent studies reveal that robots can be identified as complete solutions for future houses management [11].

In the last years, the robotics research community is focusing its effort on the study of an effective design for an indoor assistant, and different proposals have recently emerged. The HOBBIT robot [12] and the Toyota Home Service Robot (HSR) [13] are the results of different research projects and they present a similar architecture composed of a wheeled main body equipped with manipulators for grasping objects. Despite the fact they are wheeled platforms, they both present a human-like shape and dimension. TIAGo [14] is another comparable platform developed for robotics research groups and in general for indoor applications. SMOOTH robot [15] is the final outcome of a research study that aims at developing a modular assistant robot for healthcare with a participatory design process. Three use cases for SMOOTH robot have been identified: laundry and garbage handling, water delivery, and guidance.

In addition to research projects, Amazon has recently launched its commercial home assistant Astro [16]. Even though it is still in an experimental stage, Astro can be surely considered an enhanced design thought for end-users, which is able to visually recognize people and interact with them through cameras and thanks to the Alexa vocal assistant. Robotic platforms as Astro, aims at totally managing the house, providing also surveillance and telepresence services.

In this paper, we propose a novel robotic assistive platform: *Marvin* (Figure 1). The goal of our mobile robot is to provide basic domestic assistance to the user. In the following, the complete mechatronic design process adopted is presented. We identify a set of application tasks for Marvin robot within the overall research scope of socially assistive robots such as patients monitoring, fall detection, night assistant, remote presence, and connectivity. We adopt a layered modular designing approach to conceive a mobile robot that will be indifferent to small modifications of the environment in which Marvin is used and of the feature that the specific application requires. Differently from previously presented robots for home assistance, we choose an omnidirectional base platform [17]. Indeed, Marvin exploits four mecanum wheels to autonomously navigate in a cluttered indoor environment such as the domestic one. Omniwheels and mecanum wheels have already been studied in many prototypes [18], [19], and they are particularly used in industrial robotics applications [20], where the flexibility and the optimization of trajectories are a priority. Omnidirectional motion offers a competitive advantage with respect to a most commonly used differential-drive system in unstructured environment navigation. In particular, the omnidirectional mobility can be exploited to efficiently monitor the user while navigating and avoiding obstacles. In the case of asymmetric footprint platform, the omnidirectional capability can be also used to exploit the minor size of the platform footprint to pass through confined spaces, which are very common in domestic environment. Although the study of the human-robot interaction does not fall in the specific scope of this project, we design a telescopic positioning device to adjust the height and tilt of Marvin's camera and its potential user interface. This effectively improves its usability for surveillance purposes offering an extended visual range and facilitates access to its screen for telepresence and connectivity. The mobile robot design has been merged with state-of-the-art computer vision and AI methods for perception, person tracking, pose classification, and vocal assistance. Deep Learning lightweight models have been selected from recent literature and optimized for real-time inference with the computational embedded hardware mounted on the robot. Similarly to the Amazon robot Astro, Marvin presents an AI-based vocal assistant named PIC4Speech for controlling its actions and selecting the desired task. However, differently from Alexa, the PIC4Speech system described in Section 5 completely runs offline, on the onboard computational device of the robot, avoiding the privacy risks and issues of an online cloud-based solution.

## 2 Requirements

The first step for the design of whatever mechatronic system is the definition of the specifications that must be fulfilled. Due to the large number of the tasks identified for the application and due to the unpredictability of the working environment of the robot, it is difficult to draw a linear path for the designing phase. In any case, given a set of tasks and performances to be addressed, some specifications can be worked out for the robotic platform and for the software and electronic design.

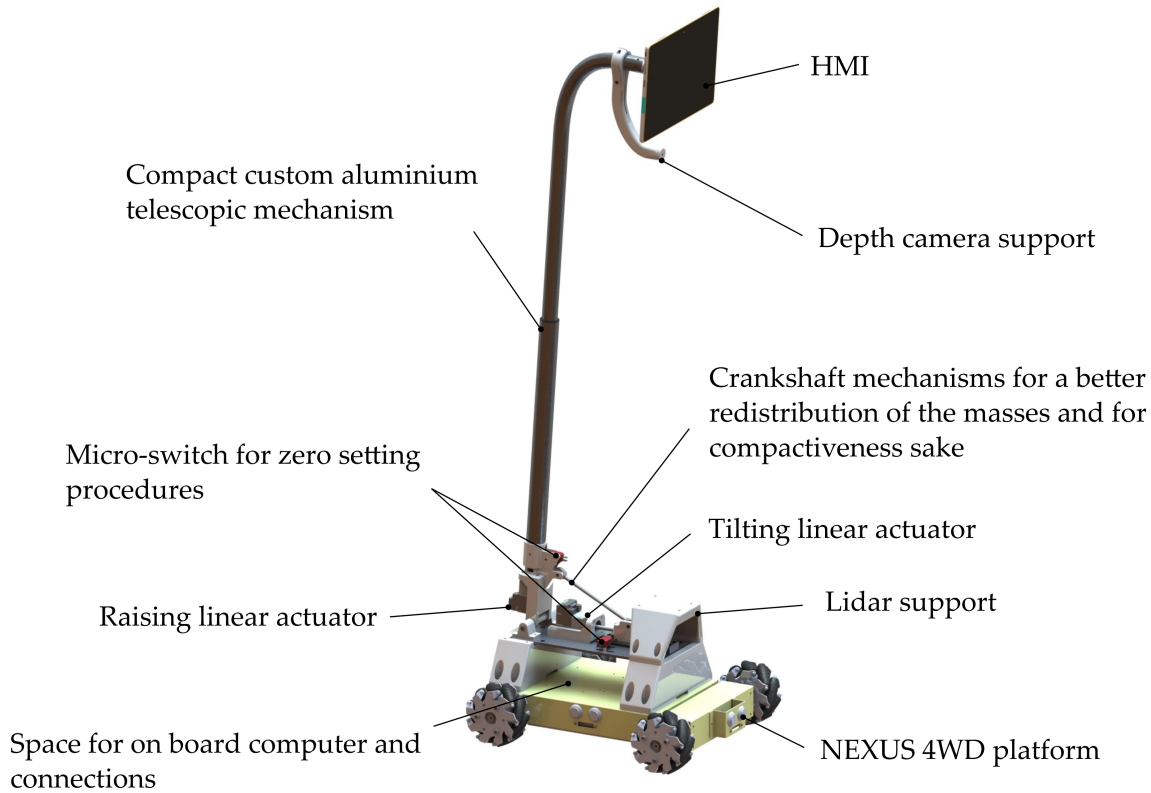

Figure 1: Final prototype of the mobile assistive robot Marvin.

## 2.1 Goal Statement

The most interesting application in which the robot will be adopted is that of acting as a personal domestic assistant. A more specific focus is the assistance of elderly or handicapped users, i.e. assistance of people owning reduced motility. In this direction, the robot final goal is to provide basic indoor assistance such as patients monitoring, fall detection, night assistant, remote presence and connectivity. Specific tasks and required abilities have been identified for the assistive robot:

- **Autonomous navigation from a voice command:** the robot goes to a specific location of the environment, on user request. Voice control has been chosen because of its simplicity and consequent fast-learning curve. When needed the robots can be asked to go away to ensure the privacy of the user. In this case, the robot leaves the room and return to the recharging docking. Such ability requires the definition of points of interest, like rooms or specific locations (bedroom, kitchen, «home», etc), vocal command recognition, autonomous navigation capability and self-localization.
- **Person-following ability:** when asked the robot autonomously follows the user. This feature can be used to show the robot a new environment and generate a map, to change room, etc. This task requires a person tracking algorithm based on visual information, recognition neural networks and autonomous navigation algorithms.
- **Fall detection:** the robot should be able to detect a fall of the user and call for help. In order to detect if the user occurs in an accidental fall, many approaches are possible. For example, it is possible to provide the environment with proper sensors, to provide the user himself with wearable sensors, or to monitor with the robotic assistant his displacements within the house. The first two solutions require intervention on the users' houses, or on the users themselves. Therefore, the monitoring of the person movement by the robot is the more feasible solution, even though it requires the robot to maintain a constant line of sight with the user. From a mobility point of view, this implies the ability to move and reorient the robot sensors at any instant. To such an aim, the machine must be able to exhibit whatever angular velocity at any time so that the line of sight can be maintained constantly. Aside from this, the robot should exhibit monitoring ability: recognize a laying posture

and ask for help if necessary. This task requires the implementation of pose detection and classification neural networks and external communication via a mobile connection.

- **Remote presence and connectivity:** the robot must be provided with the ability to access commonly used communication platforms (e.g. Skype, Whatsapp, etc). Such a task implies that the robot should be able to approach the communication interface for the user to answer or perform calls/video calls. Such ability infers with usability requirements: the human-robot interface needs to be positioned and oriented towards the user.
- **Night assistance:** one of the most critical moments in the daily life of elders is the night-time bedroom-to-toilet journey. Thus, the robot would be adopted to provide basic assistance for this moment. That means assisting the user enlightening the path and monitoring its movements, giving alarms in case of need. Again, such a feature requires as-high-as-possible manoeuvrability to contemporary providing light and not hampering the user path. When required the robot goes to specific a location with night lights on, accompanying the user to the destination. Such ability requires the definition of points of interest, like rooms or specific locations (bedroom, kitchen, «home», etc), vocal command recognition, self-localization and a proper lighting system.

## 2.2 Environment Related Requirements

To access all the features presented in the previous section, a list of requirements can be identified for the robot.

**Performance:** as anticipated, the robot should act as a personal assistant. As a consequence, it should be able to follow the user to provide basic assistance. From a mechanical point of view, this implies with the need of performing a velocity similar to that of a human walk ( $v \approx 1 \div 1.5m/s$ ). The robot should be capable of reaching such cruise velocity in a reasonably short time ( $t \approx 1 \div 1.5s$ ): it follows an acceptable maximum acceleration range  $a_{MAX} \approx 0.7 \div 1.5m/s^2$ .

**Dimensions:** the environment where the robot should navigate is designed for human's needs. To effectively move in this environment, the assistant should have the same footprint as human's have: maximum encumbrance on the ground approximately of  $40cm \times 60cm$ .

**Mobility:** the use case requires the robot to exhibit remarkable mobility to maintain a reduced distance from the user while he is moving within the domestic environment. To such an aim, it turns crucial to provide the mobile platform with full in-plane mobility. Such a feature allows the robot to exhibit velocities in the plane independently from its configuration (orientation).

**Usability:** the identified users' category suggests that the robot should own an easy-accessible interface, to allow efficient interfacing. This feature yields requirements for both software and structural design areas. From the mechanical point of view, the robot layout must allow simple and comfortable access to the interface area. Then, it is interesting to consider the possibility to provide the interface with a proper number of degrees of freedom, to make it approach the users' reach when they are unable to.

**Computational capability:** given the complexity of the software system, a certain degree of computational resources are needed. In particular, one of the most critical components in this regard is represented by the navigation system: to guide the platform in a cluttered, dynamic environment, it needs to replan the optimized path very quickly and react appropriately to very different and potentially dangerous situations. In any case, the final implementation needs to be executed completely on-board the platform, without the help of external or remote contributions.

## 3 Modular Platform Architecture

In general, the architecture of a service robot can be drawn as the interaction of many design layers which must be orchestrated so that their cooperation ensures the fulfilment of every task. Such layers cover all the robot's physical and non-physical constituent parts, such as mechanics, electronics, and software. In the following sections, the designing processes are presented separately, coherently with the modular approach adopted. This approach has been chosen to develop robust architectures, physical and non-physical, that will be indifferent to small modifications of the particular application environment. The interaction between the different layers is coordinated by communication protocols.

The platform architecture can be divided into two fundamental layers: a *Low Layer System* and a *High Layer System*. On top of this, a further *Human Machine Interface Layer* can be defined. The low layer system includes all basic

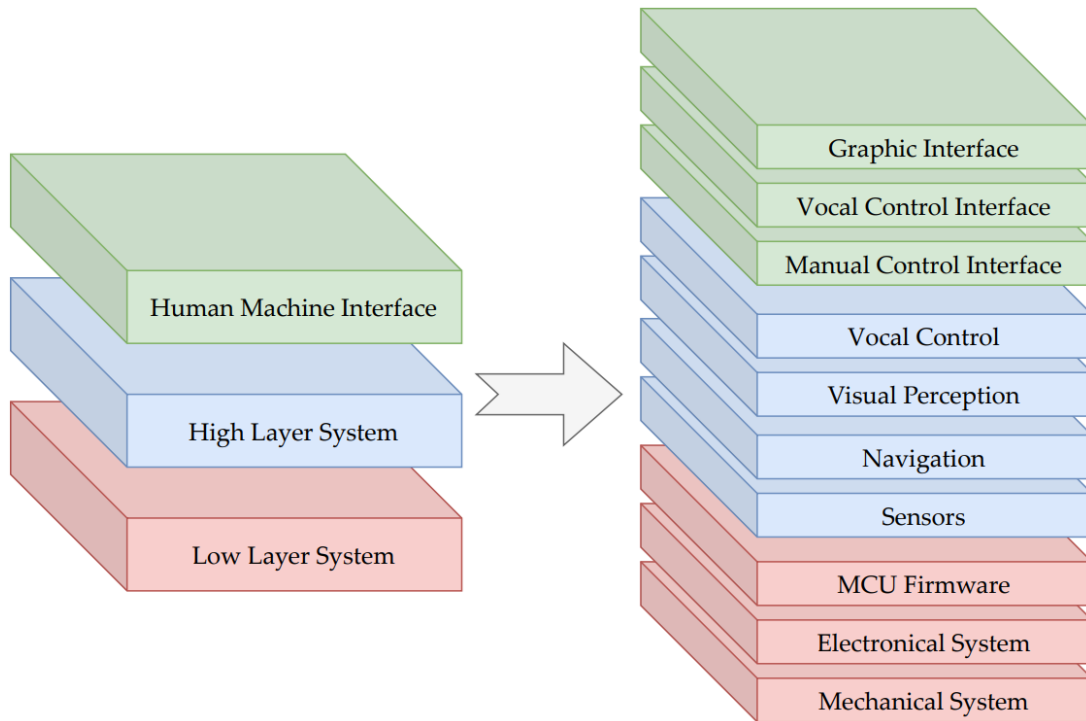

Figure 2: Schematic representation of the platform architecture main modules

components on which the platform is designed. These are the *mechanical system*, that is the physical structure constituting the rover, and the *electronic system*, which allows the platform to activate motors, actuators and peripherals. Immediately thereafter, the *microcontroller firmware* enables the control of the two previous layers, providing an efficient communication between hardware and software systems. The high layer system contains all algorithms used for navigation, visual perception and vocal control, and all the sensors used to achieve these tasks. Finally, the human-machine interface layer comprehends both the main platform’s communication means, manual and vocal control, and the graphic interface mounted on the positioning device.

### 3.1 Sensors employed

For the robot to effectively work in the domestic environment, a whole series of sensors are required to adequately perceive the surroundings. Alongside classic devices like RGB cameras and Lidar sensors, technology has introduced more powerful tools able to autonomously achieve advanced tasks, like self-localization and depth estimation. On the platform, some of these state-of-the-art devices are employed. In particular, the following sensors are used:

- Intel RealSense T265 Tracking Camera, with VIO technology for self localization of the platform. It is placed in the front of the rover, to better exploit its capability
- Intel RealSense D435i Depth Camera, able to provide color and depth image of the environment. It is mounted on the appropriate support, on the positioning device, which provide a convenient elevated position to the camera
- RPLIDAR A1, exploited for its precision in obstacle detection, a fundamental aspect for obstacle avoidance navigation and mapping of the environment
- Jabra 710, with a panoramic microphone and speaker. It is particularly useful for voice command. Can be placed on the rover or used wireless from a distance
- Furthermore, a wireless gamepad is employed for manual control operations.

### 3.2 Computational resources

With technological advancement, software algorithms have exponentially grown in complexity and computational requirements, leading to the abandonment of limited integrated systems, in favour of more powerful hardware. Fortu-

nately, these systems are increasingly widespread and easy to find, allowing researchers to focus on the development of new applications, without worrying about hardware limits.

Our system relies on two fundamental components: the *microcontroller unit* (MCU) which manage the low layer system software and a computing unit, that execute all high layer system applications. The selected microcontroller, a Teensy 4.1, is chosen for its high clock frequency and excellent general performance. On the high-level system, an Intel NUC11TNHv5 is selected as a computing unit, as it represents a good trade-off between high computational power and low energy consumption. A Coral Edge TPU Accelerator is employed alongside the computing unit to run optimized neural network models without the necessity of a full-size graphics processing unit.

## 4 Mobile Robot Design

This section presents the designing steps that have been made for the base platform selection and control and for the custom positioning device design.

### 4.1 Base Platform

In order to rapidly prototype the proof of concept of this assistant, a commercial omnidirectional 4WD robotic platform has been selected after extensive scouting. The selected platform, Nexus 4WD, is provided with four mecanum wheels and a passive rolling joint as represented in Figure 3 (a). The on-board set of locomotion provides the platform with omnidirectional capability, while the passive rolling joint between the front and rear module of the platform is beneficial to guarantee full contact on all four wheels.

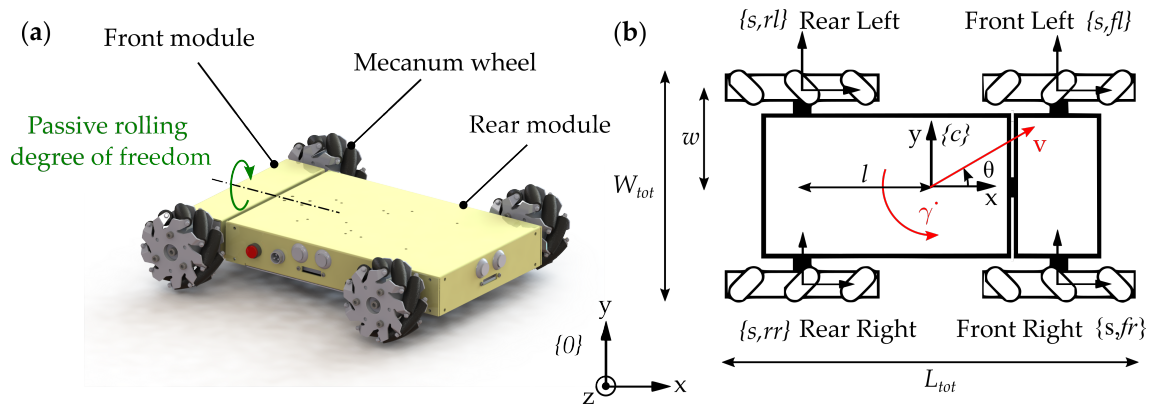

Figure 3: Base platform render and depiction (a) and parameters' definition (b).

The kinematics of the platform can be described using a local reference frame (r.f. in the following)  $\{c\}$  defined with respect to a fixed reference frame  $\{0\}$ . The parameters of the kinematic model and the reference frames are defined Figure 3 (b), while the main variables and parameters of the kinematic model are summarized in Table 1.

To analyse the mobility of the commercial Nexus 4WD platform, the motion of the mobile robot can be limited to a quasi-planar motion, which represents a significant simplification of the kinematic model. The pose of the chassis turns to be defined by only two parameters for the translation and one for the orientation. The position of the four contact points with the ground coincides with the projections of the origins of r.f.'s  $\{s, \sim\}$  on the ground. Assuming pure rolling between the small rollers of the mecanum wheels and the ground, equation 1 describes the relationship between the driven wheel velocities and the chassis longitudinal ( ${}^c v_x$ ), transverse ( ${}^c v_y$ ), and angular speed ( ${}^c \dot{\gamma}$ ).

$$\begin{bmatrix} {}^c \dot{\gamma} \\ {}^c v_x \\ {}^c v_y \end{bmatrix} = \frac{r}{4} \begin{bmatrix} -\frac{1}{l+w} & \frac{1}{l+w} & \frac{1}{l+w} & -\frac{1}{l+w} \\ 1 & 1 & 1 & 1 \\ -1 & 1 & -1 & 1 \end{bmatrix} \begin{bmatrix} \dot{\theta}_{fl} \\ \dot{\theta}_{fr} \\ \dot{\theta}_{rr} \\ \dot{\theta}_{rl} \end{bmatrix} \quad (1)$$

From equation 1 it is clear that:

- forward/backward motion requires all wheels to have the same speed;

Table 1: Main kinematic variables and parameters.

Variable	Symbol	Unit	
Chassis position in space	$\mathbf{x} = [x_c \ y_c \ z_c]^T$	$m$	
Chassis velocity in space	$\dot{\mathbf{x}} = [\dot{x}_c \ \dot{y}_c \ \dot{z}_c]^T$	$m/s$	
Chassis yaw angle	$\gamma$	$rad$	
Chassis yaw rate	$\dot{\gamma}$	$rad/s$	
Front right wheel velocity	$\dot{\theta}_{fr}$	$rad/s$	
Front left wheel velocity	$\dot{\theta}_{fl}$	$rad/s$	
Rear right wheel velocity	$\dot{\theta}_{rr}$	$rad/s$	
Rear left wheel velocity	$\dot{\theta}_{rl}$	$rad/s$	
Parameter	Symbol	Value	Unit
Transverse semi-axis	$w$	0.00	$m$
Longitudinal semi-axis	$l$	0.00	$m$
Transverse encumbrance	$W_{tot}$	0.00	$m$
Longitudinal encumbrance	$L_{tot}$	0.00	$m$
Wheel radius	$r$	0.00	$m$

- pure rotation about the z-axis requires the same speed for wheels on the same side;
- sideways motion requires that the wheels on opposite corners should have the same speed, opposite to the ones on the other corner;
- omnidirectional motion requires a specific combination of the four wheel velocities.

A further study has been conducted to identify the mobility limitation due to the maximum wheel velocities. Given a maximum velocity of the wheels  $\dot{\theta}_{max}$ , the platform velocities must lie inside the velocity Octahedron represented in Figure 4.

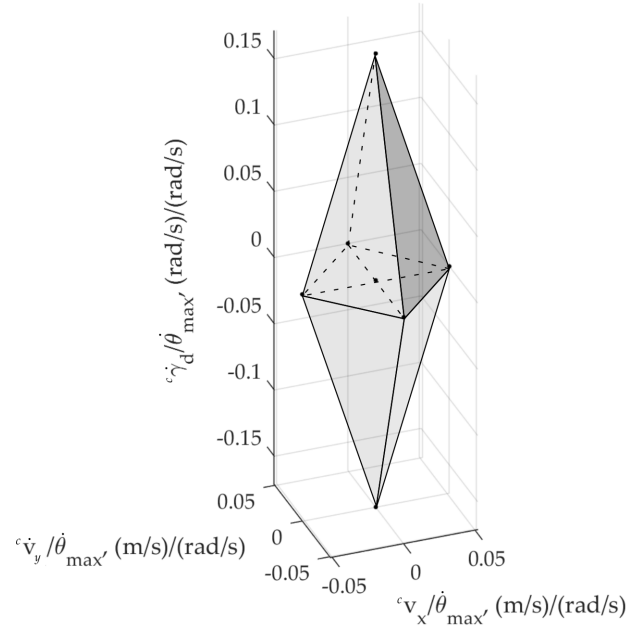

Figure 4: Allowed velocity octahedron.

This map is fundamental to ensure that the inputs given to the platform are coherent with the physical limitation of the robot. Given this operative tool, the velocity inputs given to the platform are filtered through this map. Different

approaches can be adopted to filter this information, our solution takes the rotation rate about the  $z$ -axis and module the maximum linear velocity along  $x$ -axis and  $y$ -axis to ensure that the input reference lies inside the octahedron.

## 4.2 Positioning Device

The main peculiarity of the robot, aside from its ability to exhibit full planar mobility, is its capability to deploy its sensors and user interface. Such aspect is crucial for different reasons:

- it allows improving the perception of the robot of the external environment improving the range of view of the sensors;
- a re-orientable and deployable head enhances the usability of the touch interface for the users, giving a chance also to bedridden or handicapped people to easily interact with the robot.

Firstly, the workspace requirements need to be evaluated. As the application suggests, the head should reach above common furniture to bring the user interface in a comfortable position. To perform this action, the robot can approach the furniture parking as close as possible to the goal position or it can go under the furniture if the geometry allows it, as shown in Figure 5. Moreover, the device can be mounted near the closer or at the opposite side of the approached entity. Regarding Figure 5, the mounting configuration (b) guarantees a better redistribution of the masses to keep the centre of mass inside the footprint of the robot, but the device has limited capability at reaching distant points in the longitudinal direction, while the mounting configuration (c) enables the device to further reach out in that direction, but it moves the centre of gravity away from the centre of the platform.

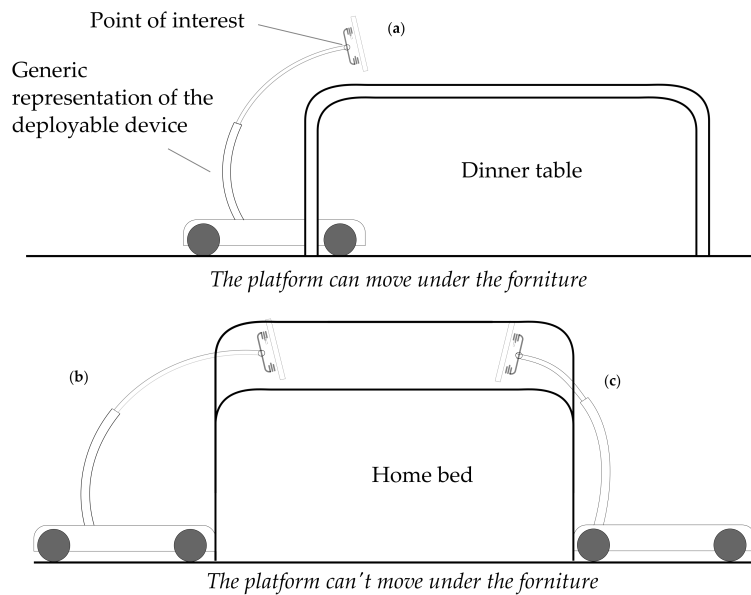

Figure 5: Mounting configurations of the telescopic device on the platform.

The workspace related requirements have been chosen according to the specific working scenario. In particular, the following situations have been considered:

- Dinner table: under motion is possible, no longitudinal displacement from the platform border is required, working height approximately  $90 - 100\text{cm}$ ;
- Home bed: under motion is usually not possible, required longitudinal displacement from the platform border of approximately  $20\text{cm}$ , working height approximately  $80 - 90\text{cm}$ ;
- Hospital bed: under motion is usually possible, required longitudinal displacement from the platform border of approximately  $20\text{cm}$ , working height approximately  $100 - 110\text{cm}$ ;
- Standing person: no longitudinal displacement from the platform border is required, working height approximately  $120\text{cm}$ ;



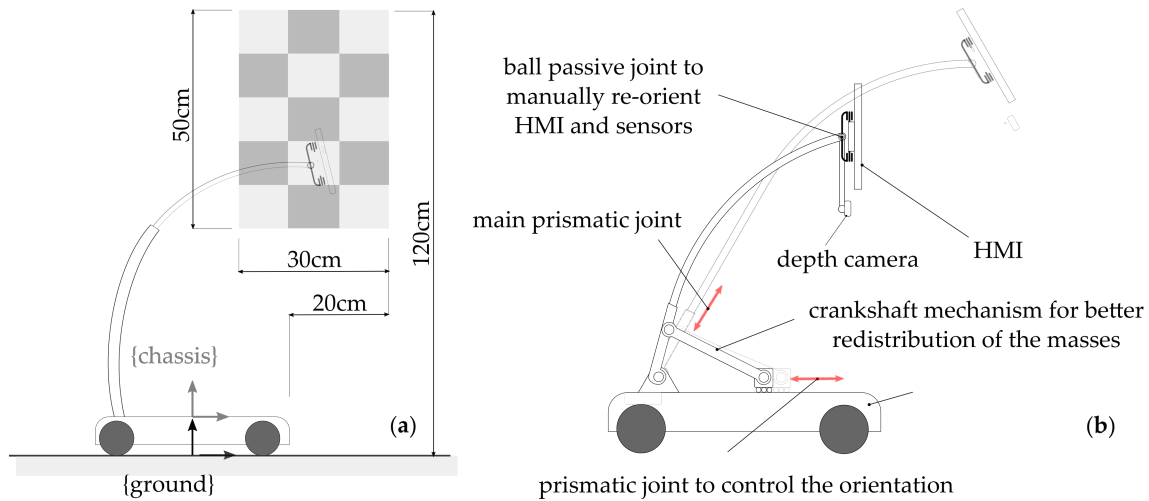

Figure 6: Workspace identified for the deployable mechanism (a) and functional representation of the proposed architecture (b)

- Seated person: required longitudinal displacement from the platform border of approximately 10 – 20cm, working height approximately 90 – 100cm;
- Person on wheelchair: required longitudinal displacement from the platform border of approximately 10 – 20cm, working height approximately 80 – 90cm;

To keep the centre of gravity low during the motions, the conceived device need to be retracted in as much compact configuration as possible. Figure 6 (a) shows the selected workspace following the requirements set up by the application.

To such an aim, the selected solution is presented in Figure 6 (b). To orient and raise the human-robot interface and sensors, a two degree of freedom mechanism is adopted. A crankshaft mechanism is being adopted to keep the centre of gravity low and to exploit the free space available. In this way, the automatic orientation of the mechanism is performed by the lower linear actuator, while a second motor actuates the vertical axis.

Once the architecture has been defined, it is possible to evaluate the main parameters for the positioning device. According to the workspace previously defined and considering the commercial platform Nexus 4WD with a height of 10cm a longitudinal length of 30cm, the required linear stroke for the main prismatic joint and the required angular stroke for the orientation are respectively 350mm and 26°.

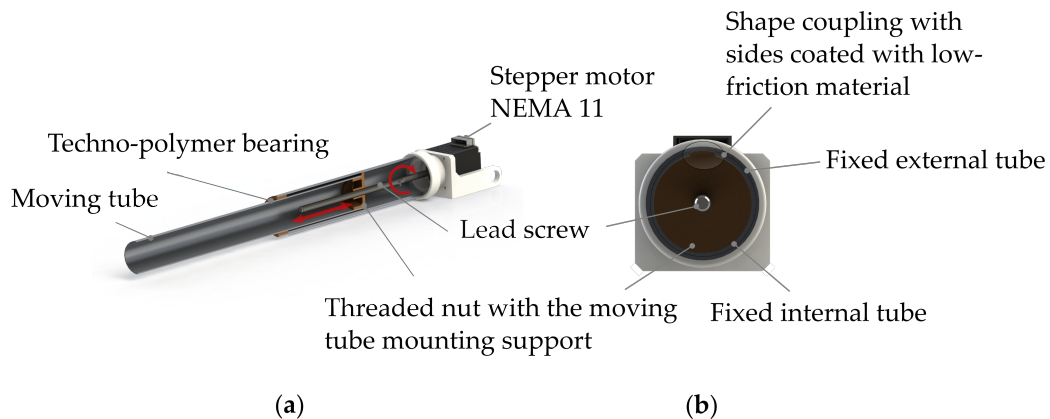

Figure 7: Longitudinal section (a) and cross-section of the custom linear guide (b)

Given the requirements and the functional design previously presented, the following section describes the executive design of the positioning device. The executive design has been conceived to combine a standard manufacturing approach and a more innovative additive manufacturing. This approach aims at limiting the cost of the prototype and avoiding the technological limitation of standard processes while keeping good tolerance and precision for the critical components.

The actuation units are composed of two stepper motors provided with a screw where a nut is engaged. On the tilting mechanism, a commercial linear guide constrains the nut to translate without rotation relative to the motor holder. The same result is obtained on the vertical axis through a custom solution to reduce the encumbrance and weight of the mechanism. To achieve this result we adopted a screw-nut actuation system combined with a shape coupling to constraint the threaded nut to translate without rotation relative to the motor holder, as presented in Figure 7. The motors accept as input a couple of square wave signals to command the motion in the two directions: clockwise and counterclockwise. The combined effects of the 200 physical steps per revolution, a 256 factor of micro-stepping and a screw pitch of  $6.35\text{mm}$  enable very fine positioning of the linear guide. An anti-backlash nut is adopted to avoid uncontrolled motion during changes of motion direction. The hollow design of the telescopic guide is conceived for housing the cables of the sensors installed on the device, for which a retraction system mechanism should be included in the future.

In Figure 8, the mobile assistive robot is represented in two configurations: on the left, the telescopic mechanism is deployed for better standing usage, while on the right the custom mechanism is retracted and inclined forward for better-seated usage. The retracted configuration is also very effective in keeping the center of gravity low during the motion of the robot.



Figure 8: Final prototype of the mobile assistive robot in two different working configurations: (a) Deployed configuration for standing usage, (b) Retracted end angled configuration for better seated usage.

## 5 Assistance software system

As already described in Section 3, the software architecture can be conceptually divided in high and low layer. The low layer software, running on the MCU, is responsible for receiving instructions from the computing unit and operating them on motors, actuators and peripheral devices. On the other hand, the computing unit executes much more complex algorithms, which compose the high layer software. In the following sections, the main components constituting the entire system are presented.

### 5.1 Microcontroller Firmware

The microcontroller firmware takes care of actuating on three subsystems: wheel motors, positioning device actuators and lighting system. The high layer software sends the required velocity twist of the platform to the microcontroller which computes the inverse kinematics to convert this information into velocity references for each wheel using the inverse kinematic matrix, as can be seen in Figure 9. Moreover, a *Proportional-Integral-Derivative* (PID) controller is

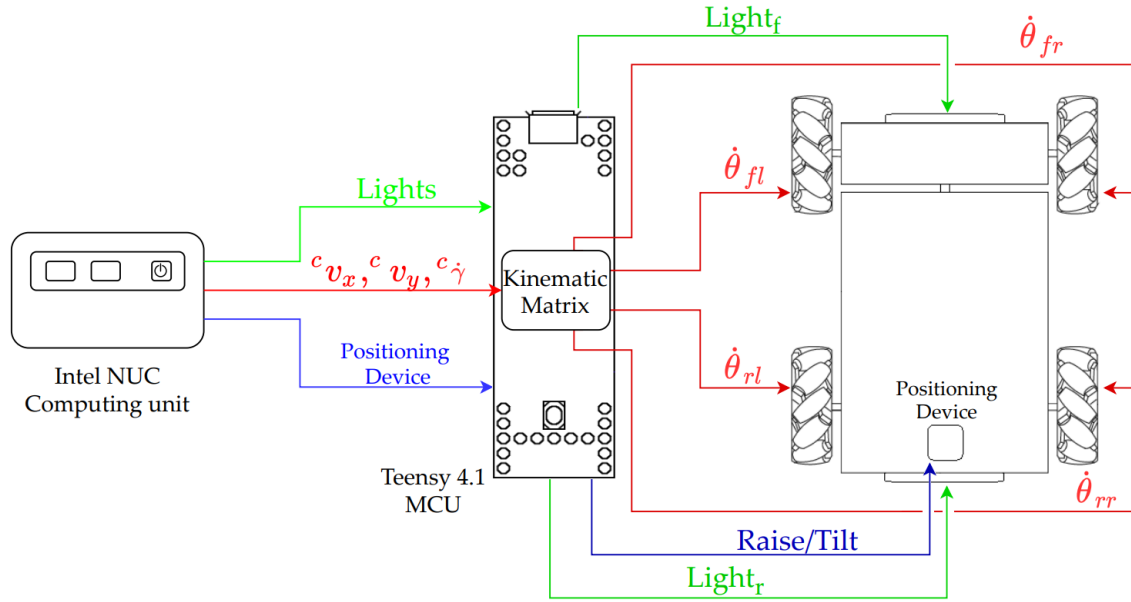

Figure 9: Simple visualization of the MCU system. The microcontroller exploits the cinematic matrix of the platform to translate the velocities of the chassis, arriving from the computing unit, into the velocities of each wheel. Furthermore it needs to turn on/off lights and control the positioning device, depending on requests of high layer applications.

applied on the closed-loop control system of each wheel to effectively follow the imposed speed profile. The positioning device can be raised and tilted towards the front of the platform. When fully retracted, two mechanical micro-switches (one for the vertical and one for the horizontal axis) ensure the starting position of each stepper actuator. When the platform is turned on, if switches are not pressed (the device is not fully retracted), a zero-setting procedure is performed. When the user requires the raise (or the tilt) of the device, a predefined stroke is covered by the actuator, raising (or tilting) the device at operational speed. At last, the microcontroller is responsible for turning the lights on and off during night assistant mode.

## 5.2 High layer software structure

Shifting the attention to the system running on the computing unit, the whole high layer software system is written in Python3 and is organized in nodes, exploiting ROS2 as infrastructure to make nodes communicate with each other. The system is then based on a Data Distribution Service (DDS) structure, with nodes able to publish and subscribe to different topics. In this system, all the nodes listen to (or publish on) a specific topic (called *Actions topic* hereafter for clarity), containing information regarding the action the robot is supposed to perform at that moment. This action can be one of the tasks presented before, or simply a request to urgently stop all the current activities. In such a way, a certain degree of synchronization between all the components of the system is ensured, with consequent robustness of the entire software.

The serial node is the first piece of software of the high layer software directly interfacing with the microcontroller system. It is responsible for managing the information exchange with the microcontroller through serial communication, conveying high layer commands such as platform velocities or control instructions for the positioning device. Moreover, the serial node is also responsible for prioritizing possible velocity commands arriving from the manual control interface with respect to the ones sent by the autonomous navigation system. This naive stopping mechanism reinforces the ready control of the user on the autonomous behaviour of the platform and allows the user to easily change the current task in execution.

To control the platform, the user can use two different human-machine interfaces. The first is the Vocal Command (which will be presented later in this chapter), the second is the wireless gamepad. The latter allows manual control of the platform, as well as the execution of all the tasks. The manual control interface provides also the possibility to send an emergency stop signal which immediately disables the platform current action, guaranteeing safety conditions and risk prevention.

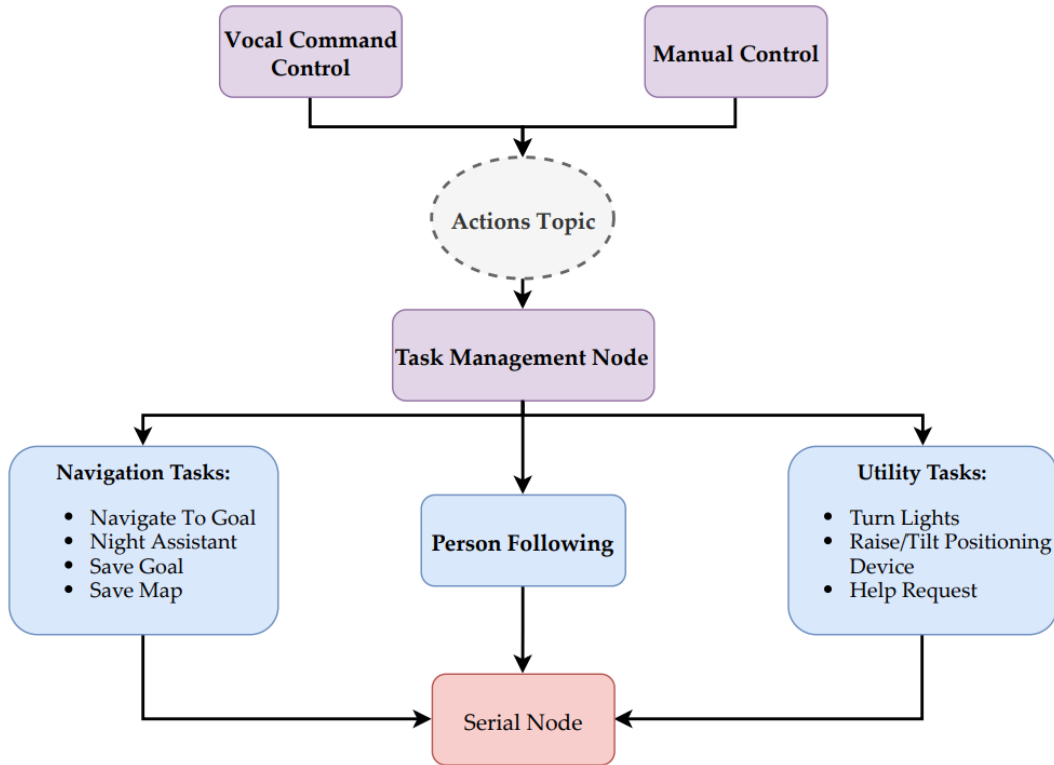

Figure 10: Schematic description of the high-level software structure: the desired action is received by the manual or vocal control interface and redirected to the dedicated controller node by the task management node.

Any task activated manually or through vocal command publishes the request of activation on the Actions topic. The Task Management Node listens to this topic and activates the desired task, as can be seen in Figure 10. The only exception is the manual controller, which can directly communicate with the Serial node, since it needs to abort any task bypassing the whole system. As explained before, this centralizes the execution of tasks with a consequent improvement in robustness.

### 5.3 Visual Perception for Person Monitoring

Computer vision is a fundamental component of most recent service robotics platforms. In the last decade, Deep Neural Networks have largely demonstrated to be meaningful solutions for a wide variety of visual perception tasks such as real-time object detection [21], semantic segmentation [22] or pose estimation [23]. As humans do, robots can exploit the vision of the surrounding environment to extrapolate information and plan their actions accordingly. Nonetheless, visual perception is an extremely effective method for monitoring a person in a domestic scenario. We developed a visual perception system for Marvin which contextually detect and track a person from colour images. Such information is translated into an effective method for constantly monitoring sudden emergency health conditions of the assisted individual. The RealSense D435i API is used to retrieve aligned colour and depth images.

The monitoring task is carried out through a double step computing pipeline. Firstly, the person-detection is obtained with PoseNet [24], a lightweight neural network able to detect humans in images and videos. As output, it gives 17 key joints (like elbows, shoulders, or feet) of each person present in the scene. At this point, a second simple neural network receives the key points to classify the pose of the person as standing, sitting, or laying. As already explained, a persisting laying condition can automatically activate an emergency call to an external agent (a relative or a healthcare operator).

Moreover, as shown in Figure 11, the key points predicted by PoseNet for the detected person can be exploited for a different assistive task: the person following. Indeed, once a person is recognized within the colour image, it is possible to derive the coordinates of such person with respect to the robot from the aligned depth image at any instant. This constitutes an effective method to generate a dynamic goal, corresponding to the position of the user, to be reached by

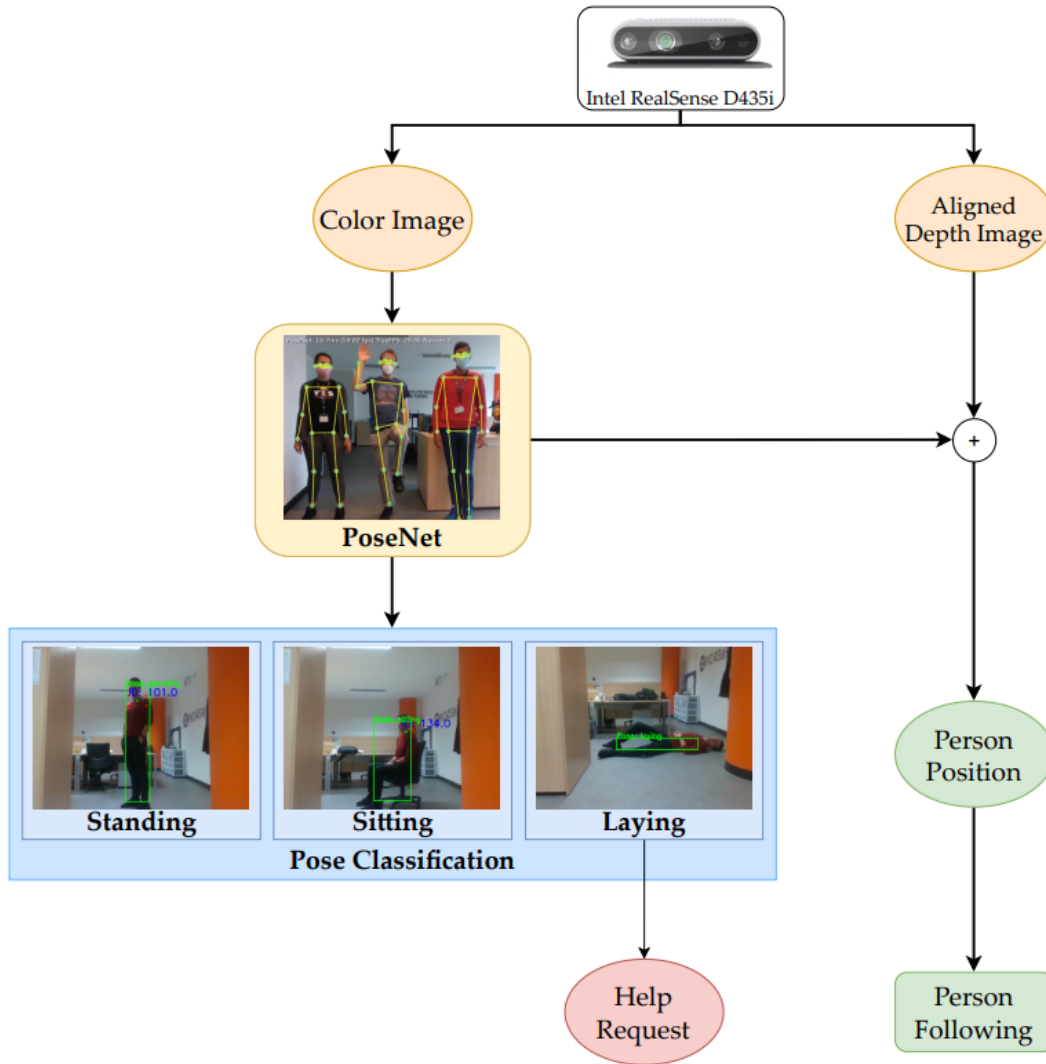

Figure 11: Representation diagram of the person identification system: the estimated pose of the person are continuously classified as standing, sitting or laying, generating an help emergency request if necessary. Moreover, it is used to extract the dynamic goal coordinates for the person following task.

the robot. The person-following navigation system is fed with such information and allows the robot to follow the user around the house. However, more than a single person is usually present in a family house, dramatically increasing the difficulty of an automatic system to recognize the person to follow. For this reason, we combine in our visual perception software a filter called Sort [25], which is used within the same node to track the people recognized. In particular, it assigns an ID to each person in the image and tracks them during their motion. The person with the lower ID is chosen to be followed: the robot focuses always on a single person and the computational complexity of the task is considerably reduced. Nonetheless, a further improvement of the person-following task can be achieved by adopting a neural network for person re-identification, allowing the robot to discard undesired detected persons and reduce the interference with its monitoring activity.

#### 5.4 Vocal Control Interface

The principal user’s communication interface with the platform is represented by a vocal assistant. We build our vocal assistant system, called PIC4Speech, exploiting the combination of state-of-the-art Deep Neural Networks (DNN) models for speech-to-text translation and Natural Language Processing (NLP) taken from literature. The overall structure of the system is inspired by the most notable products Siri, Alexa, and Google Assistant. It exploits a cascade of models that are progressively activated when the previous one is enabled. Figure 12 is presented an overview of the

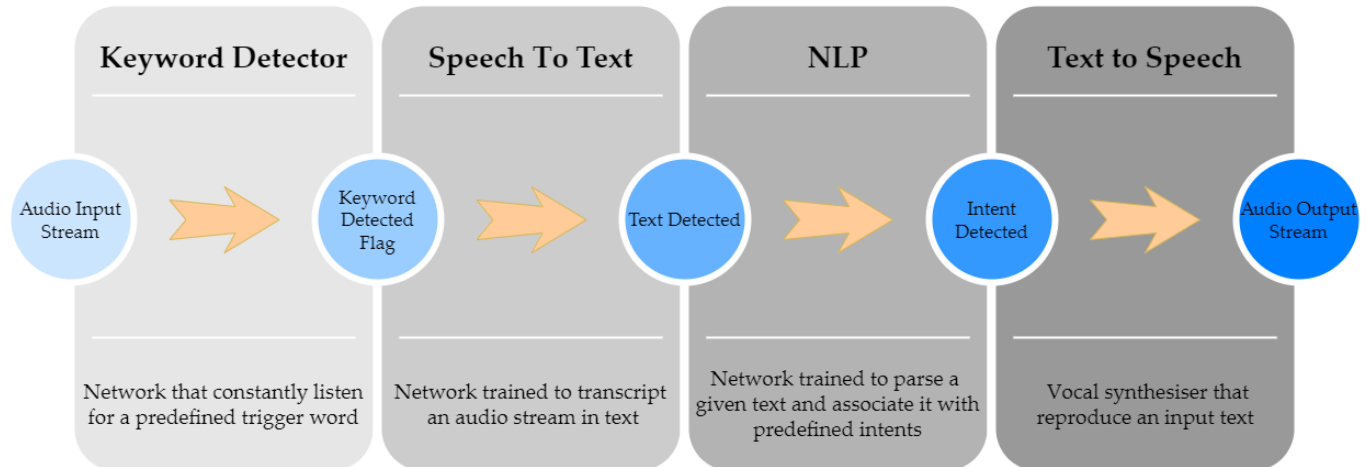

Figure 12: Overview of PIC4Speech vocal assistant architecture.

overall architecture of the PIC4Speech vocal assistant. The system aims at matching a vocal instruction expressed by the user to the corresponding required task, in order to successively start the correct control process by publishing a ROS message on the Actions topic.

The PIC4Speech operative chain presents acts as it follows:

1. The first component is the **Keyword detector** [26], which constantly monitors the input audio stream in search of the specific triggering command. In this specific case, that word is the name of the platform, "Marvin".
2. Once the trigger word is detected, a second model performs a **speech-to-text** operation. We exploited the Vosk offline speech recognition API [27] for this block which gives the flexibility to switch language and has ample community support. It continuously analyzes the input audio stream until the volume is below a certain threshold and performs the transcription.
3. At this point, the text obtained is passed to core NLP step of the pipeline, responsible of the analysis and processing of the text command. We use the Universal Sentence Encoder (USE) [28] for semantic retrieval of the robot action, which is published on the Actions topic of the ROS framework.
4. The response of the vocal assistant is also given to the user with a text-to-speech process. Each OS comes with a default vocal synthesizer that can directly access the speakers.

More in detail, the keyword detection is performed with a DNN based on a Vision Transformer that constantly listens to the audio stream, looking for the target command. First, the mel-scale spectrogram is extracted from each sample of the input stream. These features are treated as visual information and therefore they are processed with a Vision Transformer [29], a state-of-the-art model for image classification. We re-trained the keyword detector on the open-source Speech Commands dataset [30], constituted by 1-second-long audio samples from 36 classes: 35 standard keywords plus a silence/noise class. Thanks to the multi-class approach, the keyword can be changed at run-time. Vocal instructions may arrive in a wide variety of verbal shapes to the robot. For this reason, we choose the Universal Sentence Encoder for the NLP stage of the pipeline. This recent model increased the usage flexibility by computing a semantic matching of sentences, allowing for a correct understanding of instructions with the same meaning, expressed differently. Although commercial voice assistants require a stable internet connection, PIC4Speech works completely offline, running uniquely on the hardware resources of the platform. Diversely, companies prefer to offer a server-client paradigm with the assistant algorithms running on the cloud. That solution presents some computational advantages, and most of all, it dramatically facilitates data collection. However, this solution may arise privacy issues related to the collection of data in domestic environments. In addition, the dependency on a stable internet connection may weaken the system performance in terms of response time and power consumption. For all those reasons, an offline solution should largely fit most service robotics applications requiring vocal control.

Moreover, it is worth noting that a help request is constantly checked visually by the pose classification node, but it can also be called directly through vocal command. In this case, the platform will ask the user for confirmation, avoiding any accidental activation. If confirmed, or without any reply within ten seconds, the help request is sent. Otherwise,

the platform return to its regular operation state. Further development of PIC4Speech vocal assistant, could see the substitution of the last block for text-to-speech conversion with an additional lightweight neural network, providing also the possibility to choose a more comfortable synthetic voice, closer to a real human one.

## 5.5 Navigation and Mapping system

In any navigation system, the primary necessity consists in localizing the robot within the operating scenario. To achieve this, the localization node exploits the Intel RealSense API to communicate with the T265 camera and retrieve the visual-inertial odometry [31]. This contains indeed the pose of the rover, in the fixed reference frame, at any time instant. The navigation system is based on the Navigation2 stack [32], which has been highly modified to suit the needs of the platform. Details on the entire development and optimization process of the navigation behavioral tree are out of the scope of this paper. When a goal is published on the Goal Topic by the Task Management Node or by the person following system, the navigation system retrieves the pose of the rover and exploit the 2D LiDAR points to perceive surrounding obstacles and create a local cost map. From such cost map, the navigation apparatus plans an optimal path for the platform and guide it towards the desired goal. Similarly, the mapping system, based on Slam Toolbox [33], uses the pose of the rover and the laserscan to generate a gridmap of the environment. Although the navigation system perfectly adapts to mapless circumstances, the generated map of the domestic environment can be saved by the robot.

## 6 Conclusions

In the era of automatic machines, technology is progressively reshaping the domestic environment as we know it. In particular, service robotics is recalling an ever-growing interest of markets, industries, and researchers. Their exploitation in the care-giving sector could relieve the pressure on assistive operators, providing basic assistance which does not require particular dexterity or adaptation capability. In this scenario, we developed a modular assistive mobile robot for autonomous applications in the field of assistance of elderly and reduced-mobility subjects. Hence, the paper aims at presenting Marvin, a four mecanum-wheel robot provided with a custom positioning device for the human-machine interface and state-of-the-art Artificial Intelligence methods for perception and vocal control. The robot has been fully prototyped and qualitatively tested in a domestic-like environment and it proved to be successful in the execution of the tasks. Future studies will quantitatively test the performance of the robot and an improvement on the human-machine interface will be developed.

## Acknowledgments

The work presented in this paper has born from the collaboration between PIC4SeR Centre for Service Robotics at Politecnico di Torino and Edison S.p.A. In particular, we sincerely thank Riccardo Silvestri and Stefano Ginocchio, as well as the entire team from Officine Edison Milano that fruitfully contributed to the funding and conceptualization of Marvin assistive platform, and supervised the whole design process. We demonstrated Marvin's capabilities in the Smart Home facility at Officine Edison Milano, simulating a real-case indoor assistance scenario, showing how Marvin successfully fulfill the tasks requirements identified in the design process.

## References

- [1] United Nations. Shifting demographics.
- [2] Alessandro Vercelli, Innocenzo Rainero, Ludovico Ciferri, Marina Boido, and Fabrizio Pirri. Robots in elderly care. *DigitCult-Scientific Journal on Digital Cultures*, 2(2):37–50, 2018.
- [3] Jordan Abdi, Ahmed Al-Hindawi, Tiffany Ng, and Marcela P Vizcaychipi. Scoping review on the use of socially assistive robot technology in elderly care. *BMJ open*, 8(2):e018815, 2018.
- [4] David Gouaillier, Vincent Hugel, Pierre Blazevic, Chris Kilner, Jérôme Monceaux, Pascal Lafourcade, Brice Marnier, Julien Serre, and Bruno Maisonnier. Mechatronic design of nao humanoid. In *2009 IEEE International Conference on Robotics and Automation*, pages 769–774. IEEE, 2009.
- [5] Masahiro Fujita. Aibo: Toward the era of digital creatures. *The International Journal of Robotics Research*, 20(10):781–794, 2001.
- [6] Selma Šabanović, Casey C Bennett, Wan-Ling Chang, and Lesa Huber. Paro robot affects diverse interaction modalities in group sensory therapy for older adults with dementia. In *2013 IEEE 13th international conference on rehabilitation robotics (ICORR)*, pages 1–6. IEEE, 2013.

- [7] Susel Góngora Alonso, Sofiane Hamrioui, Isabel de la Torre Díez, Eduardo Motta Cruz, Miguel López-Coronado, and Manuel Franco. Social robots for people with aging and dementia: a systematic review of literature. *Telemedicine and e-Health*, 25(7):533–540, 2019.
- [8] Norina Gasteiger, Kate Loveys, Mikaela Law, and Elizabeth Broadbent. Friends from the future: A scoping review of research into robots and computer agents to combat loneliness in older people. *Clinical interventions in aging*, 16:941, 2021.
- [9] Akihito Yatsuda, Toshiyuki Haramaki, and Hiroaki Nishino. A study on robot motions inducing awareness for elderly care. In *2018 IEEE International Conference on Consumer Electronics-Taiwan (ICCE-TW)*, pages 1–2, 2018.
- [10] Zaid A Mundher and Jiaofei Zhong. A real-time fall detection system in elderly care using mobile robot and kinect sensor. *International Journal of Materials, Mechanics and Manufacturing*, 2(2):133–138, 2014.
- [11] Gonçalo Marques, Ivan Miguel Pires, Nuno Miranda, and Rui Pitarma. Air quality monitoring using assistive robots for ambient assisted living and enhanced living environments through internet of things. *Electronics*, 8(12):1375, 2019.
- [12] David Fischinger, Peter Einramhof, Konstantinos Papoutsakis, Walter Wohlking, Peter Mayer, Paul Panek, Stefan Hofmann, Tobias Koertner, Astrid Weiss, Antonis Argyros, et al. Hobbit, a care robot supporting independent living at home: First prototype and lessons learned. *Robotics and Autonomous Systems*, 75:60–78, 2016.
- [13] Kunimatsu Hashimoto, Fuminori Saito, Takashi Yamamoto, and Koichi Ikeda. A field study of the human support robot in the home environment. In *2013 IEEE Workshop on Advanced Robotics and its Social Impacts*, pages 143–150. IEEE, 2013.
- [14] PAL Robotics. Tiago.
- [15] William K Juel, Frederik Haarslev, Eduardo R Ramirez, Emanuela Marchetti, Kerstin Fischer, Danish Shaikh, Poramate Manoonpong, Christian Hauch, Leon Bodenhagen, and Norbert Krüger. Smooth robot: Design for a novel modular welfare robot. *Journal of Intelligent & Robotic Systems*, 98(1):19–37, 2020.
- [16] Amazon. Introducing amazon astro – household robot for home monitoring, with alexa, 2021.
- [17] Ioan Doroftei, Victor Grosu, and Veaceslav Spinu. *Omnidirectional mobile robot-design and implementation*. INTECH Open Access Publisher, 2007.
- [18] Md Abdullah Al Mamun, Mohammad Tariq Nasir, and Ahmad Khayyat. Embedded system for motion control of an omnidirectional mobile robot. *IEEE Access*, 6:6722–6739, 2018.
- [19] Paulo José Costa, Nuno Moreira, Daniel Campos, José Gonçalves, José Lima, and Pedro Luís Costa. Localization and navigation of an omnidirectional mobile robot: the robot@ factory case study. *IEEE Revista Iberoamericana de Tecnologías del Aprendizaje*, 11(1):1–9, 2016.
- [20] Jun Qian, Bin Zi, Daoming Wang, Yangang Ma, and Dan Zhang. The design and development of an omnidirectional mobile robot oriented to an intelligent manufacturing system. *Sensors*, 17(9):2073, 2017.
- [21] Zhong-Qiu Zhao, Peng Zheng, Shou-tao Xu, and Xindong Wu. Object detection with deep learning: A review. *IEEE transactions on neural networks and learning systems*, 30(11):3212–3232, 2019.
- [22] Xuetao Zhang, Zhenxue Chen, QM Jonathan Wu, Lei Cai, Dan Lu, and Xianming Li. Fast semantic segmentation for scene perception. *IEEE Transactions on Industrial Informatics*, 15(2):1183–1192, 2018.
- [23] Zhe Cao, Gines Hidalgo, Tomas Simon, Shih-En Wei, and Yaser Sheikh. Openpose: realtime multi-person 2d pose estimation using part affinity fields. *IEEE transactions on pattern analysis and machine intelligence*, 43(1):172–186, 2019.
- [24] George Papandreou, Tyler Zhu, Liang-Chieh Chen, Spyros Gidaris, Jonathan Tompson, and Kevin Murphy. Personlab: Person pose estimation and instance segmentation with a bottom-up, part-based, geometric embedding model. *CoRR*, abs/1803.08225, 2018.
- [25] Alex Bewley, ZongYuan Ge, Lionel Ott, Fabio Ramos, and Ben Uppcroft. Simple online and realtime tracking. *CoRR*, abs/1602.00763, 2016.
- [26] Axel Berg, Mark O’Connor, and Miguel Tairum Cruz. Keyword transformer: A self-attention model for keyword spotting. *arXiv preprint arXiv:2104.00769*, 2021.
- [27] Alexey Andreev and Kirill Chuvilin. Speech recognition for mobile linux distributions in the case of aurora os. In *2021 29th Conference of Open Innovations Association (FRUCT)*, pages 14–21. IEEE, 2021.



- [28] Daniel Cer, Yinfei Yang, Sheng-yi Kong, Nan Hua, Nicole Limtiaco, Rhomni St John, Noah Constant, Mario Guajardo-Céspedes, Steve Yuan, Chris Tar, et al. Universal sentence encoder. *arXiv preprint arXiv:1803.11175*, 2018.
- [29] Alexey Dosovitskiy, Lucas Beyer, Alexander Kolesnikov, Dirk Weissenborn, Xiaohua Zhai, Thomas Unterthiner, Mostafa Dehghani, Matthias Minderer, Georg Heigold, Sylvain Gelly, et al. An image is worth 16x16 words: Transformers for image recognition at scale. *arXiv preprint arXiv:2010.11929*, 2020.
- [30] Pete Warden. Speech commands: A dataset for limited-vocabulary speech recognition. *arXiv preprint arXiv:1804.03209*, 2018.
- [31] César Debeunne and Damien Vivet. A review of visual-lidar fusion based simultaneous localization and mapping. *Sensors*, 20(7):2068, 2020.
- [32] Steve Macenski, Francisco Martín, Ruffin White, and Jonatan Ginés Clavero. The marathon 2: A navigation system. In *2020 IEEE/RSJ International Conference on Intelligent Robots and Systems (IROS)*, pages 2718–2725. IEEE, 2020.
- [33] Steve Macenski and Ivona Jambrecic. Slam toolbox: Slam for the dynamic world. *Journal of Open Source Software*, 6(61):2783, 2021.