

# EmTract: Investor Emotions and Market Behavior\*

Domonkos F. Vamossy<sup>†</sup>      Rolf Skog

December 8, 2021

## Abstract

We develop a tool that extracts emotions from social media text data. Our methodology has three main advantages. First, it is tailored for financial context; second, it incorporates key aspects of social media data, such as non-standard phrases, emojis and emoticons; and third, it operates by sequentially learning a latent representation that includes features such as word order, word usage, and local context. This tool, along with a user guide is available at: <https://github.com/dvamossy/EmTract>. Using EmTract, we explore the relationship between investor emotions expressed on social media and asset prices. We document a number of interesting insights. First, we confirm some of the findings of controlled laboratory experiments relating investor emotions to asset price movements. Second, we show that investor emotions are predictive of daily price movements. These impacts are larger when volatility or short interest are higher, and when institutional ownership or liquidity are lower. Third, increased investor enthusiasm prior to the IPO contributes to the large first-day return and long-run underperformance of IPO stocks. To corroborate our results, we provide a number of robustness checks, including using an alternative emotion model. Our findings reinforce the intuition that emotions and market dynamics are closely related, and highlight the importance of considering investor emotions when assessing a stock's short-term value.

**Keywords:** Deep Learning; Investor Emotions; Text Analysis; Social Media; Return Predictability.

**JEL Codes:** G41; L82.

---

\*I am extremely grateful to Stefania Albanesi, Lee Dokyun, Sera Linardi, and Zhi Da for their continued guidance and support throughout this project. Special thanks to StockTwits for sharing their data. This research was supported in part by the University of Pittsburgh Center for Research Computing through the resources provided.

<sup>†</sup>Department of Economics, University of Pittsburgh, [d.vamossy@pitt.edu](mailto:d.vamossy@pitt.edu).

# 1 Introduction

The connection between financial markets and emotions is well-known in investment circles. Most have heard the famous adage from Warren Buffett: “Be fearful when others are greedy, and greedy when others are fearful”. Similarly, Christopher Blum, as chief investment officer of the U.S. Behavioral Finance Group at J.P. Morgan Fund, said that “Humans are emotional individuals, and that gets exaggerated when it comes to taking risks. . . These are errors that investors make, we try to exploit anomalies in valuations and momentum.”

This relationship has not eluded academics. For instance, Galbraith [1994] describes stock market bubbles as “speculative euphoria”, while former Federal Reserve chairman Alan Greenspan famously remarked that the U.S. stock market exhibited an “irrational exuberance” when it experienced a rapid run-up in 1996. This observation portrayed a belief on his part that the increase originated in traders’ positive emotions. In contrast, fear is cited as a force leading to sell-offs, price declines, and price variability. Market volatility indices, such as the CBOE’s VIX, are often referenced as “fear” indices.

Journalists have also written articles such as “‘Gut Feelings’ Are Driving the Markets” or “How Emotion Hurts Stock Returns” (e.g., Shiller [2020] and Wolfers [2015]); or as Michelle Perry put it:

What defeats investors more than anything is psychology. Specifically, they can be undone by the emotional ups and downs that accompany the ups and downs of the market. For investors, it’s crucial that they understand how closely their emotions track the market, and how such emotions often lead them to do precisely the wrong thing. . . (Michelle Perry Higgins, WSJ, 1999)

The claims are there, yet empirical evidence is still lacking; partly driven by the lack of methodology to extract direct, firm-level proxies of investor emotions. This paper is intended to provide that. We then test the connection between firm-specific investor emotions and asset price movements. Specifically, we explore the following research questions: (1) Do the

results of controlled laboratory experiments relating investor emotions to trading behavior replicate with observational data?; (2) Do investor emotions forecast daily price movements?; (3) Whose emotions matter and for what type of firms?; and (4) Do investor emotions help explain first day IPO returns and subsequent long-run under-performance? Only recently has academic literature begun exploring the role emotions play in capital markets. Due to data difficulties regarding the measurement of investor emotions, studies mainly relied on indirect proxies, or were limited to experimental evidence. By pairing a large, novel dataset with recent advances in text processing, we are able to overcome the data challenge inherent in studying investor emotions.

To get to our answer, we use data from StockTwits, a social networking platform for investors to share stock opinions. A critical feature of this data is that it contains firm-specific messages, so we are able to compute firm-specific emotions. We employ a broad sample of over 63 million messages that span 2010 - 2021 May.

Our first and main contribution is that we develop a simple tool that quantifies investor emotions from financial social media text data (i.e., informal text containing less than 30 words). Our models are powered by deep learning and a large, novel dataset of investor messages.<sup>1</sup> In particular, our tool takes social media text as inputs, and for each message it constructs emotion variables corresponding to seven emotional states: neutral, happy, sad, anger, disgust, surprise, fear.<sup>2</sup> Our emotion variables are probabilistic measures, and hence the seven emotions sum up to 1. As an illustration, if the user supplies a file with the message "dump it", the tool returns "dump it" and the corresponding emotion probabilities, which is fear 100% and 0% for all other emotions in this case.

Using our tool, we can then test whether firm-specific investor emotions before the market opens predict a firm's daily price movements. To do so, we first use our tool generate

---

<sup>1</sup>For other applications of deep learning in economics see Albanesi and Vamossy [2019], Vamossy [2020], and LaVoice and Vamossy [2019]. For reviews of machine learning applications in economics, see Mulainathan and Spiess [2017] and Athey and Imbens [2019].

<sup>2</sup>The emotions in this paper correspond to the seven emotional states specified in Breaban and Noussair [2018]. We provide a detailed description of our classification schemes in the Appendix B.

emotion variables by quantifying the content of each message using textual analysis and then average the textual analysis results across all messages by firm-day-market open/close. In addition to measuring the emotional content, we also distinguish between different types of messages by employing two classification schemes. The first one isolates messages conveying information related to earnings, firm fundamentals, or stock trading from general chat. The second separates messages conveying original information from those disseminating existing information. Once the emotion variables are constructed, we then use a fixed effects model, exploiting within-firm variation in investor emotions, to test whether emotions predict a firm's daily price movements. Using within-firm variation shuts down some mechanisms. For instance, if a firm tends to have high returns, investors might always be more excited before the market opens, but including fixed effect means we can rule out that our results are driven by this. We also control for calendar day fixed effects to reject that our results are only driven by factors which effect emotions and returns across all firms simultaneously. We take a number of steps to mitigate additional estimation concerns. For instance, we rule out reactive emotions by looking at the impact of the pre-market emotions (those posted between 4:00pm the previous trading day (i.e.,  $t - 1$ ) and 9:29AM the day of (i.e.,  $t$ ) on daily trading behavior so that we have a clear temporal separation between the independent and dependent variables. We also tackle misattribution - the concern that our emotion measures are not capturing emotions correctly - by training an additional emotion model for robustness checks and by investigating the impacts of contemporaneous emotions and asset prices. We find that our algorithm classifies messages happier for assets that have gone up in value, and our results hold even with the alternative emotion model.

Our analysis focuses on the role of investor emotions in explaining daily asset price movements. We document three main findings. First, we confirm some of the findings of controlled laboratory experiments relating investor emotions to asset price movements. In particular, we find that investor emotions extracted from social media data behave similarly as in lab experiments, and hence, we provide external validity for previous controlled lab-

oratory experiments. Second, we document that within-firm investor emotions can predict the company’s daily price movements. For instance, one of our findings is that variation in investor enthusiasm is linked with marginally higher daily returns. We show that this result is driven both by messages conveying original information and by those disseminating existing ones. When considering messages that convey information directly related to earnings, firm fundamentals, or stock trading relative to those messages which consist of other information, we find that the latter has a slightly larger impact on daily returns. To corroborate the relation between daily price movements and investor emotions, we use alternative emotion variables based on an emotion metadata compiled by other researchers. Our findings remain significant with a comparable point estimate. In addition, we find that the impacts of emotions are larger when volatility or short interest are higher, and when institutional ownership or liquidity are lower. Third, we show that investor enthusiasm is a predictor for first day IPO returns and subsequent long-run underperformance.

This analysis contributes to the literature on behavioral finance in a variety of ways. First, we contribute to papers studying the connection between market behavior and emotional state. Existing research has shown that traders’ moods can lead to price movements at the market level. Unlike our paper, a number of studies have leveraged indirect proxies to infer emotions. For instance, Kamstra et al. [2003] observe that returns are relatively low in the darker seasons of fall and winter, an outcome they presume is the result of the effect that weather has on mood.<sup>3</sup> Studies relying on indirect proxies have limitations. For instance, Jacobsen and Marquering [2008] suggest that the findings reported in Kamstra et al. [2003] may be explained by a number of other factors related to the season (they illustrate with ice cream consumption and airline travel), thus questioning their conclusion that changes in investors’ moods associated with the Seasonal Affective Disorder (SAD) directly influence stock market returns. By measuring emotions in social media posts directly related to a stock listing, we alleviate the concern that the emotions measure is unrelated to the firm. Similar

---

<sup>3</sup>Similarly, Hirshleifer and Shumway [2003] find that good weather is correlated with higher stock returns, and appeal to a similar intuition to explain their results.

research using direct proxies have been limited to examining the relationship between investor emotions at the market level and daily index returns.<sup>4</sup> Bollen et al. [2011] find that Twitter mood predicts subsequent stock market movements, while Gilbert and Karahalios [2010] find that the level of anxiety of posts on the blog site Live Journal predicts price declines. Accordingly, we add to this literature by showing that firm-specific investor emotions predict firms' daily price movements.

The relationship between market behavior and emotional state has also been studied in controlled laboratory experiments. These papers explored the role of emotions in generating bubbles in experimental asset markets. For instance, Breaban and Noussair [2018] measures emotions using traders' facial expressions and find that positive emotion is linked to higher prices and larger bubbles, while traders' fear before the market opens is associated with lower prices. Similarly, Andrade et al. [2016] document larger bubbles when induced investor enthusiasm is higher. We contribute to this literature by showing that emotions captured by investor messages on a social media platform behave similarly to emotions in the lab. Specifically, we confirm some of the main findings of controlled laboratory experiments relating investor emotions to asset price movements.

Another contribution of this paper is to literature studying the role social media plays in capital markets.<sup>5,6</sup> These studies have investigated whether social media content can

---

<sup>4</sup>To our knowledge, only Li et al. [2016] firm-specific emotions, but in a correlational study with a significantly smaller sample.

<sup>5</sup>The importance of social media is voiced in studies exploring how companies exploit this channel as a means for investor communication. For instance, Blankespoor et al. [2014] show that firms can reduce information asymmetry among investors by broadly disseminating their news, including press releases and other disclosures, to market participants using Twitter. Jung et al. [2018] find that roughly half of S&P 1500 firms have created a corporate presence on either Facebook or Twitter.

<sup>6</sup>Adding to the literature on StockTwits and Twitter is research that has examined investors' use of Internet search engines, financial websites, forums, and other social media platforms. This research has provided mixed evidence on whether this information helps predict future earnings and stock returns. Using Google search volume as a proxy for investors' demand for financial information, Da et al. [2011] find that increased Google searches predict higher stock prices in the near-term followed by a price reversal within a year. Drake et al. [2012] show that the returns-earnings relation is smaller when Google search volume before earnings announcements is high. Antweiler and Frank [2004] and Das and Chen [2007] both find that the volume of posts on message boards, such as Yahoo! or Raging Bull, is associated with stock return volatility, but not stock returns. Chen et al. [2014] demonstrate that information in user-generated research reports on the Seeking Alpha investing portal helps predict earnings and long-window stock returns following the report posting date.

predict the overall movement of the stock market. For instance, Mao et al. [2012] find that the daily number of tweets that mention S&P 500 stocks is significantly associated with the changes in that same index. This literature has also analyzed how Twitter and/or StockTwits activity influences investor response to earnings. Curtis et al. [2014] find that high levels of activity correlate with greater sensitivity to earnings announcement returns and earnings surprises, while low levels of social media activity are associated with significant post-earnings-announcement drift. Cookson and Niessner [2020] show that even though it is unlikely that investor trades from those on StockTwits move the market, disagreement measured by these messages robustly forecasts abnormal trading volume. We add to this research by showing that emotions extracted from social media can help predict a firm’s first day IPO returns and subsequent long-run underperformance.

The remainder of the paper is organized as follows. Section 2 describes the data; Section 3 outlines our text analysis, Section 4 presents our primary results; Section 5 explores heterogeneous effects and conducts a sensitivity analysis. Section 6 concludes.

## **2 Data**

### **2.1 Data Sources**

#### **2.1.1 Social Media Data (StockTwits)**

Our investor emotion dataset comes from StockTwits, which was founded in 2008 as a social networking platform for investors to share stock opinions. StockTwits looks similar to Twitter, where users post messages of up to 140 characters (280 characters since late 2019), and use “cashtags” with the stock ticker symbol (e.g., \$AMZN) to link ideas to a particular company. Although the app does not directly integrate with other social media platforms, participants can share content to their personal Twitter, LinkedIn, and Facebook accounts.

Our original dataset’s range falls between 1 January, 2010 and 31 May, 2021. In total,

there are 164M messages. For each message, we observe sentiment indicators as tagged by the user (bullish, bearish, or unclassified), sentiment score as computed by StockTwits, “cashtags” that connect the message to particular stocks, like count, and a user identifier. The user identifier allows us to explore characteristics of the user, such as follower count. For most users, we also have information on self-reported investment philosophy that can vary along two dimensions: (1) Approach - technical, fundamental, momentum, value, growth, and global macro; or (2) Holding Period - day trader, swing trader, position trader, and long term investor.<sup>7</sup> Users of the platform also provide their experience level as either novice, intermediate, or professional. Leveraging textual analysis, we also distinguish between female and male authored accounts. This user-specific information about the style, experience, type and investment model employed is useful to explore heterogeneity in investor emotions.

Table 1: Itemized Sample Restrictions

	Messages
StockTwits Data 2010-2021*	164,016,572
Keep	
Single Ticker	147,998,736
Not Automated	138,583,490
At Least 20 Messages during Non-Market/Market Hours	109,939,198
Active, Common Ordinary Shares, Traded on US Exchanges**	63,304,804
Final Pre-Market (4pm-9am) Sample	26,165,247
Final Market (9am-4pm) Sample	37,131,297

\*Sample starts January 1st 2010 and runs till May 31st 2021. \*\*We filter out stocks for which the security status (SECSTAT is “I”) is inactive and restrict our sample to common ordinary shares (TPCI is “0”) traded on US exchanges (EXCHG is 11, 12, 14, or 17).

We remove messages that appear automated.<sup>8</sup> We focus on messages that can be directly

<sup>7</sup>We group technical with momentum and value with fundamental for our heterogeneity explorations. For investment horizon, we explore day traders and long term investors.

<sup>8</sup>We define automated messages as messages posted over 1,000 times by the same user over the period 2010-2021.



linked to particular stocks, so we restrict attention to messages that only mention one ticker. Next, we require at least twenty posts per stock per session (market and non-market) to discard noisy signals. Last, we filter out inactive tickers based on SECSTAT, and restrict our analysis to common ordinary shares, traded on U.S. exchanges. We summarize our sample restrictions in Table 1. We end up with 63M messages authored by 734,574 users, covering 3,476 tickers.

We plot the average word count per messages over time in Figure 1, displaying a relatively stable trend with a spike in late 2019. This spike is due the character limit extension from 140 characters to 280 characters. The average post length peaks at 18, and 94% of our messages contain 30 or less words. Since we use the first 30 words to extract the emotion from messages, this likely does not affect the estimation.

Figure 2 portrays the number of messages over time in our data, indicating substantial growth in the early years, plateauing around 2017, followed by a surge in 2020. We control for the growing nature of our sample and the changing nature of our posts by including time fixed effects in our analysis.

We also explore when investors post the messages. In particular, we examine whether they post messages concurrently with daily news so that it reflects hour-by-hour changes in beliefs, or in the evening after work, when they have more free time and then it is more of a reflective general analysis. In Panels (a) and (b) of Figure 3 we plot the distribution of messages by the day of the week and by the hour of the day respectively. We can clearly see that most posting activity on the platform happens when the markets are open (Monday-Friday and between 9am and 4pm). This behavior is consistent with investors updating their beliefs in real time as financial events unfold.

### **2.1.2 Short Interest, Institutional Ownership, Pricing and IPO Data**

We collect all IPOs of common stocks completed between January 2010 and May 2021 in the United States directly from NASDAQ's website. This data contains the date of the

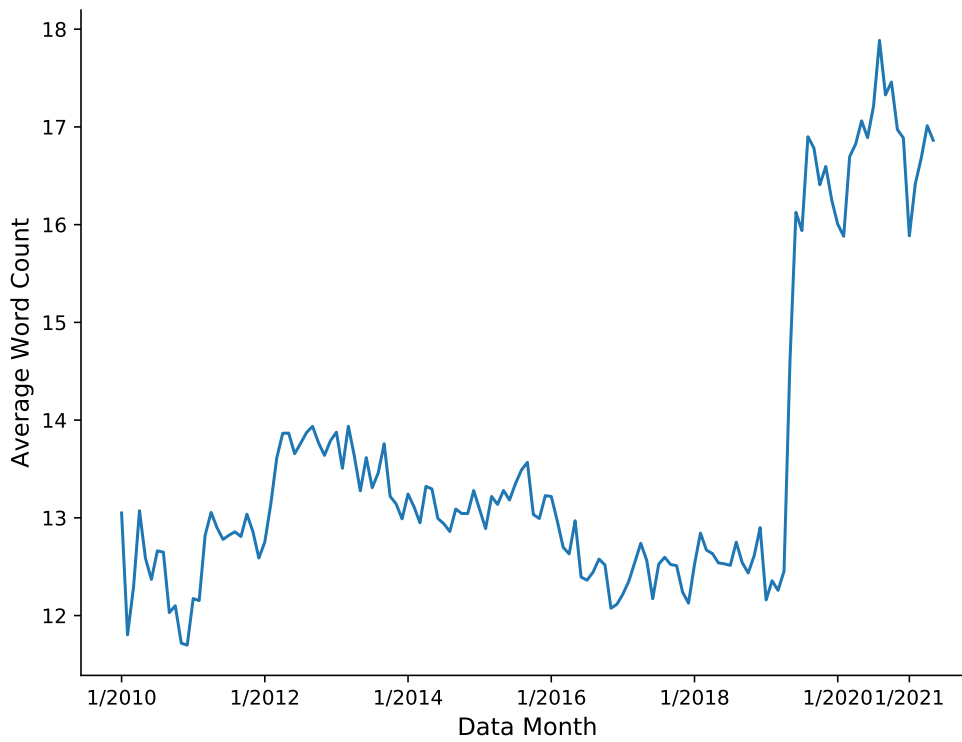

Figure 1: Time Series of Average Post Length

Notes: Similarly to Twitter, StockTwits introduced longer messages in late 2019 (280 characters).

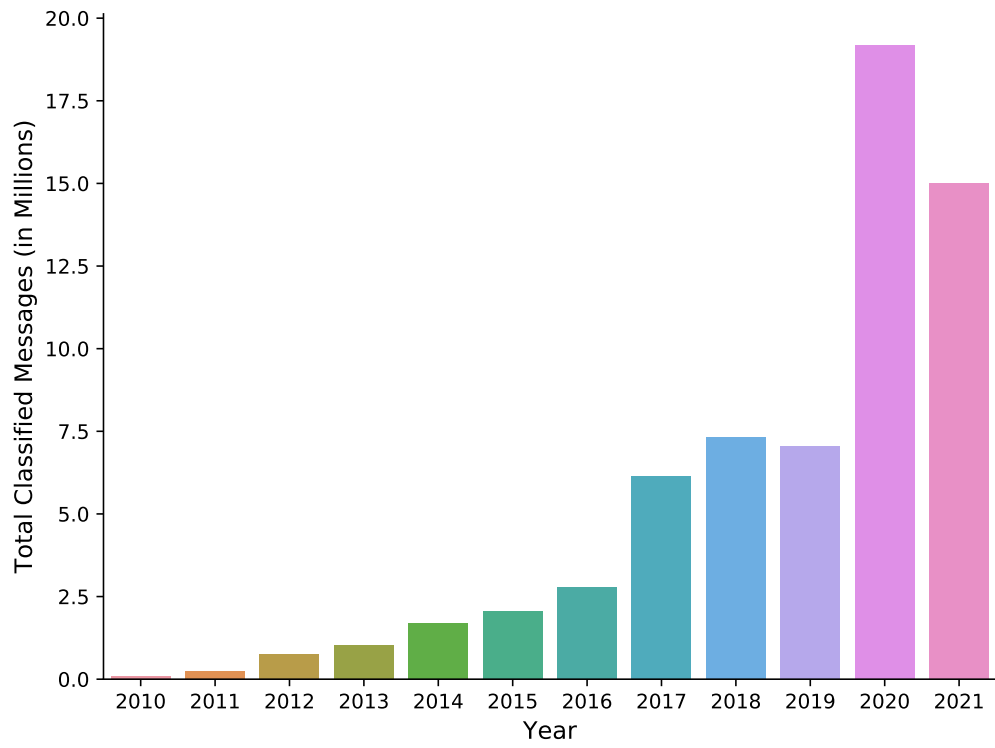
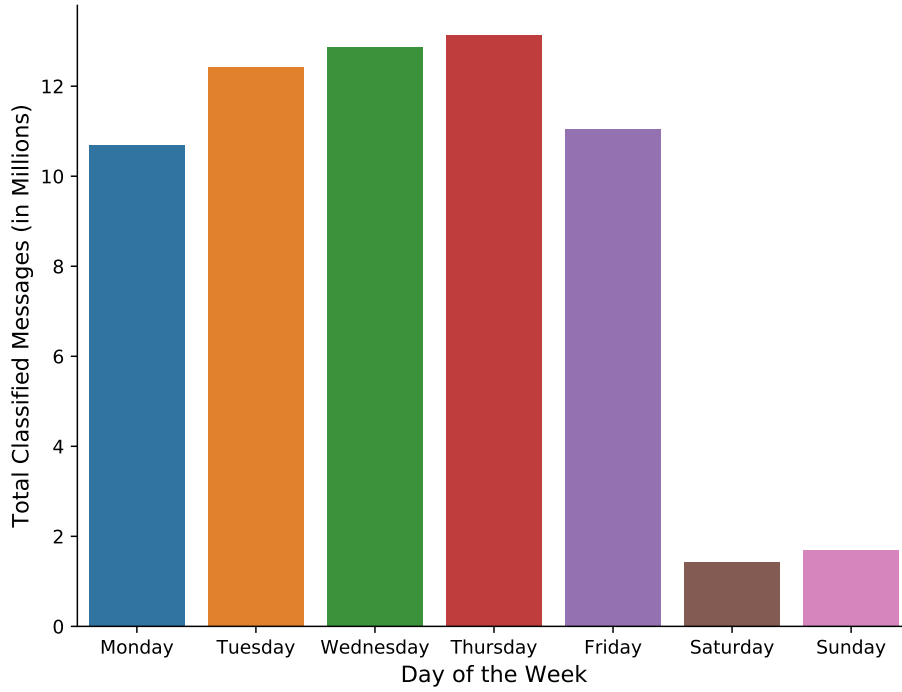
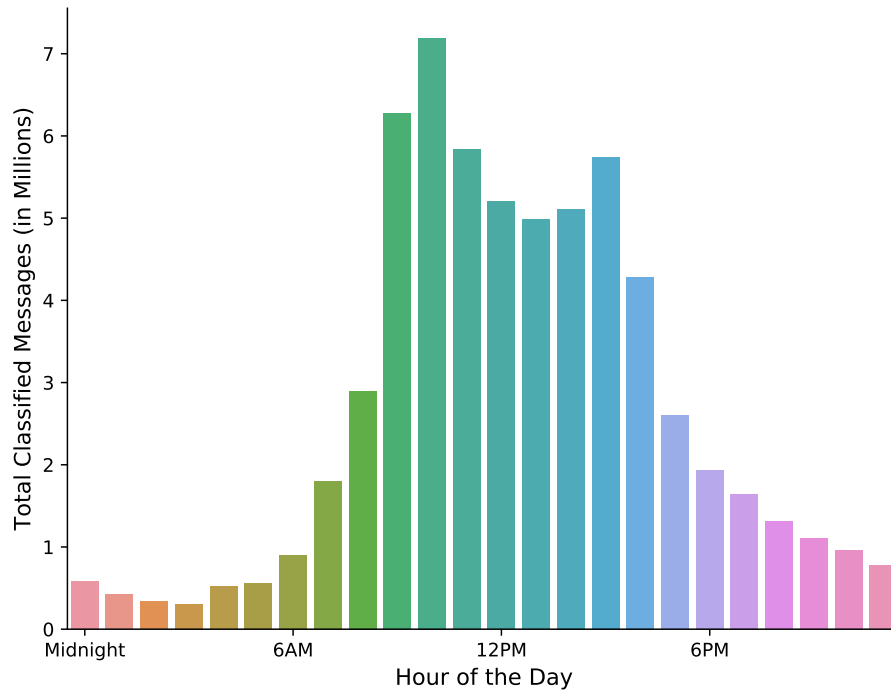

Figure 2: StockTwits Messages Over Time

Notes: Includes our final pre-market and market sample.



(a)



(b)

Figure 3: Distribution of Messages

Notes: Includes our final pre-market and market sample. Panel (a) portrays the day-of-the-week, while Panel (b) depicts the hour-of-the-day distribution of messages.

IPO, the ticker, the IPO price, and the total offer amount. Other variables are constructed from standard data sources. Price and volume related variables are obtained from the merged CRSP/COMPUSTAT file, short interest from Compustat’s Supplemental Short Interest File, and institutional ownership from Thomson-Reuters Institutional Holdings (13f). We match these with StockTwits, Robinhood, and IPO data on ticker and date.

## 2.2 Descriptive Statistics

Table 2 presents the descriptive statistics for the analysis variables. We report the mean, the standard deviation (in parentheses), and the within-firm standard deviation [in brackets]. Panel A reports summary statistics for our social media based variables. We find a high fraction of neutral messages, with a mean of 41.7%, followed by 31.4% of happy posts. Looking at the emotion variables, we observe a positive skewness. This might suggest a “good-news” bias in twits, following from investors being more likely to share their enthusiasm on social media than pessimism. Fear and surprise are the third and fourth most frequent emotions, followed by sad, anger, then disgust. Similarly to our return variables, the within-firm standard deviation is only slightly smaller than the sample standard deviation for our emotion variables. Hence, there is plenty of variation for us to exploit even with a firm-date fixed effect framework.

To help with interpreting the magnitude of our other variables, we contrast our final estimation sample with a CRSP/Compustat sample covering the same time period, following the same sample restrictions (i.e., active, common ordinary shares traded on U.S. exchanges). Panel B of Table 2 presents the results. We observe a few interesting patterns. First, StockTwits users tend to discuss stocks that have gone up or are currently going up in value: the average past monthly return is 6 percentage points, the close-open return is 0.5 percentage point, the one-day lag open-close return is 0.1 percentage point higher than in the CRSP sample. Second, these stocks end up with a 0.4 percentage point lower open-close return, possibly suggesting mean-reversion. We also find that social media investors are

more interested in discussing firms with higher \$ trading volume, volatility, market cap, and short interest, and with lower institutional ownership and past returns.

Next, we report summary statistics for our IPO sample in Table 3. The proportion of neutral messages is significantly higher in this sample, partly driven by messages providing information about the upcoming IPO. In line with stylized facts about IPO returns, we document high average first day returns (23.7%), and negative industry adjusted returns (i.e., long-run underperformance).

Table 4 presents pairwise correlation coefficients among our analysis variables. The variables include our StockTwits based emotion measures, daily return, and our main control variables, lag open-close return, close-open return, past 20 days trading return, and volatility in the past 183 days. Investor enthusiasm, surprise and neutral show statistically significant correlations with our dependent variable, daily returns. This may be viewed as prima facie evidence of the predictive ability of aggregate emotions from individual posts regarding the firm's daily price movements. In addition, the relatively small pairwise correlation coefficients among our control variables indicate that there is little evidence of a multi-collinearity in our data.<sup>9</sup>

---

<sup>9</sup>We explored using more control variables, however \$ Volume, Market Cap were highly correlated with Volatility. We excluded them to avoid multi-collinearity. We did not include short interest, retail interest, and institutional ownership in our main specifications, since they would have restricted our sample size significantly. Nonetheless, we explore them separately in Table 10.

Table 2: Summary Statistics

	CRSP/Compustat-StockTwits	CRSP/Compustat	Difference
<b>Panel A: Social Media Information</b>			
Happy	0.314 (0.125) [0.0972]		
Sad	0.046 (0.0368) [0.0349]		
Fear	0.081 (0.0557) [0.0516]		
Disgust	0.031 (0.0332) [0.0299]		
Anger	0.037 (0.0324) [0.0298]		
Surprise	0.074 (0.0466) [0.0425]		
Neutral	0.417 (0.153) [0.119]		
<b>Panel B: Financial Information</b>			
Open-Close Return	-0.004 (0.0578) [0.0544]	0.000 (0.031)	-0.004***
Close-Open Return	0.006 (0.0512)[0.0483]	0.001 (0.021)	0.005***
Open-Close Return <sub>-1</sub>	0.001 (0.0624) [0.0588]	0.000 (0.031)	0.001***
Return <sub>-20,-1</sub>	0.073 (0.354) [0.311]	0.012 (0.154)	0.06***
\$ Volume <sub>-183,-1</sub>	17.333 (2.731) [1.027]	15.241 (2.756)	2.093***
Volatility <sub>-183,-1</sub>	0.043 (0.0231) [0.00983]	0.026 (0.017)	0.017***
Market Cap <sub>-1</sub>	21.494 (2.760) [0.987]	20.7678 (2.073)	0.727***
Institutional Ownership	0.467 (0.319) [0.0969]	0.602 (0.318)	-0.135***
Short Interest	0.084 (0.0903) [0.0504]	0.042 (0.053)	0.042***
Observations	207,838	9,826,722	10,034,560

Notes: \$ Volume and Market capitalization are in logs. Institutional Ownership, Short Interest, Return, and Volatility are in units. Close-Open Return refers to the return between closing price at  $t - 1$  to the opening price at  $t$ . \*  $p < 0.10$ , \*\*  $p < 0.05$ , \*\*\*  $p < 0.01$ . Standard deviations in parentheses, within-firm standard deviation in brackets for our CRSP/Compustat-StockTwits sample only (we remove firm and date fixed effects to help interpret effect sizes).

Table 3: Summary Statistics: IPO Sample

	CRSP/Compustat-StockTwits/Nasdaq
<b>Panel A: Social Media Information</b>	
Happy	0.168 (0.173)
Sad	0.023 (0.0393)
Fear	0.037 (0.0782)
Disgust	0.018 (0.0514)
Anger	0.026 (0.0462)
Surprise	0.038 (0.0574)
<b>Panel B: IPO &amp; Financial Information</b>	
Return <sub>91,252</sub>	0.089 (0.687)
Industry Adjusted Return <sub>91,252</sub>	-0.011 (0.627)
Offer Amount	401.182 (1192.5)
IPO Shares	17.857 (35.73)
First Day Return	0.237 (0.364)
IPO Price	17.570 (10.36)
Observations	528

Notes: Offer Amount and IPO Shares in millions. Standard deviations in parentheses. Emotions from 30 days before the IPO date up till 9.29AM of the IPO date; firms with at least two messages.



Table 4: Correlation Matrix

	Happy	Sad	Fear	Disgust	Anger	Surprise	Neutral	Return <sub>oc</sub>	Return <sub>oc,-1</sub>	Return <sub>co</sub>	Return <sub>-20,-1</sub>
Happy											
Sad	-0.16***										
Fear	-0.16***	0.17***									
Disgust	-0.16***	0.20***	0.14***								
Anger	-0.16***	0.21***	0.14***	0.26***							
Surprise	0.13***	0.08***	0.04***	0.04***	0.03***						
Neutral	-0.69***	-0.28***	-0.35***	-0.25***	-0.25***	-0.46***					
Return <sub>oc</sub>	-0.02***	0.00	0.00	-0.00	0.01	-0.01**	0.01***				
Return <sub>oc,-1</sub>	0.11***	-0.13***	-0.08***	-0.09***	-0.07***	-0.07***	0.02***	-0.04***			
Return <sub>co</sub>	0.11***	-0.15***	-0.10***	-0.09***	-0.09***	-0.06***	0.04***	-0.09***	0.05***		
Return <sub>-20,-1</sub>	0.13***	-0.09***	-0.02***	-0.06***	-0.04***	-0.01***	-0.05***	-0.03***	0.20***	0.00	
Volatility <sub>-183,-1</sub>	0.37***	-0.03***	-0.04***	0.03***	0.04***	0.18***	-0.35***	-0.05***	0.03***	0.06***	0.19***
Observations	207,838										

Notes: Pairwise correlation with Bonferroni corrections. Continuous variables winsorized at the 0.1% and 99.9% levels.  $t$  statistics in parentheses. \*  $p < 0.05$ , \*\*  $p < 0.01$ , \*\*\*  $p < 0.001$ . Return<sub>co</sub> refers to return between the closing price at  $t - 1$  and the opening price at  $t$ . Return<sub>oc</sub> refers to the open-close return.

## 3 Text Analysis

We now briefly describe the text analysis methodologies used in this paper. For an in-depth discussion, see Appendix B.1, B, and B.5.

### 3.1 Messages as Indicators for Emotion

In order for our emotion measure to be useful, it must reveal the true state of investors. Thus, before using the data, we must rule out that users are trying to manipulate the stock market by posting fake opinions. For instance, if a user believes the stock price will go down and thus wants to sell the stock, they could post positive messages that might increase the price temporarily and thus would allow them to sell at a higher price. This would invalidate our measure, as we would capture their emotion as happy, even though their current emotional state might not be. This does not, though, seem to be an important concern in our data for a number of reasons. First, there is anecdotal evidence that users post on platforms to attract followers, gain internet fame, or find employment. In all those cases, it is incentive compatible for them to provide their honest opinion about the stock. Second, we also investigate the pricing impacts concerning S&P 500 firms, which have large market caps that make it unlikely that individual investors could move prices.

### 3.2 Measuring Emotion

The primary challenge underlying our research design is the estimation of emotion. To overcome this, we use text analysis to quantify the emotion expressed in investor messages. We leverage a large set of emojis and emoticons, along with emotionally charged words to generate a dataset of investor messages with their corresponding emotions. We then use a standard bi-directional GRU model with word embeddings (see Chung et al. [2014]) to obtain a probabilistic assessment for each message in the data. See Table B.5 for examples.

### 3.3 Measuring Information Content

To further explore the channels whereby emotions operate, we also compute the emotional state of messages separately as they relate to fundamental and/or stock price information (“finance”) or whether they look like general social media chat (“chat”). We provide examples of messages and their predicted emotion probabilities for a set of “fundamental” and “chat” posts in Table B.5.

We also distinguish between messages by whether they provide original information (“original”) or they disseminate existing ones (“dissemination”). A message is considered original if (1) it is not a retweet of another user’s message and (2) it does not include a hyperlink.

### 3.4 Validation

We now validate our emotion measures using the shutdown of meme-stock trading on January 28th, 2021. We included this exercise to show that our NLP model is capturing emotions in a way that is intuitive. As Matt Levine of Bloomberg put it:

Yesterday many big retail brokerage firms told their customers that they would no longer be able to buy GameStop Corp. stock because it was getting too crazy. This led to a lot of outrage from people who are famous and online:

Among others rebuking the moves by the brokerages were Rep. Alexandria Ocasio-Cortez (D., N.Y.), Sen. Ted Cruz (R., Texas), billionaire Mark Cuban and Dave Portnoy, the founder of the popular digital media company Barstool Sports Inc. Mr. Portnoy was one of countless individual investors who dove into the markets this year, often streaming his trades to his followers on Twitter.

Ms. Ocasio-Cortez tweeted: “We now need to know more about @RobinhoodApp’s decision to block retail investors from purchasing

stock while hedge funds are freely able to trade the stock as they see fit.”

The popular story here is that small-time retail investors, who stereotypically trade stock on the Robinhood app and egg each other on in the WallStreetBets Reddit forum, have been pushing up the stock of GameStop for a few weeks, and they got it to pretty dizzying heights: GameStop started the year at \$18.84 per share; at one point yesterday morning it traded at \$483, up almost 2,500%. They are doing this partly for fun and partly for profit but also, especially, to mess with the hedge funds on the other side of the trade, who had bet against GameStop by shorting the stock and who suffered and surrendered as it went up ...

Given the circumstances of this event, we expect to see increased levels of emotions with negative valence, particularly disgust and anger, expressed on social media regarding “meme” stocks on January 28th, 2021, and shortly after. On Figure 4, we plot daily closing prices and selected emotions for two of the most important meme stocks, AMC and GME from January 4th, 2021 until March 1st 2021. Black dotted lines correspond to daily closing prices, colored lines represent daily aggregate emotions, while thick and colored dotted lines represent the 20 trading day average for the selected emotion.

Prior to the trading shut-down, the level of anger and disgust was comparable to the sample average, while the level of happiness was, unsurprisingly, higher as these stock were surging. As the trading restriction came, the level of happiness dropped, and posts containing angry and disgusted content skyrocketed. For instance, the daily posts containing angry content soared from 3% to slightly over 10% for AMC on January 28th, an approximately 2.3 standard deviation increase. Once the restrictions were lifted, the level of anger and disgust slowly decreased, but remained at elevated levels. The “system is rigged” echoed for a while after the shut-down.

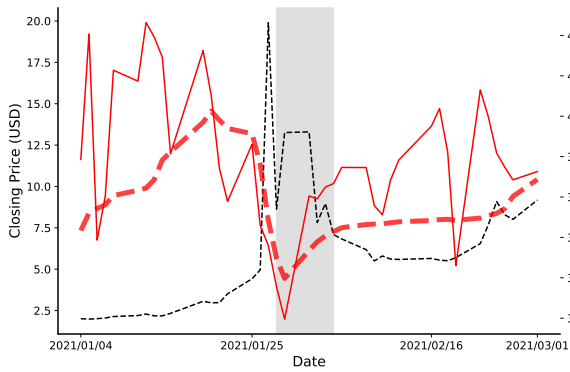

(a) AMC: Happy

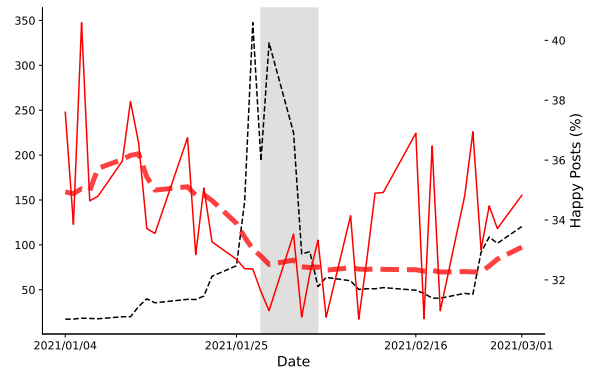

(b) GME: Happy

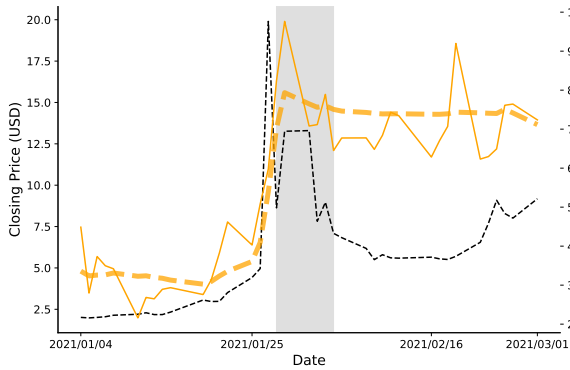

(c) AMC: Anger

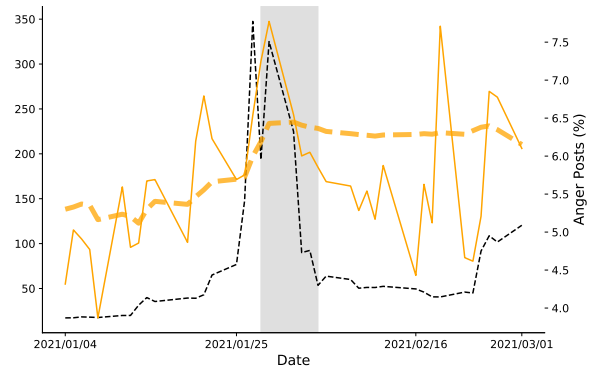

(d) GME: Anger

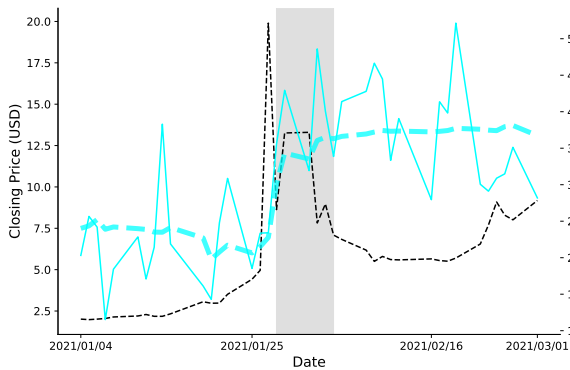

(e) AMC: Disgust

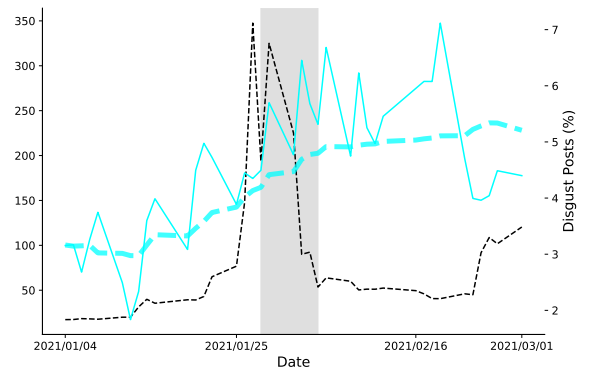

(f) GME: Disgust

Figure 4: Firm-Specific Investor Emotions for Selected Meme Stocks

Notes: Relationship between daily closing price and firm-specific emotions during market hours. Grey area corresponds to the dates during which Robinhood restricted trading for a number of “meme” stocks. Dotted lines correspond to closing prices; solid lines correspond to emotions; dotted solid lines correspond to the 20 trading day average emotion. These patterns are comparable for other “meme” stocks. For a full list of stock restrictions, click [here](#). Source: Authors’ calculations based on StockTwits & CRSP data.

## 4 Primary Findings

As seen from Figure 4, emotions can vary considerably over time. How do such changes in emotion affect stock returns? This is the question that we examine in this section. We expect investor enthusiasm resulting in increased buying pressure to subsequently push up stock prices temporarily. We first examine such price pressure in the context of daily price movements, then with IPOs. Given the lack of trading data prior to the IPO, our emotion measures offer a unique opportunity to empirically study the impact of investor emotions on IPO returns.

Before presenting our main results, we would like to point out that we do not establish a causal link between social media emotions and asset price movements. Our main goal is to provide a tool that extracts investor emotions from social media data, tailored for financial contexts. We use this tool for illustrative purposes. The key take-away is that investor emotions extracted from social media contain information relevant to stock valuation not accounted by unobservable time-invariant stock characteristics, by time patterns or by recent price movements. In addition, we lend credibility to the lessons learned from controlled laboratory experiments studying the role investor emotions play in explaining trading behavior; and provide empirical evidence for a theory on two stylized facts about IPO returns.

### 4.1 Empirical Framework

Our return regressions, excluding the IPO study, exploit within-firm variation. That is, we estimate the following model:

$$Y_{it} = \alpha + \sum_{j=0}^{j=5} \beta_j EMOTION_{jit} + \gamma Y_{i,t-1} + \zeta X_{i,t-1} + \delta_t + \delta_i + \epsilon_{it} \quad (1)$$

where  $EMOTION_{jit}$  is our emotion measure for firm  $i$  at date  $t$  (computed based on messages during non-trading hours, before the market opens). The benchmark group in our regression analysis is neutral, so that  $j \in \{happy, sad, anger, disgust, surprise, fear\}$ . Our

dependent variable for most our analysis is open-close daily return. Our day ( $\delta_t$ ) fixed effects control for important daily news events (or for the daily market return) at the market level, while firm ( $\delta_i$ ) fixed effects shut down some mechanisms. For instance, if a firm tends to have high returns, investors might always be more excited before the market opens, but including firm fixed effects mean we can rule out that our results are driven by this. We account for autocorrelation by controlling for the open-close return on day  $t - 1$ . We include the close-open return (i.e., previous day close to current open), to ensure that our emotions contain incremental information to after-hours and pre-market price movements. Most our specifications also include controls ( $X_{i,t-1}$ ) for past 20 trading days return, volatility as defined in Table A.1. To mitigate the concern that our emotion measure only reflects changes in trading activity, we regress our dependent variable on day  $t$  (i.e., open-close return) on emotion among messages that were posted before the market opened on day  $t$ . In this case, the emotion measure clearly leads the dependent variable in time.

We also refine our analysis by classifying tweets into two categories and computing emotion for each. The first category includes tweets explicitly containing information about a firm’s fundamentals and/or stock price (“finance”), while the second category includes general chat (“chat”). This refinement allows us to cast light on the role of emotions in different information environments. Appendix B outlines in detail the procedures we use to classify tweets into “finance”, and “chat”.<sup>10</sup> The second category distinguishes between messages by whether they provide original information (“original”) or they disseminate existing ones (“dissemination”). A message is considered original if (1) it is not a retweet of another user’s message and (2) it does not include a hyperlink.

## 4.2 Testing Laboratory Experiments

We first investigate whether controlled laboratory experiment findings regarding investor emotions and trading, such as Breaban and Noussair [2018], replicate with our investor

---

<sup>10</sup>It is important to note that our classification heuristics might be subject to a degree of error. Specifically, some of the tweets we classify as “chat” might actually be “finance” related.

emotion data. In particular, we contrast the results of some highly influential lab experiments with ours in Table 5. Though we document relatively low correlation coefficients, we confirm the findings of four lab experiments that relate emotions to trading behavior.

Table 5: Empirical tests of Lab Experiments on Emotions and Asset Pricing

Finding	Source	Dependent Variable	Sample	Test	Result	
<b>Panel A: Directly Testable</b>						
<i>Finding I:</i> Average trader fear before the market opens is negatively correlated with subsequent price movements.	Breaban and Noussair [2018]	Return	Pre-market	$\rho_{y,fear} < 0$	-0.0059***	✓
<i>Finding II:</i> Fear and anger are negatively, while happiness is positively correlated with price movements.	Hargreaves Heap and Zizzo [2011], Breaban and Noussair [2018]	Return	Market	$\rho_{y,fear} < 0$ , $\rho_{y,anger} < 0$ , $\rho_{y,happy} > 0$	-0.1342***, -0.1210***, 0.1755***	✓ ✓ ✓
<b>Panel B: Not Testable</b>						
<i>Finding III:</i> Traders with higher levels of fear (valence) make more (less) loss-averse decisions. <i>Alternative III:</i> Average trader fear (valence) before the market opens is positively (negatively) correlated with the ease of valuation.	Breaban and Noussair [2018]	Market Cap	Pre-market	$\rho_{y,fear} > 0$ , $\rho_{y,valence} < 0$	0.0872***, -0.2130***	✓ ✓
<i>Finding IV:</i> Cash holdings are negatively correlated with fear. <i>Alternative IV:</i> Trading volume is positively correlated with fear.	Breaban and Noussair [2018]	Volume	Market	$\rho_{y,fear} > 0$	0.0319***	✓

Notes: This table investigates whether the findings of controlled laboratory experiments that relate investor emotions to trading behavior replicate with our observational data. \*  $p < 0.10$ , \*\*  $p < 0.05$ , \*\*\*  $p < 0.01$ . Continuous variables winsorized at the 0.1% and 99.9% level. Aside from Finding III, variables are demeaned by firm and date.

### 4.3 Emotions, Information Content, and Returns

We next explore the relationship between investor emotions and daily stock returns with our regression framework. Closest to our setting, lab evidence finds a positive (negative) relationship between pre-market happiness (fear) and returns (Breaban and Noussair [2018]). We evaluate this empirically in Table 6. Column (1) only includes our control variables, firm and date fixed effects. The direct comparison between Column (1) and (2) shows that



emotions before the market opens can explain a small fraction of the variation in daily returns ( $R^2$  increases by 0.05 percentage points). In addition, a standard deviation increase in non-market hour happiness (before the market opens on day  $t$ ) is associated with a 0.7% standard deviation increase in daily stock returns. Column (3) shows that the point estimates of investor emotions are smaller for larger and easier to value firm, i.e., S&P Super Composite firms. We find stronger effects for stocks with larger user engagement (Column (4)), i.e., at least 100 messages, such that a standard deviation increase in happiness before the market opens on day  $t$  is associated with a 3.1% standard deviation increase in daily open-close stock returns. These findings suggest that investor emotions extracted from StockTwits provide information relevant to stock valuation not accounted for by unobservable time-invariant stock characteristics, by time patterns, or by recent price movements.

Table 7 repeats the analysis using measures of emotions disaggregated between messages that convey earnings or trade-related information (“finance”) and messages that provide other information (“chat”) (Column (1) and Column (2)). We find that emotions extracted from messages specifically mentioning firm fundamentals and earnings typically have smaller point estimates for emotions with negative valence. This suggests that there is important information conveyed in seemingly irrelevant messages that we capture with extracting emotions. For instance, a user may post “:) :)” as a reaction to news events or other posts, which clearly expresses her excitement yet do not contain any information about the stock aside from her emotion. Next, contrasting Column (3) and Column (4), we find that both messages containing original information and those disseminating existing information drive our results. Interestingly, when it comes to messages disseminating existing information, only the level of fear and happiness is associated with statistically significant differences from the baseline (neutral) level.

Table 8 explores the impact on pre-market emotions today on returns the following four days. As expected, we find that the predictive power of investor emotions diminishes. In addition, we do find persistent negative impacts for fear.

Table 6: Pre-Market Emotions and Price Movements

	(1)	(2)	(3)	(4)
Happy		0.0039*** (0.0013)	-0.0013 (0.0015)	0.0218*** (0.0070)
Sad		-0.0180*** (0.0034)	-0.0077** (0.0036)	-0.0190 (0.0167)
Fear		-0.0137*** (0.0023)	-0.0017 (0.0022)	-0.0456*** (0.0120)
Disgust		-0.0074* (0.0039)	-0.0018 (0.0042)	-0.0321 (0.0208)
Anger		-0.0001 (0.0038)	-0.0050 (0.0041)	-0.0018 (0.0198)
Surprise		-0.0106*** (0.0028)	-0.0087*** (0.0033)	0.0003 (0.0141)
S&P Super Composite Firms			X	
At least 100 messages				X
$\sigma_{y,within}$	0.0538	0.0538	0.0329	0.0674
Observations	198468	198468	66175	44100
$R^2$	0.1240	0.1245	0.1769	0.1815

Notes: This table considers the relationship between pre-market emotions and daily price movements. The dependent variable is daily returns, computed as the difference between the closing and the opening price, divided by the opening price. All specifications include firm and date fixed effects, close-open returns, lag open-close returns, past 20 trading days return and volatility (as defined in Variable Definitions). Robust standard errors clustered at the industry and date levels are in parentheses. We use the Fama-French 12-industry classification. \*  $p < 0.10$ , \*\*  $p < 0.05$ , \*\*\*  $p < 0.01$ . Continuous variables winsorized at the 0.1% and 99.9% level to mitigate the impact of outliers. We report the within-firm, detrended (demeaned) standard deviation of the dependent variable.

Table 7: Pre-Market Emotions, Message Content and Price Movements

	(1)	(2)	(3)	(4)
	<u>Chat Type</u>		<u>Information Type</u>	
	Chat	Finance	Disseminating	Original
Happy	0.0030*** (0.0012)	0.0033*** (0.0007)	0.0036*** (0.0007)	0.0035*** (0.0010)
Sad	-0.0113*** (0.0031)	-0.0066*** (0.0014)	0.0013 (0.0019)	-0.0143*** (0.0023)
Fear	-0.0116*** (0.0020)	-0.0027* (0.0014)	-0.0024* (0.0013)	-0.0086*** (0.0018)
Surprise	-0.0046* (0.0024)	-0.0028** (0.0012)	0.0018 (0.0014)	-0.0063*** (0.0018)
Disgust	-0.0084** (0.0035)	-0.0021 (0.0018)	0.0003 (0.0022)	-0.0099*** (0.0030)
Anger	-0.0009 (0.0035)	-0.0021 (0.0016)	0.0015 (0.0022)	-0.0080*** (0.0027)
$\sigma_{y,within}$	0.0538	0.0544	0.0538	0.0542
Observations	198466	190395	196287	193970
$R^2$	0.1243	0.1255	0.1243	0.1251

Notes: This table considers the relationship between pre-market emotions disaggregated by information content and information type, and daily price movements. The dependent variable is daily returns, computed as the difference between the closing and the opening price, divided by the opening price. All specifications include firm and date fixed effects, close-open returns, lag open-close returns, past 20 trading days return and volatility (as defined in Variable Definitions). Robust standard errors clustered at the industry and date levels are in parentheses. We use the Fama-French 12-industry classification. \*  $p < 0.10$ , \*\*  $p < 0.05$ , \*\*\*  $p < 0.01$ . Continuous variables winsorized at the 0.1% and 99.9% level to mitigate the impact of outliers. We report the within-firm, detrended (demeaned) standard deviation of the dependent variable.

Table 8: Pre-Market Emotions and Subsequent Price Movements

	(1)	(2)	(3)	(4)
	Ret <sub>t+1</sub>	Ret <sub>t+2</sub>	Ret <sub>t+3</sub>	Ret <sub>t+4</sub>
Happy	0.0011 (0.0012)	0.0032*** (0.0011)	0.0000 (0.0011)	-0.0010 (0.0011)
Sad	-0.0031 (0.0031)	0.0016 (0.0030)	-0.0026 (0.0029)	-0.0025 (0.0030)
Fear	-0.0053** (0.0021)	-0.0049** (0.0020)	-0.0035* (0.0020)	-0.0032* (0.0019)
Disgust	0.0038 (0.0036)	0.0019 (0.0035)	-0.0007 (0.0034)	-0.0032 (0.0035)
Anger	0.0060* (0.0037)	0.0055 (0.0036)	0.0022 (0.0035)	0.0028 (0.0036)
Surprise	-0.0031 (0.0026)	-0.0022 (0.0025)	0.0016 (0.0024)	0.0014 (0.0024)
$\sigma_{y,within}$	0.0484	0.0465	0.0455	0.0450
Observations	198392	198344	198298	198244
$R^2$	0.1250	0.1286	0.1310	0.1265

Notes: This table investigates the predictive power of investor emotions on price movements one to four days into the future. The dependent variable is daily returns, computed as the difference between the closing and the opening price, divided by the opening price at  $t+1$  through  $t+4$ . All specifications include firm and date fixed effects, close-open returns, open-close returns at  $t-1$ , past 20 trading days return and volatility (as defined in Variable Definitions). Robust standard errors clustered at the industry and date levels are in parentheses. We use the Fama-French 12-industry classification. \*  $p < 0.10$ , \*\*  $p < 0.05$ , \*\*\*  $p < 0.01$ . Continuous variables winsorized at the 0.1% and 99.9% level to mitigate the impact of outliers. We report the within-firm, detrended (demeaned) standard deviation of the dependent variable.

## 4.4 Emotions and IPO Pricing

We now explore the mechanism behind two stylized facts about IPO returns. First, IPOs on average have high first-day returns (see Loughran and Ritter [2004]). Second, small-growth IPOs underperform non-IPO seasoned companies. Ljungqvist et al. [2006] hypothesize that the over-enthusiasm of retail investors may drive up an IPO's first-day return, and consequently overpriced IPOs revert to fundamental value which causes long-run underperformance. We take a direct approach to test this conjecture with investor emotions. To address the first part, we explore the relationship between first day IPO returns and investor emotions from thirty days before the IPO date up till 9.29AM of the IPO date. For the second part, we use these emotions and interact them with first day IPO returns to investigate how emotions relate to long-run (under)performance.

First, we illustrate the relation between investor enthusiasm prior to the IPO and the first-day IPO return graphically. Panel A of Figure 5 summarizes the main results. The set of IPOs with low investor enthusiasm prior to the IPO have first-day returns of 16.50% on average while the set of IPOs with high investor enthusiasm have a much higher first-day return of 30.85% on average.

We formalize the analysis using cross-sectional regressions in Table 9. In Column (1), we regress the IPO's first-day return against investor emotions. In Column (2), we also control for other variables that may have predictive power for first-day IPO returns. These variables include the logarithm of offering size, defined as the number of shares offered times the offering price; the industry return from six month prior to the offering to a month prior the IPO; and the Fama-French five factors the day of the IPO. In these two regressions, investor enthusiasm is statistically significant at the 1 percent level. Comparing these two regressions, it is clear that pre-IPO investor enthusiasm plays an important role in determining the first-day IPO return.

Second, we examine the relation between investor enthusiasm prior to the IPO and the long-run performance of the IPO stock. Panel B of Figure 5 summarizes the main findings.

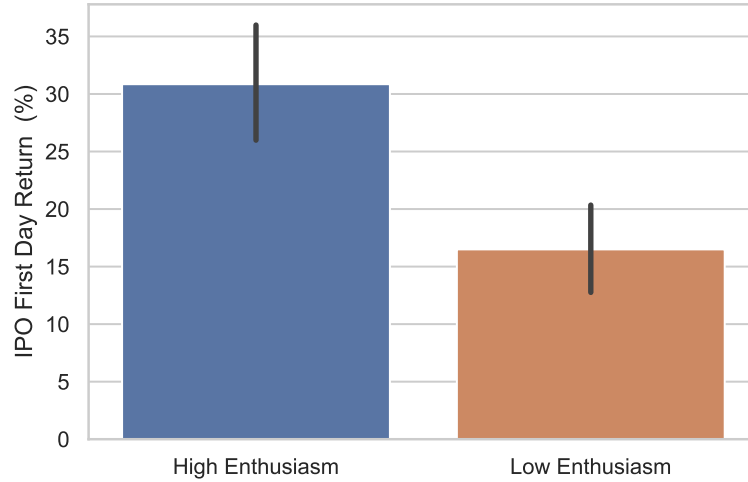

(a) First Day Return

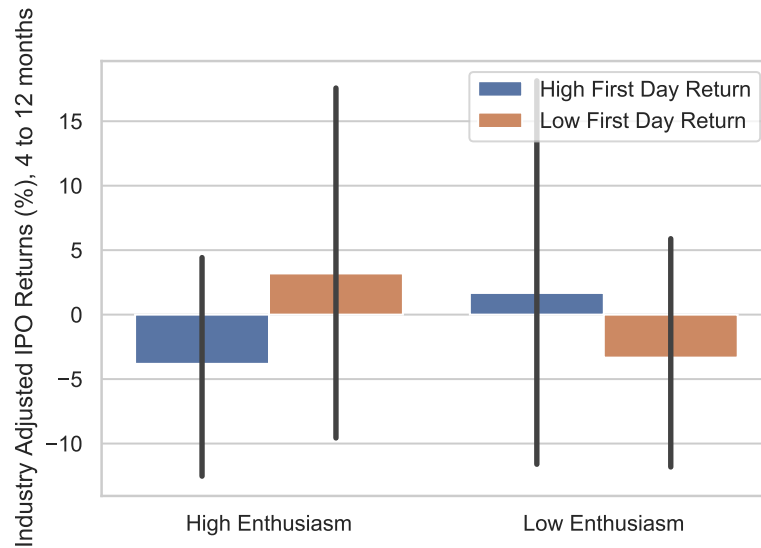

(b) Long-Run Industry Adjusted Return

Figure 5: Firm-Specific Investor Emotions for Selected Meme Stocks

Notes: Panel A plots the pre-IPO investor enthusiasm and average first-day returns. Panel B plots the pre-IPO investor enthusiasm and the Fama-French 48-industry adjusted returns from the fourth month to the twelfth month. There are 528 IPOs with sufficient StockTwits activity for Panel (a), and 509 for Panel (b).

Table 9: Pre-Market Emotions and First Week IPO Returns

	(1)	(2)	(3)	(4)
	First Day Return		Raw Return	Adjusted Return
Happy	0.4133*** (0.1071)	0.3861*** (0.1113)	0.2701 (0.1763)	0.1064 (0.1445)
Sad	0.4832 (0.4551)	0.5338 (0.4383)	1.2191* (0.6451)	0.9015 (0.7332)
Fear	-0.0638 (0.1610)	-0.0858 (0.1604)	-0.1176 (0.2848)	-0.2817 (0.2279)
Surprise	0.0410 (0.2574)	0.0856 (0.2440)	-0.0446 (0.5021)	-0.1018 (0.4176)
Disgust	-0.1088 (0.2630)	-0.0795 (0.3014)	0.5936** (0.2676)	0.2870 (0.2980)
Anger	-0.0716 (0.3215)	-0.0477 (0.3337)	0.1984 (0.3891)	0.4914 (0.4247)
Offer Amount		0.0178 (0.0147)	-0.0041 (0.0224)	-0.0027 (0.0200)
FDR			0.3797* (0.2025)	0.2076 (0.1686)
Happy $\times$ FDR			-0.9937*** (0.3247)	-0.5785** (0.2665)
Sad $\times$ FDR			-0.7231 (1.1896)	-0.3875 (1.2364)
Disgust $\times$ FDR			-4.3743** (1.8127)	-3.7700* (2.0379)
Anger $\times$ FDR			-0.2819 (1.9426)	-0.5161 (1.8106)
Fear $\times$ FDR			-0.6307 (0.6520)	-0.6638 (0.4937)
Surprise $\times$ FDR			-0.5525 (1.6475)	-0.5859 (1.4627)
Constant	0.1607*** (0.0214)	-0.6482** (0.3263)	0.0016 (0.4287)	-0.1068 (0.4119)
Observations	528	528	509	509
$R^2$	0.0414	0.0742	0.0461	0.0372

Notes: This table considers the first day IPO return (Columns (1-2)), the cumulative IPO raw return (Column (3)), and the cumulative IPO return adjusted by the cumulative industry returns (Column (4)), during the first day, and during the fourth to the twelfth month after the initial public offering. The dependent variable in Column (3) is the individual IPO's cumulative return during the [91, 252] trading day window after the initial public offering, while for Column (4) it is adjusted by the cumulative industry return during the same period. Industry returns are based on the Fama-French 48-industry classification. We exclude stocks where the final offering price is below five dollars. First Day Return is computed as the difference between the CRSP/Compustat closing price and the offering price, divided by the offering price. Offer Amount is the logarithm of the offering size, where the offering size is defined as the offering price multiplied by the number of shares offered. Columns (1) only controls for emotions. Columns (2-4) include the IPO Offer Amount, the industry return from six month prior to the offering to a month prior the IPO, and Fama-French 5 Factors during the IPO day. Robust standard errors clustered at the offering year and month are in parentheses. \*  $p < 0.10$ , \*\*  $p < 0.05$ , \*\*\*  $p < 0.01$ .

The figure plots the mean of the industry-adjusted IPO returns, starting at the end of the fourth month after the IPO and ending at the end of the twelfth month after the IPO. We skip the first three months after the IPO due to the market making and price stabilization efforts by lead underwriters in that period (see Ellis et al. [2000]).<sup>11</sup> We divide our IPOs into portfolios based on their investor enthusiasm prior to the IPO and first-day returns. In particular, low enthusiasm IPOs correspond to IPOs with below median investor enthusiasm, while low first-day return corresponds to IPOs with below median first-day-returns. This figure illustrates that IPOs with large first-day returns driven by investor enthusiasm indeed underperform average firms in the same industry over the long run. In contrast, IPOs experiencing large first-day returns without high investor enthusiasm prior to IPO do not experience long-run reversal.

We formalize the analysis using cross-sectional regressions in Column (3-4) of Table 9 where we include additional control variables. We find that neither investor enthusiasm nor first-day Return alone predict long-run IPO underperformance. Interestingly, the interaction between investor enthusiasm and first-day return does. This is consistent with our conjecture that for IPOs with high first-day returns that also experienced high investor enthusiasm, the high first-day returns are partly driven by price pressure and will revert in the long run.

## 5 Additional Findings

The results thus far suggest that investor emotions from social media provide valuable information that can help explain daily price movements. However, this effect is unlikely to be uniform. In this section, we explore heterogeneous effects with respect to stock and user characteristics, and show that our results are robust and capture investor emotions intuitively.

---

<sup>11</sup>We draw similar conclusions if we skip only two months after the IPO.



## 5.1 Heterogeneous Effects: Stock Characteristic

Theory on investor sentiment posits that younger, smaller, more volatile, unprofitable, non-dividend paying, distressed stocks are most sensitive to investor sentiment. Conversely, “bond-like” stocks are less driven by sentiment (see, Baker and Wurgler [2007]).

### 5.1.1 Emotions, Volatility, and Liquidity

To examine whether emotions behave similarly to sentiment, we first interact our emotion variables with a dummy variable intended to capture volatility and liquidity (i.e., market cap, \$ trading volume). In line with theory on investor sentiment, we find larger point estimates for investor enthusiasm (i.e., happy) for more volatile, lower trading volume, and lower market cap firms (Column (2-4) of Table 10).

### 5.1.2 Emotions, Short Interest and Institutional Ownership

We next interact our emotion variables with institutional ownership and short interest. We find larger impacts when short interest is higher and when institutional ownership is lower (Column (5-6) of Table 10).

## 5.2 Heterogeneous Effects: User Characteristic

Hong and Page [2004] show that a diverse group of intelligent decision makers reach reliably better decisions than a less diverse group of individuals with superior skills. We investigate this by segmenting our messages coming from traders with similar investment horizons (i.e., long-term, short-term), trading approaches (i.e., value, technical), trading experiences (i.e., amateur, intermediate, professional), and gender (i.e., men vs. women).

We report heterogeneity across user types in Table 11 and document a few interesting observations. First, in line with the value of diversity hypothesis, we find that the emotions of homogeneous groups are less informative in predicting daily price movements. Second, the

Table 10: Pre-Market Emotions, Stock Characteristics and Price Movements

	(1)	(2)	(3)	(4)	(5)	(6)	
			Interaction Variable				
	None	\$ Volume	Volatility	Market Cap	Short Interest	Institutional	
Happy	0.0042*** (0.0013)	0.0191** (0.0094)	-0.0066*** (0.0023)	0.0261** (0.0102)	0.0050*** (0.0017)	0.0084** (0.0040)	
Sad	-0.0171*** (0.0033)	-0.0406 (0.0262)	-0.0222*** (0.0062)	-0.0763*** (0.0278)	-0.0104** (0.0045)	-0.0156* (0.0091)	
Fear	-0.0136*** (0.0023)	-0.0306 (0.0189)	0.0001 (0.0040)	-0.0512*** (0.0199)	-0.0074** (0.0030)	-0.0119 (0.0073)	
Surprise	-0.0109*** (0.0028)	-0.0058 (0.0209)	-0.0095* (0.0053)	-0.0085 (0.0226)	-0.0045 (0.0037)	-0.0114 (0.0078)	
Disgust	-0.0069* (0.0038)	0.0188 (0.0289)	-0.0032 (0.0073)	-0.0280 (0.0317)	0.0051 (0.0052)	-0.0196* (0.0104)	
Anger	-0.0010 (0.0037)	0.0539* (0.0287)	0.0038 (0.0071)	0.0297 (0.0305)	0.0124** (0.0051)	0.0092 (0.0106)	
Happy $\times$ IV		-0.0009* (0.0005)	0.2465*** (0.0629)	-0.0010** (0.0004)	-0.0167 (0.0139)	-0.0112* (0.0060)	
Sad $\times$ IV		0.0014 (0.0014)	0.0877 (0.1817)	0.0028** (0.0012)	-0.0945*** (0.0343)	-0.0078 (0.0140)	
Disgust $\times$ IV		-0.0016 (0.0016)	-0.1075 (0.2037)	0.0009 (0.0014)	-0.1488*** (0.0361)	0.0012 (0.0151)	
Anger $\times$ IV		-0.0031* (0.0016)	-0.1091 (0.1950)	-0.0014 (0.0013)	-0.1839*** (0.0427)	-0.0263 (0.0168)	
Fear $\times$ IV		0.0010 (0.0010)	-0.3673*** (0.1222)	0.0017** (0.0009)	-0.0925*** (0.0239)	0.0005 (0.0107)	
Surprise $\times$ IV		-0.0002 (0.0011)	-0.0108 (0.1433)	-0.0001 (0.0010)	-0.0890*** (0.0291)	0.0036 (0.0124)	
IV		-0.0009*** (0.0003)	-0.0689* (0.0354)	-0.0018*** (0.0003)	0.0509*** (0.0073)	0.0036 (0.0029)	
$\sigma_{y,within}$	0.0539	0.0538	0.0538	0.0539	0.0538	0.0499	
Observations	205586	198496	198468	205586	205436	90965	
$R^2$	0.1250	0.1247	0.1247	0.1262	0.1255	0.1270	

Notes: This table considers the relationship between pre-market emotions, stock characteristics and daily price movements. The dependent variable is daily returns, computed as the difference between the closing and the opening price, divided by the opening price. The interaction variables (IV) are \$ trading Volume (Column (2)), volatility (Column (3)), market cap (Column (4)), short interest (Column (5)), and institutional ownership (Column (6)). All specifications include firm and date fixed effects, close-open returns, lag open-close returns, and past 20 trading days return. Robust standard errors clustered at the industry and date levels are in parentheses. We use the Fama-French 12-industry classification. \*  $p < 0.10$ , \*\*  $p < 0.05$ , \*\*\*  $p < 0.01$ . Continuous variables winsorized at the 0.1% and 99.9% level to mitigate the impact of outliers. We report the within-firm, detrended (demeaned) standard deviation of the dependent variable.

Table 11: Pre-Market Emotions, Investor Types and Price Movements

	(1)		(2)		(3)		(4)		(5)		(6)		(7)		(8)		(9)	
	Amateur	Intermediate	Trading Experience	Professional	Fundamental	Technical	Short-Term	Long-Term	Investment Horizon	Men	Women	Gender	Men	Women	Gender	Men	Women	
Happy	0.0005 (0.0005)	0.0014** (0.0006)	-0.0009 (0.0006)	0.0013** (0.0005)	0.0003 (0.0006)	-0.0007 (0.0005)	0.0003 (0.0005)	0.0003 (0.0005)	0.0007 (0.0005)	0.0003 (0.0005)	0.0025*** (0.0008)	0.0013** (0.0006)	0.0025*** (0.0008)	0.0013** (0.0006)	0.0025*** (0.0008)	0.0013** (0.0006)	0.0025*** (0.0008)	0.0013** (0.0006)
Sad	-0.0028*** (0.0010)	-0.0062*** (0.0013)	-0.0036** (0.0015)	-0.0050*** (0.0012)	-0.0044*** (0.0014)	-0.0048*** (0.0012)	-0.0045*** (0.0012)	-0.0045*** (0.0012)	-0.0048*** (0.0012)	-0.0045*** (0.0012)	-0.0103*** (0.0019)	-0.0031*** (0.0011)	-0.0103*** (0.0019)	-0.0031*** (0.0011)	-0.0103*** (0.0019)	-0.0031*** (0.0011)	-0.0103*** (0.0019)	-0.0031*** (0.0011)
Fear	-0.0017* (0.0009)	-0.0022** (0.0011)	-0.0039*** (0.0010)	-0.0019** (0.0010)	-0.0025** (0.0010)	-0.0023** (0.0009)	-0.0022** (0.0010)	-0.0022** (0.0010)	-0.0023** (0.0009)	-0.0022** (0.0010)	-0.0079*** (0.0015)	-0.0006 (0.0010)	-0.0079*** (0.0015)	-0.0006 (0.0010)	-0.0079*** (0.0015)	-0.0006 (0.0010)	-0.0079*** (0.0015)	-0.0006 (0.0010)
Surprise	-0.0019** (0.0009)	-0.0026** (0.0010)	-0.0010 (0.0012)	-0.0023** (0.0010)	-0.0024** (0.0012)	-0.0021** (0.0010)	-0.0013 (0.0010)	-0.0013 (0.0010)	-0.0021** (0.0010)	-0.0013 (0.0010)	-0.0051*** (0.0015)	-0.0024*** (0.0009)	-0.0051*** (0.0015)	-0.0024*** (0.0009)	-0.0051*** (0.0015)	-0.0024*** (0.0009)	-0.0051*** (0.0015)	-0.0024*** (0.0009)
Disgust	-0.0030** (0.0015)	-0.0028 (0.0017)	-0.0019 (0.0018)	0.0002 (0.0016)	-0.0041** (0.0017)	-0.0018 (0.0016)	-0.0029* (0.0015)	-0.0029* (0.0015)	-0.0018 (0.0016)	-0.0018 (0.0015)	-0.0044* (0.0025)	-0.0016 (0.0015)	-0.0044* (0.0025)	-0.0016 (0.0015)	-0.0044* (0.0025)	-0.0016 (0.0015)	-0.0044* (0.0025)	-0.0016 (0.0015)
Anger	-0.0023* (0.0012)	-0.0006 (0.0016)	-0.0010 (0.0016)	-0.0015 (0.0015)	-0.0009 (0.0016)	-0.0018 (0.0015)	-0.0011 (0.0015)	-0.0011 (0.0015)	-0.0018 (0.0015)	-0.0018 (0.0015)	-0.0042* (0.0024)	-0.0011 (0.0014)	-0.0042* (0.0024)	-0.0011 (0.0014)	-0.0042* (0.0024)	-0.0011 (0.0014)	-0.0042* (0.0024)	-0.0011 (0.0014)
Observations	147216	183264	179671	179615	187662	149419	172231	172231	149419	172231	194304	177400	194304	177400	194304	177400	194304	177400
R <sup>2</sup>	0.1326	0.1270	0.1264	0.1269	0.1255	0.1288	0.1300	0.1300	0.1288	0.1300	0.1253	0.1272	0.1253	0.1272	0.1253	0.1272	0.1253	0.1272

Notes: This table considers the relationship between pre-market emotions, user characteristics and daily price movements. The dependent variable is daily returns, computed as the difference between the closing and the opening price, divided by the opening price. All specifications include firm and date fixed effects, close-open returns, lag open-close returns, past 20 trading days return and volatility (as defined in Variable Definitions). Robust standard errors clustered at the industry and date levels are in parentheses. We use the Fama-French 12-industry classification. \*  $p < 0.10$ , \*\*  $p < 0.05$ , \*\*\*  $p < 0.01$ . Continuous variables winsorized at the 0.1% and 99.9% level to mitigate the impact of outliers. We report the within-firm, detrended (demeaned) standard deviation of the dependent variable.

relationship between investor emotions and daily price movements is stable, and statistically significant in most specifications.

### **5.3 Sensitivity Analysis**

Next, we show that our results are robust and capture investor emotions intuitively.

#### **5.3.1 Alternative Classification**

Perhaps the most important part of our robustness checks, we construct alternative emotion variables based on a model trained on a Twitter emotion metadata compiled by other researchers. We explore our Twitter based model in Column (1-3) of Table 12. Our findings remain significant, which provides strong support for the relationship between investor emotions and daily price movements. In Appendix B, we elaborate why we use the StockTwits model instead of the Twitter one.

#### **5.3.2 Alternative Weighting**

For our prior results, we weighted messages by  $\log(1+\text{followers})$ . As a validity check, we consider an alternative weighting scheme. In particular, we investigate abandoning the weighting scheme, and hence, messages are weighted equally (Column (4-6) of Table 12). The results are largely unaltered under these alternative specifications.

#### **5.3.3 Contemporaneous Emotions & Prices**

To provide further support that our emotion measures are capturing investor emotions accurately, we also estimate our main regression with contemporaneous (trading hour) emotion variables. Given Table 13, our measure of happy must be picking up happiness, because when daily returns are high people should be happy, which is what our measure shows. We abstain from analyzing the contemporaneous effects further, since these could be reactive and not predictive (i.e., we do not know whether emotion leads or lags price movements).

Table 12: Robustness: Pre-Market Emotions and Price Movements

	(1)	(2)	(3)	(4)	(5)	(6)
	Twitter Model		Alternative Weighting			
Happy	0.0126*** (0.0023)	0.0001 (0.0023)	0.0338*** (0.0126)	0.0053*** (0.0014)	-0.0009 (0.0016)	0.0316*** (0.0079)
Sad	-0.0027 (0.0071)	0.0021 (0.0072)	-0.0393 (0.0310)	-0.0215*** (0.0035)	-0.0096*** (0.0037)	-0.0113 (0.0178)
Fear	-0.0161** (0.0066)	-0.0132* (0.0071)	-0.0084 (0.0300)	-0.0142*** (0.0025)	-0.0016 (0.0024)	-0.0529*** (0.0134)
Surprise	-0.0277*** (0.0083)	-0.0049 (0.0096)	-0.0594 (0.0391)	-0.0124*** (0.0029)	-0.0081** (0.0033)	0.0080 (0.0150)
Disgust	-0.0211 (0.0201)	-0.0779*** (0.0258)	0.0181 (0.0849)	-0.0060 (0.0040)	-0.0029 (0.0042)	-0.0297 (0.0213)
Anger	-0.0035 (0.0114)	0.0026 (0.0162)	0.0032 (0.0444)	-0.0005 (0.0040)	-0.0060 (0.0043)	0.0124 (0.0212)
S&P Super Composite Firms		X			X	
At least 100 messages			X			X
$\sigma_{y,within}$	0.0544	0.0330	0.0677	0.0544	0.0330	0.0677
Observations	198468	66175	44100	198468	66175	44100
$R^2$	0.1244	0.1771	0.1809	0.1246	0.1769	0.1817

Notes: This table considers the robustness of the relationship between pre-market emotions and daily price movements. Columns (1-3) uses emotion variables constructed based on a model trained on Twitter emotion data compiled by other researchers. Columns (4-6) abandons the weighting scheme used in our analysis, and weighs each posts equally. The dependent variable is daily returns, computed as the difference between the closing and the opening price, divided by the opening price. All specifications include firm and date fixed effects, close-open returns, lag open-close returns, past 20 trading days return and volatility (as defined in Variable Definitions). Robust standard errors clustered at the industry and date levels are in parentheses. We use the Fama-French 12-industry classification. \*  $p < 0.10$ , \*\*  $p < 0.05$ , \*\*\*  $p < 0.01$ . Continuous variables winsorized at the 0.1% and 99.9% level to mitigate the impact of outliers. We report the within-firm, detrended (demeaned) standard deviation of the dependent variable.

Table 13: Market Emotions and Price Movements

	(1)	(2)	(3)	(4)
Happy		0.0442*** (0.0014)	0.0422*** (0.0015)	0.0630*** (0.0066)
Sad		-0.2574*** (0.0032)	-0.1154*** (0.0035)	-0.8277*** (0.0147)
Fear		-0.1228*** (0.0023)	-0.0565*** (0.0025)	-0.3314*** (0.0111)
Surprise		-0.1492*** (0.0027)	-0.0747*** (0.0034)	-0.3264*** (0.0123)
Disgust		-0.2121*** (0.0038)	-0.0976*** (0.0049)	-0.6175*** (0.0175)
Anger		-0.1514*** (0.0037)	-0.0594*** (0.0042)	-0.4012*** (0.0164)
S&P Super Composite Firms			X	
At least 100 messages				X
$\sigma_{y,within}$	0.0609	0.0609	0.0380	0.0787
Observations	251237	251237	79907	66251
$R^2$	0.1214	0.2059	0.2470	0.3145

Notes: This table considers the relationship between emotions posted during market hours and daily price movements. The dependent variable is daily returns, computed as the difference between the closing and the opening price, divided by the opening price. All specifications include firm and date fixed effects, close-open returns, lag open-close returns, past 20 trading days return and volatility (as defined in Variable Definitions). Robust standard errors clustered at the industry and date levels are in parentheses. We use the Fama-French 12-industry classification. \*  $p < 0.10$ , \*\*  $p < 0.05$ , \*\*\*  $p < 0.01$ . Continuous variables winsorized at the 0.1% and 99.9% level to mitigate the impact of outliers. We report the within-firm, detrended (demeaned) standard deviation of the dependent variable.

## 6 Conclusion

In this paper, we develop a tool to extract investor emotions from financial social media data. The tool is open-source and is available at <https://github.com/dvamossy/EmTract>. Using this tool, we make several contributions to the literature on investor emotions and market behavior. First, we confirm the findings of controlled laboratory experiments. Second, we find that investor emotions can help predict daily price movements. These impacts are larger when volatility or short interest are higher, and when institutional ownership and liquidity are lower. Last, we show that investor emotions can help rationalize two stylized facts about IPO returns.

While the effects of information on fundamentals can be identified with well-established techniques in finance and economics, studying the emotional component requires new tools. In our view, the methods described herein constitute a step forward in this direction.

## References

- Martín Abadi, Paul Barham, Jianmin Chen, Zhifeng Chen, Andy Davis, Jeffrey Dean, Matthieu Devin, Sanjay Ghemawat, Geoffrey Irving, Michael Isard, et al. Tensorflow: a system for large-scale machine learning. In *OSDI*, volume 16, pages 265–283, 2016.
- Jeffrey S Abarbanell. Do analysts’ earnings forecasts incorporate information in prior stock price changes? *Journal of Accounting and Economics*, 1991.
- Stefania Albanesi and Domonkos F Vamossy. Predicting consumer default: A deep learning approach. Technical report, National Bureau of Economic Research, 2019.
- Eduardo B Andrade, Terrance Odean, and Shengle Lin. Bubbling with excitement: an experiment. *Review of Finance*, 20(2):447–466, 2016.
- Werner Antweiler and Murray Z Frank. Is all that talk just noise? the information content of internet stock message boards. *The Journal of finance*, 59(3):1259–1294, 2004.
- David Arthur and Sergei Vassilvitskii. k-means++: The advantages of careful seeding. Technical report, Stanford, 2006.
- Susan Athey and Guido W Imbens. Machine learning methods that economists should know about. *Annual Review of Economics*, 11, 2019.
- Pablo D Azar and Andrew W Lo. The wisdom of twitter crowds: Predicting stock market reactions to fomc meetings via twitter feeds. *The Journal of Portfolio Management*, 42(5):123–134, 2016.
- Malcolm Baker and Jeffrey Wurgler. Investor sentiment in the stock market. *Journal of economic perspectives*, 21(2):129–152, 2007.
- Brad M Barber and Terrance Odean. The behavior of individual investors. In *Handbook of the Economics of Finance*, volume 2, pages 1533–1570. Elsevier, 2013.
- Eli Bartov, Lucile Faurel, and Partha S Mohanram. Can twitter help predict firm-level earnings and stock returns? *The Accounting Review*, 93(3):25–57, 2018.
- Joyce Berg, Robert Forsythe, and Thomas Rietz. What makes markets predict well? evidence from the iowa electronic markets. In *Understanding Strategic Interaction*, pages 444–463. Springer, 1997.
- Joyce Berg, Robert Forsythe, Forrest Nelson, and Thomas Rietz. Results from a dozen years of election futures markets research. *Handbook of experimental economics results*, 1: 742–751, 2008.
- Elizabeth Blankespoor, Gregory S Miller, and Hal D White. The role of dissemination in market liquidity: Evidence from firms’ use of twitter™. *The Accounting Review*, 89(1): 79–112, 2014.



- Johan Bollen, Huina Mao, and Xiaojun Zeng. Twitter mood predicts the stock market. *Journal of computational science*, 2(1):1–8, 2011.
- Adriana Breaban and Charles N Noussair. Emotional state and market behavior. *Review of Finance*, 22(1):279–309, 2018.
- Mark M Carhart. On persistence in mutual fund performance. *The Journal of finance*, 52(1):57–82, 1997.
- Hailiang Chen, Prabuddha De, Yu Jeffrey Hu, and Byoung-Hyoun Hwang. Wisdom of crowds: The value of stock opinions transmitted through social media. *The Review of Financial Studies*, 27(5):1367–1403, 2014.
- François Chollet et al. Keras: Deep learning library for theano and tensorflow. *URL: <https://keras.io/k>*, 7(8), 2015.
- Junyoung Chung, Caglar Gulcehre, KyungHyun Cho, and Yoshua Bengio. Empirical evaluation of gated recurrent neural networks on sequence modeling. *arXiv preprint arXiv:1412.3555*, 2014.
- J Anthony Cookson and Marina Niessner. Why don’t we agree? evidence from a social network of investors. *The Journal of Finance*, 75(1):173–228, 2020.
- Asher Curtis, Vernon J Richardson, and Roy Schmardebeck. Investor attention and the pricing of earnings news. *Handbook of Sentiment Analysis in Finance, Forthcoming*, 2014.
- Zhi Da, Joseph Engelberg, and Pengjie Gao. In search of attention. *The Journal of Finance*, 66(5):1461–1499, 2011.
- Sanjiv R Das and Mike Y Chen. Yahoo! for amazon: Sentiment extraction from small talk on the web. *Management science*, 53(9):1375–1388, 2007.
- J Bradford De Long, Andrei Shleifer, Lawrence H Summers, and Robert J Waldmann. Noise trader risk in financial markets. *Journal of political Economy*, 98(4):703–738, 1990.
- Michael S Drake, Darren T Roulstone, and Jacob R Thornock. Investor information demand: Evidence from google searches around earnings announcements. *Journal of Accounting research*, 50(4):1001–1040, 2012.
- Darren Duxbury, Tommy Gärling, Amelie Gamble, and Vian Klass. How emotions influence behavior in financial markets: a conceptual analysis and emotion-based account of buy-sell preferences. *The European Journal of Finance*, pages 1–22, 2020.
- Alex Edmans, Diego Garcia, and Øyvind Norli. Sports sentiment and stock returns. *The Journal of finance*, 62(4):1967–1998, 2007.
- Katrina Ellis, Roni Michaely, and Maureen O’hara. When the underwriter is the market maker: An examination of trading in the ipo aftermarket. *The Journal of Finance*, 55(3): 1039–1074, 2000.

- Larry G Epstein and Martin Schneider. Ambiguity, information quality, and asset pricing. *The Journal of Finance*, 63(1):197–228, 2008.
- Bjarke Felbo, Alan Mislove, Anders Søgaard, Iyad Rahwan, and Sune Lehmann. Using millions of emoji occurrences to learn any-domain representations for detecting sentiment, emotion and sarcasm. *arXiv preprint arXiv:1708.00524*, 2017.
- Peter Gabrovšek, Darko Aleksovski, Igor Mozetič, and Miha Grčar. Twitter sentiment around the earnings announcement events. *PloS one*, 12(2), 2017.
- John Kenneth Galbraith. *A short history of financial euphoria*, volume 3856. Penguin Books, 1994.
- Eric Gilbert and Karrie Karahalios. Widespread worry and the stock market. In *Fourth International AAAI Conference on Weblogs and Social Media*, 2010.
- Alex Graves and Jürgen Schmidhuber. Framewise phoneme classification with bidirectional lstm and other neural network architectures. *Neural networks*, 18(5-6):602–610, 2005.
- Shaun P Hargreaves Heap and Daniel John Zizzo. Emotions and chat in a financial markets experiment. *Available at SSRN 1783462*, 2011.
- Mark Hirschey, Vernon J Richardson, and Susan Scholz. Stock-price effects of internet buy-sell recommendations: The motley fool case. *Financial Review*, 35(2):147–174, 2000.
- David Hirshleifer and Tyler Shumway. Good day sunshine: Stock returns and the weather. *The Journal of Finance*, 58(3):1009–1032, 2003.
- Sepp Hochreiter and Jürgen Schmidhuber. Long short-term memory. *Neural computation*, 9(8):1735–1780, 1997.
- Lu Hong and Scott E Page. Groups of diverse problem solvers can outperform groups of high-ability problem solvers. *Proceedings of the National Academy of Sciences*, 101(46):16385–16389, 2004.
- John D Hunter. Matplotlib: A 2d graphics environment. *Computing in science & engineering*, 9(3):90–95, 2007.
- Ben Jacobsen and Wessel Marquering. Is it the weather? *Journal of Banking & Finance*, 32(4):526–540, 2008.
- Russell Jame, Rick Johnston, Stanimir Markov, and Michael C Wolfe. The value of crowd-sourced earnings forecasts. *Journal of Accounting Research*, 54(4):1077–1110, 2016.
- Narasimhan Jegadeesh and Woojin Kim. Do analysts herd? an analysis of recommendations and market reactions. *The Review of Financial Studies*, 23(2):901–937, 2010.
- Narasimhan Jegadeesh and Sheridan Titman. Returns to buying winners and selling losers: Implications for stock market efficiency. *The Journal of finance*, 48(1):65–91, 1993.

- Michael J Jung, James P Naughton, Ahmed Tahoun, and Clare Wang. Do firms strategically disseminate? evidence from corporate use of social media. *The Accounting Review*, 93(4): 225–252, 2018.
- Mark J Kamstra, Lisa A Kramer, and Maurice D Levi. Winter blues: A sad stock market cycle. *American Economic Review*, 93(1):324–343, 2003.
- Yaron Lahav and Shireen Meer. The effect of induced mood on prices in experimental asset markets. *Unpublished working paper, Emory University*, 2010.
- Jessica LaVoice and Domonkos F Vamossy. Racial disparities in debt collection. *arXiv preprint arXiv:1910.02570*, 2019.
- Alastair Lawrence, James Ryans, Estelle Sun, and Nikolay Laptev. Yahoo finance search and earnings announcements. *Available at SSRN 2804353*, 2016.
- Lian Fen Lee, Amy P Hutton, and Susan Shu. The role of social media in the capital market: Evidence from consumer product recalls. *Journal of Accounting Research*, 53(2):367–404, 2015.
- Qian Li, Bing Zhou, and Qingzhong Liu. Can twitter posts predict stock behavior?: A study of stock market with twitter social emotion. In *2016 IEEE International Conference on Cloud Computing and Big Data Analysis (ICCCBDA)*, pages 359–364. IEEE, 2016.
- Alexander Ljungqvist, Vikram Nanda, and Rajdeep Singh. Hot markets, investor sentiment, and ipo pricing. *the Journal of Business*, 79(4):1667–1702, 2006.
- George F Loewenstein, Elke U Weber, Christopher K Hsee, and Ned Welch. Risk as feelings. *Psychological bulletin*, 127(2):267, 2001.
- Tim Loughran and Bill McDonald. When is a liability not a liability? textual analysis, dictionaries, and 10-ks. *The Journal of Finance*, 66(1):35–65, 2011.
- Tim Loughran and Jay Ritter. Why has ipo underpricing changed over time? *Financial management*, pages 5–37, 2004.
- Tim Loughran and Jay R Ritter. The new issues puzzle. *The Journal of finance*, 50(1): 23–51, 1995.
- Robert E Lucas Jr. Asset prices in an exchange economy. *Econometrica: Journal of the Econometric Society*, pages 1429–1445, 1978.
- Scott M Lundberg and Su-In Lee. A unified approach to interpreting model predictions. In I. Guyon, U. V. Luxburg, S. Bengio, H. Wallach, R. Fergus, S. Vishwanathan, and R. Garnett, editors, *Advances in Neural Information Processing Systems 30*, pages 4765–4774. Curran Associates, Inc., 2017. URL <http://papers.nips.cc/paper/7062-a-unified-approach-to-interpreting-model-predictions.pdf>.

- Yuexin Mao, Wei Wei, Bing Wang, and Benyuan Liu. Correlating s&p 500 stocks with twitter data. In *Proceedings of the first ACM international workshop on hot topics on interdisciplinary social networks research*, pages 69–72, 2012.
- Wes McKinney et al. Data structures for statistical computing in python. In *Proceedings of the 9th Python in Science Conference*, volume 445, pages 51–56. Austin, TX, 2010.
- Vitaliy Meursault. The language of earnings announcements. Technical report, Working paper, 2019.
- Sendhil Mullainathan and Jann Spiess. Machine learning: an applied econometric approach. *Journal of Economic Perspectives*, 31(2):87–106, 2017.
- Vivek Narayanan, Ishan Arora, and Arjun Bhatia. Fast and accurate sentiment classification using an enhanced naive bayes model. In *International Conference on Intelligent Data Engineering and Automated Learning*, pages 194–201. Springer, 2013.
- Fabian Pedregosa, Gaël Varoquaux, Alexandre Gramfort, Vincent Michel, Bertrand Thirion, Olivier Grisel, Mathieu Blondel, Peter Prettenhofer, Ron Weiss, Vincent Dubourg, et al. Scikit-learn: Machine learning in python. *Journal of machine learning research*, 12(Oct): 2825–2830, 2011.
- Jeffrey Pennington, Richard Socher, and Christopher D Manning. Glove: Global vectors for word representation. In *Proceedings of the 2014 conference on empirical methods in natural language processing (EMNLP)*, pages 1532–1543, 2014.
- Mitchell A Petersen. Estimating standard errors in finance panel data sets: Comparing approaches. *The Review of Financial Studies*, 22(1):435–480, 2009.
- Alexander Ratner, Stephen H Bach, Henry Ehrenberg, Jason Fries, Sen Wu, and Christopher Ré. Snorkel: Rapid training data creation with weak supervision. *The VLDB Journal*, 29(2):709–730, 2020.
- Radim Řehůřek and Petr Sojka. Software Framework for Topic Modelling with Large Corpora. In *Proceedings of the LREC 2010 Workshop on New Challenges for NLP Frameworks*, pages 45–50, Valletta, Malta, May 2010. ELRA. <http://is.muni.cz/publication/884893/en>.
- Jürgen Schmidhuber. Deep learning in neural networks: An overview. *Neural networks*, 61: 85–117, 2015.
- Mike Schuster and Kuldeep K Paliwal. Bidirectional recurrent neural networks. *IEEE transactions on Signal Processing*, 45(11):2673–2681, 1997.
- Robert J Shiller. Bubbles, human judgment, and expert opinion. *Financial Analysts Journal*, 58(3):18–26, 2002.
- Robert J Shiller. From efficient markets theory to behavioral finance. *Journal of economic perspectives*, 17(1):83–104, 2003.

- Robert J. Shiller. 'gut feelings' are driving the markets. *The New York Times*, 2020. URL <https://www.nytimes.com/2020/01/02/business/gut-feelings-are-driving-the-markets.html>.
- Hui-Chu Shu. Investor mood and financial markets. *Journal of Economic Behavior & Organization*, 76(2):267–282, 2010.
- Vernon L Smith, Gerry L Suchanek, and Arlington W Williams. Bubbles, crashes, and endogenous expectations in experimental spot asset markets. *Econometrica: Journal of the Econometric Society*, pages 1119–1151, 1988.
- Douglas E Stevens and Arlington W Williams. Inefficiency in earnings forecasts: Experimental evidence of reactions to positive vs. negative information. *Experimental Economics*, 7(1):75–92, 2004.
- James Surowiecki. The wisdom of crowds: Why the many are smarter than the few and how collective wisdom shapes business. *Economies, Societies and Nations*, 296, 2004.
- Lazaros Symeonidis, George Daskalakis, and Raphael N Markellos. Does the weather affect stock market volatility? *Finance Research Letters*, 7(4):214–223, 2010.
- Paul C Tetlock. Giving content to investor sentiment: The role of media in the stock market. *The Journal of finance*, 62(3):1139–1168, 2007.
- Robert Tumarkin and Robert F Whitelaw. News or noise? internet postings and stock prices. *Financial Analysts Journal*, 57(3):41–51, 2001.
- Domonkos F Vamossy. Investor emotions and trading behavior. *Available at SSRN 3787789*, 2020.
- Stéfan van der Walt, S Chris Colbert, and Gael Varoquaux. The numpy array: a structure for efficient numerical computation. *Computing in Science & Engineering*, 13(2):22–30, 2011.
- Ivo Welch. Herding among security analysts. *Journal of Financial economics*, 58(3):369–396, 2000.
- Justin Wolfers. How emotion hurts stock returns. *The New York Times*, 2015. URL <https://www.nytimes.com/2015/08/25/upshot/how-emotion-hurts-stock-returns.html>.
- Michelle Yik, James A Russell, and James H Steiger. A 12-point circumplex structure of core affect. *Emotion*, 11(4):705, 2011.

# Appendix

## A Variable Definitions and Sources

Table A.1 defines the variables used in the analyses.

Table A.1: Variable Definitions

Variable	Definition	Source
Open-Close Return	Difference between daily closing and open price, normalized by the open price.	CRSP
Close-Open Return	Difference between previous day's closing price and current open price, normalized by the previous day's closing price.	CRSP
Market Cap <sub>-1</sub>	Natural logarithm of market value of equity ( $\log(1+\text{CSHOC}*\text{PRCCD})$ ).	CRSP
Volatility	Standard deviation of daily returns during from 183 days prior up to a day before.	CRSP
\$ Volume <sub>-183,-1</sub>	Arithmetic mean of the natural logarithm of market value of daily trading volume ( $\log(1+\text{CSHTRD}*(\text{PRCCD} + \text{PRCOD})/2)$ ) from 183 days prior up to a day before.	CRSP
Short Interest	Shares short divided by shares outstanding. Bi-weekly frequency.	Compustat
Institutional Ownership	Number of shares held by institutional investors scaled by total shares outstanding as of the quarter-end date	Thomson Reuters Institutional Holdings (13F)
IPO First Day Return	Difference between IPO price and daily closing price	NASDAQ
Emotion	Each message is classified by a many-to-one deep learning model into one of the seven categories (i.e., neutral, happy, sad, anger, disgust, surprise, fear), so that the corresponding probabilities sum up to 1. For each emotions separately, we then take the weighted average of these probabilities from 4pm the previous day until 9am the trading day and the weights correspond to the number of followers of the user $1+\log(1 + \# \text{ of Followers})$ .	StockTwits

## B Natural Language Processing to Extract Emotions

### B.1 Text Processing

We first remove images, hyperlinks, and tags from the text. We discard tweets at (e.g., @dvamosy), and the retweet indicator (i.e., “RT”) where applicable. We set text to lower case, translate emojis and emoticons (e.g., “:)” substituted with “happyface”), fix contractions (e.g., “i’ve” changed to “i have”), and correct common misspellings<sup>12</sup>.

We replace numbers preceded by a \$ sign with “dollarvalueplaceholder”, other numbers with “numbervalueplaceholder”, the % sign with “percentageplaceholder”, and any stock ticker with “companyplaceholder”. This feature is important for distinguishing between general chat versus stock trading related messages. We then remove any non-word tokens, such as punctuation marks. We include the 32,457 most frequent words in the model dictionary, changing all other tokens to “NONE”. The messages are then tokenized (i.e., words are changed to numbers) and split into sentences using keras.

### B.2 Measuring Emotions with Deep Learning

Our deep learning model operates by sequentially learning a latent representation. These reflect features such as word order, word usage, and local context. Minimization of prediction error<sup>13</sup> drives feature extraction. We use a Bidirectional-GRU model, which can be defined as the composition of several functions (layers):

$$f(X_{j,T}; w) = S \circ D \circ O \circ \text{BiGRU} \circ \text{Emb}(X_{j,T}) \quad (2)$$

where  $X_{j,t}$  is the  $j$ th message of length  $T$ ,  $\text{Emb}$  is the embedding,  $\text{BiGRU}$  is the Bidirectional Gated Recurrent Unit,  $O$  is a linear layer,  $D$  is a two-layered NN with ReLU activation, and  $S$  is the final softmax layer, which ensures that the output is between 0 and 1. We next define each component of the model.

#### B.2.1 Message

We define a message as a vector  $\mathbf{X} = [x_1 \dots x_T]$ , where  $x_k$  is the index of the  $k$ th word in the model dictionary, and  $T$  is the maximum document length (30 in our case). For documents shorter than the maximum document length, we fill the extra space with special padding words.

---

<sup>12</sup>We provide a description of our misspell correction in the Online Appendix.

<sup>13</sup>We use a categorical-cross entropy loss function.

## B.2.2 Embedding

Embedding (Emb) assigns vectors to individual words. We obtain the starting value for our word embeddings from Pennington et al. [2014], leveraging 2 billion tweets, 27 billion tokens, and a vocabulary of 1.2 million words. These embedding vectors are then updated during estimation via backpropagation. We denote the embedding of the word  $x_i$  as  $e(x_i) = e_i \in \mathbb{R}^{d(E)}$ , where  $d(E)$  is the embedding size (200 in our case). Thus, the document can be represented as:

$$\text{Emb}(X_{j,T}) = \begin{bmatrix} e_1 \\ e_2 \\ \vdots \\ e_T \end{bmatrix} = \begin{bmatrix} e_{1,1} & e_{1,2} & \cdots & e_{1,d(E)} \\ e_{2,1} & e_{2,2} & \cdots & e_{2,d(E)} \\ \vdots & \vdots & \vdots & \vdots \\ e_{T,1} & e_{T,2} & \cdots & e_{T,d(E)} \end{bmatrix} \quad (3)$$

Words frequently used interchangeably are prone to cluster in the embedding space.<sup>14</sup>

## B.2.3 Gated Recurrent Unit (GRU)

Introduced by Chung et al. [2014], the Gated Recurrent Unit (GRU) is a slight variation on the LSTM (see Hochreiter and Schmidhuber [1997]). It addresses the high memory requirements imposed by the LSTM by combining the forget and input gates into a single “update gate”, and by merging the cell state with the hidden state. The resulting model requires less computation, and has enjoyed growing popularity. We illustrate the GRU cell in Figure B.1.

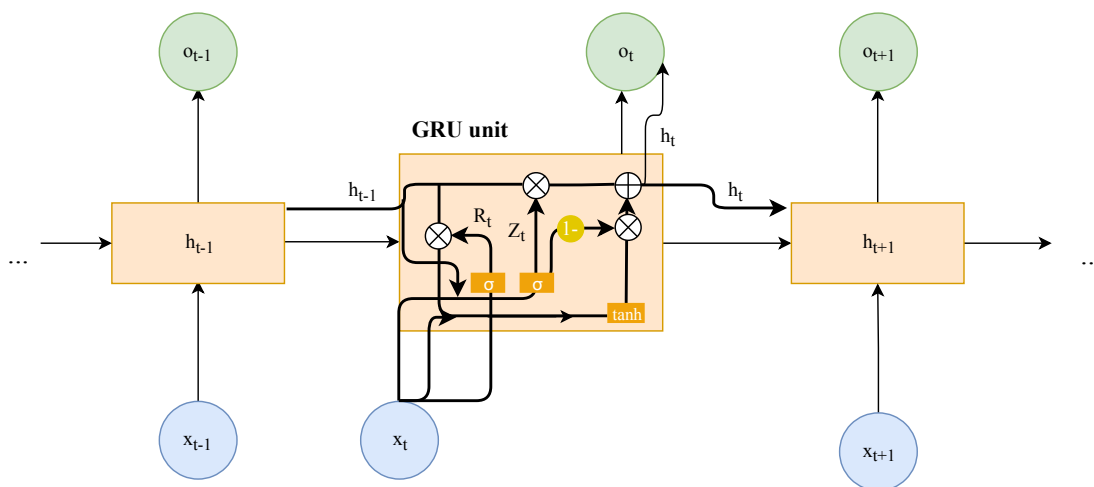

Figure B.1: The architecture of the GRU unit

<sup>14</sup>This property allows us to capture word similarities without imposing any additional structure.



The update gate decides which parts of the previous hidden state are updated (or discarded). By selecting valuable parts from the previous hidden state, the reset gate determines which parts are used to compute new content. This is then used along with current input to compute the hidden state update. Notice that the update gate controls both what is kept from the previous hidden state, and what is taken from the hidden state update. The sigmoid function ensures that the output is between zero and one. To illustrate this as a sequence of operations, consider time-step  $t$  ( $t$ -th word) and input  $\mathbf{X}_t \in \mathbb{R}^{n \times d}$  ( $n$  is sample size,  $d$  denotes input). The computations (forward-propagation) for the GRU unit can be summarized as:

$$\mathbf{Z}_t = \sigma_g(\mathbf{W}_{xz}\mathbf{X}_t + \mathbf{W}_{hz}\mathbf{H}_{t-1} + \mathbf{b}_z) \quad (4)$$

$$\mathbf{R}_t = \sigma_g(\mathbf{W}_{xr}\mathbf{X}_t + \mathbf{W}_{hr}\mathbf{H}_{t-1} + \mathbf{b}_r) \quad (5)$$

$$\mathbf{H}_t = \mathbf{Z}_t \odot \mathbf{H}_{t-1} + (1 - \mathbf{Z}_t) \odot \sigma_h(\mathbf{W}_{xh}\mathbf{X}_t + \mathbf{W}_{hh}(\mathbf{R}_t \odot \mathbf{H}_{t-1}) + \mathbf{b}_h) \quad (6)$$

where  $\odot$  denotes elementwise multiplication,  $\mathbf{X}_t$  denotes the input,  $\mathbf{H}_t \in \mathbb{R}^{n \times h}$  the output,  $\mathbf{Z}_t \in \mathbb{R}^{n \times h}$  the update gate,  $\mathbf{R}_t \in \mathbb{R}^{n \times h}$  the reset gate, and  $h$  the number of hidden states. Here,  $\mathbf{W}_{xr}, \mathbf{W}_{xz} \in \mathbb{R}^{d \times h}$  and  $\mathbf{W}_{hr}, \mathbf{W}_{hz} \in \mathbb{R}^{h \times h}$  are weight matrices, while  $\mathbf{b}_r, \mathbf{b}_z \in \mathbb{R}^{1 \times h}$  are bias parameters. Typically  $\sigma_g$  is a sigmoid function to transform input values to the interval  $(0,1)$ , while  $\sigma_h$  is tanh.

#### B.2.4 Bidirectional GRU

Bidirectional RNNs were developed by Schuster and Paliwal [1997]. The key feature of the bidirectional architecture is that dependencies and training can go forwards and backwards in time.<sup>15</sup> Before we move forward, let us denote our previous operations defined in Equations (4)-(6) as  $\mathbf{Z}_t = \vec{\mathbf{Z}}_t$ ,  $\mathbf{R}_t = \vec{\mathbf{R}}_t$ ,  $\mathbf{H}_t = \vec{\mathbf{H}}_t$ . The key addition of the bidirectional architecture is that for a given timestep  $t$ , we also compute hidden state updates as follows:

$$\overleftarrow{\mathbf{Z}}_t = \sigma_g(\mathbf{W}_{xz}^f\mathbf{X}_t + \mathbf{W}_{hz}^f\overleftarrow{\mathbf{H}}_{t+1} + \mathbf{b}_z^f) \quad (7)$$

$$\overleftarrow{\mathbf{R}}_t = \sigma_g(\mathbf{W}_{xr}^f\mathbf{X}_t + \mathbf{W}_{hr}^f\overleftarrow{\mathbf{H}}_{t+1} + \mathbf{b}_r^f) \quad (8)$$

$$\overleftarrow{\mathbf{H}}_t = \overleftarrow{\mathbf{Z}}_t \odot \overleftarrow{\mathbf{H}}_{t+1} + (1 - \overleftarrow{\mathbf{Z}}_t) \odot \sigma_h(\mathbf{W}_{xh}^f\mathbf{X}_t + \mathbf{W}_{hh}^f(\overleftarrow{\mathbf{R}}_t \odot \overleftarrow{\mathbf{H}}_{t+1}) + \mathbf{b}_h^f) \quad (9)$$

We then concatenate the forward and backward hidden states  $\overleftarrow{\mathbf{H}}_t$  and  $\vec{\mathbf{H}}_t$  to obtain the

<sup>15</sup>For instance, if we were to ingest “oil and gas” with a forward architecture, “oil” would receive signal from “gas” during backpropagation but not the reverse. The bidirectional architecture allows for both relationships. For an in-depth discussion of different bidirectional architectures see Graves and Schmidhuber [2005].

hidden state  $\mathbf{H}_t \in \mathbb{R}^{n \times 2h}$ .

### B.2.5 Linear Layer, Neural Network and Softmax Activation

Our next step is to apply another set of weights and bias terms and pass it to two-layered Neural Network:

$$\mathbf{O}_t = \mathbf{H}_t \mathbf{W}_{h,q} + \mathbf{b}_q \quad (10)$$

$$\mathbf{D} = \sigma_d(\mathbf{O}_t \mathbf{W}_o + \mathbf{b}_o) \quad (11)$$

$$\mathbf{D}' = \sigma_d(\mathbf{D} \mathbf{W}_d + b_d) \quad (12)$$

the output of the GRU is  $\mathbf{O}_t \in \mathbb{R}^{n \times q}$ , the output of the first dense layer is  $\mathbf{D} \in \mathbb{R}^{n \times q'}$ , while the output of the second dense layer is  $\mathbf{D}' \in \mathbb{R}^{n \times q''}$  where  $q, q', q''$  denote the number of hidden units for each of the layers, and  $\sigma_d$  is the RELU activation function in our case, defined as:

$$\text{RELU}(x) = \begin{cases} x & \text{if } x \geq 0 \\ 0 & \text{otherwise} \end{cases} \quad (13)$$

This is then passed to another hidden layer, followed by a softmax layer to obtain the final output:

$$\hat{\mathbf{y}} = \text{softmax}(\mathbf{D}' \mathbf{W}_y + b_y) \quad (14)$$

where  $\hat{\mathbf{y}}$  denotes the final output with  $\hat{\mathbf{y}} \in \mathbb{R}^{n \times y}$ , and  $y$  denotes the number of outputs, 7 in our case for the emotion classification, and 3 for the chat type classification.

## B.3 Training Data Sources

Since performing textual analysis using any word classification scheme is inherently imprecise (see, e.g., Loughran and McDonald [2011]), we train two different models based on different data sources. Our first, and preferred model is similar to Li et al. [2016]. It relies on building the training data from dictionaries. In particular, we define dictionaries for each emotional states. Our dictionaries include both emojis and emoticons, and consists of 4,307 words. To map emojis and emoticons to emotions we use <https://unicode.org/Public/emoji/13.0/emoji-test.txt>. We translate emoticons into categories such as “happyface”, while we retain emojis in their original format, such as “facewithopenmouth”. We do this to keep the diversity of our emotional labels, which has been shown to improve predictive power

(e.g, Felbo et al. [2017]). We then prepare a training data with messages containing such words, and augment this with messages not containing any of these words while having zero sentiment as neutral ones. We add automated messages as neutral to our training sample.<sup>16</sup> We then use these dictionaries and Ratner et al. [2020] to generate our training data. The second classification scheme builds a model from pre-compiled emotion datasets based on Twitter messages. We construct this training data from <https://github.com/sarnthil/unify-emotion-datasets/tree/master/datasets>. We compare the performance of these two models in Appendix B.5, and discuss further limitations of using the Twitter based model in the Online Appendix.

For our information-based classification, our “fundamental” data comes from StockTwits data with messages containing earnings or fundamental information, while our “chat” data comes from our Twitter training data, excluding messages containing such information. This allows us to isolate general chat-like messages from those containing financial information. We rely on these models instead of using a dictionary-based method since it gives us a probabilistic assessment whether a message belongs to a certain class. Additionally, trained word-embeddings learn words often co-occurring with entries from our dictionaries, so that words not included in the dictionary but containing financial information could be picked up by our model.

## B.4 Implementation

We include 30 words for each message and train roughly 10 million messages for our emotion classification<sup>17</sup>. We use a batch-size of 4,096, a learning rate of 0.003, an early-stopping parameter of 10, an embedding dropout of 0.25, 256 hidden units for our GRU, and 256-128 hidden units respectively for our dense layers.

Our deep learning models are made up of millions of free parameters. Since the estimation procedure relies on computing gradients via backpropagation, which tends to be time and memory intensive, using conventional computing resources (e.g., desktop) would be impractical (if not unfeasible). Acknowledging the impact of GPUs in deep learning (see Schmidhuber [2015]), we train our models on a GPU cluster (1-2 NVIDIA GeForce GTX1080 GPUs proved to be sufficient). We conduct our analysis using Python 3.6.3 (Python Software Foundation), building on the packages numpy (Walt et al. [2011]), pandas (McKinney et al. [2010]) and matplotlib (Hunter [2007]). We develop our bidirectional gru model with

---

<sup>16</sup>We further require positive (negative) emotions to have positive (negative) sentiment, classified by <https://textblob.readthedocs.io/en/dev/>. We do not impose this for surprise. This reduced the coverage of our labeling model, but increased the accuracy.

<sup>17</sup>Training data messages by class: 2.7M neutral, 3.8M happy, 1.1M fear, 1.1M surprise, 0.6M sad, 0.3M disgust, 0.4M anger.

keras (Chollet et al. [2015]) running on top of Google TensorFlow, a powerful library for large-scale machine learning on heterogenous systems (Abadi et al. [2016]).

## B.5 Model Comparison & Output

We contrast our model trained on Twitter with the one trained on StockTwits data, and provide a reasoning why we prefer the StockTwits trained model.

### B.5.1 Labeling

Given that the training data for the StockTwits model was built using dictionaries, it may miss words that are emotional in nature but were not included in the dictionary. To alleviate this concern, we report the accuracy and coverage of our dictionary based training data preparation on a sample of 10,000 hand-tagged messages from StockTwits in Table B.1.

Table B.1: Generating Training Data: Dictionary Based Labeling Accuracy

Class	Correct	Incorrect	Empirical Accuracy
Neutral	2133	28	98.7%
Happy	2298	148	93.9%
Sad	406	74	84.6%
Anger	197	101	66.1%
Disgust	253	132	65.7%
Surprise	723	72	90.9%
Fear	902	214	80.8%

Labeling accuracy evaluated on the hand-tagged 10,000 messages. Note: our labeling model would cover 76.81% of these messages, so it would not classify 2,319 messages (i.e., would not label the message with any of our classes).

This shows that approximately 3/4 of our messages can be tagged with this approach with a fairly high accuracy, suggesting that this issue might not be severe. The second model, however, was developed using Twitter messages, and it is unclear whether this model would be directly applicable to messages about stocks and companies (we provide mixed evidence in the Online Appendix). In addition, a large number of words are not accounted for using this technique: while in terms of word frequencies our Twitter words cover 97.2% of our StockTwits words, they only cover 2% of the vocabulary. Thus, trained on this data, our model discards potentially important words for classification.

### B.5.2 Classifier Performance

To directly compare these two models, we test the accuracy of both classifiers on a sample of 10,000 hand-tagged messages from StockTwits. We report the results in Table B.2. This shows that the StockTwits trained model performs significantly better in terms of accuracy (roughly 33% better) and slightly better in terms of loss. Most mistakes by the StockTwits based model are classifying non-neutral messages as neutral with almost certainty.

Table B.2: Performance on Hand-Tagged Test Sample

Model	In-Sample		Test Sample	
	Loss	Accuracy	Loss	Accuracy
Twitter	0.859	69.67%	1.725	41.60%
StockTwits	<b>0.066</b>	<b>97.80%</b>	1.644	74.52%

Test sample refers to the hand-tagged 10,000 messages; these messages are never fed into the model during training. Model that gets selected based on in-sample loss in bold.

We confirm this with first plotting the classification errors for each emotions in the data for each of our models. Panel (a) of Figure B.2 plots it for our StockTwits based model, while Panel (b) does so for the Twitter based model. The diagonal entries represent the precision of the classifier. For instance, the 83.6% in the upper left corner of Panel (a) implies that our StockTwits classifier accurately classified 88.1% of all neutral messages as neutral, while the 16.9% in the second row first column represents that our classifier mistakenly tagged 16.9% happy messages as neutral. As we can see, the majority of our mistakes with the StockTwits based model is classifying non-neutral messages as neutral. Since we take neutral as our benchmark group, these types of mistakes likely bias our coefficients towards zero, but retain the true ordinal ranking. Particularly important for our results is the lack of misclassification between positive and negative valence emotions. This is not the case for our Twitter based model. Though most mistakes are towards neutral, there is a large degree of misclassification from sad, angry, and disgust to both happy, and fear. Hence, we mainly use this model for a robustness check, and use our StockTwits model for most of our analyses.<sup>18</sup>

## B.6 Model Explanations

We next uncover associations between the explanatory variables (words) and our model’s predictions. We implement SHapley Additive exPlanations (SHAP), a unified framework for

---

<sup>18</sup>We find few errors in our chat type classification, but it was not evaluated on a hand-tagged sample, and hence the results are not surprising.

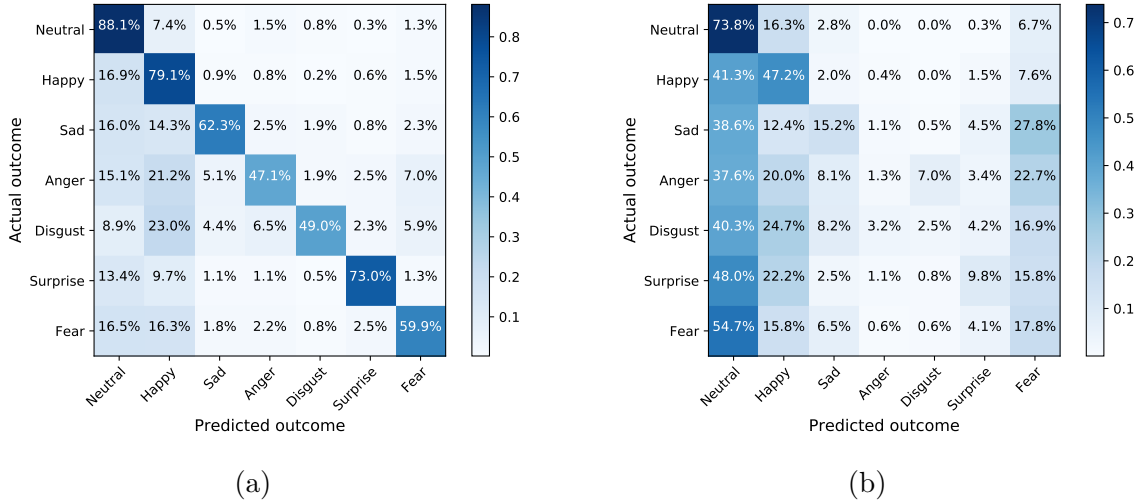

Figure B.2: Confusion Matrices for Emotion Classification Models.

Notes: (a) StockTwits based model, (b) Twitter based model. Results reported are based on performance on the hand-tagged sample for the best performing model on the validation set during five-fold CV.

interpreting predictions, to explain the output of our GRU model<sup>19</sup>. SHAP leverages a game theoretical concept to give each feature (word) a local importance value for a given prediction. Shapley values are local by design, yet they can be combined into global explanations by averaging the absolute Shapley values word-wise. Then, we can compare words based on their absolute average Shapley values, with higher values implying higher word importance.

To do the SHAP analysis, we draw a random sample of 100,000 StockTwits messages. Table B.3 reports average absolute SHAP for our StockTwits model. A quick inspection of Table B.3 confirm that our StockTwits model relates words to emotions correctly. When looking at the SHAP values of the Twitter model, Table B.4, however, we can see some of the roots of our misclassifications. In particular, we see significantly less emotionally charged words.

## B.7 Examples of Messages & Outputs

We provide examples of our model’s predictions in Table B.5.

<sup>19</sup>For a detailed description of the approach see Lundberg and Lee [2017].

Table B.3: Shap Values: StockTwits Model

	Neutral	Happy	Sad	Anger	Disgust	Surprise	Fear
wins	0.36	wins	maxpain	mad	losers	unusual	worry
healthy	0.35	funny	perfect	hate	waste	wow	bubble
funny	0.34	healthy	horrible	fuck	ugly	ohh	fear
serious	0.34	worry	worst	sucks	fake	insane	crude
gem	0.33	perfect	sadface	fucked	pathetic	weird	worthless
glad	0.33	rally	broken	fucking	stupid	wtf	scare
impressive	0.33	honest	desperate	dumb	crude	ridiculous	scary
best	0.32	hoping	tough	killing	turd	curious	operating
hoping	0.32	calm	weak	shit	idiots	nuts	correction
hot	0.32	unusual	sad	suck	lmfao	surge	worried
okay	0.32	cheers	dead	damn	sick	crazy	trap
calm	0.32	glad	crap	bitch	shorty	whoa	pump
FALSE	0.31	operating	hurt	pileofpoo	idiot	jesus	bearish
maxpain	0.31	latest	crying	die	garbage	chance	bearface
strong	0.31	safe	bad	freaking	manipulated	why	tanking
congrats	0.31	gfta	liquid	bear	screwed	wild	downside
party	0.31	epic	ouch	middlefinger	morons	blast	cold
rally	0.31	flying	pain	crude	lie	thinkingface	trouble
honest	0.31	best	crude	ass	pig	seriously	pressure
excellent	0.31	congrats	failed	serious	manipulation	holy	falling
loving	0.31	nice	fail	late	trash	omg	FALSE
amazing	0.30	impressive	rip	hell	fraud	surprise	contracts
desperate	0.30	party	ugh	sorry	bag	gossip	scared
nice	0.30	easy	facewithrollingeyes	common	scam	zanyface	warning
winning	0.30	happy	dang	base	fools	unbelievable	common
sweet	0.30	bullish	ripping	FALSE	bullshit	god	overbought
gfta	0.30	gem	bleeding	least	pumpers	personshrugging	trends
nicely	0.29	amazing	smh	hard	bs	flushedface	dumping
boring	0.29	smfw	mistake	sick	loser	foreign	pullback
awesome	0.29	loving	personfacepalming	boring	bags	sick	worries
favorite	0.29	great	death	shut	bagholders	operating	careful
flying	0.29	lol	common	slow	serious	uh	desperate
runner	0.29	moon	missed	cold	common	latest	wins
lol	0.29	desperate	cold	heavy	approximately	fair	squeeze
hodl	0.28	excellent	thumbsdown	silly	boring	lie	grimacingface
cheers	0.28	hot	regret	cheers	fool	interesting	run
great	0.28	winning	lose	usual	FALSE	guess	bankruptcy
guessing	0.28	strong	losing	green	base	clearly	dropping
bullish	0.28	hope	cry	game	heavy	best	bankrupt
beautiful	0.28	hodl	expensive	late	late	lol	inflation
happy	0.28	wow	expensive	worse	active	wk	doubt
interesting	0.28	sweet	sorry	down	sorry	outstanding	falls
love	0.28	love	poor	down	sorry	outstanding	falls
winkface	0.28	love	late	tired	lmao	perfect	dropped
least	0.28	awesome	burned	wrong	slow	internet	healthy
filled	0.28	favorite	funny	little	expensive	kind	pumping
beast	0.27	okay	FALSE	poor	clown	growing	dumped
foreign	0.27	smilingfacewithhorns	FALSE	wins	flat	happened	crash
winner	0.27	winkface	sick	small	small	filled	selloff
late	0.27	winner	loudlycryingface	black	tired	sure	dump
	0.27	winner	boring	direct	tight	software	panic

Average absolute SHAP values evaluated on a random sample of 100,000 StockTwits messages. Words reported, followed by their corresponding average absolute SHAP values, are the 50 most important words that appear at least 50 times in the SHAP sample. smfw=smilingfacewithopenmouthcoldswat.

Table B.4: Shap Values: Twitter Model

	Neutral	Happy	Sad	Anger	Disgust	Surprise	Fear
faceblowingakiss	8.18	faceblowingakiss	4.18	faceblowingakiss	1.37	faceblowingakiss	2.57
boring	2.55	snap	1.64	faceblowingakiss	0.75	boring	1.15
exhibits	2.54	fourth	1.58	idiots	0.51	releasing	1.08
self	2.34	regret	1.56	morons	0.42	loving	1.02
regret	2.31	exhibits	3.02	boring	0.35	cares	0.94
fwr	2.26	cares	2.79	ridiculous	0.26	morons	0.91
hrs	2.22	reaction	2.67	pathetic	0.26	idiots	0.40
stuck	2.22	created	2.30	fwr	0.25	insurance	0.91
letting	2.16	exciting	2.26	fed	0.25	anybody	0.39
south	2.09	hrs	2.19	yep	0.23	idiot	0.39
exciting	2.07	fib	2.17	stuck	0.23	panic	0.88
fourth	2.03	oncomingfist	2.12	idiot	0.22	delivry	0.38
fade	1.93	backs	2.10	cares	0.22	sucks	0.84
backs	1.90	itself	2.06	reaction	0.22	expensive	0.83
fell	1.89	fwr	2.02	oncomingfist	0.22	fwr	0.80
alright	1.81	boring	1.96	south	0.22	terms	0.78
fib	1.81	fell	1.95	pig	0.21	doge	0.77
pipeline	1.78	alright	1.88	backs	0.21	exciting	0.76
staying	1.76	wedge	1.85	revs	0.21	regret	1.32
created	1.64	fair	1.79	ii	0.20	king	1.26
wedge	1.63	morons	1.76	pic	0.20	fed	0.75
cares	1.59	king	1.74	pipeline	0.20	sideways	0.70
pic	1.58	pig	1.72	intelligence	0.20	hate	0.69
oncomingfist	1.56	pays	1.71	rebound	0.19	snaps	0.63
king	1.55	sideways	1.65	trash	0.18	result	0.63
signals	1.52	access	1.59	redheart	0.17	fuck	0.61
wins	1.51	pic	1.58	death	0.17	shit	0.61
death	1.51	hahaha	1.57	sucks	0.16	raise	1.03
pig	1.50	signals	1.54	sideways	0.16	ups	1.03
happy	1.49	rebound	1.52	sad	0.16	mho	1.00
sideways	1.45	happy	1.49	idiot	0.16	signals	1.00
somebody	1.45	yeah	1.47	reaction	0.15	steal	0.59
count	1.44	stuck	1.41	pathetic	0.15	south	0.58
reaction	1.38	reason	1.40	failed	0.15	fuckng	0.58
access	1.35	staying	1.38	worries	0.14	percentage	0.57
morons	1.32	south	1.27	neutral	0.14	worst	0.93
sucks	1.32	cry	1.27	fell	0.14	pic	0.92
benefit	1.25	happyface	1.26	downgrade	0.13	sadface	0.56
screwed	1.25	picture	1.25	stuck	0.13	alright	0.55
sfws	1.24	sept	1.25	rip	0.13	hearing	0.84
reason	1.24	joke	1.24	oncomingfist	0.13	joke	0.54
happyface	1.23	sucks	1.24	blocked	0.13	garbage	0.83
crap	1.22	remains	1.23	wins	0.13	sub	0.54
hahaha	1.22	beautiful	1.22	within	0.13	earning	0.82
beats	1.20	somebody	1.18	bankrupt	0.13	force	0.80
foreign	1.20	sub	1.18	fear	0.13	ish	0.80
happening	1.18	progress	1.18	reason	0.13	upward	0.80
plans	1.18	private	1.17	letting	0.13	word	0.79
joke	1.18	blocked	1.17	crap	0.13	reason	0.79
nervous	1.17	earning	1.15	snap	0.12	repeat	0.49
faceblowingakiss	3.76	faceblowingakiss	7.78	faceblowingakiss	1.37	faceblowingakiss	2.57
itself	1.91	failure	5.31	faceblowingakiss	0.75	boring	1.15
cares	1.81	benefit	4.18	idiots	0.51	releasing	1.08
regret	1.71	fade	3.51	morons	0.42	loving	1.02
regret	1.59	exhibits	3.02	boring	0.35	cares	0.94
fade	1.57	cares	2.79	ridiculous	0.26	morons	0.91
boring	1.55	reaction	2.67	pathetic	0.26	idiots	0.40
fourth	1.49	created	2.30	fwr	0.25	insurance	0.91
fell	1.48	exciting	2.26	fed	0.25	anybody	0.39
staying	1.48	hrs	2.19	yep	0.23	idiot	0.39
fwr	1.48	fib	2.17	stuck	0.23	panic	0.88
death	1.44	oncomingfist	2.12	idiot	0.22	delivry	0.38
nervous	1.44	backs	2.10	cares	0.22	sucks	0.84
exciting	1.39	itself	2.06	reaction	0.22	expensive	0.83
south	1.35	fwr	2.02	oncomingfist	0.22	fwr	0.80
backs	1.34	boring	1.96	south	0.22	crap	0.78
doge	1.34	fell	1.95	pig	0.21	exciting	0.77
hrs	1.33	alright	1.88	backs	0.21	regret	1.32
pig	1.32	alright	1.85	revs	0.21	whoever	1.26
freakng	1.26	wedge	1.85	exciting	0.21	regret	0.75
somebody	1.19	fair	1.79	letting	0.20	king	0.75
yeah	1.15	morons	1.76	fade	0.20	fed	0.70
page	1.10	king	1.74	forming	0.20	sideways	0.69
stuck	1.09	pig	1.72	alright	0.19	hate	0.67
failure	1.07	pays	1.71	regret	0.19	snaps	0.63
idiot	1.05	sideways	1.65	losers	0.18	result	0.63
created	1.03	access	1.59	page	0.17	fuck	0.61
gift	1.03	pic	1.58	garbage	0.17	shit	0.61
direction	1.03	hahaha	1.57	cry	0.16	raise	0.61
crap	1.00	signals	1.54	apex	0.16	ups	0.60
sfws	1.00	rebound	1.52	pipeline	0.16	mho	0.60
sideways	1.00	happy	1.49	grimacingface	0.16	signals	0.59
hearing	0.99	yeah	1.47	idiot	0.15	steal	0.58
winner	0.97	stuck	1.41	pathetic	0.15	south	0.58
sucks	0.96	reason	1.40	failed	0.15	fuckng	0.57
word	0.95	staying	1.38	worries	0.14	percentage	0.57
pic	0.93	south	1.27	neutral	0.14	worst	0.57
failed	0.92	cry	1.27	fell	0.14	pic	0.56
correlation	0.90	happyface	1.26	downgrade	0.13	sadface	0.55
king	0.88	picture	1.25	stuck	0.13	alright	0.55
lately	0.84	sept	1.25	rip	0.13	hearing	0.54
ratings	0.83	joke	1.24	oncomingfist	0.13	joke	0.54
signals	0.83	sucks	1.24	blocked	0.13	garbage	0.54
partner	0.83	remains	1.23	wins	0.13	sub	0.54
joke	0.82	beautiful	1.22	within	0.13	earning	0.53
fair	0.80	somebody	1.18	bankrupt	0.13	force	0.53
waste	0.80	sub	1.18	fear	0.13	ish	0.52
morons	0.80	progress	1.18	reason	0.13	upward	0.52
holy	0.79	private	1.17	letting	0.13	word	0.52
reached	0.79	blocked	1.17	crap	0.13	reason	0.51
reaction	0.79	earning	1.15	snap	0.12	repeat	0.49

Average absolute SHAP values evaluated on a random sample of 100,000 StockTwits messages. Words reported, followed by their corresponding average absolute SHAP values, are the 50 most important words that appear at least 50 times in the SHAP sample. sfws = smilingfacewithsmilingeyes, sfm = sfm, fwr = facewithrollingeyes.



Table B.5: Examples of Model Outputs

Text	Emotion	Emotion (%)	Type
awake the kraken companyplaceholder	99.87%	neutral	chat
piano keys musicalkeyboard companyplaceholder	99.95%	neutral	chat
very undervalued companyplaceholder	99.86%	neutral	finance
deutschebank chief economist calls for billion bailout of european banks companyplaceholder numbervalueplaceholder	99.97%	neutral	finance
time for celebratory dab windface companyplaceholder numbervalueplaceholder	100.00%	happy	chat
haha let us just say my wife is cool with my whiskey collection i have about bottles companyplaceholder numbervalueplaceholder	97.82%	happy	chat
blood in the streets with a huge catalyst on the way love companyplaceholder	100.00%	happy	finance
buy buy buy smilingfacewithhearteyes smilingfacewithhearteyes smilingfacewith-horns smilingfacewithhearteyes smilingfacewithhearteyes companyplaceholder	100.00%	happy	finance
weak hands drill companyplaceholder	99.99%	sad	chat
darn companyplaceholder	100.00%	sad	chat
ok bears we get it we are all terribly sorry for provoking you now please gogo go home and let us have our apple back companyplaceholder	99.68%	sad	finance
zerohedge is accurate on articles yes economy doing bad in the end the private federal reserve printers and its shareholders trump all companyplaceholder	99.99%	sad	finance
this is annoying companyplaceholder	99.99%	anger	chat
still f***ing companyplaceholder	99.99%	anger	chat
just taking out some trash i hope to hell he is short not nice at all companyplaceholder	99.82%	anger	finance
the type of bullshit we have to hear all day from stupid a** bears companyplaceholder	99.99%	anger	finance
is pretty laughable companyplaceholder dollarvalueplaceholder	99.97%	disgust	chat
she is nasty companyplaceholder	99.98%	disgust	chat
bears sacrifice their money to save you from stocks that make you too much money too fast philanthropists they are clown face companyplaceholder	62.71%	disgust	finance
is this garbage going to be well below by the end of the week companyplaceholder numbervalueplaceholder	99.97%	disgust	finance
oh no what happened ac companyplaceholder	100.00%	surprise	chat
trap door or trampoline right here imo will be interesting companyplaceholder	49.38%	surprise	chat
now you know again why his name is fkman companyplaceholder	100.00%	surprise	chat
so would you rather hold heb stock for months or take a nail gun to the groin geez that is tough how much psi on the nail gun companyplaceholder numbervalueplaceholder	85.76%	surprise	finance
what a crazy good week for the market companyplaceholder	100.00%	surprise	finance
anyone scared about next week companyplaceholder	100.00%	fear	chat
trolling is an essential part of modern day politics emotion drives irrational decisions opportunity trump has mastered the art companyplaceholder	84.71%	fear	chat
pumpaty pump then dumpaty dump companyplaceholder	100.00%	fear	finance
every bad news is followed or before by future promises same story last recyclingsymbol after the promises are silenced to dead or adapted companyplaceholder numbervalueplaceholder	100.00%	fear	finance

## C Why EmTract?

### C.1 Alternative Packages

We are aware of alternative text to emotion libraries, such as <https://github.com/aman2656/text2emotion-library>.<sup>20</sup> Text2Emotion uses a dictionary based method to classify text into five classes: happy, sad, fear, anger, surprise. We found this to be inadequate for several reasons. First, a number of messages are automated on social media, which might contain emotional words, yet they should be treated as neutral. Second, we found Text2Emotion to perform significantly worse on our hand-tagged sample, and do so significantly slower. In particular, the categorical cross-entropy loss(accuracy) for our StockTwits model on this sample is 1.47(76.1%), for the Twitter model it is 1.59(43.9%), while Text2Emotion achieves a poor 20.46(25.2%).<sup>21</sup> In addition, our model submits text predictions in batches, which significantly expedites time spent on inference. Based on the demo available for Text2Emotion, it took the package 12 minutes to compute emotions for our hand-tagged sample, while it took a second with our model. Because of these, and to be consistent with controlled laboratory experiments, we constructed seven emotions, adding neutral and disgust to the list, and developed an open-source package for researchers to use.

### C.2 User Guide

A user guide for our python package to extract emotions from short text data (i.e., tweets, texts) is available at <https://github.com/dvamosy/EmTract>.

## D StockTwits Activity & Sample Distributions

Table D.1 presents the descriptive statistics on StockTwits activity for our sample. In particular, it reports the frequency distributions by calendar year. We can see a dramatic rise in StockTwits activity over our sample period: starting from 49,074 messages in 2010 to 10,584,254 messages in 2020. This pattern demonstrates the increased popularity of social media during the decade of 2010. Similarly, our coverage also expands to more firm-day observations, from 1,660 in 2010 to 129,565 in 2020.

---

<sup>20</sup>We also trained BERT and DistilBERT models using <https://huggingface.co/bhadresh-savani/distilbert-base-uncased-emotion>, but these substantially increased the training and inference time with limited performance gains.

<sup>21</sup>We posted the hand-tagged sample on our GitHub repo. To be fair, we removed posts relating to disgust, which left us with 9,472 posts. For Text2Emotion, if the returned dictionary contained only 0s, we classified it as neutral.

We also compare the sample distributions of messages and firm-quarters by the Fama-French 12-industry groupings with the CRSP universe during our sample period. The results are reported in Table D.2. Our sample spans all 12 industries. It is heavier on tech and healthcare firms, and contains less financial firms.

Table D.1: Distribution of Twits by Calendar Year

	(1) Firm-Day Observations	(2) Twits
2010	455	24,664
2011	1,325	85,556
2012	2,088	254,493
2013	3,235	346,669
2014	5,748	604,403
2015	8,354	747,409
2016	11,264	1,038,194
2017	20,860	2,302,809
2018	26,658	2,888,071
2019	28,937	2,757,242
2020	59,430	8,353,743
2021	39,484	6,761,994
Total	207,838	26,165,247

Table D.2: Distribution of Twits Based on Fama-French 12-Industry Classification

Fama-French industry code (12 industries)	(1) CRSP (%)	(2) Twits (%)	(3) Firm-Day (%)
Consumer NonDurables – Food, Tobacco, Textiles, Apparel, Leather, Toys	3.97	2.21	2.65
Consumer Durables – Cars, TV's, Furniture, Household Appliances	2.29	8.47	4.37
Manufacturing – Machinery, Trucks, Planes, Off Furn, Paper, Com Printing	8.51	3.03	4.41
Oil, Gas, and Coal Extraction and Products	3.13	1.34	2.49
Chemicals and Allied Products	2.37	1.45	1.54
Business Equipment – Computers, Software, and Electronic Equipment	15.03	24.67	23.96
Telephone and Television Transmission	1.75	1.10	1.74
Utilities	2.47	0.27	0.56
Wholesale, Retail, and Some Services (Laundries, Repair Shops)	7.43	5.81	7.33
Healthcare, Medical Equipment, and Drugs	15.39	32.89	35.25
Finance	23.94	3.39	5.46
Other – Mines, Constr, BldMt, Trans, Hotels, Bus Serv, Entertainment	13.72	15.37	10.24
Observations	9,754,901	26,165,247	207,838

CRSP sample follows the same basic sample restrictions; active, traded on U.S. exchanges.

# Online Appendix to “EmTract: Extracting Emotions from Social Media”

## A Misspell Correction

We leverage SymSpell (<https://github.com/wolfgarbe/SymSpell>) for correcting misspellings. First, we obtain the vocabulary of our combined StockTwits and Twitter data and corresponding word frequencies. We remove stock tickers, emojis, emoticons and words that appear in the NLTK corpus. We then check whether these words appear in the SymSpell dictionary, if they do, we are done - no correction needed. Next, We proceed with words that do not appear in the SymSpell dictionary and segment these (“ilike” is segmented to “i like”). If the only difference between the corrected segment and the original word is spacing, and if each of the words appear in the SymSpell dictionary then we use segmentation. We then continue with the rest and apply auto-correction, setting “max\_edit\_distance” to four (i.e, find words that are at most four letters off). We use the corrections for words that are at most one letter off by retaining the most frequent match, using frequencies first from our frequency dictionary then SymSpell’s. We noticed that words that are more than four letters off are often words such as “ilikeyousosomuch”, so we segment them. We discard repeated patterns (words that appear more than 3 times in a row), and keep only the first fifteen words from the segments. First, our text cleaning reduced the size of our vocabulary from 17.9M words, includes numbers and special characters, to 3M. Then, our misspell correction further reduced it to 1.5M; this is important, since we only use the 32,457 most common words. Almost 1M of these corrections are white-spacing only (e.g., “aahstop” → “aah stop”), while around 500k of these corrections are one letter off (e.g., “alchol” → “alcohol”). We inspected the word correction output, and albeit imperfect, we believe it still helps.

## B Dictionaries

After thorough review of our messages, we created fourteen word lists. Twelve to capture the emotional state, and two to extract whether the twit contains information directly related to earnings, firm fundamentals and/or stock trading. We do these two classifications separately, so that each message will be classified into both emotions and information. Our emotion dictionaries mostly come from Li et al. [2016] and <http://saifmohammad.com/WebPages/lexicons.html>, while our information dictionaries use Bartov et al. [2018] with a small number of additions. To attach emotional states to our emojis, we use <https://unicode.org>.

org/Public/emoji/13.0/emoji-test.txt. We summarize them in Table B.1, and make them available in our GitHub repository (see <https://github.com/dvamossy/EmTract/tree/main/emtract/data>).

Table B.1: Dictionaries for Training Data

Word List	# of Entries
<b>Panel A: Emotions</b>	
Happy	982
Fear	782
Disgust	705
Sad	609
Surprise	305
Anger	733
Happy Emojis & Emoticons	99
Sad Emojis & Emoticons	33
Anger Emojis & Emoticons	16
Fear Emojis & Emoticons	22
Surprise Emojis & Emoticons	12
Disgust Emojis & Emoticons	9
<b>Panel B: Information</b>	
Finance	270
Earnings	84

## C Model Explanations

We next investigate the distribution of SHAP values for some of the most influential words. Figure C.1 plots it for the ten most important words for each emotions. For instance, the second entry in Panel (b) of Figure C.1 is “wow”, and this word is strongly associated with an increased model output for the surprise class. As another example, the ninth entry of Panel (f) is “crude”, which has a dispersed distribution, illustrating that in certain cases the word “crude” nudges the model’s prediction towards fear by relatively insignificantly<sup>22</sup>. A quick inspection of Figure C.1 and Table B.3 confirm that our StockTwits model relates words to emotions correctly. When looking at the SHAP values of the Twitter model, however, we can see some of the roots of our misclassifications. For instance, “fourth” is a strong predictor for the happy class, while “fear” is a strong predictor for surprise.

The interpretability results for our “chat type” model are as expected (see Table C.1). For instance, words such as ugh, sweet, and boring are associated with a higher predicted probability for our “chat” class.

<sup>22</sup>Crude oil has a very different meaning than a crude person.

Table C.1: Shap Values: Chat Type

Most Important Words	
quickly	0.16
yep	0.08
ugh	0.08
boring	0.08
sweet	0.08
yup	0.08
ouch	0.07
vrng	0.07
hello	0.07
ohh	0.07
goo	0.06
omg	0.06
uh	0.06
redheart	0.06
t	0.06
baby	0.06
boom	0.06
mother	0.06
rimm	0.06
winkface	0.06
girl	0.06
holy	0.06
climb	0.06
break	0.06
companyplaceholder	0.06
bears	0.06
touch	0.06
sells	0.06
mode	0.06
blocked	0.05
flushedface	0.05
halt	0.05
her	0.05
bulls	0.05
downgrades	0.05
flush	0.05
lunch	0.05
unbelievable	0.05
leg	0.05
airplane	0.05
da	0.05
beautiful	0.05
charge	0.05
okay	0.05
she	0.05
buys	0.05
numbervalueplaceholder	0.05
halted	0.05
bankruptcy	0.05
exciting	0.05

Average absolute SHAP values evaluated on a random sample of 100,000 StockTwits messages. Words reported, followed by their corresponding average absolute SHAP values, are the 50 most important words that appear at least 50 times in the SHAP sample.

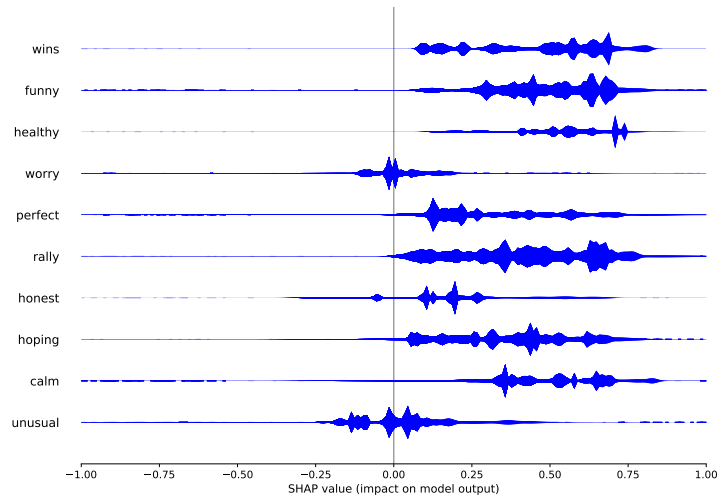

(a) Happy

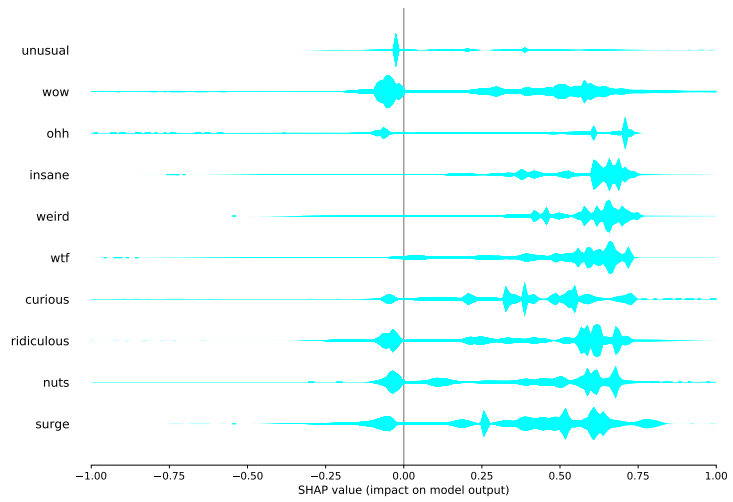

(b) Surprise



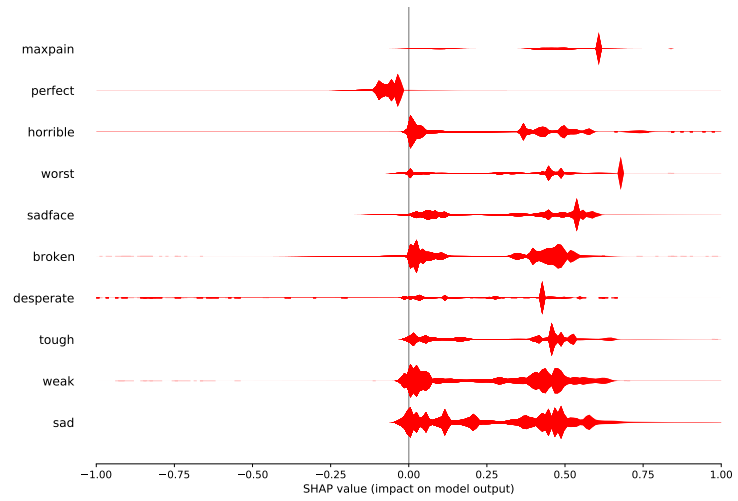

(c) Sad

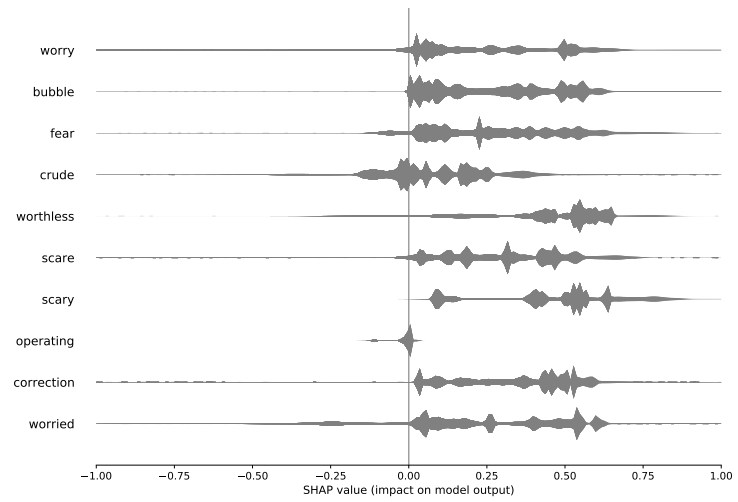

(d) Fear

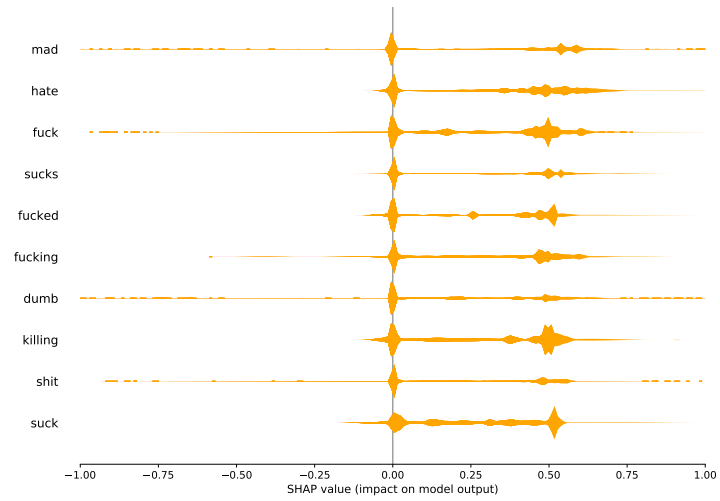

(e) Anger

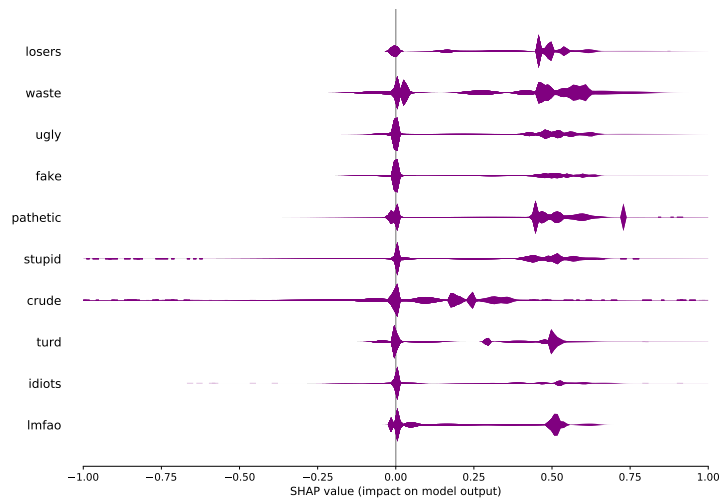

(f) Disgust

Figure C.1: Selected Distribution of Word Importances for StockTwits Emotion Model.

Notes: SHAP values evaluated on a random sample of 100,000 StockTwits messages. (a) happy, (b) surprise, (c) sad, (d) fear, (e) anger, (f) disgust. Not shown here: neutral.

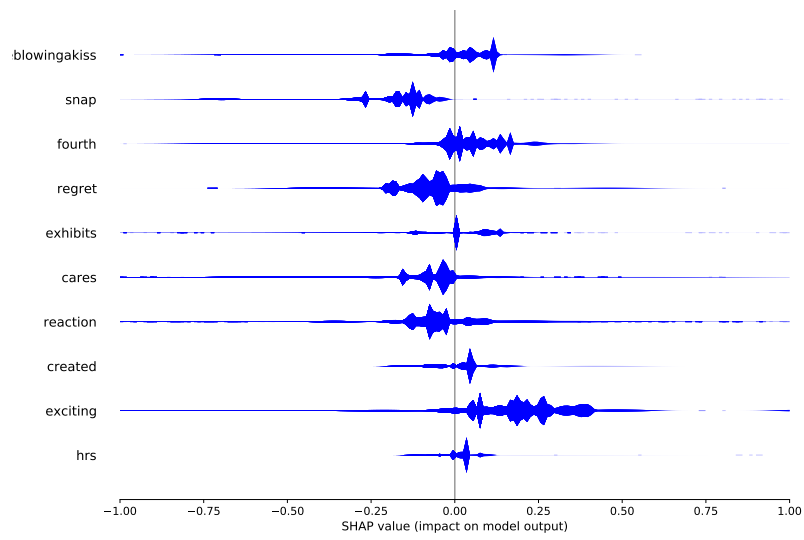

(a) Happy

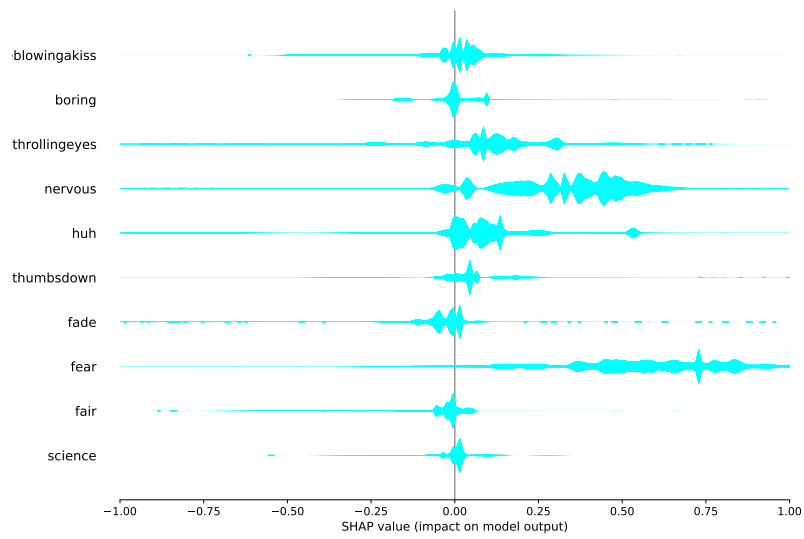

(b) Surprise

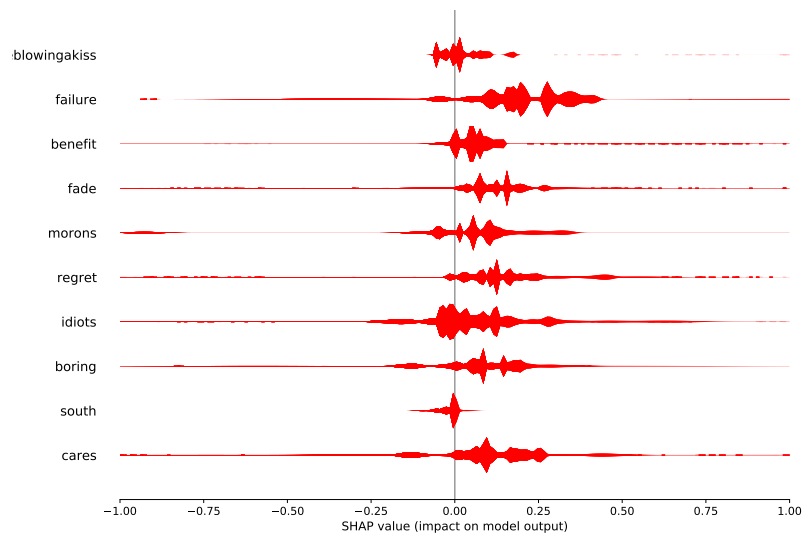

(c) Sad

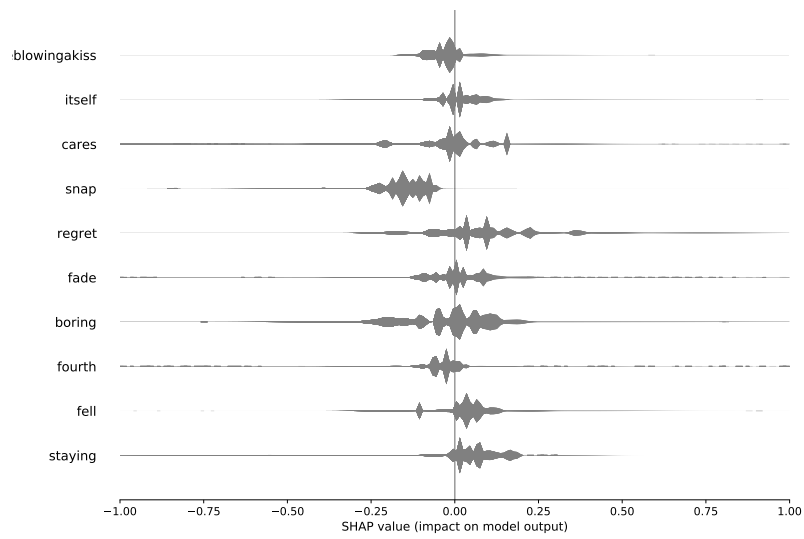

(d) Fear

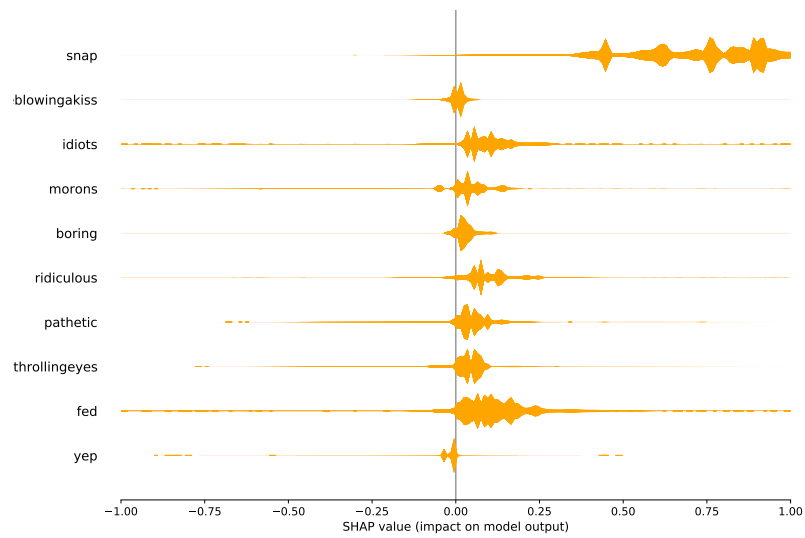

(e) Anger

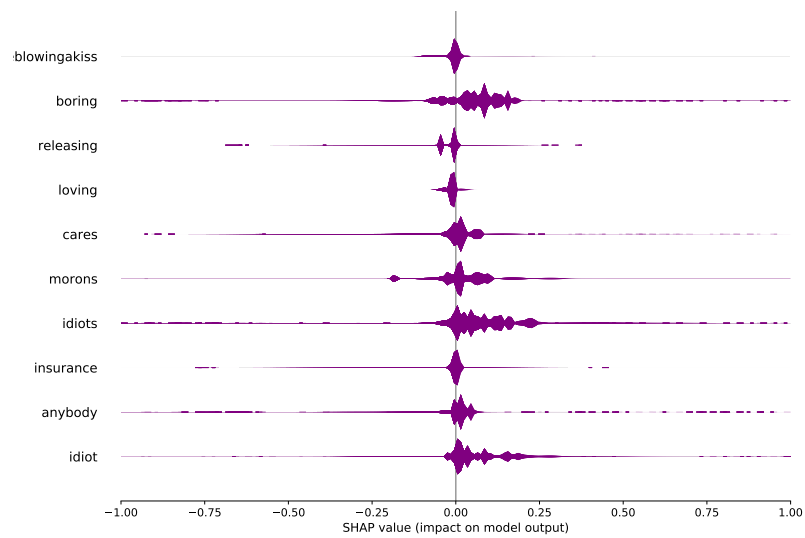

(f) Disgust

Figure C.1: Distribution of Word Importances for Twitter Emotion Model.

Notes: SHAP values evaluated on a random sample of 100,000 StockTwits messages. (a) happy, (b) surprise, (c) sad, (d) fear, (e) anger, (f) disgust. Not shown here: neutral.

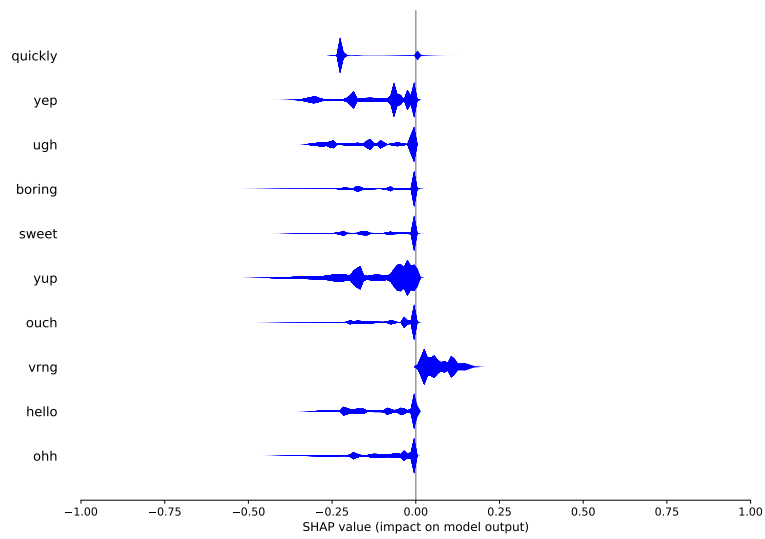

(a)

Figure C.2: Distribution of Word Importances for Information Content Model.

Notes: SHAP values plotted for the “finance” class. Given that the ranking is based on absolute average SHAP values, the “chat” class values are the negative of the “finance” class values.

## D Document Similarity

We examine whether a model trained on Twitter is transferable to StockTwits by comparing how similar twits (i.e., StockTwits messages) are to tweets (i.e., Twitter messages). The results are mixed. We first compare them at the document level. To do so, we use our entire Twitter training data, draw a random sample with the same number of messages from our StockTwits data, and treat them as separate entities. We augment this with a collection of texts from <https://www.nltk.org/book/ch02.html>. These include popular journals pertaining to various categories (e.g., New York Times: Sport, Wall Street Journal: Finance), texts from the Brown Corpus (used to study systematic differences between genres), a collection of positive, negative, and unlabeled tweets from Twitter, and a chapter from the Bible (i.e., Genesis).

Table D.1 presents the results. Without getting lost in the details, this table shows us that our Twitter training data and the StockTwits sample have a similar vocabulary size, StockTwits is slightly more diverse, but less complex. In terms of cosine similarities, our Twitter training data is more similar to NLTK texts included than our StockTwits text. This makes sense, since our Twitter data contains casual conversations, while our StockTwits data discusses financial markets in a social media context. We also cluster our texts into three clusters using k-means clustering (Arthur and Vassilvitskii [2006]). This unsupervised learning approach groups documents together that appear most similar. Based on this, our StockTwits sample belongs to the same class as our Twitter training data, while no other documents are in this cluster.

Table D.1 shows us that our messages and tweets are more similar to each other than messages and newspaper articles or the other documents included in our comparison. However, this does not tell us whether messages and tweets are interchangeable. To get a better sense, we next compare them at the message level. We do this by drawing a random sample of 10,000 messages from StockTwits and 10,000 tweets from Twitter. We compute message-by-message cosine-similarities between twits and twits, twits and tweets, and tweets and tweets.<sup>23</sup> This gives us a matrix of size  $10,000 \times 10,000$  for StockTwits and Twitter, and we take one of the  $10,000 \times 10,000$  matrices for our StockTwits-Twitter similarities. We discard the diagonal elements of our StockTwits and Twitter matrices, and plot the distributions in Figure D.1. Visual inspection and Two-Sample KS-tests tell us that when we compare our twits to tweets at the message level they do not seem to be interchangeable. This is yet another warning sign that cautions us against using the Twitter trained model.

---

<sup>23</sup>We use a 200-dimensional Twitter based Glove embedding, and use Řehůřek and Sojka [2010] to compute the cosine similarities.

Table D.1: Document Similarity

Document	Vocabulary	Total Words	Complexity	Diversity	Cosine Similarity	Cluster
Adventure	7874	334889	13.606	0.009	0.806	0
Editorial	8586	331345	14.916	0.01	0.833	0
Fiction	8331	334313	14.409	0.01	0.81	0
Genesis-English-Web	2430	188666	5.594	0.014	0.757	0
Government	6864	396904	10.895	0.012	0.808	0
Hobbies	9911	441323	14.919	0.009	0.826	0
Humor	4613	109286	13.954	0.008	0.822	0
Learned	14201	1015908	14.089	0.012	0.812	0
Mystery	6135	274529	11.709	0.009	0.798	0
Negative Tweets	10647	321935	18.765	0.004	0.558	1
New York Times: Editorials	827	12584	7.372	0.012	0.781	0
New York Times: Political	801	12960	7.036	0.012	0.757	0
New York Times: Sport	845	12272	7.628	0.012	0.743	0
News	11880	543146	16.12	0.01	0.829	0
Positive Tweets	13175	373440	21.56	0.004	0.476	1
Religion	5780	207979	12.674	0.011	0.822	0
Reviews	7705	218527	16.482	0.01	0.823	0
Romance	7500	335805	12.942	0.008	0.79	0
Science Fiction	2959	72153	11.016	0.009	0.799	0
Stocktwits Messages	30541	11805543	8.889	0.01	0.233	2
Times: National Affairs	867	12972	7.612	0.011	0.754	0
Tweets	19045	2450175	12.167	0.006	0.314	1
Twitter: Training Data	32431	8089677	11.402	0.007	0.651	2
Wall Street Journal: Financial	765	12245	6.913	0.011	0.708	0
Wall Street Journal: Reviews	925	13043	8.099	0.013	0.779	0
Washington Post: Cultural	817	12407	7.335	0.015	0.774	0

We define Complexity =  $\frac{\text{Vocabulary}}{\sqrt{\text{TotalWords}}}$  and Diversity =  $\sum_{n=0}^k \left( \frac{\text{\#of occurrences word}_n}{\text{TotalWords}} \right)^2$  for each word n in the dictionary. Clustering is done via k-means clustering, with k= 3.



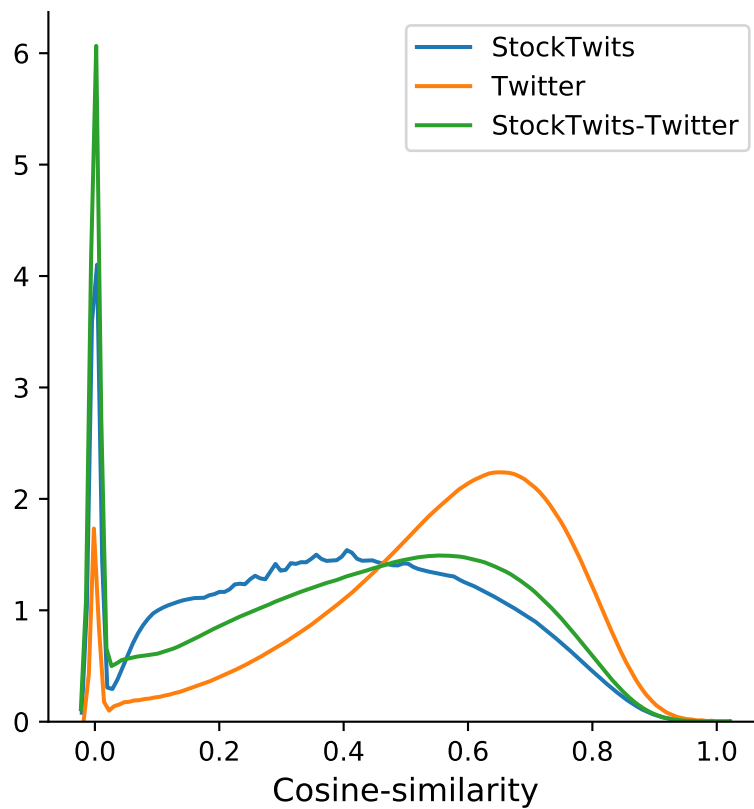

Figure D.1: Twit-Tweet Similarities

Notes: The Two-Sample Kolmogorov-Smirnov statistics are: 0.319, 0.070, 0.250 for testing whether our StockTwits vs. Twitter, StockTwits vs. StockTwits-Twitter and Twitter vs. StockTwits-Twitter come from the same distribution. Each rejects the null hypothesis with p-value < 0.01.