

CHARACTERIZING THE COMMUTATOR IN VARIETIES WITH A DIFFERENCE TERM

KEITH A. KEARNES, ÁGNES SZENDREI, AND ROSS WILLARD

ABSTRACT. We extend the validity of Kiss’s characterization of “ $[\alpha, \beta] = 0$ ” from congruence modular varieties to varieties with a difference term. This fixes a recently discovered gap in our paper [8]. We also prove some related properties of Kiss terms in varieties with a difference term.

1. INTRODUCTION

In [3], H. Peter Gumm characterized the commutator relation “ $[\alpha, \beta] = 0$ ” when α and β are comparable congruences ($\alpha \leq \beta$) on an algebra in a congruence modular variety. His characterization involved the concept of a 3-ary difference term (or “Gumm term”). A 3-ary difference term for a variety \mathcal{V} is a 3-ary term $p(x, y, z)$ such that

(I)_p $p(x, x, y) \approx y$ holds in every member of \mathcal{V} , while

(II)_p $p(a, b, b) \stackrel{[\theta, \theta]}{\equiv} a$ whenever $(a, b) \in \theta \in \text{Con}(\mathbf{A})$ for some $\mathbf{A} \in \mathcal{V}$.

Gumm showed that (i) every congruence modular variety has a 3-ary difference term, while it is easy to verify (using [7, Corollary 4.7]) that (ii) $p(x, y, z) = z$ is a 3-ary difference term for any congruence meet-semidistributive variety. The class of all varieties having a difference term is a natural class to study: it is intermediate between the class of congruence modular varieties and the class of Taylor varieties, it is definable by a (linear) Maltsev condition [11, 7, 8], and the commutator operation is fairly well-behaved in this class [10, 5, 7] – in particular, the commutator operation is commutative in varieties with a difference term [5, Lemma 2.2].

In [9, Definition 3.3], Emil Kiss introduced the concept of a 4-ary difference term for congruence modular varieties. He used this concept to characterize the relation “ $[\alpha, \beta] = 0$ ” when α and β are not-necessarily-comparable congruences on an algebra in a congruence modular variety. The definition of a 4-ary difference term refers to a

Date: February 15, 2022.

2010 Mathematics Subject Classification. Primary: 08B05. Secondary: 08A05, 08A30.

Key words and phrases. difference term, Kiss term, variety, commutator.

This material is based upon work supported by the National Research, Development and Innovation Fund of Hungary (NKFI) grant no. K128042, and a Natural Sciences and Engineering Research Council (NSERC) of Canada Discovery Grant.

4-ary relation $R(\alpha, \beta)$ defined from $\alpha, \beta \in \text{Con}(\mathbf{A})$, $\mathbf{A} \in \mathcal{V}$ as follows:

$$R(\alpha, \beta) = \{(a, b, c, d) \in A^4 : (a, b), (c, d) \in \alpha \text{ and } (a, c), (b, d) \in \beta\}.$$

$R(\alpha, \beta)$ is a subalgebra of \mathbf{A}^4 . A 4-ary difference term (or “Kiss term”) for a variety \mathcal{V} is a 4-ary term $q(x, y, z, w)$ such that

- (I)_q $q(x, x, y, y) \approx y$ and $q(x, y, x, y) \approx x$ hold in every member of \mathcal{V} , while
- (II)_q $q(a, b, c, d) \stackrel{[\alpha, \beta]}{\equiv} q(a, b, c', d)$ holds whenever $\alpha, \beta \in \text{Con}(\mathbf{A})$, $\mathbf{A} \in \mathcal{V}$, and $(a, b, c, d), (a, b, c', d) \in R(\alpha, \beta)$.

Kiss shows in his paper that (i) every congruence modular variety has a 4-ary difference term, while it is easy to verify that (ii) $q(x, y, z, w) = z$ is a 4-ary difference term for any congruence meet-semidistributive variety.

At the top of page 467 of [9], Kiss states that if $q(x, y, z, w)$ is a 4-ary difference term for a congruence modular variety \mathcal{V} , then $p(x, y, z) := q(x, y, z, z)$ will be a 3-ary difference term for \mathcal{V} . We give the argument for this in the next paragraph in order to illustrate that this statement does not require \mathcal{V} to be congruence modular.

Assume that $q(x, y, z, w)$ is a 4-ary difference term for \mathcal{V} and define $p(x, y, z) = q(x, y, z, z)$. From the identity $q(x, x, y, y) \approx y$, which is part of (I)_q, we derive that $p(x, x, y) = q(x, x, y, y) \approx y$ holds in every member of \mathcal{V} , which is the claim of (I)_p. That is, (I)_q suffices to prove (I)_p if $p(x, y, z) = q(x, y, z, z)$. Now assume that $\mathbf{A} \in \mathcal{V}$ and $(a, b) \in \theta \in \text{Con}(\mathbf{A})$. Let $\alpha = \beta = \theta$. Then $(A, B, C, D) := (a, b, b, b)$ and $(A, B, C', D) := (a, b, a, b)$ both belong to $R(\alpha, \beta) = R(\theta, \theta)$. From the defining properties (I)_q and (II)_q of q we get

$$p(a, b, b) = q(a, b, b, b) = q(A, B, C, D) \stackrel{[\theta, \theta]}{\equiv} q(A, B, C', D) = q(a, b, a, b) = a.$$

This is the claim of (II)_p. That is, (I)_q and (II)_q suffice to prove (II)_p if $p(x, y, z) = q(x, y, z, z)$.

In Problem 3.11 of his paper, Kiss asks whether, conversely, there is a reasonable way to construct a 4-ary difference term from a 3-ary difference term. Paolo Lipparini solved this problem in [12], by showing that, for any variety,

$$(L) \quad q(x, y, z, w) := p(p(x, z, z), p(y, w, z), z)$$

is a 4-ary difference term whenever $p(x, y, z)$ is a 3-ary difference term. This shows that a variety has a 3-ary difference term if and only if it has a 4-ary difference term, and we will refer to such a variety as a “variety with a difference term”. We will reserve the phrase “difference term” for a 3-ary difference term p and use the phrase “Kiss term” for a 4-ary difference term q .

Our goal in this paper is to show that Kiss’s characterization of “[α, β] = 0” holds for any variety with a difference term, whether the variety is congruence modular or not.

In fact, we already claimed to have done this in [8, Lemma 6.2]. But recently, Ralph Freese and Peter Mayr discovered that the proof in [8] of Lemma 6.2 has a gap. Lemma 6.2 of [8] states (under the assumption that \mathcal{V} has a difference term and q is the Kiss term obtained from it via Lipparini's Formula (L)):

Lemma 6.2 of [8]. *If $\mathbf{A} \in \mathcal{V}$ and $\alpha, \beta \in \text{Con}(\mathbf{A})$, then $[\alpha, \beta] = 0$ iff*

- (i) $q: R(\alpha, \beta) \rightarrow \mathbf{A}$ is a homomorphism, and
- (ii) q is independent of its third variable on $R(\alpha, \beta)$.

The incomplete part of the proof of Lemma 6.2 in [8] concerns the implication

$$[\alpha, \beta] = 0 \quad \text{implies} \quad \text{Item (i)}.$$

In this paper we will fill the gap with

Theorem 1.1. *If \mathcal{V} is a variety with difference term p , $q(x, y, z, w)$ is the Kiss term obtained from p via (L), $\mathbf{A} \in \mathcal{V}$, $\alpha, \beta \in \text{Con}(\mathbf{A})$, and $[\alpha, \beta] = 0$, then $q: R(\alpha, \beta) \rightarrow \mathbf{A}$ is a homomorphism.*

Then in Section 7 we will restate Lemma 6.2 of [8] and prove it.

Although Lemma 6.2 of [8] only makes a claim about the Kiss term q obtained from the difference term p by Lipparini's Formula (L), we shall prove in Section 8 that the statement of Lemma 6.2 holds for any Kiss term in any variety that has a Kiss term. Section 8 contains other refinements and extensions of results in earlier sections.

2. HIGH-LEVEL SUMMARY OF THE PROOF OF THEOREM 1.1

We represent a 4-tuple $(a, b, c, d) \in A^4$ in matrix form as

$$\begin{bmatrix} a & c \\ b & d \end{bmatrix}.$$

Thus a matrix in $R(\alpha, \beta)$ has its columns in α and its rows in β . To emphasize this representation, we shall henceforth rename \mathbf{A}^4 as $\mathbf{A}^{2 \times 2}$. As usual, we define $M(\alpha, \beta)$ to be the subalgebra of $\mathbf{A}^{2 \times 2}$ generated by

$$(2.1) \quad G(\alpha, \beta) := \left\{ \begin{bmatrix} c & c \\ d & d \end{bmatrix} : (c, d) \in \alpha \right\} \cup \left\{ \begin{bmatrix} a & c \\ a & c \end{bmatrix} : (a, c) \in \beta \right\}.$$

In the congruence modular setting, the ‘‘horizontal transitive closure’’ of $M(\alpha, \beta)$, denoted $\Delta_{\alpha, \beta}$, plays a key role. In that setting it turns out that $\Delta_{\alpha, \beta}$ is also ‘‘vertically transitively closed,’’ and hence $\Delta_{\beta, \alpha}$ is equal to the set of transposes of the matrices in $\Delta_{\alpha, \beta}$. These facts can fail outside the congruence modular setting. Andrew Moorhead [13] recently identified and studied the ‘‘horizontal and vertical transitive closure’’ of $M(\alpha, \beta)$ in a general setting. This 4-ary relation is an example of a construct that Moorhead calls a ‘‘2-dimensional congruence,’’ and George Janelidze and M. Cristina Pedicchio [4] previously called a ‘‘double equivalence relation.’’ Moorhead's

“horizontal and vertical transitive closure” of $M(\alpha, \beta)$ will play a crucial role in our arguments.

Definition 2.1 ([13, Definition 2.10 and Lemma 2.13]). Let \mathbf{A} be an algebra and $\alpha, \beta \in \text{Con}(\mathbf{A})$. $\Delta(\alpha, \beta)$ denotes the “horizontal and vertical” transitive closure of $M(\alpha, \beta)$. That is, $\Delta(\alpha, \beta)$ is the smallest subset of $R(\alpha, \beta)$ containing $M(\alpha, \beta)$ and satisfying the following two closure conditions:

- (1) (Horizontal gluing) If $\begin{bmatrix} a & a' \\ b & b' \end{bmatrix}, \begin{bmatrix} a' & a'' \\ b' & b'' \end{bmatrix} \in \Delta(\alpha, \beta)$, then $\begin{bmatrix} a & a'' \\ b & b'' \end{bmatrix} \in \Delta(\alpha, \beta)$.
- (2) (Vertical gluing) If $\begin{bmatrix} a & a' \\ b & b' \end{bmatrix}, \begin{bmatrix} b & b' \\ c & c' \end{bmatrix} \in \Delta(\alpha, \beta)$, then $\begin{bmatrix} a & a' \\ c & c' \end{bmatrix} \in \Delta(\alpha, \beta)$.

Here are the facts about $\Delta(\alpha, \beta)$ that we need.

Lemma 2.2 ([13, Lemma 2.9]). *For any algebra \mathbf{A} and congruences $\alpha, \beta \in \text{Con}(\mathbf{A})$, $\Delta(\alpha, \beta)$ is a subalgebra of $\mathbf{A}^{2 \times 2}$.*

Lemma 2.3. *For any algebra \mathbf{A} and congruences $\alpha, \beta \in \text{Con}(\mathbf{A})$, $\Delta(\beta, \alpha)$ is the set of transposes of matrices in $\Delta(\alpha, \beta)$.*

Lemma 2.4. *Suppose \mathbf{A} is an algebra in a variety with a difference term and $\alpha, \beta \in \text{Con}(\mathbf{A})$ with $[\alpha, \beta] = 0$.*

- (1) *If $\begin{bmatrix} a & c \\ b & d \end{bmatrix} \in \Delta(\alpha, \beta)$, then $a = c$ iff $b = d$.*
- (2) *If $\begin{bmatrix} a & c \\ b & d \end{bmatrix}, \begin{bmatrix} a & c' \\ b & d \end{bmatrix} \in \Delta(\alpha, \beta)$, then $c = c'$.*

Lemma 2.5. *Let \mathbf{A} be an algebra in a variety having a difference term $p(x, y, z)$ and let $q(x, y, z, w)$ be the Kiss term obtained from p via (L). If $\alpha, \beta \in \text{Con}(\mathbf{A})$ with $[\alpha, \beta] = 0$, then for all $\begin{bmatrix} a & c \\ b & d \end{bmatrix} \in R(\alpha, \beta)$ we have $\begin{bmatrix} a & c' \\ b & d \end{bmatrix} \in \Delta(\alpha, \beta)$ where $c' = q(a, b, c, d)$.*

Lemmas 2.2–2.4 are easy to prove. Theorem 1.1 follows easily from Lemmas 2.2–2.5, essentially following our (incorrect) proof in [8] except replacing $\Delta_{\alpha, \beta}$ at every step with $\Delta(\alpha, \beta)$. We shall prove Lemmas 2.2–2.4 in the next section.

Lemma 2.5 is not obvious. For example, in the congruence meet-semidistributive case (where $p(x, y, z)$ can be taken to be z) it implies the nonobvious fact that if $\alpha \cap \beta = 0$ then $R(\alpha, \beta) = \Delta(\alpha, \beta)$. Note that in congruence meet-semidistributive varieties, Moorhead’s analysis yields $R(\alpha, \alpha) = \Delta(\alpha, \alpha)$ for any congruence α [13, Theorem 5.2]; our Lemma 2.5 applied to the congruence meet-semidistributive case may be seen as extending Moorhead’s result to pairs of disjoint congruences. We will prove Lemma 2.5 in Sections 4 and 5 using our Maltsev condition for varieties with a difference term. The proof of Theorem 1.1 is completed in Section 6.

3. PROOFS OF LEMMAS 2.2–2.4

Proof of Lemma 2.2. This is a special case of [13, Lemma 2.9 (2)]. However, we include an alternative proof here because we will need some of its elements in our proofs of Lemma 2.4 and Theorem 8.8. Fix \mathbf{A} and congruences α, β . For $n \in \omega$ define $M_n(\alpha, \beta)$ by setting $M_0(\alpha, \beta) = M(\alpha, \beta)$, and for $n > 0$,

- If n is odd, then a matrix is in $M_n(\alpha, \beta)$ iff it can be realized as the result of horizontally gluing two matrices from $M_{n-1}(\alpha, \beta)$; that is,

$$\begin{bmatrix} a & c \\ b & d \end{bmatrix} \in M_n(\alpha, \beta) \quad \text{iff} \quad \exists r, s \in A \text{ with } \begin{bmatrix} a & r \\ b & s \end{bmatrix}, \begin{bmatrix} r & c \\ s & d \end{bmatrix} \in M_{n-1}(\alpha, \beta).$$

- If n is even, then a matrix is in $M_n(\alpha, \beta)$ iff it can be realized as the result of vertically gluing two matrices from $M_{n-1}(\alpha, \beta)$; that is,

$$\begin{bmatrix} a & c \\ b & d \end{bmatrix} \in M_n(\alpha, \beta) \quad \text{iff} \quad \exists r, s \in A \text{ with } \begin{bmatrix} a & c \\ r & s \end{bmatrix}, \begin{bmatrix} r & s \\ b & d \end{bmatrix} \in M_{n-1}(\alpha, \beta).$$

One can easily prove by induction that for each $n \geq 0$,

- (i) $M_n(\alpha, \beta)$ is a subalgebra of $\mathbf{A}^{2 \times 2}$,
- (ii) $M_n(\alpha, \beta) \subseteq \Delta(\alpha, \beta)$,
- (iii) $M_n(\alpha, \beta) \subseteq M_{n+1}(\alpha, \beta)$.

Hence if we let $M_\omega(\alpha, \beta) = \bigcup_{n=0}^{\infty} M_n(\alpha, \beta)$, then $M_\omega(\alpha, \beta)$ is a subalgebra of $\mathbf{A}^{2 \times 2}$ and $M_\omega(\alpha, \beta) \subseteq \Delta(\alpha, \beta)$. For the opposite inclusion, observe that if a matrix B can be obtained from two matrices $C, D \in M_\omega(\alpha, \beta)$ by gluing (either horizontally or vertically), then by (iii) there exists $n \in \omega$ such that $C, D \in M_n(\alpha, \beta)$ and hence $B \in M_{n+2}(\alpha, \beta)$. This proves that $M_\omega(\alpha, \beta)$ is closed under horizontal and vertical transitive closure, which implies $\Delta(\alpha, \beta) \subseteq M_\omega(\alpha, \beta)$. \square

Proof of Lemma 2.3. This follows easily from the symmetry between horizontal and vertical transitive closures in the definition of $\Delta(\alpha, \beta)$, and the fact that the set of generators for $M(\beta, \alpha)$ is the set of transposes of the generators for $M(\alpha, \beta)$. \square

Proof of Lemma 2.4. This can be deduced from [5, Lemma 2.2] and [7, Corollary 4.5] and the description of the linear commutator in [7]. For completeness, we give a short direct proof here. Fix \mathbf{A} and $\alpha, \beta \in \text{Con}(\mathbf{A})$ with $[\alpha, \beta] = 0$. To prove (1), we recycle the notation from the proof of Lemma 2.2 and show by induction on n that if $\begin{bmatrix} a & c \\ b & d \end{bmatrix} \in M_n(\alpha, \beta)$ then $a = c$ iff $b = d$. This claim follows automatically from $[\alpha, \beta] = 0$ if $n = 0$, so assume $n > 0$. Assume without loss of generality that $a = c$. If n is even, then there exist $r, s \in A$ with

$$\begin{bmatrix} a & a \\ r & s \end{bmatrix}, \begin{bmatrix} r & s \\ b & d \end{bmatrix} \in M_{n-1}(\alpha, \beta).$$

By the inductive hypothesis we get $r = s$ from the first matrix and then $b = d$ from the second matrix as required. If instead n is odd, then there exist $r, s \in A$ with

$$\begin{bmatrix} a & r \\ b & s \end{bmatrix}, \begin{bmatrix} r & a \\ s & d \end{bmatrix} \in M_{n-1}(\alpha, \beta).$$

One can show that each $M_k(\alpha, \beta)$ is closed under swapping columns, and we use that here to get $\begin{bmatrix} r & a \\ s & b \end{bmatrix} \in M_{n-1}(\alpha, \beta)$. Also note that our assumptions imply $(b, d) \in \alpha \cap \beta$, which with $[\alpha, \beta] = 0$ implies $p(d, b, b) = d$. Now use the usual trick: apply p to the following three matrices from $M_{n-1}(\alpha, \beta)$:

$$\begin{bmatrix} r & a \\ s & d \end{bmatrix}, \begin{bmatrix} r & a \\ s & b \end{bmatrix}, \begin{bmatrix} b & b \\ b & b \end{bmatrix}.$$

The resulting matrix $\begin{bmatrix} b & b \\ b & d \end{bmatrix}$ is again in $M_{n-1}(\alpha, \beta)$ (since $M_k(\alpha, \beta)$ is a subalgebra for any k). We can apply the inductive hypothesis to this last matrix to get $b = d$, which was our aim.

(2) Suppose

$$\begin{bmatrix} a & c \\ b & d \end{bmatrix}, \begin{bmatrix} a & c' \\ b & d \end{bmatrix} \in \Delta(\alpha, \beta).$$

Swapping the two columns of the first matrix gives $\begin{bmatrix} c & a \\ d & b \end{bmatrix} \in \Delta(\alpha, \beta)$. This last matrix can be glued horizontally to the second matrix above to get a matrix in $\Delta(\alpha, \beta)$ whose entries on the bottom row are equal, and having c, c' as the entries on the top row. We then get $c = c'$ from part (1). \square

4. PROOF OF LEMMA 2.5: REDUCTION

Throughout this section we fix a variety \mathcal{V} having a difference term $p(x, y, z)$. Let $\mathbf{F} = \mathbb{F}_{\mathcal{V}}(x, y, z, w)$ be the free algebra over $\{x, y, z, w\}$ in \mathcal{V} . We will consider a certain set T of 2×2 matrices with entries in F , defined as follows: if

$$M = \begin{bmatrix} t_1 & t_3 \\ t_2 & t_4 \end{bmatrix} = \begin{bmatrix} t_1(x, y, z, w) & t_3(x, y, z, w) \\ t_2(x, y, z, w) & t_4(x, y, z, w) \end{bmatrix} \in F^{2 \times 2},$$

then

$M \in T \iff$ For all $\mathbf{A} \in \mathcal{V}$, for all $\alpha, \beta \in \text{Con}(\mathbf{A})$ with $[\alpha, \beta] = 0$, and

for all $\begin{bmatrix} a & c \\ b & d \end{bmatrix} \in R(\alpha, \beta)$ we have $\begin{bmatrix} t_1(a, b, c, d) & t_3(a, b, c, d) \\ t_2(a, b, c, d) & t_4(a, b, c, d) \end{bmatrix} \in \Delta(\alpha, \beta)$.

Our ultimate goal is to prove Lemma 2.5. Note that this is equivalent to proving $\begin{bmatrix} x & q \\ y & w \end{bmatrix} \in T$ where q is the Kiss term obtained from p by (L).

In what follows, for readability, we will frequently suppress commas in rendering terms. For example, we may write $p(xzz)$ for $p(x, z, z)$.

Lemma 4.1. *If $\begin{bmatrix} x & p(xzz) \\ y & p(yww) \end{bmatrix} \in T$, then $\begin{bmatrix} x & q(xyzw) \\ y & w \end{bmatrix} \in T$.*

Proof. Assume that $\mathbf{A} \in \mathcal{V}$, $\alpha, \beta \in \text{Con}(\mathbf{A})$ with $[\alpha, \beta] = 0$, and

$$(4.1) \quad \begin{bmatrix} a & c \\ b & d \end{bmatrix} \in R(\alpha, \beta).$$

The assumption of the lemma statement together with the assumptions of the first line of the proof imply that

$$(4.2) \quad M_0 := \begin{bmatrix} a & p(acc) \\ b & p(bdd) \end{bmatrix} \in \Delta(\alpha, \beta).$$

Since $p(xxx) \approx x$, $(a, b), (c, d) \in \alpha$, and $(a, c), (b, d) \in \beta$, we have

$$(4.3) \quad \begin{bmatrix} p(acc) & c \\ p(bdd) & d \end{bmatrix} = \begin{bmatrix} p(acc) & p(ccc) \\ p(bdd) & p(ddd) \end{bmatrix} \in R(\alpha, \beta).$$

Applying to (4.3) the argument that led from the matrix in (4.1) to the matrix in (4.2), we obtain

$$(4.4) \quad M_1 := \begin{bmatrix} p(acc) & p(p(acc)cc) \\ p(bdd) & p(p(bdd)dd) \end{bmatrix} \in \Delta(\alpha, \beta).$$

Finally, the following three matrices

$$\begin{bmatrix} p(acc) & p(acc) \\ p(bdd) & p(bdd) \end{bmatrix}, \quad \begin{bmatrix} p(bbc) & p(bdc) \\ p(bbd) & p(bdd) \end{bmatrix}, \quad \begin{bmatrix} c & c \\ d & d \end{bmatrix}$$

are in $M(\alpha, \beta)$ because $(a, b), (c, d) \in \alpha$ and $(a, c), (b, d) \in \beta$, so applying p to them we get that the matrix

$$M_2 := \begin{bmatrix} p(p(acc)cc) & q(abcd) \\ p(p(bdd)dd) & d \end{bmatrix} = \begin{bmatrix} p(p(acc), p(bbc), c) & p(p(acc), p(bdc), c) \\ p(p(bdd), p(bbd), d) & p(p(bdd), p(bdd), d) \end{bmatrix}$$

is in $M(\alpha, \beta)$ and hence is in $\Delta(\alpha, \beta)$. Gluing M_0 , M_1 and M_2 horizontally gives

$$\begin{bmatrix} a & q(abcd) \\ b & d \end{bmatrix} \in \Delta(\alpha, \beta).$$

Since this is true for arbitrary $\mathbf{A} \in \mathcal{V}$, $\alpha, \beta \in \text{Con}(\mathbf{A})$ with $[\alpha, \beta] = 0$, and arbitrary $\begin{bmatrix} a & c \\ b & d \end{bmatrix} \in R(\alpha, \beta)$, we have proved the conclusion of the lemma. \square

Lemma 4.1 reduces the task of proving Lemma 2.5 to the following:

Remaining Goal: to show $\begin{bmatrix} x & p(xzz) \\ y & p(yww) \end{bmatrix} \in T$.

We will complete this remaining goal with the help of the other terms in the Maltsev condition characterizing a difference term. This Maltsev condition was alluded to in our paper [8, Theorem 1.2, proof of (2) \Rightarrow (3)], but now we need to make it explicit. By virtue of p being a difference term for \mathcal{V} , there exist:

- a finite vertex-labeled tree \mathcal{T} with vertex set I and root 0, such that the children of each nonleaf are linearly ordered, every vertex is labeled by \mathbf{b} or \mathbf{g} , 0 is labeled \mathbf{b} , and a child always has the opposite label of its parent; and
- a family $\{(f_i, g_i) : i \in I\}$ of pairs of idempotent 3-ary terms in (x, y, z) ;

which, with p , satisfy some identities which will be stated after some preparation. First,

- For each nonleaf vertex $i \in I$ let $\alpha(i)$ and $\omega(i)$ denote the first and last children respectively of i ;
- For each vertex $i \in I \setminus \{0\}$, let $\pi(i)$ denote the parent of i , and if $i \neq \omega(\pi(i))$ then let $\text{suc}(i)$ denote the first child of $\pi(i)$ after i .

Then the identities are:

$$(4.5) \quad f_i(x, y, x) \approx g_i(x, y, x) \quad \text{for all } i \in I$$

$$(4.6) \quad f_0(x, y, z) \approx x$$

$$(4.7) \quad f_i(x, x, y) \approx g_i(x, x, y) \quad \text{if } i \text{ is a leaf colored } \mathbf{b}$$

$$(4.8) \quad f_i(x, y, y) \approx g_i(x, y, y) \quad \text{if } i \text{ is a leaf colored } \mathbf{g}$$

$$(4.9) \quad f_i(x, x, y) \approx f_{\alpha(i)}(x, x, y) \quad \text{if } i \text{ is a nonleaf colored } \mathbf{b}$$

$$(4.10) \quad g_i(x, x, y) \approx g_{\omega(i)}(x, x, y) \quad \text{if } i \text{ is a nonleaf colored } \mathbf{b}$$

$$(4.11) \quad f_i(x, y, y) \approx f_{\alpha(i)}(x, y, y) \quad \text{if } i \text{ is a nonleaf colored } \mathbf{g}$$

$$(4.12) \quad g_i(x, y, y) \approx g_{\omega(i)}(x, y, y) \quad \text{if } i \text{ is a nonleaf colored } \mathbf{g}$$

$$(4.13) \quad g_i(x, x, y) \approx f_{\text{suc}(i)}(x, x, y) \quad \text{if } i \neq 0, \pi(i) \text{ is colored } \mathbf{b}, \text{ and } i \neq \omega(\pi(i))$$

$$(4.14) \quad g_i(x, y, y) \approx f_{\text{suc}(i)}(x, y, y) \quad \text{if } i \neq 0, \pi(i) \text{ is colored } \mathbf{g}, \text{ and } i \neq \omega(\pi(i))$$

$$(4.15) \quad g_0(x, y, y) \approx p(x, y, y)$$

$$(4.16) \quad p(x, x, y) \approx y.$$

(Note: in [8, Theorem 1.2, proof of (2) \Rightarrow (3)], we used q to denote g_0 , but we do not do that here since we are using q for the Kiss term.)

Definition 4.2. For each $i \in I$, define the matrices $L_i, R_i \in F^{2 \times 2}$ by

$$L_i = \begin{bmatrix} f_i(xxz) & g_i(xxz) \\ f_i(yyw) & g_i(yyw) \end{bmatrix} \quad \text{and} \quad R_i = \begin{bmatrix} f_i(xzz) & g_i(xzz) \\ f_i(yww) & g_i(yww) \end{bmatrix}.$$

Note in particular that

$$R_0 = \begin{bmatrix} f_0(xzz) & g_0(xzz) \\ f_0(yww) & g_0(yww) \end{bmatrix} = \begin{bmatrix} x & p(xzz) \\ y & p(yww) \end{bmatrix}$$

by identities (4.6) and (4.15). Thus we can restate our remaining goal as “ $R_0 \in T$.”

Lemma 4.3. *If for every $i \in I$ we have $L_i \in T \iff R_i \in T$, then $R_0 \in T$.*

Proof. It suffices by the assumption to show that $T \cap \{L_0, R_0\} \neq \emptyset$. In fact we will show $T \cap \{L_i, R_i\} \neq \emptyset$ for all $i \in I$, by induction on i starting at the leaves. If $i \in I$ is a leaf colored \mathbf{b} , then $L_i \in T$ by identity (4.7). Similarly, if $i \in I$ is a leaf colored \mathbf{g} , then $R_i \in T$ by identity (4.8).

Next assume that $i \in I$ is not a leaf. Let $\alpha(i) = i_1, \dots, i_k = \omega(i)$ be the list of children of i in their prescribed order. By induction, we can assume that $T \cap \{L_j, R_j\} \neq \emptyset$ for each $j = i_1, \dots, i_k$. Hence by the assumption we have $\{L_j, R_j\} \subseteq T$ for each $j = i_1, \dots, i_k$.

First consider the case when i is colored \mathbf{b} . Let $\mathbf{A} \in \mathcal{V}$, let $\alpha, \beta \in \text{Con}(\mathbf{A})$ with $[\alpha, \beta] = 0$, and let $\begin{bmatrix} a & c \\ b & d \end{bmatrix} \in R(\alpha, \beta)$. Consider the matrices

$$\begin{bmatrix} f_{i_1}(aab) & g_{i_1}(aab) \\ f_{i_1}(ccd) & g_{i_1}(ccd) \end{bmatrix}, \begin{bmatrix} f_{i_2}(aab) & g_{i_2}(aab) \\ f_{i_2}(ccd) & g_{i_2}(ccd) \end{bmatrix}, \dots, \begin{bmatrix} f_{i_k}(aab) & g_{i_k}(aab) \\ f_{i_k}(ccd) & g_{i_k}(ccd) \end{bmatrix}.$$

Because $L_{i_1}, \dots, L_{i_k} \in T$, the above matrices are in $\Delta(\alpha, \beta)$. And because $\text{suc}(i_1) = i_2$, $\text{suc}(i_2) = i_3$ etc., the identities (4.13) guarantee that we can glue the above matrices horizontally to get

$$\begin{bmatrix} f_{\alpha(i)}(aab) & g_{\omega(i)}(aab) \\ f_{\alpha(i)}(ccd) & g_{\omega(i)}(ccd) \end{bmatrix} \in \Delta(\alpha, \beta).$$

Identities (4.9) and (4.10) give that this matrix equals $\begin{bmatrix} f_i(aab) & g_i(aab) \\ f_i(ccd) & g_i(ccd) \end{bmatrix}$. This proves $L_i \in T$. The case when i is colored \mathbf{g} is handled similarly. \square

5. PROOF OF LEMMA 2.5: FINAL STEP

We continue to assume that \mathcal{V} is a variety with a difference term p and other terms f_i, g_i ($i \in I$) witnessing the Maltsev condition stated in the previous section. By Lemmas 4.1 and 4.3, the next theorem will finish the proof of Lemma 2.5.

Theorem 5.1. *For every $i \in I$, $L_i \in T \iff R_i \in T$.*

Proof. What we actually prove is that for any two idempotent 3-ary terms $f(x, y, z)$, $g(x, y, z)$ satisfying $\mathcal{V} \models f(x, y, x) \approx g(x, y, x)$, if we set

$$L_{fg} := \begin{bmatrix} f(xxz) & g(xxz) \\ f(yyw) & g(yyw) \end{bmatrix} \quad \text{and} \quad R_{fg} := \begin{bmatrix} f(xzz) & g(xzz) \\ f(yww) & g(yww) \end{bmatrix}$$

then $R_{fg} \in T$ implies $L_{fg} \in T$. This will suffice as we now explain. Fix $i \in I$. Applying the above claim to $(f, g) = (f_i, g_i)$ and invoking identity (4.5) shows that $R_i \in T$ implies $L_i \in T$. For the reverse implication, let δ be the automorphism of \mathbf{F} which swaps x with z and y with w . It is easy to check that T is closed under the componentwise action of δ . Thus if $L_i \in T$ then

$$\delta(L_i) = \begin{bmatrix} f_i(zzx) & g_i(zzx) \\ f_i(wwy) & g_i(wwy) \end{bmatrix} \in T.$$

Now define $f(x, y, z) := f_i(z, y, x)$ and $g(x, y, z) := g_i(z, y, x)$. Then $R_{fg} = \delta(L_i) \in T$. We have $\mathcal{V} \models f(xyx) \approx g(xy x)$ by identity (4.5), so we can apply the above claim to get $L_{fg} \in T$, and hence $R_i = \delta(L_{fg}) \in T$ as well.

So let f, g be idempotent 3-ary terms satisfying

$$(\dagger) \quad \mathcal{V} \models f(xy x) \approx g(xy x),$$

and assume $R_{fg} \in T$. In order to prove $L_{fg} \in T$, we must show that

$$\begin{bmatrix} f(aac) & g(aac) \\ f(bbd) & g(bbd) \end{bmatrix} \in \Delta(\alpha, \beta)$$

whenever $\mathbf{A} \in \mathcal{V}$, $\alpha, \beta \in \text{Con}(\mathbf{A})$ with $[\alpha, \beta] = 0$, and $\begin{bmatrix} a & c \\ b & d \end{bmatrix} \in R(\alpha, \beta)$.

To this end, choose and fix arbitrary $\mathbf{A} \in \mathcal{V}$, $\alpha, \beta \in \text{Con}(\mathbf{A})$ with $[\alpha, \beta] = 0$, and $\begin{bmatrix} a & c \\ b & d \end{bmatrix} \in R(\alpha, \beta)$. We start by defining some matrices in $\Delta(\alpha, \beta)$. Let

$$B_1 := \begin{bmatrix} f(aac) & f(aca) \\ f(bac) & f(bca) \end{bmatrix} \quad B_2 := \begin{bmatrix} g(aca) & g(aac) \\ g(bca) & g(bac) \end{bmatrix}.$$

These matrices are in $M(\alpha, \beta)$, since each can be realized as a coordinatewise application of f or g to three generators of $M(\alpha, \beta)$.

Next define the matrix

$$G_1 := \begin{bmatrix} f(baa) & f(baa) \\ g(baa) & g(baa) \end{bmatrix}.$$

Here, the idempotence of f and g yields that $f(baa) \stackrel{\alpha}{\equiv} f(aaa) = a = g(aaa) \stackrel{\alpha}{\equiv} g(baa)$, so G_1 is one of the generators of $M(\alpha, \beta)$.

Next, we use the assumption that $R_{fg} \in T$ as follows. Clearly

$$\begin{bmatrix} b & a \\ d & c \end{bmatrix}, \begin{bmatrix} d & c \\ b & a \end{bmatrix} \in R(\beta, \alpha).$$

Since $[\beta, \alpha] = 0$ by commutativity of the commutator in \mathcal{V} [5, Lemma 2.2], applying $R_{fg} \in T$ gives

$$\begin{bmatrix} f(baa) & g(baa) \\ f(dcc) & g(dcc) \end{bmatrix}, \begin{bmatrix} f(dcc) & g(dcc) \\ f(baa) & g(baa) \end{bmatrix} \in \Delta(\beta, \alpha).$$

Then taking transposes and appealing to Lemma 2.3 we get that the following are in $\Delta(\alpha, \beta)$:

$$H_1 := \begin{bmatrix} f(baa) & f(dcc) \\ g(baa) & g(dcc) \end{bmatrix} \quad H_2 := \begin{bmatrix} f(dcc) & f(baa) \\ g(dcc) & g(baa) \end{bmatrix}.$$

Since $\Delta(\alpha, \beta)$ is a subalgebra of $\mathbf{A}^{2 \times 2}$ by Lemma 2.2, we can apply f coordinatewise to G_1, H_1, H_2 to get another matrix in $\Delta(\alpha, \beta)$:

$$B_3 := f(G_1, H_1, H_2) = \begin{bmatrix} f \circ f \begin{pmatrix} baa \\ baa \\ dcc \end{pmatrix} & f \circ f \begin{pmatrix} baa \\ dcc \\ baa \end{pmatrix} \\ f \circ g \begin{pmatrix} baa \\ baa \\ dcc \end{pmatrix} & f \circ g \begin{pmatrix} baa \\ dcc \\ baa \end{pmatrix} \end{bmatrix}$$

where we are using the notation $f \circ h \begin{pmatrix} \mathbf{x} \\ \mathbf{y} \\ \mathbf{z} \end{pmatrix}$ for $f(h(\mathbf{x}), h(\mathbf{y}), h(\mathbf{z}))$.

We now focus on the matrices $B_1, B_2, B_3 \in \Delta(\alpha, \beta)$. Let's define new names for (some of) their entries as follows:

$$\begin{aligned} B_1 &= \begin{bmatrix} f(aac) & f(aca) \\ f(bac) & f(bca) \end{bmatrix} = \begin{bmatrix} f(aac) & f(aca) \\ r_0 & t_0 \end{bmatrix} \\ B_2 &= \begin{bmatrix} g(aca) & g(aac) \\ g(bca) & g(bac) \end{bmatrix} = \begin{bmatrix} g(aca) & g(aac) \\ u_0 & g(bac) \end{bmatrix} \\ B_3 &= \begin{bmatrix} f \circ f \begin{pmatrix} baa \\ baa \\ dcc \end{pmatrix} & f \circ f \begin{pmatrix} baa \\ dcc \\ baa \end{pmatrix} \\ f \circ g \begin{pmatrix} baa \\ baa \\ dcc \end{pmatrix} & f \circ g \begin{pmatrix} baa \\ dcc \\ baa \end{pmatrix} \end{bmatrix} = \begin{bmatrix} r & t \\ s & u \end{bmatrix}. \end{aligned}$$

These matrices “fit roughly” together as illustrated in Figure 1. The parallel blue lines between the upper-right entry of B_1 and the upper-left entry of B_2 indicate an equality (in this case due to the assumption (\dagger)). Let $\theta = \alpha \cap \beta$ and note that $[\theta, \theta] \leq [\alpha, \beta] = 0$, so θ is abelian. The red squiggly lines indicate pairs that are in θ , as shown in the next claim.

Claim 5.2. $(r, r_0), (t, t_0), (u, u_0) \in \theta$.

Proof. $r = f(f(baa), f(baa), f(dcc)) \stackrel{\alpha}{\equiv} f(f(aaa), f(aaa), f(ccc)) = f(aac)$ by the idempotence of f , and $f(aac) \stackrel{\alpha}{\equiv} f(bac) = r_0$. Thus $(r, r_0) \in \alpha$. Similarly,

$$r \stackrel{\beta}{\equiv} f(f(baa), f(baa), f(baa)) = f(baa) \stackrel{\beta}{\equiv} f(bac) = r_0$$

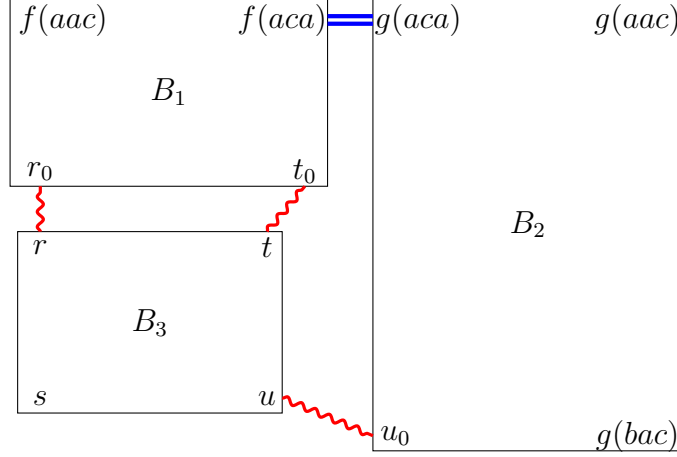

FIGURE 1

proving $(r, r_0) \in \beta$. So $(r, r_0) \in \alpha \cap \beta = \theta$. The proof is similar for (t, t_0) . For (u, u_0) , also use the fact that $f(aca) = g(aca)$ by the assumption (\dagger) . \square

Next, we use the difference term p and the fact that $(r, r_0) \in \theta$ and $(r_0, t_0) \in \beta$ to find t_1 so that $\begin{bmatrix} r_0 & t_0 \\ r & t_1 \end{bmatrix} \in M(\theta, \beta)$. Namely, we observe that

$$\begin{bmatrix} r_0 & r_0 \\ r & r \end{bmatrix}, \begin{bmatrix} r_0 & r_0 \\ r_0 & r_0 \end{bmatrix}, \begin{bmatrix} r_0 & t_0 \\ r_0 & t_0 \end{bmatrix}$$

are all generators for $M(\theta, \beta)$; applying p to them coordinatewise and noting that $p(r, r_0, r_0) = r$ as θ is abelian gives

$$C_1 := \begin{bmatrix} r_0 & t_0 \\ r & t_1 \end{bmatrix} \in M(\theta, \beta) \quad \text{where } t_1 = p(r, r_0, t_0).$$

In particular, we get that $t_0 = p(r_0, r_0, t_0) \stackrel{\theta}{=} p(r, r_0, t_0) = t_1$, so $(t_0, t_1) \in \theta$, and therefore $(t, t_1) \in \theta$ by transitivity.

Similarly, applying p to generators $\begin{bmatrix} t & t_1 \\ t & t_1 \end{bmatrix}, \begin{bmatrix} t_1 & t_1 \\ t & t \end{bmatrix}, \begin{bmatrix} t_1 & t_1 \\ u & u \end{bmatrix} \in G(\alpha, \theta)$ we get a matrix

$$C_2 := \begin{bmatrix} t & t_1 \\ u & u_1 \end{bmatrix} \in M(\alpha, \theta) \quad \text{where } u_1 = p(t_1, t, u).$$

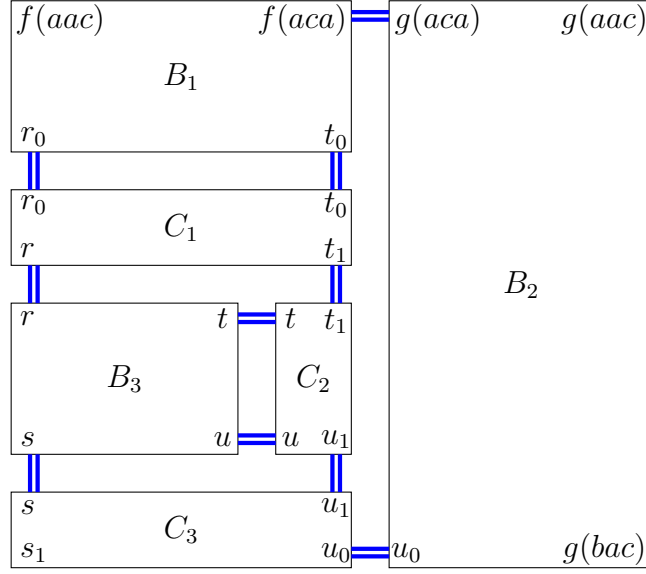

FIGURE 2

We get that $(u, u_1) \in \theta$ so $(u_0, u_1) \in \theta$. Employing the argument one more time, applying p to generators $\begin{bmatrix} u_1 & u_1 \\ u_0 & u_0 \end{bmatrix}, \begin{bmatrix} u_1 & u_1 \\ u_1 & u_1 \end{bmatrix}, \begin{bmatrix} s & u_1 \\ s & u_1 \end{bmatrix} \in G(\theta, \beta)$, we get a matrix

$$C_3 := \begin{bmatrix} s & u_1 \\ s_1 & u_0 \end{bmatrix} \in M(\theta, \beta) \quad \text{where } s_1 = p(u_0, u_1, s).$$

The matrices C_1, C_2, C_3 fit perfectly with B_1, B_2, B_3 as shown in Figure 2.

Claim 5.3. $\begin{bmatrix} f(aac) & g(aac) \\ s_1 & g(bac) \end{bmatrix} \in \Delta(\alpha, \beta)$.

Proof. Glue B_3 to C_2 horizontally; then combine the resulting matrix with B_1, C_1 and C_3 vertically; and finally glue this last matrix to B_2 horizontally. \square

We now follow similar steps to find $\bar{s}_1 \in A$ such that $\begin{bmatrix} \bar{s}_1 & g(bac) \\ f(bbd) & g(bbd) \end{bmatrix} \in \Delta(\alpha, \beta)$. The following are in $M(\alpha, \beta)$, as can be shown by the same reasoning used to show that B_1 and B_2 are in $M(\alpha, \beta)$:

$$B_4 := \begin{bmatrix} f(bac) & f(dac) \\ f(bbd) & f(dbd) \end{bmatrix} \quad B_5 := \begin{bmatrix} g(dac) & g(bac) \\ g(dbd) & g(bbd) \end{bmatrix}.$$

The following is a generator of $M(\alpha, \beta)$, as can be shown by the same reasoning used to show that G_1 is a generator:

$$G_2 := \begin{bmatrix} f(dcc) & f(dcc) \\ g(dcc) & g(dcc) \end{bmatrix}.$$

Also recall the matrices $G_1, H_1 \in \Delta(\alpha, \beta)$ defined earlier. Now apply f coordinatewise to H_1, G_1, G_2 to get

$$B'_6 := f(H_1, G_1, G_2) = \begin{bmatrix} f \circ f \begin{pmatrix} baa \\ baa \\ dcc \end{pmatrix} & f \circ f \begin{pmatrix} dcc \\ baa \\ dcc \end{pmatrix} \\ f \circ g \begin{pmatrix} baa \\ baa \\ dcc \end{pmatrix} & f \circ g \begin{pmatrix} dcc \\ baa \\ dcc \end{pmatrix} \end{bmatrix}.$$

Finally, we let B_6 be the matrix obtained from B'_6 by swapping its top row with its bottom row. $\Delta(\alpha, \beta)$ is closed under the action of swapping rows, since $M(\alpha, \beta)$ is, so $B_6 \in \Delta(\alpha, \beta)$.

Observe that the upper-left entry of B_4 equals the lower-left entry of B_1 , which we have named r_0 . Similarly, the two entries in the first column of B_6 equal the two entries of the first column of B_3 but in reverse order (these are r and s).

Define a few more new names for entries of B_4, B_5, B_6 as follows:

$$B_4 = \begin{bmatrix} f(bac) & f(dac) \\ f(bbd) & f/dbd) \end{bmatrix} = \begin{bmatrix} r_0 & \bar{t}_0 \\ f(bbd) & f/dbd) \end{bmatrix}$$

$$B_5 = \begin{bmatrix} g(dac) & g(bac) \\ g/dbd) & g/bbd) \end{bmatrix} = \begin{bmatrix} \bar{u}_0 & g(bac) \\ g/dbd) & g/bbd) \end{bmatrix}$$

$$B_6 = \begin{bmatrix} f \circ g \begin{pmatrix} baa \\ baa \\ dcc \end{pmatrix} & f \circ g \begin{pmatrix} dcc \\ baa \\ dcc \end{pmatrix} \\ f \circ f \begin{pmatrix} baa \\ baa \\ dcc \end{pmatrix} & f \circ f \begin{pmatrix} dcc \\ baa \\ dcc \end{pmatrix} \end{bmatrix} = \begin{bmatrix} s & \bar{u} \\ r & \bar{t} \end{bmatrix}.$$

These matrices “fit roughly” together as illustrated in Figure 3.

Claim 5.4. $(\bar{t}, \bar{t}_0), (\bar{u}, \bar{u}_0) \in \theta$.

Proof. Similar to the proof of Claim 5.2. □

Now we repeat the process of adding matrices from $M(\theta, \beta)$ or $M(\alpha, \theta)$. Because $(r, r_0) \in \theta$ (by Claim 5.2) we can apply p to $\begin{bmatrix} r & r \\ r_0 & r_0 \end{bmatrix}, \begin{bmatrix} r_0 & r_0 \\ r_0 & r_0 \end{bmatrix}, \begin{bmatrix} r_0 & \bar{t}_0 \\ r_0 & \bar{t}_0 \end{bmatrix} \in G(\theta, \beta)$ to

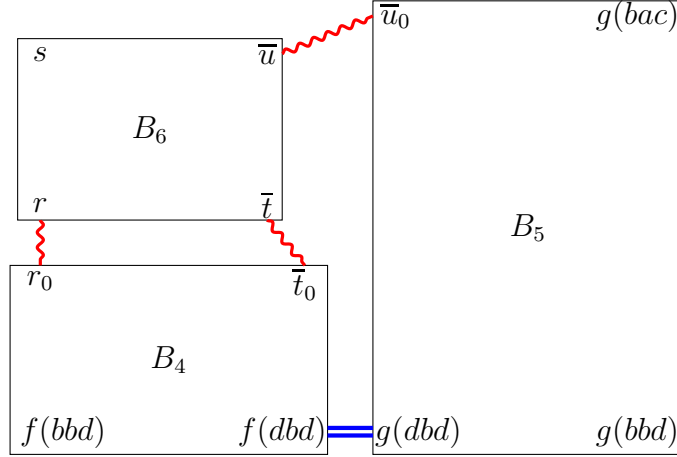

FIGURE 3

get

$$C_4 := \begin{bmatrix} r & \bar{t}_1 \\ r_0 & \bar{t}_0 \end{bmatrix} \in M(\theta, \beta) \quad \text{where } \bar{t}_1 = p(r, r_0, \bar{t}_0).$$

In particular, we get that $(\bar{t}_0, \bar{t}_1) \in \theta$ so $(\bar{t}, \bar{t}_1) \in \theta$ by transitivity.

By a similar argument, applying p to $\begin{bmatrix} \bar{t} & \bar{t}_1 \\ \bar{t} & \bar{t}_1 \end{bmatrix}, \begin{bmatrix} \bar{t} & \bar{t} \\ \bar{t}_1 & \bar{t}_1 \end{bmatrix}, \begin{bmatrix} \bar{u} & \bar{u} \\ \bar{t}_1 & \bar{t}_1 \end{bmatrix} \in G(\alpha, \theta)$ we get a matrix

$$C_5 := \begin{bmatrix} \bar{u} & \bar{u}_1 \\ \bar{t} & \bar{t}_1 \end{bmatrix} \in M(\alpha, \theta) \quad \text{where } \bar{u}_1 = p(\bar{t}_1, \bar{t}, \bar{u}).$$

We get $(\bar{u}_0, \bar{u}_1) \in \theta$, so applying p to $\begin{bmatrix} \bar{u}_0 & \bar{u}_0 \\ \bar{u}_1 & \bar{u}_1 \end{bmatrix}, \begin{bmatrix} \bar{u}_1 & \bar{u}_1 \\ \bar{u}_1 & \bar{u}_1 \end{bmatrix}, \begin{bmatrix} s & \bar{u}_1 \\ s & \bar{u}_1 \end{bmatrix} \in G(\theta, \beta)$ we get

$$C_6 := \begin{bmatrix} \bar{s}_1 & \bar{u}_0 \\ s & \bar{u}_1 \end{bmatrix} \in M(\theta, \beta) \quad \text{where } \bar{s}_1 = p(\bar{u}_0, \bar{u}_1, s).$$

The matrices C_4, C_5, C_6 fit perfectly with B_4, B_5, B_6 as shown in Figure 4. This proves

Claim 5.5. $\begin{bmatrix} \bar{s}_1 & g(bac) \\ f(bbd) & g(bbd) \end{bmatrix} \in \Delta(\alpha, \beta).$

Now for our final bit of magic, we will show

Claim 5.6. $s_1 = \bar{s}_1.$

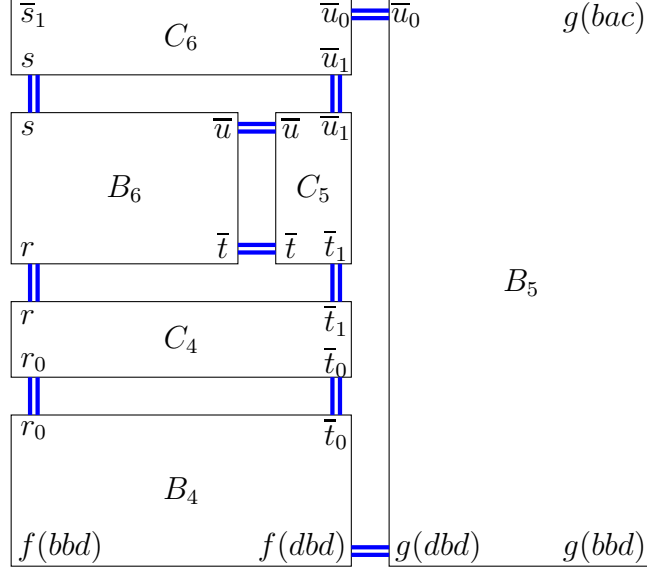

FIGURE 4

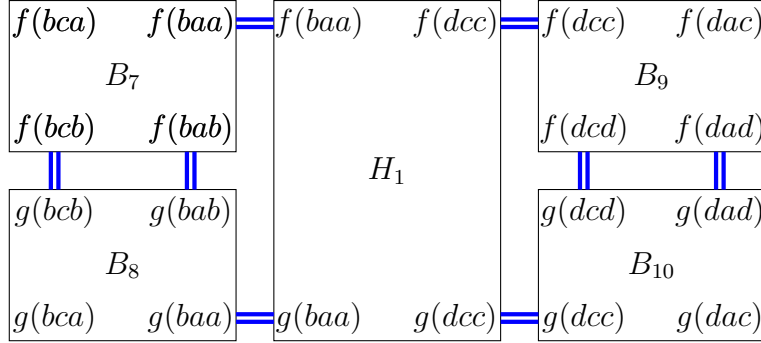

FIGURE 5

Proof. First, we define four more matrices in $M(\alpha, \beta)$:

$$\begin{aligned}
 B_7 &= \begin{bmatrix} f(bca) & f(baa) \\ f(bcb) & f(bab) \end{bmatrix} & B_9 &= \begin{bmatrix} f(dcc) & f(dac) \\ f(dcd) & f(dad) \end{bmatrix} \\
 B_8 &= \begin{bmatrix} g(bcb) & g(bab) \\ g(bca) & g(baa) \end{bmatrix} & B_{10} &= \begin{bmatrix} g(dcd) & g(dad) \\ g(dcc) & g(dac) \end{bmatrix}.
 \end{aligned}$$

With the matrix H_1 defined earlier, these matrices fit perfectly as shown in Figure 5.

Thus we get

$$(5.1) \quad \begin{bmatrix} t_0 & \bar{t}_0 \\ u_0 & \bar{u}_0 \end{bmatrix} = \begin{bmatrix} f(bca) & f(dac) \\ g(bca) & g(dac) \end{bmatrix} \in \Delta(\alpha, \beta).$$

Recall that the following matrices are in $\Delta(\alpha, \beta)$:

$$B_3 = \begin{bmatrix} r & t \\ s & u \end{bmatrix} \quad \text{and} \quad B'_6 = \begin{bmatrix} r & \bar{t} \\ s & \bar{u} \end{bmatrix}.$$

If we swap the two columns of B_3 , we can horizontally glue the resulting matrix to B'_6 , getting

$$(5.2) \quad \begin{bmatrix} t & \bar{t} \\ u & \bar{u} \end{bmatrix} \in \Delta(\alpha, \beta).$$

It follows from (5.1) and (5.2) that we can apply $p(x_1, p(x_2, x_3, x_4), x_5)$ to the matrices

$$\begin{bmatrix} u_0 & \bar{u}_0 \\ u_0 & \bar{u}_0 \end{bmatrix}, \quad \begin{bmatrix} t_0 & \bar{t}_0 \\ u_0 & \bar{u}_0 \end{bmatrix}, \quad \begin{bmatrix} t & \bar{t} \\ u & \bar{u} \end{bmatrix}, \quad \begin{bmatrix} u & \bar{u} \\ u & \bar{u} \end{bmatrix}, \quad \begin{bmatrix} s & s \\ s & s \end{bmatrix}$$

and the resulting matrix

$$\begin{bmatrix} p(u_0, p(t_0, t, u), s) & p(\bar{u}_0, p(\bar{t}_0, \bar{t}, \bar{u}), s) \\ p(u_0, p(u_0, u, u), s) & p(\bar{u}_0, p(\bar{u}_0, \bar{u}, \bar{u}), s) \end{bmatrix}$$

is in $\Delta(\alpha, \beta)$. Observe that $(u, u_0), (\bar{u}, \bar{u}_0) \in \theta$ by Claims 5.2 and 5.4. Hence the bottom entries of the above matrix are both equal to s . By Lemma 2.4(1) we get that the top entries are also equal, i.e.,

$$(5.3) \quad p(u_0, p(t_0, t, u), s) = p(\bar{u}_0, p(\bar{t}_0, \bar{t}, \bar{u}), s).$$

Let's rewrite this last equation as

$$(5.4) \quad p(u_0, p(\underbrace{p(r, \underline{r}, t_0)}_{=t_0}, t, u), s) = p(\bar{u}_0, p(\underbrace{p(r, \underline{r}, \bar{t}_0)}_{=\bar{t}_0}, \bar{t}, \bar{u}), s).$$

Observe that

$$t \stackrel{\beta}{\equiv} r \stackrel{\beta}{\equiv} \bar{t} \quad \text{and} \quad u \stackrel{\beta}{\equiv} s \stackrel{\beta}{\equiv} \bar{u}.$$

Since $(t_0, t), (\bar{t}_0, \bar{t}), (u_0, u), (\bar{u}_0, \bar{u}) \in \theta$, we get that each of the pairs $(u_0, \bar{u}_0), (t_0, \bar{t}_0), (t, \bar{t}), (u, \bar{u})$ is in β . As $(r, r_0) \in \theta \subseteq \alpha$, the condition $[\alpha, \beta] = 0$ allows us to change the two underlined occurrences of r in equation (5.4) to r_0 , producing

$$(5.5) \quad p(u_0, p(p(r, r_0, t_0), t, u), s) = p(\bar{u}_0, p(p(r, r_0, \bar{t}_0), \bar{t}, \bar{u}), s).$$

Now

$$\begin{aligned} p(u_0, p(p(r, r_0, t_0), t, u), s) &= p(u_0, p(t_1, t, u), s) && \text{definition of } t_1 \\ &= p(u_0, u_1, s) && \text{definition of } u_1 \\ &= s_1 && \text{definition of } s_1 \end{aligned}$$

and $p(\bar{u}_0, p(p(r, r_0, \bar{t}_0), \bar{t}, \bar{u}), s)$ similarly simplifies to \bar{s}_1 . Thus $s_1 = \bar{s}_1$, proving Claim 5.6. \square

Now we can finish the proof of Theorem 5.1. By Claims 5.3, 5.5 and 5.6, we have matrices

$$\begin{bmatrix} f(aac) & g(aac) \\ s_1 & g(bac) \end{bmatrix}, \begin{bmatrix} s_1 & g(bac) \\ f(bbd) & g(bbd) \end{bmatrix} \in \Delta(\alpha, \beta).$$

We can glue the first matrix on top of the second to get

$$\begin{bmatrix} f(aac) & g(aac) \\ f(bbd) & g(bbd) \end{bmatrix} \in \Delta(\alpha, \beta).$$

As $\mathbf{A}, \alpha, \beta, \begin{bmatrix} a & c \\ b & d \end{bmatrix}$ were arbitrary, this proves

$$L_{fg} = \begin{bmatrix} f(xxz) & g(xxz) \\ f(yyw) & g(yyw) \end{bmatrix} \in T. \quad \square$$

6. PROOF OF THEOREM 1.1

Proof of Theorem 1.1. Given that $\mathbf{A} \in \mathcal{V}$ and $[\alpha, \beta] = 0$, we must show that q restricted to $R(\alpha, \beta)$ is a homomorphism $R(\alpha, \beta) \rightarrow \mathbf{A}$. Let s be an n -ary term and $\begin{bmatrix} a_i & c_i \\ b_i & d_i \end{bmatrix} \in R(\alpha, \beta)$ for $i = 1, \dots, n$. Applying s gives

$$\begin{bmatrix} s(\mathbf{a}) & s(\mathbf{c}) \\ s(\mathbf{b}) & s(\mathbf{d}) \end{bmatrix} \in R(\alpha, \beta).$$

For $i = 1, \dots, n$ define $c'_i = q(a_i, b_i, c_i, d_i)$. Applying Lemma 2.5 to the $n + 1$ matrices in $R(\alpha, \beta)$ at hand gives

$$(6.1) \quad \begin{bmatrix} a_i & c'_i \\ b_i & d_i \end{bmatrix} \in \Delta(\alpha, \beta), \quad (i = 1, \dots, n)$$

$$(6.2) \quad \begin{bmatrix} s(\mathbf{a}) & q(s(\mathbf{a}), s(\mathbf{b}), s(\mathbf{c}), s(\mathbf{d})) \\ s(\mathbf{b}) & s(\mathbf{d}) \end{bmatrix} \in \Delta(\alpha, \beta).$$

Applying s to the n matrices in (6.1) and using Lemma 2.2, we get

$$\begin{bmatrix} s(\mathbf{a}) & s(c'_1, \dots, c'_n) \\ s(\mathbf{b}) & s(\mathbf{d}) \end{bmatrix} \in \Delta(\alpha, \beta),$$

which with (6.2) and Lemma 2.4(2) gives

$$s(c'_1, \dots, c'_n) = q(s(\mathbf{a}), s(\mathbf{b}), s(\mathbf{c}), s(\mathbf{d}))$$

as required. □

7. PROOF OF LEMMA 6.2 OF [8]

In this section we prove Lemma 6.2 of [8]. First, we need the following fact about arbitrary Kiss terms. (Arbitrary Kiss terms were defined by (I)_q and (II)_q of the Introduction.)

Lemma 7.1. *Let \mathcal{V} be a variety with a Kiss term $q(x, y, z, w)$. If $\mathbf{A} \in \mathcal{V}$, $\alpha, \beta \in \text{Con}(\mathbf{A})$, and $[\alpha, \beta] = 0$, then $q(x, y, z, w)$ is independent of its third variable on $R(\alpha, \beta)$.*

Proof. It follows from (II)_q of the definition of a Kiss term that if $(a, b, c, d), (a, b, c', d) \in R(\alpha, \beta)$, then

$$q(a, b, c, d) \stackrel{[\alpha, \beta]}{\equiv} q(a, b, c', d).$$

Since we are assuming $[\alpha, \beta] = 0$, we obtain that $q(a, b, c, d) = q(a, b, c', d)$ whenever $(a, b, c, d), (a, b, c', d) \in R(\alpha, \beta)$, which is the claim of the lemma. \square

Now let \mathcal{V} be a variety having a Kiss term q which has been constructed from a 3-ary difference term via Lipparini's Formula. In this context, Lemma 6.2 of [8] states the following.

Lemma 6.2 of [8]. *If $\mathbf{A} \in \mathcal{V}$ and $\alpha, \beta \in \text{Con}(\mathbf{A})$, then $[\alpha, \beta] = 0$ iff*

- (i) $q: R(\alpha, \beta) \rightarrow \mathbf{A}$ is a homomorphism, and
- (ii) q is independent of its third variable on $R(\alpha, \beta)$.

In the following proof, note that the requirement that q be constructed from a 3-ary difference term via Lipparini's Formula is used only at the point where Theorem 1.1 is called.

Proof of Lemma 6.2 of [8]. Assume that $[\alpha, \beta] = 0$. Item (ii) holds by Lemma 7.1. Item (i) holds by Theorem 1.1, using our assumption on q .

Conversely, assume that Items (i) and (ii) hold for some Kiss term q . Recall that $M(\alpha, \beta)$ is the subalgebra of $R(\alpha, \beta)$ generated by

$$G(\alpha, \beta) := \left\{ \begin{bmatrix} c & c \\ d & d \end{bmatrix} : (c, d) \in \alpha \right\} \cup \left\{ \begin{bmatrix} a & c \\ a & c \end{bmatrix} : (a, c) \in \beta \right\}.$$

It follows from the Kiss identities (I)_q that $q(a, b, c, d) = c$ if $\begin{bmatrix} a & c \\ b & d \end{bmatrix} \in G(\alpha, \beta)$.

Assuming Item (i) of the lemma statement, $q: R(\alpha, \beta) \rightarrow \mathbf{A}$ is a homomorphism. This homomorphism agrees with the third projection homomorphism $\pi_3(a, b, c, d) = c$ on $G(\alpha, \beta)$. Since $q = \pi_3$ on $G(\alpha, \beta)$, and both q and π_3 are homomorphisms, we have $q = \pi_3$ on the generated subalgebra $\langle G(\alpha, \beta) \rangle = M(\alpha, \beta)$. To repeat this statement more directly, $q(a, b, c, d) = c$ whenever $\begin{bmatrix} a & c \\ b & d \end{bmatrix} \in M(\alpha, \beta)$.

We claim that $b = d$ implies $a = c$ whenever $\begin{bmatrix} a & c \\ b & d \end{bmatrix} \in M(\alpha, \beta)$. For, if $b = d$ for some $\begin{bmatrix} a & c \\ b & d \end{bmatrix} \in M(\alpha, \beta)$, then $\begin{bmatrix} a & c \\ d & d \end{bmatrix}, \begin{bmatrix} a & a \\ d & d \end{bmatrix} \in M(\alpha, \beta) \leq R(\alpha, \beta)$. Now we use Item (ii) of the lemma statement together with identities $(I)_q$ from the definition of a Kiss term to conclude that $q(a, d, c, d) = q(a, d, a, d) = a$. Yet $q(a, d, c, d) = c$ by the conclusion of the preceding paragraph. This shows that $a = c$, as claimed.

We have shown that $b = d$ implies $a = c$ whenever $\begin{bmatrix} a & c \\ b & d \end{bmatrix} \in M(\alpha, \beta)$, which is one of the standard definitions of the expression “ $[\alpha, \beta] = 0$ ”. \square

8. REFINEMENTS AND EXTENSIONS

We have shown that, given a 3-ary difference term $p(x, y, z)$ for a variety, the 4-ary Kiss term

$$p(p(x, z, z), p(y, w, z), z)$$

obtained from p via Lipparini’s Formula satisfies certain properties (see our Theorem 1.1 and Lemma 6.2 of [8]). In this section we will see that Theorem 1.1 and Lemma 6.2 of [8] hold for arbitrary Kiss terms, and not just those defined by Lipparini’s Formula. This will be accomplished by showing that in a variety with a difference term, if $[\alpha, \beta] = 0$ then all Kiss terms for the variety agree on $R(\alpha, \beta)$. When $\alpha \leq \beta$, we refine this last result and connect it to 3-ary difference terms for the variety. Next, we extend results in earlier sections by explaining the effect of eliminating the hypothesis “ $[\alpha, \beta] = 0$ ”. Finally, we show that a result of Moorhead for pairs of comparable congruences in congruence meet-semidistributive varieties is true for arbitrary pairs of congruences.

Theorem 8.1. *If q and q' are Kiss terms for \mathcal{V} , $\alpha, \beta \in \text{Con}(\mathbf{A})$, $\mathbf{A} \in \mathcal{V}$, and $[\alpha, \beta] = 0$, then q and q' agree on $R(\alpha, \beta)$.*

Proof. To show that any two Kiss terms agree on $R(\alpha, \beta)$ it suffices to choose a 3-ary difference term p , define the term q from p using Lipparini’s Formula (L), and then prove that any other Kiss term q' agrees with this Lipparini-type Kiss term q on $R(\alpha, \beta)$. Therefore, choose a 3-ary difference term p and let q be given by Lipparini’s Formula applied to p . Thus it follows from Theorem 1.1 that $q: R(\alpha, \beta) \rightarrow \mathbf{A}$ is a homomorphism. Let q' be any other Kiss term.

Since q is a homomorphism on $R(\alpha, \beta)$ and q' is a term, q and q' must commute on arrays of the form

$$\begin{bmatrix} a & b & a & b \\ b & b & b & b \\ a & b & c & d \\ b & b & d & d \end{bmatrix}$$

for all $(a, b, c, d) \in R(\alpha, \beta)$. Here, all of the columns and rows of this 4×4 array belong to $R(\alpha, \beta)$. The commutativity just claimed is the second equality in

$$\begin{aligned} q(a, b, q'(a, b, c, d), d) &= q(q'(a, b, a, b), q'(b, b, b, b), q'(a, b, c, d), q'(b, b, d, d)) \\ &= q'(q(a, b, a, b), q(b, b, b, b), q(a, b, c, d), q(b, b, d, d)) \\ &= q'(a, b, q(a, b, c, d), d). \end{aligned}$$

The first and third equalities follow from the Kiss identities $(I)_q$.

Observe that for any Kiss term q' we have $q'(a, b, c, d) \stackrel{\beta}{\equiv} q'(a, b, a, b) = a$ and $q'(a, b, c, d) \stackrel{\alpha}{\equiv} q'(b, b, d, d) = d$. This implies that if $(a, b, c, d) \in R(\alpha, \beta)$, then $(a, b, q'(a, b, c, d), d) \in R(\alpha, \beta)$. By Lemma 7.1 we obtain

$$q(a, b, q'(a, b, c, d), d) = q(a, b, c, d).$$

A similar argument establishes that $q'(a, b, q(a, b, c, d), d) = q'(a, b, c, d)$. Combining this with the final displayed lines of the previous paragraph we obtain

$$q(a, b, c, d) = q(a, b, q'(a, b, c, d), d) = q'(a, b, q(a, b, c, d), d) = q'(a, b, c, d),$$

showing that q and q' agree on $R(\alpha, \beta)$. \square

Corollary 8.2. *The conclusion of Theorem 1.1 holds for arbitrary Kiss terms.*

Proof. Theorem 1.1 proves that if $[\alpha, \beta] = 0$, then $q: R(\alpha, \beta) \rightarrow \mathbf{A}$ is a homomorphism when q is the Kiss term constructed from a 3-ary difference term by Lipparini's Formula. Theorem 8.1 proves that if q' is any other Kiss term for the same variety and $[\alpha, \beta] = 0$, then $q = q'$ on $R(\alpha, \beta)$. Thus $q': R(\alpha, \beta) \rightarrow \mathbf{A}$ is also a homomorphism (the same one). \square

Corollary 8.3. *Lemma 6.2 of [8] holds for arbitrary Kiss terms.*

Proof. This can be deduced from Lemma 6.2 of [8] (proved in Section 7) using Theorem 8.1, or by replacing the use of Theorem 1.1 in our proof of Lemma 6.2 of [8] in Section 7 with Corollary 8.2. \square

Let \mathcal{V} be a variety with a difference term p , let q be an arbitrary Kiss term for \mathcal{V} , and let $\mathbf{A} \in \mathcal{V}$. Assume $\alpha, \beta \in \text{Con}(\mathbf{A})$ satisfy $[\alpha, \beta] = 0$. We know from Lemma 7.1 that q is independent of its third variable on $R(\alpha, \beta)$. The third variable corresponds to the top right entry in the matrices in $R(\alpha, \beta)$. Therefore, the restriction of q to $R(\alpha, \beta)$ yields a ternary function q^- with codomain A and domain

$$R^-(\alpha, \beta) := \left\{ \begin{bmatrix} a & \\ b & d \end{bmatrix} \in A^3 : \begin{bmatrix} a & c \\ b & d \end{bmatrix} \in R(\alpha, \beta) \text{ for some } c \in A \right\}$$

such that $q^-(a, b, d) = q(a, b, c, d)$ for all $\begin{bmatrix} a & c \\ b & d \end{bmatrix} \in R(\alpha, \beta)$.

Theorem 8.4. *Let \mathcal{V} be a variety with a difference term p , let q be an arbitrary Kiss term for \mathcal{V} , and let $\mathbf{A} \in \mathcal{V}$. Assume $\alpha, \beta \in \text{Con}(\mathbf{A})$ satisfy $[\alpha, \beta] = 0$. The function q^- , defined above, has the following properties:*

(1) *The relation $\Delta(\alpha, \beta)$ is the graph of q^- ; that is,*

$$(8.1) \quad \Delta(\alpha, \beta) = \left\{ \begin{bmatrix} a & q^-(a, b, d) \\ b & d \end{bmatrix} : \begin{bmatrix} a & \\ b & d \end{bmatrix} \in R^-(\alpha, \beta) \right\}.$$

(2) *If $\alpha \leq \beta$, then q^- agrees with p on $R^-(\alpha, \beta)$, hence the relation $\Delta(\alpha, \beta)$ is also the graph of p restricted to $R^-(\alpha, \beta)$:*

$$(8.2) \quad \Delta(\alpha, \beta) = \left\{ \begin{bmatrix} a & p(a, b, d) \\ b & d \end{bmatrix} : \begin{bmatrix} a & \\ b & d \end{bmatrix} \in R^-(\alpha, \beta) \right\}.$$

Proof. The definition of q^- involves only how q restricts to $R(\alpha, \beta)$. Therefore, by Theorem 8.1, no generality is lost by assuming that q is the special Kiss term obtained from p via Lipparini's Formula (L), i.e., q is the Kiss term that we used throughout Sections 2–6.

For (1), the definition of q^- shows that the right-hand side of (8.1) is equal to

$$(8.3) \quad \left\{ \begin{bmatrix} a & q(a, b, c, d) \\ b & d \end{bmatrix} : \begin{bmatrix} a & c \\ b & d \end{bmatrix} \in R(\alpha, \beta) \right\}.$$

Therefore, the inclusion \supseteq in (8.1) follows from Lemma 2.5.

Recall from the definition of $\Delta(\alpha, \beta)$ (Definition 2.1) that $\Delta(\alpha, \beta) \subseteq R(\alpha, \beta)$. Combining this with the inclusion established in the preceding paragraph, we get that the relations on both sides of (8.1) project onto $R^-(\alpha, \beta)$ when omitting the top right entries. In the relation on the right-hand side, the top right entry is clearly a function of the remaining three entries. The same holds for $\Delta(\alpha, \beta)$ by Lemma 2.4 (2). Therefore, both sides of (8.1) are graphs of functions with domain $R^-(\alpha, \beta)$. Since one is a subset of the other, they must be equal. This completes the proof of statement (1).

To prove (2), assume that $\alpha \leq \beta$. Our hypothesis $[\alpha, \beta] = 0$ implies that $[\alpha, \alpha] = 0$.

First we establish the inclusion \supseteq in (8.2). If $\begin{bmatrix} a & \\ b & d \end{bmatrix} \in R^-(\alpha, \beta)$, then $a \stackrel{\alpha}{\equiv} b$, so $[\alpha, \alpha] = 0$ implies that $p(a, b, b) = a$. Hence, by applying p to the following generators

$$\begin{bmatrix} a & a \\ b & b \end{bmatrix}, \quad \begin{bmatrix} b & b \\ b & b \end{bmatrix}, \quad \begin{bmatrix} b & d \\ b & d \end{bmatrix}$$

of $M(\alpha, \beta)$ we get that

$$\begin{aligned} \begin{bmatrix} a & p(a, b, d) \\ b & d \end{bmatrix} &= \begin{bmatrix} p(a, b, b) & p(a, b, d) \\ p(b, b, b) & p(b, b, d) \end{bmatrix} \\ &= p \left(\begin{bmatrix} a & a \\ b & b \end{bmatrix}, \begin{bmatrix} b & b \\ b & b \end{bmatrix}, \begin{bmatrix} b & d \\ b & d \end{bmatrix} \right) \in M(\alpha, \beta) \subseteq \Delta(\alpha, \beta). \end{aligned}$$

This proves that \supseteq holds in (8.2).

Now the same argument as in the second paragraph of the proof of (1) yields that equality holds in (8.2). Combining this with (8.1) we conclude that p and q^- agree on $R^-(\alpha, \beta)$, as claimed. \square

Equality (8.1) yields a characterization of $\Delta(\alpha, \beta)$ in the situation where \mathcal{V} is a variety with a Kiss term q , $\mathbf{A} \in \mathcal{V}$, and $\alpha, \beta \in \text{Con}(\mathbf{A})$ satisfy $[\alpha, \beta] = 0$. In the following corollary we reformulate this characterization in two different ways, the second of which is a fact that will be used in the proof of Theorem 8.8.

Corollary 8.5. *Let \mathcal{V} be a variety with a Kiss term q and let $\mathbf{A} \in \mathcal{V}$. If $\alpha, \beta \in \text{Con}(\mathbf{A})$ satisfy $[\alpha, \beta] = 0$, then the following are true.*

- (1) $\Delta(\alpha, \beta) = \left\{ \begin{bmatrix} a & q(a, b, c, d) \\ b & d \end{bmatrix} : \begin{bmatrix} a & c \\ b & d \end{bmatrix} \in R(\alpha, \beta) \right\}$.
- (2) $\Delta(\alpha, \beta) = \left\{ \begin{bmatrix} a & c \\ b & d \end{bmatrix} \in R(\alpha, \beta) : q(a, b, c, d) = c \right\}$.

Proof. The left-hand side of Item (1) equals the left-hand side of (8.1) in Theorem 8.4 (1). The right-hand side of Item (1) is shown to be equal to the right-hand side of (8.1) in the proof of Theorem 8.4 (1).

To verify Item (2), pick any matrix $M \in \Delta(\alpha, \beta)$ ($\subseteq R(\alpha, \beta)$). According to (8.3), $M = \begin{bmatrix} a & c \\ b & d \end{bmatrix}$ for some $c = q(a, b, c_1, d)$ and some $\begin{bmatrix} a & c_1 \\ b & d \end{bmatrix} \in R(\alpha, \beta)$. By $(\text{II})_q$ and by our assumption $[\alpha, \beta] = 0$, we get that $c = q(a, b, c_1, d) = q(a, b, c, d)$, which shows that $M = \begin{bmatrix} a & c \\ b & d \end{bmatrix}$ is an element of the right-hand side of the equality in Item (2).

Conversely, if $\begin{bmatrix} a & c \\ b & d \end{bmatrix}$ is in the right-hand side of Item (2), that is, $\begin{bmatrix} a & c \\ b & d \end{bmatrix} \in R(\alpha, \beta)$ and $q(a, b, c, d) = c$, then $\begin{bmatrix} a & c \\ b & d \end{bmatrix} = \begin{bmatrix} a & q(a, b, c, d) \\ b & d \end{bmatrix} \in \Delta(\alpha, \beta)$ follows directly from Item (1). \square

In the final portion of this section, we address how to remove the requirement “ $[\alpha, \beta] = 0$ ” from our results about $\Delta(\alpha, \beta)$. Given \mathcal{V} , $\mathbf{A} \in \mathcal{V}$, $\alpha, \beta \in \text{Con}(\mathbf{A})$, we consider the natural map $\nu: \mathbf{A} \rightarrow \mathbf{A}/[\alpha, \beta]: a \mapsto a/[\alpha, \beta]$ and denote by \bar{x} and \overline{X}

the images $\nu(x)$ and $\nu(X)$ of elements $x \in A$ and subsets or relations X on A . We shall compare $\Delta(\alpha, \beta)$ to $\Delta(\overline{\alpha}, \overline{\beta})$. We will learn in Theorem 8.6 that $\Delta(\alpha, \beta)$ is “[α, β]-saturated”. A subset $X \subseteq A$ is θ -saturated for a congruence $\theta \in \text{Con}(\mathbf{A})$ if X is a union of θ -classes. An n -ary relation $R \subseteq A^n$ is θ -saturated if it is a union of θ^n -classes. The saturation result of Theorem 8.6 (2) allows us to reflect information about $\Delta(\overline{\alpha}, \overline{\beta})$, which is the Δ -relation on the quotient $\overline{\mathbf{A}}$ (where $[\overline{\alpha}, \overline{\beta}] = 0$ holds), back to information about $\Delta(\alpha, \beta)$ on \mathbf{A} (where $[\alpha, \beta]$ need not be zero). See e.g. Theorem 8.8. The first step is the next result, which describes properties of $\Delta(\alpha, \beta)$ that are true in any variety. (It is possible to derive Theorem 8.6 (1) from the more-general result [13, Theorem 4.10 (1) \Rightarrow (2)] by observing that $[\alpha, \beta] \subseteq [\alpha, \beta]_H$, but we give our own proof here.)

Theorem 8.6. *Let \mathbf{A} be any algebra and $\alpha, \beta \in \text{Con}(\mathbf{A})$.*

- (1) *If $(a, b) \in [\alpha, \beta]$, then $\begin{bmatrix} a & a \\ a & b \end{bmatrix} \in \Delta(\alpha, \beta)$.*
- (2) *$\Delta(\alpha, \beta)$ is $[\alpha, \beta]$ -saturated.*

Proof. We will freely use the fact that, since $M(\alpha, \beta)$ is closed under interchanging rows or columns, the same is true for $\Delta(\alpha, \beta)$. Hence the conditions $\begin{bmatrix} a & a \\ a & b \end{bmatrix} \in \Delta(\alpha, \beta)$, $\begin{bmatrix} a & a \\ b & a \end{bmatrix} \in \Delta(\alpha, \beta)$, $\begin{bmatrix} b & a \\ a & a \end{bmatrix} \in \Delta(\alpha, \beta)$, and $\begin{bmatrix} a & b \\ a & a \end{bmatrix} \in \Delta(\alpha, \beta)$ are equivalent.

For Item (1), let $\delta_0 = 0 \in \text{Con}(\mathbf{A})$ be the equality relation. If δ_i has been defined, let δ_{i+1} be the congruence of \mathbf{A} generated by

$$(8.4) \quad X_{i+1} = \left\{ (r, s) \in A^2 : \begin{bmatrix} p & q \\ r & s \end{bmatrix} \in M(\alpha, \beta) \text{ for some } (p, q) \in \delta_i \right\}.$$

It is easy to prove (see the proof of [1, Proposition 4.1(3)]) that $\delta_0 \leq \delta_1 \leq \dots$ and $[\alpha, \beta] = \bigcup \delta_i$. We execute the proof of Item (1) by arguing by induction on i that,

$$\text{Item (1)}_i \quad \text{if } (a, b) \in \delta_i, \text{ then } \begin{bmatrix} a & a \\ a & b \end{bmatrix} \in \Delta(\alpha, \beta).$$

Item (1)₀ holds since $\Delta(\alpha, \beta)$ is reflexive. We assume that Item (1) _{i} holds and proceed to prove that Item (1) _{$i+1$} holds. The binary relation X_{i+1} defined on line (8.4) is a subalgebra of \mathbf{A}^2 since $M(\alpha, \beta) \leq \mathbf{A}^{2 \times 2}$ and $\delta_i \in \text{Con}(\mathbf{A})$. The relation is reflexive and symmetric since $M(\alpha, \beta)$ is reflexive and closed under interchanging columns. This shows that X_{i+1} is a tolerance relation on \mathbf{A} . Therefore, the congruence δ_{i+1} generated by X_{i+1} equals the transitive closure of X_{i+1} . If $(a, b) \in \delta_{i+1}$, there must exist a sequence of matrices

$$\begin{bmatrix} p_0 & q_0 \\ r_0 & s_0 \end{bmatrix}, \begin{bmatrix} p_1 & q_1 \\ r_1 & s_1 \end{bmatrix}, \dots, \begin{bmatrix} p_n & q_n \\ r_n & s_n \end{bmatrix}, \quad \text{with } \begin{bmatrix} p_j & q_j \\ r_j & s_j \end{bmatrix} \in M(\alpha, \beta)$$

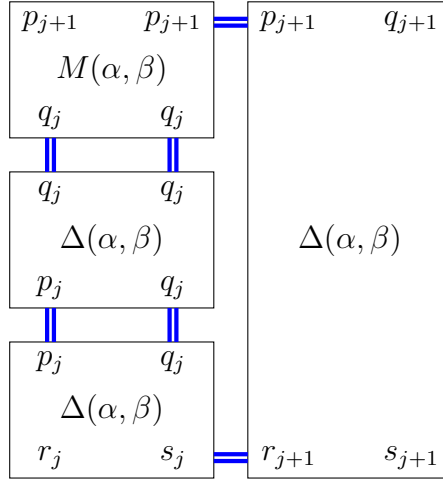

FIGURE 6

where $a = r_0$, $b = s_n$, $s_j = r_{j+1}$ for all $j < n$, and $(p_j, q_j) \in \delta_i$ for all j . We shall employ the following claim to work through this sequence.

Claim 8.7. *If*

(1) both $M = \begin{bmatrix} p_j & q_j \\ r_j & s_j \end{bmatrix}$ and $N = \begin{bmatrix} p_{j+1} & q_{j+1} \\ r_{j+1} & s_{j+1} \end{bmatrix}$ belong to $\Delta(\alpha, \beta)$,

(2) $s_j = r_{j+1}$, and

(3) $(p_j, q_j) \in \delta_i$,

then $\begin{bmatrix} p_{j+1} & q_{j+1} \\ r_j & s_{j+1} \end{bmatrix} \in \Delta(\alpha, \beta)$.

Since $(p_j, q_j) \in \delta_i$, we can use the induction hypothesis to conclude that $\begin{bmatrix} q_j & q_j \\ p_j & q_j \end{bmatrix} \in \Delta(\alpha, \beta)$. This is the center-left matrix in Figure 6. The upper-left matrix in Figure 6 belongs to $G(\alpha, \beta) (\subseteq M(\alpha, \beta) \subseteq \Delta(\alpha, \beta))$, since $(q_j, p_{j+1}) \in \alpha$. (The fact that $(q_j, p_{j+1}) \in \alpha$ follows from $q_j \stackrel{\alpha}{\equiv} s_j = r_{j+1} \stackrel{\alpha}{\equiv} p_{j+1}$.) An examination of Figure 6 establishes that $\begin{bmatrix} p_{j+1} & q_{j+1} \\ r_j & s_{j+1} \end{bmatrix}$ is an element of $\Delta(\alpha, \beta)$, which concludes the proof of Claim 8.7.

Applying Claim 8.7 repeatedly, left-to-right, to the sequence of matrices

$$\begin{bmatrix} p_0 & q_0 \\ r_0 & s_0 \end{bmatrix}, \begin{bmatrix} p_1 & q_1 \\ r_1 & s_1 \end{bmatrix}, \dots, \begin{bmatrix} p_n & q_n \\ r_n & s_n \end{bmatrix} \in M(\alpha, \beta) \subseteq \Delta(\alpha, \beta)$$

leads to $\begin{bmatrix} p_j & q_j \\ r_0 & s_j \end{bmatrix} \in \Delta(\alpha, \beta)$ for all j , in particular $\begin{bmatrix} p_n & q_n \\ a & b \end{bmatrix} = \begin{bmatrix} p_n & q_n \\ r_0 & s_n \end{bmatrix} \in \Delta(\alpha, \beta)$.

Apply Claim 8.7 one more time to the matrices $M = \begin{bmatrix} p_n & q_n \\ a & b \end{bmatrix} \in \Delta(\alpha, \beta)$ and $N = \begin{bmatrix} a & a \\ b & b \end{bmatrix} \in \Delta(\alpha, \beta)$. Note that the assumption that $(a, b) \in \delta_{i+1} \leq [\alpha, \beta]$ implies that $(a, b) \in \alpha$, so we do indeed have $\begin{bmatrix} a & a \\ b & b \end{bmatrix} \in \Delta(\alpha, \beta)$. Claim 8.7 yields that $\begin{bmatrix} a & a \\ a & b \end{bmatrix} \in \Delta(\alpha, \beta)$, as desired. This concludes the inductive proof of Item (1).

Item (2) asserts that if $\begin{bmatrix} a & c \\ b & d \end{bmatrix} \in \Delta(\alpha, \beta)$ and $(a, a'), (b, b'), (c, c'), (d, d') \in [\alpha, \beta]$, then $\begin{bmatrix} a' & c' \\ b' & d' \end{bmatrix} \in \Delta(\alpha, \beta)$. Since $\Delta(\alpha, \beta)$ is closed under row and column interchanges, it suffices to check this one entry at a time, so we only explain why $\begin{bmatrix} a & c \\ b & d \end{bmatrix} \in \Delta(\alpha, \beta)$ and $(a, a') \in [\alpha, \beta]$ imply that $\begin{bmatrix} a' & c \\ b & d \end{bmatrix} \in \Delta(\alpha, \beta)$. By Item (1), the assumption $(a, a') \in [\alpha, \beta]$ implies that $\begin{bmatrix} a' & a \\ a & a \end{bmatrix} \in \Delta(\alpha, \beta)$. Now Figure 7 shows how to realize $\begin{bmatrix} a' & c \\ b & d \end{bmatrix}$ as an element of $\Delta(\alpha, \beta)$. \square

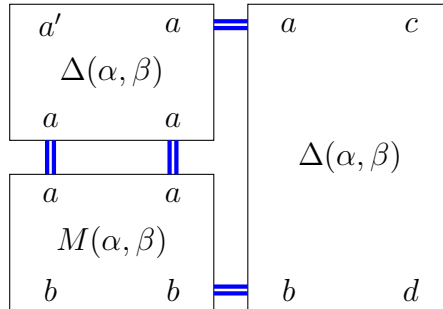

FIGURE 7

The converse of Theorem 8.6 (1) is not true for arbitrary varieties. A counterexample can be constructed by the technique described in [6, Example 3.2]. Nevertheless, the converse of Theorem 8.6 (1) is true if the variety has a Kiss term. This is part of the next theorem.

Theorem 8.8. *Let \mathcal{V} be a variety with a Kiss term q , $\mathbf{A} \in \mathcal{V}$, and $\alpha, \beta \in \text{Con}(\mathbf{A})$.*

$$(1) \Delta(\alpha, \beta) = \left\{ \begin{bmatrix} a & c \\ b & d \end{bmatrix} \in R(\alpha, \beta) : q(a, b, c, d) \stackrel{[\alpha, \beta]}{\equiv} c \right\}.$$

(2) If $\begin{bmatrix} a & c \\ b & d \end{bmatrix} \in R(\alpha, \beta)$ and $c' = q(a, b, c, d)$, then $\begin{bmatrix} a & c' \\ b & d \end{bmatrix} \in \Delta(\alpha, \beta)$.

(Lemma 2.5 is true without the assumption “[α, β] = 0”.)

(3) $[\alpha, \beta] = \left\{ (a, b) \in A^2 : \begin{bmatrix} a & a \\ a & b \end{bmatrix} \in \Delta(\alpha, \beta) \right\}$.

(The converse of Theorem 8.6 (1) is true in the presence of a Kiss term.)

Proof. To simplify notation, we will write $\overline{\mathbf{A}}$ for $\mathbf{A}/[\alpha, \beta]$, and we will use the “bar notation” introduced in the paragraph preceding Theorem 8.6 for passing from elements of \mathbf{A} or relations on \mathbf{A} to the elements of $\overline{\mathbf{A}}$ or relations on $\overline{\mathbf{A}}$ under the quotient map $\mathbf{A} \rightarrow \overline{\mathbf{A}}$.

For the equality in Item (1) we need to argue that the following are equivalent for arbitrary elements a, b, c, d of \mathbf{A} :

(a) $\begin{bmatrix} a & c \\ b & d \end{bmatrix} \in \Delta(\alpha, \beta)$.

(b) $\begin{bmatrix} a & c \\ b & d \end{bmatrix} \in R(\alpha, \beta)$ and $q(a, b, c, d) \stackrel{[\alpha, \beta]}{\equiv} c$.

We will establish (a) \Leftrightarrow (b) by showing that each one of (a) and (b) is equivalent to the following condition:

(c) $\begin{bmatrix} \overline{a} & \overline{c} \\ \overline{b} & \overline{d} \end{bmatrix} \in \Delta(\overline{\alpha}, \overline{\beta})$.

We start with (a) \Leftrightarrow (c). Proving (a) \Rightarrow (c) is equivalent to showing that $\overline{\Delta(\alpha, \beta)} \subseteq \Delta(\overline{\alpha}, \overline{\beta})$. To prove this inclusion, recall that in the proof of Lemma 2.2 we defined an increasing sequence

$$M(\alpha, \beta) =: M_0(\alpha, \beta) \subseteq M_1(\alpha, \beta) \subseteq \cdots \subseteq M_n(\alpha, \beta) \subseteq \cdots$$

of subalgebras of $\mathbf{A}^{2 \times 2}$ and proved that $\Delta(\alpha, \beta) = \bigcup_{n \geq 0} M_n(\alpha, \beta)$. Applying this fact to the algebra $\overline{\mathbf{A}}$ and $\overline{\alpha}, \overline{\beta} \in \text{Con}(\overline{\mathbf{A}})$, we get a sequence

$$M(\overline{\alpha}, \overline{\beta}) =: M_0(\overline{\alpha}, \overline{\beta}) \subseteq M_1(\overline{\alpha}, \overline{\beta}) \subseteq \cdots \subseteq M_n(\overline{\alpha}, \overline{\beta}) \subseteq \cdots$$

of subalgebras of $\overline{\mathbf{A}}^{2 \times 2}$ such that $\Delta(\overline{\alpha}, \overline{\beta}) = \bigcup_{n \geq 0} M_n(\overline{\alpha}, \overline{\beta})$. We claim that

$$(8.5) \quad \overline{M_n(\alpha, \beta)} \subseteq M_n(\overline{\alpha}, \overline{\beta})$$

holds for all $n \geq 0$. For $n = 0$, we have equality, because $\overline{G(\alpha, \beta)} = G(\overline{\alpha}, \overline{\beta})$ for the generating sets of $M_0(\alpha, \beta) = M(\alpha, \beta)$ and $M_0(\overline{\alpha}, \overline{\beta}) = M(\overline{\alpha}, \overline{\beta})$ (see the definition of $G(\alpha, \beta)$ at (2.1)). For $n > 0$, the definitions of $M_n(\alpha, \beta)$ and $M_n(\overline{\alpha}, \overline{\beta})$ yield (8.5) by induction. Thus,

$$\overline{\Delta(\alpha, \beta)} = \bigcup_{n \geq 0} \overline{M_n(\alpha, \beta)} \subseteq \bigcup_{n \geq 0} M_n(\overline{\alpha}, \overline{\beta}) = \Delta(\overline{\alpha}, \overline{\beta}),$$

as claimed.

For the converse, (c) \Rightarrow (a), we need to argue that if $\begin{bmatrix} \bar{a} & \bar{c} \\ \bar{b} & \bar{d} \end{bmatrix} \in \Delta(\bar{\alpha}, \bar{\beta})$, then $\begin{bmatrix} a & c \\ b & d \end{bmatrix} \in \Delta(\alpha, \beta)$. Since $\Delta(\bar{\alpha}, \bar{\beta}) = \bigcup_{n \geq 0} M_n(\bar{\alpha}, \bar{\beta})$, it suffices to show that for every $n \geq 0$,

$$(8.6) \quad \forall a, b, c, d \in A, \text{ if } \begin{bmatrix} \bar{a} & \bar{c} \\ \bar{b} & \bar{d} \end{bmatrix} \in M_n(\bar{\alpha}, \bar{\beta}), \text{ then } \begin{bmatrix} a & c \\ b & d \end{bmatrix} \in \Delta(\alpha, \beta).$$

We will proceed by induction on n .

First let $n = 0$ and choose any $\begin{bmatrix} \bar{a} & \bar{c} \\ \bar{b} & \bar{d} \end{bmatrix} \in M_0(\bar{\alpha}, \bar{\beta}) = \overline{M_0(\alpha, \beta)}$. There must exist $\begin{bmatrix} a_0 & c_0 \\ b_0 & d_0 \end{bmatrix} \in M_0(\alpha, \beta)$ such that $\bar{a}_0 = \bar{a}$, $\bar{b}_0 = \bar{b}$, $\bar{c}_0 = \bar{c}$, and $\bar{d}_0 = \bar{d}$. Thus, $\begin{bmatrix} a_0 & c_0 \\ b_0 & d_0 \end{bmatrix} \in \Delta(\alpha, \beta)$ and $a_0 \stackrel{[\alpha, \beta]}{\equiv} a$, $b_0 \stackrel{[\alpha, \beta]}{\equiv} b$, $c_0 \stackrel{[\alpha, \beta]}{\equiv} c$, $d_0 \stackrel{[\alpha, \beta]}{\equiv} d$. Since $\Delta(\alpha, \beta)$ is $[\alpha, \beta]$ -saturated (Theorem 8.6 (2)) we get that $\begin{bmatrix} a & c \\ b & d \end{bmatrix} \in \Delta(\alpha, \beta)$, proving (8.6) for $n = 0$.

Next, consider the case when n is odd, and assume that (8.6) holds for $n - 1$ in place of n . By definition, if $\begin{bmatrix} \bar{a} & \bar{c} \\ \bar{b} & \bar{d} \end{bmatrix} \in M_n(\bar{\alpha}, \bar{\beta})$, then $\bar{\mathbf{A}}$ has elements \bar{r}, \bar{s} ($r, s \in A$) such that $\begin{bmatrix} \bar{a} & \bar{r} \\ \bar{b} & \bar{s} \end{bmatrix}, \begin{bmatrix} \bar{r} & \bar{c} \\ \bar{s} & \bar{d} \end{bmatrix} \in M_{n-1}(\bar{\alpha}, \bar{\beta})$. The induction hypothesis yields that $\begin{bmatrix} a & r \\ b & s \end{bmatrix}, \begin{bmatrix} r & c \\ s & d \end{bmatrix} \in \Delta(\alpha, \beta)$. Thus, $\begin{bmatrix} a & c \\ b & d \end{bmatrix} \in \Delta(\alpha, \beta)$, proving (8.6) when n is odd.

The case when $n > 0$ is even can be handled the same way, so the proof of (8.6) is complete. This finishes the proof that (a) \Leftrightarrow (c).

It remains to show that (b) \Leftrightarrow (c). Since $R(\alpha, \beta)$ is $(\alpha \cap \beta)$ -saturated and $[\alpha, \beta] \leq (\alpha \cap \beta)$, $R(\alpha, \beta)$ is $[\alpha, \beta]$ -saturated. Therefore, Condition (b) is equivalent (after factoring by $[\alpha, \beta]$) to

$$(b) \quad \begin{bmatrix} \bar{a} & \bar{c} \\ \bar{b} & \bar{d} \end{bmatrix} \in R(\bar{\alpha}, \bar{\beta}) \text{ and } q(\bar{a}, \bar{b}, \bar{c}, \bar{d}) = \bar{c}.$$

Since $[\bar{\alpha}, \bar{\beta}] = 0$, Corollary 8.5 (2) proves that Condition (b) is equivalent to $\begin{bmatrix} \bar{a} & \bar{c} \\ \bar{b} & \bar{d} \end{bmatrix} \in \Delta(\bar{\alpha}, \bar{\beta})$, which is Condition (c). This finishes the proof of Item (1).

To prove Item (2) assume that $\begin{bmatrix} a & c \\ b & d \end{bmatrix} \in R(\alpha, \beta)$ and $q(a, b, c, d) = c'$. Factoring by $[\alpha, \beta]$ yields $\begin{bmatrix} \bar{a} & \bar{c} \\ \bar{b} & \bar{d} \end{bmatrix} \in R(\bar{\alpha}, \bar{\beta})$ and $q(\bar{a}, \bar{b}, \bar{c}, \bar{d}) = \bar{c}'$, but in this quotient $[\bar{\alpha}, \bar{\beta}] = 0$.

By Lemma 2.5, $\begin{bmatrix} \bar{a} & \bar{c}' \\ \bar{b} & \bar{d} \end{bmatrix} \in \Delta(\bar{\alpha}, \bar{\beta})$. Using the equivalence (a) \Leftrightarrow (c) from the proof of Item (1), we get $\begin{bmatrix} a & c' \\ b & d \end{bmatrix} \in \Delta(\alpha, \beta)$.

For Item (3), we have \subseteq from Lemma 8.6 (1) and we need to prove the opposite inclusion. Assume $\begin{bmatrix} a & a \\ a & b \end{bmatrix} \in \Delta(\alpha, \beta)$. Since $\Delta(\alpha, \beta)$ is closed under interchanging rows, we also have that $\begin{bmatrix} a & b \\ a & a \end{bmatrix} \in \Delta(\alpha, \beta)$. Now the description of $\Delta(\alpha, \beta)$ in Item (1) implies that $\begin{bmatrix} a & b \\ a & a \end{bmatrix} \in R(\alpha, \beta)$ and $q(a, a, b, a) \stackrel{[\alpha, \beta]}{\equiv} b$. Since $\begin{bmatrix} a & a \\ a & a \end{bmatrix} \in \Delta(\alpha, \beta)$, properties (I)_q and (II)_q of q force $a = q(a, a, a, a) \stackrel{[\alpha, \beta]}{\equiv} q(a, a, b, a)$. Thus, $a \stackrel{[\alpha, \beta]}{\equiv} b$, which completes the proof of equality in Item (3). Note that this also proves the final statement in Item (3). \square

Remarks. 1. Ralph Freese and Ralph McKenzie [2, Theorem 4.9] proved our Theorem 8.8(3) in the restricted setting of congruence modular varieties, but with $\Delta(\alpha, \beta)$ replaced by $\Delta_{\alpha, \beta}$ (see Section 2). It can be shown that $\Delta_{\alpha, \beta} = \Delta(\alpha, \beta)$ in any congruence modular variety, so our Theorem 8.8 (3) can be viewed as an extension of their result to varieties with a difference term.

2. Similarly, Kiss [9, Theorem 3.8 (ii)] proved our Theorem 8.8 Items (1) and (2) in the congruence modular setting, but with $\Delta(\alpha, \beta)$ replaced by $\Delta_{\alpha, \beta}$.

3. Our Theorem 8.8 (3) can be deduced from a related result of Moorhead. In [13], Moorhead defines the ‘‘hypercommutator’’ $[\alpha, \beta]_H$ of congruences α and β to be the smallest congruence δ satisfying the implication $(a, c) \in \delta \implies (b, d) \in \delta$ for all $\begin{bmatrix} a & c \\ b & d \end{bmatrix} \in \Delta(\alpha, \beta)$. In [13, Proposition 3.5], Moorhead shows that if α, β are congruences of any algebra whatsoever, then $[\alpha, \beta]_H$ is equal to the set on the right-hand side of the equation in the statement of our Theorem 8.8 (3). Since $[\alpha, \beta]_H$ is always sandwiched between the usual commutator $[\alpha, \beta]$ and the linear commutator $[\alpha, \beta]_\ell$ (see [7] for the definition of $[\alpha, \beta]_\ell$), and since $[\alpha, \beta] = [\alpha, \beta]_\ell$ in varieties with a difference term by [5, Lemma 2.2] and [7, Corollary 4.5], our Theorem 8.8 (3) can be viewed as the specialization of Moorhead’s [13, Proposition 3.5] to algebras in varieties with a difference term.

We can use Theorem 8.8 to obtain the following result, which was previously obtained by Moorhead [13, Theorem 5.2] in the special case that $\alpha = \beta$.

Corollary 8.9. *Let \mathcal{V} be a congruence meet-semidistributive variety. If $\mathbf{A} \in \mathcal{V}$ and $\alpha, \beta \in \text{Con}(\mathbf{A})$, then $R(\alpha, \beta) = \Delta(\alpha, \beta)$.*

Proof. If \mathcal{V} is congruence meet-semidistributive, then $q(x, y, z, w) = z$ is a Kiss term for \mathcal{V} . Using this and the fact that $[\alpha, \beta]$ is a reflexive relation, the statement of Theorem 8.8 (1) reduces to $R(\alpha, \beta) = \Delta(\alpha, \beta)$. \square

In closing, we note that Kiss’s proof of Theorem 1.1 in the congruence modular case was relatively short and used standard properties of congruences and the commutator operation in congruence modular varieties. By contrast, our proof of Theorem 1.1 is long, complicated and syntactic.

PROBLEM. Develop the theory of congruences and commutators in varieties with a difference term, sufficient to support a short, direct proof of our Theorem 1.1.

REFERENCES

- [1] W. DEMEO, R. FREESE, AND M. VALERIOTE, *Polynomial-time tests for difference terms in idempotent varieties*, Internat. J. Algebra Comput., 29 (2019), pp. 927–949.
- [2] R. FREESE AND R. MCKENZIE, *Commutator theory for congruence modular varieties*, vol. 125 of London Mathematical Society Lecture Note Series, Cambridge University Press, Cambridge, 1987.
- [3] H.-P. GUMM, *An easy way to the commutator in modular varieties*, Arch. Math. (Basel), 34 (1980), pp. 220–228.
- [4] G. JANELIDZE AND M. C. PEDICCHIO, *Pseudogroupoids and commutators*, Theory Appl. Categ., 8 (2001), pp. No. 15, 408–456.
- [5] K. A. KEARNES, *Varieties with a difference term*, J. Algebra, 177 (1995), pp. 926–960.
- [6] K. A. KEARNES AND E. W. KISS, *The shape of congruence lattices*, Mem. Amer. Math. Soc., 222 (2013), pp. viii+169.
- [7] K. A. KEARNES AND Á. SZENDREI, *The relationship between two commutators*, Internat. J. Algebra Comput., 8 (1998), pp. 497–531.
- [8] K. KEARNES, Á. SZENDREI, AND R. WILLARD, *A finite basis theorem for difference-term varieties with a finite residual bound*, Trans. Amer. Math. Soc., 368 (2016), pp. 2115–2143.
- [9] E. W. KISS, *Three remarks on the modular commutator*, Algebra Universalis, 29 (1992), pp. 455–476.
- [10] P. LIPPARINI, *Commutator theory without join-distributivity*, Trans. Amer. Math. Soc., 346 (1994), pp. 177–202.
- [11] ———, *A characterization of varieties with a difference term*, Canad. Math. Bull., 39 (1996), pp. 308–315.
- [12] ———, *A Kiss 4-difference term from a ternary term*, Algebra Universalis, 42 (1999), pp. 153–154.
- [13] A. MOORHEAD, *Supernilpotent Taylor algebras are nilpotent*, Trans. Amer. Math. Soc., 374 (2021), pp. 1229–1276.

DEPARTMENT OF MATHEMATICS, UNIVERSITY OF COLORADO, BOULDER, COLORADO 80309-0395, USA

Email address: kearnes@colorado.edu

DEPARTMENT OF MATHEMATICS, UNIVERSITY OF COLORADO, BOULDER, COLORADO 80309-0395, USA

Email address: szendrei@colorado.edu

PURE MATHEMATICS DEPARTMENT, UNIVERSITY OF WATERLOO, WATERLOO, ONTARIO N2L 3G1, CANADA

Email address: ross.willard@uwaterloo.ca