

IRONWAN: Increasing Reliability of Overlapping Networks in LoRaWAN

Laksh Bhatia, Po-Yu Chen, Michael Breza, Cong Zhao, Julie A. McCann

Department of Computing, Imperial College London

{laksh.bhatia16,po-yu.chen11,michael.breza04,c.zhao,j.mccann}@imperial.ac.uk

Abstract—LoRaWAN deployments follow an ad-hoc deployment model that has organically led to overlapping communication networks, sharing the wireless spectrum, and completely unaware of each other. LoRaWAN uses ALOHA-style communication where it is almost impossible to schedule transmission between networks belonging to different owners properly. The inability to schedule overlapping networks will cause inter-network interference, which will increase node-to-gateway message losses and gateway-to-node acknowledgement failures. This problem is likely to get worse as the number of LoRaWAN networks increase. In response to this problem, we propose IRONWAN, a wireless overlay network that shares communication resources without modifications to underlying protocols. It utilises the broadcast nature of radio communication and enables gateway-to-gateway communication to facilitate the search for failed messages and transmit failed acknowledgements already received and cached in overlapping network’s gateways. IRONWAN uses two novel algorithms, a Real-time Message Inter-arrival Predictor, to highlight when a server has not received an expected uplink message. The Interference Predictor ensures that extra gateway-to-gateway communication does not negatively impact communication bandwidth. We evaluate IRONWAN on a 1000-node simulator with up to ten gateways and a 10-node testbed with 2-gateways. Results show that IRONWAN can achieve up to 12% higher packet delivery ratio (PDR) and total messages received per node while increasing the minimum PDR by up to 28%. These improvements save up to 50% node’s energy. Finally, we demonstrate that IRONWAN has comparable performance to an optimal solution (wired, centralised) but with 2-32 times lower communication costs. IRONWAN also has up to 14% better PDR when compared to FLIP, a wired-distributed gateway-to-gateway protocol in certain scenarios.

Index Terms—lorawan, multi-owner, overlapping, reliability

I. INTRODUCTION

LoRaWAN [1] is a widely deployed Low Power Wide Area Network (LPWAN) wireless communication protocol used in many large scale Internet of Things (IoT) systems, including city-scale sensing, smart urban infrastructure, precision agriculture, and industry 4.0 [2]. It provides a low-power solution to applications that tolerate low data rates, are uplink-heavy and generally delay-tolerant. LoRaWAN is a license-free protocol that allows users to deploy their networks (including nodes, gateways, and servers) anywhere and in any density that they require.

This freedom of deployment by different stakeholders in a space creates communication interference among overlapping networks or networks in close physical proximity. LPWANs like NB-IoT and Sigfox solve the problem of overlapping networks by being carrier controlled. NB-IoT gateways are

positioned to implement purposefully designed minimally overlapping cells. Overlapping may exist with SigFox, but a network’s location and capacity are constrained to a single carrier. The carrier controlled approach constrains networks to areas where, for example, a network operator can provide communication coverage.

The deployment model of LoRaWAN is one reason for its popularity and broad adoption. Over 1.3 million public and private LoRaWAN gateways have been deployed by 2021¹. LoRaWAN allows private stakeholders to build personal LPWAN networks for security and privacy reasons [2]. LoRaWAN is also preferred in areas where network infrastructures and Internet access are unreliable or not readily available. It can be deployed relatively cheaply without the need for a carrier.

Overlapping LoRaWAN networks cause unexpected packet collisions and duty-cycle exhaustion. We demonstrate this in Sec. II through a simulation of a 1,000 node network with 6 gateways (results in Fig.2). Our simulation shows that the packet delivery ratio (PDR) of four overlapping networks is 50% less than that of the same sized deployment owned by a single network.

Without a carrier-controlled system, it is a challenge for overlapping LoRaWAN deployments to optimise their network settings (e.g. scheduling, transmission parameters) as in Sigfox and NB-IoT. Simply sharing network metrics (e.g. network loads and node transmission patterns) between networks is not sufficient to solve this problem without sophisticated analysis to determine when gateways should interact and how to do so without disrupting the other networks. A naive gateway-to-gateway (G2G) solution would create potential security vulnerabilities. Malicious users could send falsified information for their benefit or jam the network at critical times [3].

Recent research has shed light on the problem of overlapping networks in LoRaWAN and exposed beneficial opportunities [4], [5], [6]. LoRaWAN operates in the unlicensed spectrum, and gateways receive all messages in their communication range. LoRaWAN encrypts the messages so that only the desired users can decode them. These encrypted messages, however, are available at gateways and servers that have no use for them. This presents an opportunity for gateways and servers to deliver messages not destined for them to other networks that may have missed those messages.

For example, [7] proposes message exchanging between network servers via an Internet-based cloud service. FLIP

¹<https://www.semtech.com/lor>

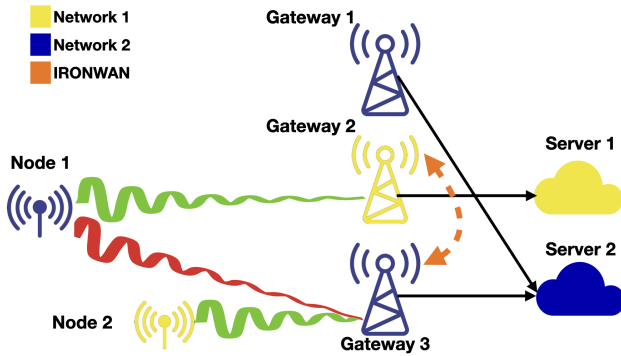

Fig. 1: IRONWAN creates a wireless overlay network to link overlapping networks (networks 1 and 2) to exchange uplink and downlink transmissions. IRONWAN replays failed messages for uplink collisions (red colour) and can use the link for acknowledgements

[4] constructs a G2G backhaul network to transfer the reception and acknowledgement responsibility of nodes from one network to gateways of an overlapping network. However, these approaches require reliable wired backhaul access (for internet access or G2G communications), which may not be available in hazardous or remote areas [8]. Furthermore, these approaches (e.g. [4]) require the network owners to co-ordinate and agree to exchange authentication keys or grant full access [9] to the gateways of other networks. This puts each network at risk of injection attacks or falsified data and the dropping of uplink or downlink messages.

In this paper, we propose *Increasing Reliability of Overlapping Networks in LoRaWAN* (IRONWAN), a solution to the problems caused by overlapping LoRaWAN networks. It is a software approach that requires no additional backhaul networks, internet access or cloud services and can be readily deployed by only updating the gateways. IRONWAN organises the gateways of multiple networks into a wireless overlay network for G2G message exchange (as shown in Fig.1). IRONWAN allows a gateway from one network to act as a redundant receiver for gateways of another network without revealing their encryption keys. Gateways operate IRONWAN can receive their uplink messages even when they do not share the same network server (i.e. they belong to different networks). IRONWAN also enables gateways in the overlay network to share their downlink capacity. Gateways that have exhausted their allocated duty cycle on the downlink channel can send downlink messages via other gateways with free capacity. Sharing uplink and downlink messages allow all overlapping networks to increase the number of unique messages they can receive per node (which implies they have more data per node). It also helps to reduce the number of retransmissions for messages requiring acknowledgements, which saves a node's energy. Since there is no need to share encryption keys, there is no need for coordination between the network owners and no chance of the associated security threats. All that is required is adding some services on the gateways and no modification to the nodes making the adoption of IRONWAN trivial and anonymous.

Gateways in IRONWAN send G2G messages only when necessary and with local information in a fully distributed manner. Our contributions in this work are summarised as below:

- By analysing 11-million real-world LoRaWAN messages, we propose a Real-time Message Inter-arrival Prediction (RMIP) algorithm. With RMIP, gateways can adaptively predict message-arrival times from hundreds if not thousands of uplink nodes with only $O(n)$ computation and memory overhead. Here n is a user-defined parameter (i.e. window size) that is typically small and independent of network and message sizes. Our evaluation shows RMIP can achieve more than 99% accuracy in both precision and recall at the same time.
- To minimise communication interference caused by the G2G communications in IRONWAN, we propose InterPred. InterPred exploits reinforcement-learning techniques to predict the behaviours of other nodes to avoid message collisions during G2G communication in a fully distributed manner. Our evaluation results demonstrate that InterPred reduces messages collisions for G2G communications from 16% – 39% to 7% – 13% given different networks loads.
- We test IRONWAN (with RMIP and InterPred) with a trace-driven simulation consisting of 1,000 nodes and 6-10 gateways against original LoRaWAN, FLIP [4] and an optimised centralised wired approach using OMNet++. Our experimental results show that IRONWAN improves packet delivery ratio (PDR) up to 28% and reduces message re-transmissions by 50% compared to the original LoRaWAN. Compared to FLIP with hardware backhaul between gateways, IRONWAN shows comparable performance improvement and outperforms FLIP with more than 8 gateways. We also implemented and tested IRONWAN with a 10-node test-bed to demonstrate its practicality.

We organise the paper as follows. We present preliminaries and background in Sec. II. We present an overview of IRONWAN in Sec. III. We then describe the detailed design of RMIP and InterPred in Sec. IV and V. We present the experimental results in Sec. VI, and then we round out our discussion with sections on the limitations and potential extensions of our approach VII, related work VIII, and a conclusion IX.

II. BACKGROUND AND PRELIMINARIES

In this section, we describe the current LoRaWAN architecture and the problems with overlapping networks.

A. LoRaWAN Architecture Overview

LoRaWAN operates a 3-level architecture, consisting of *nodes*, *gateways* and *servers*. They are (as shown in Fig.1): **Nodes** are devices responsible for sensing and transmitting data to servers via gateways using LoRaWAN[1]. These nodes use the ALOHA channel access scheme. They must implement Class-A functionality, where nodes open two receive windows(1 and 2 seconds) after transmission to receive acknowledgements for their messages. If messages are not acknowledged, nodes can retransmit these messages. The number of retransmissions and the algorithm are user-defined.

Gateways are the bridges between servers and nodes responsible for wireless communication with nodes. They receive messages via uplink channels and send control and acknowledgement messages via downlink channels. The owner of the gateway chooses to which server to forward all messages. In LoRaWAN, the gateways forward *all* messages they receive to the servers even if the messages belong to other networks. **Servers** are the final destination for the data collected by the nodes. Servers discard messages belonging to unknown nodes (other networks) as they are unwanted and cannot be decoded. Once messages are successfully delivered, servers select the gateway with the best link conditions with the originating node (e.g. highest RSSI, SNR) to send acknowledgements when necessary.

B. Impact of overlapping networks

To study the effect of multiple overlapping networks on the packet delivery ratio (PDR) and the number of unique uplink messages per node received at the server (for a detailed description, see Sec.VI), we simulate 1000 nodes generating a message every 3 minutes. Fig.2 shows the results for a network with 1 owner and 4 overlapping networks with 4 owners with the same network topology. We test the networks under three levels of message acknowledgement requirements (i.e. low:10%, medium:50% and high:100%). At all three levels, the 1-owner network outperforms the networks with 4-owners. Given networks consisting of 6 gateways, the number of unique messages received per node and PDR of the 1-owner network is 65% and 50% higher than the network consisting of 4 different stakeholders without gateway sharing. Our analysis shows that networks with 4-owners suffer from extensive message collisions caused by message retransmissions or lack of available duty-cycle to acknowledge these messages. This work aims to introduce the performance advantages of 1-owner networks to networks with multiple owners by sharing gateway resources between multiple owners.

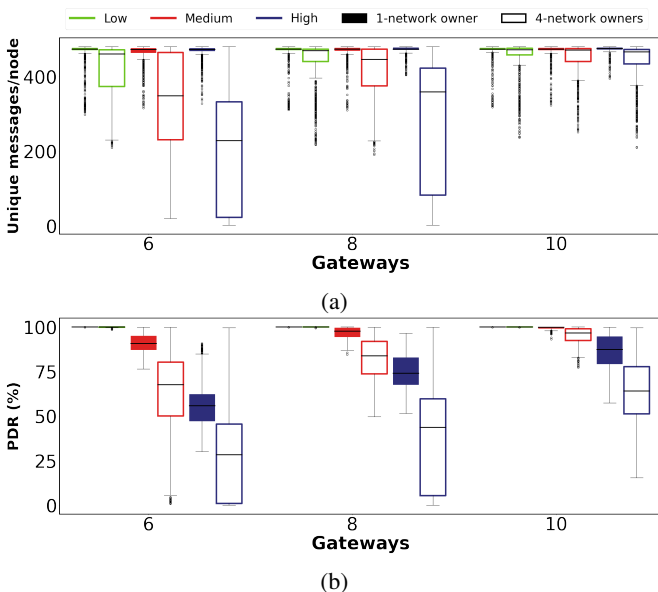

Fig. 2: Effect of partitioning in a LoRaWAN network

III. IRONWAN OVERVIEW

IRONWAN is a G2G communication system that solves the message loss and downlink duty-cycle exhaustion problems caused by overlapping LoRaWAN networks. It does this by enabling gateways to coordinate to find lost uplink messages and share downlink capacity. Importantly, IRONWAN schedules G2G communication to minimise interference to all of the networks. IRONWAN runs as an add-on module on LoRaWAN gateways, is fully compatible with the LoRaWAN specifications, does not require any backhaul networks, does not incur usage costs, and is readily deployable with a software update on the gateways. This section presents an overview of IRONWAN’s architecture and the four sub-modules forming IRONWAN. We then provide an operational overview describing the interactions between modules and the objectives and challenges for IRONWAN.

A. IRONWAN Architecture

IRONWAN consists of four sub-modules: a manager, a cache and two learning algorithms that run on every IRONWAN-enabled gateway as shown in Fig.3. They are:

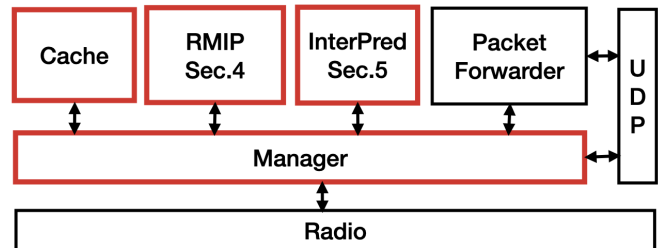

Fig. 3: Interaction between LoRa radio, packet forwarder and IRONWAN’s modules (shown in red)

- 1) **Manager module** facilitates gateway communication. This module is responsible for scheduling and orchestrating access to the wireless channel for a gateway, tracking channel usage, querying RMIP and InterPred when needed and handling incoming G2G messages from other gateways. The Manager module is also responsible for requesting lost uplink messages (by querying RMIP), handing over downlink messages and ensuring that any G2G communication causes minimal interference (by querying InterPred). IRONWAN also introduces new G2G messages that are not defined in standard LoRaWAN, and so the manager module is also responsible for prioritising and scheduling these messages. It also forwards messages received from the radio layer to the appropriate modules, including the Packet Forwarder (part of the LoRaWAN specification). No encryption keys need to be shared by the manager modules of different gateways.
- 2) **Caching Module** caches the latest data packages received from nearby nodes within the communication range. Upon receiving data requests (for lost messages) from other gateways, the manager module accesses this cache to find the requested messages. The data stored in this cache are deleted after a user-defined time to limit memory consumption.
- 3) **Real-time Message Inter-Arrival Predictor (RMIP)**: estimates the message-arrival time for every node within the

reception range. If an the expected message does not arrive in time, it triggers the manager module to request the lost message from gateways belonging to other networks, or the manager module can poll this module to get information about lost messages, see Sec.IV.

- 4) **Interference Predictor (InterPred):** predicts if a G2G communication can cause interference through training a value-based reinforcement-learning agent which learns channel usage in real-time. By querying this module, the manager can choose time-slots and channels for G2G communications without causing interference to N2G communication, see Sec.V.

B. Operation Overview

Every gateway has to perform three operations alongside standard LoRaWAN functionality to be IRONWAN-compliant. The first is to duplicate and forward the received messages correctly. The second is to request for failed uplink messages if they haven't arrived. The third is to hand over downlink messages if a gateway has no downlink capacity. These operations are described in detail below.

Received Messages. As shown in Fig.4a, the manager module forwards all valid LoRaWAN messages to the cache module, RMIP module, InterPred module and the packet forwarder. The packet forwarder sends the message to the server as per the LoRaWAN specification.

Request for a lost uplink message due to uplink packet collisions. As described in Fig.4b, a gateway's RMIP module indicates to the manager that an uplink message from a node was lost ①. The manager then sends a *Request for uplink message* with the node's address and last received message ID to radio ② which in-turn broadcasts it using LoRa ③. The manager module of the receiving gateway ④, queries its caching module for a newer message than the message ID for that particular node ⑤. If there is such a message⑥, the gateway responds to the requesting gateway with a *Rebroadcast an uplink message* to radio ⑦ that then broadcasts it using LoRa ⑧. These messages are received by the gateway⑨ and forwarded to the server⑩. Essentially, the gateways act as store-and-replay intermediaries, and this increases overall network throughput.

Request to send a downlink message due to duty-cycle exhaustion on downlink channels. As shown in Fig.4c, IRONWAN enables a gateway with no remaining downlink duty-cycle to handover the transmission of downlink messages to other gateways. Whenever the manager receives a message from packet forwarder①, and it cannot transmit it, the requesting gateway's packet forwards it to manager② that encapsulates the packet in a *Request to forward Downlink message* and sends it to radio③ that broadcasts it using LoRa ④. If a gateway belonging to another network receives this message, it checks its cache to verify if it has received a message from that particular node in the last two seconds⑤. If the gateway has received a message from that node, it gets the time of when to transmit the message from its cache, and it schedules⑥ and transmits a *Neighbour Downlink Message*⑦.

C. Objective and Challenges

IRONWAN solves the problem caused by overlapping networks by exchanging failed uplink and downlink messages between gateways. IRONWAN uses LoRaWAN for G2G communication. LoRaWAN operates in the sub-GHz unlicensed band, which is subject to a 1% duty-cycle on band 0 (868.0-868.8 MHz for both uplink and downlink) and a 10% duty-cycle on band 1 (869.40-869.65 MHz for downlink) in the EU. As the access to the channel is duty-cycle limited, this makes communication a scarce resource. So message transmissions need to be planned and scheduled to use the spectrum efficiently. Gateways are also resource-constrained devices (e.g. raspberry pi) and may connect to hundreds if not thousands of nodes simultaneously. It is essential to ensure all of the solutions are lightweight and can scale to large networks. This creates two new challenges:

1. Deciding when to hunt for missing messages. We aim to solve the problem of uplink packet collisions by requesting the gateways of other networks to retransmit a message that failed to arrive at its own network as is described in Subsec. III-B. Gateways have to accurately estimate when to expect message arrivals for every node in their communication range. To understand if this could be estimated, we analyse 11-million real-world LoRaWAN messages to see if there was an observable trend, using the LoED dataset [10]. LoED is a real-world dataset consisting of LoRaWAN messages collected by passively listening at 9 gateways deployed in London, representing a dense urban environment. LoED's data showed that message inter-arrival times per node are relatively consistent. 56% of the nodes in the dataset sent messages periodically, 5% of these nodes changed their transmission period at some point because of application layer changes or the reassignment of node ids, and only 4% of the nodes which transmit messages periodically require acknowledgements. This observation is in line with the results in citeChoi2020. Their results show that around 65% of the nodes transmit with intervals that have less than 10 seconds of standard deviation. These results indicate that gateways can predict the message arrival time for nodes that send messages periodically. An additional solution is also required to cope with changes in inter-arrival periods and errors from undefined behaviours that could deviate from our predictions.

2. G2G communication scheduling. Whenever a G2G communication occurs to exchange uplink or downlink messages, it can only occur on band 0 as gateways only listen on that band. G2G messages will interfere with node-to-gateway (N2G) communication on band 0. A gateway can choose from several channels and times on this band to transmit a packet. If it transmits at the wrong time on the wrong channel, it will interfere with an N2G message, leading to a lost packet, triggering retransmission. We need an effective, lightweight solution to predict and avoid interference so gateways can schedule G2G transmissions that cause the least interference. The solution needs to consider the changes in the environment, like varying transmission periods and network conditions that affect communication parameters.

In this section, we have described IRONWAN's compo-

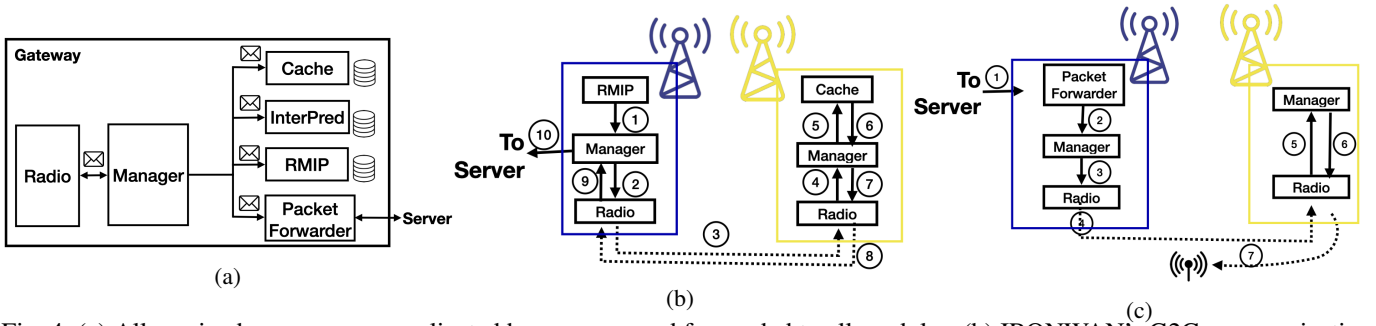

Fig. 4: (a) All received messages are replicated by manager and forwarded to all modules, (b) IRONWAN's G2G communication for a gateway to request a lost uplink message from a neighbour gateway. (c) IRONWAN's G2G communication for a gateway with no remaining downlink duty-cycle to request that a neighbour gateway send a downlink message.

nents, how they interact, and the communication protocol. In the next two sections, we will dive deeper into the design and evaluation of RMIP and InterPred modules, which are solutions for the objectives described in Subsec.III-C.

IV. ESTIMATING MESSAGE ARRIVAL WITH RMIP

In this section we describe how the RMIP module estimates the message inter-arrival time for every node. RMIP uses techniques from streaming and statistical methods. The computation and memory overhead of RMIP are both $O(n)$, where n is a buffer size that determines how fast RMIP responds to changes in inter-arrival times. A gateway only needs $(n + 1) * 4$ bytes (assuming 32-bit floats) per node and can predict message arrivals from hundreds if not thousands of nodes using low memory and computation.

A. Problem Statement

Assume a gateway with a set of nodes in its reception range. The nodes transmit messages periodically with an inter-arrival time Δt . We show in Fig.5(a), when every uplink message successfully arrives at a gateway on the first try (i.e. no retransmissions), the messages arrival time can be seen as a time series $\langle t_1, t_2, \dots, t_l \rangle$, where $\{1, 2, \dots, l\}$ are monotonically increasing message IDs. In Fig.5(b) we see that for messages that require acknowledgements nodes will try to retransmit the message when a message delivery fails before the next message is generated. For messages that do not need acknowledgements, this message is lost. The actual arrival time at the gateway, shown in Fig.5(c), becomes $\langle t_1 + d_1, t_2 + d_2, \dots, t_m + d_m \rangle$, where $\{d_1, d_2, \dots, d_l\}$ are random numbers in range $[0, \Delta t)$ denoting the delays incurred because of these retransmissions. As messages may be missing and these delays are unknown to the gateway, message delivery intervals may vary and become $\langle \Delta t'_1, \Delta t'_2, \dots, \Delta t'_m \rangle$.

Our objective is, given the *observed* message inter-arrival times $\langle \Delta t'_1, \Delta t'_2, \dots, \Delta t'_m \rangle$, to predict the *actual* message arrival times $\langle t_1, t_2, \dots, t_l \rangle$ at the gateway. We further break down the problem into three sub-problems listed below:

- **Inter-arrival time prediction:** The first task is to predict the actual inter-arrival time Δt given $\langle \Delta t'_1, \Delta t'_2, \dots, \Delta t'_m \rangle$.
- **Reference-anchor prediction:** The second task is to find a reference point from where this inter-arrival time is valid. To predict $\langle t_1, t_2, \dots, t_l \rangle$ from inter-arrival time Δt , we find

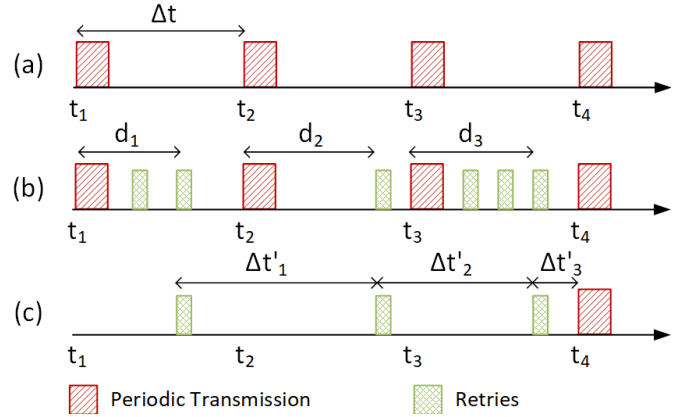

Fig. 5: Examples of: (a) uplink messages sent and received by a node and the gateway, respectively, without retries. (b) uplink messages sent by a node with retries. (c) uplink messages received at the gateway with retries.

a reference time point t_0 where a message arrives with *zero* retries.

- **Change detection in inter-arrival time:** The inter-arrival time Δt may change overtime. Our predictions based on previous observations may be skewed if the gateway is not aware of these changes. Consequently, a gateway needs to detect changes and adapt accordingly given $\langle \Delta t'_1, \Delta t'_2, \dots, \Delta t'_m \rangle$.

It is worth noting that, each LoRaWAN gateway may connect to thousands of LoRaWAN nodes and it is essential to minimise the extra overhead introduced by RMIP.

B. Estimating $\Delta t'$ for Missing Messages

Before starting the prediction algorithm, RMIP first checks if each data point in $\langle \Delta t'_1, \Delta t'_2, \dots, \Delta t'_m \rangle$ is computed from messages with two consecutive IDs (e.g. $\Delta t'_1 = t'_2 - t'_1$). In practice, some messages may go missing and never reach the gateway (delay $d_i > \Delta t$) due to interference. The Inter-arrival time computed from a message stream with lost messages can significantly deviate from the ground truth. For example, when a gateway only receives every alternate message, the inter-arrival estimation can be two times larger than the ground truth. To deal with missing messages RMIP fills in these missing $\Delta t'_i$ using the equation below:

$$\Delta t'_i = \frac{t'_{l+m} - t'_l}{m} \quad \forall l < i < l + m$$

where l and $l + m$ denotes the message ID of the recent and last received messages, and m denotes the number of missing messages.

C. Inter-Arrival Time Prediction

Once the missing inter-arrival times are estimated, the next task is to estimate Δt given $\langle \Delta t'_1, \Delta t'_2, \dots, \Delta t'_l \rangle$. To do so, we have a closer look at the message inter-arrival time observed in real-world scenarios. From example shown in Fig.5, we observe the property:

$$(l - 1)\Delta t < \sum_{i=1}^l \Delta t'_i < (l + 1)\Delta t, \quad (1)$$

where l is the number of messages expected. From Eq.(1), we know that the error term is bounded by $\pm 1/l$ when using the *mean* as our estimator. However, using the mean has several drawbacks. First, this error term is not equal to zero unless the first and last messages both arrive without delay. This is a problem in practical scenarios where delays due to collisions, retransmissions or clock jitter are common. The estimation may deviate from the actual inter-arrival time. Second, the mean value is more sensitive to outliers, and a large delay may significantly skew the estimation. We use the *median* as the estimator, which is more robust against the problems mentioned above.

The median may still deviate from actual intervals when there are no *exact* inter-arrival times in observed samples. We overcome this problem by performing a statistical test on the inter-arrival estimate. Due to the small sample size ($n = 10$ in our implementation), RMIP uses student's t-test[11] to test if we should use the computed median value as Δt . T-test produces a p-value (with regards to its degree of freedom) which we test to see if we can reject the null hypothesis (i.e. median is not valid). We adopt a more restrictive p-value (0.703 representing a 50% two-side quantile when $n = 10$) for our implementation. If the null hypothesis is rejected RMIP accepts this median as the estimated inter-arrival time (Δt), otherwise it continues to collect new inter-arrival time samples while dropping the oldest one until the null hypothesis is rejected.

D. Reference-Anchor Prediction

Our next task is to find the reference time point t_\emptyset with which $\langle t_1, t_2, \dots, t_l \rangle$ can be acquired. RMIP uses a simple but efficient method to predict t_\emptyset using the equation below:

$$t_\emptyset = \begin{cases} t_n & t_n - t_\emptyset < n\Delta t, \\ t_\emptyset & \text{else,} \end{cases} \quad (2)$$

where n is the message counter values from t_\emptyset . As can be seen, it resets t_\emptyset when messages are received before expected arrival time. This is valid because LoRaWAN message counter values are reset only when a new message is generated. This allows t_\emptyset to quickly converge to the *first* transmission for any message of every node.

E. Change Detection in Inter-Arrival Time

RMIP adopts the event trigger technique that is commonly seen in stream processing to minimise memory and computational requirements and detect changes in the inter-arrival time. Instead of updating Δt every time a new message is received, it compares the new inter-arrival time with Δt . If RMIP collects n consecutive inter-arrival times $\langle \Delta t'_1, \Delta t'_2, \dots, \Delta t'_n \rangle$, where their difference with Δt is greater than a given threshold e (i.e. $|\Delta t - \Delta t'_i| > e, \forall i \in \{1, 2, \dots, n\}$), it assumes that a node's transmission interval has changed. RMIP then recomputes the Δt and t_\emptyset , with the algorithms presented in Subsecs.IV-C and IV-D, respectively.

To better understand the impact of n and e on RMIP, we run an experiment on a real-world dataset, LoED[10]. As the ground-truth changes are not available in this dataset, changes were simulated by concatenating inter-arrival timeseries of different nodes (to simulate artificial inter-arrival changes). The results are shown in Fig.6. As can be seen, RMIP captures changes with a very high accuracy. Precision and Recall are more than 96% in all of our experiments. There is no discernible changes in Recall with respect to both n and e . Precision improves with larger n and e ; however, the difference become negligible when $e \geq 1.5$ s. In our experiments, we choose $n = 10$ and $e = 1$ s as default. This is because LoRaWAN devices open two receive windows 0.9-1.1 and 1.9-2.1 seconds for acknowledgements from gateways as presented in Sec.II-A.

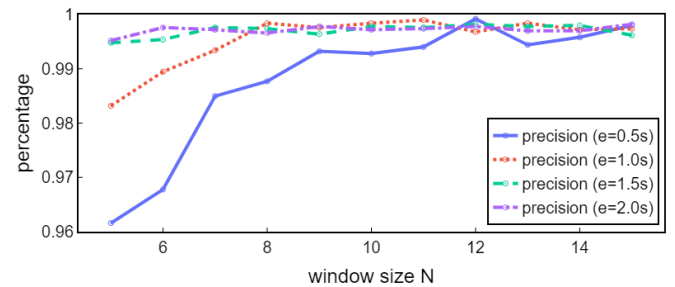

(a) Precision

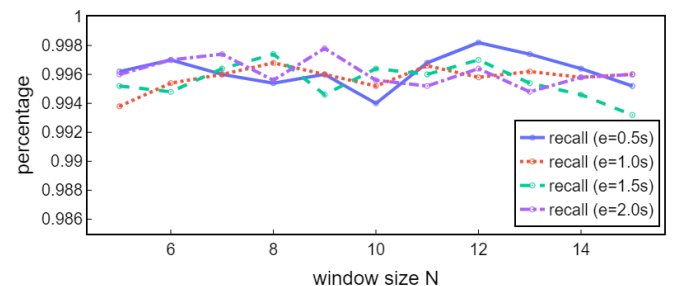

(b) Recall

Fig. 6: The precision and recall of the change detection in RMIP given given different window size n (5-15) and error threshold e (0.5s-2.0s)

V. INTERFERENCE PREDICTION WITH INTERPRED

In this section we describe InterPred. Each gateway using IRONWAN has an InterPred agent, when requested, determining a channel and timeslot for G2G communication that will not interfere with N2G communication.

A. InterPred Overview

InterPred trains an *interference predicting agent* on each gateway by overhearing the network traffic that reflect the communication usage of the neighbouring gateways and nodes. The agent learns an interference model to decide the channel and timeslot for G2G communication that will not interfere with other communication. To formalise LoRaWAN interference prediction as a *reinforcement learning* problem, InterPred introduces novel definitions of state, action, policy, and reward, and uses the value-based reinforcement learning method, State-Action-Reward-State-Action (SARSA)[12], to train the gateway agent. We use SARSA because of its merits in embedded applications (e.g., fast, efficient, and no pre-trained model requirement). It is not trivial to use SARSA for agent training to predict wireless communication. Most wireless communication systems (including but not limited to LoRaWAN) are *half-duplex*, i.e., messages can be either sent or received on a channel but not both simultaneously. A half-duplex system does not have the immediate feedback about its success or failure required by SARSA. To address this issue InterPred trains the agent based on *pseudo actions* (discussed in Sec.V-C).

The workflow of InterPred is illustrated in Fig.7. An InterPred agent on a specific gateway chooses an *action* (i.e., decides the channel and timeslot inducing the minimal interference with N2G communication, and conducts G2G communication correspondingly) given a specific *state* (i.e., the network status defined by spectrum usage information during a past period of time). Since the optimal acting *policy* (i.e., best actions to take in different states) is unknown after the system initialisation, the agent continuously interacts with its *wireless environment*, and iteratively optimises its policy according to the environment *reward* determined by the interference caused by actions taken. We present detailed definitions as follows.

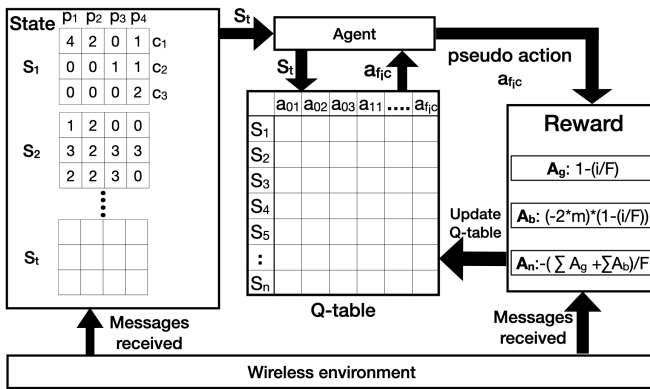

Fig. 7: InterPred overview

B. State, Action, Policy, and Reward

Formally, we assume that IRONWAN operates in discrete timeslots $t \in 1, 2, \dots$ of 0.1 seconds. InterPred stores the communication spectrum usage information of up to P past slots. When a gateway needs to conduct a G2G communication, it uses the information collected in these P slots to choose one slot from future F slots on one of C channels to communicate

with the least possibility of causing interference with other N2G communication. The gateways have no information about interference at other gateways, and they can only make locally optimal decisions.

1) **State.**: At a specific timeslot, we define the current *State* S as a matrix of information about message received on each of C channels in each of past P timeslots (see Fig.7). Each timeslot is labelled as $p_i, i \in \{1, 2, \dots, P\}$, and each channel is labelled as $c_j, j \in \{1, 2, \dots, C\}$. p_1 and p_P represent the oldest and the current timeslots in S , respectively. Each state matrix element $s_{p_i c_j}$ contains information about the number of messages received on c_j at p_i . Whenever the gateway receives a message in p_P on c_j , it extracts information about the airtime of a packet, and calculates the number of timeslots where packet reception was undergoing (k) by dividing airtime with slot length (0.1 seconds). $s_{p_i c_j}$ is then updated as:

$$s_{p_i c_j} = s_{p_i c_j} + 1, \quad i \in [\max(0, P - k), P]. \quad (3)$$

We use this approach as the gateway radio only forwards a message when it has been completely received. The maximum value of $s_{p_i c_j}$ is bounded by 5, which implies that c_j is congested and not suitable for transmission. Such a bound objectively reflects this property of LoRaWAN communication, and it helps to restrict the state space for better tractability.

2) **Action.**: In a specific state S at timeslot p_P , if G2G communication is required, the InterPred agent needs to take an action. We define an *Action* a as the gateway conducting a G2G transmission at a future timeslot $f_i \in \{0, p_P + 1, p_P + 2, \dots, p_P + F\}$ on channel $c_j \in \{c_1, c_2, \dots, c_C\}$. Note that the agent only decides to transmit in one of next F timeslots, and $f_i = 0$ represents the case where no transmission is conducted. Specifically, $a_{f_i c_j}$ denotes transmit at timeslot $f_i = p_P + i$ on channel c_j .

3) **Policy.**: In state S , the InterPred agent needs to choose an action from $((F + 1) * C)$ available candidates to minimise the interference on N2G communication. To achieve this, we use a *Q-value* ($Q_{S,a}$) to denote the impact of taking action a in state S on the N2G communication interference. A higher Q-value represents less interference. The *Policy* of an InterPred agent is a table of the Q-value of each action in each state, or a *Q-table* (see Fig.7). Agents take actions in an ϵ -greedy manner according to the Q-table, i.e., selects the action with the highest Q-value with a probability of $1 - \epsilon$, or a random action with a probability of ϵ . $\epsilon \in [0, 1]$ can be adjusted for a desirable trade-off between exploitation and exploration.

Initially, all elements in the Q-table are assigned with 0 since there is no prior information about each action's impact. Iteratively taking actions according to its latest policy, the InterPred agent updates the Q-table based on the feedback from the wireless environment. Each element $Q_{S,a}$ is updated as follows:

$$Q_{S,a}^{new} = Q_{S,a} + \alpha * (reward + \gamma * Q_{S',a'} - Q_{S,a}). \quad (4)$$

Here, S' denotes the state transferred from S after a is taken, a' denotes the action taken in S' according to the current policy, $\alpha \in [0, 1]$ is the learning rate that controls the stepsize of Q-value update, and $\gamma \in [0, 1]$ is the discount factor that controls the weight of future Q-value. Both α and γ are

empirically tuned to improve the performance of the learnt policy under our experimental settings. *Reward* is a real value quantifying how to adjust the Q-value of each action in a state considering its impact.

4) **Reward.**: Intuitively, if an action causes no interference, we call it *good*, which should impart a positive reward. Similarly, a *bad* action causing interference should impart a negative reward. Moreover, if *no* G2G transmission is conducted, the agent should be punished or rewarded based on whether potential chances are missed or not. Therefore, we have following definitions:

- **Reward of a good action (A_g):** If action $a_{f_i c}$ interferes with no N2G message, its reward is:

$$reward_{a_{f_i c}} = 1 - i/F. \quad (5)$$

This encourages the gateway to carry out G2G communication as soon as possible.

- **Reward of a bad action (A_b):** If action $a_{f_i c}$ interferes with m N2G messages, its reward is:

$$reward_{a_{f_i c}} = -2 * m * (1 - i/F). \quad (6)$$

This introduces a penalty to discourage the gateway from taking bad actions in the current timeslot.

- **Reward of a no-transmission action (A_n):** If action a_{0c} is taken, its reward is:

$$reward_{a_{0c}} = (\sum A_g + \sum A_b)/F. \quad (7)$$

Here, $\sum A_g + \sum A_b$ represents the total reward that would impart by all other actions, implying whether it was a lost of transmission opportunity or a good choice to not transmit.

C. Agent Training based on Pseudo Actions

The real challenge of training the InterPred agent with SARSA is that, LoRaWAN communication is half-duplex. The gateways can only transmit or receive on a channel at any given point, which makes it impossible to get feedback to calculate rewards. To address this issue, we use *pseudo actions* for training. Once deployed on a gateway with the initial policy (i.e., all Q-values are 0), the agent first enters the *training phase*, where it iteratively selects actions in different states according to its policy. However, no G2G communication is actually conducted. In the meantime, the gateway keeps overhearing all communications on all channels, and continuously provides the agent with the wireless spectrum usage information. With this, interference that **would have been caused** by corresponding actual actions can be inferred and used to update the Q-table according to Eq.4.

After trained based on pseudo actions for 3 hours in a 24-hour simulation, the agent is able to start actual predictions. When the gateway needs to transmit a G2G message the agent determines a timeslot and a channel according to its Q-table for G2G transmission. The Q-table is not updated after a real transmission. When there is no G2G transmission request the agent continuously learns based on pseudo actions. There may be no transmission decision that the agent can take that gives it a positive reward. In this case, the agent will take the no-transmission action, and the gateway will not send a

G2G message. This lack of a decision helps InterPred to deal with network conditions of extreme overcrowding to prevent complete resource starvation.

D. InterPred Validation

We implement InterPred and compare it with two naive policies, i.e., *random* and *next-used* to validate the correctness of our method. Three agents with different prediction methods were placed under the same virtual wireless environment (defined by the same set of simulated and real-world datasets). They were evaluated in terms of *fulfilling G2G communication requests* and *preventing N2G interference*. Only the InterPred agent was required for this validation.

1) **Comparatives.**: We selected following two comparatives:

- **Random:** In a state, the agent randomly chooses a timeslot and channel with a uniform probability for G2G communication.
- **Next-Used:** In a state, the agent chooses the next timeslot on a channel where there was no message in the last timeslot of that channel for G2G communication.

The next-used policy requires little storage (the number of messages sent on each channel in the last timeslot). We selected these comparatives to demonstrate how a trivial solutions perform under real-world wireless communication conditions.

2) **Scenarios and Metrics.**: We tested all agents in virtual wireless scenarios defined by three simulated datasets (i.e., low, medium, and high load) and the real-world dataset, LoED[10]. We define load as the proportion of nodes that require acknowledgements for all messages. Traffic amounts of the medium and high load scenarios are 1.5 and 2.5 times as that of the low load scenario and that of real-world dataset are lower than the low load scenario.

In all scenarios the system parameters are set to $P = 4$, $F = 8$, and $C = 3$. P is chosen based on the available memory and the convergence time of a network. Increasing P increases the convergence time that reduces the accuracy of our system. We set $F = 8$ to give enough time to facilitate G2G communications because LoRaWAN nodes open their receive windows after a fixed period LoRaWAN specifications require all devices to operate on at least 3 channels, so we set $C = 3$. For InterPred parameters, we set $\alpha = 0.8$, $\gamma = 0.1$, and $\epsilon = 0.2$ according to empirical studies on all datasets.

The system operate for 24 hours under each scenario. We collected the *numbers of different actions* taken by each agent to quantify its ability to fulfil G2G communication requests, and the *total reward* received by each agent to quantify its ability to prevent N2G interference.

3) **Memory requirements:** InterPred has a low memory footprint so that it can run on low-resource gateways. The memory requirements for InterPred depends upon P , F , C and the maximum number of messages per slot. With our chosen values, the maximum number of bits required to encode the counter value of 5 is 3 and with $P = 4$ and $C = 3$, we only need $P * C * 3 = 36$ bits (rounded to *5bytes*) to encode a single state. Total number of states is $((5^P) * C) = 1875$. Assuming

every action is a 32-float value, the memory needed to encode all actions of a state is $((F + 1) * C) * 4 = 108bytes$. The total memory needed is $1875 * (108 + 5) = 210Kbytes$. The memory requirement can be reduced by using a 16-bit float or reducing number of future states.

4) **Computation requirements:** InterPred has a low computation complexity. For each gateway, $Q_{S,a}^{new}$ is calculated and the Q-table is updated at every time slot. The lookup and computation complexity for SARSA is $O(1)$, and is one of the primary reasons to choose a lightweight solution to run on gateways that have low resources.

5) **Results.:** Our experimental results are illustrated in Fig.8. The results show that InterPred performs similarly to random and next in the LoED dataset. In low-load scenario, the total rewards for InterPred and next are similar, however, next has up to 2x more bad actions compared to InterPred. InterPred also performs better in medium and high load scenarios in terms of lower bad actions and higher total rewards. In scenarios defined by simulated datasets, according to Fig.8(a), the InterPred agent fulfils between 92% and 97% of all G2G communication requests. The ratio of bad actions to all actions is between 7% and 13%. The random agent fulfils 88% of all requests in all scenarios, but its bad action ratio increases from 16% to 30% as the network load increases. The fulfilling ratio of the next-used agent is close to 99% all the time, but its bad action ratio is between 19% to 39%. In Fig.8(b) the total rewards for InterPred and next-used agents are more than 1.9 times of that of the random agent in the low load scenario. However, as the network load increases, the total reward for either the random or the next-used agent goes below 0, implying that they have on average a negative impact on the network. On the other hand, the total reward for the InterPred agent always remains positive.

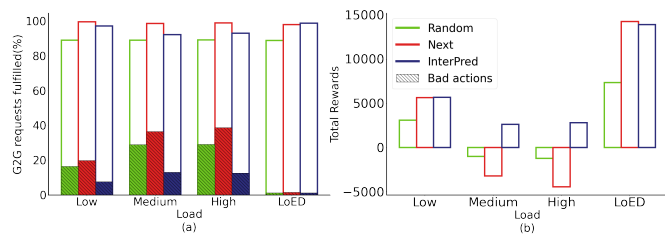

Fig. 8: InterPred validation results

In the LoED dataset scenario the InterPred and next-used agents perform similarly since the system load is lower than that of our low-load simulated scenario. The random agent performs much worse than the other two in terms of the total reward. Its bad action ratio, however, is similar to the others. This shows that the random and next-used agents may work well in low load scenarios, but the InterPred agent performs better than both regardless of the load on the system.

It is clear from the results above that IRONWAN has more communication opportunities and causes less interference when using InterPred over the other policies. InterPred uses a SARSA continuous learning model to train a gateway agent to learn a model of its local communication traffic. A single model would not work on all gateways due to the multitude of wireless interference and placement issues.

InterPred also enables a gateway agent to deal with changes in the environment like new nodes, dynamic inter-arrival times or environmental conditions.

VI. IMPLEMENTATION AND EVALUATION

In this section we describe our evaluation of IRONWAN. We perform four performance studies; initially on a small-scale testbed to demonstrate that it works on gateways without making changes to the LoRaWAN protocol. The next two studies are simulations to evaluate how IRONWAN compares against LoRaWAN in highly-dense environments. The final simulation study compares our work against an full-oracle wired centralised solution (WCS).

Evaluation Criteria. We use three evaluation criteria:

- **Unique messages/node** - The number of unique messages received at the server per node. Each node sends approximately 480 messages per experiment (depending on start time). Each message is identified by a counter number $0, \dots, 479$. A unique message has a unique counter number, and is received only once by the gateway. This is an application level metric and shows how much unique information a server received from a node.
- **Packet Delivery Ratio (PDR in %)** - Packet delivery ratio is defined as number of messages acknowledged over the total number of unique messages sent by the node. This metric captures how many messages that needed acknowledgements were successfully acknowledged.
- **Number of retransmissions (NoReTx)** - The average number of retransmissions needed for messages that require acknowledgements to be acknowledged. Reduction in NoReTx implies that nodes have to retransmit less and conserve their energy.

Evaluation algorithms. We compare IRONWAN with a baseline algorithm LoRaWAN:

- **LoRaWAN:** This is baseline LoRaWAN that represents a typical use-case for LPWANs. Nodes implement Class A specification[1] and use Adaptive Data Rate(ADR). There is no G2G communication in LoRaWAN.
- **IRONWAN:** This inherits all properties of LoRaWAN and implements the G2G communication.

A. Testbed Evaluation

1) **Setup.:** We evaluated IRONWAN with two overlapping LoRaWAN networks, each with 5 nodes and 1 gateway connected to a server. The nodes and gateways were deployed in a 150² metre indoor office environment. The nodes were placed about 4 metres apart from each other and the gateways. We created collisions by having all of the nodes transmit at the same time, on the same frequency, using spreading factor 7, and a transmit power of 14 dBm. We also reduced the duty-cycle on one of the gateways to 0%. The nodes transmitted a message every 20 seconds and we run the experiment for 5 minutes and repeat it 10 times. We report on the average and standard deviation.

Our LoRaWAN nodes consisted of an Adafruit Feather M0 RFM95 LoRa node communicating over USB to a host running Linux. All of the hosts were synchronised with

NTP, and they instructed the LoRaWAN nodes to transmit at the same time to ensure message collisions. We used 2 MultiConnect Conduit Gateway as LoRaWAN gateways each with an 868MHz +3dbi whip antenna.

2) **Results.**: Fig.9 show results of the testbed experiment. The results show that the average unique messages per node increases by 2-6% and the average PDR increases by 15-88%. The results indicate that IRONWAN works on gateways and can improve the total messages received and PDR.

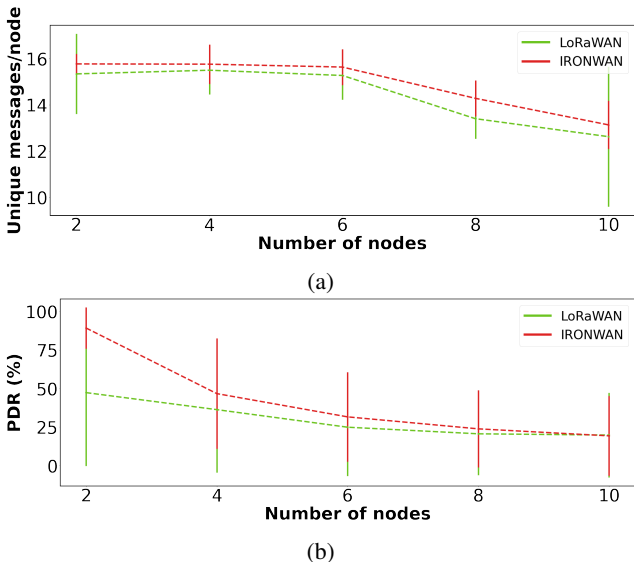

Fig. 9: Testbed evaluation

B. Large-scale Simulation Evaluation

Next, we perform large-scale simulations to study how IRONWAN works in dense urban scenarios.

Setup. We evaluate IRONWAN on the FLORA[13] LoRaWAN simulator using OMNeT++ and the INET framework. We simulate 1000 nodes uniformly deployed in a $4km^2$ simulation area. We base the density of the gateway deployment on an experimental study where an average of 2 – 3 gateways should receive a message for any node with a gateway density of one every $1.5km^2$ [14]. We simulated the use of six, eight, and ten gateways, $G \in 6, 8, 10$, to give an average of 1.5, 2, 2.5 gateways per network. Our simulated networks had G gateways connected to 4 independent networks with their own servers. The nodes transmit a new message every three minutes (maximum of 480 messages). The experiment is run for 24 hours of simulated time. We define the load on the network as the percentage of nodes that require acknowledgements for all of their messages. We evaluate three loads on the network: low, medium and high that correspond to 10,50 and 90% of nodes requiring acknowledgements.

1) **Study 1: Impact of increasing gateways:** In the first study, we compare LoRaWAN and IRONWAN. We increase the number of gateways and the load on the network.

Unique Messages Received and PDR. Fig.10a shows that the total messages received increases with an increase in gateways for both LoRaWAN and IRONWAN. We see IRONWAN receives 12% more messages than LoRaWAN for

a medium load scenario with 6 gateways. For other scenarios, the average total messages received by IRONWAN is from 1-7% better than that for LoRaWAN. We attribute the low throughput gain difference to the LoRaWAN Adaptive Data Rate which reduces the transmission power to reduce the number of nodes heard at multiple gateways. IRONWAN increases the minimum number of messages received from a node in all but the high load with 8 gateways and reduces the 25th percentile (lower line of the box) for all scenarios. IRONWAN reduces the starvation of nodes and the servers have more information from every node.

Fig.10b shows that the average PDR in low-load scenarios is above 99.7% and 99.9% for LoRaWAN and IRONWAN respectively. With a medium-load IRONWAN has 11%,12% and 5% higher PDR for 6,8 and 10 gateways. A similar but smaller PDR performance increase is seen for IRONWAN when the network has a high load. The minimum PDR does not change in low-load scenarios. For medium load IRONWAN has a minimum PDR that is better than the LoRaWAN's minimum PDR by 28% for 6 gateways, 27% for 8 gateways and 20% for 10 gateways. IRONWAN's minimum PDR for a high network load with 10 gateways is 23% higher than that of LoRaWAN. The results show that networks with a medium or high load have a higher PDR with IRONWAN than with LoRaWAN. We see that for networks with a high load and 10 gateways IRONWAN enables gateways to handle more acknowledgements and improve its minimum and average PDR.

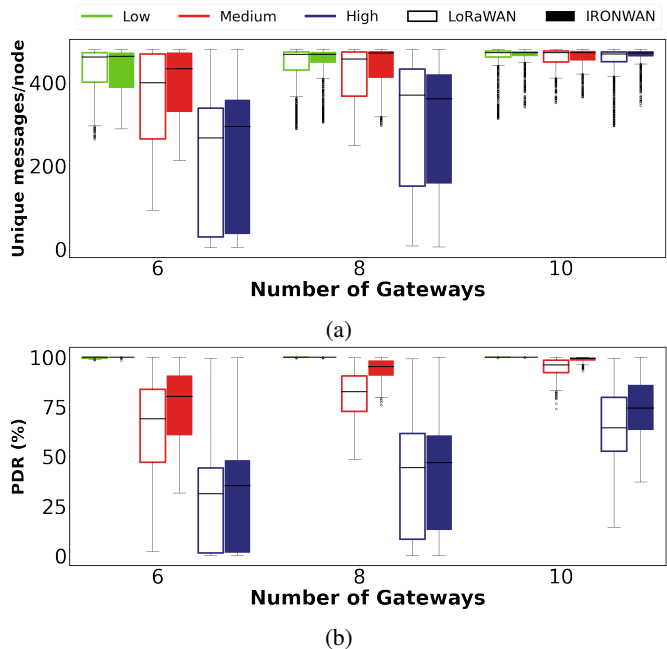

Fig. 10: Evaluation of LoRaWAN and IRONWAN with increasing load and number of gateways

Fig.10a and Fig.10b show that as the load on the network increases, IRONWAN increases the reliability by handling more acknowledgements which reduces the load on the network. We then see the impact of IRONWAN on NoReTx.

Number of retransmissions IRONWAN and LoRaWAN have very similar messages received per node as seen in

Fig.10a. The difference is in the number of retransmissions required to achieve the messages received. Fig.11 shows the NoReTx per node. IRONWAN reduces the NoReTx in low load scenarios by 1%,21% and 32%, for medium load by 8%,29%,39%, and for high load by 2%,5% and 6% when compared to LoRaWAN. This shows that IRONWAN can achieve similar performance to LoRaWAN while consuming lesser energy in low and medium load scenarios.

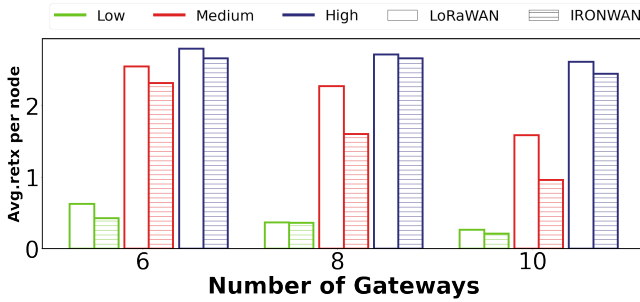

Fig. 11: Average number of retransmissions

Overhead of IRONWAN In Fig.12 we see the additional communication overhead caused by the G2G communication used in IRONWAN when compared to LoRaWAN. IRONWAN’s overhead is the number of messages transmitted on bands 0 and 1 and LoRaWAN’s overhead is only messages transmitted on band 1. IRONWAN’s overhead is 12-14% for low load scenarios, 0-7% in medium load, and 2-5% in high load scenarios. An interesting observation is that when IRONWAN is used in a network with a medium load and 8 gateways it has its highest gain in PDR (Fig.10b) and transmits less messages per node. This occurs because IRONWAN provides a better redistribution of resources and reduces acknowledgements. The results show that overhead of IRONWAN is not high and that it uses spare gateway duty-cycles to the benefit of all networks.

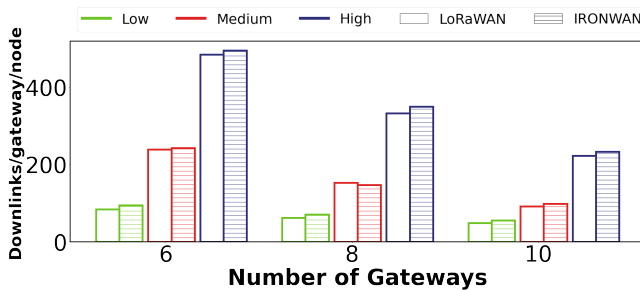

Fig. 12: Overhead for IRONWAN compared to LoRaWAN

2) **Study 2: Impact of increasing number of retransmissions:** In the second study, we test the effect of varying the maximum number of retransmissions on LoRaWAN and IRONWAN. LoRaWAN allows users to choose a policy that limits the maximum number of retransmissions(*retx*). LoRaWAN specifications recommend a retransmission limit of 8 which is what we use in all other experiments. It was shown in [15] that increasing the number of retransmissions increases the probability of lost packets. With this experiment, we study the effects of varying the retransmission limit on the performance of IRONWAN.

Results. Fig.13 shows the unique messages received and PDR for a maximum of 2,4,6 and 8 retransmissions in a network with 10 gateways distributed between 4-servers. The total messages received is similar for all networks loads. This allows us to see how the PDR changes to achieve the same performance. A clear trend emerges where the PDR reduces to 78% for a medium load and 50% for a high load for 2 retransmissions for LoRaWAN. For IRONWAN under the same conditions the PDR only drops to 90% and 63%. Another observation is that IRONWAN with *retx* retransmissions has a 5% to 10% higher PDR than LoRaWAN with *retx* + 2 retransmissions. Instead of increasing *retx*, IRONWAN could be used instead which would reduce the load on the network and the number of messages sent by the nodes by replacing node retransmissions with G2G messages requests. This can also be seen in Fig.13b. In all scenarios, the average PDR of the system increases by up to 20% and the minimum PDR increases in range of 25-160% for medium and high load scenarios. Increasing the retransmissions increases the load on the network and does not significantly increase the PDR. This is evident from the high-load scenario where the average PDR is always higher in IRONWAN compared to cases in which the retransmission limit is increased. This study shows that IRONWAN increases the total messages received and PDR of the system when compared to LoRaWAN with an increasing retransmission limit.

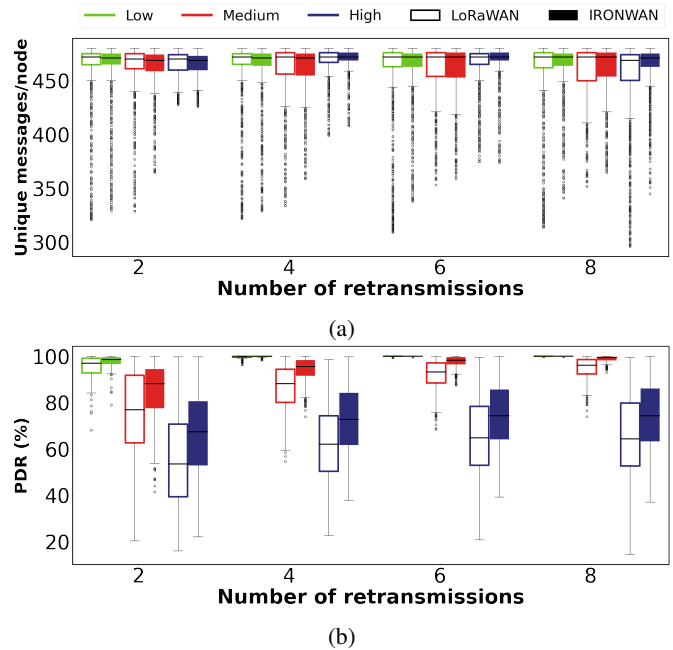

Fig. 13: Varying maximum number of retransmissions

3) **Study 3: Comparison to state-of-art:** In our final study, we compare IRONWAN with two state-of-art systems. As both of the algorithms under comparison have components that tackle different issues, we focus only on the parts of solution that are comparable to IRONWAN. The two solutions are:

1. **Wired centralised server (WCS).** WCS is a centralised system that facilitates message exchange between multiple servers. In WCS every time a server receives a message, it forwards messages not destined for it to all other servers. So,

the servers have information from all gateways that received their message, and they can also use those gateways for acknowledgements. However, they only choose to use those gateways if none of their gateways had received a message. We calculate the overhead of WCS as the number of times it used a message received from another server or used another server for acknowledgements. This is the most significant difference between a network with 1-stakeholder and WCS. The closest thing to WCS is PacketBroker, however, there are no documentations or publications that describe how they work.

2. FLIP. FLIP is a peer-to-peer network between gateways to distribute the load of the network. FLIP does this by minimising Shannon’s entropy and coming to a consensus about what nodes are handled by which gateways. For our comparison, we implement a centralised server that receives all of the messages and assigns nodes to gateways such that the entropy is minimised. We use this technique as it mimics the operation of FLIP which minimises entropy by sharing the load.

Results. Fig.14a and Fig.14b show the results of our comparison. We only show results for medium and high load as all three algorithms perform similarly under the low-load scenario. WCS always has the highest number of unique messages received and PDR as it provides the behaviour of an unpartitioned network. The cost required by WCS to achieve this can be seen in Fig.14c. For a medium load scenario, the total messages received by IRONWAN is as good as FLIP with 6 gateways and outperforms it when 8 and 10 gateways are used. The total messages received by FLIP is higher than that for IRONWAN in the 6 and 8 gateway scenarios. IRONWAN receives more messages than FLIP in the 10 gateway scenario. The PDR for medium load follows a similar trend, where IRONWAN has a higher PDR and much higher minimum PDR when compared to FLIP and is comparable to WCS in the 10 gateway scenario. For a high load scenario, IRONWAN has a lower PDR when compared to FLIP and WCS, however, it increases the maximum PDR from 80% in FLIP and WCS to 100%. IRONWAN’s PDR is higher than FLIP in 10 gateway scenario and closer to WCS’s. Fig.14c shows that the cost of IRONWAN is significantly lower than WCS in all scenarios where cost for IRONWAN is number of messages it requested or responded for other networks.

The results of our evaluation show that IRONWAN increases total messages received by a limited amount while increasing the PDR in most scenarios. It also increases the minimum PDR in all scenarios. IRONWAN also reduces the number of retransmissions in all scenarios with minimal overhead per gateway. IRONWAN does not perform as well as WCS (which is similar to an unpartitioned network) but performs better than FLIP in terms of PDR. Finally, our results show that IRONWAN is a candidate solution for dealing with multi-owner overlapping networks commonly found in LoRaWAN.

VII. LIMITATIONS AND FUTURE WORK

IRONWAN currently has no idea about how many gateways are in its communication range. A neighbourhood discovery

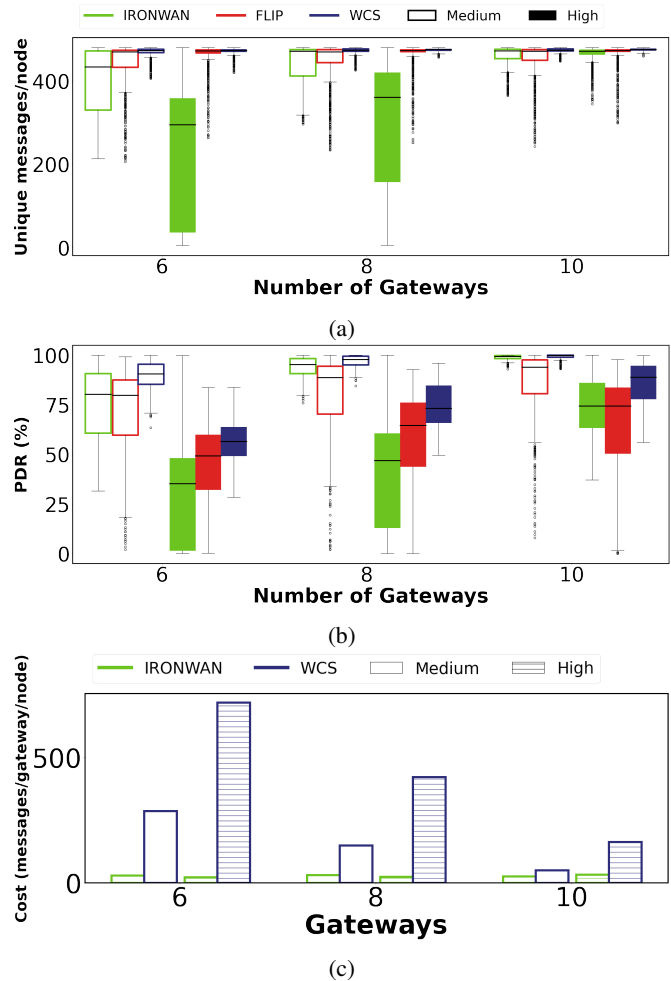

Fig. 14: Comparison of IRONWAN, FLIP and WCS

protocol could help gateways form a map of its neighbouring gateways. This map could then be used to create trust and incentivisation schemes to deal with free-loading or malicious gateways. The G2G messages are not currently encrypted nor authenticated, we leave that for further work. We plan to use neighbour discovery algorithms to create keys for G2G authentication in a way that would not require network owners to coordinate thus retaining the deployment security and simplicity of IRONWAN.

RMIP has been designed for periodic data, it could be extended to deal with event-based data which would allow our system to be used in more scenarios. We have tested InterPred for a limited time and over-time the environment it operates in can change. A real-time parameter tuning and periodic recalibration needs to happen to deal with drastic changes in the wireless environment.

VIII. RELATED WORK

In this section we review current research that tackles aspects of the multi-gateway and multi-owner networks problem in LoRaWAN.

Benefits of multiple gateways: Authors in [16] showed that increasing LoRaWAN gateways from one to four improved the messages that were acknowledged from 24% to 40%. The authors of [5], [17], [6] used multiple gateways to directly

forward all of signals received from all of the nodes in their range to a central server where they are combined and decoded. This is an orthogonal approach to ours as it changes the role that gateways play in a LoRaWAN network by offloading decoding of packets to a server which requires precise time-synchronisation, high bandwidth wired links and most importantly all gateways talking to the same server. To the best of our knowledge, all previous work has assumed that multi-gateway LoRaWAN networks share the same server which is contradictory to LoRaWAN deployment methods where multiple overlapping networks exist. Our work removes this assumption and allows networks to retain their autonomy while still working together to improve performance for all.

Downlink traffic: The authors of [15], [18] examine the effects of downlink traffic in LoRaWAN and demonstrate its inability to handle high amount of downlink traffic. A number of solutions have been proposed [16], [19], [20] to increase the reliability of LoRaWAN by balancing the load, scheduling traffic or controlling access to the channel using queuing systems. All of this assumes a single network using a *single server*. IRONWAN addresses the more realistic scenario of multiple overlapping networks and solves these by enabling communication between the gateways of different networks.

Merging overlapping networks: The most notable work that tackles the problem of overlapping networks is FLIP[4]. FLIP federates gateways of multi-stakeholder overlapping networks. The federated gateways distribute the nodes in overlapping communication regions amongst each other at initialisation. The gateways then handle the communication with the nodes assigned to them as they also hold the encryption keys for that node. The gateways then forward the received messages to the gateway that owns the node which in-turn forwards it to the server. The federated gateways share decryption keys for the allocated nodes which poses a threat in the case of malicious gateways. FLIP assumes a wired internet connection for G2G communication which may not be available, reliable, or secure. In IRONWAN gateways do not require the keys of neighbour nodes. IRONWAN uses the wireless spectrum overcoming the problem of an unreliable wired connection[8] or unavailable backhaul networks in hazardous scenarios. As shown in Sec.VI, IRONWAN performs better than FLIP in most scenarios without having any security issues.

IX. CONCLUSION

In this paper, we present IRONWAN and its novel components RMIP and InterPred. IRONWAN leverages overlapping LoRaWAN networks to enable wireless gateway-to-gateway communication, reducing the negative effects of node-to-gateway message collisions and efficiently sharing gateway-to-node communication capacity. Both RMIP and InterPred are new approaches to solve these problems. We evaluate the effectiveness of IRONWAN in simulation and a testbed experiment. Our results show that IRONWAN outperforms LoRaWAN in low-load and medium-load scenarios (can be considered typical use-cases of LoRaWAN) and achieves comparable performance in the high-load scenario. IRONWAN also improves the messages received per node and the packet

delivery ratio while reducing the number of retransmissions required and enables gateways to acknowledge messages when they have exhausted their communication duty-cycle. Ultimately, IRONWAN is a suitable candidate to leverage overlapping networks to increase the reliability for all participating networks in LoRaWAN deployments.

REFERENCES

- [1] L. Alliance™, “LoRaWAN™ Specification,” lora-alliance.org/sites/default/files/2018-07/lorawan1.0.3.pdf, July 2018.
- [2] K. Mekki, E. Bajic, F. Chaxel, and F. Meyer, “A comparative study of lpwan technologies for large-scale iot deployment,” *ICT express*, 2019.
- [3] E. Aras, N. Small, G. S. Ramachandran, S. Delbruel, W. Joosen, and D. Hughes, “Selective jamming of lorawan using commodity hardware,” *Proceedings of the 14th EAI International Conference on Mobile and Ubiquitous Systems: Computing, Networking and Services*, Nov 2017. [Online]. Available: <http://dx.doi.org/10.1145/3144457.3144478>
- [4] S. Delbruel *et al.*, “Tackling contention through cooperation: A distributed federation in lorawan space,” in *EWSN '20*, 2020.
- [5] A. Dongare *et al.*, “Charm: exploiting geographical diversity through coherent combining in low-power wide-area networks,” in *IPSN' 18*, 2018.
- [6] J. Liu, W. Xu, S. Jha, and W. Hu, “Nephalai: Towards LPWAN C-RAN with physical layer compression,” *arXiv*, 2020.
- [7] The Things Network, “PacketBroker,” <https://www.packetbroker.org>, 2019, [Online; accessed 07-Sep-2020].
- [8] Kathleen McLaughlin, “Gaps in 4G Network Hinder High-tech Agriculture: FCC Prepares to Release 500 Million to Improve Coverage,” 2016.
- [9] M. H. Dwijaksara, W. Sook Jeon, and D. G. Jeong, “Multihop gateway-to-gateway communication protocol for lora networks,” *Proceedings of the IEEE International Conference on Industrial Technology*, vol. 2019-Febru, pp. 949–954, 2019.
- [10] L. Bhatia *et al.*, “Dataset: Loed: The lorawan at the edge dataset,” in *Proceedings of the Third Workshop on Data Acquisition To Analysis*, ser. DATA '20, 2020.
- [11] J. C. De Winter, “Using the student’s t-test with extremely small sample sizes,” *Practical Assessment, Research, and Evaluation*, 2013.
- [12] R. S. Sutton and A. G. Barto, *Reinforcement learning: An introduction*. MIT press, 2018.
- [13] M. Slabicki, G. Premsankar, and M. Di Francesco, “Adaptive configuration of lora networks for dense iot deployments,” in *IEEE/IFIP NOMS*, 2018.
- [14] Olivier Seller, “Predicting LoRaWAN Capacity,” <https://lora-developers.semtech.com/library/tech-papers-and-guides/predicting-lorawan-capacity>, 2020, [Online; accessed 26-Oct-2020].
- [15] M. Capuzzo, D. Magrin, and A. Zanella, “Confirmed traffic in lorawan: Pitfalls and countermeasures,” in *Med-Hoc-Net*, 2018.
- [16] V. Di Vincenzo, M. Heusse, and B. Tourancheau, “Improving downlink scalability in lorawan,” in *IEEE ICC 2019*, 2019.
- [17] X. Xia, Y. Zheng, and T. Gu, “Ftrack: Parallel decoding for lora transmissions,” in *ACM SenSys' 19*, 2019.
- [18] A.-I. Pop, U. Raza, P. Kulkarni, and M. Sooriyabandara, “Does bidirectional traffic do more harm than good in lorawan based lpwa networks?” 2017.
- [19] L. Bhatia *et al.*, “Control communication co-design for wide area cyber-physical systems,” *ACM Trans. Cyber-Phys. Syst.*, 2020.
- [20] Y. Oh *et al.*, “Trilo: A traffic indication-based downlink communication protocol for lorawan,” *Wireless Comm. and Mobile Computing*, 2018.