

RESEARCH ARTICLE

Optimal control of a heroin epidemic mathematical model

P. T. Sowndarrajan^a, L. Shangerganesh^a, A. Debbouche^{b,c} and D. F. M. Torres^c

^aDepartment of Applied Sciences, National Institute of Technology, Goa 403401, India;

^bDepartment of Mathematics, Guelma University, Guelma 24000, Algeria;

^cCenter for Research and Development in Mathematics and Applications (CIDMA),
Department of Mathematics, University of Aveiro, Aveiro 3810-193, Portugal

ARTICLE HISTORY

Submitted 31-Mar-2021; Revised 19-Aug and 10-Oct 2021; Accepted 10-Nov-2021
in *Optimization* (ISSN 0233-1934)

ABSTRACT

A heroin epidemic mathematical model with prevention information and treatment, as control interventions, is analyzed, assuming that an individual's behavioral response depends on the spreading of information about the effects of heroin. Such information creates awareness, which helps individuals to participate in preventive education and self-protective schemes with additional efforts. We prove that the basic reproduction number is the threshold of local stability of a drug-free and endemic equilibrium. Then, we formulate an optimal control problem to minimize the total number of drug users and the cost associated with prevention education measures and treatment. We prove existence of an optimal control and derive its characterization through Pontryagin's maximum principle. The resulting optimality system is solved numerically. We observe that among all possible strategies, the most effective and cost-less is to implement both control policies.

KEYWORDS

Heroin epidemic mathematical model; stability analysis; behavioral change; optimal control

AMS CLASSIFICATION

34D20; 49J15; 92D30

1. Introduction

An opioid drug, made from morphine, is known as heroin. It is a natural substance in the seedpod of the Asian opium poppy plant, used as a recreational drug for its euphoric effects. Heroin is also known as diamorphine, used as a painkiller or in an opioid replacement treatment. It is a white or brown powder, or a black sticky substance known as black tar heroin [1]. The users inject these types of contents into a vein. Heroin can also be smoked, snorted or inhaled. When injected into a vein, the drug has two to three times the effect of a similar dose of morphine. Nowadays, the use of non-medical prescription drugs is becoming a significant threat around the world. It is estimated that about 23% of individuals who take these substances become dependent on it. Further, drug users are suffering severe mental illness, including suicidal, espe-

cially among youth individuals. According to the World Health Organization (WHO), roughly 450,000 people die as a result of drug use [2]. The spread of heroin usage and its addiction follows many of the familiar aspects of an epidemics. The National Survey on Drug Use and Health (NSDUH) [3] estimates that the percentage of heroin users aged twelve or above was particularly high between 2002 and 2008. Among the young adults, it is similar high from 2009 to 2012. Currently, many countries are affected by the heroin drug trade and its growing number of users. Due to high in quality and low in cost, heroin is likely to approach consumer markets over the world with increased consumption and related harmful effects. Drug users who share needles have a higher risk of the proliferation of other diseases, like human immunodeficiency virus (HIV), Hepatitis B and C [4, 5].

A successful anti-drug vaccine produces an immune response to block the target drug from entering the brain and thus avoiding psychoactive or addictive effects. The experimental new vaccine for heroin addiction, developed at the National Institute on Drug Abuse (NIDA) [1], incites the generation of antibodies, which block the effects of heroin. It prevents the drug from crossing the blood-brain barrier and the euphoric effects of heroin, so far tested in mice and rats. Side effects in quitting heroin usage are very severe and, often, constrain heroin addicts to reverse. Available medicines can be given during the detoxification stage to prevent and reduce physical symptoms.

Treatment of drug users is an expensive procedure. It is a long-term process involving various interventions and consistent monitoring to recover successfully. Many countries still fail to provide treatment and other health services, mainly due to lack of fund. It is also a significant burden on the health system of many nations. Several types of researches suggest that drug usage and the associated harm are highest among young people aged 18 to 25 years. Therefore, the rise in awareness among users is needed to make countries healthy. Prevention education, treatment interventions, and alternative development programs, as well as a criminal justice response, prevent an increase in drug habituation and its disorders. Furthermore, it is also important to provide treatment and services to minimize the adverse health effects due to drug use.

Mathematical models are a handy tool to describe and predict how classes of drug users behave. Moreover, treatment strategies can naturally be added to such models as control variables. The resulting control systems can then play a vital role in the understanding of the drug addiction problem. This is our motivation in the present work: to investigate the real-life problem of heroin mathematically, as an epidemic problem, with the aim to reduce the transmission mechanism. As already mentioned, for a better control of the transmission mechanism, it is crucial to consider both prevention education and treatment. Moreover, to treat heroin addiction and disorders related to its usage, it is important the integration of both behavioral and pharmacological medications. Such integrated approach will eventually result in a society free of drug-addiction. With the reduction of the criminal behavior, one expects an increase in the employment rate and a lower risk of other related health diseases. Therefore, prevention and treatment of heroin-addiction is beneficial and efficient for individuals and society.

During last few years, several mathematical models have been developed to describe the heroin epidemic [6, 7]. The literature includes clinical and theoretical studies [7, 8, 9, 10], as well as educational campaigns [11]. In [6, 7], susceptible, untreated, and treated individuals are considered with a standard incidence rate. In [12], Wangari and Stone model the heroin problem based on similar assumptions as used in infectious diseases and consider a saturation function for treating the heroin drug users. In [13], Wang et al. consider a mass action incidence rate and prove the existence of a drug-free

equilibrium and a unique endemic equilibrium, which is stable under some conditions. Huang and Liu study the stability for a heroin epidemic model with distributed delay [14], improving related results previously obtained in [15]. A non-autonomous heroin epidemic model is also analyzed in [8], where it is suggested that the spread of the heroin among users can be controlled by full screening measures. More recently, Wang et al. [16] analyzed mathematically an age-structured heroin epidemic model, which can be used to describe the spread of heroin habituation and addiction in a heterogeneous environment. Even though the above-proposed models study many important features, most of them fail to consider the heroin epidemic model as a control system. Here we propose a heroin epidemic disease model with control variables and study it using optimal control theory.

In [9], the authors formulate a mathematical model for illicit drug use and investigate optimal control strategies for the model. Precisely, they incorporate two control functions: one to reduce the intensity of social influence and the other to increase the rate of detection and rehabilitation of illicit drug users. In [17], a synthetic drug transmission model is proposed and an optimal control problem is formulated. They show that a proper optimal policy can minimize the cost burden as well as the number of addicted individuals. In [18], the authors incorporate control interventions as education campaigns and treatment to minimize the impact of HIV. In [19], an epidemic model with the effect of information about the vaccine and treatment, as control interventions, is considered. Optimal control of a SIR model with education or information, that causes a change in the behavior response, is proposed in [20]. The dynamics of illicit drug use and its optimal control analysis is investigated in [9]. In [21], a mathematical model with prescription drug addiction and treatment is proposed to control the opioid epidemic. An optimal control problem and a cost-effectiveness analysis for the transmission of the Zika virus is analyzed in [22], with four types of preventive measures as control variables. In [23, 24], Ebola models with a preventive control in the form of education campaigns are investigated. Very recently, an age-structured heroin epidemic model is formulated with partial differential equations, under the assumption that susceptibility and recovery are age-dependent, keeping in view some control measures for heroin addiction and using optimal control for simulations, which show the effect on the entire population [25, 26].

Motivated by the above mentioned works, we extend here available heroin epidemic models by introducing two new compartments. In particular, we extend the model proposed in [7] by modeling behavioral change, through the spreading of information and preventive education, and treatments. The novelty of the model consists to express the risk factors of drugs through information, as a behavioral response to susceptible individuals. As a consequence, in our model the susceptible have an active role in preventive education and provide a self-protective effect. Furthermore, failure in participating in preventive programs move individuals back to the susceptible population.

The paper is organized as follows. In Section 2, we formulate a new mathematical model for the heroin epidemic with a behavioral response. Furthermore, the drug free equilibrium is computed and the basic reproduction number R_0 obtained. Section 3 deals with the stability analysis of the equilibrium points (we prove that the heroin free equilibrium is locally asymptotically stable when the basic reproduction number is less than one, cf. Theorem 3.1, and, under a suitable condition, is globally asymptotically stable, cf. Theorem 3.2; and we obtain conditions under which the endemic equilibrium of the system is locally asymptotically stable, cf. Theorem 3.3) and we perform a sensitivity analysis of the epidemiological model. Then, in Section 4, we formulate an optimal control problem and do its analysis: we prove existence of an optimal control

pair that minimizes the proposed cost functional, in finite time, cf. Theorem 4.1; and we characterize it using Pontryagin’s Maximum Principle, cf. Theorem 4.2. Numerical simulations are given in Section 5. We end with some concluding remarks in Section 6. We claim that the model here proposed and analyzed can also be useful to combat other drug epidemics such as cocaine.

2. Mathematical model

In this section, we propose and analyze a mathematical model for the heroin epidemics. A schematic diagram for the proposed model is shown in Figure 1. The parameter Λ

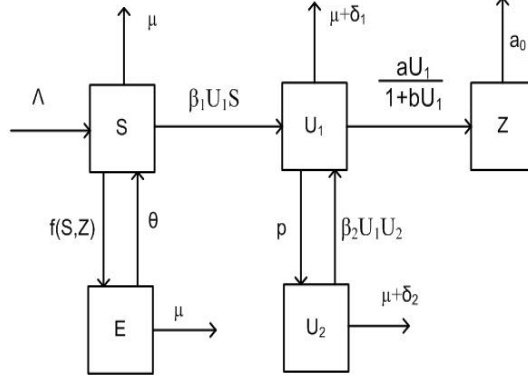

Figure 1.: Schematic diagram of the proposed heroin epidemic model.

represents the constant recruitment rate of susceptible individuals, S . The natural death rate of all individuals is assumed to be μ . The parameter β_1 represents the probability of becoming a drug user, U_1 , and β_2 denotes the rate of drug users in treatment, U_2 , relapsing to untreated. The rate at which drug users enter into treatment is p . Later, we will incorporate a “case holding” control mechanism in the model by replacing the parameter p with $u_2(t)$, which will act as a control variable. The individuals in preventive education, E , are in a state of self-protection, and stop to participate in preventive education, moving back to the susceptible class, at a rate θ . Parameters δ_1 and δ_2 denote induced death rates caused by heroin, respectively for drug users without and with treatment. Information regarding heroin mainly spreads through various media such as TV, newspapers etc., as well as active social and educational campaigns from the government. This information density is proportional to the population density of drug users under no treatment and will change as population U_1 changes. Let $Z(t)$ denote the density of information spreading in the population at time t , such that the information density $Z(t)$ vanishes when $U_1(t) = 0$. This information increases the awareness in the behavioral change of insusceptible individuals to protect themselves from consuming heroin. Even though the people are informed, everyone does not respond to it equally. So, only a fraction of susceptible population with information is responding to the harmful effects of consuming heroin and changing their behavior, moving to class E . The rate of behavioral response via information interaction will be a function of both the densities of susceptible individuals and information, that is, $f(S, Z)$. Also, the growth of information is a function of U_1 , that is, $g(U_1)$, as the growth of information depends only on the density of untreated heroin consumers. The rate of behavioral response of susceptible individuals, caused

by the information about the harmful and risk factors of heroin, is here assumed as $f(S, Z) = u_1\rho SZ$ [19], where $u_1\rho$ is the corresponding response rate and the parameter ρ is the rate of information interaction by which individuals change their behavior. Later, we will consider u_1 , the response intensity through information, as a control variable $u_1(t)$. The growth rate of information $g(U_1)$ is assumed as a saturated functional of the form $g(U_1) = \frac{aU_1}{1+bU_1}$, where a is the growth rate of information and b the saturation constant. We denote by a_0 the natural degradation rate of information, which happens with time due to natural fading of memory about information as well as complacent behavior. Furthermore, we consider the following assumptions in our model: drug users who are not in treatment may contact with susceptible and users in treatment in an undesirable way, transmitting to them the habit of consuming heroin; drug users who are in treatment does not transmit the habit of consuming heroin to susceptible; finally, those who are in treatment may return back to no-treatment due to contact with U_1 individuals. Thus, the proposed system of nonlinear ordinary differential equations is as follows:

$$\begin{cases} \frac{dU_1(t)}{dt} = \beta_1 S(t)U_1(t) - pU_1(t) + \beta_2 U_1(t)U_2(t) - (\mu + \delta_1)U_1(t), \\ \frac{dU_2(t)}{dt} = pU_1(t) - \beta_2 U_1(t)U_2(t) - (\mu + \delta_2)U_2(t), \\ \frac{dS(t)}{dt} = \Lambda - \beta_1 S(t)U_1(t) - \mu S(t) + \theta E(t) - f(S(t), Z(t)), \\ \frac{dE(t)}{dt} = f(S(t), Z(t)) - (\mu + \theta)E(t), \\ \frac{dZ(t)}{dt} = g(U_1(t)) - a_0 Z(t), \end{cases} \quad (1)$$

with non-negative initial conditions $U_1(0)$, $U_2(0)$, $S(0)$, $E(0)$ and $Z(0)$. The total population, denoted by $N(t)$, is partitioned into the four sub-classes of susceptible $S(t)$, drug users not in treatment $U_1(t)$, drug users in treatment $U_2(t)$, and educated $E(t)$: $N(t) := U_1(t) + U_2(t) + S(t) + E(t)$.

Let us consider the biological feasible region by

$$D = \left\{ (S, U_1, U_2, E, Z) \in \mathbb{R}_+^5 : 0 \leq N(t) \leq \frac{\Lambda}{\mu}, 0 < Z(t) \leq \frac{a\Lambda}{a_0\mu} \right\}.$$

Next, we establish the positive invariance of the feasible region D . It is trivial to show that $(S, U_1, U_2, E, Z) > 0$ is positive for all time. Thus,

$$\frac{dN}{dt} = \Lambda - \mu N - \delta_1 U_1 - \delta_2 U_2 \leq \Lambda - \mu N.$$

Then, a standard comparison theorem (see, e.g., [27]) can be used to show that

$$N(t) \leq \left(N(0) - \frac{\Lambda}{\mu} \right) e^{-\mu t} + \frac{\Lambda}{\mu} \leq \frac{\Lambda}{\mu}$$

for all $t \geq 0$. Moreover, we have

$$\frac{dZ}{dt} \leq aU_1 - a_0 Z \leq \frac{a\Lambda}{\mu} - a_0 Z.$$

It follows that

$$Z(t) \leq \left(Z(0) - \frac{a\Lambda}{a_0\mu} \right) e^{-a_0t} + \frac{a\Lambda}{a_0\mu} \leq \frac{a\Lambda}{a_0\mu}$$

for all $t \geq 0$ and system (1) is epidemiologically and mathematically well-posed.

2.1. Drug free equilibrium

In order to study the behavior of the heroin model at its equilibrium, we set the right-hand side of all the equations of system (1) to zero. It is easy to understand that $\tilde{U}_1 = \tilde{U}_2 = \tilde{E} = \tilde{Z} = 0$ at the drug free state and, therefore, the drug free equilibrium (DFE) point of our heroin drug model is given as

$$E_0 = \left(\tilde{S}, \tilde{U}_1, \tilde{U}_2, \tilde{E}, \tilde{Z} \right) = \left(\frac{\Lambda}{\mu}, 0, 0, 0, 0 \right). \quad (2)$$

2.2. Basic reproduction number

The basic reproduction number, denoted by R_0 , is a threshold parameter used in epidemiology to measure the transmission potential of an infection. It is defined to be the expected number of secondary cases produced from a typical infected individual when introduced into a susceptible population during its entire period of infection. Here, R_0 represents the total number of people that each single drug user will initiate to drug use during their drug-using career. To obtain the basic reproduction number for model (1), we use the next generation matrix method of [28].

Let $x = (U_1, U_2, S, E, Z)^T$. Then, system (1) can be written as

$$\frac{dx}{dt} = \mathcal{F}(x) - \mathcal{V}(x),$$

where $\mathcal{F}(x) = (\beta_1 S U_1 + \beta_2 U_1 U_2, 0, 0, 0, 0)^T$ is the rate of new additions in the population and

$$\mathcal{V}(x) = \left((\mu + \delta_1 + p)U_1, \beta_2 U_1 U_2 + (\mu + \delta_2)U_2 - pU_1, \beta_1 S U_1 + \mu S + u_1 d S Z - \theta E - \Lambda, \mu E + \theta E - u_1 d S Z, a_0 Z - \frac{a U_1}{1 + b U_1} \right)^T$$

is the rate of transfer of individuals. Thus, the corresponding linearized matrices are given as $D\mathcal{F}(x)(E_0)$ and $D\mathcal{V}(x)(E_0)$, respectively. To obtain the basic reproduction number R_0 , we need to consider only the infected components of $F := D\mathcal{F}(x)(E_0)$ and $V := D\mathcal{V}(x)(E_0)$ [28]. Therefore, we have

$$F = \begin{pmatrix} \frac{\beta_1 \Lambda}{\mu} & 0 & 0 \\ 0 & 0 & 0 \\ 0 & 0 & 0 \end{pmatrix}$$

and

$$V = \begin{pmatrix} Q_1 & 0 & 0 \\ -p & Q_2 & 0 \\ -a & 0 & a_0 \end{pmatrix},$$

where

$$Q_1 = \mu + \delta_1 + p \quad \text{and} \quad Q_2 = \mu + \delta_2. \quad (3)$$

Matrix FV^{-1} is said to be the next generation matrix of system (1). The basic reproduction R_0 is given as the spectral radius of FV^{-1} , and we obtain that

$$R_0 = \frac{\beta_1 \Lambda}{\mu(\mu + \delta_1 + p)}. \quad (4)$$

3. Stability analysis

In this section, we discuss the stability of the equilibrium points of model (1).

Theorem 3.1. *If $R_0 < 1$, then the heroin free equilibrium E_0 is locally asymptotically stable.*

Proof. The Jacobian matrix of the system at E_0 is

$$J(E_0) = \begin{pmatrix} -\mu & -\frac{\beta_1 \Lambda}{\mu} & 0 & \theta & -\frac{u_1 \rho \Lambda}{\mu} \\ 0 & -\frac{\beta_1 \Lambda}{\mu} - p - (\mu + \delta_1) & 0 & 0 & 0 \\ 0 & p & -(\mu + \delta_2) & 0 & 0 \\ 0 & 0 & 0 & -(\mu + \theta) & \frac{u_1 \rho \Lambda}{\mu} \\ 0 & a & 0 & 0 & -a_0 \end{pmatrix}.$$

The eigenvalues of the characteristic equation of $J(E_0)$ are

$$\lambda_1 = -\mu, \quad \lambda_2 = -(\mu + \theta), \quad \lambda_3 = -a_0,$$

together with the solutions of the equation

$$\lambda^2 + \zeta_1 \lambda + \zeta_2 = 0, \quad (5)$$

where $\zeta_1 = 2\mu + p + \delta_1 + \delta_2 + \frac{\beta_1 \Lambda}{\mu}$ and $\zeta_2 = -\frac{\beta_1 \Lambda}{\mu} \left[(\mu + \delta_2) \left(1 - \frac{1}{R_0} \right) \right]$. By the Routh–Hurwitz condition, the characteristic equation (5) has two roots with negative real parts if, and only if, $\zeta_i > 0$, $i = 1, 2$. The result follows from the fact that $R_0 < 1$ implies $\zeta_i > 0$, $i = 1, 2$. \square

Theorem 3.2. *If $\frac{\beta_1 \Lambda}{\mu(\mu + \delta_1)} < 1$, then the heroin free equilibrium E_0 is globally asymptotically stable.*

Proof. We consider the Lyapunov function $L(U_1, U_2) = U_1 + U_2$. The time derivative of L computed along the solutions of system (1) is given by

$$\frac{dL}{dt} = \beta_1 S U_1 - (\mu + \delta_1) U_1 - (\mu + \delta_2) U_2 \leq (\mu + \delta_1) \left[\frac{\beta_1 \Lambda}{\mu(\mu + \delta_1)} - 1 \right] U_1 - (\mu + \delta_2) U_2.$$

When $\frac{\beta_1 \Lambda}{\mu(\mu + \delta_1)} < 1$, we get $\frac{dL}{dt} < 0$. Furthermore, $\frac{dL}{dt} = 0$ if and only if $U_1 = U_2 = 0$. Note that the largest compact invariant set is $\left\{ (\tilde{S}, \tilde{U}_1, \tilde{U}_2, \tilde{E}, \tilde{Z}) \mid \frac{dL}{dt} = 0 \right\}$. Therefore, the drug free equilibrium E_0 is globally asymptotically stable by LaSalle's invariance principle. \square

3.1. Endemic equilibria

The endemic equilibrium point $E_1 = (S^*, U_1^*, U_2^*, E^*, Z^*)$ of system (1) is given by

$$\begin{aligned} S^* &= \frac{\Lambda}{\mu} \frac{1}{R_0} \left[\frac{Q_1(\beta_2 U_1^* + \mu + \delta_2) - \beta_2 p U_1^*}{Q_1(\beta_2 U_1^* + \mu + \delta_2)} \right], \\ U_2^* &= \frac{p U_1^*}{\beta_2 U_1^* + \mu + \delta_2}, \\ E^* &= \frac{u_1 \rho S^* a U_1^*}{a_0(1 + b U_1^*)(\mu + \theta)}, \\ Z^* &= \frac{a U_1^*}{a_0(1 + b U_1^*)}, \end{aligned}$$

with U_1^* the positive solution of equation $A_1 U_1^3 + A_2 U_1^2 + A_3 U_1 + A_4 = 0$, where

$$\begin{aligned} A_1 &= Q_1 \beta_2 a_0 b (\mu + \theta) (\mu + \delta_1), \\ A_2 &= -a_0 (\mu + \theta) b Q_1 \beta_2 \Lambda \left(1 - \frac{1}{R_0} \right) + Q_1 \beta_2 a_0 (\mu + \theta) (\mu + \delta_1) + Q_1^2 Q_2 a_0 b (\mu + \theta) \\ &\quad - \frac{\Lambda}{R_0} \beta_2 p a_0 b (\mu + \theta) + \frac{\Lambda}{R_0} \beta_2 u_1 \rho a (\mu + \delta_1), \\ A_3 &= -a_0 (\mu + \theta) Q_1 \beta_2 \Lambda \left(1 - \frac{1}{R_0} \right) - a_0 b (\mu + \theta) Q_1 Q_2 \Lambda \left(1 - \frac{1}{R_0} \right) + Q_1^2 Q_2 a_0 (\mu + \theta) \\ &\quad - \frac{\Lambda}{R_0} \beta_2 p a_0 (\mu + \theta) + \frac{\Lambda}{R_0} Q_1 Q_2 u_1 \rho a, \\ A_4 &= -a_0 (\mu + \theta) Q_1 Q_2 \Lambda \left(1 - \frac{1}{R_0} \right) \end{aligned}$$

and Q_1 and Q_2 are given as in (3). For all possible values of the parameters, one has always $A_1 > 0$. If $R_0 > 1$, then $A_4 < 0$. Now, using Descartes' rule of signs, we obtain:

- (i) if $A_2 > 0$ and $A_3 > 0$, then there exists exactly one positive root,
- (ii) if $A_2 > 0$ and $A_3 < 0$, then there exists exactly one positive root,
- (iii) if $A_2 < 0$ and $A_3 > 0$, then there exists three or one positive roots,
- (iv) if $A_2 < 0$ and $A_3 < 0$, then there exists exactly one positive root.

Therefore, U_1^* may have a non-trivial positive value if any one of the above four conditions (i)–(iv) is satisfied.

Theorem 3.3. *The endemic equilibrium $E_1 = (S^*, U_1^*, U_2^*, E^*, Z^*)$ of the system is locally asymptotically stable if $R_0 > 1$ and the following conditions are satisfied:*

$$\begin{aligned} \Theta_i &> 0, \quad i = 2, \dots, 5, \\ \Theta_1 \Theta_2 \Theta_3 &> \Theta_3^2 + \Theta_1^2 \Theta_4, \\ (\Theta_1 \Theta_4 - \Theta_5)(\Theta_1 \Theta_2 \Theta_3 - \Theta_3^2 - \Theta_1^2 \Theta_4) &> \Theta_5(\Theta_1 \Theta_2 - \Theta_3)^2 + \Theta_1 \Theta_5^2, \end{aligned} \quad (6)$$

where

$$\begin{aligned} \Theta_1 &= -a_{11} - a_{22} - a_{33} - a_{44} - a_{55}, \\ \Theta_2 &= a_{11}(a_{44} + a_{33} + a_{22} + a_{55}) - a_{21}a_{12} - a_{14}a_{41} - a_{23}a_{32} + a_{55}a_{22} \\ &\quad + a_{33}(a_{22} + a_{55}) + a_{44}(a_{33} + a_{22} + a_{55}), \\ \Theta_3 &= a_{11}(a_{23}a_{32} - a_{33}a_{44} - a_{44}a_{22} - a_{44}a_{55} - a_{33}a_{22} - a_{33}a_{55} - a_{55}a_{22}) \\ &\quad - a_{21}a_{15}a_{52} - a_{33}a_{44}a_{22} - a_{55}(a_{33}a_{44} + a_{44}a_{22} + a_{33}a_{22}) \\ &\quad + a_{21}(a_{12}a_{33} + a_{12}a_{44} + a_{12}a_{55}) + a_{14}(a_{33}a_{41} + a_{41}a_{22} + a_{41}a_{55}) \\ &\quad + a_{23}a_{32}(a_{44} + a_{55}), \\ \Theta_4 &= a_{11}a_{44}(a_{33}a_{22} - a_{23}a_{32}) - a_{11}a_{55}(a_{23}a_{32} - a_{33}a_{44}) + a_{11}a_{55}a_{22}(a_{44} + a_{33}) \\ &\quad - a_{21}a_{12}(a_{33}a_{44} + a_{33}a_{55} + a_{44}a_{55}) - a_{14}a_{33}a_{41}(a_{22} + a_{55}) - a_{21}a_{14}a_{45}a_{52} \\ &\quad + a_{21}a_{15}a_{52}(a_{33} + a_{44}) + a_{23}a_{32}(a_{14}a_{41} - a_{44}a_{55}) \\ &\quad + a_{55}a_{22}(a_{33}a_{44} - a_{14}a_{41}), \\ \Theta_5 &= a_{11}a_{44}a_{55}(a_{23}a_{32} - a_{33}a_{22}) - a_{14}a_{41}a_{55}(a_{23}a_{32} - a_{33}a_{22}) \\ &\quad - a_{21}(a_{15}a_{33}a_{44}a_{52} - a_{12}a_{33}a_{44}a_{55} - a_{14}a_{45}a_{33}a_{52}), \end{aligned} \quad (7)$$

with

$$\begin{aligned} a_{11} &= -\beta_1 U_1^* - \mu - u_1 \rho Z^*, \quad a_{12} = -\beta_1 S^*, \quad a_{14} = \theta, \quad a_{15} = -u_1 \rho S^*, \\ a_{21} &= \beta_1 U_1^*, \quad a_{22} = \beta_1 S^* + \beta_2 U_2^* - Q_1, \quad a_{23} = \beta_2 U_1^*, \\ a_{32} &= p - \beta_2 U_2^*, \quad a_{33} = -\beta_2 U_1^* - Q_2, \\ a_{41} &= u_1 \rho Z, \quad a_{44} = -(\mu + \theta), \quad a_{45} = u_1 \rho S^*, \\ a_{52} &= \frac{a}{(1 + bU_1^*)^2}, \quad a_{55} = -a_0, \end{aligned} \quad (8)$$

and Q_1 and Q_2 given by (3).

Proof. The Jacobian matrix of the system at E_1 is

$$J(E_1) = \begin{pmatrix} a_{11} & a_{12} & 0 & a_{14} & a_{15} \\ a_{21} & a_{22} & a_{23} & 0 & 0 \\ 0 & a_{32} & a_{33} & 0 & 0 \\ a_{41} & 0 & 0 & a_{44} & a_{45} \\ 0 & a_{52} & 0 & 0 & a_{55} \end{pmatrix},$$

where the a_{ij} 's are given as in (8). The characteristic equation of $J(E_1)$ is given by $\lambda^5 + \Theta_1 \lambda^4 + \Theta_2 \lambda^3 + \Theta_3 \lambda^2 + \Theta_4 \lambda + \Theta_5 = 0$ with the Θ_i 's defined by (7). One has $\Theta_1 > 0$

for all feasible S^* and U_2^* . Therefore, the endemic equilibrium of the system is locally asymptotically stable if, and only if, the Routh–Hurwitz criterion is satisfied, that is, conditions (6) hold. \square

3.2. Sensitivity analysis

A sensitivity analysis of the epidemiological model is performed to determine the relative importance of the model parameters to the infection transmission. Such analysis is important to discover the parameters that have a high impact on R_0 and should be targeted by intervention strategies. The basic reproduction number (4) of system (1) depends on the recruitment rate of susceptible, Λ , on the probability β_1 of becoming a drug user, on the natural death rate μ , on the rate p at which drug users enter into treatment, and on the induced death rate δ_1 caused by heroin. Computing the partial derivatives of R_0 with respect to β_1 and p gives

$$\begin{aligned}\frac{\partial R_0}{\partial \beta_1} &= \frac{\Lambda}{\mu(\mu + \delta_1 + p)} > 0, \\ \frac{\partial R_0}{\partial p} &= -\frac{\beta_1 \Lambda}{\mu(\delta_1 + \mu + p)^2} < 0.\end{aligned}$$

Next, we examine the sensitivity of R_0 with respect to the parameters β_1 and p , by the method of Arriola and Hyman [29]: the normalized forward sensitivity index for each of those parameters. The normalized forward sensitivity index of a variable for a parameter is the ratio of the relative change in the variable to the relative change in the parameter. When the variable is a differentiable function of the parameter, then the sensitivity index may be alternatively defined using partial derivatives. Note that to the most sensitive parameter v it corresponds a normalized forward sensitivity index of one or minus one: $\Theta_v = \pm 1$. If $\Theta_v = +1$, then an increase (decrease) of v by x percent increases (decreases) R_0 by x percent. If $\Theta_v = -1$, then an increase (decrease) of v by x percent decreases (increases) R_0 by x percent [30, 31]. In order to reduce the drug burden, we pay more attention to the highest sensitivity index parameters. Therefore, we compute for parameters β_1 and p as follows:

$$\Theta_{\beta_1} = \left| \frac{\beta_1}{R_0} \frac{\partial R_0}{\partial \beta_1} \right| = 1.$$

It is noted that the basic reproduction number R_0 is most sensitive to changes in β_1 , that is, the probability of becoming a drug user. If β_1 increases, then R_0 will increase. Similarly, if β_1 decreases, then R_0 will decrease. Next,

$$\Theta_p = \left| \frac{p}{R_0} \frac{\partial R_0}{\partial p} \right| < 1.$$

Here, R_0 is less sensitive to changes in p , the rate at which drug users enter into treatment. Further, Θ_p suggests that an increment in p will decrease R_0 and a decrease in p will increase R_0 . As R_0 is more sensitive to changes in β_1 than p , we choose to focus more on β_1 . Furthermore, $\frac{\partial R_0}{\partial p} < 0$ implies that improving the successful treatment rate is a successful remedy from drug addiction and its associated disorders. Finally, this sensitivity analysis tell us that preventing (or) controlling individual's from drug use is more effective than any other strategies.

4. Optimal control model

In this section, we begin by formulating an optimal control problem with vaccination and treatment as control interventions. Then, we prove existence of an optimal control and we characterize it through Pontryagin's Maximum Principle.

4.1. The total cost functional

Our main goal is to decrease the number of drug users and the cost of implementing the two control interventions. Therefore, we consider the following total cost functional J to minimize, as the weighted sum of three components:

$$J[u_1(\cdot), u_2(\cdot)] = \int_0^{t_f} [B_1 U_1 + B_2 u_1^4(t) + B_3 u_2^2(t)] dt \longrightarrow \min \quad (9)$$

subject to the model control system

$$\left\{ \begin{array}{l} \frac{dS}{dt} = \Lambda - \beta_1 S U_1 - \mu S + \theta E - u_1(t) \rho S Z, \\ \frac{dU_1}{dt} = \beta_1 S U_1 - u_2(t) U_1 + \beta_2 U_1 U_2 - (\mu + \delta_1) U_1, \\ \frac{dU_2}{dt} = u_2(t) U_1 - \beta_2 U_1 U_2 - (\mu + \delta_2) U_2, \\ \frac{dE}{dt} = u_1(t) \rho S Z - (\mu + \theta) E, \\ \frac{dZ}{dt} = \frac{a U_1}{1 + b U_1} - a_0 Z, \end{array} \right. \quad (10)$$

with fixed initial conditions

$$S(0) = S_0 > 0, U_1(0) = U_{1,0} > 0, U_2(0) = U_{2,0} > 0, E(0) = E_0 > 0, Z(0) = Z_0 > 0. \quad (11)$$

Here, t_f is the fixed terminal time. The detailed report of the three components in the cost functional (9) is as follows:

- (i) The cost induced by heroin burden itself is $\int_0^{t_f} B_1 U_1(t) dt$, which is proportional to the number of drug users U_1 . It also includes drug-affected driving, creating an impact on the environment, nation's economy, individual's health loss, career loss like education, employment, and productivity, social care, etc. The coefficient B_1 represents the positive weight constant of the heroin drug user.
- (ii) Preventive education to susceptible individuals. Prevention from drug abuse helps the population to live longer, happier and healthier. It also helps in a better growth of nation's economy, making it stronger. Therefore, providing information about the risk factors behind the drug use, its associated disorders and mainly its prevention, like effective participation in preventive education, which includes self-protective schemes, makes a behavioral change among susceptible population. Additional efforts are needed to increase prevention and turn it more effective in controlling the habit of drug use. Mainly, preventive and protective factors should include impulse control, parental monitoring, academic

competence, anti-drug use policies, and secure neighborhood attachment. Here, all the susceptible individuals are made aware of preventive education through spreading of information. In our model, the control variable $u_1(t)$ is the intensity response function through information to maximize the individual behavioral response and keeping cost low. The cost $\int_0^{t_f} B_2 u_1^4(t) dt$ is involved in the process of information spreading, through preventive education and its participation. It may be through campaigns, mass media, social networks, etc. It also represents the cost of spreading information, which includes creating awareness about the high-risk factors of heroin abuse and its causes. Moreover, this gives information about the heroin user's behavior and, mainly, its protective measures. The cost is comparatively higher because of the additional efforts needed to convince individuals of a behavioral change. Hence, we consider the non-linearity of order four $u_1^4(t)$ [19, 32]. It represents the high expenses and efforts to spread the information. Here, the coefficient B_2 represents the positive weight constant associated with the spreading of information.

- (iii) Medical treatment to drug users. The drug addictions and its disorders can be lowered by a certain level by undergoing medical procedures. It involves hospitalization, diagnosis, medication, and other subsequent therapies, like contingency management psychology, motivational incentives, etc. Here, we consider the treatment rate p as the control variable $u_2(t)$, which measures the treatment intensity. The cost $\int_0^{t_f} B_3 u_2^2(t) dt$ is involved in providing treatment. It represents the cost for medical treatment. To treat drug abuse population includes psychological and pharmacological medications. We consider a non-linearity of order two, $u_2^2(t)$, in the cost for treatment [18, 33]. The coefficient B_3 represents the positive weight constant associated with treatment.

Thus, the Lagrangian function L for our optimal control problem is given by

$$L(S, U_1, U_2, E, Z, u_1, u_2) = B_1 U_1 + B_2 u_1^4 + B_3 u_2^2. \quad (12)$$

The control variables $u_1(t)$ and $u_2(t)$ of our optimal control problem involve the following admissible control set:

$$U_{ad} = \{(u_1, u_2) | u_i(t) \text{ is Lebesgue measurable on } [0, t_f] : 0 \leq u_i(t) \leq u_{imax}, i = 1, 2\},$$

where u_{1max} and u_{2max} are fixed positive constants.

4.2. Existence of optimal control

In this subsection, we prove that there exists an optimal control pair u_1^* and u_2^* that minimizes the cost functional J in finite time.

Theorem 4.1. *There exists an optimal control pair u_1^* and u_2^* in U_{ad} such that $J(u_1^*, u_2^*) = \min\{J(u_1, u_2)\}$, solution to the optimal control problem (9)–(11).*

Proof. To prove existence of solution, we need to satisfy the following conditions:

- (1) The admissible set of controls U_{ad} and the state solutions of (10) is nonempty.
- (2) The control set U_{ad} is closed, convex and the state system can be expressed as

a linear function of the control variables with coefficients that depend on time and state variables.

- (3) The integrand L in the cost functional (9) is convex on the control set U_{ad} and $L(S, U_1, U_2, E, Z, u_1, u_2) \geq h(u_1, u_2)$, where $h(u_1, u_2)$ is continuous and $|(u_1, u_2)|^{-1}h(u_1, u_2) \rightarrow \infty$ whenever $|(u_1, u_2)| \rightarrow \infty$, with $|\cdot|$ the $L^2(0, t_f)$ norm.

For each control variables u_1 and u_2 in the set U_{ad} , the solutions of the system (10) are bounded and the right-hand side satisfies the Lipschitz condition with respect to the state variables. Therefore, by applying the Picard–Lindelöf theorem [34], condition (1) holds. By definition, the control set U_{ad} is closed and convex. The model system (10) is linear in the control variables u_1 and u_2 with the coefficients dependent on the state variables. Thus, condition (2) is satisfied. Finally, the integrand L is convex due to the biquadratic nature of u_1 and the quadratic nature of u_2 . We have $L(S, U_1, U_2, E, Z, u_1, u_2) \geq B_2u_1^4 + B_3u_2^2$. Let $c = \min(B_2, B_3) > 0$ and $h(u_1, u_2) = c(u_1^4 + u_2^2)$. Then, condition (3) is also satisfied. Hence, from [35], there exists a control pair u_1^* and u_2^* such that $J(u_1^*, u_2^*) = \min J(u_1, u_2)$. \square

4.3. Characterization of optimal control functions

Now, we derive necessary optimality conditions using Pontryagin’s Maximum Principle (PMP) [36, 37]. In particular, we characterize the optimal control pair u_1^* and u_2^* for problem (9)–(11).

Theorem 4.2. *Let u_1^* and u_2^* be optimal controls of problem (9)–(11) and S^* , U_1^* , U_2^* , E^* , Z^* the corresponding optimal state trajectories satisfying (10)–(11). Then, there exists an adjoint variable $\lambda = (\lambda_1, \lambda_2, \lambda_3, \lambda_4, \lambda_5) \in \mathbb{R}^5$ that satisfies the following equations:*

$$\left\{ \begin{array}{l} \frac{d\lambda_1}{dt} = \lambda_1\beta_1U_1 + \lambda_1\mu + \lambda_1u_1\rho Z - \lambda_2\beta_1U_1 - \lambda_4u_1\rho Z, \\ \frac{d\lambda_2}{dt} = \lambda_1\beta_1S - \lambda_2\beta_1S + \lambda_2u_2 - \lambda_2\beta_2U_2 + \lambda_2\mu + \lambda_2\delta_1 - \lambda_3u_2 \\ \quad + \lambda_3\beta_2U_2 - \lambda_5\frac{a}{(1+bU_1)^2} - B_1, \\ \frac{d\lambda_3}{dt} = -\lambda_2\beta_2U_1 + \lambda_3\beta_2U_1 + \lambda_3\mu + \lambda_3\delta_2, \\ \frac{d\lambda_4}{dt} = \lambda_4\mu + \lambda_4\theta - \lambda_1\theta, \\ \frac{d\lambda_5}{dt} = \lambda_1u_1\rho S - \lambda_4u_1\rho S + \lambda_5a_0, \end{array} \right. \quad (13)$$

with transversality conditions

$$\lambda_i(t_f) = 0, \quad i = 1, \dots, 5. \quad (14)$$

Moreover, the optimal controls u_1^* and u_2^* are given as

$$\begin{aligned} u_1^*(t) &= \min \left\{ \max \left\{ 0, \left(\frac{\rho S^*(t) Z^*(t)}{4B_2} (\lambda_1(t) - \lambda_4(t)) \right)^{\frac{1}{3}} \right\}, u_{1max} \right\}, \\ u_2^*(t) &= \min \left\{ \max \left\{ 0, \frac{(\lambda_2(t) - \lambda_3(t)) U_1(t)}{2B_3} \right\}, u_{2max} \right\}. \end{aligned} \quad (15)$$

Proof. We define the Hamiltonian function as follows:

$$\begin{aligned} H(S, U_1, U_2, E, Z, u_1, u_2, \lambda) &= L(S, U_1, U_2, E, Z, u_1, u_2) \\ &\quad + \lambda_1 (\Lambda - \beta_1 S U_1 - \mu S + \theta E - u_1 \rho S Z) \\ &\quad + \lambda_2 (\beta_1 S U_1 - u_2 U_1 + \beta_2 U_1 U_2 - (\mu + \delta_1) U_1) \\ &\quad + \lambda_3 (u_2 U_1 - \beta_2 U_1 U_2 - (\mu + \delta_2) U_2) \\ &\quad + \lambda_4 (u_1 \rho S Z - (\mu + \theta)) \\ &\quad + \lambda_5 \left(\frac{a U_1}{1 + b U_1} - a_0 Z \right), \end{aligned}$$

where L is the Lagrangian function (12). Let u_1^* and u_2^* be the optimal controls and $S^*, U_1^*, U_2^*, E^*, Z^*$ the corresponding optimal state variables. From PMP, there exist functions $\lambda_1, \dots, \lambda_5$ that satisfy the adjoint equations

$$\frac{d\lambda_1}{dt} = -\frac{\partial H}{\partial S}, \quad \frac{d\lambda_2}{dt} = -\frac{\partial H}{\partial U_1}, \quad \frac{d\lambda_3}{dt} = -\frac{\partial H}{\partial U_2}, \quad \frac{d\lambda_4}{dt} = -\frac{\partial H}{\partial E}, \quad \frac{d\lambda_5}{dt} = -\frac{\partial H}{\partial Z},$$

evaluated at the optimal controls and corresponding state variables, subject to the transversality conditions $\lambda_i(t_f) = 0$, $i = 1, \dots, 5$. Therefore, we obtain the adjoint system (13) and terminal conditions (14). Finally, having in mind that

$$\frac{\partial H}{\partial u_1} = 4B_2 u_1^3 - \lambda_1 \rho Z S + \lambda_4 \rho S Z$$

and

$$\frac{\partial H}{\partial u_2} = 2B_3 u_2 - \lambda_2 U_1 + \lambda_3 U_1,$$

we obtain from the minimality condition of PMP that (15) holds. \square

Concluding, the optimality conditions consist of the state system (10) with given initial conditions (11), the adjoint system (13) with transversality conditions (14), and the optimal control functions (15). In the next Section 5, we solve numerically the

obtained optimality system:

$$\left\{ \begin{array}{l}
\frac{dS(t)}{dt} = \Lambda - \beta_1 S U_1 - \mu S + \theta E - u_1 \rho S Z, \\
\frac{dU_1(t)}{dt} = \beta_1 S U_1 - u_2 U_1 + \beta_2 U_1 U_2 - (\mu + \delta_1) U_1, \\
\frac{dU_2(t)}{dt} = u_2 U_1 - \beta_2 U_1 U_2 - (\mu + \delta_2) U_2, \\
\frac{dV(t)}{dt} = u_1 \rho S Z - (\mu + \theta) E, \\
\frac{dZ(t)}{dt} = \frac{a U_1}{1 + b U_1} - a_0 Z, \\
\frac{d\lambda_1}{dt} = \lambda_1 \beta_1 U_1 + \lambda_1 \mu + \lambda_1 u_1 \rho Z - \lambda_2 \beta_1 U_1 - \lambda_4 u_1 \rho Z, \\
\frac{d\lambda_2}{dt} = \lambda_1 \beta_1 S - \lambda_2 \beta_1 S + \lambda_2 u_2 - \lambda_2 \beta_2 U_2 + \lambda_2 \mu + \lambda_2 \delta_1 - \lambda_3 u_2 \\
\quad + \lambda_3 \beta_2 U_2 - \lambda_5 \frac{a}{(1 + b U_1)^2} - B_1, \\
\frac{d\lambda_3}{dt} = -\lambda_2 \beta_2 U_1 + \lambda_3 \beta_2 U_1 + \lambda_3 \mu + \lambda_3 \delta_2, \\
\frac{d\lambda_4}{dt} = \lambda_4 \mu + \lambda_4 \theta - \lambda_1 \theta, \\
\frac{d\lambda_5}{dt} = \lambda_1 u_1 \rho S - \lambda_4 u_1 \rho S + \lambda_5 a_0, \\
S(0) = S_0, \quad U_1(0) = U_{10}, \quad U_2(0) = U_{20}, \quad E(0) = E_0, \quad Z(0) = Z_0, \\
\lambda_i(t_f) = 0, \quad i = 1, \dots, 5,
\end{array} \right. \quad (16)$$

with

$$\begin{aligned}
u_1 &= \min \left\{ \max \left\{ 0, \left(\frac{\rho S Z}{4 B_2} (\lambda_1 - \lambda_4) \right)^{\frac{1}{3}} \right\}, u_{1max} \right\}, \\
u_2 &= \min \left\{ \max \left\{ 0, \frac{(\lambda_2 - \lambda_3) U_1}{2 B_3} \right\}, u_{2max} \right\}.
\end{aligned} \quad (17)$$

Remark 1. In principle, there is a possibility of having “singular controls”, which may occur along the arcs for which either $\lambda_1(t) - \lambda_4(t)$ or $\lambda_2(t) - \lambda_3(t)$ or both vanish. In our numerical simulations such possibility was not found.

5. Numerical results and discussion

We begin by illustrating our Theorem 3.1 numerically. For that, we consider the parameter values as given in Table 1, for which the basic reproduction (4) is less than one. In agreement with Theorem 3.1, we see in Fig. 2 the stability of the population around the drug free equilibrium (2).

We are, however, more interested to illustrate numerically our analytical findings and the involvement of control variables in the system dynamics in the endemic situation, when $R_0 > 1$, which is more challenging and where control measures are crucial and optimal control theory has an important role. We use a fourth-order Runge–Kutta

Table 1.: Parameter values for which $R_0 < 1$, used to obtain Fig. 2.

Parameter	Value
Λ	2.0
β_1	0.0002
β_2	0.0001
μ	0.125
ρ	0.04
δ_1	0.05
δ_2	0.06
θ	0.001
a	0.01
b	1.0
a_0	0.06

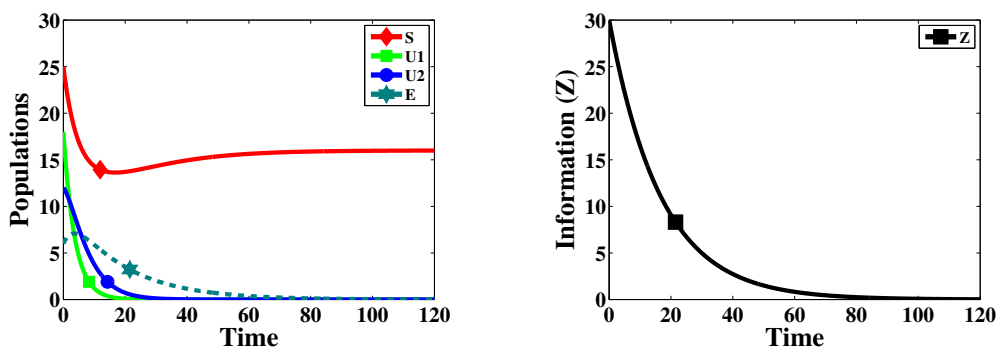

Figure 2.: Stability of the population around the drug-free equilibrium E_0 in agreement with Theorem 3.1.

algorithm to perform the numerical simulation of the optimal system (16) with (17). Choosing the initial conditions for the states and the initial guesses for the controls, the state system (10) is solved forward in time using a fourth-order Runge–Kutta scheme. Using the current iteration solution of the state equation (10) and the transversality conditions (14), the adjoint system (13) is solved backwards in time by the fourth-order Runge–Kutta scheme. We repeat the iteration process by updating the controls using the state and adjoint values. This process will continue until the values of the state, adjoint, and controls converge. The initial values of unknowns we have used are given by $S(0) = 15.0$, $U_1(0) = 5.0$, $U_2(0) = 2.0$, $E(0) = 1.25$ and $Z(0) = 1.0$. Population profiles and control interventions are plotted for a time period of $t_f = 30$ days. We use the set of parameter values as in the Table 2 to determine the numerical simulation of the optimality system with a small time step size $\Delta t = 0.03$. Note that here the positive weights in the objective functional (9) are assumed. In general, the individual’s response to behavioral change for a large population is very challenging, and it is expensive. Therefore, and exactly because information spreading for the community to change their behavior is expensive and a difficult task, we assume the positive weight for the control u_1 to be higher than the control u_2 [18]. We define the following three approaches to examine the efficiency of the control policies introduced:

Table 2.: Values of the parameters used to illustrate the endemic situation and optimal control.

Parameter	Value	Units	Reference
Λ	0.7	persons per day	Assumed
β_1	0.01	per day	Assumed
β_2	0.0008	per day	Assumed
μ	0.07	per day	Assumed
ρ	0.04	per day	Assumed
δ_1	0.05	persons per day	[13]
δ_2	0.06	persons per day	[13]
θ	0.001	per day	[19]
a	0.01	–	[19]
b	1.0	–	[19]
a_0	0.06	–	[19]
B_1	6	–	Assumed
B_2	120	–	Assumed
B_3	30	–	Assumed
u_{1max}	1.0	–	Assumed
u_{2max}	1.0	–	Assumed

- **Case 1** – implementation of the optimal control variable u_1^* only ($u_2 \equiv 0$);
- **Case 2** – implementation of the optimal control variable u_2^* only ($u_1 \equiv 0$);
- **Case 3** – implementation of both optimal control variables u_1^* and u_2^* .

Before studying these three situations under optimal control, we illustrate the endemic situation under investigation in Fig. 3, which shows the population densities of system (1) without controls, that is, where we assume $u_1 \equiv 0$ and $u_2 \equiv 0$ in the control

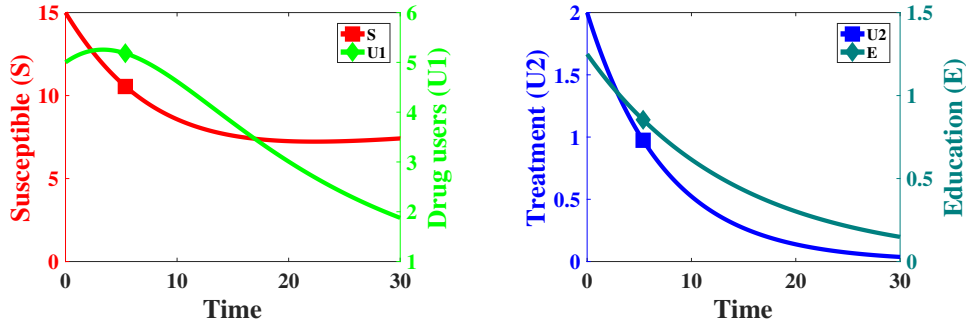

Figure 3.: Population profiles for the endemic situation of Table 2 without controls, i.e., $u_1 = u_2 \equiv 0$.

system (10). We observe from Fig. 3, and in contrast with the situation of Fig. 2, that the number of drug users begins increasing and does not go to zero due to the absence of control variables. Therefore, the increase in heroin users creates an economic burden on the nation, including drug-affected driving and impact on the environment. It also creates opportunity loss, and it is the main burden to individual users with weight loss, mental disorders, etc. So, we aim to minimize the drug addiction burden and also

the cost of the control policies. We induce the two control interventions, (i) preventive education as vaccination for drug abuse, which spreads through the information and makes the behavioral change and (ii) treatment with medications and other therapies.

Case 1: Using the same parameters as in Table 2, the above mentioned positive weights and initial conditions, we solve the system numerically with control u_1 to discuss the effectiveness of the control intervention u_1 . The corresponding evolution in the population densities of the system is shown in Fig. 4. We observe from Fig. 4d, that

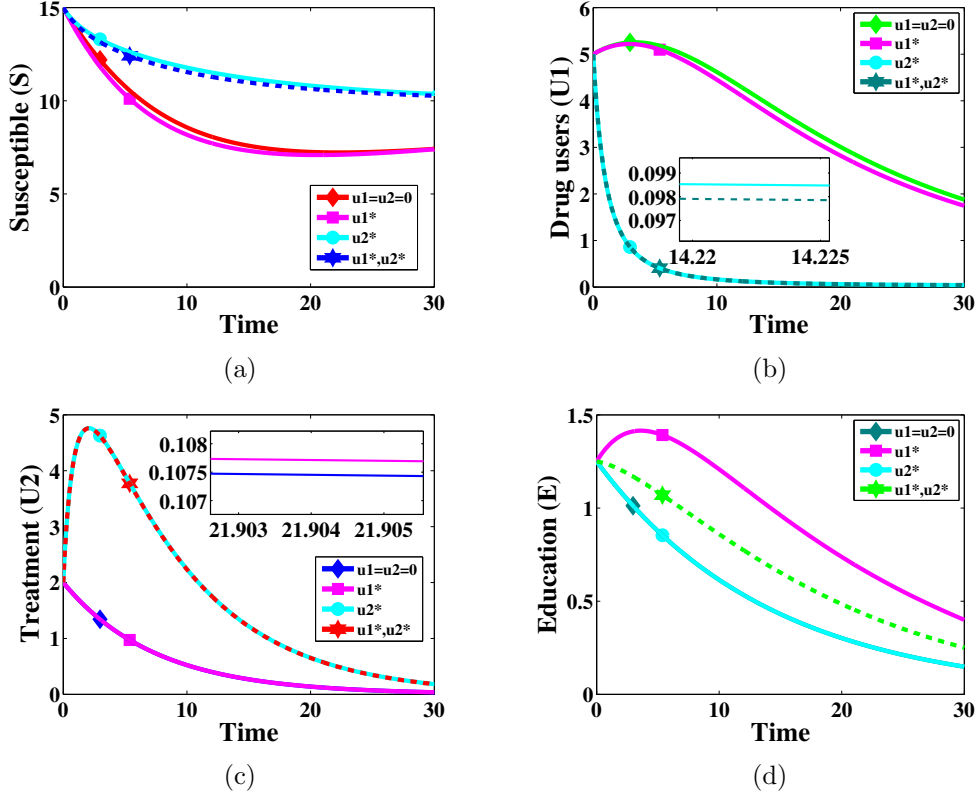

Figure 4.: Population profiles without controls and under optimal control strategies for Cases 1, 2 and 3.

the population of preventive education is gradually increasing with the control u_1 than without control. Moreover, we also observe from Fig. 4a and 4b a moderate decrease in the population of susceptible and drug users. Further, various computational results were carried out with different values of ρ , which are depicted in Fig. 5a. It clearly shows that an increase in the information interaction rate ρ decreases the drug user population. Moreover, the control profile is plotted in Fig. 5b.

Case 2: We are continuing the numerical simulations using the same parameter values as in Case 1 but with control u_2 . Then the evolution of the corresponding population densities of the optimal control system is depicted in Fig. 4. Here we can understand that the number of drug users in treatment is rapidly increasing over the course of time when compared with Case 1, see Fig. 4c. Further, the influence of control u_2 is also there in other population densities of the model, see Figs. 4a and 4b. The corresponding optimal control profile is given in Fig. 6a. It shows that treatment for drug users rapidly decreases in the stipulated time and then goes to zero. We conclude

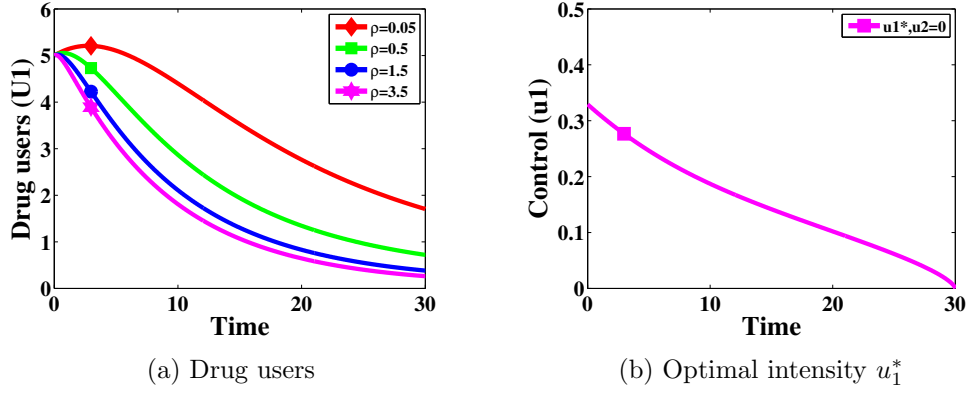

Figure 5.: Drug users and optimal intensity of u_1 in Case 1 for various values of the rate ρ of information interaction.

that medical treatment plays a crucial role to reduce the population of heroin users.

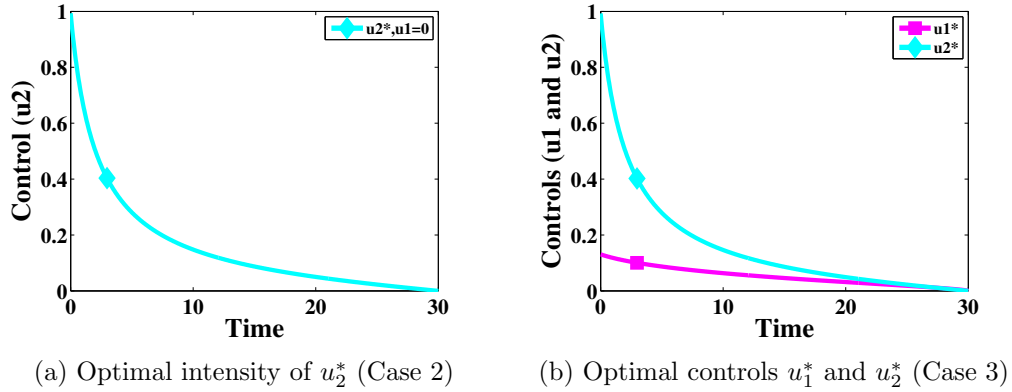

Figure 6.: Optimal control profiles.

Case 3: In this case, we take non-zero control interventions, that is, we compute the solution of the optimal control problem exactly as discussed in Section 4. Further, we continue the simulations with the same parameter values as in the previous two cases. The evolution of the population densities is depicted in Fig. 4. As expected, the influence of both controls is more effective than the other two cases already discussed. The optimal control profile is depicted in Fig. 6b. Fig. 7 shows the information level with optimal policies versus without any control measures. Furthermore, we also perform numerical simulations with different weights for both control interventions u_1 and u_2 . The result given in Fig. 8a shows how the control strategies depend on weight B_2 . It is noted that if the positive weight B_2 increases, then the amount of control policy u_1 decreases. Figure 8b illustrates how the control strategies depend on weight B_3 . The amount of treatment u_2 decreases as the positive weight B_3 increases.

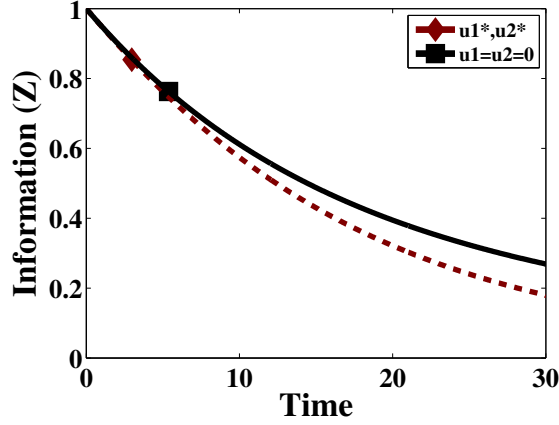
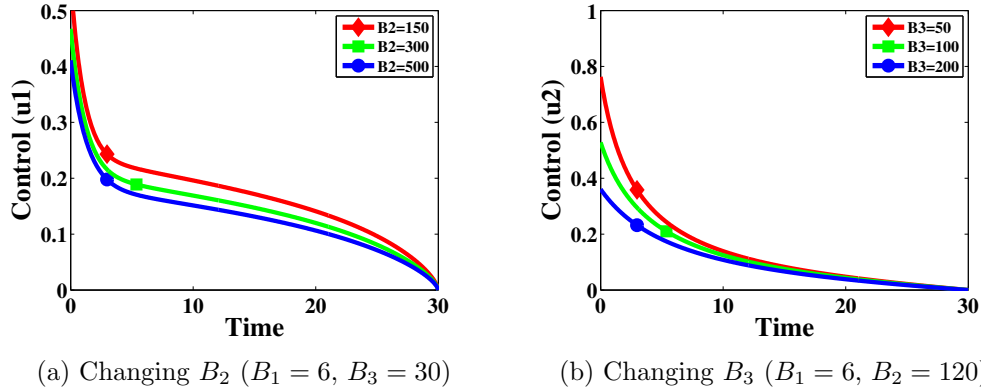

Figure 7.: Information level with u_1^*, u_2^* (15) versus $u_1 = u_2 = 0$.



(a) Changing B_2 ($B_1 = 6, B_3 = 30$)

(b) Changing B_3 ($B_1 = 6, B_2 = 120$)

Figure 8.: Optimal controls u_1^*, u_2^* (15) with different weights in cost functional (9).

6. Conclusion

We examined an optimal control problem for a heroin epidemic model. Information regarding prevention education and drug treatments were considered as control interventions. Both controls have their advantage and efficiency in implementation. Stability theory was used to analyze the mathematical model qualitatively. The system has two equilibrium points: a drug-free equilibrium, which always exists, and an endemic equilibrium, which exists when the basic reproduction number is greater than one. We analytically found controls in terms of state and costate variables and then numerically solved the boundary value problem for the resulting system of ordinary differential equations, finding the optimal paths. Further, various control strategies were studied numerically for the proposed control problem. Finally, we concluded that prevention programs and treatment not only decrease the cost burden but also minimize the number of drug abuse cases. As a future direction of research, one can investigate the proposed heroin model by introducing stochastic effects on the unknowns [38]. Further, application of several types of delays [39] and multiobjective optimization [40] are also pointed out as interesting directions for future research.

Acknowledgments

The authors are grateful to two anonymous reviewers for several constructive comments that really helped to improve the manuscript.

Funding

Sowndarrajan is thankful to the Ministry of Human Resources Development (MHRD) and National Institute of Technology Goa, India, for awarding him a Senior Research Fellowship. Debbouche and Torres are grateful to the Portuguese Foundation for Science and Technology (FCT), project UIDB/04106/2020 (CIDMA).

References

- [1] NIDA InfoFacts: Heroin. <http://www.nida.nih.gov/infofacts/heroin.html>
- [2] UNODC, World Drug Report (2018). <https://www.unodc.org/wdr2018>
- [3] Lipari, R.N., Hughes, A.: Trends in heroin use in the United States: 2002 to 2013, (2015)
- [4] Li, X., Zhou, Y., Stanton, B.: Illicit drug initiation among institutionalized drug users in China, *Addiction*, **97**, 575–582 (2002)
- [5] Garten, R.J., Lai, S., Zhang, J., Liu, W., Chen, J., Vlahov, D., Yu, X.F.: Rapid transmission of hepatitis C virus among young injecting heroin users in Southern China, *Int. J. Epidemiol.* **33**, 182–188 (2004)
- [6] Mulone, G., Straughan, B.: A note on heroin epidemics, *Math. Biosci.* **218**, 138–141 (2009)
- [7] White, E., Comiskey, C.: Heroin epidemics, treatment and ODE modelling, *Math. Biosci.* **208**, 312–324 (2007)
- [8] Samanta, G.P.: Dynamic behaviour for a nonautonomous heroin epidemic model with time delay, *J. Appl. Math. Comput.* **35**, 161–178 (2011)
- [9] Mushayabasa, S., Tapedzesa, G.: Modeling illicit drug use dynamics and its optimal control analysis, *Comput. Math. Methods Med.* **2015**, Art. ID 383154, 11 pp (2015)
- [10] Mushayabasa, S., Bhunu, C.P.: Epidemiological consequences of non-compliance to HCV therapy among intravenous drug users, *International Journal of Research and Reviews in Applied Sciences* **8**, 288–295 (2011)
- [11] United Nations Office on Drugs and Crime (UNODC), World Drug Report (2014)
- [12] Wangari, I.M., Stone, L.: Analysis of a heroin epidemic model with saturated treatment function, *J. Appl. Math.*, **2017**, Art. ID 1953036, 21 pp (2017)
- [13] Wang, X., Yang, J., Li, X.: Dynamics of a heroin epidemic model with very population, *Applied Mathematics* **2**, 732–738 (2011)
- [14] Huang, G., Liu, A.: A note on global stability for a heroin epidemic model with distributed delay, *Appl. Math. Lett.* **26**, 687–691 (2013)
- [15] Liu, J., Zhang, T.: Global behaviour of a heroin epidemic model with distributed delays, *Appl. Math. Lett.* **24**, 1685–1692 (2011)
- [16] Wang, J., Wang, J., Kuniya, T.: Analysis of an age-structured multi-group heroin epidemic model, *Appl. Math. Comput.* **347**, 78–100 (2019)
- [17] Saha, S., Samanta, G.P.: Synthetic drugs transmission: stability analysis and optimal control, *Lett. Biomath.* 1–31 (2019)

- [18] Kassa, S., Ouhinou, A.: The impact of self-protective measures in the optimal interventions for controlling infectious diseases of human population, *J. Math. Biol.* **70**, 213–236 (2015)
- [19] Saha, S., Samanta, G.P.: Modelling and optimal control of HIV/AIDS prevention through PrEP and limited treatment, *Physica A.* **516**, 280–307 (2019)
- [20] Joshi, H., Lenhart, S., Hota, S., Agosto, F.: Optimal control of an SIR model with changing behavior through an education campaign, *Electron. J. Differential Equations.* **50**, 1–14 (2015)
- [21] Battista, N.A., Percy, L.B., Strickland, W.C.: Modeling the opioid epidemic, *Bull. Math. Biol.* **81**, 2258–2289 (2019)
- [22] Momoh, A.A., Fugenschuh, A.: Optimal control of intervention strategies and cost effectiveness analysis for a Zika virus model, *Operations Research for Health Care.* **18**, 99–111 (2018)
- [23] Bonyah, E., Badu, K., Asiedu-Addo, S.K.: Optimal control application to an Ebola model, *Asian Pac. J. Trop. Biomed.* **6**, 283–289 (2016)
- [24] Area, I., Ndairou, F., Nieto, J.J., Silva, C.J., Torres, D.F.M.: Ebola model and optimal control with vaccination constraints, *J. Ind. Manag. Optim.* **14**, 427–446 (2018) [arXiv:1703.01368](https://arxiv.org/abs/1703.01368)
- [25] Khan, A., Zaman, G., Ullah, R., Naveed, N.: Optimal control strategies for a heroin epidemic model with age-dependent susceptibility and recovery-age, *AIMS Math.* **6**, no. 2, 1377–1394 (2021)
- [26] Khan, A., Zaman, G., Ullah, R., Naveed, N.: Correction: Optimal control strategies for a heroin epidemic model with age-dependent susceptibility and recovery-age, *AIMS Math.* **6**, no. 7, 7318–7319 (2021)
- [27] Lakshmikantham, V., Leela, S., Martynuk, A.A.: *Stability Analysis of Nonlinear Systems*, Marcel Dekker, Inc., New York, Basel (1989)
- [28] van den Driessche, P., Watmough, J.: Reproduction numbers and sub-threshold endemic equilibria for compartmental models of disease transmission, *Math. Biosci.* **180**, 29–48 (2002)
- [29] Arriola, L., Hyman, J.: *Lecture notes, forward and adjoint sensitivity analysis: with applications in Dynamical Systems*, Linear Algebra Optim. Math. Theor. Biol. Inst., **2005**
- [30] Rosa, S., Torres, D.F.M.: Optimal control and sensitivity analysis of a fractional order TB model, *Stat. Optim. Inf. Comput.* **7**, 617–625 (2019). [arXiv:1812.04507](https://arxiv.org/abs/1812.04507)
- [31] Silva, C.J., Torres, D.F.M.: Optimal control for a tuberculosis model with reinfection and post-exposure interventions, *Math. Biosci.* **244**, 154–164 (2013) [arXiv:1305.2145](https://arxiv.org/abs/1305.2145)
- [32] Zeiler, I., Caulkins, J., Grass, D., Tragler, G.: Keeping options open: an optimal control model with trajectories that reach a dnss point in positive time, *SIAM J. Control Optim.* **48**, 3698–3707 (2010)
- [33] Kumar, A., Srivastava, P.K.: Vaccination and treatment as control interventions in an infectious disease model with their cost optimization, *Commun. Nonlinear Sci. Numer. Simul.* **44**, 334–343 (2017)
- [34] Coddington, E., Levinson, N.: *Theory of Ordinary Differential Equations*, Tata McGraw-Hill Education (1955)
- [35] Gaff, H., Schaefer, E., Lenhart, S.: Use of optimal control models to predict treatment time for managing tick-borne disease, *J. Biol. Dyn.* **5**, 517–530 (2011)
- [36] Lenhart, S.M., Workman, J.T.: *Optimal Control Applied to Biological Models*, CRC Press, Boca Raton, FL (2007)
- [37] Pontryagin, L.S., Boltyanskii, V.G., Gamkrelidze, R.V., Mishchenko, E.F.: *The*

- mathematical theory of optimal processes, A Pergamon Press Book, The Macmillan Co., New York (1964)
- [38] Zine, H., Boukhouima, A., Lotfi, E.M., Mahrouf, M., Torres, D.F.M., Yousfi, N.: A stochastic time-delayed model for the effectiveness of Moroccan COVID-19 deconfinement strategy, *Math. Model. Nat. Phenom.* **15**, Paper 50, 14 pp (2020) [arXiv:2010.16265](#)
- [39] Abraha, T., Al Basir, F., Obsu, L.L., Torres, D.F.M.: Pest control using farming awareness: Impact of time delays and optimal use of biopesticides, *Chaos Solitons Fractals* **146**, Art. 110869, 11 pp (2021) [arXiv:2103.06007](#)
- [40] Denysiuk, R., Silva, C.J., Torres, D.F.M.: Multiobjective optimization to a TB-HIV/AIDS coinfection optimal control problem, *Comput. Appl. Math.* **37**, 2112–2128 (2018) [arXiv:1703.05458](#)