

Second Degree Model for Multi-Compression and Recovery of Distributed Signals

Pablo Soto-Quiros, Anatoli Torokhti and Stanley J. Miklavcic

Abstract—We study the problem of multi-compression and reconstructing a stochastic signal observed by several independent sensors (or compressors) that transmit compressed information to a fusion center. The key aspect of this problem is to find models of the sensors and fusion center that are optimized in the sense of an error minimization under a certain criterion, such as the mean square error (MSE). A novel technique to solve this problem is developed. The novelty is as follows. First, the multi-compressors are non-linear and modeled using second degree polynomials. This may increase the accuracy of the signal estimation through the optimization in a higher dimensional parameter space compared to the linear case. Second, the required models are determined by a method based on a combination of the second degree transform (SDT) [1] with the maximum block improvement (MBI) method [2], [3] and the generalized rank-constrained matrix approximation [4], [5]. It allows us to use the advantages of the methods in [2], [3], [4], [5] to further increase the estimation accuracy of the source signal. Third, the proposed method is justified in terms of pseudo-inverse matrices. As a result, the models of compressors and fusion center always exist and are numerically stable. In other words, the proposed models may provide compression, de-noising and reconstruction of distributed signals in cases when known methods either are not applicable or may produce larger associated errors.

Keywords—Data compression, stochastic signal recovery.

I. INTRODUCTION

This paper deals with a new method for the multi-compression and recovery of a source stochastic signal for a non-linear wireless sensor network (WSN). Although WSNs exhibit a significant potential in many application fields (see, for example [6]), up till now the results obtained are based on linear models and fall short of a consideration of more effective non-linear models for WSNs. The objective of this paper is to provide a new effective technique for the modeling of a non-linear WSN. The technique is based on an extension of the approach in [1] in combination with ideas of the maximum block improvement (MBI) method [2], [3] and the generalized rank-constrained matrix approximation [4], [5].

Pablo Soto-Quiros is with the Centre for Industrial and Applied Mathematics, University of South Australia, SA 5095, Australia and Instituto Tecnológico de Costa Rica, Apdo. 159-7050, Cartago, Costa Rica (e-mail: juan.soto-quiros@mymail.unisa.edu.au).

Anatoli Torokhti is with the Centre for Industrial and Applied Mathematics, University of South Australia, SA 5095, Australia (e-mail: anatoli.torokhti@unisa.edu.au).

Stanley J. Miklavcic is with the Phenomics and Bioinformatics Research Centre, University of South Australia, SA 5095, Australia (e-mail: stan.miklavcic@unisa.edu.au).

Manuscript received XXXX XX, 2015; revised XXXX XX, 2015.

A. Motivation

WE are motivated and inspired by the work in [7], [8], [9], [10], [11], [12], [13], [14], [15], [16], [17] where the effective methods for modeling of WSNs were developed. The WSNs are widely used in many areas of signal processing such as, for example, battlefield surveillance, target localization and tracking, and acoustic beamforming using an array of microphones [18], [19], [20]. An associated scenario involves a set of spatially distributed sensors, $\mathcal{B}_1, \dots, \mathcal{B}_p$, and a fusion center \mathcal{T} . The sensors are autonomous, have a limited energy supply and furthermore, cannot communicate with each other. The sensors make local noisy observations, $\mathbf{y}_1, \dots, \mathbf{y}_p$, correlated with a source stochastic signal \mathbf{x} . Each sensor \mathcal{B}_j transmits compressed information about its measurements, \mathbf{u}_j , to the fusion center which should recover the original signal within a prescribed accuracy. The compression level is predefined and is not data-dependent.

The problem is to find an effective way to compress and denoise each observation \mathbf{y}_j , where $j = 1, \dots, p$, and then reconstruct all the compressed observations in the fusion center so that the reconstruction will be optimal in the sense of a minimization of the associated error under a certain criterion, such as the mean square error (MSE).

The known methods for the distributed signal compression and recovery [7]-[17] are based on a natural idea of extensions of the optimal *linear* transforms [21], [22], [23]. In many cases, this approach leads to a required associated accuracy. At the same time, the error associated with the optimal *linear* transform, for a given compression ratio, cannot be diminished by any other linear transform. Thus, if the performance of the methods based on the optimal *linear* transforms is not as good as required then a method based on a different idea should be applied. In this paper, such a method is provided.

The key questions motivating this work are as follows. How can one improve the accuracy of the distributed signal processing approach compared to that of other methods? Second, is it possible to achieve the improvement under the same assumptions that those in the known methods? The last question is motivated by an observation that the models with an “extended” structure often require additional initial information needed for their implementation. Third, the block coordinate descent (BCD) method [24] is known to work on the modeling of WSNs when applied only under certain conditions, which may restrict its applicability. Is it possible to avoid those restrictions?

B. Known techniques

Here, the term “compression” is treated in the same sense as in the previous works on data compression (developed, for instance, in [7]-[17], [25], [26]), i.e. we say that observed signal \mathbf{y}_j with n_j components is compressed if it is represented by signal \mathbf{u}_j with r_j components where $r_j < n_j$, for $j = 1, \dots, p$. That is “compression” refers to dimensionality reduction and not quantization which outputs bits for digital transmission. This is similar to what is considered, in particular, in [7], [8], [9], [10], [11].

It is known that in the nondistributed setting (in the other words, in the case of a single sensor only) the MSE optimal solution is provided by the generic Karhunen-Loève transform (GKLT) [1], [27] which provides the smallest associated error in the class of all *linear* transforms. Nevertheless, the GKLT cannot be applied to the above WSN since the entire data vector $\mathbf{y} = [\mathbf{y}_1^T, \dots, \mathbf{y}_p^T]^T$ is not observed by each sensor (in this regard, see also [10], [11]). Therefore, several approaches to a determination of mathematical models for $\mathcal{B}_1, \dots, \mathcal{B}_p$ and \mathcal{T} have been pursued. In particular, in the information-theoretic context, distributed compression has been considered in the landmark works of Slepian and Wolf [28], and Wyner and Ziv [29]. The natural setting of the approach in [28], [29] in terms of the transform-based methodology has been considered in [7], [8], [9], [10], [11]. Intimate relations between these two perspectives have been shown in [30]. The methodology developed in [7], [8], [9], [10], [11] is based on the dimensionality reduction by linear projections. Such an approach has received considerable attention (see, for example, [12], [13], [14], [15], [16], [17], [31], [32]).

In particular, in [7], two approaches are considered. By the first approach, the fusion center model, \mathcal{T} , is given in the form $\mathcal{T} = [\mathcal{T}_1, \dots, \mathcal{T}_p]$ where \mathcal{T}_j is a ‘block’ of \mathcal{T} , for $j = 1, \dots, p$, and then the original MSE cost function is represented as a sum of p decoupled MSE cost functions. Then approximations to \mathcal{B}_j and \mathcal{T}_j are found as solution to each of the p associated MSE minimization (MSEM) problems. Some more related results can be found in [33]. The second approach in [7] generalizes the results in [8], [9] in the following way. The original MSE cost function is represented, by re-grouping terms, in the form similar to that presented by the summand in the decoupled MSE cost function. Then the minimum is seeking for each $\mathcal{T}_j \mathcal{B}_j$, for $j = 1, \dots, p$, while other terms $\mathcal{T}_k \mathcal{B}_k$, for $k = 1, \dots, j-1, j+1, \dots, p$, are assumed to be fixed. The minimizer follows from the result given in [21] (Theorem 10.2.4). To combine solutions of those p local MSEM problems, approximations to each sensor model \mathcal{B}_j are determined from an iterative procedure. Values of $\mathcal{B}_1, \dots, \mathcal{B}_p$ for the initial iteration are chosen randomly.

The method in [11] is based on ideas similar to those in the earlier references [7], [8], [9], [10]¹, i.e., on the replacement of the original MSEM problem with the $p+1$ unconstrained MSEM problems for separate determination of approximations to \mathcal{B}_j , for each $j = 1, \dots, p$, and then an approximation to \mathcal{T} . First, an approximation to each \mathcal{B}_j , for $j = 1, \dots, p$, is

determined under assumption that other $p-1$ sensors are fixed. Then, on the basis of known approximations to $\mathcal{B}_1, \dots, \mathcal{B}_p$, an approximation of \mathcal{T} is determined as the optimal Wiener filter. In [11], the involved signals are assumed to be zero-mean jointly Gaussian random vectors. Here, this restriction is not used.

The work in [8], [9], [10] can be considered as a particular case of [11].

The method in [34] is applied to the problem which is an approximation of the original problem. It implies an increase in the associated error compared to the method applied to the original problem. Further, the technique suggested in [34] is applicable under certain restrictions imposed on observations and associated covariance matrices. In particular, in [34], the observations should be presented in the special form $\mathbf{y}_j = H_j \mathbf{x} + \mathbf{v}_j$, for $j = 1, \dots, p$ (where H_j is a measurement matrix and \mathbf{v}_j is noise), and the covariance matrix formed by the noise vector should be *block-diagonal* and invertible. It is not the case here.

The approaches taken in the above references are based, in fact, on the BCD method [24]. The BCD method converges to a stationary point if the space of optimization is convex, and the objective function is continuous and regular [24] (pp. 480–481). It converges to a coordinatewise minimum if the space of optimization is convex and the objective function is continuous [24] (pp. 480–481). The BCD method converges to a global minimum if the objective function can be separated into sums of functions of single block variables [3] (p. 211). The above conditions are not satisfied in the present case.

Further, the WSN models in [7], [8], [9], [10], [11], [34] are justified in terms of inverse matrices. It is known that in cases when the matrices are close to singular this may lead to instability and a significant increase in the associated error. Moreover, when the matrices are singular, the algorithms [7], [8], [9], [10], [11] may not be applicable. This observation is illustrated by Examples 2, 3 in Section IV and Example 4 in Section VI below where the associated matrices are singular and the method [7] is not applicable. In [11], for the case when a matrix is singular, the inverse is replaced with the pseudo-inverse, but such a simple replacement does not follow from the justification of the model provided in [11]. As a result, a simple substitution by pseudo-inverse matrices may result in numerical instability as shown, in particular, in [35] and Example 2 in Section IV. In this regard, we also refer to references [4], [27], [36] where the case of rank-constrained data compression in terms of the pseudo-inverse matrices is studied.

C. Differences from known methods. Novelty and Contribution

The methods of [7]-[17], [34] are based on exploiting the *linear* minimizers of the mean square error [21], [22], [23] in the BCD method [24]. The key advantages and novelty of the proposed methodology, and differences from the techniques in [7]-[17], [34] are as follows.

Firstly, the minimizers developed in this paper are *non-linear*. They are based on the second degree transform (SDT) considered in [1]. It has been shown in [1] that under a certain

¹In particular, it generalizes the work of [10] to the case when the vectors of interest are not directly observed by the sensors.

condition, the SDT leads to greater accuracy in the signal estimation compared to methods based on the optimal linear signal transform, the GKLT. In Section X-C3, a similar condition is determined for the case under consideration, i.e., for distributed signal compression and reconstruction. Secondly, unlike the previous works we apply a version of the maximum block improvement (MBI) method [2], [3], not the BCD method [24]. This is because a solution of the minimization problem we consider is not unique, the optimization space is not convex and the objective function is not regular in the sense of [24]. The objective function also does not separate into sums of functions of single block variables [3]. As a result, convergence of the BCD method cannot be guaranteed [3] for the problem we consider. The MBI method [2], [3] avoids the requirements of the BCD method. The main idea of the MBI method is to implement an update of the block of variables which is the best possible among all the updates. Further, unlike the previous methods, at each stage of the proposed greedy method the generalized rank-constrained matrix approximation [4], [5] has to be applied. This is required because of the special structure of the objective function under consideration. More details are given below in Section III-A. Thirdly, the minimizers in [21], [22], [23] used in [7]-[17], [34] have been obtained in terms of inverse matrices, i.e., they have only been *justified* for full rank covariance matrices. In our method, the minimizers are obtained and rigorously *justified* in terms of pseudo-inverse matrices and, therefore, the models of the sensors and the fusion center are numerically stable and always exist. In other words, the proposed WSN model may provide compression, de-noising and reconstruction of distributed signals for the cases when known methods either are not applicable (because of singularity of associated matrices) or produce larger associated errors. This observation is supported, in particular, by the error analysis provided in Section X-C and by the results of simulations shown in Section IV. Fourthly, despite the special structure of our method compared to those of known techniques, the same initial information is required for the method implementation. This observation is illustrated in Example 1 given in Section IV.

D. Notation

Here, we provide some notation which is required to formalize the problem in the form presented in Section below. Let us write (Ω, Σ, μ) for a probability space². We denote by $\mathbf{x} \in L^2(\Omega, \mathbb{R}^m)$ the signal of interest³ (a source signal to be estimated) represented as $\mathbf{x} = [\mathbf{x}^{(1)}, \dots, \mathbf{x}^{(m)}]^T$ where $\mathbf{x}^{(j)} \in L^2(\Omega, \mathbb{R})$, for $j = 1, \dots, m$. Further, $\mathbf{y}_1 \in L^2(\Omega, \mathbb{R}^{n_1}), \dots, \mathbf{y}_p \in L^2(\Omega, \mathbb{R}^{n_p})$ are observations made by the sensors. In this regard, we write

$$\mathbf{y} = [\mathbf{y}_1^T, \dots, \mathbf{y}_p^T]^T \quad \text{and} \quad \mathbf{y} = [\mathbf{y}^{(1)}, \dots, \mathbf{y}^{(n)}]^T \quad (1)$$

²Here $\Omega = \{\omega\}$ is the set of outcomes, Σ a σ -field of measurable subsets of Ω and $\mu : \Sigma \rightarrow [0, 1]$ an associated probability measure on Σ with $\mu(\Omega) = 1$.

³Space $L^2(\Omega, \mathbb{R}^m)$ has to be used because of the norm introduced in (3) below.

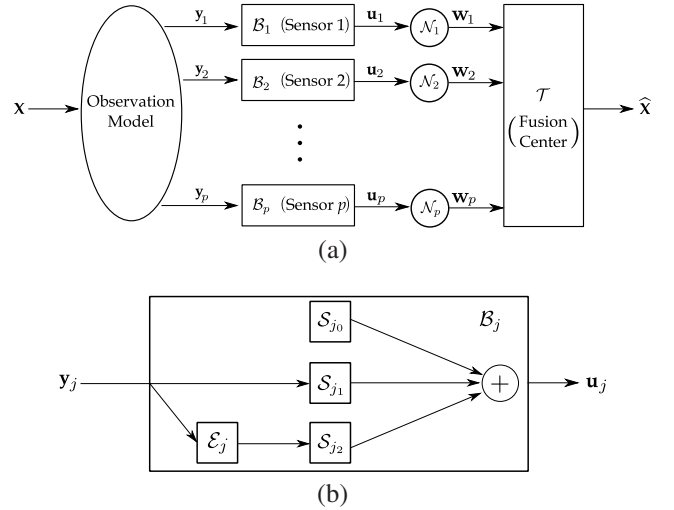

Fig. 1. (a): WSN model. (b): Sensor model.

where $\mathbf{y}^{(k)} \in L^2(\Omega, \mathbb{R})$, for $k = 1, \dots, n$. We would like to emphasize a difference between \mathbf{y}_j and $\mathbf{y}^{(k)}$: in (1), the observation \mathbf{y}_j , for $j = 1, \dots, p$, is a random vector itself (i.e. \mathbf{y}_j is a ‘piece’ of \mathbf{y}), and $\mathbf{y}^{(k)}$, for $k = 1, \dots, n$, is a random variable (i.e. $\mathbf{y}^{(k)}$ is an entry of \mathbf{y}). Therefore, $\mathbf{y}_j = (\mathbf{y}^{(q_{j-1}+1)}, \dots, \mathbf{y}^{(q_j)})^T$ where $q_j = q_{j-1} + n_j$, $j = 1, \dots, p$ and $q_0 = 0$.

For $j = 1, \dots, p$, we represent a sensor model by linear operator $\mathcal{B}_j : L^2(\Omega, \mathbb{R}^{n_j}) \rightarrow L^2(\Omega, \mathbb{R}^{r_j})$ defined by matrix $B_j \in \mathbb{R}^{r_j \times n_j}$ such that,⁴ for $j = 1, \dots, p$,

$$[\mathcal{B}_j(\mathbf{y}_j)](\omega) = B_j[\mathbf{y}_j(\omega)]. \quad (2)$$

Here, $r = r_1 + \dots + r_p$, $r_j \leq \min\{m, n_j\}$, and r_j is given and fixed for each j th sensor, for $j = 1, \dots, p$. Let us denote $\mathbf{u}_j = \mathcal{B}_j(\mathbf{y}_j)$ and $\mathbf{u} = [\mathbf{u}_1^T, \dots, \mathbf{u}_p^T]^T$, where for $j = 1, \dots, p$, vector $\mathbf{u}_j \in L^2(\Omega, \mathbb{R}^{r_j})$ represents the compressed observation transmitted by a j th sensor \mathcal{B}_j to the fusion center \mathcal{T} .

A fusion center model is represented by linear operator $\mathcal{T} : L^2(\Omega, \mathbb{R}^r) \rightarrow L^2(\Omega, \mathbb{R}^m)$ defined by matrix $T \in \mathbb{R}^{m \times r}$ so that $[\mathcal{T}(\mathbf{u})](\omega) = T[\mathbf{u}(\omega)]$, where $\mathbf{u} \in L^2(\Omega, \mathbb{R}^r)$. To state the problem in the next section, we also denote

$$\mathbb{E}(\|\mathbf{x}\|^2) := \|\mathbf{x}\|_\Omega^2 := \int_\Omega \|\mathbf{x}(\omega)\|_2^2 d\mu(\omega) < \infty, \quad (3)$$

where $\|\mathbf{x}(\omega)\|_2$ is the Euclidean norm of $\mathbf{x}(\omega) \in \mathbb{R}^m$.

II. STATEMENTS OF THE PROBLEMS

A. Formalization of the Generic Problem

For \mathbf{x} represented by $\mathbf{x} = [\mathbf{x}^{(1)}, \dots, \mathbf{x}^{(m)}]^T$ where $\mathbf{x}^{(j)} \in L^2(\Omega, \mathbb{R})$ we write $E[\mathbf{x}\mathbf{y}^T] = E_{xy} = \{E_{x_j y_k}\}_{j,k=1}^{m,n} \in \mathbb{R}^{m \times n}$, where $E_{x_j y_k} = \int_\Omega \mathbf{x}^{(j)}(\omega)\mathbf{y}^{(k)}(\omega)d\mu(\omega) < \infty$ and $\mathbf{y} = [\mathbf{y}^{(1)}, \dots, \mathbf{y}^{(n)}]^T$. An assumption used in previous methods [7], [8], [9], [10], [11] and associated works such as [21], [22],

⁴An explanation for the relation in (2) is given in Section X-B.

[23], [25], [37] is that the covariance matrices E_{xy} and E_{yy} are known. Here, we adopt this assumption. As mentioned, in particular, in [7] (and similarly, for example, in [37], [38], [39], [40], [41], [42], [43], [44], [45]), “*a priori* knowledge of the covariances can come either from specific data models, or, after sample estimation during a training phase.” Importantly, although we wish to develop the method with an extended structure, no additional initial information is required. Example 1 in Section IV illustrates this observation.

First, we consider the case when the channels from the sensors to the fusion center are ideal, i.e., each channel operator \mathcal{N}_j in Fig. 1 (a) is the identity. The case of not ideal channels will be considered in Section V. Then the problem is as follows: Find models of the sensors, $\mathcal{B}_1, \dots, \mathcal{B}_p$, and a model of the fusion center, \mathcal{T} , that provide

$$\min_{\mathcal{T}, \mathcal{B}_1, \dots, \mathcal{B}_p} \left\| \mathbf{x} - \mathcal{T} \begin{bmatrix} \mathcal{B}_1(\mathbf{y}_1) \\ \vdots \\ \mathcal{B}_p(\mathbf{y}_p) \end{bmatrix} \right\|_{\Omega}^2. \quad (4)$$

The model of the fusion center, \mathcal{T} , can be represented as $\mathcal{T} = [\mathcal{T}_1, \dots, \mathcal{T}_p]$ where for $j = 1, \dots, p$, $\mathcal{T}_j : L^2(\Omega, \mathbb{R}^{r_j}) \rightarrow L^2(\Omega, \mathbb{R}^m)$. Let us write

$$\begin{aligned} & \min_{\substack{\mathcal{T}_1, \dots, \mathcal{T}_p, \\ \mathcal{B}_1, \dots, \mathcal{B}_p}} \left\| \mathbf{x} - [\mathcal{T}_1, \dots, \mathcal{T}_p] \begin{bmatrix} \mathcal{B}_1(\mathbf{y}_1) \\ \vdots \\ \mathcal{B}_p(\mathbf{y}_p) \end{bmatrix} \right\|_{\Omega}^2 \\ &= \min_{\substack{\mathcal{T}_1, \dots, \mathcal{T}_p, \\ \mathcal{B}_1, \dots, \mathcal{B}_p}} \left\| \mathbf{x} - [\mathcal{T}_1 \mathcal{B}_1(\mathbf{y}_1) + \dots + \mathcal{T}_p \mathcal{B}_p(\mathbf{y}_p)] \right\|_{\Omega}^2 \end{aligned} \quad (5)$$

where $\mathbf{y} = [\mathbf{y}_1^T, \dots, \mathbf{y}_p^T]^T$.

In this paper, we study the case where \mathcal{B}_j , for $j = 1, \dots, p$, is represented by a second degree polynomial, i.e., is non-linear. Previous methods were developed for the case of *linear* \mathcal{T}_j and \mathcal{B}_j , for $j = 1, \dots, p$.

B. Inducement to Introduce Second Degree WSN

1) *Linear WSN*: Let us first consider the case when \mathcal{T}_j and \mathcal{B}_j are *linear* operators, and $\mathcal{N}_j = I$, for $j = 1, \dots, p$. Denote by $\mathcal{R}(m, n_j, r_j)$ the variety of all linear operators $L^2(\Omega, \mathbb{R}^{n_j}) \rightarrow L^2(\Omega, \mathbb{R}^m)$ of rank at most r_j where $k \leq \min\{m, n_j\}$. For convenience we will sometimes write \mathcal{R}_{r_j} instead of $\mathcal{R}(m, n_j, r_j)$. Then, for $\mathcal{F}_j = \mathcal{T}_j \mathcal{B}_j$, the generic problem in (5) can equivalently be reformulated as follows: Find $\mathcal{F}_1, \dots, \mathcal{F}_p$ that solve

$$\min_{\mathcal{F}_1 \in \mathcal{R}_{r_1}, \dots, \mathcal{F}_p \in \mathcal{R}_{r_p}} \left\| \mathbf{x} - \sum_{j=1}^p \mathcal{F}_j(\mathbf{y}_j) \right\|_{\Omega}^2. \quad (6)$$

Recall that $r_j < \min\{m, n_j\}$, for $j = 1, \dots, p$.

2) *Second Degree WSN*: Mathematically speaking, the problem in (6) is the problem of the best constrained *linear* approximation. At the same time, it is known that a ‘proper’ *non-linear* approximation would provide better associated accuracy, i.e., a better estimation of \mathbf{x} . This follows, in particular, from the famous Weierstrass approximation theorem [46] and its

generalizations in [47], [48], [49], [50], [51], [52], [53].⁵ In [1], this observation has been realized as the second degree transform. For $p = 1$ and $\mathcal{N}_1 = I$ in (5), it has been shown in [1] that if

$$\mathcal{T}_1 \mathcal{B}_1(\mathbf{y}_1) = \mathcal{A}_1(\mathbf{y}) + \mathcal{A}_2(\mathbf{y}^2), \quad (7)$$

where \mathbf{y}^2 is given by $\mathbf{y}^2(\omega) := ([y_1(\omega)]^2, \dots, [y_n(\omega)]^2)^T$, and operators \mathcal{A}_1 and \mathcal{A}_2 are determined from the minimization of the associated MSE, then under a quite unrestrictive condition obtained in [1], the error associated with the SDT [1] is less than the error associated with the GKLT, for the same compression ratio. The improvement in [1] is due to doubling of the number of parameters compared to the KLT. Indeed, the KLT is a particular case of transform [1] if $\mathcal{A}_2 = \mathbb{O}$ in (7), where \mathbb{O} is zero operator. In the general case, optimization of $\mathcal{T}_1 \mathcal{B}_1$ in (7) is achieved by a variation of two operators, \mathcal{A}_1 and \mathcal{A}_2 , while the KLT is obtained on the basis of optimization of \mathcal{A}_1 only. More details are provided in Section X-A.

Based on these observations, we now extend the approach in [1] to the case of arbitrary p in (5) and combine it with the MBI method [2], [3] and results in [4], [5]. To this end, we write

$$\mathcal{B}_j(\mathbf{y}_j) = \mathcal{S}_{j,0} + \mathcal{S}_{j,1}(\mathbf{y}_j) + \mathcal{S}_{j,2}(\mathbf{y}_j^2), \quad (8)$$

where a random vector $\mathcal{S}_{j,0} \in L^2(\Omega, \mathbb{R}^{r_j})$, and linear operators $\mathcal{S}_{j,1} : L^2(\Omega, \mathbb{R}^{n_j}) \rightarrow L^2(\Omega, \mathbb{R}^{r_j})$ and $\mathcal{S}_{j,2} : L^2(\Omega, \mathbb{R}^{n_j}) \rightarrow L^2(\Omega, \mathbb{R}^{r_j})$ are to be determined, and \mathbf{y}_j^2 is defined by $\mathbf{y}_j^2(\omega) = ([y^{(q_{j-1}+1)}(\omega)]^2, \dots, [y^{(q_j)}(\omega)]^2)^T$, for all $\omega \in \Omega$, where, as before, $q_j = q_{j-1} + n_j$, $j = 1, \dots, p$ and $q_0 = 0$. In (8), the term $\mathcal{S}_{j,2}(\mathbf{y}_j^2)$ can be interpreted as a ‘*second degree term*’. In this regard, $\mathcal{B}_j(\mathbf{y}_j)$ is called the second degree polynomial. Furthermore, $\mathcal{B}_j(\mathbf{y}_j)$ can also be written as

$$\mathcal{B}_j(\mathbf{y}_j) = \mathcal{S}_j(\mathbf{z}_j) \quad (9)$$

where

$$\mathcal{S}_j = [\mathcal{S}_{j,0}, \mathcal{S}_{j,1}, \mathcal{S}_{j,2}] \quad \text{and} \quad \mathbf{z}_j = [1, \mathbf{y}_j^T, (\mathbf{y}_j^2)^T]^T. \quad (10)$$

The above implies the following definition.

Definition 1: Let $\mathcal{S} = \text{diag}[\mathcal{S}_1, \dots, \mathcal{S}_p]$, $\mathbf{z} = [\mathbf{z}_1^T, \dots, \mathbf{z}_p^T]^T$ and $\mathcal{P}_j = \mathcal{T}_j \mathcal{S}_j$, for $j = 1, \dots, p$. The WSN represented by the operator $\mathcal{P} = \mathcal{T} \mathcal{S}$ such that

$$\begin{aligned} \mathcal{P}(\mathbf{z}) &= \sum_{j=1}^p \mathcal{P}_j(\mathbf{z}_j) \\ &= \sum_{j=1}^p \mathcal{T}_j [\mathcal{S}_{j,0} + \mathcal{S}_{j,1}(\mathbf{y}_j) + \mathcal{S}_{j,2}(\mathbf{y}_j^2)], \end{aligned} \quad (11)$$

⁵A constructive choice of the optimal non-linear approximation, which provides the minimal associated error, is a special and hard research problem [54]. Its solution is subject to special conditions (convexity, for example) that are not satisfied for the problem under consideration. This is why in [7], [8], [9], [10], [11], [12], [13], [14], the special approaches for solving problem (6) have been developed.

where

$$\begin{aligned}\mathcal{P}_j(\mathbf{z}_j) &= \mathcal{T}_j \mathcal{S}_j(\mathbf{z}_j) \\ &= \mathcal{T}_j [\mathcal{S}_{j,0} + \mathcal{S}_{j,1}(\mathbf{y}_j) + \mathcal{S}_{j,2}(\mathbf{y}_j^2)]\end{aligned}\quad (12)$$

will be called the *second degree WSN*. If $\mathcal{S}_{j,0}$ and $\mathcal{S}_{j,2}$ are the zero random vector and zero operator, respectively, for all $j = 1, \dots, p$, then the WSN will be called the *linear WSN*.

C. Statement of the Problem for Second Degree WSN

On the basis of (8)-(11), for the second degree WSN, the generic problem in (5) is reformulated as follows. For $j = 1, \dots, p$, let \mathcal{B}_j and \mathbf{z}_j be represented by (8)-(10), and \mathcal{P}_j be as in (12). Find $\mathcal{P}_1, \dots, \mathcal{P}_p$ that solve

$$\min_{\mathcal{P}_1 \in \mathcal{R}_{r_1}, \dots, \mathcal{P}_p \in \mathcal{R}_{r_p}} \left\| \mathbf{x} - \sum_{j=1}^p \mathcal{P}_j(\mathbf{z}_j) \right\|_{\Omega}^2. \quad (13)$$

Note that \mathcal{P}_j is linear with respect to \mathbf{z}_j and non-linear with respect to \mathbf{y}_j . At the same time, we are interested in the optimal models for \mathcal{B}_j , for $j = 1, \dots, p$, and \mathcal{T} . It will be show in Section III, that the models follow from the solution of problem (13).

III. SOLUTION OF PROBLEM (13)

A. Greedy Approach to Determining $\mathcal{P}_1, \dots, \mathcal{P}_p$ that Solve (13)

We wish to find $\mathcal{P}_1, \dots, \mathcal{P}_p$ that provide a solution to the problem in (13) for an arbitrary finite number of sensors in the WSN model, i.e. for $p = 1, 2, \dots$ in (13). To this end, we need some more preliminaries which are given in Sections III-A1 and III-A2 that follow. The method itself and an associated algorithm are then represented in Section III-A3.

1) *Reduction of Problem (13) to Equivalent Form*: Let us set $M^{1/2\dagger} = (M^{1/2})^\dagger$, where $M^{1/2}$ is a square root of a matrix M , i.e. $M = M^{1/2}M^{1/2}$. The pseudo-inverse for a matrix M is denoted by M^\dagger .

We denote $P = [P_1, \dots, P_p]$, where $P \in \mathbb{R}^{m \times (2n+p)}$ and $P_j \in \mathbb{R}^{m \times (2n_j+1)}$, for all $j = 1, \dots, p$, $\mathcal{P}_j(\mathbf{z}_j) = P_j \mathbf{z}_j$ and write $\|\cdot\|$ for the Frobenius norm. Then

$$\begin{aligned}\left\| \mathbf{x} - \sum_{j=1}^p \mathcal{P}_j(\mathbf{z}_j) \right\|_{\Omega}^2 &= \left\| \mathbf{x} - \sum_{j=1}^p P_j \mathbf{z}_j \right\|_{\Omega}^2 \\ &= \|\mathbf{x} - P(\mathbf{z})\|_{\Omega}^2 \\ &= \|E_{xx}^{1/2}\|^2 - \|E_{xz}(E_{zz}^{1/2})^\dagger\|^2 \\ &\quad + \|E_{xz}(E_{zz}^{1/2})^\dagger - PE_{zz}^{1/2}\|^2.\end{aligned}\quad (14)$$

Let us write $H = E_{xz}(E_{zz}^{1/2})^\dagger$ and represent matrix $E_{zz}^{1/2}$ in blocks

$$E_{zz}^{1/2} = [G_1^T, \dots, G_p^T]^T \quad (15)$$

where $E_{zz}^{1/2} \in \mathbb{R}^{(2n+p) \times (2n+p)}$ and $G_j \in \mathbb{R}^{(2n_j+1) \times (2n+p)}$,

for $j = 1, \dots, p$. Then

$$E_{xz}(E_{zz}^{1/2})^\dagger - PE_{zz}^{1/2} = H - \sum_{j=1}^p P_j G_j. \quad (16)$$

Therefore, (14) and (16) imply

$$\begin{aligned}&\min_{P_1 \in \mathcal{R}_{r_1}, \dots, P_p \in \mathcal{R}_{r_p}} \left\| \mathbf{x} - \sum_{j=1}^p P_j(\mathbf{z}_j) \right\|_{\Omega}^2 \\ &= \min_{P_1 \in \mathbb{R}_{r_1}, \dots, P_p \in \mathbb{R}_{r_p}} \left\| H - \sum_{j=1}^p P_j G_j \right\|_{\Omega}^2\end{aligned}\quad (17)$$

where \mathbb{R}_{r_j} denotes the variety of all $m \times (2n_j + 1)$ matrices of rank at most r_j , for $j = 1, \dots, p$, where $r_j \leq \min\{m, n_j\}$. On the basis of (17), problem (13) and the problem

$$\min_{P_1 \in \mathbb{R}_{r_1}, \dots, P_p \in \mathbb{R}_{r_1}} \left\| H - \sum_{j=1}^p P_j G_j \right\|_{\Omega}^2 \quad (18)$$

are equivalent. Therefore, below we consider problem (18). Note that

$$\left\| H - \sum_{j=1}^p P_j G_j \right\|_{\Omega}^2 = \|Q_j - P_j G_j\|^2, \quad (19)$$

where $Q_j = H - \sum_{\substack{i=1 \\ i \neq j}}^p P_i G_i$. This representation will be used below.

2) *SVD and Orthogonal Projections* : Let the SVD of a matrix $C \in \mathbb{R}^{m \times s}$ be given by

$$C = U_C \Sigma_C V_C^T, \quad (20)$$

where $U_C \in \mathbb{R}^{m \times m}$ and $V_C \in \mathbb{R}^{s \times s}$ are unitary matrices, $\Sigma_C = \text{diag}(\sigma_1(C), \dots, \sigma_{\min(m,s)}(C)) \in \mathbb{R}^{m \times s}$ is a generalized diagonal matrix, with the singular values $\sigma_1(C) \geq \sigma_2(C) \geq \dots \geq 0$ on the main diagonal. Let $U_C = [u_1 \ u_2 \ \dots \ u_m]$ and $V_C = [v_1 \ v_2 \ \dots \ v_s]$ be the representations of U and V in terms of their m and s columns, respectively. Let $L_C \in \mathbb{R}^{m \times m}$ and $R_C \in \mathbb{R}^{s \times s}$, such that

$$L_C = \sum_{i=1}^{\text{rank } C} u_i u_i^T \quad \text{and} \quad R_C = \sum_{i=1}^{\text{rank } C} v_i v_i^T, \quad (21)$$

be the orthogonal projections on the range of C and C^T , correspondingly. Define $C_r \in \mathbb{R}^{m \times s}$ such that

$$C_r = [C]_r = \sum_{i=1}^r \sigma_i(C) u_i v_i^T = U_{C_r} \Sigma_{C_r} V_{C_r}^T \quad (22)$$

for $r = 1, \dots, \text{rank } C$, where

$$U_{C_r} = [u_1 \ u_2 \ \dots \ u_r],$$

$$\Sigma_{C_r} = \text{diag}(\sigma_1(C), \dots, \sigma_r(C)), \quad (23)$$

$$V_{C_r} = [v_1 \ v_2 \ \dots \ v_r].$$

For $r > \text{rank } C$, we write $C^{(r)} = C (= C_{\text{rank } C})$. For $1 \leq r < \text{rank } C$, the matrix $C^{(r)}$ is uniquely defined if and only if $\sigma_r(C) > \sigma_{r+1}(C)$.

3) *Greedy Method for Solution of Problem (18)*: An exact solution of problem (18) is unknown. That is why, similar to previous works [7]-[17], [34], we adopt a greedy approach for its solution.⁶ In particular, in [7]-[17], [34], the BCD method [24] (mentioned in Section I-B) was used. At the same time, the conditions for convergence of the BCD method are not satisfied for problem (18). The recently developed MBI method [2], [3] avoids the restrictions of the BCD method. The advantage and main idea of the MBI method is that it accepts an ‘‘update of the block of variables that achieves the maximum improvement’’ [3] at each iteration. Further, the problem in (18) is different from that considered in [7]-[17], [34]. Therefore, unlike methods in [7]-[17], [34], a solution of problem (18) is represented by a version of the MBI method [2], [3] where at each iteration the result from [4], [5] is exploited; this is due to the specific form of the objective function in (18). More precisely, each iteration of the proposed method is based on the following result.

Theorem 1: Let $K_j = M_j(I - LG_j)$ where M_j is an arbitrary matrix. For given $P_1, \dots, P_{j-1}, P_{j+1}, \dots, P_p$, the optimal matrix \hat{P}_j of rank at most r_j minimizing

$$\left\| \mathbf{x} - \sum_{j=1}^p \mathcal{P}_j(\mathbf{z}_j) \right\|_{\Omega}^2$$

is given by

$$\hat{P}_j = [Q_j R_{G_j}]_{r_j} G_j^\dagger (I + K_j), \quad \text{for } j = 1, \dots, p. \quad (24)$$

where Q_j and G_j are as in (15) and (19), and R_{G_j} and $[\cdot]_{r_j}$ are defined similarly to (21) and (22), respectively. Any minimizing \hat{P}_j has the above form if and only if either $r_j \geq \text{rank}(Q_j R_{G_j})$ or $1 \leq r_j < \text{rank}(Q_j R_{G_j})$ and $\sigma_{r_j}(Q_j R_{G_j}) > \sigma_{r_j+1}(Q_j R_{G_j})$, where $\sigma_{r_j}(Q_j R_{G_j})$ is a singular value in the SVD for matrix $Q_j R_{G_j}$.

Proof: The proof is considered in Section X-C. We note that the arbitrary matrix M_j implies non-uniqueness of the optimal matrix \hat{P}_j . ■

We represent the error associated with the optimal matrix \hat{P}_j in the way similar to that used in [7], [11]. Let us write $\bar{\mathbf{x}} = \mathbf{x} - \mathbf{w}_j$, where $\mathbf{w}_j = \sum_{\substack{i=1 \\ i \neq j}}^p \mathcal{P}_i \mathbf{z}_i$. Denote by $\delta_1, \dots, \delta_{r_j}$ the first r_j eigenvalues in the SVD for matrix $E_{\bar{\mathbf{x}} \mathbf{z}_j} E_{\mathbf{z}_j \mathbf{z}_j}^\dagger E_{\mathbf{z}_j \bar{\mathbf{x}}}$, and by $\mu_{j,1}, \dots, \mu_{j,m_j}$ the eigenvalues of $C_j H_j^\dagger C_j^T$, where $C_j = E_{\bar{\mathbf{x}} y_j^2} - E_{\bar{\mathbf{x}} y_j} E_{y_j y_j}^\dagger E_{y_j y_j^2}$ and $H_j = E_{y_j^2 y_j^2} - E_{y_j^2 y_j} E_{y_j y_j}^\dagger E_{y_j y_j^2}$. We also write $\beta_j = \text{tr}\{2 E_{w_j x} - E_{w_j w_j}\}$ and

$$f(P_1, \dots, P_p) = \left\| \mathbf{x} - \sum_{j=1}^p \mathcal{P}_j(\mathbf{z}_j) \right\|_{\Omega}^2.$$

Theorem 2: For given $P_1, \dots, P_{j-1}, P_{j+1}, \dots, P_p$, the error associated with the optimal matrix \hat{P}_j is given by

$$f(P_1, \dots, P_{j-1}, \hat{P}_j, P_{j+1}, \dots, P_p) = \text{tr}\{E_{xx}\} - \sum_{i=1}^{r_j} \delta_i - \sum_{i=1}^m \mu_{j,i} - \beta_j. \quad (25)$$

Proof: The proof is considered in Section X-C. If the given matrices $P_1, \dots, P_{j-1}, P_{j+1}, \dots, P_p$ are optimal in the sense of minimizing $\left\| \mathbf{x} - \sum_{j=1}^p \mathcal{P}_j(\mathbf{z}_j) \right\|_{\Omega}^2$, then Theorem 1 returns the globally optimal solution of (13). ■

Further, let us denote $\mathbb{R}_{r_1, \dots, r_p} = \mathbb{R}_{r_1} \times \dots \times \mathbb{R}_{r_p}$, $\mathbf{P} = (P_1, \dots, P_p) \in \mathbb{R}_{r_1, \dots, r_p}$ and $\phi(\mathbf{P}) = \left\| H - \sum_{j=1}^p P_j G_j \right\|^2$. The computational procedure for the solution of problem (13) is based on the solution of problem (18) and consists of the following steps.

1st step. Given $\mathbf{P}^{(0)} = (P_1^{(0)}, \dots, P_p^{(0)}) \in \mathbb{R}_{r_1, \dots, r_p}$, compute $\hat{P}_j^{(1)}$, for $j = 1, \dots, p$, such that

$$\hat{P}_j^{(1)} = [Q_j^{(0)} R_{G_j}]_{r_j} G_j^\dagger (I + K_j), \quad (26)$$

where

$$Q_j^{(0)} = H - \sum_{\substack{i=1 \\ i \neq j}}^p P_i^{(0)} G_i.$$

Here, G_j is given by (19), and $\hat{P}_j^{(1)}$ is evaluated in the form (26) on the basis of Theorem 1 and using $P_1^{(0)}, \dots, P_{j-1}^{(0)}, P_{j+1}^{(0)}, \dots, P_p^{(0)}$. Matrices E_{xx} and E_{zz} are formed from matrices E_{xy} and E_{yy} . This is illustrated below by Example 1 in Section IV. A choice of initial iterations $P_1^{(0)}, \dots, P_p^{(0)}$, is considered in Section III-B below.

2nd step. Denote

$$\bar{\mathbf{P}}_j^{(1)} = (P_1^{(0)}, \dots, P_{j-1}^{(0)}, \hat{P}_j^{(1)}, P_{j+1}^{(0)}, \dots, P_p^{(0)}) \quad (27)$$

and select $\bar{\mathbf{P}}_k^{(1)}$, for $k = 1, \dots, p$, such that $\phi(\bar{\mathbf{P}}_k^{(1)})$ is minimal among all $\phi(\bar{\mathbf{P}}_1^{(1)}), \dots, \phi(\bar{\mathbf{P}}_k^{(1)}), \dots, \phi(\bar{\mathbf{P}}_p^{(1)})$, i.e.

$$\bar{\mathbf{P}}_k^{(1)} = \arg \min_{\bar{\mathbf{P}}_1^{(1)}, \dots, \bar{\mathbf{P}}_p^{(1)}} \left\{ \phi(\bar{\mathbf{P}}_1^{(1)}), \dots, \phi(\bar{\mathbf{P}}_k^{(1)}), \dots, \phi(\bar{\mathbf{P}}_p^{(1)}) \right\} \quad (28)$$

and write

$$\mathbf{P}^{(1)} = \bar{\mathbf{P}}_k^{(1)}, \quad (29)$$

where we denote $\mathbf{P}^{(1)} = (P_1^{(1)}, \dots, P_p^{(1)}) \in \mathbb{R}_{r_1, \dots, r_p}$.

Then we repeat procedure (26)-(29) with the replacement of $\mathbf{P}^{(0)}$ by $\mathbf{P}^{(1)}$ as follows: Given $\mathbf{P}^{(1)} = (P_1^{(1)}, \dots, P_p^{(1)})$, compute, for $j = 1, \dots, p$,

$$\hat{P}_j^{(2)} = [Q_j^{(1)} R_{G_j}]_{r_j} G_j^\dagger (I + K_j),$$

⁶Other reason to apply the greedy approach is mentioned at the end of Section X-A.

where

$$Q_j^{(1)} = H - \sum_{\substack{i=1 \\ i \neq j}}^p P_i^{(1)} G_i.$$

Note that $\widehat{P}_j^{(2)}$ is computed similar to $\widehat{P}_j^{(1)}$, i.e., on the basis of Theorem 1 and using $P_1^{(1)}, \dots, P_{j-1}^{(1)}, P_{j+1}^{(1)}, \dots, P_p^{(1)}$. Then denote $\overline{P}_j^{(2)} = (P_1^{(1)}, \dots, P_{j-1}^{(1)}, \widehat{P}_j^{(2)}, P_{j+1}^{(1)}, \dots, P_p^{(1)})$, select $\overline{P}_k^{(2)}$ that satisfies (28) where superscript (1) is replaced with superscript (2), and set $\mathbf{P}^{(2)} = \overline{P}_k^{(2)}$ where $\mathbf{P}^{(2)} = (P_1^{(2)}, \dots, P_p^{(2)}) \in \mathbb{R}_{r_1, \dots, r_p}$.

This process is continued up to the q th step when a given tolerance $\epsilon \geq 0$ is achieved in the sense

$$|\phi(\mathbf{P}^{(q+1)}) - \phi(\mathbf{P}^{(q)})| \leq \epsilon, \quad \text{for } q = 1, 2, \dots \quad (30)$$

It is summarized as follows.

Algorithm 1: Greedy solution of problem (18)

Initialization: $\mathbf{P}^{(0)}$, H , G_1, \dots, G_p and $\epsilon > 0$.

1. **for** $q = 0, 1, 2, \dots$
 2. **for** $j = 1, 2, \dots, p$
 3. $Q_j^{(q)} = H - \sum_{i=1, i \neq j}^p P_i^{(q)} G_i$
 4. $\widehat{P}_j^{(q+1)} = [Q_j^{(q)} R_{G_j}]_{r_j} G_j^\dagger (I + K_j)$
 5. $\overline{P}_j^{(q+1)} = (P_1^{(q)}, \dots, P_{j-1}^{(q)}, \widehat{P}_j^{(q+1)}, P_{j+1}^{(q)}, \dots, P_p^{(q)})$
 6. **end**
 7. Choose $\overline{P}_k^{(q+1)}$ such that

$$\overline{P}_k^{(q+1)} = \arg \min_{\overline{P}_1^{(q+1)}, \dots, \overline{P}_p^{(q+1)}} \left\{ \phi(\overline{P}_1^{(q+1)}), \dots, \phi(\overline{P}_p^{(q+1)}) \right\}$$
 8. Set $\mathbf{P}^{(q+1)} := \overline{P}_k^{(q+1)}$, where $\mathbf{P}^{(q+1)} = (P_1^{(q+1)}, \dots, P_p^{(q+1)})$
 9. **If** $|\phi(\mathbf{P}^{(q+1)}) - \phi(\mathbf{P}^{(q)})| \leq \epsilon$
 10. **Stop**
 11. **end**
 12. **end**
-

Sequence $\{\mathbf{P}^{(q+1)}\}$ converges to a coordinate-wise minimum point of objective function $\phi(\mathbf{P})$ which is a local minimum of (18). Section X-C provides more associated details.

Theorem 3: For $\mathbf{P}^{(q+1)}$ determined by Algorithm 1, the error associated with the proposed model of the second order WSN is represented as

$$\begin{aligned} \|\mathbf{x} - \mathbf{P}^{(q+1)}(\mathbf{z})\|_\Omega^2 &= \|E_{xx}^{1/2}\|^2 - \|E_{xz}(E_{zz}^{1/2})^\dagger\|^2 \\ &\quad + \|E_{xz}(E_{zz}^{1/2})^\dagger - \mathbf{P}^{(q+1)} E_{zz}^{1/2}\|^2. \end{aligned} \quad (31)$$

Proof: The proof follows from (14). ■

Remark 1: Although (31) represents a posteriori error, it is convenient to use during a testing phase.

Remark 2: For $p = 1$, the formula in (26) coincides with

the second degree transform (SDT) proposed in [1]. Therefore, the transform represented by $\mathcal{P}(\mathbf{z}) = \sum_{j=1}^p \mathcal{P}_j(\mathbf{z}_j)$ (see

Definition 1) where P_j solves $\min_{P_j \in \mathbb{R}_{r_j}} \|H - \sum_{i=1}^p P_i G_i\|^2$, for $j = 1, \dots, p$, can be regarded the multi-compressor SDT. Further, Algorithm 1 represents the version of the MBI method that uses the multi-compressor SDT. Therefore, the WSN model in the form $\mathcal{P}^{(q+1)}(\mathbf{z}) = \sum_{j=1}^p \mathcal{P}_j^{(q+1)}(\mathbf{z}_j)$ where $P_1^{(q+1)}, \dots, P_p^{(q+1)}$ are determined by Algorithm 1 can be interpreted as a transform as well. We call this transform the multi-compressor SDT-MBI.

B. Determination of Initial Iterations

We determine initial iterations $P_j^{(0)}$, for $j = 1, \dots, p$, for Algorithm 1 as follows. Let us denote $\mathbf{x} = [\mathbf{x}_1^T, \dots, \mathbf{x}_p^T]^T$ where $\mathbf{x}_i \in L^2(\Omega, \mathbb{R}^{m_i})$, $i = 1, \dots, p$ and $m_1 + \dots + m_p = m$. Suppose that matrix $T \in \mathbb{R}^{m \times r}$ is given by $T = \text{diag}(T_{11}, \dots, T_{pp})$ where $T_{jj} \in \mathbb{R}^{m_j \times r_j}$, for $j = 1, \dots, p$. Then

$$\begin{aligned} & \left\| \begin{bmatrix} \mathbf{x}_1 \\ \vdots \\ \mathbf{x}_p \end{bmatrix} - \text{diag}(T_{11}, \dots, T_{pp}) \begin{bmatrix} \mathcal{S}_1(\mathbf{z}_1) \\ \vdots \\ \mathcal{S}_p(\mathbf{z}_p) \end{bmatrix} \right\|_\Omega^2 \\ &= \left\| \begin{bmatrix} \mathbf{x}_1 - \mathcal{P}_1(\mathbf{z}_1) \\ \vdots \\ \mathbf{x}_p - \mathcal{P}_p(\mathbf{z}_p) \end{bmatrix} \right\|_\Omega^2 \\ &= \sum_{j=1}^p \|\mathbf{x}_j - \mathcal{P}_j(\mathbf{z}_j)\|_\Omega^2 \end{aligned} \quad (32)$$

and

$$\min_{P_1 \in \mathcal{R}_{r_1}, \dots, P_p \in \mathcal{R}_{r_p}} \sum_{j=1}^p \|\mathbf{x}_j - \mathcal{P}_j(\mathbf{z}_j)\|_\Omega^2 = \sum_{j=1}^p \min_{P_j \in \mathcal{R}_{r_j}} \|\mathbf{x}_j - \mathcal{P}_j(\mathbf{z}_j)\|_\Omega^2.$$

As a result, in this case, problem (13) is reduced to the problem of finding \mathcal{P}_j that solves

$$\min_{P_j \in \mathcal{R}_{r_j}} \|\mathbf{x}_j - \mathcal{P}_j(\mathbf{z}_j)\|_\Omega^2, \quad (33)$$

for $j = 1, \dots, p$. Its solution is given by [1]

$$\widehat{P}_j = [E_{x_j z_j} (E_{z_j z_j}^\dagger)^{1/2}]_{r_j} (E_{z_j z_j}^\dagger)^{1/2} (I + \widetilde{K} j) \quad (34)$$

where $\widetilde{K} j = \widetilde{M}_j \left(I - L_{E_{z_j z_j}^{1/2}} \right)$ and \widetilde{M}_j is an arbitrary matrix. Then the initial iterations for Algorithm 1 are defined by

$$P_j^{(0)} = \widehat{P}_j, \quad \text{for } j = 1, \dots, p. \quad (35)$$

C. Models of Sensors and Fusion Center

To determine the sensor model B_j in the form (8)–(10), for $j = 1, \dots, p$, and the fusion center model $T = [T_1, \dots, T_p]$ we need to determine $S_{j,0}$, $S_{j,1}$, $S_{j,2}$ such that

$S_j = [S_{j,0}, S_{j,1}, S_{j,2}]$ and T_j , for $j = 1, \dots, p$. Matrices $S_{j,0}$, $S_{j,1}$, $S_{j,2}$ and T_j are evaluated by $S_{j,0}^{(q+1)} \in \mathbb{R}^{r_j}$, $S_{j,1}^{(q+1)} \in \mathbb{R}^{r_j \times (2n_j+1)}$, $S_{j,2}^{(q+1)} \in \mathbb{R}^{r_j \times (2n_j+1)}$ and $T_j^{(q+1)} \in \mathbb{R}^{m \times r_j}$, respectively, as follows. By Algorithm 1, the mathematical model of the second degree WSN is given by

$$\begin{aligned} \mathbf{P}^{(q+1)}(\mathbf{z}) &= \sum_{j=1}^p P_j^{(q+1)}(\mathbf{z}_j) \\ &= \sum_{j=1}^p T_j^{(q+1)} S_j^{(q+1)}(\mathbf{z}_j) \\ &= T^{(q+1)} \begin{pmatrix} S_1^{(q+1)}(\mathbf{z}_1) \\ \vdots \\ S_p^{(q+1)}(\mathbf{z}_p) \end{pmatrix}, \end{aligned} \quad (36)$$

where $\mathbf{P}^{(q+1)} = (P_1^{(q+1)}, \dots, P_p^{(q+1)})$ and $P_j^{(q+1)} = T_j^{(q+1)} S_j^{(q+1)}$. By step 7 of Algorithm 1,

$$P_j^{(q+1)} = \hat{P}_j^{(q+1)} = \left[Q_j^{(q)} R_{G_j} \right]_{r_j} G_j^\dagger (I + K_j)$$

or $P_j^{(q+1)} = P_j^{(0)}$, where $P_j^{(0)}$ is represented by (34)-(35). For the case when $P_j^{(q+1)} = \hat{P}_j^{(q+1)}$, we write

$$U_{r_j} \Sigma_{r_j} V_{r_j}^T = \left[Q_j^{(q)} R_{G_j} \right]_{r_j}, \quad (37)$$

where $U_{r_j} \Sigma_{r_j} V_{r_j}^T$ is the truncated SVD taken with first r_j singular values, $U_{r_j} \in \mathbb{R}^{m \times r_j}$, $\Sigma_{r_j} \in \mathbb{R}^{r_j \times r_j}$ and $V_{r_j}^T \in \mathbb{R}^{r_j \times (2n_j+1)}$. Then

$$T_j^{(q+1)} = U_{r_j} \quad \text{or} \quad T_j^{(q+1)} = U_{r_j} \Sigma_{r_j} \quad (38)$$

where $T_j^{(q+1)} \in \mathbb{R}^{m \times r_j}$ and $T_j^{(q+1)} \in \mathbb{R}^{m \times r_j}$, and

$$S_j^{(q+1)} = \Sigma_{r_j} V_{r_j}^T G_j^\dagger (I + K_j) \quad \text{or} \quad S_j^{(q+1)} = V_{r_j}^T G_j^\dagger (I + K_j), \quad (39)$$

respectively, where $S_j^{(q+1)} \in \mathbb{R}^{r_j \times (2n_j+1)}$. Here, $S_j^{(q+1)} = [S_{j,0}^{(q+1)}, S_{j,1}^{(q+1)}, S_{j,2}^{(q+1)}]$.

As a result, for the j th sensor model represented by (8)–(10), $S_{j,0}$, $S_{j,1}$ and $S_{j,2}$ are given by $S_{j,0}^{(q+1)}$, $S_{j,1}^{(q+1)}$ and $S_{j,2}^{(q+1)}$, respectively, which are determined from (39) as blocks of matrix $S_j^{(q+1)}$. The fusion center model is given by $T^{(q+1)} = [T_1^{(q+1)}, \dots, T_p^{(q+1)}]$ where $T_j^{(q+1)}$, for $j = 1, \dots, p$, is determined by (38).

For the case when $P_j^{(q+1)} = P_j^{(0)}$, where $P_j^{(0)}$ is represented by (34)-(35), matrices T_j , $S_{j,0}$, $S_{j,1}$ and $S_{j,2}$ are evaluated similar to matrices $T_j^{(q+1)}$, $S_{j,0}^{(q+1)}$, $S_{j,1}^{(q+1)}$ and $S_{j,2}^{(q+1)}$ in (38) and (39), respectively. In this case, in (37), $\left[Q_j^{(q)} R_{G_j} \right]_{r_j}$ should be replaced with $\left[E_{x_j z_j} (E_{z_j z_j}^\dagger)^{1/2} \right]_{r_j}$ and in (39), $G_j^\dagger (I + K_j)$ should be replaced with $(E_{z_j z_j}^\dagger)^{1/2} (I + \tilde{K}_j)$.

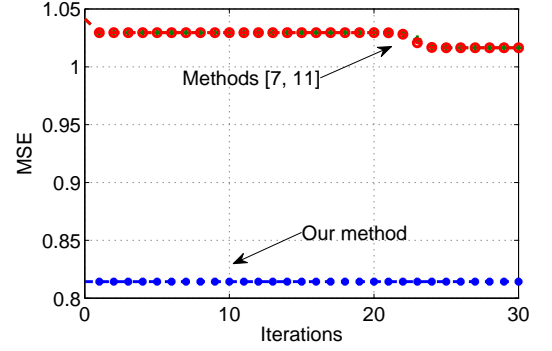

(a) Example 1

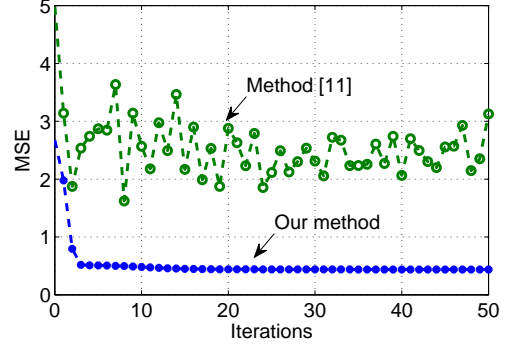

(b) Example 2

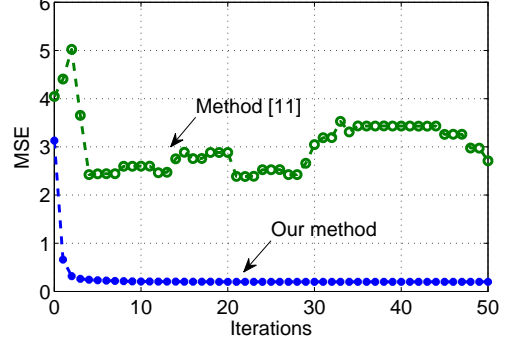

(c) Example 2

Fig. 2. Diagrams of MSEs associated with our method and methods [7], [11]. In Fig. (a), MSEs associated with methods [7], [11] coincide.

IV. NUMERICAL RESULTS AND COMPARISONS

We wish to illustrate the advantages of the proposed methodology by numerical examples where a comparison with known methods [7], [8], [9], [10], [11], [34] is provided. The method [11] represents a generalization of methods [8], [9], [10] and therefore, we provide a numerical comparison with method [11] which includes, in fact, a comparison with methods [8], [9], [10] as well. Further, covariance matrices used in the simulations associated with Figs. 2 (b) and (c) are singular, and therefore, method [7] is not applicable (some more associated

observations have been given at the end of Section I-B). Therefore, in Figs. 2 (b) and (c), results related to algorithm in [7] are not given.

For the same reason, the method presented in [34] is not applicable as well. Moreover, the method in [34] is restricted to the case when the covariance matrix formed by the noise vector is block diagonal. This is not the case here.

In the examples below, different types of noisy observed signals and different compression ratios are considered. In all examples, our method provides the better associated accuracy than that for the methods in [7], [11] (and methods in [8], [9], [10] as well, because they follow from [11]).

Example 1: Suppose that the source signal $\mathbf{x} \in L^2(\Omega, \mathbb{R}^3)$ is a Gaussian random vector with mean zero and covariance matrix $E_{xx} = \begin{bmatrix} 1 & 0.64 & 0.08 \\ 0.64 & 1 & 0.08 \\ 0.08 & 0.08 & 1 \end{bmatrix}$. The observed vectors

\mathbf{y}_1 and \mathbf{y}_2 are noisy version of \mathbf{x} , i.e., $\mathbf{y}_1 = \mathbf{x} + \boldsymbol{\xi}_1$ and $\mathbf{y}_2 = \mathbf{x} + \boldsymbol{\xi}_2$, where $\boldsymbol{\xi}_1$ and $\boldsymbol{\xi}_2$ are Gaussian random vectors with mean zero and covariance matrices $E_{\xi_1, \xi_1} = \sigma_1^2 I$ and $E_{\xi_2, \xi_2} = \sigma_2^2 I$, for $j = 1, 2$. The vectors \mathbf{x} , $\boldsymbol{\xi}_1$ and $\boldsymbol{\xi}_2$ are assumed to be independent. Then $E_{xy} = [E_{xx} \ E_{xx}]$ and $E_{yy} = \begin{bmatrix} E_{y_1 y_1} & E_{y_1 y_2} \\ E_{y_2 y_1} & E_{y_2 y_2} \end{bmatrix} = \begin{bmatrix} E_{xx} + E_{\xi_1 \xi_1} & E_{xx} \\ E_{xx} & E_{xx} + E_{\xi_2 \xi_2} \end{bmatrix}$. For the sake of simplicity, in (11)–(12), we choose $\mathcal{S}_{1,0} = \mathcal{S}_{2,0} = \mathbb{O}$. Therefore, $\mathbf{z}_j = \begin{bmatrix} \mathbf{y}_j \\ \mathbf{y}_j^2 \end{bmatrix}$, for $j = 1, 2$, and as before

(see Definition 1), $\mathbf{z} = [\mathbf{z}_1^T, \mathbf{z}_2^T]^T$, i.e. $\mathbf{z} = \begin{bmatrix} \mathbf{y}_1 \\ \mathbf{y}_1^2 \\ \mathbf{y}_2 \\ \mathbf{y}_2^2 \end{bmatrix} =$

$\begin{bmatrix} \mathbf{x} + \boldsymbol{\xi}_1 \\ (\mathbf{x} + \boldsymbol{\xi}_1)^2 \\ \mathbf{x} + \boldsymbol{\xi}_2 \\ (\mathbf{x} + \boldsymbol{\xi}_2)^2 \end{bmatrix} = \begin{bmatrix} \mathbf{x} + \boldsymbol{\xi}_1 \\ \mathbf{x}^2 + \boldsymbol{\xi}_1^2 \\ \mathbf{x} + \boldsymbol{\xi}_2 \\ \mathbf{x}^2 + \boldsymbol{\xi}_2^2 \end{bmatrix}$, because \mathbf{x} , $\boldsymbol{\xi}_1$ and $\boldsymbol{\xi}_2$ are

independent. Matrices E_{xz} and E_{zz} are evaluated as follows. For a random variable a with the probability density function $f_a(u) = \frac{1}{\sqrt{2\pi}} \exp\left(-\frac{u^2}{2\sigma_a^2}\right)$, associated covariances are given by $E_{aa} = \sigma^2$ and $E_{a^2 a^2} = 2\sigma^4$. Here, σ^2 is variance.

For random variables a and b with the joint probability density function $f_{a,b}(u, v) = \frac{1}{2\pi\sqrt{1-\rho_{a,b}^2}} \exp\left(-\frac{u^2 - 2\rho_{a,b}uv + v^2}{2(1-\rho_{a,b}^2)}\right)$,

associated covariances are given by $E_{ab} = \rho_{a,b}$, $E_{a^2 b} = E_{ab^2} = 0$, $E_{a^2 b^2} = 2\rho_{a,b}^2$ and $E_{a^2 a} = E_{aa^2} = 0$, where $\rho_{a,b}$ is the correlation parameter. Then $E_{x^2 x^2} =$

$\begin{bmatrix} 2 & 0.8192 & 0.0128 \\ 0.8192 & 2 & 0.0128 \\ 0.0128 & 0.0128 & 2 \end{bmatrix}$, $E_{\xi_1^2 \xi_1^2} = 2\sigma_1^4 I$, $E_{\xi_2^2 \xi_2^2} =$

$2\sigma_2^4 I$, $E_{xz} = [E_{xy} \ E_{xy^2}] = [E_{xy_1} \ E_{xy_2} \ E_{xy_1^2} \ E_{xy_2^2}] =$

$[E_{xx} \ E_{xx} \ \mathbb{O} \ \mathbb{O}]$ and E_{zz} is given in (40). On this basis, Algorithm 1 produces the associated errors that were evaluated by (31), for different σ_j and r_j with $j = 1, 2$. The errors associated with methods [7], [11] were estimated in a similar way. A typical example of the errors, for $\sigma_1 = 0.9$, $\sigma_2 = 0.65$ and $r_1 = r_2 = 1$, is represented in Fig. 2 (a).

Example 2: Here, it is supposed that covariance matrices E_{xx} , E_{xy} and E_{yy} are known from a training phase. We

assume that, for $j = 1, \dots, p$, noisy observations are such that $\mathbf{y}_j = \mathcal{A}_j \mathbf{x} + \beta_j \boldsymbol{\xi}_j$, where $\mathcal{A}_j : L^2(\Omega, \mathbb{R}^m) \rightarrow L^2(\Omega, \mathbb{R}^m)$ is a linear operator defined by matrix $A_j \in \mathbb{R}^{m \times m}$ with uniformly distributed random entries, \mathbf{x} is a random vector with uniform distribution, $\beta_j \in \mathbb{R}$ and $\boldsymbol{\xi}_j$ is noise represented by a Gaussian random vector with mean zero.

The errors associated with the proposed method and the method in [11], for the case of two and three sensors (i.e., for $p = 2$ and $p = 3$, respectively), and different choices of m, n_j and r_j , for $j = 1, 2$ and $j = 1, 2, 3$, are represented in Figs. 2 (b) and (c). Method [7] is not applicable since covariance matrices used in these simulations are singular. Note that method [11] is not numerically stable in these simulations. We believe this is because of the reason mentioned in Section I-B.

Example 3: Here, we wish to illustrate the obtained theoretical results in a more conspicuous and different way than that in the above examples. To this end, we use training signals themselves, not only covariance matrices as before. In this example, training reference signal \mathbf{x} is simulated by its realizations, i.e. by matrix $\mathbf{X} \in \mathbb{R}^{m \times k}$ where each column represents a realization of the signal. To represent the obtained results in a visible way, signal $\mathbf{X} \in \mathbb{R}^{m \times k}$ is chosen as the known image ‘Cameraman’ given by the 256×256 matrix – see Fig. 3 (a), i.e. with $m, k = 256$. Then $X \in \mathbb{R}^{256 \times 128}$. A sample $X \in \mathbb{R}^{m \times s}$ with $s < k$ is formed from \mathbf{X} by choosing the even columns, i.e. $s = 128$.

Further, we consider the WSN with two sensors, i.e. with $p = 2$, where the observed signal \mathbf{Y}_j , for $j = 1, 2$, is simulated as $\mathbf{Y}_j = A_j * \mathbf{X} + \beta_j \mathcal{Y}_j$, where $A_j \in \mathbb{R}^{256 \times 256}$ and $\mathcal{Y}_j \in \mathbb{R}^{256 \times 256}$ have random entries, chosen from a normal distribution with mean zero and variance one, $A_j * X$ represents the Hadamard matrix product and $\beta_1 = 0.2$ and $\beta_2 = 0.1$.

For $r_1 = r_2 = 128$, the simulation results are represented in Figs. 3 and 4. Our method and methods from [7] and [11] have been applied to the above signals with 50 iterations each. The associated errors are evaluated in the form $\|\mathbf{X}(i) - \hat{\mathbf{X}}(i)\|_2^2$, for $i = 1, \dots, 256$, where $\hat{\mathbf{X}}$ is the reconstruction of \mathbf{X} by the method we use (i.e. by our method or methods in [7] and [11]), and $\mathbf{X}(i)$ and $\hat{\mathbf{X}}(i)$ are i th columns of matrices \mathbf{X} and $\hat{\mathbf{X}}$, respectively.

Method [7] has only been developed in terms of the inverses of certain covariance matrices. In this example, the covariance matrices are singular. Consequently, the estimate by method [7] has the form represented in Fig. 3 (f). Due to singularity of covariance matrices, the error associated with method [7] is very large. Therefore, those results are not included in Fig. 4.

Method [7] was applied in terms of pseudo-inverse matrices as it suggested in the section ‘‘Appendix I’’ of [7]. Nevertheless, the associated estimate (see Fig. 3 (e)) is still not so accurate as that by the proposed method. As mentioned in Example 2, it might be, in particular, because of the reason considered in Section I-B.

Similar to the other examples, Figs. 3 and 4 demonstrate a more accurate signal reconstruction associated with the proposed method than those associated with previous methods.

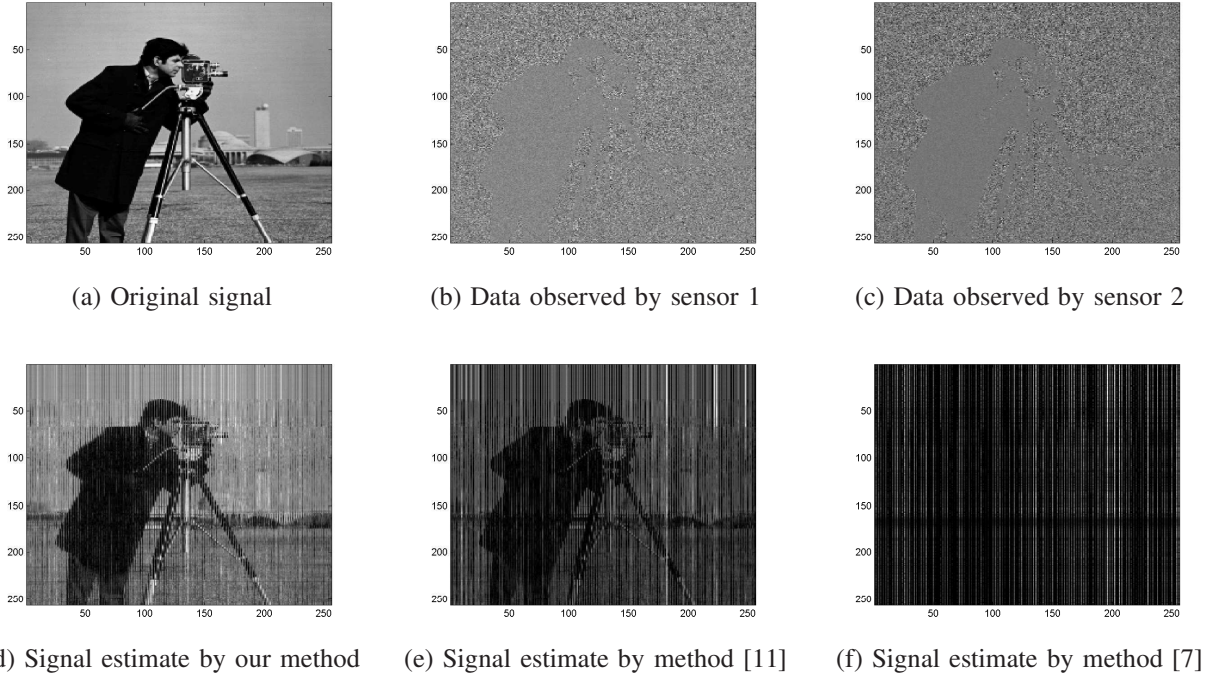

Fig. 3. Illustration to Example 3.

$$\begin{aligned}
E_{zz} &= \begin{bmatrix} E_{yy} & E_{yy^2} \\ E_{y^2y} & E_{y^2y^2} \end{bmatrix} \\
&= \begin{bmatrix} E_{y_1y_1} & E_{y_1y_2} & E_{y_1y_1^2} & E_{y_1y_2^2} \\ E_{y_2y_1} & E_{y_2y_2} & E_{y_2y_1^2} & E_{y_2y_2^2} \\ E_{y_1^2y_1} & E_{y_1^2y_2} & E_{y_1^2y_1^2} & E_{y_1^2y_2^2} \\ E_{y_2^2y_1} & E_{y_2^2y_2} & E_{y_2^2y_1^2} & E_{y_2^2y_2^2} \end{bmatrix} \\
&= \begin{bmatrix} E_{xx} + E_{\xi_1\xi_1} & E_{xx} & \circ & \circ \\ E_{xx} & E_{xx} + E_{\xi_2\xi_2} & \circ & \circ \\ \circ & \circ & E_{x^2x^2} + E_{\xi_1^2\xi_1^2} & E_{x^2x^2} \\ \circ & \circ & E_{x^2x^2} & E_{x^2x^2} + E_{\xi_2^2\xi_2^2} \end{bmatrix}.
\end{aligned} \tag{40}$$

V. SECOND DEGREE WSN WITH NONIDEAL CHANNELS

In the above sections, we dealt with the WSN model with ideal links between the sensors and the fusion center. Here, we consider nonideal channels which comprise multiplicative signal fading and additive noise. These effects are modeled by operators $\mathcal{N}_j : L^2(\Omega, \mathbb{R}^{r_j}) \rightarrow L^2(\Omega, \mathbb{R}^{r_j})$, for $j = 1, \dots, p$, which are depicted in Fig. 1 (a). Each \mathcal{N}_j is such that $\mathcal{N}_j(\mathbf{u}_j) = \mathcal{D}_j(\mathbf{u}_j) + \boldsymbol{\eta}_j$ where the channel linear operator \mathcal{D}_j and $\boldsymbol{\eta} \in L^2(\Omega, \mathbb{R}^{r_j})$ is random noise with zero mean which is uncorrelated with \mathbf{x} , \mathbf{y}_j , \mathcal{D}_j and across the channels, i.e., $E_{\eta_i\eta_j} = \circ$ for $i \neq j$. Operator \mathcal{D}_j is represented by matrix $D_j \in \mathbb{R}^{r_j \times r_j}$ similar, in particular, to \mathcal{B}_j in (2). Matrices D_j and $E_{\eta_j\eta_j}$, for $j = 1, \dots, p$, are available at the fusion center. As in [7] it is assumed that channel matrix D_j and matrices $E_{\eta_j\eta_j}$ can be acquired similar to covariances E_{xy} and E_{yy} . At the same time, unlike [7] here, it is not required that D_j and $E_{\eta_j\eta_j}$ are necessarily invertible.

In the case of nonideal channels, we deal with the problem as follows. Find models of the sensors $\mathcal{B}_1, \dots, \mathcal{B}_p$ and the fusion center $\mathcal{T} = [\mathcal{T}_1, \dots, \mathcal{T}_p]$ that solve

$$\min_{\substack{\mathcal{T}_1, \dots, \mathcal{T}_p, \\ \mathcal{B}_1, \dots, \mathcal{B}_p}} \left\| \mathbf{x} - \sum_{j=1}^p \mathcal{T}_j [\mathcal{D}_j \mathcal{B}_j(\mathbf{y}_j) + \boldsymbol{\eta}_j] \right\|_{\Omega}^2. \tag{41}$$

On the basis of (9), the above can equivalently be represented as the problem of finding $\mathcal{S}_1, \dots, \mathcal{S}_p$ and $\mathcal{T}_1, \dots, \mathcal{T}_p$ that solve

$$\min_{\substack{\mathcal{T}_1, \dots, \mathcal{T}_p, \\ \mathcal{S}_1, \dots, \mathcal{S}_p}} \left\| \mathbf{x} - \sum_{j=1}^p \mathcal{T}_j [\mathcal{D}_j \mathcal{S}_j(\mathbf{z}_j) + \boldsymbol{\eta}_j] \right\|_{\Omega}^2. \tag{42}$$

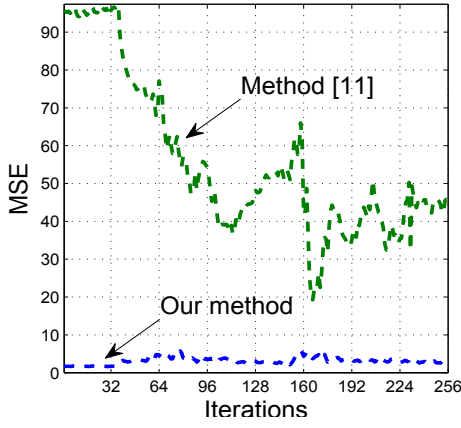

Fig. 4. Example 3: Diagrams of MSEs associated with our method and method [11]. MSE associated with method [7] is very large and, therefore, it is not given here.

A. Greedy Method for Solution of Problem (42)

An exact solution to problem (42) is unknown. By this reason, we apply a greedy approach to (42) in the form of an iterative procedure. At each iteration, the idea of the MBI method is combined with the optimal solutions to two pertinent minimization problems, so that one solution determines the optimal model of the sensor and another solution determines the optimal model of the fusion center. By this reason, it is called the alternating iterative (AI) procedure.

First, in Section V-A1, we provide the solutions to the minimization problems used in the AI procedure. In Section V-A2, a detailed description of the steps used at each iteration of the AI procedure is provided. Then the AI procedure itself is considered in Section V-A3.

1) *Preliminaries for AI Procedure:* Let us denote

$$\psi(\mathbf{P}) = \left\| \mathbf{x} - \sum_{j=1}^p \mathcal{T}_j [\mathcal{D}_j \mathcal{S}_j(\mathbf{z}_j) + \boldsymbol{\eta}_j] \right\|_{\Omega}^2$$

where $\mathbf{P} = (T_1, \dots, T_p, S_1, \dots, S_p)$.

Theorem 4: Let $\mathbf{w}_j = \mathcal{D}_j \mathcal{S}_j(\mathbf{z}_j) + \boldsymbol{\eta}_j$, for $j = 1, \dots, p$, and $\mathbf{w} = [\mathbf{w}_1^T, \dots, \mathbf{w}_p^T]^T$. Let $K = M(I - L_{E_{\mathbf{w}\mathbf{w}}})$ where M be an arbitrary matrix. For given S_1, \dots, S_p , optimal matrix T minimizing $\psi(\mathbf{P})$ is given by

$$T = E_{\mathbf{x}\mathbf{w}} E_{\mathbf{w}\mathbf{w}}^{\dagger} (I + K). \quad (43)$$

The associated error is represented by

$$\min_T \psi(\mathbf{P}) = \|E_{\mathbf{x}\mathbf{x}}^{1/2}\|^2 - \|E_{\mathbf{x}\mathbf{w}} (E_{\mathbf{w}\mathbf{w}}^{1/2})^{\dagger}\|^2. \quad (44)$$

Proof: It follows that $\psi(\mathbf{P})$ can be represented as

$$\psi(\mathbf{P}) = \|\mathbf{x} - T\mathbf{w}\|_{\Omega}^2. \quad (45)$$

Then (43) and (44) follow from [5]. If given matrices S_1, \dots, S_p are optimal in the sense of minimizing $\psi(\mathbf{P})$ then Theorem 4 returns the globally optimal solution of (42). ■

Theorem 5: Let $\mathbf{x}_{(j)} = \mathbf{x} - \sum_{\substack{i=1 \\ i \neq j}}^p \mathcal{T}_i [\mathcal{D}_i \mathcal{S}_i(\mathbf{z}_i) + \boldsymbol{\eta}_i]$. For

given T and $\{S_i\}_{i=1, i \neq j}^p$, optimal matrix S_j minimizing $\|\mathbf{x}_{(j)} - \mathcal{T}_j \mathcal{D}_j S_j(\mathbf{z}_j)\|_{\Omega}^2$ is given by

$$S_j = (T_j D_j)^{\dagger} E_{\mathbf{x}_{(j)} \mathbf{z}_j} E_{\mathbf{z}_j \mathbf{z}_j}^{\dagger} (I + K_j), \quad (46)$$

where $K_j = M_j(I - L_{E_{\mathbf{z}_j \mathbf{z}_j}})$ and M_j is arbitrary. The associated error is represented by

$$\begin{aligned} & \min_{S_j} \|\mathbf{x}_{(j)} - \mathcal{T}_j \mathcal{D}_j S_j(\mathbf{z}_j)\|_{\Omega}^2 \\ &= \left\| E_{\mathbf{x}_{(j)} \mathbf{x}_{(j)}}^{1/2} \right\|^2 - \left\| E_{\mathbf{x}_{(j)} \mathbf{z}_j} (E_{\mathbf{z}_j \mathbf{z}_j}^{\dagger})^{1/2} \right\|^2 \\ & \quad + \left\| E_{\mathbf{x}_{(j)} \mathbf{z}_j} E_{\mathbf{z}_j \mathbf{z}_j}^{1/2 \dagger} [I - T_j D_j (T_j D_j)^{\dagger}] \right\|^2. \end{aligned} \quad (47)$$

Proof: We write

$$\begin{aligned} & \left\| \mathbf{x} - \sum_{j=1}^p \mathcal{T}_j [\mathcal{D}_j \mathcal{S}_j(\mathbf{z}_j) + \boldsymbol{\eta}_j] \right\|_{\Omega}^2 \\ &= \left\| \mathbf{x}_{(j)} - \mathcal{T}_j \mathcal{D}_j S_j(\mathbf{z}_j) \right\|_{\Omega}^2 \\ &= \left\| E_{\mathbf{x}_{(j)} \mathbf{x}_{(j)}}^{1/2} \right\|^2 - \left\| E_{\mathbf{x}_{(j)} \mathbf{z}_j} (E_{\mathbf{z}_j \mathbf{z}_j}^{\dagger})^{1/2} \right\|^2 \\ & \quad + \left\| E_{\mathbf{x}_{(j)} \mathbf{z}_j} E_{\mathbf{z}_j \mathbf{z}_j}^{1/2 \dagger} - T_j D_j S_j E_{\mathbf{z}_j \mathbf{z}_j}^{1/2} \right\|^2. \end{aligned} \quad (48)$$

By [5], S_j in (46) minimizes $\left\| E_{\mathbf{x}_{(j)} \mathbf{z}_j} E_{\mathbf{z}_j \mathbf{z}_j}^{1/2 \dagger} - T_j D_j S_j E_{\mathbf{z}_j \mathbf{z}_j}^{1/2} \right\|^2$ and hence, minimizes

$$\left\| \mathbf{x}_{(j)} - \mathcal{T}_j \mathcal{D}_j S_j(\mathbf{z}_j) \right\|_{\Omega}^2.$$

The error representation in (47) follows from (46) and (48).

Note that if given matrices T and $\{S_i\}_{i=1, i \neq j}^p$ are optimal in the sense of minimizing $\psi(\mathbf{P})$ then Theorem 5 returns the globally optimal solution of (42). ■

2) *Description of Steps in AI Procedure:* Before describing the AI procedure in Section V-A3 that follows, here we describe the steps made at its each iteration. The steps are based on Theorems 4 and 5 provided above.

1st step. Given $T^{(0)}, S_1^{(0)}, \dots, S_p^{(0)}$, compute

$$T^{(1)} = E_{\mathbf{x}\mathbf{w}^{(0)}} E_{\mathbf{w}^{(0)} \mathbf{w}^{(0)}}^{\dagger} (I + K^{(1)}). \quad (49)$$

Here, $E_{\mathbf{x}\mathbf{w}^{(0)}} = [E_{\mathbf{x}\mathbf{w}_1^{(0)}}, \dots, E_{\mathbf{x}\mathbf{w}_p^{(0)}}]$ and $E_{\mathbf{w}^{(0)} \mathbf{w}^{(0)}} = \{E_{\mathbf{w}_i^{(0)} \mathbf{w}_j^{(0)}}\}_{i,j=1}^p$, where, for $j = 1, \dots, p$,

$$\begin{aligned} E_{\mathbf{x}\mathbf{w}_j^{(0)}} &= E_{\mathbf{x}\mathbf{z}_j} (S_j^{(0)})^T D_j^T, \\ E_{\mathbf{w}_i^{(0)} \mathbf{w}_j^{(0)}} &= D_i S_i^{(0)} E_{\mathbf{z}_i \mathbf{z}_j} (S_j^{(0)})^T D_j^T + E_{\boldsymbol{\eta}_i \boldsymbol{\eta}_j}, \\ K^{(1)} &= M^{(1)} (I - L_{E_{\mathbf{w}^{(0)} \mathbf{w}^{(0)}}}) \end{aligned} \quad (50)$$

where $M^{(1)}$ is an arbitrary matrix. Then $T_1^{(1)}, \dots, T_p^{(1)}$ are determined as blocks of matrix $T^{(1)} = [T_1^{(1)}, \dots, T_p^{(1)}]$ given by (49).

2nd step. Given $\{T_1^{(1)}\}_{j=1}^p$ and $\{S_i^{(0)}\}_{i=1, i \neq j}^p$, compute, for $j = 1, \dots, p$,

$$\widehat{S}_j^{(1)} = (T_j^{(1)} D_j)^\dagger E_{x_{(j,0)} z_j} E_{z_j z_j}^\dagger (I + K_j) \quad (51)$$

where

$$E_{x_{(j,0)} z_j} = E_{x z_j} - \sum_{\substack{i=1 \\ i \neq j}}^p T_i^{(1)} D_i S_i^{(0)} E_{z_i z_j}, \quad (52)$$

$$K_j = M_j (I - L E_{z_j z_j}), \quad (53)$$

where M_j is arbitrary. Note that (49) and (51) are evaluated on the basis of (43) and (46), respectively.

3rd step. Denote

$$\overline{\mathbf{P}}_j^{(1)} = \left(T_1^{(1)}, \dots, T_p^{(1)}, S_1^{(0)}, \dots, S_{j-1}^{(0)}, \widehat{S}_j^{(1)}, S_{j+1}^{(0)}, \dots, S_p^{(0)} \right), \quad (54)$$

set $S_j^{(1)} := \widehat{S}_j^{(1)}$ and select $\overline{\mathbf{P}}_k^{(1)}$, for $k = 1, \dots, p$, such that $\psi(\overline{\mathbf{P}}_k^{(1)})$ is minimal among all $\psi(\overline{\mathbf{P}}_1^{(1)}), \dots, \psi(\overline{\mathbf{P}}_p^{(1)})$, i.e.,

$$\overline{\mathbf{P}}_k^{(1)} = \arg \min_{\overline{\mathbf{P}}_1^{(1)}, \dots, \overline{\mathbf{P}}_p^{(1)}} \left\{ \psi(\overline{\mathbf{P}}_1^{(1)}), \dots, \psi(\overline{\mathbf{P}}_k^{(1)}), \dots, \psi(\overline{\mathbf{P}}_p^{(1)}) \right\}. \quad (55)$$

Then write

$$\mathbf{P}^{(1)} := \overline{\mathbf{P}}_k^{(1)} \quad (56)$$

and denote $\mathbf{P}^{(1)} = (P_1^{(1)}, \dots, P_p^{(1)}) \in \mathbb{R}_{r_1, \dots, r_p}$. Then we repeat steps (49)–(56) with the replacement of $T^{(0)}, S_1^{(0)}, \dots, S_p^{(0)}$ by $T^{(1)}, S_1^{(1)}, \dots, S_p^{(1)}$ as follows. Compute

$$T^{(2)} = E_{x w^{(1)}} E_{w^{(1)} w^{(1)}}^\dagger (I + K^{(2)}),$$

where $E_{x w^{(1)}}$ and $E_{w^{(1)} w^{(1)}}$ are evaluated similar to (50) with subscript (0) replaced by subscript (1). Then similar to (51) compute

$$\widehat{S}_j^{(2)} = (T_j^{(2)} D_j)^\dagger E_{x_{(j,1)} z_j} E_{z_j z_j}^\dagger (I + K_j) \quad (57)$$

where $E_{x_{(j,1)} z_j} = E_{x z_j} - \sum_{\substack{i=1 \\ i \neq j}}^p T_i^{(2)} D_i S_i^{(1)} E_{z_i z_j}$ and continue

the computation with other pertinent replacement in the superscripts as it is represented in Algorithm 2 that follows.

3) *Algorithm for AI Procedure:* It follows from (45) that the cost function can be written as

$$\psi(\mathbf{P}) = \left\| E_{xx}^{1/2} \right\|^2 - \left\| E_{xw} (E_{ww}^{1/2})^\dagger \right\|^2 + \left\| E_{xw} (E_{ww}^{1/2})^\dagger - T E_{ww}^{1/2} \right\|^2. \quad (58)$$

The process described above is summarized in Algorithm 2.

On line 17, $\psi(\mathbf{P}^{(q+1)})$ is evaluated by (58) with the replacement of $E_{xw_j}, E_{w_i w_j}, T$ with $E_{x w_j^{(q)}}, E_{w_i^{(q)} w_j^{(q)}}, T^{(q+1)}$, respectively, which have been computed in lines 2 and 3.

Sequence $\{\mathbf{P}^{(q+1)}\}$ in Algorithm 2 converges to a

Algorithm 2: Greedy approach to problem (42): AI procedure

Initialization: $T^{(0)}, S_1^{(0)}, \dots, S_p^{(0)}, D_1, \dots, D_p$ and $\epsilon > 0$.

1. **for** $q = 0, 1, 2, \dots$
 2. $E_{x w_j^{(q)}} = E_{x z_j} (S_j^{(q)})^T D_j^T$
 3. $E_{w_i^{(q)} w_j^{(q)}} = D_i S_i^{(q)} E_{z_i z_j} (S_j^{(q)})^T D_j^T + E_{\eta_i \eta_j}$
 4. $T^{(q+1)} = E_{x w^{(q)}} E_{w^{(q)} w^{(q)}}^\dagger (I + K^{(q+1)})$
 5. $T_1^{(q+1)} = T^{(q+1)}(:, 1 : r_1)$
 6. **for** $j = 2, 3, \dots, p$
 7. $k_j = \sum_{i=1}^j r_i$
 8. $T_j^{(q+1)} = T^{(q+1)}(:, r_{j-1} + 1 : k_j)$
 9. **end**
 10. $\overline{\mathbf{P}}_0^{(q+1)} = (T_1^{(q+1)}, \dots, T_p^{(q+1)}, S_1^{(q)}, \dots, S_p^{(q)})$
 11. **for** $j = 1, 2, \dots, p$
 12. $E_{x_{(j,q)} z_j} = E_{x z_j} - \sum_{\substack{i=1 \\ i \neq j}}^p T_i^{(q+1)} D_i S_i^{(q)} E_{z_i z_j}$
 13. $\widehat{S}_j^{(q+1)} = (T_j^{(q+1)} D_j)^\dagger E_{x_{(j,q)} z_j} E_{z_j z_j}^\dagger (I + K_j)$,
 14. $\overline{\mathbf{P}}_j^{(q+1)} = (T^{(q)}, S_1^{(q)}, \dots, S_{j-1}^{(q)}, \widehat{S}_j^{(q+1)}, S_{j+1}^{(q)}, \dots, S_p^{(q)})$
 15. $S_j^{(q+1)} = \widehat{S}_j^{(q+1)}$
 16. **end**
 17. Choose $\overline{\mathbf{P}}_k^{(q+1)}$ such that
 18. $\overline{\mathbf{P}}_k^{(q+1)} = \arg \min_{\overline{\mathbf{P}}_1^{(q+1)}, \dots, \overline{\mathbf{P}}_p^{(q+1)}} \left\{ \psi(\overline{\mathbf{P}}_0^{(q+1)}), \dots, \psi(\overline{\mathbf{P}}_p^{(q+1)}) \right\}$
 19. Set $\mathbf{P}^{(q+1)} := \overline{\mathbf{P}}_k^{(q+1)}$ where
 20. $\mathbf{P}^{(q+1)} = (T^{(q)}, S_1^{(q)}, \dots, S_p^{(q)})$
 21. **If** $|\psi(\mathbf{P}^{(q+1)}) - \psi(\mathbf{P}^{(q)})| \leq \epsilon$
 22. **Stop**
 23. **end**
-

coordinate-wise minimum point of $\psi(\mathbf{P})$ which is a local minimum. Section X-D provides more associated details.

Similar to Algorithm 1, in a training stage, it is convenient to use the error representation given in Theorem 6 where $\mathbf{P}^{(q+1)}$ should be understood as that determined by Algorithm 2.

B. Algorithm 2: Determination of $T^{(0)}, S_1^{(0)}, \dots, S_p^{(0)}$

To start Algorithm 2, matrices $T^{(0)}, S_1^{(0)}, \dots, S_p^{(0)}$ should be known. They can be determined by the procedure detailed in Section III-C for the case of the ideal channels. That is, for Algorithm 2, $T^{(0)}$ is determined as $T^{(q+1)} = [T_1^{(q+1)}, \dots, T_p^{(q+1)}]$ where $T_j^{(q+1)}$, for $j = 1, \dots, p$, is given by (38). For $j = 1, \dots, p$, matrix $S_j^{(0)}$, for Algorithm 2, is determined as $S_j^{(q+1)}$ by (39).

C. Models of Sensors and Fusion Center by Algorithm 2

By (8)–(10), the sensor model B_j is defined by matrix $S_j = [S_{j,0}, S_{j,1}, S_{j,2}]$. Matrix S_j is evaluated as $S_j^{(q+1)}$

at line 14. Since $S_j^{(q+1)}$ can be written as $S_j^{(q+1)} = [S_{j,0}^{(q+1)}, S_{j,1}^{(q+1)}, S_{j,2}^{(q+1)}]$ where $S_{j,k}^{(q+1)}$ is a block of $S_j^{(q+1)}$, for $k = 0, 1, 2$, then $S_{j,0}, S_{j,1}, S_{j,2}$ are evaluated as $S_{j,0}^{(q+1)}, S_{j,1}^{(q+1)}, S_{j,2}^{(q+1)}$.

The fusion center $T = [T_1, \dots, T_p]$ is evaluated as $T^{(q+1)} = [T_1^{(q+1)}, \dots, T_p^{(q+1)}]$ where $T_j^{(q+1)}$, for $j = 1, \dots, p$, is computed on the lines from 3 to 7.

VI. NUMERICAL RESULTS AND COMPARISON

Here, we illustrate the performance of the proposed approach with numerical modeling of the second degree WSN with two sensors and nonideal channels.

Example 4: Suppose that source signal $\mathbf{x} \in L^2(\Omega, \mathbb{R}^4)$ is a Gaussian random vector with mean zero and covariance matrix

$$E_{xx} = \begin{bmatrix} 1.000 & 0.580 & 0.275 & 0.450 \\ 0.580 & 1.000 & 0.295 & 0.540 \\ 0.275 & 0.295 & 1.000 & 0.215 \\ 0.450 & 0.540 & 0.215 & 1.000 \end{bmatrix}.$$

Observed signals \mathbf{y}_1 and \mathbf{y}_2 are noisy versions of \mathbf{x} such that $\mathbf{y}_j = \mathbf{x} + \delta_j^2 \xi_j$, $\delta_j \in \mathbb{R}$, for $j = 1, 2$, where ξ_1 and ξ_2 are Gaussian random vector with mean zero and covariance matrices $E_{\xi_i \xi_i} = \delta_j^2 I$, for $j = 1, 2$. The vectors \mathbf{x} , ξ_1 and ξ_2 are independent. Channel matrices are $D_1 = \begin{pmatrix} 6 & 6 \\ 2 & 8 \end{pmatrix}$ and

$D_2 = \begin{pmatrix} 0 & 5 \\ 0 & 5 \end{pmatrix}$. Note D_2 is singular, i.e., method in [7] is not applicable here. Suppose the channel noise η_j is white, for $j = 1, 2$, i.e., $E_{\eta_j \eta_j} = \gamma_j^2 I$.

The diagrams of the MSE, given in Fig. 5, for $r_1 = r_2 = 2$, $\delta_1 = 0.7$, $\delta_2 = 0.8$, $\gamma_1 = 0.6$, $\gamma_2 = 0.5$, demonstrate the advantage of the second degree model over its particular case, the linear model.

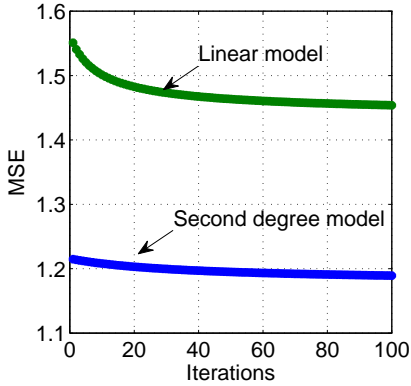

Fig. 5. Diagrams of the MSE for the WSNs with nonideal channels.

VII. CONCLUSION

We have addressed the problem of multi-compression and recovery of an unknown source stochastic signal when the

signal cannot be observed centrally. In the mean square estimation framework, this means finding the optimal signal representation which minimizes the associated error. This scenario is based on multiple noisy signal observations made by distributed sensors. Each sensor compresses the observation and then transmits the compressed signal to the fusion center that decompresses the signals in such a way that the original signal is estimated within a prescribed accuracy. By known techniques, models of the sensors and the fusion center have been developed from optimal *linear* transforms and therefore, the associated errors cannot be improved by any other linear transform with the same rank. At the same time, in some problems, the performance of the known techniques may not be as good as required.

In this paper, we developed a new method for the determination of models of the sensors and the fusion center. The contribution and advantages are as follows. First, the proposed approach is based on the *non-linear* second degree transform (SDT) [1]. The special condition has been established under which the proposed methodology may lead to the higher accuracy of signal estimation compared to known methods based on linear signal transforms. Second, the SDT is combined with the maximum block improvement (MBI) method [2], [3]. Unlike the commonly used block coordinate descent (BCD) method, the MBI method converges to a local minimum under weaker conditions than those required by the BCD method (more details have been provided in Sections I-B and I-C). Third, the models of the sensors and the fusion center have been determined in terms of the pseudo-inverse matrices. Therefore, they are always well determined and numerically stable. As a result, this approach mitigates to some extent the difficulties associated with the existing techniques. Since a ‘good’ choice of the initial iteration gives reduced errors, special methods for determining initial iterations have been considered.

The error analysis of the proposed method has been provided.

VIII. FUTURE DEVELOPMENT

The problem of WSN modeling with nonideal channels subject to a power constraint per sensor was tackled with different approaches considered, in particular, in [7], [55], [56], [57], [58]. It appears that this is a specialized topic and we intend to extend the approach proposed in Section V to this important problem. Another important topic relates to the analysis of the influence of the covariance estimation errors on models of the sensors and the fusion center. As mentioned before, special methods were developed, in particular, in [38], [39], [40], [41], [42], [43], [44], [45]. In our future research, we intend to extend the known related results to the WSN modeling with the proposed methodology.

IX. ACKNOWLEDGMENT

The authors are grateful to anonymous reviewers for their useful suggestions that led to the significant improvement of the presented results.

X. APPENDIX

A. Advantages of Non-linear Approximation

Advantages of non-linear approximation have been considered, in particular, in [47], [48], [49], [50], [51], [52], [53] where the *non-linear* approximator is represented by the q -degree polynomial operator $\mathbb{P}_q : L^2 \rightarrow L^2$ defined as $\mathbb{P}_q(\mathbf{y}) = \mathcal{A}_0 + \mathcal{A}_1(\mathbf{y}) + \mathcal{A}_2(\mathbf{y}, \mathbf{y}) + \dots + \mathcal{A}_q(\underbrace{\mathbf{y}, \dots, \mathbf{y}}_q)$. Here,

\mathcal{A}_0 stands for a constant operator and $\mathcal{A}_k : (L^2)^k \rightarrow L^2$, for $k = 1, \dots, q$, is a k -linear operator. In broad terms, it is proven that under certain conditions specified in [47], [48], [49], [50], [51], [52], [53], a non-linear transform $\Phi : L^2 \rightarrow L^2$, where $L^2 := L^2(\Omega, \mathbb{R}^n)$, defined as $\mathbf{x} = \Phi(\mathbf{y})$ can uniformly be approximated by $\mathbb{P}_q(\mathbf{y})$ to any degree of accuracy. In other words, for any $\epsilon > 0$, there is a q -degree polynomial $\mathbb{P}_q(\mathbf{y})$ such that, for an appropriate norm $\|\cdot\|$,

$$\|\mathbf{x} - \mathbb{P}_q(\mathbf{y})\| < \epsilon. \quad (59)$$

For $q > 1$, the q -degree polynomial $\mathbb{P}_q(\mathbf{y})$ has more parameters to optimize compared to the linear case when $\mathbb{P}_1(\mathbf{y}) = \mathcal{A}_1(\mathbf{y})$. That is why $\mathbb{P}_q(\mathbf{y})$ can provide any degree of accuracy. Indeed, optimization of $\mathbb{P}_q(\mathbf{y})$ is achieved by a variation of $q + 1$ parameters, $\mathcal{A}_0, \mathcal{A}_1, \dots, \mathcal{A}_q$, while optimization of $\mathbb{P}_1(\mathbf{y}) = \mathcal{A}_1(\mathbf{y})$ follows from choosing one parameter only, \mathcal{A}_1 .

An optimal determination of the q -degree polynomial $\mathbb{P}_q(\mathbf{y})$ is a hard research problem [54]. Its solution is subject to special conditions (convexity, for example) that are not satisfied for the problem in (6) if $\mathcal{F}_j(\mathbf{y}_j)$ is replaced by $\mathbb{P}_q(\mathbf{y})$. For a particular case in (6), when $p = 1, q = 1$ and \mathcal{A}_0 is the zero operator, this difficulty was surmounted in [7], [8], [9], [10], [11], [12], [13], [14] where a special approach for finding $\mathbb{P}_1(\mathbf{y})$ that solves

$$\min_{\mathbb{P}_1 \in \mathcal{R}_{r_1}} \|\mathbf{x} - \mathbb{P}_1(\mathbf{y})\|_{\Omega}^2. \quad (60)$$

has been developed. In [1], for still $p = 1$ in (6), a more general case has been considered, when $q = 2$ and $\mathbb{P}_2(\mathbf{y})$ is represented in a special form given by $\mathbb{P}_2(\mathbf{y}) = \mathcal{A}_1(\mathbf{y}) + \mathcal{A}_2(\mathbf{y}, \mathbf{y})$, where $\mathcal{A}_2(\mathbf{y}, \mathbf{y}) = \tilde{\mathcal{A}}_2(\mathbf{y}^2)$, $\tilde{\mathcal{A}}_2$ is a linear operator and \mathbf{y}^2 is given by $\mathbf{y}^2(\omega) := ([y_1(\omega)]^2, \dots, [y_n(\omega)]^2)^T$. The solution of the problem

$$\begin{aligned} & \min_{\mathcal{A}_1, \tilde{\mathcal{A}}_2} \|\mathbf{x} - \mathbb{P}_2(\mathbf{y})\|_{\Omega}^2 \\ \text{s. t. } & \text{rank}[\mathcal{A}_1, \tilde{\mathcal{A}}_2] \leq r \leq \min\{m, 2n\} \end{aligned}$$

obtained in [1] shows that the increase in q to $q = 2$ allows us to achieve a better associated accuracy than that for the linear case, i.e. with $q = 1$, for the same compression ratio.

The result in [1] has been extended in [59], for an arbitrary q in $\mathbb{P}_q(\mathbf{y})$ and still for $p = 1$ in (6). Due to a special structure of the polynomial $\mathbb{P}_q(\mathbf{y})$ based on the orthogonalisation procedure proposed in [59], it has been shown in Theorem 2 in [59] that, for $p = 1$ and \mathcal{F}_1 represented by $\mathbb{P}_q(\mathbf{y})$ in (6), the accuracy of \mathbf{x} estimation in (6) is further improved when q increases. The orthogonalisation procedure [59] cannot be used for the problem under consideration since the sensors should

not communicate with each other. It is one of the reasons to develop the greedy approach represented in the above Sections I-C, III-A3.

B. Explanation for the Relation in (2)

In Fig. 1 (a), the input of the j th sensor is random vector \mathbf{y}_j which is, by the definition, a function from Ω to \mathbb{R}^{n_j} . More specifically, to satisfy the boundedness condition, $\mathbf{y}_j \in L^2(\Omega, \mathbb{R}^{n_j})$. Since a multiplication of *function* \mathbf{y}_j by a *matrix* is not defined, the sensor model is represented by linear operator \mathcal{B}_j . As a result, in the LHS of (2), $\mathcal{B}_j(\mathbf{y}_j)$ is a random vector as well (i.e., a function from Ω to \mathbb{R}^{n_j}) and then $[\mathcal{B}_j(\mathbf{y}_j)](\omega)$, for any $\omega \in \Omega$, is a vector in \mathbb{R}^{n_j} . To define operator \mathcal{B}_j , matrix B_j is used. To be consistent, operator \mathcal{B}_j and matrix B_j relate to each other as in (2). In the RHS of (2), $\mathbf{y}_j(\omega)$ is a vector in \mathbb{R}^{n_j} , for every $\omega \in \Omega$, and therefore, multiplication of B_j by the vector $\mathbf{y}_j(\omega)$ is well defined.

C. Justification of Algorithm 1

1) *Proof of Theorem 1:* On the basis of (19),

$$\begin{aligned} \min_{\mathcal{P}_j \in \mathcal{R}_{r_j}} \left\| \mathbf{x} - \sum_{j=1}^p \mathcal{P}_j(\mathbf{z}_j) \right\|_{\Omega}^2 &= \min_{\mathcal{P}_j \in \mathcal{R}_{r_j}} \left\| H - \sum_{j=1}^p \mathcal{P}_j G_j \right\|_{\Omega}^2 \\ &= \min_{\mathcal{P}_j \in \mathcal{R}_{r_j}} \|Q_j - \mathcal{P}_j G_j\|_{\Omega}^2, \end{aligned}$$

where Q_j and G_j are as in (19), and $j = 1, \dots, p$. The problem $\min_{\mathcal{P}_j \in \mathcal{R}_{r_j}} \|Q_j - \mathcal{P}_j G_j\|_{\Omega}^2$ has been studied in [4], [5] where its solution has been obtained in form (24). In Theorem 1, the conditions associated with r_j , rank of matrix $Q_j R_{G_j}$ and the singular values of matrix $Q_j R_{G_j}$ follow from the conditions of uniqueness of the SVD (see, e.g., [4]).

2) *Proof of Theorem 2 :* Denote $\bar{\mathbf{x}} = \mathbf{x} - \sum_{\substack{i=1, \\ i \neq j}}^p \mathcal{P}_j \mathbf{z}_j$. Then

we have

$$\begin{aligned} & f(P_1, \dots, P_{j-1}, \hat{P}_j, P_{j+1}, \dots, P_p) \\ &= \left\| \mathbf{x} - \sum_{\substack{i=1, \\ i \neq j}}^p \mathcal{P}_j \mathbf{z}_j - \hat{\mathcal{P}}_j \mathbf{z}_j \right\|_{\Omega}^2 \\ &= \|\bar{\mathbf{x}} - \hat{\mathcal{P}}_j \mathbf{z}_j\|_{\Omega}^2 \end{aligned}$$

On the basis of Theorem 2 in [1], we obtain

$$\begin{aligned} \|\bar{\mathbf{x}} - \hat{\mathcal{P}}_j \mathbf{z}_j\|_{\Omega}^2 &= \text{tr}\{E_{\bar{\mathbf{x}}\bar{\mathbf{x}}}\} - \sum_{i=1}^{r_j} \delta_i - \text{tr}\{C_j H_j^{\dagger} C_j^T\} \\ &= \text{tr}\{E_{\bar{\mathbf{x}}\bar{\mathbf{x}}}\} - \sum_{i=1}^{r_j} \delta_i - \sum_{i=1}^{m_j} \mu_{j,i}. \end{aligned}$$

Further,

$$\begin{aligned} \text{tr}\{E_{\bar{\mathbf{x}}\bar{\mathbf{x}}}\} &= \text{tr}\{E_{x-w_j, x-w_j}\} \\ &= \text{tr}\{E_{xx}\} - 2 \text{tr}\{E_{w_j x}\} + \text{tr}\{E_{w_j w_j}\}. \quad (61) \end{aligned}$$

Then (25) follows.

3) *Comparison with the Linear WSN in (6)*: Recall that (25) represents the error associated with the second degree WSN represented by (11). For the linear WSN considered in Section II-B1, at each iteration of Algorithm 1, matrix \widehat{P}_j should be replaced with matrix \widehat{F}_j where \widehat{F}_j is represented by the GKLT (considered, in particular, in [27]) or by its particular case given in [21]. We wish to compare the error in (25) with the error associated with the linear WSN. To this end, first, we establish the error representation for the linear WSN. Let us denote

$$f_L(F_1, \dots, F_p) = \left\| \mathbf{x} - \sum_{j=1}^p \mathcal{F}_j(\mathbf{y}_j) \right\|_{\Omega}^2,$$

\mathcal{F}_j is as in (6), $\widetilde{\mathbf{w}}_j = \sum_{\substack{i=1 \\ i \neq j}}^p \mathcal{F}_i \mathbf{y}_i$, $\alpha_j = \text{tr}\{2 E_{\widetilde{\mathbf{w}}_j x} - E_{\widetilde{\mathbf{w}}_j \widetilde{\mathbf{w}}_j}\}$ and $\widetilde{\mathbf{x}} = \mathbf{x} - \widetilde{\mathbf{w}}_j$. Further, we write $\sigma_1, \dots, \sigma_{r_j}$ for the first r_j eigenvalues in the SVD for matrix $E_{\widetilde{\mathbf{x}} \mathbf{y}_j} E_{\mathbf{y}_j \mathbf{y}_j}^\dagger E_{\mathbf{y}_j \widetilde{\mathbf{x}}}$. In the theorem that follows we consider the case when \widehat{F}_j is determined by the GKLT.

Theorem 6: For given $F_1, \dots, F_{j-1}, F_{j+1}, \dots, F_p$, the error associated with the optimal matrix \widehat{F}_j for the linear WSN is given by

$$f_L(F_1, \dots, F_{j-1}, \widehat{F}_j, F_{j+1}, \dots, F_p) = \text{tr}\{E_{xx}\} - \sum_{i=1}^{r_j} \sigma_i - \alpha_j. \quad (62)$$

Proof: On the basis of [27] (pp. 313),

$$\begin{aligned} f_L(F_1, \dots, F_{j-1}, \widehat{F}_j, F_{j+1}, \dots, F_p) &= \left\| \mathbf{x} - \sum_{\substack{i=1 \\ i \neq j}}^p \mathcal{F}_i \mathbf{y}_i - \widehat{\mathcal{F}}_j \mathbf{y}_j \right\|_{\Omega}^2 \\ &= \left\| \widetilde{\mathbf{x}} - \widehat{\mathcal{F}}_j \mathbf{y}_j \right\|_{\Omega}^2 \\ &= \text{tr}\{E_{\widetilde{\mathbf{x}} \widetilde{\mathbf{x}}}\} - \sum_{i=1}^{r_j} \sigma_i \end{aligned}$$

where

$$\begin{aligned} \text{tr}\{E_{\widetilde{\mathbf{x}} \widetilde{\mathbf{x}}}\} &= \text{tr}\{E_{x - \widetilde{\mathbf{w}}_j, x - \widetilde{\mathbf{w}}_j}\} \\ &= \text{tr}\{E_{xx}\} - 2 \text{tr}\{E_{\widetilde{\mathbf{w}}_j x}\} + \text{tr}\{E_{\widetilde{\mathbf{w}}_j \widetilde{\mathbf{w}}_j}\}. \end{aligned} \quad (63)$$

The above implies (62). ■

The following theorem establishes a condition under which the error in (25) associated with the second degree WSN is less than that in (62) for the linear WSN.

Theorem 7: If

$$\alpha_j - \beta_j < \sum_{i=1}^{r_j} (\delta_i - \sigma_i) + \sum_{i=1}^m \mu_{j,i}$$

then

$$f(P_1, \dots, P_{j-1}, \widehat{P}_j, P_{j+1}, \dots, P_p) < f_L(F_1, \dots, F_{j-1}, \widehat{F}_j, F_{j+1}, \dots, F_p) \quad \text{min}_{P_j \in \mathbb{R}^{r_j}}$$

Proof: The proof follows directly from (25) and (62). ■

4) *Comparison with Linear WSNs in [7], [11]*: A theoretical comparison of the error associated with the second degree WSN in (25) and the errors associated with the linear WSNs studied in [7], [11] is difficult because of the following. The error analysis in [7], [11] is provided in terms which are quite different from those used in Theorem 2. Second, in [7], [11], the error analysis is given under the assumption that the covariance matrices are invertible, which is not the case in Theorem 2. At the same time, the errors associated with the methods in [7] and [11] might be represented in the form similar to that in (62) where σ_i and α_j should specifically be obtained for the methods in [7], [11]. In this case, the comparison would be provided in the form similar to that in Theorem 7. Other way for the numerical comparison is to use the error representation in (31). The error associated with the linear WSN in [7] or [11], follows from (31) where z should be replaced with y and $P^{(q+1)}$ should be replaced with the corresponding iteration of the method [7] or [11]. Of course, this is a posteriori comparison, nevertheless, it is an opportunity to obtain a numerical representation of the errors under consideration. In fact, this comparison is provided in the simulations in Section IV.

5) *Convergence of Algorithm 1*: Convergence of the method presented in Section III-A3 can be shown on the basis of the results given in [2], [3], [60] as follows. We call $\mathbf{P} = (P_1, \dots, P_p) \in \mathbb{R}_{r_1, \dots, r_p}$ a point in the space $\mathbb{R}_{r_1, \dots, r_p}$. For every point $\mathbf{P} \in \mathbb{R}_{r_1, \dots, r_p}$, define a set

$$\mathbb{R}_{r_j}^{\mathbf{P}} = \{(P_1, \dots, P_{j-1})\} \times \mathbb{R}_{r_j} \times \{(P_{j+1}, \dots, P_p)\},$$

for $j = 1, \dots, p$. A coordinate-wise minimum point of the procedure represented by Algorithm 1 is denoted by $\mathbf{P}^* = (P_1^*, \dots, P_p^*)$ where⁷

$$P_j^* \in \left\{ \arg \min_{P_j \in \mathbb{R}_{r_j}} \phi(P_1^*, \dots, P_{j-1}^*, P_j, P_{j+1}^*, \dots, P_p^*) \right\}. \quad (64)$$

This point is a local minimum of objective function in (18),

$$\phi(\mathbf{P}) = \left\| H - \sum_{j=1}^p P_j G_j \right\|_{\Omega}^2. \quad \text{Note that } \mathbf{P}^{(q+1)} \text{ in Algorithm 1 and } \mathbf{P}^* \text{ defined by (64) are, of course, different.}$$

We also need the following auxiliary result.

Lemma 1: The sequence $\{\mathbf{P}^{(q)}\}$ generated by Algorithm 1 is bounded.

Proof: Consider $\widetilde{\phi}(\mathbf{P}) = \widetilde{\phi}(P_1, \dots, P_p) = \|PG - H\|$ where $G = [G_1, \dots, G_p]$, and G_j , for $j = 1, \dots, p$, and H are given in (14) and (15). Then $\|PG - H\| \geq \|PG\| - \|H\|$, i.e.,

$$\|PG\| - \|H\| \leq \widetilde{\phi}(P_1, \dots, P_p). \quad (65)$$

Suppose sequence $\{\mathbf{P}^{(q)}\}$ is unbounded, i.e., $\|\mathbf{P}^{(q)}\| \rightarrow \infty$ as $q \rightarrow \infty$. Then (65) implies $\|\mathbf{P}^{(q)} G\| - \|H\| \rightarrow \infty$ as

⁷The RHS in (64) is a set since the solution of problem $\min_{P_j \in \mathbb{R}^{r_j}} \phi(P_1^*, \dots, P_{j-1}^*, P_j, P_{j+1}^*, \dots, P_p^*)$ is not unique.

⁸There could be other local minimums defined differently from that in (64).

$q \rightarrow \infty$. Therefore, $\tilde{\phi}(P_1^{(q)}, \dots, P_p^{(q)}) \rightarrow \infty$ as $q \rightarrow \infty$ and then $\phi(P_1^{(q)}, \dots, P_p^{(q)}) \rightarrow \infty$ as $q \rightarrow \infty$. But it conflicts with Algorithm 1 where

$$0 \leq \phi(P_1^{(q)}, \dots, P_p^{(q)}) \leq \phi(P_1^{(0)}, \dots, P_p^{(0)}).$$

Thus, $\{\mathbf{P}^{(q)}\}$ is bounded. ■

Now we are in the position to show convergence of Algorithm 1. For $\mathbf{P}^{(q)}$ defined by Algorithm 1, denote

$$\phi(\check{\mathbf{P}}) = \lim_{q \rightarrow \infty} \phi(\mathbf{P}^{(q)}). \quad (66)$$

Theorem 8: Point $\check{\mathbf{P}}$ defined by (66) is the coordinate-wise minimum of Algorithm 1.

Proof: For each fixed $\mathbf{P} = (P_1, \dots, P_p)$, a so-called best response matrix to matrix P_j is denoted by $\Phi_j^{\mathbf{P}}$, where

$$\Phi_j^{\mathbf{P}} \in \left\{ \arg \min_{P_j \in \mathbb{R}^{r_j}} \phi(P_1, \dots, P_{j-1}, P_j, P_{j+1}, \dots, P_p) \right\}.$$

Let $\{\mathbf{P}^{(q)}\}$ be a sequence generated by Algorithm 1, where $\mathbf{P}^{(q)} = (P_1^{(q)}, \dots, P_p^{(q)})$. Since each $\mathbb{R}_{r_j}^{\mathbf{P}}$ is closed [61, p. 304] and sequence $\{\mathbf{P}^{(q)}\}$ is bounded, there is a subsequence $\{\mathbf{P}^{(q_s)}\}$ such that $(P_1^{(q_s)}, \dots, P_p^{(q_s)}) \rightarrow (P_1^*, \dots, P_p^*) = \mathbf{P}^*$ as $s \rightarrow \infty$. Then, for any $j = 1, \dots, p$, we have

$$\begin{aligned} & \phi(P_1^{(q_s)}, \dots, P_{j-1}^{(q_s)}, \Phi_j^{\mathbf{P}^{(q_s)}}, P_{j+1}^{(q_s)}, \dots, P_p^{(q_s)}) \\ & \geq \phi(P_1^{(q_s)}, \dots, P_{j-1}^{(q_s)}, \Phi_j^{\mathbf{P}^{(q_s)}}, P_{j+1}^{(q_s)}, \dots, P_p^{(q_s)}) \\ & \geq \phi(P_1^{(q_s+1)}, \dots, P_{j-1}^{(q_s+1)}, P_j^{(q_s+1)}, P_{j+1}^{(q_s+1)}, \dots, P_p^{(q_s+1)}) \\ & \geq \phi(P_1^{(q_s+1)}, \dots, P_{j-1}^{(q_s+1)}, P_j^{(q_s+1)}, P_{j+1}^{(q_s+1)}, \dots, P_p^{(q_s+1)}) \end{aligned}$$

By continuity, when $s \rightarrow \infty$,

$$\begin{aligned} \phi(P_1^*, \dots, P_{j-1}^*, \Phi_j^{\mathbf{P}^*}, P_{j+1}^*, \dots, P_p^*) & \geq \\ & \phi(P_1^*, \dots, P_{j-1}^*, P_j^*, P_{j+1}^*, \dots, P_p^*), \end{aligned}$$

which implies that above should hold as an equality, since the inequality is true by the definition of the best response matrix $\Phi_j^{\mathbf{P}^*}$. Thus, P_j^* is such as in (64), i.e. P_j^* is a solution of the problem

$$\min_{P_j \in \mathbb{R}_{r_j}} \phi(P_1^*, \dots, P_{j-1}^*, P_j, P_{j+1}^*, \dots, P_p^*), \quad \forall j = 1, \dots, p. \quad \blacksquare$$

D. Justification of Algorithm 2

For $\mathbf{P}^{(q)}$ defined by Algorithm 2, denote

$$\psi(\mathbf{P}^*) = \lim_{q \rightarrow \infty} \psi(\mathbf{P}^{(q)}). \quad (67)$$

Theorem 9: Point $\mathbf{P}^* = (T^*, S_1^*, \dots, S_p^*)$ defined by (67) is the coordinate-wise minimum of Algorithm 2.

Proof: The proof is similar to that for Theorem 8. Therefore, we only provide a related sketch. For each fixed $\mathbf{P} = (T, S_1, \dots, S_p)$, denote by $S_j^{\mathbf{P}}$ a best response matrix to

S_j defined by

$$R_j^{\mathbf{P}} \in \left\{ \arg \min_{S_j \in \mathbb{R}^{r_j \times n}} \psi(T, S_1, \dots, S_{j-1}, S_j, S_{j+1}, \dots, S_p) \right\}.$$

By Algorithm 2, a member of sequence $\{\mathbf{P}^{(q)}\}$ is given by $\mathbf{P}^{(q)} = (T^{(q)}, S_1^{(q)}, \dots, S_p^{(q)})$. Similar to Lemma 1, sequence $\{\mathbf{P}^{(q)}\}$ provided by Algorithm 2 is bounded. Then there is a subsequence $\{\mathbf{P}^{(q_v)}\}$ with $\mathbf{P}^{(q_v)} = (T^{(q_v)}, S_1^{(q_v)}, \dots, S_p^{(q_v)})$ such that $(T^{(q_v)}, S_1^{(q_v)}, \dots, S_p^{(q_v)}) \rightarrow (T^*, S_1^*, \dots, S_p^*) = \mathbf{P}^*$ as $v \rightarrow \infty$. Then, for any $j = 1, \dots, p$, we have

$$\begin{aligned} & \psi(T^{(q_v)}, S_1^{(q_v)}, \dots, S_{j-1}^{(q_v)}, R_j^{\mathbf{P}^{(q_v)}}, S_{j+1}^{(q_v)}, \dots, S_p^{(q_v)}) \geq \\ & \psi(T^{(q_{t+1})}, S_1^{(q_{t+1})}, \dots, S_{j-1}^{(q_{t+1})}, S_j^{(q_{t+1})}, S_{j+1}^{(q_{t+1})}, \dots, S_p^{(q_{t+1})}) \end{aligned}$$

and, for $v \rightarrow \infty$,

$$\begin{aligned} & \psi(T^*, S_1^*, \dots, S_{j-1}^*, R_j^{\mathbf{P}^*}, S_{j+1}^*, \dots, S_p^*) \geq \\ & \psi(T^*, S_1^*, \dots, S_{j-1}^*, S_j^*, S_{j+1}^*, \dots, S_p^*), \end{aligned}$$

which implies that above should hold as an equality. Thus, S_j^* is the best response to $(S_1^*, \dots, S_{j-1}^*, S_{j+1}^*, \dots, S_p^*)$, or equivalently, S_j^* is the optimal solution for the problem

$$\max_{S_j \in \mathbb{R}^{r_j \times n}} \psi(T^*, S_1^*, \dots, S_{j-1}^*, S_j, S_{j+1}^*, \dots, S_p^*), \quad \forall j = 1, \dots, p.$$

The proof is similar when

$$R_j^{\mathbf{P}} \in \left\{ \arg \min_{T \in \mathbb{R}^{m \times r_j}} \psi(T, S_1, \dots, S_p) \right\}. \quad \blacksquare$$

REFERENCES

- [1] A. Torokhti and P. Howlett, "Optimal fixed rank transform of the second degree," *IEEE Trans. CAS. Part II, Analog and Digital Signal Processing*, vol. 48, no. 3, pp. 309 – 315, 2001.
- [2] B. Chen, S. He, Z. Li, and S. Zhang, "Maximum block improvement and polynomial optimization," *SIAM Journal on Optimization*, vol. 22, no. 1, pp. 87–107, 2012.
- [3] Z. Li, A. Uschmajew, and S. Zhang, "On convergence of the maximum block improvement method," *SIAM Journal on Optimization*, vol. 25, no. 1, pp. 210–233, 2015.
- [4] S. Friedland and A. Torokhti, "Generalized rank-constrained matrix approximations," *SIAM Journal on Matrix Analysis and Applications*, vol. 29, no. 2, pp. 656–659, 2007.
- [5] A. Torokhti and S. Friedland, "Towards theory of generic Principal Component Analysis," *Journal of Multivariate Analysis*, vol. 100, no. 4, pp. 661 – 669, 2009.
- [6] I. F. Akyildiz, W. Su, Y. Sankarasubramaniam, and E. Cayirci, "A survey on sensor networks," *IEEE Commun. Mag.*, vol. 40, no. 8, pp. 102 – 114, 2002.
- [7] I. D. Schizas, G. B. Giannakis, and Z.-Q. Luo, "Distributed estimation using reduced-dimensionality sensor observations," *IEEE Transactions on Signal Processing*, vol. 55, no. 8, pp. 4284–4299, Aug 2007.
- [8] E. Song, Y. Zhu, and J. Zhou, "Sensors optimal dimensionality compression matrix in estimation fusion," *Automatica*, vol. 41, no. 12, pp. 2131 – 2139, 2005.
- [9] Y. Zhu, E. Song, J. Zhou, and Z. You, "Optimal dimensionality reduction of sensor data in multisensor estimation fusion," *IEEE Transactions on Signal Processing*, vol. 53, no. 5, pp. 1631–1639, May 2005.

- [10] G. M., D. P.L., and V. M., "The distributed Karhunen-Loève transform," *IEEE Transactions on Information Theory*, vol. 52, no. 12, pp. 5177–5196, Dec 2006.
- [11] O. Roy and M. Vetterli, "Dimensionality reduction for distributed estimation in the infinite dimensional regime," *IEEE Transactions on Information Theory*, vol. 54, no. 4, pp. 1655–1669, April 2008.
- [12] I. D. Schizas, A. Ribeiro, and G. B. Giannakis, "Dimensionality reduction, compression and quantization for distributed estimation with wireless sensor networks," in *Wireless Communications*, ser. The IMA Volumes in Mathematics and its Applications. Springer New York, 2007, vol. 143, pp. 259–296.
- [13] P. L. Dragotti and M. Gastpar, *Distributed Source Coding: Theory, Algorithms and Applications*. Academic Press, 2009.
- [14] J. Fang and H. Li, "Optimal/near-optimal dimensionality reduction for distributed estimation in homogeneous and certain inhomogeneous scenarios," *IEEE Transactions on Signal Processing*, vol. 58, no. 8, pp. 4339–4353, Aug 2010.
- [15] A. Amar, A. Leshem, and M. Gastpar, "Recursive implementation of the distributed Karhunen-Loeve transform," *IEEE Transactions on Signal Processing*, vol. 58, no. 10, pp. 5320–5330, Oct 2010.
- [16] J. A. Saghri, S. Schroeder, and A. G. Tescher, "Adaptive two-stage Karhunen-Loeve-transform scheme for spectral decorrelation in hyperspectral bandwidth compression," *Optical Engineering*, vol. 49, no. 5, pp. 057 001–057 001–7, 2010.
- [17] M. Lara and B. Mulgrew, "Performance of the distributed KLT and its approximate implementation," in *2012 Proceedings of the 20th European Signal Processing Conference (EUSIPCO)*, Aug 2012, pp. 724–728.
- [18] D. Li, K. D. Wong, Y. H. Hu, and A. M. Sayeed, "Detection, classification, and tracking of targets," *IEEE Signal Processing Mag.*, vol. 19, no. 2, pp. 17 – 29, 2002.
- [19] T.-H. L. W. J. Kaiser and G. J. Pottie, "Integrated low-power communication system design for wireless sensor networks," *IEEE Commun. Mag.*, vol. 42, no. 12, pp. 142 – 150, 2004.
- [20] M. G. M. Vetterli and P. Dragotti, "Sensing reality and communicating bits: A dangerous liaison," *IEEE Signal Process. Mag.*, vol. 23, no. 4, pp. 70 – 83, 2006.
- [21] D. R. Brillinger, *Time Series: Data Analysis and Theory*. San Francisco: Holden Day, 2001.
- [22] T. Kailath, A. Saed, and B. Hassibi, *Linear estimation*. Upper Saddle River: Prentice-Hall, 2000.
- [23] H. V. Poor, *An Introduction to Signal Processing and Estimation*. 2nd ed. New York: Springer-Verlag, 2001.
- [24] P. Tseng, "Convergence of a block coordinate descent method for nondifferentiable minimization," *Journal of Optimization Theory and Applications*, vol. 109, no. 3, pp. 475–494, 2001.
- [25] Y. Hua, M. Nikpour, and P. Stoica, "Optimal reduced-rank estimation and filtering," *IEEE Transactions on Signal Processing*, vol. 49, no. 3, pp. 457–469, Mar 2001.
- [26] A. Torokhti and S. Miklavcic, "Data compression under constraints of causality and variable finite memory," *Signal Processing*, vol. 90, no. 10, pp. 2822 – 2834, 2010.
- [27] A. Torokhti and P. Howlett, *Computational Methods for Modelling of Nonlinear Systems*. Elsevier, 2007.
- [28] D. Slepian and J. Wolf, "Noiseless coding of correlated information sources," *IEEE Transactions on Information Theory*, vol. 19, no. 4, pp. 471–480, Jul 1973.
- [29] A. Wyner and J. Ziv, "The rate-distortion function for source coding with side information at the decoder," *IEEE Transactions on Information Theory*, vol. 22, no. 1, pp. 1–10, Jan 1976.
- [30] V. Goyal, "Theoretical foundations of transform coding," *IEEE Signal Processing Magazine*, vol. 18, no. 5, pp. 9–21, Sep 2001.
- [31] A. Bertrand and M. Moonen, "Distributed adaptive node-specific signal estimation in fully connected sensor networks - Part I: Sequential node updating," *IEEE Transactions on Signal Processing*, vol. 58, no. 10, pp. 5277 – 5291, 2010.
- [32] —, "Distributed adaptive node-specific signal estimation in fully connected sensor networks—part ii: Simultaneous and asynchronous node updating," *IEEE Transactions on Signal Processing*, vol. 58, no. 10, pp. 5292 – 5306, 2010.
- [33] V. Ejoy and A. Torokhti, "How to transform matrices U_1, \dots, U_p to matrices V_1, \dots, V_p so that $V_i V_j = \mathbb{O}$ if $i \neq j$?" *Numerical Algebra, Control and Optimization*, vol. 2, no. 2, pp. 293–299, 2012.
- [34] H. Ma, Y.-H. Yang, Y. Chen, L. K.J.R., and Q. Wang, "Distributed state estimation with dimension reduction preprocessing," *Signal Processing, IEEE Transactions on*, vol. 62, no. 12, pp. 3098–3110, June 2014.
- [35] A. Grant, A. Torokhti, and P. Soto-Quiros, "Compression and recovery of distributed random signals," *IEEE Transactions on Information Theory*, (submitted).
- [36] A. Torokhti and S. Friedland, "Towards theory of generic principal component analysis," *Journal of Multivariate Analysis*, vol. 100, no. 4, pp. 661 – 669, 2009.
- [37] A. Torokhti, P. Howlett, and H. Laga, "Estimation of stochastic signals under partially missing information," *Signal Processing*, vol. 11, pp. 199–209, 2015.
- [38] L. Perlovsky and T. Marzetta, "Estimating a covariance matrix from incomplete realizations of a random vector," *IEEE Transactions on Signal Processing*, vol. 40, no. 8, pp. 2097–2100, Aug 1992.
- [39] O. Ledoit and M. Wolf, "A well-conditioned estimator for large-dimensional covariance matrices," *Journal of Multivariate Analysis*, vol. 88, no. 2, pp. 365 – 411, 2004.
- [40] —, "Nonlinear shrinkage estimation of large-dimensional covariance matrices," *The Annals of Statistics*, vol. 40, no. 2, pp. 1024–1060, 2012.
- [41] R. Adamczak, A. E. Litvak, A. Pajor, and N. Tomczak-Jaegermann, "Quantitative estimates of the convergence of the empirical covariance matrix in log-concave ensembles," *Journal of the American Mathematical Society*, no. 23, pp. 535–561, 2009.
- [42] R. Vershynin, "How close is the sample covariance matrix to the actual covariance matrix?" *Journal of Theoretical Probability*, vol. 25, no. 3, pp. 655–686, 2012.
- [43] S.-J. K. Joong-Ho Won, Johan Lim and B. Rajaratnam, "Condition-number-regularized covariance estimation," *Journal of the Royal Statistical Society: Series B (Statistical Methodology)*, vol. 75, no. 3, pp. 427–450, 2013.
- [44] B. W. Schmeiser and M. H. Chen, "On hit-and-run Monte Carlo sampling for evaluating multidimensional integrals," *Technical Report 91-39, Dept. Statistics, Purdue Univ.*, 1991.
- [45] R. Yang and J. O. Berger, "Estimation of a covariance matrix using the reference prior," *The Annals of Statistics*, vol. 22, no. 3, pp. 1195–1211, 1994.
- [46] E. Kreyszig, *Introductory Functional Analysis with Applications*. New York: John Wiley & Sons, Inc, 1978.
- [47] P. M. Prenter, "A Weierstrass theorem for real, separable Hilbert spaces," *J. Approximation Theory*, vol. 4, pp. 341 – 357, 1970.
- [48] V. I. Istrătescu, "A Weierstrass theorem for real Banach spaces," *J. Approximation Theory*, vol. 19, pp. 118–122, 1977.
- [49] V. I. Bruno, "An approximate Weierstrass theorem in topological vector space," *J. Approximation Theory*, vol. 42, pp. 1–3, 1984.
- [50] N. I. Akhiezer, *Theory of Approximation*. New York: Dover, 1992.
- [51] I. Sandberg, "Time-delay polynomial networks and quality of approximation," *IEEE Trans. on Circuits and Systems. Part I, Fundamental theory and applications*, vol. 47, pp. 40 – 49, 2000.
- [52] V. J. Mathews and G. L. Sicuranza, *Polynomial Signal Processing*. New York: John Wiley & Sons, Inc, 2001.
- [53] P. G. Howlett, A. P. Torokhti, and C. Pearce, "A philosophy for the modelling of realistic non-linear systems," *Proc. of Amer. Math. Soc.*, vol. 131, no. 2, pp. 353–363, 2003.

- [54] F. Deutsch, *Best Approximation in Inner Product Spaces*. New York: Springer, 2001.
- [55] A. Ribeiro and G. B. Giannakis, "Bandwidth-constrained distributed estimation for wireless sensor networks - Part I: Gaussian case," *IEEE Transactions on Signal Processing*, vol. 54, no. 3, pp. 1131–1143, 2006.
- [56] J.-J. Xiao, A. Ribeiro, Z.-Q. Luo, and G. B. Giannakis, "Distributed compression-estimation using wireless sensor networks," *IEEE Signal Processing Magazine*, vol. 27, 2006.
- [57] J. Li and G. AlRegib, "Distributed estimation in energy-constrained wireless sensor networks," *IEEE Transactions on Signal Processing*, vol. 57, no. 10, pp. 3746–3758, 2009.
- [58] S. Shah and B. Beferull-Lozano, "In-network iterative distributed estimation for power-constrained wireless sensor networks," *8th IEEE International Conference on Distributed Computing in Sensor Systems*, pp. 239–246, 2012.
- [59] A. Torokhti and P. Howlett, "Optimal transform formed by a combination of nonlinear operators: The case of data dimensionality reduction," *IEEE Trans. on Signal Processing*, vol. 54, no. 4, pp. 1431 – 1444, 2006.
- [60] X. Li, H. Liu, and X. Zheng, "Non-monotone projection gradient method for non-negative matrix factorization," *Computational Optimization and Applications*, vol. 51, no. 3, pp. 1163–1171, 2012.
- [61] L. Tu, *An Introduction to Manifolds*, ser. Universitext. Springer, 2007.