

5D and 6D SCFTs from \mathbb{C}^3 orbifolds

Jiahua Tian^a Yi-Nan Wang^{b,c,d}

^a*The Abdus Salam International Centre for Theoretical Physics,
Strada Costiera 11, 34151, Trieste, Italy*

^b*School of Physics and State Key Laboratory of Nuclear Physics and Technology,
Peking University, Beijing 100871, China*

^c*Center for High Energy Physics, Peking University,
Beijing 100871, China*

^d*Mathematical Institute, University of Oxford,
Andrew-Wiles Building, Woodstock Road, Oxford, OX2 6GG, UK*

E-mail: jtian@ictp.it, ynwang@pku.edu.cn

ABSTRACT: We study the orbifold singularities $X = \mathbb{C}^3/\Gamma$ where Γ is a finite subgroup of $SU(3)$. M-theory on this orbifold singularity gives rise to a 5d SCFT, which is investigated with two methods. The first approach is via 3d McKay correspondence which relates the group theoretic data of Γ to the physical properties of the 5d SCFT. In particular, the 1-form symmetry of the 5d SCFT is read off from the McKay quiver of Γ in an elegant way. The second method is to explicitly resolve the singularity X and study the Coulomb branch information of the 5d SCFT, which is applied to toric, non-toric hypersurface and complete intersection cases. Many new theories are constructed, either with or without an IR quiver gauge theory description. We find that many resolved Calabi-Yau threefolds, \tilde{X} , contain compact exceptional divisors that are singular by themselves. Moreover, for certain cases of Γ , the orbifold singularity \mathbb{C}^3/Γ can be embedded in an elliptic model and gives rise to a 6d (1,0) SCFT in the F-theory construction. Such 6d theory is naturally related to the 5d SCFT defined on the same singularity. We find examples of rank-1 6d SCFTs without a gauge group, which are potentially different from the rank-1 E-string theory.

Contents

1	Introduction and summary	2
2	3d McKay correspondence, resolution and physics	8
2.1	Ito-Reid theorem on \mathbb{C}^3/Γ orbifolds	8
2.2	Resolution	9
2.2.1	Hypersurface	9
2.2.2	Complete intersection in ambient 5-fold	11
2.2.3	Applicability of intersection number computations	12
2.3	Codimension-two singularities and flavor symmetry	13
2.3.1	Codimension-two singularity from group structure of Γ	13
2.3.2	5d flavor symmetry from resolution	16
2.4	McKay quiver and 1-form symmetry of 5d SCFT	18
2.5	Relation between 6d and 5d SCFTs	21
3	The finite subgroups of $SU(3)$	22
3.1	Abelian subgroups	22
3.1.1	\mathbb{Z}_n	23
3.1.2	$\mathbb{Z}_m \times \mathbb{Z}_n$	25
3.2	Non-abelian subgroups of $U(2)$	27
3.2.1	Infinite sequences $G_m, G_{p,q}$ and G'_m	27
3.2.2	Sporadic cases $E^{(k)}$	28
3.3	Infinite series of non-abelian finite subgroups of $SU(3)$	32
3.3.1	$\Delta(3n^2)$ series	32
3.3.2	$\Delta(6n^2)$ series	33
3.3.3	$C_{n,l}^{(k)}$ series	33
3.3.4	$D_{3l,l}^{(1)}$ series, $2 \mid l$	34
3.4	Exceptional finite subgroups of $SU(3)$	34
4	Examples	37
4.1	$\Delta(3n^2)$, $n = 3k$	37
4.1.1	6d interpretation	37
4.1.2	5d interpretation	38
4.2	A new 6d (1,0) SCFT from $\mathbb{C}^3/\Delta(48)$	41
4.2.1	6d interpretation	41
4.2.2	5d interpretation	43
4.3	$\Delta(54)$	46
4.3.1	6d interpretation	46
4.3.2	5d interpretation	47
4.4	G_m	48

4.4.1	$m = 2k$	49
4.4.2	$m = 2k + 1$	49
5	Future Directions	50
A	The abelian subgroups of the exceptional finite subgroups of $SU(3)$	51
A.1	Sporadic subgroups of $U(2)$	52
A.1.1	$E^{(1)}$	52
A.1.2	$E^{(2)}$	53
A.1.3	$E^{(3)}$	53
A.1.4	$E^{(4)}$	54
A.1.5	$E^{(5)}$	55
A.1.6	$E^{(6)}$	56
A.1.7	$E^{(7)}$	56
A.1.8	$E^{(8)}$	57
A.1.9	$E^{(9)}$	58
A.1.10	$E^{(10)}$	59
A.1.11	$E^{(11)}$	60
A.2	H_{36}	61
A.3	H_{60}	63
A.4	H_{72}	64
A.5	H_{168}	66
A.6	H_{216}	67
A.7	H_{360}	69
B	More examples	70
B.1	$E^{(6)}$	70
B.1.1	6d interpretation	70
B.1.2	5d interpretation	71
B.2	$E^{(7)}$	72
B.3	\mathbb{C}^3/H_{36}	73
B.3.1	6d interpretation	73
B.3.2	5d interpretation	74
B.4	\mathbb{C}^3/H_{60}	75
B.5	\mathbb{C}^3/H_{168}	76
B.5.1	6d interpretation	76
B.5.2	5d interpretation	79
B.6	$E^{(2)}$	79
B.7	$E^{(4)}$	80
B.8	G'_m with odd m	81
B.9	$\mathbb{C}^3/\Delta(6n^2)$, $n = 2k$	83
B.10	$C_{3l,l}^{(1)}$, $3 \mid l$	84
B.11	$D_{3l,l}^{(1)}$, $l = 2k$	85

B.12 H_{72}

85

B.13 H_{216}

87

1 Introduction and summary

In five-dimensional Minkowski spacetime there exists infinitely many non-trivial strongly-coupled $\mathcal{N} = 1$ superconformal field theories. The original examples of 5d SCFTs include Seiberg’s rank-1 and rank- N E_n theories, which can be thought as the UV completions of $SU(2) + (n - 1)\mathbf{F}$ and $Sp(N) + 1\mathbf{AS} + (n - 1)\mathbf{F}$ gauge theories, respectively [1–3]. After that it was found there are two different ways to construct 5d SCFTs systematically, in the framework of superstring/M-theory. For a relatively complete overview on these approaches, see [4].

The first approach is to define a 5d SCFT T_X^{5d} as M-theory on a canonical threefold singularity X [5]. More specifically, one can take either an isolated singularity where X is only singular at the codimension-three point $\{0\}$ or a non-isolated singularity where X is also singular along codimension-two loci. For the isolated singularities, the Coulomb branch and Higgs branch information of T_X^{5d} can be read off from the resolution \tilde{X} and deformation \hat{X} of the singularity [6–8]. For the non-isolated singularities, one can only directly read off the Coulomb branch from the resolution \tilde{X} , but the flavor symmetry (algebra) G_F is nicely encoded in the codimension-two singularities of X [9–14]. Alternatively, one can directly classify the resolved space \tilde{X} according to the topology of exceptional divisors S_i , which are subject to the “shrinkable” condition [15–25]. This technique was further extended to include cases without a straight-forward geometric description [26, 27]. In the special cases of toric geometry, the theory has a IIA construction as well [28–32].

The second approach is to construct the 5d SCFT with a (p, q) 5-brane web system in IIB superstring theory, where both the Coulomb and Higgs branch information can be extracted via the shifting of branes [33–51]. More recently, this approach was also reformulated and generalized in the framework of “generalized toric polytopes” (GTP) [52–54].

In this paper, we further explore the set of 5d SCFTs T_X^{5d} defined as M-theory on orbifold singularities $X = \mathbb{C}^3/\Gamma$, where Γ is a finite subgroup of $SU(3)$. In general, \mathbb{C}^3/Γ has non-isolated singularities and we only study the Coulomb branch data of T_X^{5d} from the resolved space \tilde{X} . Mathematically, the relation between \tilde{X} and Γ was studied under the framework of 3d McKay correspondence [55, 56], which we briefly review in section 2.1. In short, after the crepant resolution, \tilde{X} has no terminal singularity, and $b_3(\tilde{X})=0$. The different conjugacy classes \mathfrak{g} of Γ one-to-one correspond to different cycles in \tilde{X} . For each conjugacy class \mathfrak{g} where each element has the eigenvalues

$$\{\lambda_i\} = \{\exp(2\pi im) , \exp(2\pi in) , \exp(2\pi ip)\} \quad (0 \leq m, n, p < 1), \quad (1.1)$$

its *age* is defined as the sum $(m + n + p)$. The set of conjugacy classes with age 2 is denoted as Γ_2 , which corresponds to the set of compact divisors $S_i \subset \tilde{X}$. The set of conjugacy classes with age 1 is denoted as Γ_1 whose elements correspond to the Poincaré dual of S_i and flavor 2-cycles C_α (corresponding to non-compact divisors D_α) that generate the flavor symmetry G_F of T_X^{5d} . Thus, one can do a simple group theoretic computation to get the rank $r = |\Gamma_2|$ and flavor rank $f = |\Gamma_1| - |\Gamma_2|$ of the 5d SCFT. We also propose a way to

read off codimension-two singularities of X based on the structure of subgroups of Γ in section 2.3.1.

The classification of finite subgroups Γ of $SU(3)$ was known for a long time, following [57–60]. They were also applied in the studies of 4d quiver gauge theories [61–65] and particle physics model building [58, 66–70]. In table 1, we list the different classes of Γ following the classifications in [71, 72]. In this paper, we also use some notations in [73]. The details of the generators for these groups are presented in section 3.

- (A) The abelian subgroups, including \mathbb{Z}_n and $\mathbb{Z}_m \times \mathbb{Z}_n$.
- (B) The non-abelian subgroups with the generators

$$\begin{pmatrix} \sigma_{2 \times 2} & 0 \\ 0 & \det(\sigma_{2 \times 2})^{-1} \end{pmatrix} \quad (1.2)$$

where $\sigma_{2 \times 2}$ are generators of a $U(2)$ subgroup. In this paper, the finite subgroup of $SU(2)$ of D and E types are denoted as \mathbb{D}_n (the binary dihedral group with order $4n$) and \mathbb{E}_n (including the binary tetrahedral group \mathbb{T} , the binary octahedral group \mathbb{O} and the binary icosahedral group \mathbb{I}).

- (C) These subgroups have the structure of $\Gamma = (\mathbb{Z}_m \times \mathbb{Z}_n) \rtimes \mathbb{Z}_3$, where the \mathbb{Z}_3 generator is the off-diagonal matrix

$$E = \begin{pmatrix} 0 & 1 & 0 \\ 0 & 0 & 1 \\ 1 & 0 & 0 \end{pmatrix}. \quad (1.3)$$

- (D) These subgroups have the structure of $\Gamma = [(\mathbb{Z}_m \times \mathbb{Z}_n) \rtimes \mathbb{Z}_3] \rtimes \mathbb{Z}_2$, where the \mathbb{Z}_3 generator is E and the \mathbb{Z}_2 generator is

$$I = \begin{pmatrix} 0 & 0 & 1 \\ 0 & 1 & 0 \\ 1 & 0 & 0 \end{pmatrix}. \quad (1.4)$$

- (E) An exceptional subgroup of $SU(3)$ of order 108, which is also denoted as H_{36} .
- (F) An exceptional subgroup of $SU(3)$ of order 216, which is denoted as H_{72} .
- (G) An exceptional subgroup of $SU(3)$ of order 648, which is denoted as H_{216} .
- (H) A subgroup of order 60, H_{60} , which is isomorphic to the alternating group \mathbb{A}_5 .
- (I) A subgroup of order 168, H_{168} , which is isomorphic to the permutation group generated by (1234567) , $(142)(356)$ and $(12)(35)$.
- (L) An exceptional subgroups of $SU(3)$ of order 1080, which is denoted as H_{360} .

Class	$\Gamma \in SU(3)$	$ \Gamma $
(A)	\mathbb{Z}_n	n
	$\mathbb{Z}_m \times \mathbb{Z}_n$	mn
(B)	G_m	$8m$
	$G_{p,q}$	$8pq^2$
	G'_m	$8m$
	$E^{(1)}$	72
	$E^{(2)}$	24
	$E^{(3)}$	96
	$E^{(4)}$	48
	$E^{(5)}$	96
	$E^{(6)}$	48
	$E^{(7)}$	144
	$E^{(8)}$	192
$E^{(9)}$	240	
$E^{(10)}$	360	
$E^{(11)}$	600	
(C)	$\Delta(3n^2)$	$3n^2$
	$C_{n,l}^{(k)}$	$3nl$
	$D_{3l,l}^{(1)}, l = 2k$	$9l^2$
(D)	$\Delta(6n^2)$	$6n^2$
(E)	$H_{36} = \Sigma_{36 \times 3}$	108
(F)	$H_{72} = \Sigma_{72 \times 3}$	216
(G)	$H_{216} = \Sigma_{216 \times 3}$	648
(H)	$H_{60} = \Sigma_{60}$	60
(I)	$H_{168} = \Sigma_{168}$	168
(L)	$H_{360} = \Sigma_{360 \times 3}$	1080

Table 1: Classification of finite subgroups Γ of $SU(3)$ and the list of Γ used in this paper with their order $|\Gamma|$.

For a given Γ , one can write down all the invariant polynomials F_i ($i = 1, \dots, p$) in terms of the complex coordinates (Z_1, Z_2, Z_3) of \mathbb{C}^3 . Then the singular equation of $X = \mathbb{C}^3/\Gamma$ can be written as q independent relations among F_i . If $q = 1$, $p = 4$, X is a hypersurface. If $q > 1$ and $(p - q) = 3$, X is a complete intersection of q equations. If $q > 1$ and $(p - q) < 3$, X is a non-complete intersection of q equations. For example, for the group $\Gamma = \mathbb{Z}_n \times \mathbb{Z}_n$ with generators

$$\text{diag}(\omega, 1, \omega^{-1}), \text{diag}(\omega, \omega^{-1}, 1) \quad (\omega = e^{2\pi i/n}) \quad (1.5)$$

acting on (Z_1, Z_2, Z_3) , the invariant polynomials are

$$F_1 = Z_1^n, F_2 = Z_2^n, F_3 = Z_3^n, F_4 = Z_1 Z_2 Z_3. \quad (1.6)$$

There is a single relation among F_i , which is the hypersurface description of the singularity $\mathbb{C}^3/(\mathbb{Z}_n \times \mathbb{Z}_n)$:

$$F_1 F_2 F_3 = F_4^n. \quad (1.7)$$

In this paper, we only explicitly study the the following cases, where the resolution \tilde{X} is easier to perform:

1. Abelian groups $\Gamma = \mathbb{Z}_n$ or $\mathbb{Z}_m \times \mathbb{Z}_n$. In these cases, $X = \mathbb{C}^3/\Gamma$ is always toric, which can be resolved in the standard triangulation method. We discuss the geometry and physics of these cases in section 3.1.
2. X is a hypersurface in \mathbb{C}^4 , where the resolution procedure is reviewed in section 2.2.1.
3. X is a complete intersection of two equations in \mathbb{C}^5 , where the resolution procedure is discussed in section 2.2.2.

The case 2 and 3 were classified in [71, 74], where the notations for Γ are different. We list the 5d rank r and flavor rank f of T_X^{5d} and the codimension-two ADE singularities of X in table 2. Note that we only listed the cases of non-abelian Γ there, while examples of abelian Γ can be found in table 5 and 6.

For some of the cases, the singular equation X can also be embedded in a non-compact elliptic Calabi-Yau threefold. Namely, if X can be rewritten as

$$y^2 = x^3 + fx + g, \quad (1.8)$$

where f and g are holomorphic functions in other coordinates, then it can be embedded in the singular Weierstrass model

$$y^2 = x^3 + fxZ^4 + gZ^6. \quad (1.9)$$

$[x : y : Z]$ are the projective coordinates of $\mathbb{P}^{2,3,1}$, and $Z = 0$ is the zero section of the elliptic CY3. In this description, we can also define the 6d (1,0) SCFT T_X^{6d} and study its tensor branch generated by blowing up the base B_2 [75–78]. In section 2.5 we explicitly give the relation between T_X^{6d} and T_X^{5d} from the same singularity X . Namely, if T_X^{6d} is very-Higgsable, in the terminology of [79], T_X^{5d} is generated by decoupling a matter hypermultiplet from the 5d KK theory of T_X^{6d} . If T_X^{6d} is non-very-Higgsable, T_X^{5d} is constructed by decoupling vector multiplets from the 5d KK theory of T_X^{6d} . This lines up with the philosophy of [13].

We present examples of this 6d/5d correspondence in section 4.1, 4.2 and 4.3. In particular, in the case of $\Delta(48)$ (section 4.2.1), the tensor branch takes the form of type I_1 singular fiber on a (-1) -curve. We argue that it corresponds to a 6d SCFT that is potentially different from the rank-1 E-string, using both geometry and anomaly arguments. Similar arguments can be applied to the case of H_{168} as well, whose tensor branch takes the form of type II singular fiber on a (-1) -curve, see appendix B.5.1.

For a 5d SCFT T_X^{5d} from $X = \mathbb{C}^3/\Gamma$, a question of interest is how to read off the global symmetry from group theoretic data of Γ . We separate this question into the usual (0-form) flavor symmetry and the 1-form symmetry.

Γ		r	f	codimension 2 ADE
$\Delta(3n^2)$	$3 \mid n$	$\frac{1}{6}(n^2 - 3n + 6)$	$n + 5$	$A_{n-1} \times A_2^3$
	$3 \nmid n$	$\frac{1}{6}(n^2 - 3n + 2)$	$n + 1$	$A_{n-1} \times A_2$
$\Delta(6n^2), n = 2k + 1$	$3 \mid n$	$\frac{1}{12}(n^2 + 6n - 3)$	$\frac{1}{2}n + \frac{7}{2}$	$A_{n-1} \times A_1 \times A_2^3$
	$3 \nmid n$	$\frac{1}{12}(n^2 + 6n - 7)$	$\frac{1}{2}n + \frac{3}{2}$	$A_{n-1} \times A_1 \times A_2$
$\Delta(6n^2), n = 2k$	$3 \mid n$	$\frac{1}{12}(n^2 + 6n - 12)$	$\frac{1}{2}n + 5$	$D_{n/2+2} \times A_1 \times A_2^3$
	$3 \nmid n$	$\frac{1}{12}(n^2 + 6n - 16)$	$\frac{1}{2}n + 3$	$D_{n/2+2} \times A_1 \times A_2$
$C_{3l,l}^{(1)}$		$\frac{1}{2}l^2 - \frac{1}{2}l + 1$	$l + 5$	$A_{l-1} \times A_2^3$
$C_{7l,l}^{(2)}$	$3 \mid l$	$\frac{1}{6}(7l^2 - 3l + 6)$	$l + 5$	$A_{l-1} \times A_2^3$
	$3 \nmid l$	$\frac{1}{6}(7l^2 - 3l + 2)$	$l + 1$	$A_{l-1} \times A_2$
$D_{3l,l}^{(1)}, l = 2k$		$\frac{1}{4}l^2 + 2l - 1$	$\frac{1}{2}l + 5$	$D_{l/2+2} \times A_1 \times A_2^2$
G_m	$2 \mid m$	$\frac{1}{2}m$	$m + 5$	$D_{m+2} \times A_1^3$
	$2 \nmid m$	$\frac{1}{2}m - \frac{1}{2}$	$m + 3$	$D_{m+2} \times A_1^2$
$G_{p,q}$	$2 \mid p$	$pq^2 - \frac{1}{2}pq + 2q - 2$	$pq + 2q + 3$	$D_{pq+2} \times A_1^2 \times A_{2q-1}$
	$2 \nmid p$	$pq^2 - \frac{1}{2}pq + \frac{1}{2}q - 1$	$pq + 2q + 1$	$D_{pq+2} \times A_1 \times A_{2q-1}$
G'_m	$2 \mid m$	$\frac{1}{2}m$	$m + 2$	$D_{m+2} \times A_1$
	$2 \nmid m$	$\frac{1}{2}(m + 1)$	$m + 4$	$D_{m+2} \times A_1^2$
$E^{(1)}$		5	10	$E_6 \times A_2^2$
$E^{(2)}$		1	4	$D_4 \times A_2$
$E^{(3)}$		3	9	$E_7 \times A_1^2$
$E^{(4)}$		1	5	$E_6 \times A_1$
$E^{(5)}$		4	7	$E_6 \times A_3$
$E^{(6)}$		3	7	$E_6 \times A_1$
$E^{(7)}$		7	9	$E_7 \times A_2$
$E^{(8)}$		10	11	$E_7 \times A_3 \times A_1$
$E^{(9)}$		4	9	$E_8 \times A_1$
$E^{(10)}$		8	10	$E_8 \times A_2$
$E^{(11)}$		16	12	$E_8 \times A_4$
H_{36}		4	5	$A_3 \times A_2 \times A_2$
H_{60}		0	4	$A_4 \times A_2 \times A_1$
H_{72}		5	5	$D_4 \times A_2$
H_{168}		1	3	$A_3 \times A_2$
H_{216}		9	5	$D_4 \times A_2^2$
H_{360}		5	6	$A_4 \times A_3 \times A_2^2$

Table 2: Summary of the data associated to the non-abelian groups Γ covered in this paper.

Γ	r	f	G_F	IR description
G_{2k}	k	$2k + 5$	$SO(4k + 8) \times SU(2)$	$Sp(k) + (2k + 4)\mathbf{F}$
G'_{2k+1}	$k + 1$	$2k + 5$	$SO(4k + 10)$	$4\mathbf{F} - SU(2) - SU(2)_0 - \dots - SU(2)_0$
$E^{(6)}$	3	8	$E_6 \times SU(2) \times U(1)$	$SU(3)_0 - SU(2) - 5\mathbf{F}$
$\Delta(27)$	1	8	E_8	$SU(2) + 7\mathbf{F}$
$\Delta(54)$	2	5	$Sp(4) \times Sp(1)$	$G_2 + 4\mathbf{F}$
H_{36}	4	5	$SU(4) \times Sp(2)$	$SU(2)_0 - \overset{2\mathbf{F}}{G_2} - SU(2)_0$

Table 3: A number of T_X^{5d} with known 5d gauge theory descriptions.

1. Lie algebra of the 0-form flavor symmetry G_F

We find out that G_F may be different from the factors read off directly from codimension-two singularities. These subtleties are discussed in section 2.3.

As an example, in section 4.2.2 we discuss the case of $\Delta(48)$. The singularity $X = \mathbb{C}^3/\Delta(48)$ has a type A_3 and a type A_2 codimension-two singularity, which naively gives rise to a rank-1 theory with $G_F = SU(4) \times SU(3)$. Nonetheless, due to the splitting of flavor curve on the compact divisor S_1 , the flavor symmetry factor $SU(4)$ is broken to $SU(2)^2 \times U(1)$.

2. 1-form symmetry $\Gamma^{(1)}$

The higher form symmetry of 5d SUSY quantum field theories has been studied in [6–8, 80–83], using geometric and field theoretic approaches. In this paper, we propose a method to compute the electric 1-form symmetry $\Gamma^{(1)}$ of T_X^{5d} using the McKay quiver of Γ , see section 2.4. Most of the cases with a non-trivial $\Gamma^{(1)}$ are the abelian ones, $\Gamma = \mathbb{Z}_n$, and the results are cross-checked with toric geometry methods in section 3.1. We present a partial list of examples in table 5.

We list a number of theories with their IR gauge theory descriptions and G_F in table 3, where Γ is non-abelian. For the cases of abelian Γ , see table 5 and table 6 for a (non-complete) list.

Besides these cases, we also studied the resolutions for a number of higher rank SCFTs. For $\Delta(3n^2)$ theory with $n = 3k$, the flavor symmetry is enhanced to $G_F = SU(3k) \times E_6$. For example, the $\Delta(108)$ theory is a rank-4 SCFT with $G_F = SU(6) \times E_6$ and the triple intersection numbers in (4.18). The $\Delta(243)$ theory is a rank-10 SCFT with $G_F = SU(9) \times E_6$ and triple intersection numbers in (4.23).

Moreover, the $C_{3,1}^{(3)}$ theory is a rank-4 SCFT with $f = 8$, the triple intersection numbers are shown in (B.103). The $D_{6,2}$ theory is a rank-4 SCFT with $f = 6$, the triple intersection numbers are shown in (B.107). We also presented the resolution sequences for $\Delta(6n^2)$, $n = 2k$, H_{72} and H_{216} without computing the triple intersection numbers in appendix B.

The structure of the paper is as follows: in section 2 we discuss the general mathematical setup of McKay correspondence, resolution of singularities, flavor symmetry, the

way of computing 1-form symmetry and the 6d/5d correspondence. In section 3 we give a list of finite subgroups of $SU(3)$ that we study in this paper. In particular the section 3.1 covers the cases of abelian Γ , which corresponds to toric Calabi-Yau threefolds, and the 5d physics is also discussed. In section 4 we present a number of notable examples for the 6d/5d correspondence, where the 6d tensor branch geometry and the 5d resolved geometry are discussed in details. In appendix A we list a number of Γ and their maximal abelian subgroups, from which one can read off the codimension-two singularities of \mathbb{C}^3/Γ . In appendix B we present the details of other non-abelian Γ examples, their resolution geometry and 6d/5d physics.

2 3d McKay correspondence, resolution and physics

2.1 Ito-Reid theorem on \mathbb{C}^3/Γ orbifolds

In this section, we review Ito-Reid's result on the McKay correspondence of \mathbb{C}^3/Γ orbifolds [84], where Γ is a finite subgroup of $SU(3)$. We denote the conjugacy classes of Γ by $\mathfrak{g}_1, \mathfrak{g}_2, \dots, \mathfrak{g}_n$. All the group elements $g \in SL(3, \mathbb{C})$ in the same conjugacy class \mathfrak{g}_i have the same eigenvalues $\{\lambda_i\}$. If these group elements are all of order r :

$$g^r = 1, \quad (2.1)$$

then the eigenvalues can be written as

$$\{\lambda_i\} = \left\{ \exp\left(\frac{2\pi ia}{r}\right), \exp\left(\frac{2\pi ib}{r}\right), \exp\left(\frac{2\pi ic}{r}\right) \right\} := \frac{1}{r}(a, b, c) \quad (0 \leq a, b, c < r). \quad (2.2)$$

We define the *age* of a group element g and its corresponding conjugacy class \mathfrak{g}_i to be

$$\text{age}(g) = \text{age}(\mathfrak{g}_i) := \frac{1}{r}(a + b + c). \quad (2.3)$$

Hence the identity element $\mathbf{1}$ has

$$\text{age}(\mathbf{1}) = 0 \quad (2.4)$$

and is the only element whose age is 0. The other group elements either have $\text{age}(g) = 1$, which are called *junior* elements, or $\text{age}(g) = 2$. We denote the set of conjugacy classes \mathfrak{g}_i with $\text{age}(\mathfrak{g}_i) = m$ by Γ_m .

Ito-Reid proved that for every \mathbb{C}^3/Γ orbifold, there exists a crepant resolution

$$\phi : \tilde{X} \rightarrow \mathbb{C}^3/\Gamma, \quad (2.5)$$

such that

$$\begin{aligned} b_{2m}(\tilde{X}) &= |\Gamma_m| \quad (m = 0, 1, 2) \\ b_3(\tilde{X}) &= 0, \end{aligned} \quad (2.6)$$

and there is no residual terminal singularity.

Hence the total number of conjugacy classes is equal to the Euler characteristic of \tilde{X} :

$$\begin{aligned} \chi(\tilde{X}) &= b_0(\tilde{X}) + b_2(\tilde{X}) + b_4(\tilde{X}) \\ &= 1 + |\Gamma_1| + |\Gamma_2|. \end{aligned} \quad (2.7)$$

Namely, there is a one-to-one correspondence between the 2-cycles in \tilde{X} and the junior conjugacy classes in Γ_1 . There is also a one-to-one correspondence between 4-cycles in \tilde{X} and the conjugacy classes in Γ_2 . In the language of 5d SCFT, it means that for a 5d SCFT constructed from M-theory on the orbifold singularity \mathbb{C}^3/Γ , its rank r and flavor rank f can be computed group theoretically ¹:

$$\begin{aligned} r &= b_4(\tilde{X}) \\ &= |\Gamma_2| \end{aligned} \tag{2.8}$$

$$\begin{aligned} f &= b_2(\tilde{X}) - b_4(\tilde{X}) \\ &= |\Gamma_1| - |\Gamma_2|. \end{aligned} \tag{2.9}$$

In practice, the conjugacy classes corresponding to f can be computed in the following way. For any junior conjugacy class $\mathfrak{g}_i \in \Gamma_1$ with elements $g_{i,1}, \dots, g_{i,m}$. The inverse elements $g_{i,1}^{-1}, \dots, g_{i,m}^{-1}$ all belong to the same conjugacy class \mathfrak{g}_j . There are the following two cases:

1. $\mathfrak{g}_j \in \Gamma_2$. \mathfrak{g}_i and \mathfrak{g}_j correspond to a pair of 2-cycle and 4-cycle that are Poincaré dual to each other.
2. $\mathfrak{g}_j \in \Gamma_1$, \mathfrak{g}_i corresponds to a flavor curve, which is Poincaré dual to a non-compact 4-cycle D_i . Hence it contributes to the flavor rank f . We denote the set of these conjugacy classes by $\Gamma_{1,f}$.

2.2 Resolution

In this section, we review the basics of resolution techniques used in this paper, which can be applied to more general canonical threefold singularities as well. Note that for a given singularity, we always choose a crepant resolution $\phi : \tilde{X} \rightarrow \mathbb{C}^3/\Gamma$ such that all compact 2-cycles are contained inside the compact 4-cycles (for the cases of $b_4(\tilde{X}) > 0$). Physically, the resulting configuration of compact surfaces describes the Coulomb branch of T_X^{5d} with the maximal flavor rank f , which matches the group theory result (2.9). For the cases of abelian Γ , the threefold singularity is always toric, and one can apply the standard toric resolution as a maximal triangulation of polygons [85–87], see section 3.1.

2.2.1 Hypersurface

Starting from a singular hypersurface equation $X \subset \mathbb{C}^4$, we consider the crepant resolution of singularity X

$$\phi : \tilde{X} \rightarrow X, \quad K_{\tilde{X}} = \phi^* K_X. \tag{2.10}$$

The resolution involves a sequence of blow-ups of the ambient space. We use the notation in [6, 11, 88], and the possible blow-ups are [89, 90]:

¹Because $b_3(\tilde{X}) = 0$, there is no extra contribution to f as in [6].

1. Weighted blow-up of the locus $x_1 = x_2 = x_3 = x_4 = 0$ on the ambient space, with weights $(a_1, a_2, a_3, a_4) = (3, 2, 1, 1)$, $(2, 1, 1, 1)$ or $(1, 1, 1, 1)$. This blow-up is denoted by $(x_1^{(a_1)}, x_2^{(a_2)}, x_3^{(a_3)}, x_4^{(a_4)}; \delta)$, or simply $(x_1, x_2, x_3, x_4; \delta)$ iff the weights are exactly $(1, 1, 1, 1)$. The exceptional divisor on the ambient space is $\delta = 0$, which has the topology $\mathbb{P}^{a_1, a_2, a_3, a_4}$. After the blow-up, the singular equation is properly transformed by $x_i \rightarrow x_i \delta^{a_i}$, and the whole equation is divided by $\delta^{\sum_{i=1}^4 a_i - 1}$. A new SR ideal generator $x_1 x_2 x_3 x_4$ appears as well.
2. Blow-up of the locus $x_1 = x_2 = x_3 = 0$ on the ambient space, with weights $(w_1, w_2, w_3) = (1, 1, 1)$. The blow-up is denoted by $(x_1, x_2, x_3; \delta)$. After the blow-up, the singular equation is properly transformed by $x_i \rightarrow x_i \delta$, and the whole equation is divided by δ^2 . A new SR ideal generator $x_1 x_2 x_3$ appears.
3. Blow-up of the locus $x_1 = x_2 = 0$ on the ambient space, with weights $(w_1, w_2) = (1, 1)$. The blow-up is denoted by $(x_1, x_2; \delta)$. After the blow-up, the singular equation is properly transformed by $x_i \rightarrow x_i \delta$, and the whole equation is divided by δ . A new SR ideal generator $x_1 x_2$ appears.

After the resolution sequence, if the SR ideal does not involve polynomial generators, then the ambient space Σ can still be considered as toric. The intersection numbers among divisors $S_{\Sigma, i}$ on Σ are computed in the standard way, and the intersection numbers of divisors S_i on the anticanonical hypersurface \tilde{X} can be computed as

$$S_i \cdot S_j \cdot S_k = -K_\Sigma \cdot S_{\Sigma, i} \cdot S_{\Sigma, j} \cdot S_{\Sigma, k}. \quad (2.11)$$

Subtlety arises when the blow-up locus is singular by itself. For example, if we try to resolve the equation $F(x, y, z, w) = 0$ at the codimension-two locus

$$x = y = f(z, w) = 0, \quad (2.12)$$

where $f(z, w)$ is singular at $z = w = 0$. In this case, we can define a new variable

$$U \equiv f(z, w), \quad (2.13)$$

and the hypersurface equation is equivalent to a complete intersection

$$\begin{cases} F(x, y, z, w, U) = 0 \\ U - f(z, w) = 0. \end{cases} \quad (2.14)$$

After the blow-up $(x, y, f(z, w); \delta)$, the proper transform of second equation is

$$U\delta - f(z, w) = 0, \quad (2.15)$$

which is still singular at

$$U = \delta = z = w = 0, \quad (2.16)$$

and additional blow-ups are required.

In general, if the resolution locus is singular, one always need to introduce a new variable and transform the hypersurface equation into a complete intersection.

2.2.2 Complete intersection in ambient 5-fold

In this section, we consider the canonical threefold singularity X given by the complete intersection of two equations f_1 and f_2 in \mathbb{C}^5 . One can similarly resolve X by blowing up the fivefold ambient space Σ . We denote a blow-up of variables x_1, x_2, \dots, x_k with weight (a_1, a_2, \dots, a_k) by

$$(x_1^{(a_1)}, x_2^{(a_2)}, \dots, x_k^{(a_k)}; \delta), \quad (2.17)$$

where $\delta = 0$ is the exceptional divisor E . If $a_1 = a_2 = \dots = a_k = 1$, the subscripts of x_i can be omitted. Then after the replacement

$$x_i = x'_i \delta^{a_i} \quad (i = 1, \dots, k), \quad (2.18)$$

f_1 and f_2 takes the form of

$$f_j = f'_j \delta^{p_j} \quad (j = 1, 2). \quad (2.19)$$

f'_j is an irreducible holomorphic polynomial in the new variable x_i . The new complete intersection X' is given by $f'_1 = f'_2 = 0$.

Now we derive the condition for crepant resolution. Denote the divisors associated to x_i by D_i , hence the new divisor associated to x'_i is $D_i - a_i E$ after the blow-up. We denote the divisor class of $f_i = 0$ in X by F_i . Before the blow-up, from the adjunction formula the canonical class of X is given by

$$K_X = (K_\Sigma + F_1 + F_2) \cdot F_1 \cdot F_2. \quad (2.20)$$

The Calabi-Yau condition of X means $K_X = 0$. After the blow up, K_Σ is transformed as

$$K_{\Sigma'} = \phi^*(K_\Sigma) + \sum_{i=1}^k a_i E - E. \quad (2.21)$$

Hence the canonical class of the resolved X'

$$K_{X'} = (K_{\Sigma'} + F'_1 + F'_2) \cdot F'_1 \cdot F'_2 \quad (2.22)$$

is trivial iff $K_{\Sigma'} + F'_1 + F'_2 = 0$. Since the proper transformation of F_i ,

$$F'_i = F_i - p_i E, \quad (2.23)$$

the condition for a crepant resolution is

$$\sum_{i=1}^k a_i - 1 = p_1 + p_2. \quad (2.24)$$

After the blow-up, we replace the notations of F' , x' and f' by F , x and f to simplify the notations. Also, a new SR ideal generator $x_1 x_2 \dots x_k$ in the ambient space will be added.

The triple intersection numbers of divisors S_i in \tilde{X} can be computed from the ambient space divisors S_{Σ_i} as

$$S_i \cdot S_j \cdot S_k = F_1 \cdot F_2 \cdot S_{\Sigma_i} \cdot S_{\Sigma_j} \cdot S_{\Sigma_k} \quad (2.25)$$

Let us present a simple example of resolving a complete intersection, and computing the triple intersection number of compact divisors in the resolved CY3. Consider the complete intersection of two generic quadratic equations in \mathbb{C}^5 :

$$\begin{cases} f_1(x, y, z, u, v) = 0 \\ f_2(x, y, z, u, v) = 0. \end{cases} \quad (2.26)$$

The crepant resolution is

$$(x, y, z, u, v; \delta_1). \quad (2.27)$$

As one can check, $p_1 = p_2 = 2$ in this case, and the crepant condition (2.24) holds.

In the original \mathbb{C}^5 , the non-compact divisor associated to $x = 0$, $y = 0$, $z = 0$, $u = 0$ and $v = 0$ are all linearly equivalent, which is denoted as D . Its self-intersection number is

$$D^5 = 1. \quad (2.28)$$

After blowing up the 5d ambient space, these divisors are transformed to $D - E_1$, where $E_1 : \delta_1 = 0$ is the exceptional divisor in the ambient space. Because we have an SR ideal $\{xyzwv\}$, the following intersection number vanishes:

$$(D - E_1)^5 = 0. \quad (2.29)$$

In this case, all the crossing terms between D and E_1 vanish, and the only non-vanishing intersection number involving E_1 is

$$E_1^5 = 1. \quad (2.30)$$

Now we can evaluate the triple intersection number S_1^3 , where $S_1 = E_1 \cdot F_1 \cdot F_2$ is the compact complex surface in the resolved CY3 \tilde{X} . As $F_1 = F_2 = -2E_1$ (2.23), this number is computed as

$$\begin{aligned} S_1^3 &= E_1^3 \cdot F_1 \cdot F_2 \\ &= 4E_1^5 \\ &= 4. \end{aligned} \quad (2.31)$$

From the self-triple intersection number, we can see that topology of S_1 is dP_5 . This is consistent with the definition of dP_5 as the complete intersection of two quadratics in \mathbb{P}^4 .

2.2.3 Applicability of intersection number computations

Here we comment on the applicability of triple intersection number computations described in section 2.2.1 and 2.2.2, based on toric ambient spaces. If one tries to compute the triple intersection numbers among all the compact divisors S_i and non-compact divisors D_α in \tilde{X} , one needs to work out the full resolution. The full projective relations (and SR ideal) would generally involve polynomial terms, and in such cases the resolved CY3 \tilde{X} cannot be taken as a hypersurface or complete intersection inside a toric ambient space.

Nonetheless, if one only wants the triple intersection numbers among the compact divisors S_i , in many cases there exists a partial resolution $\phi_1 : X_1 \rightarrow X$ where the exceptional loci contains all the desired compact divisors S_i :

$$\phi_1^{-1}(0) = \bigcup_{i=1}^r S_i. \quad (2.32)$$

The projective relations on X_1 only involves monomial terms, and X_1 can still be thought as a hypersurface or complete intersection inside a toric ambient space. The partially resolved X_1 still contains codimension-two singularities at the subset $s_1 \in X_1$, and after the resolution $\phi_2 : \tilde{X} \rightarrow X$, we get the fully resolved \tilde{X} with exceptional locus

$$\phi_2^{-1}(s_1) = \bigcup_{i=1}^f D_\alpha. \quad (2.33)$$

If the resolution ϕ_2 does not involve the blowing up of ambient space divisors $S_{\Sigma,i}$ corresponding to S_i , the triple intersection numbers $S_i \cdot S_j \cdot S_k$ are unchanged through the resolution ϕ_2 , and one can compute them via the partial resolution ϕ_1 .

As a positive example, consider the singularity corresponding to $\Delta(27)$ in section 4.1.2:

$$w^6 - 3w^4x + 3w^2x^2 - x^3 - 4w^3y + 4wxy + 8y^2 - 16w^3z^3 + 24wxz^3 + 24yz^3 + 72z^6 = 0. \quad (2.34)$$

The first partial resolution ϕ_1 is given by a weighted blow-up $(x^{(2)}, y^{(3)}, z^{(1)}, w^{(1)}; \delta_1)$ in the toric ambient space. After this step, the partially resolved X_1 only has codimension-two singularity at non-toric loci, which can be further resolved to get the eight non-compact exceptional divisors. The point is, the second step of resolution ϕ_2 does not involve the blowing up of δ_1 , thus it does not change the triple intersection number S_1^3 of $S_1 : \delta_1 = 0$ computed in the first step, and we still have

$$S_1^3 = 1. \quad (2.35)$$

S_1 indeed has the topology of a generalized dP_8 as a degree-6 hypersurface in the weighted projective space $\mathbb{P}^{2,3,1,1}$.

As a negative example, consider the singularity corresponding to $\Delta(48)$ in section 4.2.2:

$$w^6 - 3w^4x + 3w^2x^2 - x^3 - 4w^3y + 4wxy + 8y^2 - 16w^3z^4 + 24wxz^4 + 24yz^4 + 72z^8 = 0. \quad (2.36)$$

After the partial resolution ϕ_1 given by the same blow-up $(x^{(2)}, y^{(3)}, z^{(1)}, w^{(1)}; \delta_1)$, the resulting equation

$$w^6 - 3w^4x + 3w^2x^2 - x^3 - 4w^3y + 4wxy + 8y^2 + (-16w^3z^4 + 24wxz^4 + 24yz^4)\delta_1 + 72z^8\delta_1^2 = 0. \quad (2.37)$$

has a codimension-two singularity at

$$x = y = w^3 - 27z^4\delta_1 = 0. \quad (2.38)$$

There is no way to resolve this singularity without blowing up the δ_1 coordinate. Hence one cannot simply apply the triple intersection number computation of S_1^3 from the toric ambient space.

2.3 Codimension-two singularities and flavor symmetry

2.3.1 Codimension-two singularity from group structure of Γ

In this section, we propose a procedure of reading off codimension-two singularities of \mathbb{C}^3/Γ , which are labeled by ADE Lie algebra \mathfrak{g}_{ADE} , from the group theoretic data of Γ .

Conjecture 1: consider the maximal subgroups $\tilde{G}_i \in \Gamma$ of type \mathbb{Z}_N , \mathbb{D}_N , \mathbb{E}_6 , \mathbb{E}_7 and \mathbb{E}_8 , where every non-identity element belongs to the set $\Gamma_{1,f}$. We define an equivalence relation \sim among \tilde{G}_i : $\tilde{G}_i \sim \tilde{G}_j$ if and only if there exists group isomorphism $f : \tilde{G}_1 \rightarrow \tilde{G}_2$, such that $\forall g \in \tilde{G}_1$, $f(g)$ and g belong to the same conjugacy class of Γ . Then each equivalence class of \tilde{G}_i one-to-one corresponds to a codimension-two singularity of \mathbb{C}^3/Γ . If $\tilde{G}_i = \mathbb{Z}_N$, \mathbb{D}_N or \mathbb{E}_N , the codimension-two singularity has ADE type A_{N-1} , D_N or E_N , respectively.

In practice, the non-abelian subgroups of Γ can be difficult to enumerate. Inspired by [84], a simpler method is to write down all the maximal \mathbb{Z}_N abelian subgroups G_i of Γ whose non-identity elements belong to the set $\Gamma_{1,f}$, modded out by the equivalence relation \sim .

For each maximal \mathbb{Z}_N subgroup G_i , denote the group elements by $(\mathbf{1}, g_i, g_i^2, \dots, g_i^{N-1})$. We only consider the subgroups G_i where each non-identity element g_i belongs to a conjugacy class $\mathfrak{g} \in \Gamma_{1,f}$. Each non-identity element g_i^k ($k = 1, \dots, N-1$) gives rise to a node in the Dynkin diagram \mathfrak{g}_i of type A_{N-1} , and the nodes g_i^k and g_i^{k+1} ($k = 1, \dots, N-2$) are connected by a single edge. For each G_i , there are two cases:

1. Each group element $g^k \in \mathbb{Z}_N \subset G_i$ belongs to a different conjugacy class $\mathfrak{g}_{a(k)}$ of Γ . In this case, the contribution to the rank of G_F is $N-1$.
2. Each group element $g^k \in \mathbb{Z}_N$, ($k = 0, \dots, \lfloor \frac{N}{2} \rfloor$) belongs to a different conjugacy class $\mathfrak{g}_{a(k)}$ of Γ . For the other group elements, g^k and g^{N-k} belongs to the same conjugacy class $\mathfrak{g}_{a(k)}$. In this case, the contribution to the rank of G_F is $\lfloor \frac{N}{2} \rfloor$. This precisely corresponds to the action of \mathbb{Z}_2 outer automorphism on ADE Lie algebra, which gives rise to non-simply laced gauge groups in F-theory [91] (which is called Tate-monodromy in that context). In table 4 we list the possible (maximal) flavor symmetry factors from a certain type ADE codimension-two singularity. For an actual 5d SCFT, the flavor symmetry factor may be smaller than the expected factors in table 4, due to the fact that the compact divisor lies on the ramification point, see the discussions in section 2.3.2 and the example in section B.6.

Finally, the different A_{N-1} Dynkin diagrams are glued together by identifying nodes in the same conjugacy class. In the case of 2d McKay correspondence, this is exactly the procedure leading to ADE Dynkin diagrams. Nonetheless, in the cases of $SU(3)$ orbifolds, there are ambiguities in certain cases, due to the monodromy reduction effect. For example, consider the case of type D_4 codimension-two singularity, which is reduced to G_2 . Using the notations in Appendix A, the abelian subgroup \mathbb{Z}_4 and the resulting D_4 Dynkin diagram can be written as

$$\mathbb{Z}_4 : \{0, 1, 2, 1\} \quad \begin{array}{c} \circ \\ | \\ \circ - \circ - \circ \\ 1 \quad 2 \quad 1 \end{array} \rightarrow \begin{array}{c} \circ \quad 1 \\ | \\ \circ - \circ - \circ \\ 1 \quad 2 \quad 1 \end{array} \quad (2.39)$$

We labeled the conjugacy class of each element. Nonetheless, the abelian subgroup structure is exactly the same as an A_3 singularity, reduced to $C_2 \subset A_3$. Hence these two cases

Here the blue dots correspond to the conjugacy classes in Γ_2 , which correspond to the compact divisors in T_5 . The black dots denotes the inverse conjugacy classes of the blue ones, which correspond to the Poincaré dual of the compact divisors. The yellow dots correspond to the elements in the set $\Gamma_{1,f}$.

As one can see, the elements in $\Gamma_{1,f}$ along with the identity element $\mathbf{1}$ exactly form three commuting \mathbb{Z}_N 's in Γ . They give rise to the codimension-two singularity of type $\mathfrak{g}_{ADE} = A_{N-1}^3$, and UV flavor symmetry $G_F = SU(N)^3$. When $N = 3$, the flavor symmetry is further enhanced to $G_F = E_6$, which cannot be detected by this method.

2.3.2 5d flavor symmetry from resolution

After the equation for an orbifold singularity \mathbb{C}^3/Γ is written down, one can compute the loci and ADE types of codimension-two singularities via the local Jacobian rings for example. As we show in section 3.3 and 3.4, for all of the \mathbb{C}^3/Γ covered in this paper, the 5d flavor rank f always matches the number of non-compact exceptional divisors from the resolution of codimension-two singularities.

In general, after resolving a codimension-two singularity of ADE type \mathfrak{g}_{ADE} , there will be a number of non-compact exceptional divisors D_j ($j = 1, \dots, f$) in \tilde{X} . Along with the compact exceptional divisors S_i , there will be \mathbb{P}^1 curves

$$C_j = D_j \cdot \left(\sum_i \xi_{i,j} S_i \right) \quad (2.45)$$

with normal bundle $N_{C|\tilde{X}} = \mathcal{O} \oplus \mathcal{O}(-2)$, which are called flavor curves in [10–12] (the integer coefficient $\xi_{i,j}$ is defined in [13], which depends on the detailed resolution sequence). M2-brane wrapping modes on C_j precisely give rise to the W-boson of the non-Abelian flavor symmetry factor. The symmetrized Cartan matrix [94] is computed from the triple intersection numbers as

$$C_{jk} = -\frac{2\langle \alpha, \alpha \rangle_{\max} \langle \alpha_j, \alpha_k \rangle}{\langle \alpha_j, \alpha_j \rangle \langle \alpha_k, \alpha_k \rangle} = D_j \cdot D_k \cdot \left(\sum_i \xi_{i,j} S_i \right). \quad (2.46)$$

Naively, the flavor symmetry factor from an ADE singularity type is given by table 4. The non-simply-laced factor appears when

$$f < \text{rk}(\mathfrak{g}_{ADE}). \quad (2.47)$$

Nonetheless, the actual 5d flavor symmetry may be different from the expectation. As an example, consider the geometry in figure 1, where there exists a non-compact exceptional divisor D from the resolution of a codimension-two A_1 singularity and a family of divisors S_t , $t \in \mathbb{C}$. For a generic S_t ($t \neq 0$), the intersection curve $D \cdot S_t$ is a smooth flavor curve with

$$S_t \cdot D^2 = -2, \quad D \cdot S_t^2 = 0. \quad (2.48)$$

But at $t = 0$, the curve splits into two components C_1 and C_2 with normal bundle $N_{C_1} = N_{C_2} = \mathcal{O}(-1) \oplus \mathcal{O}(-1)$. In fact, this geometry appears in the splitting $I_{n+1} \rightarrow I_n + I_1$ in

ADE type	Flavor symmetry factor
A_n	$SU(n+1)$ or $Sp(\lfloor \frac{n+1}{2} \rfloor)$
D_4	$SO(8)$ or $SO(7)$ or G_2
$D_{n>4}$	$SO(2n)$ or $SO(2n-1)$
E_6	E_6 or F_4
E_7	E_7
E_8	E_8

Table 4: The list of possible (maximal) flavor symmetry factors from a codimension-two singularity with type ADE, which can be different from the actual 5d flavor symmetry G_F . For a given type, the rank of flavor symmetry factor is determined by the number of different non-compact divisors (conjugacy classes in $\Gamma_{1,f}$) associated to a single codimension-two ADE singularity.

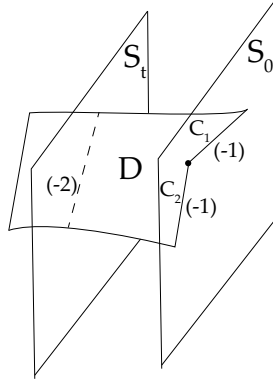

Figure 1: The splitting of flavor curve into two $\mathcal{O}(-1) \oplus \mathcal{O}(-1)$ curves.

F-theory, see e. g. [95]. In the 5d setup, suppose that S_0 is the compact divisor, and we have

$$S_0 \cdot C_1 = S_0 \cdot C_2 = -1, \quad (2.49)$$

the divisor D would generate $U(1)$ flavor symmetry instead of $SU(2)$.

We will apply this discussion to the case of $\Delta(48)$ in section 4.2.2.

As another example, consider the geometry in figure 2, which is the resolution of a codimension-two D_4 singularity

$$x^3 + y^3 t + z^2 = 0 \quad (2.50)$$

in $\mathbb{C}^4[x, y, z, t]$. The blow up sequence is

$$\begin{aligned} & (x, y, z; \delta_1) \\ & (z, \delta_1; \delta_2) \\ & (\delta_1, \delta_2; \delta_3). \end{aligned} \quad (2.51)$$

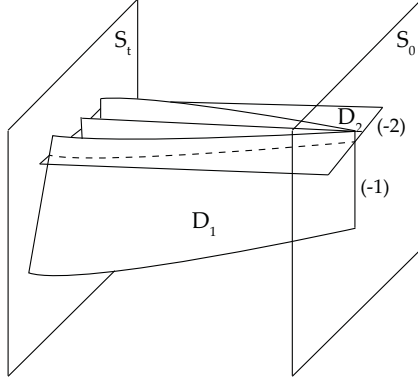

Figure 2: The ramification point of codimension-two D_4 singularity gives rise to an $\mathcal{O}(-1) \oplus \mathcal{O}(-1)$ curve on S_0 .

The resolved equation is

$$(x^3 + y^3 t)\delta_1 + z^2 \delta_2 = 0 \quad (2.52)$$

Note that there are only two irreducible non-compact divisors $D_1 : \delta_2 = 0$ and $D_2 : \delta_3 = 0$ in the resolution. The fiber over $t \neq 0$ is four \mathbb{P}^1 curves in the shape of a D_4 Dynkin diagram. Over the ramification point $t = 0$, the fiber $\delta_2 = 0$ degenerates to a single \mathbb{P}^1

$$\delta_2 = t = x = 0, \quad (2.53)$$

which is rigid and has normal bundle $\mathcal{O}(-1) \oplus \mathcal{O}(-1)$. If $t = 0$ is the location of compact divisor S_0 , then the codimension-two D_4 singularity only gives rise to flavor symmetry factor $SU(2) \times U(1)$ instead of G_2 .

This is exactly the case of $\Gamma = E^{(2)}$ in section B.6.

2.4 McKay quiver and 1-form symmetry of 5d SCFT

In this section we present the method to compute the (electric) 1-form symmetry $\Gamma^{(1)}$ of the 5d SCFT, using group theoretic data of Γ . It is based on a version of 3d McKay correspondence [96], which is proved in [97] for any $\Gamma \subset SL(3, \mathbb{C})$:

the Γ -Hilbert Scheme (Hilbert quotient) Γ -Hilb \mathbb{C}^3 is an irreducible crepant resolution of \mathbb{C}^3/Γ .

We first review the definition of McKay quiver of Γ [55, 62]. For each irrep ρ_i ($i = 0, \dots, \chi(\tilde{X}) - 1$) of Γ , we draw a node labeled by i . Then we consider the tensor product with the three-dimensional natural representation π (which can be reducible)

$$\rho_i \otimes \pi = \sum_j a_{ji} \rho_j. \quad (2.54)$$

For each non-zero a_{ji} term, we draw a_{ji} arrows from the i -th node to the j -th node. The resulting quiver diagram is the McKay quiver of Γ .

We define the antisymmetric adjacency matrix $A(\Gamma) = \{A_{ij}\}$ by

$$A_{ij} = a_{ji} - a_{ij}. \quad (2.55)$$

Now we apply corollary 5.3 of [96], and we have the following statement:

$A(\Gamma)$ has the same Smith normal form as $M(\Gamma)$, where the latter is the intersection product matrix between $\chi(\tilde{X}) = 1 + b_2(\tilde{X}) + b_4(\tilde{X})$ topological cycles of the resolved CY3 \tilde{X} .

$M(\Gamma)$ has the block form of

$$M(\Gamma) = \left(\begin{array}{c|cc} 0 & 0 & 0 \\ \hline 0 & 0 & \mathcal{M}_{b_2 \times b_4} \\ \hline 0 & (\mathcal{M}^T)_{b_4 \times b_2} & 0 \end{array} \right), \quad (2.56)$$

where $\mathcal{M}_{b_2 \times b_4}$ is the intersection matrix between compact 2-cycles and 4-cycles in \tilde{X} .

Smith normal form of $M(\Gamma)$ (which is the same as that of $A(\Gamma)$) has the form of

$$\begin{pmatrix} \alpha_1 & 0 & 0 & 0 & \dots & 0 \\ 0 & \alpha_1 & 0 & 0 & \dots & 0 \\ 0 & 0 & \alpha_2 & 0 & \dots & 0 \\ 0 & 0 & 0 & \alpha_2 & \dots & 0 \\ \vdots & \vdots & \vdots & \vdots & \ddots & \vdots \\ 0 & 0 & 0 & 0 & \dots & 0 \end{pmatrix}$$

The Smith normal form of $\mathcal{M}_{b_2 \times b_4}$ then takes the form of

$$D = \begin{pmatrix} \alpha_1 & 0 & \dots & 0 \\ 0 & \alpha_2 & \dots & 0 \\ \vdots & \vdots & \ddots & \vdots \\ 0 & 0 & \dots & \alpha_{b_4} \\ 0 & 0 & \dots & 0 \\ \vdots & \vdots & \ddots & \vdots \\ 0 & 0 & \dots & 0 \end{pmatrix} \quad (2.57)$$

The 1-form symmetry $\Gamma^{(1)}$ of T_X^{5d} is computed as [80]

$$\Gamma^{(1)} = \bigoplus_{i=1}^{b_4} \mathbb{Z}/(\alpha_i \mathbb{Z}). \quad (2.58)$$

As an example, consider the case of $\Gamma = \mathbb{Z}_5$, whose group generator is $a = \frac{1}{5}(2, 2, 1)$. The 1d representations of \mathbb{Z}_5 are denoted by ρ_i ($i = 0, \dots, 4$), where $\rho_i(a^j) = a^{ij}$.

The natural representation of \mathbb{Z}_5 in this case is

$$\pi = \rho_2 \oplus \rho_2 \oplus \rho_1. \quad (2.59)$$

The McKay quiver is

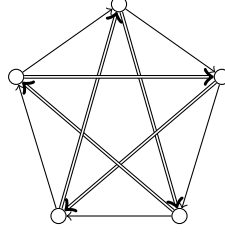

(2.60)

The antisymmetric adjacency matrix of the McKay quiver can be computed as

$$A(\mathbb{Z}_5) = \begin{pmatrix} 0 & 1 & 2 & -2 & -1 \\ -1 & 0 & 1 & 2 & -2 \\ -2 & -1 & 0 & 1 & 2 \\ 2 & -2 & -1 & 0 & 1 \\ 1 & 2 & -2 & -1 & 0 \end{pmatrix} \quad (2.61)$$

The Smith normal form of $A(\mathbb{Z}_5)$ is

$$\begin{pmatrix} 5 & 0 & 0 & 0 & 0 \\ 0 & 5 & 0 & 0 & 0 \\ 0 & 0 & 1 & 0 & 0 \\ 0 & 0 & 0 & 1 & 0 \\ 0 & 0 & 0 & 0 & 0 \end{pmatrix}, \quad (2.62)$$

which is exactly the same $M(\Gamma)$. The intersection matrix $\mathcal{M}_{2 \times 2}$ then has the Smith normal form

$$\begin{pmatrix} 5 & 0 \\ 0 & 1 \end{pmatrix}, \quad (2.63)$$

which gives rise to the correct 1-form symmetry $\Gamma^{(1)} = \mathbb{Z}_5$ of T_X^{5d} . We will check this result using toric geometry in section 3.1.1.

More generally, when $\Gamma = \mathbb{Z}_{2k+1}$, the Smith normal form of the antisymmetric adjacency matrix $A(\mathbb{Z}_{2k+1})$ is of the form $\text{diag}(2k+1, 2k+1, 1, \dots, 1, 0)$ whose dimension is $2k+1$ and the number of diagonal 1's is $2k-2$, while when $\Gamma = \mathbb{Z}_{2k}$, the Smith normal form of the antisymmetric adjacency matrix $A(\mathbb{Z}_{2k})$ is of the form $\text{diag}(k, k, 1, \dots, 1, 0, 0)$ whose dimension is $2k$ and the number of diagonal 1's is $2k-4$. The above results match the fact that the 1-form symmetry of $\mathbb{C}^3/\mathbb{Z}_{2k+1}$ theory is \mathbb{Z}_{2k+1} and the 1-form symmetry of $\mathbb{C}^3/\mathbb{Z}_{2k}$ theory is \mathbb{Z}_k . For the T_n series, the Smith normal form of the antisymmetric adjacency matrix is $\text{diag}(1, \dots, 1, 0, \dots, 0)$ whose dimension is n^2 and the number of diagonal 1's is $(n-1)(n-2)$ therefore the 1-form symmetry of T_n theory is trivial. For the $\Delta(3n^2)$ and $\Delta(6n^2)$ series a similar result holds such that the number of diagonal 1's is $2r$ and the other diagonals are zeroes therefore the 1-form symmetry of these theories are also trivial.

It is also rather trivial to compute the 1-form symmetry of the exceptional cases H_{36} , H_{60} , H_{72} , H_{168} , H_{216} , H_{360} whose McKay quivers can be found in [62, 98, 99]. The Smith normal form of the antisymmetric adjacency matrices of these exceptional cases are all of

the form $\text{diag}(1, \dots, 1, 0, \dots, 0)$ whose dimension is $\chi(\tilde{X})$ and the number of diagonal 1's is $2r$. Therefore the 1-form symmetry of this set of 5D theories is trivial. Similar results can be found for other non-abelian Γ s in table 2.

We also present a non-abelian Γ with a non-trivial 1-form symmetry, which is the following class (B) example with the generators ($\omega = e^{\pi i/3}$):

$$M_1 = \begin{pmatrix} i & 0 & 0 \\ 0 & -i & 0 \\ 0 & 0 & 1 \end{pmatrix}, \quad M_2 = \begin{pmatrix} 0 & i & 0 \\ i & 0 & 0 \\ 0 & 0 & 1 \end{pmatrix}, \quad M_3 = \begin{pmatrix} \omega & 0 & 0 \\ 0 & \omega & 0 \\ 0 & 0 & \omega^{-2} \end{pmatrix}. \quad (2.64)$$

The 5d SCFT has $r = 5$, $f = 4$ and $\Gamma^{(1)} = \mathbb{Z}_3$, and the singular equation \mathbb{C}^3/Γ is neither toric, a hypersurface nor a complete intersection of two equations. We leave a complete classification of these cases in a future work.

2.5 Relation between 6d and 5d SCFTs

Here we consider the cases where (after the redefinition of variables) the canonical threefold singularity X can be rewritten in the form of

$$y^2 = x^3 + fx + g, \quad (2.65)$$

where f and g are holomorphic functions. In this case, we can embed the singularity into a Weierstrass model

$$y^2 = x^3 + fxZ^4 + gZ^6, \quad (2.66)$$

where $[x : y : Z]$ are projective coordinates of $\mathbb{P}^{2,3,1}$. We can thus define a 6d (1,0) SCFT T_X^{6d} as F-theory on this elliptic singularity. Now we discuss the relation between T_X^{6d} and T_X^{5d} , starting with the KK reduction of T_X^{6d} on S^1 , and goes on the Coulomb branch. Geometrically, the 5d KK theory is M-theory on the resolved elliptic CY3 \tilde{X}_{ell} , with compact 4-cycles $\bigcup S_i$. The zero section $Z = 0$ is a non-compact divisor of \tilde{X}_{ell} . To get the 5d theory T_X^{5d} , the elliptic fibration structure needs to be broken, and the zero section $Z = 0$ should not intersect the compact 4-cycles any more. In order to achieve this, there are two different geometric transitions from \tilde{X}_{ell} to \tilde{X} , depending on whether T_X^{6d} is very-Higgsable:

1. (2.66) is a hypersurface equation and (f, g) are holomorphic functions on \mathbb{C}^2 . In this case, T_X^{6d} is a very-Higgsable theory as the base B in the tensor branch description can be blown down to \mathbb{C}^2 .

Now consider the intersection curves between the non-compact zero-section $Z = 0$ and compact 4-cycles S_i . Because T_X^{6d} is very-Higgsable, these curves can be linearly combined into a curve $C_Z = \sum_i \xi_{i,Z} S_i \cdot Z$ with normal bundle $\mathcal{O}(-1) \oplus \mathcal{O}(-1)$. In fact the curve C_Z corresponds to a $(n, g) = (-1, 0)$ node in the language of combined fiber diagram (CFD) [11, 13], and the coefficient $\xi_{i,Z}$ are the multiplicity factors. Then in the transition from the 6d to the 5d description, one decouples a hypermultiplet by flopping C_Z out of $\bigcup S_i$. The resulting CY3 is no longer elliptic as the zero section Z

no longer intersects the new set of compact 4-cycles $\bigcup S'_i$. The 5d SCFT T_X^{5d} defined as M-theory on X is obtained at the origin of the new Coulomb branch, where S'_i s are all shrunk to a point.

For example, in the case of

$$X : y^2 = x^3 + z^6 + w^6, \quad (2.67)$$

the 6d interpretation is the rank-1 E-string. Its KK reduction has an IR description of $SU(2) + 8\mathbf{F}$. After decoupling a fundamental hyper, we get $SU(2) + 7\mathbf{F}$ whose UV completion is the rank-1 Seiberg E_8 theory. In the resolved CY3 picture, the decoupling precisely corresponds to the blow down of a dP₉ into a dP₈. This is also consistent with the 5d interpretation of (2.67) [6].

- (2.66) is a complete intersection equation, which can be interpreted as a Weierstrass model over a singular base B . In this case, T_X^{6d} is a non-very-Higgsable theory. From the full tensor branch of T_X^{6d} , we perform a number of blow downs until the compact curves C_i ($i = 1, \dots, q$) on the resulting base all have self-intersection number $n \leq -2$. In this case, starting from the resolved elliptic CY3 \tilde{X}_{ell} , we cannot flop out the curve C_Z because its normal bundle is not $\mathcal{O}(-1) \oplus \mathcal{O}(-1)$. Alternatively, we decompactify all the vertical divisors over C_i ($i = 1, \dots, q$) (with the topology of Hirzebruch surfaces). Equivalently we decouple q $U(1)$ vector multiplets on the Coulomb branch. As a consequence, the zero-section $Z = 0$ no longer intersects \tilde{X} , and we can get the 5d SCFT T_X^{5d} as the origin of the new Coulomb branch.

Examples can be found after comparing the 6d description of $\Gamma = \Delta(54)$ in section 4.3.1 and the 5d description in section 4.3.2, or comparing the 6d description of $\Gamma = H_{36}$ in section B.3 and the 5d description in section B.3.2.

These procedures precisely match the systematics of decoupling in [13].

3 The finite subgroups of $SU(3)$

In this section we present the group theoretic data and geometry of \mathbb{C}^3/Γ orbifolds. In section 3.1 we study the cases where Γ is abelian. In these cases we are able to obtain maximal understanding of the corresponding 5d theories via both the group theoretic data of Γ and the toric geometry of the \mathbb{C}^3/Γ orbifold. In Section 3.2 we discuss the cases of non-abelian Γ which can be thought of as finite subgroups of $U(2) \subset SU(3)$. In Section 3.3 and 3.4 we study the non-abelian finite subgroups of $SU(3)$ that are not subgroups of $U(2)$. In particular, in Section 3.3 we will focus on the infinite series (cf. A and D series of finite subgroups of $SU(2)$) while in Section 3.4 we will focus on the exceptional cases (cf. E type finite subgroups of $SU(2)$).

3.1 Abelian subgroups

In this section, we discuss the simple cases of Γ being abelian. In these cases, every conjugacy class of Γ only contains a single element, and the total number of conjugacy

classes equals to the order of Γ , we have

$$|\Gamma| = 1 + |\Gamma_1| + |\Gamma_2|. \quad (3.1)$$

The generators of Γ are chosen in a way such that \mathbb{C}^3/Γ contains a codimension-three singularity.

For example, taking $\Gamma = \mathbb{Z}_3$, the generator can be chosen as either $\frac{1}{3}(1, 1, 1)$ or $\frac{1}{3}(0, 1, 2)$. In the first case, the junior conjugacy classes and age-two conjugacy classes are

$$\Gamma_1 = \left\{ \frac{1}{3}(1, 1, 1) \right\}, \quad \Gamma_2 = \left\{ \frac{1}{3}(2, 2, 2) \right\}. \quad (3.2)$$

Hence we have $r = 1$, $f = 0$, and the 5d SCFT exactly corresponds to the rank-1 Seiberg E_0 theory. The single compact exceptional divisor in the resolution \tilde{X} is exactly \mathbb{P}^2 .

In the second case, the conjugacy classes are

$$\Gamma_1 = \left\{ \frac{1}{3}(0, 1, 2), \frac{1}{3}(0, 2, 1) \right\}, \quad \Gamma_2 = \{ \}. \quad (3.3)$$

It corresponds to the singularity $\mathbb{C} \times \mathbb{C}^2/\mathbb{Z}_3$, which gives rise to a 7d $SU(3)$ SYM theory rather than a 5d theory. In the following discussions, such 7d cases are not included.

3.1.1 \mathbb{Z}_n

The generator of \mathbb{Z}_n is chosen as $\frac{1}{n}(p, q, r)$, $p + q + r = n$. The threefold singularity $\mathbb{C}^3/\mathbb{Z}_n$ is toric. Denote the three vertices of weighted projective space $\mathbb{P}^{p,q,r}$ as $v_1, v_2, v_3 \in \mathbb{Z}^2$, then the rays in the fan of the toric threefold singularity are $(v_i, 1)$ ($i = 1, 2, 3$). The resolution of $\mathbb{C}^3/\mathbb{Z}_n$ is thus given by a fine, regular star triangulation (FRST) of the 3d polytope.

Since $\mathbb{C}^3/\mathbb{Z}_n$ is toric, the (magnetic) 1-form symmetry $\Gamma^{(1)}$ of the 5d SCFT can also be computed with the procedure in [80]. Define a $3 \times (3 + f)$ matrix A_E to be the list of rays on the boundary of the 3d polytope, including $(v_i, 1)$ ($i = 1, 2, 3$), then we compute the Smith decomposition

$$A_E = SDT, \quad (3.4)$$

where D is the Smith normal form of A_E

$$D = \begin{pmatrix} \alpha_1 & 0 & 0 \\ 0 & \alpha_2 & 0 \\ 0 & 0 & \alpha_3 \\ 0 & 0 & 0 \\ \vdots & & \\ 0 & 0 & 0 \end{pmatrix} \quad (3.5)$$

The 1-form symmetry group is computed as

$$\Gamma^{(1)} = \bigoplus_{i=1}^3 \mathbb{Z}/(\alpha_i \mathbb{Z}). \quad (3.6)$$

In particular, for \mathbb{Z}_{2k+1} with the generator $\frac{1}{2k+1}(1, 1, 2k-1)$, the vertices can be chosen as

$$v_1 = (-1, -1), \quad v_2 = (0, 1), \quad v_3 = (k, 0). \quad (3.7)$$

The resolution is shown as

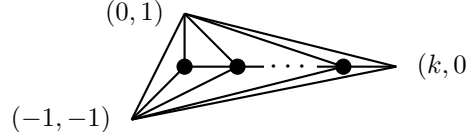

$$(3.8)$$

The black dots correspond to compact divisors. From the counting of conjugacy classes, we also get

$$|\Gamma_1| = |\Gamma_2| = k, \quad (3.9)$$

which implies

$$r = k, \quad f = 0. \quad (3.10)$$

The 1-form symmetry is generally $\Gamma^{(1)} = \mathbb{Z}_{2k+1}$.

For example, for $k = 2$, the only orbifold singularity $\mathbb{C}^3/\mathbb{Z}_5$ exactly corresponds to a rank-2 SCFT with $f = 0$, which is labeled as $\mathbb{P}^2 \cup \mathbb{F}_3$ in [16]. It has 1-form symmetry $\Gamma^{(1)} = \mathbb{Z}_5$ [80].

For arbitrary $k \geq 2$, the compact complex surfaces are $\mathbb{P}^2 \cup \mathbb{F}_3 \cup \mathbb{F}_5 \cup \dots \cup \mathbb{F}_{2k-1}$.

Similarly, for \mathbb{Z}_{2k} with the generator $\frac{1}{2k}(1, 1, 2k - 2)$, the vertices can be chosen as

$$v_1 = (-1, -1), \quad v_2 = (-1, 1), \quad v_3 = (k - 1, 0). \quad (3.11)$$

The resolution is

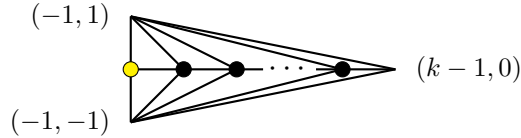

$$(3.12)$$

Here the non-compact divisor that gives rise to flavor symmetry is colored yellow. From the counting of conjugacy classes, we also get

$$|\Gamma_1| = k, \quad |\Gamma_2| = k - 1, \quad (3.13)$$

which is consistent with

$$r = k - 1, \quad f = 1. \quad (3.14)$$

The 1-form symmetry is $\Gamma^{(1)} = \mathbb{Z}_k$.

The flavor symmetry of the corresponding 5d SCFT is always $G_F = SU(2)$ for this sequence of theories. In fact, they have exactly the IR gauge theory description $SU(k)_k$ ($SU(2)_0$ when $k = 2$).

Note that for certain \mathbb{Z}_n generators, such as $\frac{1}{2k}(1, k - 1, k)$, the singularity is isomorphic to $\mathbb{C}^3/\mathbb{Z}_2 \times \mathbb{Z}_k$.

Apart from these two infinite series, we also list a number of $\mathbb{C}^3/\mathbb{Z}_n$ orbifolds with their resolutions for small n .

1. $n = 7$, generator $\frac{1}{7}(1, 2, 4)$, $r = 3$, $f = 0$, $\Gamma^{(1)} = \mathbb{Z}_7$ (this theory is known as B_4 in [80])

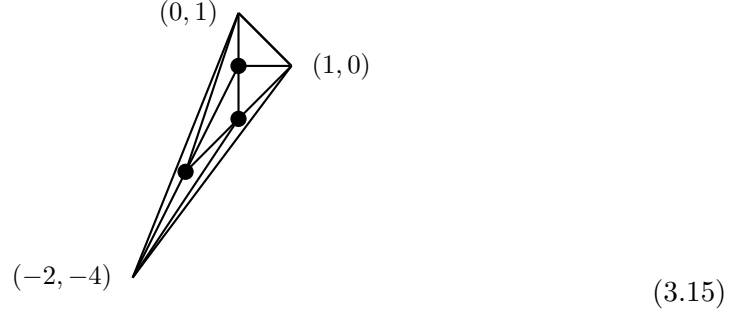

2. $n = 8$, generator $\frac{1}{8}(1, 2, 5)$, $r = 3$, $f = 1$, $G_F = SU(2)$, $\Gamma^{(1)} = \mathbb{Z}_4$

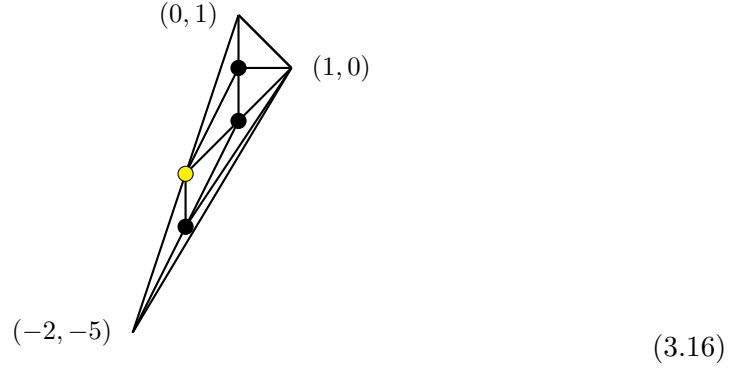

3. $n = 9$, generator $\frac{1}{9}(1, 2, 6)$, $r = 3$, $f = 2$, $G_F = SU(3)$, $\Gamma^{(1)} = \mathbb{Z}_3$

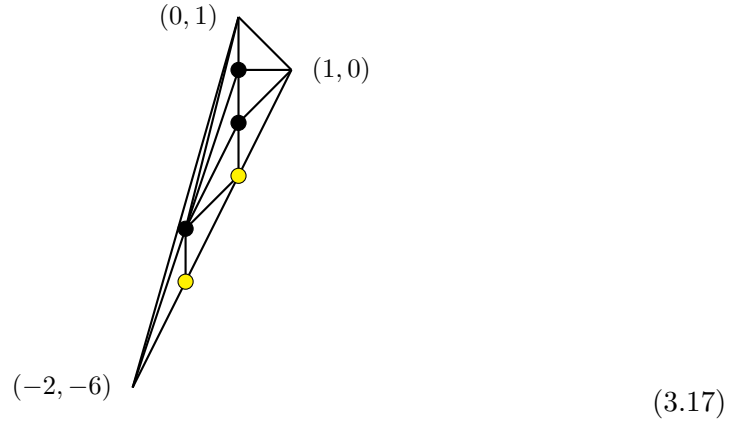

We list the physical data of $\mathbb{C}^3/\mathbb{Z}_n$ theories with small n in table 5.

3.1.2 $\mathbb{Z}_m \times \mathbb{Z}_n$

In this case, the generators of \mathbb{Z}_m and \mathbb{Z}_n are chosen as $\frac{1}{m}(1, m-1, 0)$ and $\frac{1}{n}(0, 1, n-1)$. The orbifold $\mathbb{C}^3/\mathbb{Z}_m \times \mathbb{Z}_n$ is a toric threefold singularity, with rays $(0, 0, 1)$, $(m, 0, 1)$, $(0, n, 1)$.

n	Generator	r	f	G_F	$\Gamma^{(1)}$	IR gauge theory
3	$\frac{1}{3}(1, 1, 1)$	1	0	–	\mathbb{Z}_3	–
4	$\frac{1}{4}(1, 1, 2)$	1	1	$SU(2)$	\mathbb{Z}_2	$SU(2)_0$
5	$\frac{1}{5}(1, 1, 3)$	2	0	–	\mathbb{Z}_5	–
6	$\frac{1}{6}(1, 1, 4)$	2	1	$SU(2)$	\mathbb{Z}_3	$SU(3)_3$
6	$\frac{1}{6}(1, 2, 3)$	1	3	$SU(3) \times SU(2)$	–	$SU(2) + 2\mathbf{F}$
7	$\frac{1}{7}(1, 1, 5)$	3	0	–	\mathbb{Z}_7	–
7	$\frac{1}{7}(1, 2, 4)$	3	0	–	\mathbb{Z}_7	–
8	$\frac{1}{8}(1, 1, 6)$	3	1	$SU(2)$	\mathbb{Z}_4	$SU(4)_4$
8	$\frac{1}{8}(1, 2, 5)$	3	1	$SU(2)$	\mathbb{Z}_4	–
8	$\frac{1}{8}(1, 3, 4)$	2	3	$SU(4)$	\mathbb{Z}_2	$SU(2)_0 - SU(2)_0$
9	$\frac{1}{9}(1, 1, 7)$	4	0	–	\mathbb{Z}_9	–
9	$\frac{1}{9}(1, 2, 6)$	3	2	$SU(3)$	\mathbb{Z}_3	–
10	$\frac{1}{10}(1, 1, 8)$	4	1	$SU(2)$	\mathbb{Z}_5	$SU(5)_5$
10	$\frac{1}{10}(1, 2, 7)$	4	1	$SU(2)$	\mathbb{Z}_5	–
10	$\frac{1}{10}(1, 3, 6)$	4	1	$SU(2)$	\mathbb{Z}_5	–
10	$\frac{1}{10}(1, 4, 5)$	2	5	$SU(5) \times SU(2)$	–	$SU(2)_0 - SU(2) - 2\mathbf{F}$
11	$\frac{1}{11}(1, 1, 9)$	5	0	–	\mathbb{Z}_{11}	–
11	$\frac{1}{11}(1, 2, 8)$	5	0	–	\mathbb{Z}_{11}	–
12	$\frac{1}{12}(1, 1, 10)$	5	1	$SU(2)$	\mathbb{Z}_6	$SU(6)_6$
12	$\frac{1}{12}(1, 2, 9)$	4	3	$SU(3) \times SU(2)$	\mathbb{Z}_2	$SU(4)_4 - SU(2)_0$
12	$\frac{1}{12}(1, 3, 8)$	3	5	$SU(4) \times SU(3)$	–	$SU(3)_2 - SU(2)_0 - 2\mathbf{F}$
12	$\frac{1}{12}(1, 4, 7)$	4	3	$SU(4)$	\mathbb{Z}_3	–
12	$\frac{1}{12}(1, 5, 6)$	3	5	$SU(6)$	\mathbb{Z}_2	$SU(2)_0 - SU(2)_0 - SU(2)_0$
13	$\frac{1}{13}(1, 1, 11)$	6	0	–	\mathbb{Z}_{13}	–
13	$\frac{1}{13}(1, 2, 10)$	6	0	–	\mathbb{Z}_{13}	–
13	$\frac{1}{13}(1, 3, 9)$	6	0	–	\mathbb{Z}_{13}	–

Table 5: List of $\mathbb{C}^3/\mathbb{Z}_n$ with their generators, r , f , UV flavor symmetry G_F , 1-form symmetry $\Gamma^{(1)}$ and IR gauge theory descriptions of the corresponding 5d SCFT.

For example, if $m = n$, the singularity $\mathbb{C}^3/\mathbb{Z}_n \times \mathbb{Z}_n$ exactly gives the 5d T_n theory. If $m = 3$, $n = 2$, the singularity $\mathbb{C}^3/\mathbb{Z}_3 \times \mathbb{Z}_2$ corresponds to rank-1 E_3 theory, which has the following toric diagram:

$$(0, 2) \quad (0, 0) \quad (3, 0) \quad (3.18)$$

From the picture, we can easily read off $G_F = SU(3) \times SU(2)$.

We list the basic data of $\mathbb{C}^3/\mathbb{Z}_m \times \mathbb{Z}_n$ theories with small m, n in table 6. The 1-form symmetry is always trivial for these cases.

m	n	r	f	G_F	IR gauge theory
3	2	1	3	$SU(3) \times SU(2)$	$SU(2) + 2\mathbf{F}$
4	2	1	5	$SO(10) \supset SU(4) \times SU(2)^2$	$SU(2) + 4\mathbf{F}$
5	2	2	5	$SU(5) \times SU(2)$	$SU(2)_0 - SU(2) - 2\mathbf{F}$
6	2	2	7	$SU(6) \times SU(2)^2$	$SU(3)_0 + 6\mathbf{F}/2\mathbf{F} - SU(2) - SU(2) - 2\mathbf{F}$
7	2	3	7	$SU(7) \times SU(2)$	$SU(2)_0 - SU(2)_0 - SU(2) - 2\mathbf{F}$
8	2	3	9	$SU(8) \times SU(2)^2$	$SU(4)_0 + 8\mathbf{F}/2\mathbf{F} - SU(2) - SU(2)_0 - SU(2) - 2\mathbf{F}$
3	3	1	6	$E_6 \supset SU(3)^3$	$SU(2) + 5\mathbf{F}$
4	3	3	5	$SU(4) \times SU(3)$	$SU(3)_2 - SU(2) - 2\mathbf{F}$
5	3	4	6	$SU(6) \times SU(4)$	–
6	3	4	9	$SU(6) \times SU(3)^2$	$SU(2)_0 - SU(4)_0 - 6\mathbf{F}$
7	3	6	8	$SU(7) \times SU(3)$	–
4	4	3	9	$SU(4)^3$	$4\mathbf{F} - SU(3)_0 - SU(2) - 2\mathbf{F}$
5	4	6	7	$SU(5) \times SU(4)$	$SU(4)_{\frac{5}{2}} - SU(3)_0 - SU(2) - 2\mathbf{F}$
6	4	7	9	$SU(6) \times SU(4) \times SU(2)$	$SU(2)_0 - SU(4)_{\frac{3}{2}} - SU(3)_0 - SU(2) - 2\mathbf{F}$
7	4	9	9	$SU(7) \times SU(4)$	–
5	5	6	12	$SU(5)^3$	$5\mathbf{F} - SU(4)_0 - SU(3)_0 - SU(2) - 2\mathbf{F}$
6	5	10	9	$SU(6) \times SU(5)$	$SU(5)_3 - SU(4)_0 - SU(3)_0 - SU(2) - 2\mathbf{F}$
7	5	12	10	$SU(7) \times SU(5)$	–
6	6	10	15	$SU(6)^3$	$6\mathbf{F} - SU(5)_0 - SU(4)_0 - SU(3)_0 - SU(2) - 2\mathbf{F}$
7	6	15	11	$SU(7) \times SU(6)$	$SU(6)_{\frac{7}{2}} - SU(5)_0 - SU(4)_0 - SU(3)_0 - SU(2) - 2\mathbf{F}$
7	7	15	18	$SU(7)^3$	$7\mathbf{F} - SU(6)_0 - SU(5)_0 - SU(4)_0 - SU(3)_0 - SU(2) - 2\mathbf{F}$

Table 6: List of $\mathbb{C}^3/\mathbb{Z}_m \times \mathbb{Z}_n$ with their r, f , UV flavor symmetry G_F and IR gauge theory descriptions of the corresponding 5d SCFT.

3.2 Non-abelian subgroups of $U(2)$

In this section, we discuss the cases of Γ as a non-abelian subgroup of $U(2)$, namely the class (B) in table 1. In particular, we will focus on the cases where $X = \mathbb{C}^3/\Gamma$ can be written as a hypersurface in \mathbb{C}^4 or a complete intersection of two equations in \mathbb{C}^5 , which were classified in [74].

3.2.1 Infinite sequences $G_m, G_{p,q}$ and G'_m

1. G_m

This is the case (2) of [74]. The generators are:

$$M_1 = \begin{pmatrix} \omega & 0 & 0 \\ 0 & \omega^{-1} & 0 \\ 0 & 0 & 1 \end{pmatrix}, \quad M_2 = \begin{pmatrix} -1 & 0 & 0 \\ 0 & 1 & 0 \\ 0 & 0 & -1 \end{pmatrix}, \quad M_3 = \begin{pmatrix} 0 & 1 & 0 \\ 1 & 0 & 0 \\ 0 & 0 & -1 \end{pmatrix} \quad (3.19)$$

where $\omega = e^{\pi i/m}$. From group theoretic data, when $2 \mid m$, $\chi = 2m + 6$, $|\Gamma_1| = \frac{3}{2}m + 5$, $|\Gamma_2| = \frac{1}{2}m$ while when $2 \nmid m$, $\chi = 2m + 3$, $|\Gamma_1| = \frac{3}{2}m + \frac{5}{2}$, $|\Gamma_2| = \frac{1}{2}m - \frac{1}{2}$. In this case \mathbb{C}^3/Γ is a hypersurface given by the equation

$$4wx^{m+1} - wxy^2 + z^2 = 0. \quad (3.20)$$

2. $G_{p,q}$

This is the case (18) of [74]. The generators are

$$M_1 = \begin{pmatrix} \omega & 0 & 0 \\ 0 & \omega^{-1} & 0 \\ 0 & 0 & 1 \end{pmatrix}, M_2 = \begin{pmatrix} \omega^p & 0 & 0 \\ 0 & 1 & 0 \\ 0 & 0 & \omega^{-p} \end{pmatrix}, M_3 = \begin{pmatrix} 0 & 1 & 0 \\ 1 & 0 & 0 \\ 0 & 0 & -1 \end{pmatrix} \quad (3.21)$$

where $\omega = e^{\pi i/pq}$, $p \geq 1$ and $q \geq 2$. In this case \mathbb{C}^3/Γ is a complete intersection given by the equations

$$\begin{cases} 4ux^p - uy^2 + z^2 = 0, \\ u^q - vx = 0. \end{cases} \quad (3.22)$$

3. G'_m

This corresponds to the case (19) and (20) of [74], the order of group is $|G'_m| = 8m$. When m is even, the group generators are

$$M_1 = \begin{pmatrix} 0 & -i & 0 \\ -i & 0 & 0 \\ 0 & 0 & 1 \end{pmatrix}, M_2 = \begin{pmatrix} iw & 0 & 0 \\ 0 & iw^{-1} & 0 \\ 0 & 0 & -1 \end{pmatrix} \quad (3.23)$$

where $w = e^{2\pi i/4m}$. For this group we have $\chi = 2m+3$, $|\Gamma_1| = \frac{3}{2}m+2$ and $|\Gamma_2| = \frac{1}{2}m$. In this case \mathbb{C}^3/Γ is a complete intersection given by the equations

$$\begin{cases} u^2 - y(x - 4y^m) = 0 \\ v^2 - xz = 0 \end{cases} \quad (3.24)$$

While m is odd, the group generators are

$$M_1 = \begin{pmatrix} 0 & -1 & 0 \\ -1 & 0 & 0 \\ 0 & 0 & -1 \end{pmatrix}, M_2 = \begin{pmatrix} iw & 0 & 0 \\ 0 & iw^{-1} & 0 \\ 0 & 0 & -1 \end{pmatrix}, \quad (3.25)$$

where $w = e^{2\pi i/2m}$. For this group we have $r = \frac{1}{2}(m+1)$, $f = m+4$. \mathbb{C}^3/Γ is a complete intersection

$$\begin{cases} u^2 - y(x + 4y^m) = 0 \\ v^2 - xz = 0 \end{cases} \quad (3.26)$$

3.2.2 Sporadic cases $E^{(k)}$

In this section, we present other sporadic cases of $\Gamma \subset U(2)$ with a hypersurface or complete intersection description, which are labeled by $E^{(k)}$. For the details of invariant polynomials, see [74].

- $E^{(1)} \supset \mathbb{E}_6$

This is the case (3) of [74], the order of group is 72, and the generators are

$$M_1 = \begin{pmatrix} i & 0 & 0 \\ 0 & -i & 0 \\ 0 & 0 & 1 \end{pmatrix}, M_2 = \begin{pmatrix} 0 & i & 0 \\ i & 0 & 0 \\ 0 & 0 & 1 \end{pmatrix}, M_3 = \begin{pmatrix} \frac{1}{2} + \frac{i}{2} & -\frac{1}{2} + \frac{i}{2} & 0 \\ \frac{1}{2} + \frac{i}{2} & \frac{1}{2} - \frac{i}{2} & 0 \\ 0 & 0 & 1 \end{pmatrix}, M_4 = \begin{pmatrix} w & 0 & 0 \\ 0 & w & 0 \\ 0 & 0 & w^{-2} \end{pmatrix}$$

where $w = e^{2\pi i/6}$. For this group we have $\chi = 21$, $|\Gamma_1| = 15$, $r = |\Gamma_2| = 5$, $f = 10$. \mathbb{C}^3/Γ is a hypersurface

$$z^3 - w(y^2 + 108x^4) = 0. \quad (3.27)$$

- $E^{(2)} \supset \mathbb{D}_4$

This is the case (4) of [74], the order of group is 24, and the generators are

$$M_1 = \begin{pmatrix} 0 & -i & 0 \\ -i & 0 & 0 \\ 0 & 0 & 1 \end{pmatrix}, M_2 = \begin{pmatrix} -i & 0 & 0 \\ 0 & i & 0 \\ 0 & 0 & 1 \end{pmatrix}, M_3 = \frac{1}{\sqrt{2}} \begin{pmatrix} \epsilon^7 & \epsilon^{13} & 0 \\ \epsilon^7 & \epsilon & 0 \\ 0 & 0 & \sqrt{2}\epsilon^{16} \end{pmatrix}$$

where $w = e^{2\pi i/24}$. For this group we have $\chi = 7$, $|\Gamma_1| = 5$, $r = |\Gamma_2| = 1$, $f = 4$.

\mathbb{C}^3/Γ is a hypersurface

$$z^3 - w(y^3 + 12\sqrt{3}ix^2) = 0. \quad (3.28)$$

- $E^{(3)} \supset \mathbb{E}_7$

This is the case (5) of [74], the order of group is 96, and the generators are

$$M_1 = \begin{pmatrix} i & 0 & 0 \\ 0 & -i & 0 \\ 0 & 0 & 1 \end{pmatrix}, M_2 = \begin{pmatrix} 0 & i & 0 \\ i & 0 & 0 \\ 0 & 0 & 1 \end{pmatrix}, M_3 = \begin{pmatrix} \frac{1}{2} + \frac{i}{2} & -\frac{1}{2} + \frac{i}{2} \\ \frac{1}{2} + \frac{i}{2} & \frac{1}{2} - \frac{i}{2} \\ 0 & 0 & 1 \end{pmatrix},$$

$$M_4 = \begin{pmatrix} \epsilon^3 & 0 & 0 \\ 0 & \epsilon^5 & 0 \\ 0 & 0 & 1 \end{pmatrix}, M_5 = \begin{pmatrix} w & 0 & 0 \\ 0 & w & 0 \\ 0 & 0 & w^{-2} \end{pmatrix}$$

where $\epsilon = e^{2\pi i/8}$ and $w = e^{2\pi i/4}$. For this group we have $\chi = 16$, $|\Gamma_1| = 12$, $r = |\Gamma_2| = 3$ and $f = 9$.

\mathbb{C}^3/Γ is a hypersurface

$$z^2 + w(108x^3 - xy^3) = 0. \quad (3.29)$$

- $E^{(4)} \supset \mathbb{E}_6$

This is the case (6) of [74], the order of group is 48, and the generators are

$$M_1 = \begin{pmatrix} 0 & -i & 0 \\ -i & 0 & 0 \\ 0 & 0 & 1 \end{pmatrix}, M_2 = \begin{pmatrix} -i & 0 & 0 \\ 0 & i & 0 \\ 0 & 0 & 1 \end{pmatrix}, M_3 = \frac{1}{2} \begin{pmatrix} -1 - i & 1 - i & 0 \\ -1 - i & -1 + i & 0 \\ 0 & 0 & 2 \end{pmatrix},$$

$$M_4 = \frac{1}{\sqrt{2}} \begin{pmatrix} \epsilon^5 & 0 & 0 \\ 0 & \epsilon^7 & 0 \\ 0 & 0 & -1 \end{pmatrix}$$

where $w = e^{2\pi i/8}$. For this group we have $\chi = 8$, $|\Gamma_1| = 6$, $r = |\Gamma_2| = 1$ and $f = 5$. \mathbb{C}^3/Γ is a hypersurface

$$z^2 + w(108x^4 - y^3) = 0. \quad (3.30)$$

- $E^{(5)} \supset \mathbb{E}_6$

This is the case (7) of [74], the order of group is 96, and the generators are

$$M_1 = \begin{pmatrix} 0 & -i & 0 \\ -i & 0 & 0 \\ 0 & 0 & 1 \end{pmatrix}, M_2 = \begin{pmatrix} -1 & 0 & 0 \\ 0 & 1 & 0 \\ 0 & 0 & -1 \end{pmatrix}, M_3 = \frac{1}{2} \begin{pmatrix} -1+i & -1-i & 0 \\ -1+i & 1+i & 0 \\ 0 & 0 & 2 \end{pmatrix},$$

$$M_4 = \frac{1}{\sqrt{2}} \begin{pmatrix} -1 & 0 & 0 \\ 0 & -i & 0 \\ 0 & 0 & -i \end{pmatrix}$$

For this group we have $\chi = 16$, $|\Gamma_1| = 11$, $r = |\Gamma_2| = 4$ and $f = 7$.

\mathbb{C}^3/Γ is a hypersurface

$$108z^4 + w(y^2 - x^3) = 0. \quad (3.31)$$

- $E^{(6)} \supset \mathbb{E}_6$

This is the case (21) of [74], the order of group is 48, and the generators are

$$M_1 = \begin{pmatrix} i & 0 & 0 \\ 0 & -i & 0 \\ 0 & 0 & 1 \end{pmatrix}, M_2 = \begin{pmatrix} 0 & i & 0 \\ i & 0 & 0 \\ 0 & 0 & 1 \end{pmatrix}, M_3 = \begin{pmatrix} \frac{1}{2} + \frac{i}{2} & -\frac{1}{2} + \frac{i}{2} & 0 \\ \frac{1}{2} + \frac{i}{2} & \frac{1}{2} - \frac{i}{2} & 0 \\ 0 & 0 & 1 \end{pmatrix}, M_4 = \begin{pmatrix} i & 0 & 0 \\ 0 & i & 0 \\ 0 & 0 & -1 \end{pmatrix}.$$

For this group we have $\chi = 14$, $|\Gamma_1| = 10$, $r = |\Gamma_2| = 3$ and $f = 7$.

\mathbb{C}^3/Γ is a complete intersection

$$\begin{cases} y^3 - z^2 = 108x^2 \\ u^2 - vx = 0. \end{cases} \quad (3.32)$$

- $E^{(7)} \supset \mathbb{E}_7$

This is the case (22) of [74], the order of group is 144, and the generators are

$$M_1 = \begin{pmatrix} i & 0 & 0 \\ 0 & -i & 0 \\ 0 & 0 & 1 \end{pmatrix}, M_2 = \begin{pmatrix} 0 & i & 0 \\ i & 0 & 0 \\ 0 & 0 & 1 \end{pmatrix}, M_3 = \begin{pmatrix} \frac{1}{2} + \frac{i}{2} & -\frac{1}{2} + \frac{i}{2} & 0 \\ \frac{1}{2} + \frac{i}{2} & \frac{1}{2} - \frac{i}{2} & 0 \\ 0 & 0 & 1 \end{pmatrix},$$

$$M_4 = \begin{pmatrix} \epsilon^3 & 0 & 0 \\ 0 & \epsilon^5 & 0 \\ 0 & 0 & 1 \end{pmatrix}, M_5 = \begin{pmatrix} w & 0 & 0 \\ 0 & w & 0 \\ 0 & 0 & w^{-2} \end{pmatrix}$$

where $\epsilon = e^{2\pi i/8}$ and $w = e^{2\pi i/6}$. For this group we have $\chi = 24$, $|\Gamma_1| = 16$, $r = |\Gamma_2| = 7$ and $f = 9$.

\mathbb{C}^3/Γ is a complete intersection

$$\begin{cases} yv - u^3 = 0 \\ z^2 + 108x^3 = xy. \end{cases} \quad (3.33)$$

- $E^{(8)} \supset \mathbb{E}_7$

This is the case (23) of [74], the order of group is 192, and the generators are

$$\begin{aligned} M_1 &= \begin{pmatrix} i & 0 & 0 \\ 0 & -i & 0 \\ 0 & 0 & 1 \end{pmatrix}, \quad M_2 = \begin{pmatrix} 0 & i & 0 \\ i & 0 & 0 \\ 0 & 0 & 1 \end{pmatrix}, \quad M_3 = \begin{pmatrix} \frac{1}{2} + \frac{i}{2} & -\frac{1}{2} + \frac{i}{2} & 0 \\ \frac{1}{2} + \frac{i}{2} & \frac{1}{2} - \frac{i}{2} & 0 \\ 0 & 0 & 1 \end{pmatrix}, \\ M_4 &= \begin{pmatrix} \epsilon^3 & 0 & 0 \\ 0 & \epsilon^5 & 0 \\ 0 & 0 & 1 \end{pmatrix}, \quad M_5 = \begin{pmatrix} w & 0 & 0 \\ 0 & w & 0 \\ 0 & 0 & w^{-2} \end{pmatrix} \end{aligned}$$

where $\epsilon = e^{2\pi i/8}$ and $w = e^{2\pi i/8}$. For this group we have $\chi = 32$, $|\Gamma_1| = 21$, $r = |\Gamma_2| = 10$ and $f = 11$.

\mathbb{C}^3/Γ is a complete intersection

$$\begin{cases} z^2 + 108ux - uy^3 = 0 \\ u^2 - vx = 0 \end{cases} \quad (3.34)$$

- $E^{(9)} \supset \mathbb{E}_8$

This case and the next two cases correspond to the case (8) of [74]. The order of group is 240, and the generators are

$$M_1 = \frac{1}{\sqrt{5}} \begin{pmatrix} \eta^4 - \eta & \eta^2 - \eta^3 & 0 \\ \eta^2 - \eta^3 & \eta - \eta^4 & 0 \\ 0 & 0 & \sqrt{5} \end{pmatrix}, \quad M_2 = \frac{1}{\sqrt{5}} \begin{pmatrix} \eta^2 - \eta^4 & \eta^4 - \eta & 0 \\ 1 - \eta & \eta^3 - \eta & 0 \\ 0 & 0 & \sqrt{5} \end{pmatrix}, \quad M_3 = \begin{pmatrix} w & 0 & 0 \\ 0 & w & 0 \\ 0 & 0 & w^{-2} \end{pmatrix}$$

where $\eta = e^{2\pi i/5}$ and $w = e^{2\pi i/4}$. For this group we have $\chi = 18$, $|\Gamma_1| = 13$, $r = |\Gamma_2| = 4$ and $f = 9$.

\mathbb{C}^3/Γ is a hypersurface

$$z^2 + w(-1728x^5 + y^3) = 0. \quad (3.35)$$

- $E^{(10)} \supset \mathbb{E}_8$

The order of group is 360, and the generators are

$$M_1 = \frac{1}{\sqrt{5}} \begin{pmatrix} \eta^4 - \eta & \eta^2 - \eta^3 & 0 \\ \eta^2 - \eta^3 & \eta - \eta^4 & 0 \\ 0 & 0 & \sqrt{5} \end{pmatrix}, \quad M_2 = \frac{1}{\sqrt{5}} \begin{pmatrix} \eta^2 - \eta^4 & \eta^4 - \eta & 0 \\ 1 - \eta & \eta^3 - \eta & 0 \\ 0 & 0 & \sqrt{5} \end{pmatrix}, \quad M_3 = \begin{pmatrix} w & 0 & 0 \\ 0 & w & 0 \\ 0 & 0 & w^{-2} \end{pmatrix}$$

where $\eta = e^{2\pi i/5}$ and $w = e^{2\pi i/6}$. For this group we have $\chi = 27$, $|\Gamma_1| = 18$, $r = |\Gamma_2| = 8$ and $f = 10$.

\mathbb{C}^3/Γ is a hypersurface

$$z^3 + w(-1728x^5 + y^2) = 0. \quad (3.36)$$

- $E^{(11)} \supset \mathbb{E}_8$

The order of group is 600, and the generators are

$$M_1 = \frac{1}{\sqrt{5}} \begin{pmatrix} \eta^4 - \eta & \eta^2 - \eta^3 & 0 \\ \eta^2 - \eta^3 & \eta - \eta^4 & 0 \\ 0 & 0 & \sqrt{5} \end{pmatrix}, \quad M_2 = \frac{1}{\sqrt{5}} \begin{pmatrix} \eta^2 - \eta^4 & \eta^4 - \eta & 0 \\ 1 - \eta & \eta^3 - \eta & 0 \\ 0 & 0 & \sqrt{5} \end{pmatrix}, \quad M_3 = \begin{pmatrix} w & 0 & 0 \\ 0 & w & 0 \\ 0 & 0 & w^{-2} \end{pmatrix}$$

where $\eta = e^{2\pi i/5}$ and $w = e^{2\pi i/10}$. For this group we have $\chi = 45$, $|\Gamma_1| = 28$, $r = |\Gamma_2| = 16$ and $f = 12$.

\mathbb{C}^3/Γ is a hypersurface

$$1728z^5 - w(x^3 + y^2) = 0. \quad (3.37)$$

3.3 Infinite series of non-abelian finite subgroups of $SU(3)$

3.3.1 $\Delta(3n^2)$ series

The generators of $\Delta(3n^2)$ groups are:

$$E = \begin{pmatrix} 0 & 1 & 0 \\ 0 & 0 & 1 \\ 1 & 0 & 0 \end{pmatrix}, \quad L_n = \begin{pmatrix} \omega & 0 & 0 \\ 0 & \omega^{-1} & 0 \\ 0 & 0 & 1 \end{pmatrix} \quad (3.38)$$

where $\omega = e^{2\pi i/n}$.

The number of conjugacy classes can be computed as

$$\begin{aligned} |\Gamma_0| &= 1, \quad |\Gamma_1| = \frac{1}{6}(n^2 + 3n + 8), \quad |\Gamma_2| = \frac{1}{6}(n-1)(n-2), \quad 3 \nmid n, \\ |\Gamma_0| &= 1, \quad |\Gamma_1| = \frac{1}{6}(n^2 + 3n + 36), \quad |\Gamma_2| = \frac{1}{6}(n^2 - 3n + 6), \quad 3 \mid n. \end{aligned} \quad (3.39)$$

The gauge and flavor rank are

$$\begin{aligned} r &= \frac{1}{6}(n-1)(n-2), \quad f = n+1, \quad 3 \nmid n, \\ r &= \frac{1}{6}(n^2 - 3n + 6), \quad f = n+5, \quad 3 \mid n. \end{aligned} \quad (3.40)$$

For $\mathbb{C}^3/\Delta(3n^2)$ theories, they can be written as a hypersurface singularity in \mathbb{C}^4 :

$$-16w^3z^n + 24wxz^n + 24yz^n + 72z^{2n} + 3w^2x^2 - 3w^4x - 4w^3y + w^6 + 4wxy - x^3 + 8y^2 = 0. \quad (3.41)$$

3.3.2 $\Delta(6n^2)$ series

The generators of $\Delta(6n^2)$ groups are:

$$E = \begin{pmatrix} 0 & 1 & 0 \\ 0 & 0 & 1 \\ 1 & 0 & 0 \end{pmatrix}, \quad I = \begin{pmatrix} 0 & 0 & -1 \\ 0 & -1 & 0 \\ -1 & 0 & 0 \end{pmatrix}, \quad L_n = \begin{pmatrix} \omega & 0 & 0 \\ 0 & \omega^{-1} & 0 \\ 0 & 0 & 1 \end{pmatrix} \quad (3.42)$$

where $\omega = e^{2\pi i/n}$.

The gauge and flavor rank are

$$r = \begin{cases} \frac{1}{12}(n^2 + 6n) - 1, & n = 6k, \\ \frac{1}{12}(n + 7)(n - 1), & n = 6k + 1 \text{ or } 6k + 5, \\ \frac{1}{12}(n + 8)(n - 2), & n = 6k + 2 \text{ or } 6k + 4, \\ \frac{1}{12}(n^2 + 6n - 3), & n = 6k + 3 \end{cases} \quad (3.43)$$

$$f = \begin{cases} \frac{1}{2}n + 5, & n = 6k, \\ \frac{1}{2}n + \frac{3}{2}, & n = 6k + 1 \text{ or } 6k + 5, \\ \frac{1}{2}n + 3, & n = 6k + 2 \text{ or } 6k + 4, \\ \frac{1}{2}n + \frac{7}{2}, & n = 6k + 3 \end{cases}$$

For $n = 2k + 1$ these theories can be described as a complete intersection in \mathbb{C}^5 :

$$\begin{cases} 27u^n + 4u^{\frac{n-1}{2}}vx - 10u^{\frac{n-1}{2}}vy - xy^2 + 2y^3 + z^2 = 0, \\ v^2 - ux - 2uy = 0. \end{cases} \quad (3.44)$$

When n is even, for $n = 2k$ ($k \neq 1$) these theories can be described as a hypersurface in \mathbb{C}^4 :

$$-20w^{\frac{n}{2}+1}x^3 + 36w^{\frac{n}{2}+1}xy + 108w^{n+1} + 5wx^2y^2 - 4wx^4y + wx^6 - 2wy^3 + 4z^2 = 0. \quad (3.45)$$

3.3.3 $C_{n,l}^{(k)}$ series

1. $(r, k, l) = (3, 1, l)$, $3|l$

A series of simple examples is given by $(r, k, l) = (3, 1, l)$ where $n = rl = 3l$ and $3|l$, whose generators are:

$$E = \begin{pmatrix} 0 & 1 & 0 \\ 0 & 0 & 1 \\ 1 & 0 & 0 \end{pmatrix}, \quad B_{9,1} = \begin{pmatrix} w & 0 & 0 \\ 0 & w & 0 \\ 0 & 0 & w^{-2} \end{pmatrix}, \quad G_{7,7} = \begin{pmatrix} 1 & 0 & 0 \\ 0 & w^{-3} & 0 \\ 0 & 0 & w^3 \end{pmatrix}. \quad (3.46)$$

where $w = e^{2\pi i/n}$. For this series we have

$$\begin{aligned} |\Gamma_1| &= \frac{1}{2}l^2 + \frac{1}{2}l + 6, \\ r = |\Gamma_2| &= \frac{1}{2}l^2 - \frac{1}{2}l + 1. \end{aligned} \quad (3.47)$$

\mathbb{C}^3/Γ is a hypersurface given by the equation:

$$w^lx^2 + 3w^{2l}x - 6w^lyz + 9w^{3l} - xyz + y^3 + z^3 = 0. \quad (3.48)$$

2. $(r, k, l) = (7, 2, l)$

Another example is given by $(r, k, l) = (7, 2, l)$ where $n = rl = 7l$, whose generators are:

$$E = \begin{pmatrix} 0 & 1 & 0 \\ 0 & 0 & 1 \\ 1 & 0 & 0 \end{pmatrix}, B_{7,2} = \begin{pmatrix} w & 0 & 0 \\ 0 & w^2 & 0 \\ 0 & 0 & w^{-3} \end{pmatrix}, G_{7l,7} = \begin{pmatrix} 1 & 0 & 0 \\ 0 & w^7 & 0 \\ 0 & 0 & w^{-7} \end{pmatrix} \quad (3.49)$$

where $w = e^{2\pi i/n}$. When $3 \mid l$, $f = l + 5$ while when $3 \nmid l$, $f = l + 1$. For this series we have

$$|\Gamma_1| = \begin{cases} \frac{21}{2}k^2 + \frac{3}{2}k + 6, & l = 3k \\ \frac{21}{2}k^2 + \frac{17}{2}k + 3, & l = 3k + 1 \\ \frac{21}{2}k^2 + \frac{31}{2}k + 7, & l = 3k + 2 \end{cases} \quad (3.50)$$

$$r = |\Gamma_2| = \begin{cases} \frac{21}{2}k^2 - \frac{3}{2}k + 1, & l = 3k \\ \frac{21}{2}k^2 + \frac{11}{2}k + 1, & l = 3k + 1 \\ \frac{21}{2}k^2 + \frac{25}{2}k + 4, & l = 3k + 2 \end{cases}$$

In this case \mathbb{C}^3/Γ is a complete intersection given by the equations:

$$\begin{cases} u^{2l}v - u^l z + vy - x^2 = 0, \\ 9u^{4l} + 3u^{2l}y - 5u^l vx + v^3 - xz + y^2 = 0. \end{cases} \quad (3.51)$$

3.3.4 $D_{3l,l}^{(1)}$ series, $2 \mid l$

The generators are $E, I, B_{3l,1}$ where

$$B_{3l,1} = \begin{pmatrix} \omega & 0 & 0 \\ 0 & \omega & 0 \\ 0 & 0 & \omega^{-2} \end{pmatrix} \quad (3.52)$$

and $\omega = e^{2\pi i/3l}$. We consider the case of $2 \mid l$, where $r = \frac{1}{4}l^2 + 2l - 1$, $f = \frac{1}{2}l + 5$.

In this case \mathbb{C}^3/Γ is a complete intersection given by the equations:

$$\begin{cases} 4v^2u^{l/2} + 12vu^l - 6x^2u^{l/2} + 6zu^{l/2} + 36u^{3l/2} - vx^2 + vz + x^3 + 3xz = 0, \\ y^2 - uz = 0. \end{cases} \quad (3.53)$$

3.4 Exceptional finite subgroups of $SU(3)$

Here we discuss the classes (E)(F)(G)(H)(I)(L), the ‘‘exceptional’’ finite subgroups of $SU(3)$ that are analogs of E-type finite subgroups of $SU(2)$.

1. H_{36}

This group is generated by

$$M_1 = \begin{pmatrix} 1 & 0 & 0 \\ 0 & \omega & 0 \\ 0 & 0 & \omega^2 \end{pmatrix}, M_2 = \begin{pmatrix} 0 & 1 & 0 \\ 0 & 0 & 1 \\ 1 & 0 & 0 \end{pmatrix}, M_3 = h \begin{pmatrix} 1 & 1 & 1 \\ 1 & \omega & \omega^2 \\ 1 & \omega^2 & \omega \end{pmatrix} \quad (3.54)$$

where $h = (\omega - \omega^2)^{-1}$ and $\omega = e^{2\pi i/3}$. The order of H_{36} is 108.

$$\chi = 14, |\Gamma_1| = 9, r = |\Gamma_2| = 4, f = 5. \quad (3.55)$$

The singular variety \mathbb{C}^3/H_{36} can be written as a complete intersection given by the equations:

$$\begin{cases} 3u^2v + 2u^3 - 36uy - 36vx - v^3 + 432z^2 = 0, \\ u^2x - u^2y - 12x^2 + 9y^2 = 0. \end{cases} \quad (3.56)$$

2. H_{60}

This group is generated by

$$M_1 = \begin{pmatrix} 1 & 0 & 0 \\ 0 & -1 & 0 \\ 0 & 0 & -1 \end{pmatrix}, M_2 = \begin{pmatrix} 0 & 1 & 0 \\ 0 & 0 & 1 \\ 1 & 0 & 0 \end{pmatrix}, M_3 = \frac{1}{2} \begin{pmatrix} -1 & u_2 & u_1 \\ u_2 & u_1 & -1 \\ u_1 & -1 & u_2 \end{pmatrix} \quad (3.57)$$

where $u_1 = \frac{1}{2}(-1 + \sqrt{5})$ and $u_2 = \frac{1}{2}(-1 - \sqrt{5})$. The order of H_{60} is 60, and

$$\chi = 5, |\Gamma_1| = 4, r = |\Gamma_2| = 0, f = 4. \quad (3.58)$$

Therefore there are 4 non-compact exceptional divisors in $\widetilde{\mathbb{C}^3/H_{60}}$ and no compact exceptional divisors.

The singular variety \mathbb{C}^3/H_{60} can be expressed as a hypersurface in \mathbb{C}^4 :

$$\begin{aligned} 0 = & 10125w^2 - 13071240x^4y^2z + 446240256x^9y^2 - 408197440x^6y^3 + 174372625x^3y^4 \\ & + 25927020x^2yz^2 + 40449024x^7yz - 245088256x^{12}y - 17622576x^5z^2 - 13658112x^{10}z \\ & + 54329344x^{15} - 21994875xy^3z - 18907875y^5 - 2777895z^3. \end{aligned} \quad (3.59)$$

3. H_{72}

This group is generated by

$$M_1 = \begin{pmatrix} 1 & 0 & 0 \\ 0 & \omega & 0 \\ 0 & 0 & \omega^2 \end{pmatrix}, M_2 = \begin{pmatrix} 0 & 1 & 0 \\ 0 & 0 & 1 \\ 1 & 0 & 0 \end{pmatrix}, M_3 = h \begin{pmatrix} 1 & 1 & 1 \\ 1 & \omega & \omega^2 \\ 1 & \omega^2 & \omega \end{pmatrix}, M_4 = h \begin{pmatrix} 1 & 1 & \omega^2 \\ 1 & \omega & \omega \\ \omega & 1 & \omega \end{pmatrix} \quad (3.60)$$

where $h = (\omega - \omega^2)^{-1}$, $\omega = e^{2\pi i/3}$. The order of H_{72} is 216, and

$$\chi = 16, |\Gamma_1| = 10, r = |\Gamma_2| = 5, f = 5. \quad (3.61)$$

The singular variety \mathbb{C}^3/H_{72} can be described as a hypersurface in \mathbb{C}^4 :

$$(-w^3 + 3wy + 432x^2)^2 - 4(3y^2z - 3yz^2 + z^3) = 0. \quad (3.62)$$

4. H_{168}

This group is generated by

$$M_1 = \begin{pmatrix} \omega & 0 & 0 \\ 0 & \omega^2 & 0 \\ 0 & 0 & \omega^4 \end{pmatrix}, M_2 = \begin{pmatrix} 0 & 1 & 0 \\ 0 & 0 & 1 \\ 1 & 0 & 0 \end{pmatrix}, M_3 = h \begin{pmatrix} \omega^4 - \omega^3 & \omega^2 - \omega^5 & \omega - \omega^6 \\ \omega^2 - \omega^5 & \omega - \omega^6 & \omega^4 - \omega^3 \\ \omega - \omega^6 & \omega^4 - \omega^3 & \omega^2 - \omega^5 \end{pmatrix} \quad (3.63)$$

where $\omega = e^{2\pi i/7}$ and $h = \frac{1}{7}(\omega + \omega^2 + \omega^4 - \omega^3 - \omega^5 - \omega^6)$. The order of H_{168} is 168, and

$$\chi = 6, |\Gamma_1| = 4, r = |\Gamma_2| = 1, f = 3. \quad (3.64)$$

The singular variety \mathbb{C}^3/H_{168} can be described as a hypersurface in \mathbb{C}^4 :

$$z^3 + 1728y^7 + 1008zy^4x - 88z^2yx^2 - 60032y^5x^3 + 1088zy^2x^4 + 22016y^3x^6 - 256zx^7 - 2048yx^9 - w^2 = 0. \quad (3.65)$$

5. H_{216}

This group is generated by

$$M_1 = \begin{pmatrix} 1 & 0 & 0 \\ 0 & \omega & 0 \\ 0 & 0 & \omega^2 \end{pmatrix}, M_2 = \begin{pmatrix} 0 & 1 & 0 \\ 0 & 0 & 1 \\ 1 & 0 & 0 \end{pmatrix}, M_3 = h \begin{pmatrix} 1 & 1 & 1 \\ 1 & \omega & \omega^2 \\ 1 & \omega^2 & \omega \end{pmatrix}, M_4 = \epsilon \begin{pmatrix} 1 & 0 & 0 \\ 0 & 1 & 0 \\ 0 & 0 & \omega \end{pmatrix} \quad (3.66)$$

where $h = (\omega - \omega^2)^{-1}$, $\omega = e^{2\pi i/3}$ and $\epsilon = e^{4\pi i/9}$. The order of H_{216} is 648, and

$$\chi = 24, |\Gamma_1| = 14, r = |\Gamma_2| = 9, f = 5. \quad (3.67)$$

The singular variety \mathbb{C}^3/H_{216} can be described as a hypersurface in \mathbb{C}^4 :

$$y^3 - \frac{1}{4}z \left((432w^2 - z - 3y)^2 - 6912x^3 \right) = 0. \quad (3.68)$$

6. H_{360}

The group H_{360} is generated by

$$M_1 = \begin{pmatrix} -1 & 0 & 0 \\ 0 & 0 & -1 \\ 0 & -1 & 0 \end{pmatrix}, M_2 = \begin{pmatrix} 1 & 0 & 0 \\ 0 & \omega^4 & 0 \\ 0 & 0 & \omega \end{pmatrix}, M_3 = \frac{1}{\sqrt{5}} \begin{pmatrix} 1 & \sqrt{2} & \sqrt{2} \\ \sqrt{2} & s & t \\ \sqrt{2} & t & s \end{pmatrix}, \quad (3.69)$$

$$M_4 = \frac{1}{\sqrt{5}} \begin{pmatrix} 1 & \sqrt{2}\lambda_1 & \sqrt{2}\lambda_1 \\ \sqrt{2}\lambda_2 & s & t \\ \sqrt{2}\lambda_2 & t & s \end{pmatrix}$$

where $\omega = e^{2\pi i/5}$, $s = \frac{1}{2}(-1 - \sqrt{5})$, $t = \frac{1}{2}(-1 + \sqrt{5})$, $\lambda_1 = \frac{1}{4}(-1 + \sqrt{15}i)$ and $\lambda_2 = \frac{1}{4}(-1 - \sqrt{15}i)$. The order of H_{360} is 1080, and

$$\chi = 17, |\Gamma_1| = 11, |\Gamma_2| = 5, f = 6. \quad (3.70)$$

4 Examples

In this section, we provide a number of notable examples of \mathbb{C}^3/Γ , their resolutions and the 5d SCFT interpretation. If the singularity can be embedded in a singular elliptic Calabi-Yau threefold, one can also study the 6d (1,0) SCFT from F-theory. The 6d and 5d theories are naturally related, see section 2.5. We put additional examples in appendix B.

4.1 $\Delta(3n^2)$, $n = 3k$

In this section we study the cases of $X = \mathbb{C}^3/\Delta(3n^2)$, $n = 3k$. One can dimensionally reduce T_X^{6d} on S^1 , and then decouple a 5d hypermultiplet to get T_X^{5d} .

4.1.1 6d interpretation

Starting with the singular equation

$$-16w^3z^n + 24wxz^n + 24yz^n + 72z^{2n} + 3w^2x^2 - 3w^4x - 4w^3y + w^6 + 4wxy - x^3 + 8y^2 = 0, \quad (4.1)$$

we can rescale and shift coordinates and rewrite it as

$$\begin{cases} y^2 = x^3 + \frac{1}{12}w(8U - 9w^3)x + \frac{1}{108}(8U^2 - 36Uw^3 + 27w^6) \\ U = w^3 - 27z^n \end{cases} \quad (4.2)$$

The discriminant is

$$\begin{aligned} \Delta &= 4z^n(27z^n - w^3)^3 \\ &= \frac{4}{27}U^3(U - w^3). \end{aligned} \quad (4.3)$$

If $n = 3k$, the non-compact curves supporting Kodaira singular fiber are

$$\begin{aligned} z = 0 &: I_{n,s}, \quad G_{F,6d} = SU(n) \\ w - 3e^{2\pi im/3}z = 0 &: I_{3,s}, \quad G_{F,6d} = SU(3) \quad (m = 0, 1, 2). \end{aligned} \quad (4.4)$$

The total flavor symmetry is

$$G_{F,6d} \supset SU(n) \times SU(3)^3. \quad (4.5)$$

Now we discuss the tensor branch geometry of a few $\Delta(3n^2)$ theories with small $n = 3k$. For $n = 3$, the base blow up is $(w, z; \delta)$, and the resulting (f, g, Δ) are

$$\begin{aligned} f &= -\frac{1}{12}w(w^3 + 216z^3) \\ g &= -\frac{w^6}{108} + 5w^3z^3 + 54z^6 \\ \Delta &= -4z^3(w^3 - 27z^3)^3, \end{aligned} \quad (4.6)$$

The tensor branch is

$$\begin{array}{ccc} & [SU(3)] & \\ & | & \\ [SU(3)] - & 1 & -[SU(3)], \\ & | & \\ & [SU(3)] & \end{array} \quad (4.7)$$

with only a single (-1) -curve. Hence the corresponding 6d $(1,0)$ SCFT is the same as rank-1 E-string theory.

For higher $n = 3k$ ($k > 1$), the base blow ups are

$$\begin{aligned} (w, z; \delta_1) \\ (w, \delta_i; \delta_{i+1}) \quad (i = 1, \dots, k-1). \end{aligned} \tag{4.8}$$

The resulting (f, g, Δ) are

$$\begin{aligned} f &= -\frac{1}{12}w \left(w^3 + 216z^{3k} \prod_{i=1}^{k-1} \delta_i^{3k-3i} \right) \\ g &= -\frac{w^6}{108} + 5w^3 z^{3k} \prod_{i=1}^{k-1} \delta_i^{3k-3i} + 54z^{6k} \prod_{i=1}^{k-1} \delta_i^{6k-6i} \\ \Delta &= -4z^{3k} \left(w^3 - 27z^{3k} \prod_{i=1}^{k-1} \delta_i^{3k-3i} \right)^3 \prod_{i=1}^{k-1} \delta_i^{3k-3i}. \end{aligned} \tag{4.9}$$

From the Weierstrass model, we read of the following tensor branch

$$\begin{array}{c} [SU(3)] \\ | \\ [SU(3k)] - \frac{\text{su}(3k-3)}{2} - \frac{\text{su}(3k-6)}{2} - \dots - \frac{\text{su}(3)}{2} - 1 - [SU(3)] \\ | \\ [SU(3)] \end{array} \tag{4.10}$$

The compact curves from left to right are $\delta_1 = 0, \delta_2 = 0, \dots, \delta_k = 0$. The flavor symmetry $SU(3)^3$ attached to the (-1) -curve on the right is enhanced to E_6 , after the three $I_{3,s}$ loci collide into an IV_{ns}^* , and the tensor branch becomes

$$[SU(3k)] - \frac{\text{su}(3k-3)}{2} - \frac{\text{su}(3k-6)}{2} - \dots - \frac{\text{su}(3)}{2} - 1 - [E_6]. \tag{4.11}$$

These 6d SCFTs are very-Higgsable tensor-gauge quiver theories that naturally appear in the literature, such as [79].

4.1.2 5d interpretation

The 5d interpretation of these theories has also been studied in [100] using a different approach. In this section we study the resolved geometry explicitly.

1. $n = 3$

The non-isolated singular equation is

$$w^6 - 3w^4x + 3w^2x^2 - x^3 - 4w^3y + 4wxy + 8y^2 - 16w^3z^3 + 24wxz^3 + 24yz^3 + 72z^6 = 0. \tag{4.12}$$

The equation is homogeneous with weights

$$d(x) = \frac{1}{3}, \quad d(y) = \frac{1}{2}, \quad d(z) = \frac{1}{6}, \quad d(w) = \frac{1}{6}, \quad (4.13)$$

hence the singular point $x = y = z = w = 0$ can be removed after the weighted blow up of ambient space

$$(x^{(2)}, y^{(3)}, z^{(1)}, w^{(1)}; \delta_1). \quad (4.14)$$

After this blow up, the equation of compact exceptional divisor $\delta_1 = 0$ has the same form as (4.12). There are still four cod-2 A_2 singularities at the following curves

$$x - w^2 = y = z = 0, \quad x - \frac{w^2}{3} = y - \frac{w^3}{9} = z^3 - \frac{w^3}{27} = 0, \quad (4.15)$$

which all intersects $\delta_1 = 0$. Note that the last one has three components. Now after the four A_2 singularities are resolved, the compact surface $S_1 : \delta_1 = 0$ has the form of a generalized dP_8 of type $4A_2$ (the (-2) -curves on S_1 consists of four disconnected A_2 Dynkin diagram).

In the limit of zero surface volume, the UV SCFT is the rank-1 Seiberg E_8 theory. We do not write down the fully resolved equation for simplicity.

2. $n = 6$

For $n = 6$, the whole resolution sequence giving rise to compact divisors is

$$(x^{(2)}, y^{(3)}, z^{(1)}, w^{(1)}; \delta_1), \quad (x^{(2)}, y^{(3)}, w^{(1)}, \delta_1^{(1)}; \delta_2), \quad (x_2, y, \delta_1; \delta_3) \\ (y, \delta_3; \delta_4) \quad (4.16)$$

The resolved equation at this step is

$$-x_2^3 \delta_3 + 4wx_2y + 8y^2 \delta_4 + 8\delta_1^3 \delta_3 z^6 (w^3 + 3\delta_3 \delta_4 wx_2 + 3\delta_3 \delta_4^2 y) z^6 + 72\delta_1^6 \delta_3^4 \delta_4^3 z^{12} = 0. \quad (4.17)$$

The compact divisors are $S_1 : \delta_1 = 0$, $S_2 : \delta_2 = 0$, $S_3 : \delta_3 = 0$, $S_4 : \delta_4 = 0$ and they are all irreducible. This matches the expected $r = 4$. The intersection numbers between them can be computed using the SR ideal from the resolution sequence

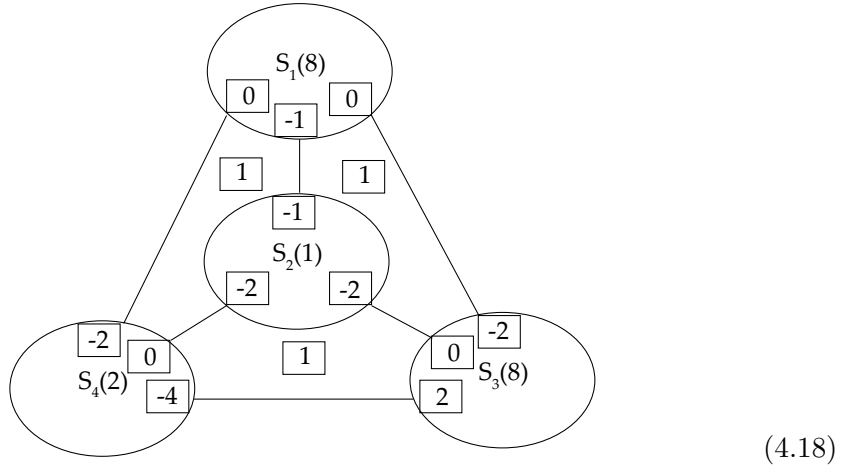

The flavor symmetry is enhanced to

$$G_F = SU(9) \times E_6. \quad (4.24)$$

For higher $n = 3k$, the flavor symmetry is similarly

$$G_F = SU(3k) \times E_6. \quad (4.25)$$

4.2 A new 6d (1,0) SCFT from $\mathbb{C}^3/\Delta(48)$

In this section we consider the case of $\Delta(3n^2)$, $n = 4$. An interesting observation is that the tensor branch geometry of T_X^{6d} consists of a (-1) -curve with an Kodaira I_1 singularity. From resolution geometry and gravitational anomaly arguments, we postulate that T_X^{6d} is different from the rank-1 E-string. We also work out T_X^{5d} from the resolution of $\mathbb{C}^3/\Delta(48)$, which turns out to be the rank-1 Seiberg E_5 theory.

4.2.1 6d interpretation

From the equation

$$\begin{cases} y^2 = x^3 + \frac{1}{12}w(8U - 9w^3)x + \frac{1}{108}(8U^2 - 36Uw^3 + 27w^6) \\ U = w^3 - 27z^4, \end{cases} \quad (4.26)$$

we can see that the non-compact curves supporting Kodaira singular fiber are

$$\begin{aligned} z = 0 : I_{4,s}, G_{F,6d} = SU(4) \\ U = w^3 - 27z^4 = 0 : I_{3,s}, G_{F,6d} = SU(3). \end{aligned} \quad (4.27)$$

The total 6d flavor symmetry is

$$G_{F,6d} = SU(4) \times SU(3). \quad (4.28)$$

To get the tensor branch, one blows up the base $(w, z; \delta)$, and the resulting (f, g, Δ) are

$$\begin{aligned} f &= -\frac{1}{12}w(w^3 + 216z^4\delta) \\ g &= -\frac{w^6}{108} + 5w^3z^4\delta + 54z^8\delta^2 \\ \Delta &= -4z^4(w^3 - 27z^4\delta)^3\delta \\ &= -4z^4U^3\delta, \end{aligned} \quad (4.29)$$

The tensor branch is

$$(4.30)$$

with a single (-1) -curve carrying I_1 singular fiber. At the collision point $z = \delta = 0$ between $I_{4,s}$ and I_1 , the $I_{4,s}$ fiber splits into $I_{5,s}$. At the collision point $U = \delta = 0$ between $I_{3,s}$ and I_1 , the Kodaira fiber type becomes type IV. Hence at $z = \delta = 0$, there are 4 localized neutral hypermultiplets in the $\mathbf{4}$ representation of the flavor symmetry group $SU(4)$. At $U = \delta = 0$, the enhancement of $I_{3,s} \rightarrow IV$ does not give rise to matter hypermultiplets as there are no additional \mathbb{P}^1 s from the enhancement.

From the above discussions of splitting of Kodaira fiber on $\delta = 0$, we can draw the configuration of curves on the vertical divisor S over $\delta = 0$:

(4.31)

C_1, C_2, C_3, C_4 and C_7 comes from the split $I_{5,s}$, C_5, C_6 and C_8 comes from the type IV fiber, Z corresponds to the intersection curve with the zero-section. Note that C_3 and C_4 have normal bundle $\mathcal{O}(-1) \oplus \mathcal{O}(-1)$, because M2-brane wrapping modes over them would give rise to matter hypermultiplets under $SU(4)$.

For the topology of S , it is different from a rational elliptic surface as the Picard rank is smaller than 10. The $h^{1,1}(S) = 7$ generators include the base curve Z , the generic fiber and the five (-2) -curves generating $G_{F,6d} = SU(3) \times SU(4)$. The generic (I_1) fiber of S , F , is a cubic curve with a double point singularity. Because of the double point singularity, the curve F has geometric genus $g(F) = 0$. In terms of the Picard group generator h, e_1, \dots, e_6 of a dP_6 , the fiber F can be written as

$$F = 3h - 2e_1 - e_2 - e_3 - e_4 - e_5 - e_6. \quad (4.32)$$

Although S is a singular dP_6 surface rather than an elliptic surface, the uplift to 6d still works geometrically, since the genus-0 fiber F is interpreted as a singular cubic curve.

An important question is whether this 6d theory is equivalent to rank-1 E-string theory. Positive evidences were provided in [101], where it is showed that for the cases of type I_1 or II fiber over a (-1) -curve, the flavor symmetry group G on non-compact curves intersecting the (-1) -curve is always a subgroup of E_8 . This is a crucial feature of rank-1 E-string theory. Nonetheless, if the tensor branch shown in (4.30) is embedded in a compact base, after going to the origin of the tensor branch by blowing down the (-1) -curve, the number of tensor multiplets T and charged hypermultiplets H_{charged} are shifted as

$$\Delta T = -1, \quad \Delta H_{\text{charged}} = -4. \quad (4.33)$$

The 6d gravitational anomaly cancellation can be written as

$$\Delta H_{\text{moduli}} + \Delta H_{\text{localized}} + \Delta H_{\text{charged}} - \Delta V + 29\Delta T = 0, \quad (4.34)$$

where H_{moduli} corresponds to the number of complex structure moduli of the CY3, which is unchanged after going into the tensor branch. $H_{\text{localized}}$ denotes additional SCFT sector which contributes to the gravitational anomaly, V denotes the number of vector multiplets.

In this case, we have

$$\begin{aligned}\Delta H_{\text{localized}} &= -\Delta H_{\text{charged}} - 29\Delta T \\ &= 33,\end{aligned}\tag{4.35}$$

which is bigger than the contribution of a simple rank-1 E-string theory. This is due to the fact that additional hypermultiplets on the tensor branch become a part of the strongly interacting theory at the origin of the tensor branch. In other words, the Higgs branch dimension of this rank-1 theory is bigger than $d_H = 29$ of the rank-1 E-string theory. Conservatively, we conjecture that the 6d theory associated to $\Delta(48)$ is different from the rank-1 E-string theory, but it is possibly rank-1 E-string theory coupled to $-\Delta H_{\text{charged}} = 4$ neutral hypermultiplets.

4.2.2 5d interpretation

Now we discuss the 5d interpretation of the non-isolated singular equation

$$w^6 - 3w^4x + 3w^2x^2 - x^3 - 4w^3y + 4wxy + 8y^2 - 16w^3z^4 + 24wxz^4 + 24yz^4 + 72z^8 = 0.\tag{4.36}$$

We first do the resolution

$$(y^{(3)}, x^{(2)}, z^{(1)}, w^{(1)}, \delta_1),\tag{4.37}$$

resulting in the compact exceptional divisor $S_1 : \delta_1 = 0$.

After substituting variables

$$x \rightarrow x + \frac{w^2}{3}, \quad y \rightarrow y + \frac{w^3}{9},\tag{4.38}$$

the equation can be rewritten as

$$\begin{cases} -x^3 + 2w^2x^2 + 4wxy - \frac{8}{9}wxU + \frac{8}{81}(81y^2 - 9yU + U^2) = 0 \\ U = w^3 - 27z^4\delta_1. \end{cases}\tag{4.39}$$

Now we can blow up the A_2 singularity

$$(x, y, U; \delta_2)\tag{4.40}$$

and get the new equation

$$\begin{cases} -x^3\delta_2 + 2w^2x^2 + 4wxy - \frac{8}{9}wxU + \frac{8}{81}(81y^2 - 9yU + U^2) = 0 \\ U\delta_2 = w^3 - 27z^4\delta_1. \end{cases}\tag{4.41}$$

To see the remaining singularity, we work in the patch of $U \neq 0$, and substitute

$$\delta_2 = \frac{w^3 - 27z^4\delta_1}{U}\tag{4.42}$$

into the first equation. We again get a hypersurface:

$$\frac{8U^3}{81} - \frac{8}{9}U^2(wx + y) + 2U(w^2x^2 + 2wxy + 4y^2) - x^3(w^3 - 27\delta_1z^4) = 0. \quad (4.43)$$

Further introducing variables

$$y_2 = y + \frac{wx}{6}, \quad U_2 = U - \frac{3wx}{2}, \quad (4.44)$$

(4.43) can be rewritten as

$$\frac{8}{81}U_2(U_2^2 - 9U_2y_2 + 81y_2^2) - \frac{4}{27}wx(2U_2 - 9y_2)(U_2 + 9y_2) + 27x^3z^4\delta_1 = 0 \quad (4.45)$$

The type A_3 singularity at $U_2 = y_2 = z = 0$ can be resolved as

$$(U_2, y_2, z; \delta_3), \quad (U_2, y_2, \delta_3; \delta_4) \quad (4.46)$$

The resolved equation at the $U \neq 0$ patch is

$$\frac{8}{81}U_2(U_2^2 - 9U_2y_2 + 81y_2^2)\delta_3\delta_4^2 - \frac{4}{27}wx(2U_2 - 9y_2)(U_2 + 9y_2) + 27x^3z^4\delta_1\delta_3^2 = 0. \quad (4.47)$$

The projective relations are

$$\begin{aligned} &(x\delta_2, y_2\delta_2\delta_3\delta_4^2, z\delta_3\delta_4, w) \\ &(x, y_2\delta_3\delta_4^2, U_2\delta_3\delta_4^2) \\ &(U_2\delta_4, y_2\delta_4, z) \\ &(U_2, y_2, \delta_3) \end{aligned} \quad (4.48)$$

The irreducible non-compact divisors are

$$\begin{aligned} D_1 : \delta_3 &= 2U_2 - 9y_2 = 0, \\ D_2 : \delta_3 &= U_2 + 9y_2 = 0, \\ D_3 : \delta_4 &= 0. \end{aligned} \quad (4.49)$$

In the $U \neq 0$ patch, the equation for the compact exceptional divisor $S_1 : \delta_1 = 0$ is

$$\delta_1 = \frac{8}{81}U_2(U_2^2 - 9U_2y_2 + 81y_2^2)\delta_3\delta_4^2 - \frac{4}{27}wx(2U_2 - 9y_2)(U_2 + 9y_2) = 0. \quad (4.50)$$

The surface S_1 still has a double point singularity along the curve $U_2 = y_2 = 0$. The intersection curves $\delta_1 \cdot \delta_3$ and $\delta_1 \cdot \delta_4$ are

$$\begin{aligned} \delta_1 = \delta_3 = 0 : \quad &(2U_2 - 9y_2)(U_2 + 9y_2) = 0 \\ \delta_1 = \delta_4 = 0 : \quad &(2U_2 - 9y_2)(U_2 + 9y_2) = 0 \end{aligned} \quad (4.51)$$

Each of these curves have two components, denote the curves by

$$\begin{aligned} C_1 : \quad &\delta_1 = \delta_3 = 2U_2 - 9y_2 = 0 \\ C_2 : \quad &\delta_1 = \delta_3 = U_2 + 9y_2 = 0 \\ C_3 : \quad &\delta_1 = \delta_4 = 2U_2 - 9y_2 = 0 \\ C_4 : \quad &\delta_1 = \delta_4 = U_2 + 9y_2 = 0 \end{aligned} \quad (4.52)$$

The intersection relations are

$$C_1 = D_1 \cdot S_1, \quad C_2 = D_2 \cdot S_1, \quad C_3 + C_4 = D_3 \cdot S_1. \quad (4.53)$$

The other non-compact divisors are

$$\begin{aligned} D_4 : \delta_2 = U_2 - \frac{9}{2}(1 + i\sqrt{3})y_2 = 0, \\ D_5 : \delta_2 = U_2 - \frac{9}{2}(1 - i\sqrt{3})y_2 = 0, \end{aligned} \quad (4.54)$$

which give rise to the (-2) -curves $C_5 = D_4 \cdot S_1$ and $C_6 = D_5 \cdot S_1$. There are also two (-1) -curves

$$\begin{aligned} C_7 : U = 0 \\ C_8 : z = 0 \end{aligned} \quad (4.55)$$

which mutually intersects. The intersection relations between all these curves are shown in the following figure

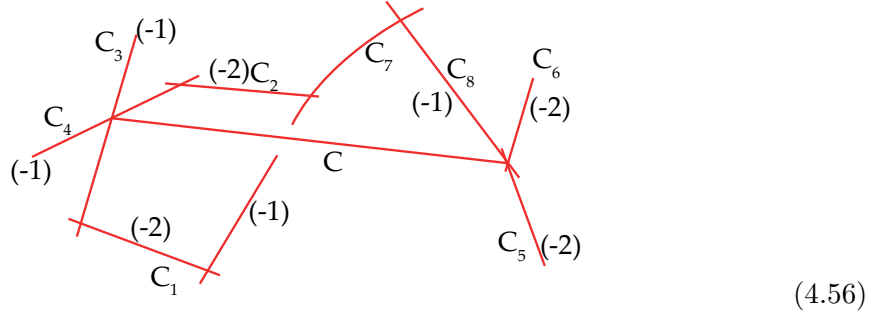

Since S_1 has a double point singularity along the central curve $C : \delta_1 = U_2 = y_2 = 0$, it is not a smooth rational surface. For C_3 and C_4 , they come from the same non-compact divisor D_3 and only give rise to a single flavor curve, which is a reminiscence of matter curve splitting in the 6d description in section 4.1.1. Note that C_3 and C_4 are (-1) -curves on S_1 , as M2-brane wrapping modes over them should give rise to matter hypermultiplets. One can also generate (4.56) by blowing down the (-1) -curve labeled by Z in the 6d geometry (4.31).

The codimension-two A_3 singularity generates $SU(2)^2 \times U(1)$ flavor symmetry in the 5d theory, and the total flavor symmetry is

$$G_F = SU(3) \times SU(2)^2 \times U(1), \quad (4.57)$$

which can be embedded in the flavor symmetry group of rank-1 Seiberg E_5 theory. There are two possible physical interpretations:

1. The rank-1 SCFT from $\mathbb{C}^3/\Delta(48)$ is equivalent to the Seiberg E_5 theory. Additional evidences are also provided via brane-web arguments in [100]. Nonetheless, it is unclear how to get the correct BPS states from M2 brane wrapping curves in (4.56).
2. The geometry describes a new rank-1 theory, analogous to the cases with terminal singularities or singular divisors in [7, 8].

To solve the problem, more physical quantities should be computed, such as the Higgs branch dimensions or superconformal indices. Similar subtleties appear in the cases of $\Gamma = E^{(2)}, E^{(4)}, G_3$ and H_{168} as well.

4.3 $\Delta(54)$

In this section we discuss the case of $X = \mathbb{C}^3/\Delta(6n^2)$, $n = 3$. In this case T_X^{6d} is non-very-Higgsable. To get T_X^{5d} , one need to decouple a single vector multiplet after the KK reduction.

4.3.1 6d interpretation

Starting with the singular equation

$$\begin{cases} 27u^{2k+1} + 4vuw^k - 18u^k vx - wx^2 + 4x^3 + y^2 = 0, \\ v^2 - uw = 0, \end{cases} \quad (4.58)$$

we rescale and shift the coordinates and rewrite the equation into a Weierstrass equation

$$\begin{cases} y^2 = x^3 - \frac{1}{12 \times 2^{2/3}}(216u^k v + w^2)x + 27u^{1+2k} + \frac{5}{2}u^k vw - \frac{w^3}{216}, \\ v^2 - uw = 0. \end{cases} \quad (4.59)$$

Thus the singular equation can be viewed as an elliptic fibration over a singular base with \mathbb{Z}_2 orbifold singularity at $u = v = w = 0$.

Another equivalent description is to replace

$$u = s^2, \quad v = st, \quad w = t^2, \quad (4.60)$$

and the Weierstrass polynomials become

$$\begin{aligned} f &= -\frac{1}{12 \times 2^{2/3}}(t^4 + 216s^{2k+1}t) \\ g &= -\frac{t^6}{216} + \frac{5}{2}s^{2k+1}t^3 + 27s^{4k+2}. \end{aligned} \quad (4.61)$$

Nonetheless, the base still has a \mathbb{Z}_2 singularity at $s = t = 0$. Now we discuss the tensor branch of models with small k .

In the case of $k = 1, n = 3$, after the base blow up $(s, t; \delta)$ (or equivalently $(u, v, w; \delta)$), the new (f, g, Δ) are

$$\begin{aligned} f &= -\frac{1}{12 \times 2^{2/3}}(t^4 + 216s^3t)\delta^2 \\ g &= \left(-\frac{t^6}{216} + \frac{5}{2}s^3t^3 + 27s^6\right)\delta^3 \\ \Delta &= s^3(3s - t)^3(3e^{\frac{2\pi i}{3}}s - t)^3(3e^{\frac{4\pi i}{3}}s - t)^3\delta^6 \end{aligned} \quad (4.62)$$

There is no codimension-two (4,6) locus any more. Over the compact (-2) -curve: $\delta = 0$, there is type $I_{0,ns}^*$ singular fiber and G_2 gauge group. There are four $I_{3,ns}$ fiber and $SU(2)$ flavor groups over four non-compact curves

$$s = 0, \quad 3s - t = 0, \quad 3e^{\frac{2\pi i}{3}}s - t = 0, \quad 3e^{\frac{4\pi i}{3}}s - t = 0. \quad (4.63)$$

In fact, if one tunes G_2 gauge group over a (-2) -curve, the 6d gauge theory is exactly $G_2+4\mathbf{F}$. The four matter hypermultiplets exactly locate on the intersection points between $\delta = 0$ and (4.63). The tensor branch of the 6d SCFT is written as

$$\begin{array}{ccc} & [SU(2)] & \\ & | & \\ [SU(2)]- & \frac{\mathfrak{g}_2}{2} & -[SU(2)] \\ & | & \\ & [SU(2)] & \end{array} \quad (4.64)$$

One can also collide the four intersection points into a single $(Sp(4), G_2)$ collision, and the tensor branch is

$$[Sp(4)] - \frac{\mathfrak{g}_2}{2}. \quad (4.65)$$

The resolution geometry of this SCFT was already worked out in (4.38) of [17]. The triple intersection numbers among three compact surfaces S_1 , S_2 and S_3 are

$$S_1^3 = 8, S_2^3 = -24, S_3^3 = 8, S_3 S_1^2 = -2, S_2^2 S_3 = 18, S_2 S_3^2 = -12. \quad (4.66)$$

4.3.2 5d interpretation

First we consider the case of $\mathbb{C}^3/\Delta(6n^2)$ theory with $n = 3$:

$$\begin{cases} 27u^3 + 4uvx - 18uvy - xy^2 + 4y^3 + z^2 = 0, \\ v^2 - ux = 0. \end{cases} \quad (4.67)$$

We can perform the following resolution sequence

$$(x, y, z, u, v; \delta_1), (z, \delta_1; \delta_2), (\delta_1, \delta_2; \delta_3), \quad (4.68)$$

and the equations become

$$\begin{cases} (27u^3 + 4uvx - 18uvy - xy^2 + 4y^3)\delta_1 + z^2\delta_2 = 0, \\ v^2 - ux = 0. \end{cases} \quad (4.69)$$

Note that the divisors $\delta_1 = 0$ is an empty set, $\delta_2 = 0$ and $\delta_3 = 0$ are the two compact exceptional divisors.

In the patch of $u \neq 0$, we plug $x = v^2/u$ into the first equation, and get

$$(27u^4 + 4uv^3 - 18u^2vy - v^2y^2 + 4uy^3)\delta_1 + uz^2\delta_2 = 0. \quad (4.70)$$

The remaining codimension-two singularities are type A_1 at

$$u = v = z^2\delta_2 + 4y^3\delta_1 = 0, \quad (4.71)$$

(note that this curve is non-singular since $u = v = y = z = 0$ is removed in the first blow-up) and type A_2 at

$$z = v - e^{2\pi im/3}y = u - e^{4\pi im/3}y = 0 \quad (m = 0, 1, 2). \quad (4.72)$$

The resolution of each type A_2 singularity gives rise to a single non-compact exceptional divisor, after

$$(z, v - e^{2\pi im/3}y, u - e^{4\pi im/3}y; \delta_{4+m}) \quad (m = 0, 1, 2), \quad (4.73)$$

the non-compact exceptional divisors δ_{4+m} ($m = 0, 1, 2$) are irreducible. The same codimension-two singular loci can be seen from the other patch $x \neq 0$ as well.

Furthermore, there is an A_1 singularity at $v = u = x = 0$. Hence in total there are five non-compact exceptional divisors, giving rise to $G_F \supset SU(2)^5$.

We can also compute the triple intersection number of the two compact surfaces $S_2 : \delta_2 = 0$, $S_3 : \delta_3 = 0$, following the algorithm in section 2.2.2:

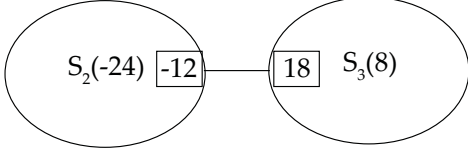

$$(4.74)$$

The topology of S_2 is a \mathbb{P}^1 fibered over the $g = 4$ curve $S_2 \cdot S_3$, and S_3 is a Hirzebruch surface. Nonetheless, we can blow up $S_2 \cdot S_3$ at four double points on S_3 , and transform it to a rational configuration [16]:

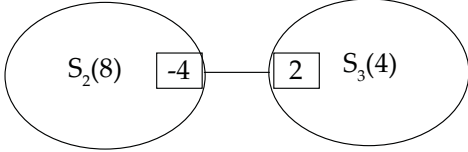

$$(4.75)$$

The latter geometry gives rise to the 5d IR gauge theory $G_2 + 4\mathbf{F}$ (with equivalent descriptions $Sp(2) + 2\mathbf{AS} + 2\mathbf{F}$ and $SU(3)_5 + 4\mathbf{F}$), which indeed has $f = 5$ and $r = 2$. The flavor symmetry is $G_F = Sp(4) \times Sp(1)$.

Note that in the 6d description of $\Delta(54)$, whose resolved elliptic CY3 has three compact divisors (4.66). Now we decompactify the divisor S_1 , following the philosophy of [13, 21], and the remaining compact divisors S_2, S_3 exactly correspond to the two compact divisors in this section. An additional $SU(2)$ flavor symmetry appears from 6d to 5d, because $S_2 S_1^2 = -2$ in (4.66), and $S_1 \cdot S_2$ becomes a new flavor curve that generates $SU(2)$ flavor symmetry factor.

4.4 G_m

In this section, we provide a class of examples without a straight-forward T_X^{6d} interpretation, which is $\Gamma = G_m$. The G_m orbifold is given by the hypersurface equation

$$wx(4x^m - y^2) + z^2 = 0. \quad (4.76)$$

The resolution of this singularity is qualitatively different for odd and even m . For even m , the codimension-two singular loci are all smooth, and the resolution procedure is the conventional hypersurface one. On the other hand, for odd m , the resolved equation becomes a complete intersection CY3 in the process.

4.4.1 $m = 2k$

For example, for $m = 2$, the equation

$$wx(4x^2 - y^2) + z^2 = 0 \quad (4.77)$$

can be resolved by

$$(z^{(2)}, x^{(1)}, y^{(1)}, w^{(1)}; \delta_1). \quad (4.78)$$

Then one can resolve the $D_4 \times A_1^3$ codimension-two singularities afterwards.

The compact exceptional divisor $S_1 : \delta_1 = 0$ is a generalized dP₇ of type $\mathbf{D}_4 + 3\mathbf{A}_1$. The 5d SCFT is the rank-1 E_7 theory.

For $m = 2k$ ($k \geq 2$), the equation

$$wx(4x^{2k} - y^2) + z^2 = 0 \quad (4.79)$$

can be resolved by

$$\begin{aligned} &(z^{(2)}, x^{(1)}, y^{(1)}, w^{(1)}; \delta_1) \\ &(y, z, \delta_i; \delta_{i+1}) \quad (i = 1, \dots, k-1). \end{aligned} \quad (4.80)$$

And then the $D_{2k+2} \times A_1^3$ codimension-two singularities can be resolved in the conventional way.

The triple intersection number among the compact exceptional divisors $S_i : \delta_i = 0$ are

$$\begin{array}{ccccccc} \text{Oval 1} & \text{Box 2} & \text{Box -4} & \text{Oval 2} & \text{Box 4} & \dots & \text{Box -2k} & \text{Oval 3} & \text{Box 2k-2} & \text{Oval 4} & \text{Box -2k} & \text{Oval 5} & \text{Box 2k-2} \\ S_1(8) & & & S_2(8) & & & & S_{k-1}(8) & & S_k(4-2k) & & & \end{array} \quad (4.81)$$

The corresponding 5d SCFT is the UV completion of IR gauge theory $Sp(k) + (2k + 4)\mathbf{F}$. The UV flavor symmetry is

$$G_F = SO(4k + 8) \times SU(2), \quad (4.82)$$

which contains the flavor symmetry read off from codimension-two singularities as a subset.

4.4.2 $m = 2k + 1$

For $m = 3$, we first do the blow ups

$$\begin{aligned} &(z^{(2)}, x^{(1)}, y^{(1)}, w^{(1)}; \delta_1), (x, z, w; \delta_2), (x, y, z; \delta_3), (y, z, \delta_3; \delta_4) \\ &(z, \delta_3; \delta_5), (\delta_3, \delta_5; \delta_6), (\delta_4, \delta_5; \delta_7) \end{aligned} \quad (4.83)$$

and get

$$wx(4x^3 \delta_1 \delta_2^3 \delta_3 \delta_5 \delta_6^2 - y^2 \delta_4) \delta_3 + z^2 \delta_5 = 0 \quad (4.84)$$

Then we define

$$U = 4x^3 \delta_1 \delta_2^3 \delta_3 \delta_5 \delta_6^2 - y^2 \delta_4 \quad (4.85)$$

and blow up

$$(z, w, U; \delta_8). \quad (4.86)$$

The resolved equation is

$$\begin{cases} wxU\delta_3 + z^2\delta_5 = 0 \\ U\delta_8 = 4x^3\delta_1\delta_2^3\delta_3\delta_5\delta_6^2 - y^2\delta_4. \end{cases} \quad (4.87)$$

The curves on the single compact divisor $S_1 : \delta_1 = 0$ are

$$\begin{aligned} C_1 : \quad & \delta_1 = \delta_4 = 0 \\ C_2 : \quad & \delta_1 = \delta_5 = 0 \\ C_3 : \quad & \delta_1 = \delta_6 = 0 \\ C_4 : \quad & \delta_1 = \delta_7 = 0 \\ C_5 : \quad & \delta_1 = \delta_2 = 0 \\ C_6 : \quad & \delta_1 = \delta_8 = 0 \end{aligned} \quad (4.88)$$

Among these, C_1, C_2, C_3, C_4 come from the resolution of codimension-two D_5 singularity, and C_1 is the degenerate \mathbb{P}^1 curve with normal bundle $\mathcal{O}(-1) \oplus \mathcal{O}(-1)$. The other curves are all (-2) -curves, which form the Dynkin diagram of $A_3 \times A_1^2$. Hence the flavor symmetry factors from C_i is $G_F = SU(4) \times SU(2)^2 \times U(1)$.

5 Future Directions

In this paper, we investigated various \mathbb{C}^3/Γ orbifolds using 3d McKay correspondence and resolution techniques. Nonetheless, there are still infinitely many cases to be studied in details. We conclude the paper by listing a number of future questions.

- In the version of McKay correspondence in [96], the Γ -Hilbert scheme corresponds to a particular resolution \tilde{X} of \mathbb{C}^3/Γ . The detail of this correspondence is unknown except for the abelian Γ [55, 96] and a few non-abelian cases [102, 103]. It would be interesting to read off more details of \tilde{X} and the 5d SCFT T_X^{5d} from the group theoretic data of Γ .
- Resolving \mathbb{C}^3/Γ for the other cases of Γ mentioned in section 3, which are not explicitly studied in this paper. Especially, more advanced techniques are needed to compute triple intersection numbers in the cases involving polynomial blow-ups, shifting variables and singular divisors. There are also additional cases in the class (B), (C) and (D) that cannot be written as a hypersurface in \mathbb{C}^4 or a complete intersection in \mathbb{C}^5 , which should be investigated in the future. In particular, they include interesting cases with a non-trivial 1-form symmetry, which is mentioned at the end of section 2.4.
- Understand the physics associated to compact divisors with log-canonical singularities, which often appears in not only the cases of $X = \mathbb{C}^3/\Gamma$, but also the isolated

hypersurface singularities [6, 7]. In the 6d descriptions of $\Delta(48)$ and H_{168} , these singular divisors potentially give rise to new 6d (1,0) SCFTs. The details of these (1,0) SCFTs should be elucidated in a future work.

- Study the Higgs branch of T_X^{5d} , using either brane web or geometric techniques. For the cases of $\Gamma = \Delta(3n^2)$, this is worked out in [100]. It would be interesting to study the other classes of $SU(3)$ subgroups as well. A more difficult question is to study the deformation of X , which is a non-isolated singularity.

Acknowledgements

We thank Bobby Acharya, Jim Halverson, Max Hubner, Horia Magureanu, David Morrison, Sakura Schafer-Nameki, Benjamin Sung and Hao Y. Zhang for helpful discussions. JT would like to thank Ying Zhang for her love and support. The work of JT is supported by a grant from the Simons Foundation (#488569, Bobby Acharya). YW is supported by National Science Foundation of China under Grant No. 12175004, by Peking University under startup Grant No. 7100603534 and by the ERC Consolidator Grant number 682608 “Higgs bundles: Supersymmetric Gauge Theories and Geometry (HIGGSBNDL)”.

A The abelian subgroups of the exceptional finite subgroups of $SU(3)$

In this appendix we summarize the abelian subgroups G^A of the exceptional finite subgroups $G \subset SU(3)$, i.e., $E^{(n)}$ and $H_{36}, H_{60}, H_{72}, H_{168}, H_{216}, H_{360}$. We will represent type of an abelian subgroup $G^A \subset G$ by the conjugacy classes of its elements. We will underline the conjugacy class if $\text{age}(g) = 2$ for its representative $g \in G^A$ and overline the conjugacy class which has an $\text{age}(g) = 2$ dual. For example if

$$G^A = \{1, a_1, a_2, \dots, a_n\} \quad (\text{A.1})$$

then we represent G^A by

$$r(G^A) = \{c(1), \underline{c(a_1)}, \overline{c(a_2)}, \dots, c_{a_n}\} \quad (\text{A.2})$$

where $c(\cdot)$ maps a group element to the conjugacy class it belongs to and in this case $\text{age}(a_1) = 2$ and a_2 has an $\text{age}(g) = 2$ dual. Also we will adopt the notation that when $G^A \cong \mathbb{Z}_{m+1} \times \mathbb{Z}_{n+1}$ we represent it by

$$r(G^A) = \{c(a_{00}), c(a_{01}), \dots, c(a_{0m}), \quad (\text{A.3})$$

$$\dots \quad (\text{A.4})$$

$$c(a_{n0}), c(a_{n1}), \dots, c(a_{nm})\} \quad (\text{A.5})$$

where a_{01} is the generator of \mathbb{Z}_{m+1} and a_{10} is the generator of \mathbb{Z}_{n+1} and $a_{ij} = a_{10}^i \cdot a_{01}^j$.

Note that two different abelian subgroups $G_1^A \subset G$ and $G_2^A \subset G$ can have the same types, i.e., $r(G_1^A) = r(G_2^A)$. Physically, different abelian subgroups of G that have the same $r(G^A)$ lead to identical information on the Coulomb branch. Therefore, for our purpose,

A.1.2 $E^{(2)}$

There are in total 7 conjugacy classes and 7 abelian subgroups. There are 4 of them that are $\mathbb{Z}_3 \times \mathbb{Z}_2$ whose types are

$$r(G^A) = \{0, 3, 4, 2, \bar{6}, \bar{5}\} \quad (\text{A.11})$$

and there are 3 of them that are \mathbb{Z}_4 whose types are

$$r(G^A) = \{0, 1, 2, 1\}. \quad (\text{A.12})$$

The maximal \mathbb{Z}_N subgroups

$$\begin{aligned} &\{0, 1, 2, 1\}, \\ &\{0, 3, 4\} \end{aligned} \quad (\text{A.13})$$

are glued into the Dynkin diagram of $D_4 \times A_2$:

$$\begin{array}{ccccccc} & & & \circ & 1 & & \\ & & & | & & & \\ \circ & - & \circ & - & \circ & - & \circ \\ 1 & & 2 & & 1 & & 3 & 4 \end{array} \quad (\text{A.14})$$

This matches the flavor rank $f = 4$. Note that the D_4 singularity only contributes flavor rank $f = 2$, due to monodromy reduction. In fact, the binary dihedral group \mathbb{D}_4 is a subgroup of $E^{(2)}$, which also confirms that there is a D_4 factor instead of A_3 .

From the singularity equation

$$z^3 - w(y^3 + 12\sqrt{3}ix^2) = 0, \quad (\text{A.15})$$

one can also check that there is a D_4 singularity along $x = y = z = 0$ and an A_2 singularity along $w = z = 12\sqrt{3}ix^2 + y^3 = 0$.

A.1.3 $E^{(3)}$

There are in total 16 conjugacy classes and 13 abelian subgroups. There are 3 of them that are $\mathbb{Z}_8 \times \mathbb{Z}_2$ whose types are

$$r(G^A) = \{0, 15, 9, 14, 8, 14, 9, 15, 11, \bar{6}, \bar{4}, \bar{6}, 11, \bar{7}, \bar{5}, \bar{7}\}, \quad (\text{A.16})$$

there are 4 of them that are $\mathbb{Z}_4 \times \mathbb{Z}_3$ whose types are

$$r(G^A) = \{0, \bar{4}, 8, \bar{5}, 12, \bar{3}, 13, \bar{2}, 12, \bar{3}, 13, \bar{2}\} \quad (\text{A.17})$$

and there are 6 of them that are $\mathbb{Z}_4 \times \mathbb{Z}_2$ whose types are

$$r(G^A) = \{0, \bar{4}, 8, \bar{5}, 1, 10, 1, 10\}. \quad (\text{A.18})$$

A.1.6 $E^{(6)}$

There are in total 14 conjugacy classes and 7 abelian subgroups. There are 4 of them that are $\mathbb{Z}_4 \times \mathbb{Z}_3$ whose types are

$$r(G^A) = \{0, \underline{10}, 3, \overline{11}, \\ 5, \overline{9}, 13, \underline{4}, \\ 7, \overline{8}, 12, \underline{6}\} \quad (\text{A.34})$$

and there are 3 of them that are $\mathbb{Z}_4 \times \mathbb{Z}_2$ whose types are

$$r(G^A) = \{0, 2, 3, 2, \\ 1, \overline{11}, 1, \underline{10}\}. \quad (\text{A.35})$$

The maximal \mathbb{Z}_n subgroups

$$\{0, 12, 5, 3, 7, 13\} \\ \{0, 2, 3, 2\} \\ \{0, 1\} \quad (\text{A.36})$$

are glued into the Dynkin diagram of $E_6 \times A_1$:

$$\begin{array}{cccccc} & & \circ & & & \\ & & | & & & \\ \circ & - & \circ & - & \circ & - & \circ & - & \circ \\ 12 & & 5 & & 3 & & 7 & & 13 & & 1 \end{array} \quad (\text{A.37})$$

This matches the flavor rank $f = 7$.

The singular equation is a complete intersection

$$\begin{cases} y^3 - z^2 = 108x^2 \\ u^2 - vx = 0. \end{cases} \quad (\text{A.38})$$

We impose $v \neq 0$ first and plug $x = u^2/v$ into the first equation. We see that on the $v \neq 0$ patch there is an E_6 singularity along $u = x = y = z = 0$. Clearly there is also an A_1 singularity along $u = v = x = z^2 - y^3 = 0$.

A.1.7 $E^{(7)}$

There are in total 24 conjugacy classes and 13 abelian subgroups. There are 3 of them that are $\mathbb{Z}_8 \times \mathbb{Z}_3$ whose types are

$$r(G^A) = \{0, 14, 1, 15, 7, 15, 1, 14, \\ 11, \underline{21}, \overline{2}, \overline{22}, \underline{8}, \overline{22}, \overline{2}, \underline{21}, \\ 10, \overline{23}, \underline{3}, \underline{20}, \overline{9}, \underline{20}, \underline{3}, \overline{23}\}, \quad (\text{A.39})$$

there are 4 of them that are $\mathbb{Z}_6 \times \mathbb{Z}_3$ whose types are

$$r(G^A) = \{0, \underline{8}, \underline{10}, 7, \overline{11}, \overline{9}, \\ 16, \underline{18}, 12, \overline{19}, 17, 13, \\ 17, 13, 16, \underline{18}, 12, \overline{19}\} \quad (\text{A.40})$$

The maximal \mathbb{Z}_N subgroups

$$\begin{aligned}
& \{0, 14, 16, 12, 15, 9, 15, 12, 16, 14\} , \\
& \{0, 13, 17, 9, 17, 13\} , \\
& \{0, 10, 9, 10\} , \\
& \{0, 11\}
\end{aligned} \tag{A.54}$$

are glued into the Dynkin diagram of $E_8 \times A_1$:

$$\begin{array}{cccccccc}
& & & & \circ & & & \\
& & & & | & & & \\
& & & & 10 & & & \\
\circ & - & \circ & - & \circ & - & \circ & - & \circ & - & \circ & - & \circ \\
14 & & 16 & & 12 & & 15 & & 9 & & 17 & & 13 & & 11
\end{array} \tag{A.55}$$

This matches the flavor rank $f = 9$.

The singular equation is

$$z^2 + w(-1728x^5 + y^3) = 0. \tag{A.56}$$

There is an E_8 singularity along $x = y = z = 0$ and an A_1 singularity along $w = z = y^3 - 1728x^5 = 0$.

A.1.10 $E^{(10)}$

There are in total 27 conjugacy classes and 31 abelian subgroups. There are 6 of them that are $\mathbb{Z}_6 \times \mathbb{Z}_5$ whose types are

$$\begin{aligned}
r(G^A) = \{ & 0, \overline{10}, \overline{20}, 2, \underline{11}, \underline{19}, \\
& 6, \underline{12}, \underline{24}, 5, \overline{16}, \overline{23}, \\
& 7, \underline{14}, \overline{25}, 3, \underline{15}, \overline{21}, \\
& 7, \underline{14}, \overline{25}, 3, \underline{15}, \overline{21}, \\
& 6, \underline{12}, \underline{24}, 5, \overline{16}, \overline{23} \},
\end{aligned} \tag{A.57}$$

there are 10 of them that are $\mathbb{Z}_6 \times \mathbb{Z}_3$ whose types are

$$\begin{aligned}
r(G^A) = \{ & 0, \overline{10}, \overline{20}, 2, \underline{11}, 19, \\
& 26, 4, 17, \overline{22}, 8, \underline{13}, \\
& 17, \overline{22}, 8, \underline{13}, 26, 4 \}
\end{aligned} \tag{A.58}$$

and there are 15 of them that are $\mathbb{Z}_4 \times \mathbb{Z}_3$ whose types are

$$\begin{aligned}
r(G^A) = \{ & 0, 1, 2, 1, \\
& \underline{11}, \underline{9}, \overline{10}, \underline{9}, \\
& \overline{20}, \overline{18}, \underline{19}, \overline{18} \}.
\end{aligned} \tag{A.59}$$

The maximal \mathbb{Z}_N subgroups

$$\begin{aligned}
& \{0, 5, 7, 3, 6, 2, 6, 3, 7, 5\} , \\
& \{0, 4, 8, 2, 8, 4\} , \\
& \{0, 1, 2, 1\} , \\
& \{0, 26, 17\}
\end{aligned} \tag{A.60}$$

and there are 2 of them that are $\mathbb{Z}_3 \times \mathbb{Z}_3$ whose types are

$$r(G^A) = \{0, 4, 4, \overline{13}, 4, 4, \underline{11}, 4, 4\}. \quad (\text{A.71})$$

The maximal \mathbb{Z}_N subgroups

$$\begin{aligned} & \{0, 9, 5, 7\}, \\ & \{0, 3, 3\}, \\ & \{0, 4, 4\} \end{aligned} \quad (\text{A.72})$$

form the Dynkin diagram of $A_3 \times A_2 \times A_2$:

$$\begin{array}{cccccc} \circ & \text{---} & \circ & \text{---} & \circ & & \circ & \text{---} & \circ & & \circ & \text{---} & \circ \\ 9 & & 5 & & 7 & & 3 & & 3 & & 4 & & 4 \end{array} \quad (\text{A.73})$$

The number of conjugacy classes in $\Gamma_{1,f}$ matches the flavor rank $f = 5$. Note that each of the two A_2 singularities only has contribution $f = 1$.

The singular equation is

$$\begin{cases} 3u^2v + 2u^3 - 36uy - 36vx - v^3 + 432z^2 = 0, \\ u^2x - u^2y - 12x^2 + 9y^2 = 0. \end{cases} \quad (\text{A.74})$$

We can solve the first equation in Eq. A.74 for either x or y and plug into the second equation. Solving for x then plugging into the second equation while requiring that $v \neq 0$ we will see there are a A_3 singularity along the locus

$$\{u = x = y = 432z^2 - v^3 = 0\} \subset \mathbb{C}^5, \quad (\text{A.75})$$

an A_2 singularity along the locus

$$\{u + v = x = y = z = 0\} \subset \mathbb{C}^5 \quad (\text{A.76})$$

and another A_2 singularity along the locus

$$\{u - v = x = y - \frac{u^2}{9} = z = 0\} \subset \mathbb{C}^5. \quad (\text{A.77})$$

Solving for y then plugging into the first equation while requiring that $u \neq 0$ we see an A_2 singularity along the locus

$$\{u + v = x = y = z = 0\} \subset \mathbb{C}^5 \quad (\text{A.78})$$

and another A_2 singularity along the locus

$$\{u - v = x = y - \frac{u^2}{9} = z = 0\} \subset \mathbb{C}^5. \quad (\text{A.79})$$

We see that the two A_2 singularities seen in the $u \neq 0$ patch are exactly the same A_2 singularities seen previously in the $v \neq 0$ patch. Therefore we conclude that the total codimension 2 ADE singularity is $A_3 \times A_2 \times A_2$. Due to monodromy reduction, the two A_2 factors are reduced to flavor rank 1.

A.3 H_{60}

There are in total 5 conjugacy classes. The representatives of each non-trivial conjugacy classes are

$$\begin{aligned}
 M_1 &= \frac{1}{2} \begin{pmatrix} -1 & w^3 - w^2 & -w^3 + w^2 + 1 \\ -w^3 + w^2 & -w^3 + w^2 + 1 & 1 \\ w^3 - w^2 - 1 & 1 & w^3 - w^2 \end{pmatrix}, \\
 M_2 &= \frac{1}{2} \begin{pmatrix} 1 & w^3 - w^2 & -w^3 + w^2 + 1 \\ w^3 - w^2 & -w^3 + w^2 + 1 & 1 \\ w^3 - w^2 - 1 & -1 & -w^3 + w^2 \end{pmatrix}, \\
 M_3 &= \frac{1}{2} \begin{pmatrix} 1 & w^3 - w^2 & -w^3 + w^2 + 1 \\ -w^3 + w^2 & w^3 - w^2 - 1 & -1 \\ -w^3 + w^2 + 1 & 1 & w^3 - w^2 \end{pmatrix}, \\
 M_4 &= \begin{pmatrix} -1 & 0 & 0 \\ 0 & -1 & 0 \\ 0 & 0 & 1 \end{pmatrix}
 \end{aligned}$$

where $w = e^{2\pi i/10}$.

There are in total 21 abelian subgroups. There are 6 of them that are \mathbb{Z}_5 whose types are

$$r(G^A) = \{0, 2, 3, 3, 2\}, \quad (\text{A.80})$$

there are 5 of them that are $\mathbb{Z}_2 \times \mathbb{Z}_2$ whose types are

$$r(G^A) = \{0, 4, 4, 4\} \quad (\text{A.81})$$

and there are 10 of them that are \mathbb{Z}_3 whose types are

$$r(G^A) = \{0, 1, 1\}. \quad (\text{A.82})$$

The maximal \mathbb{Z}_N subgroups

$$\begin{aligned}
 &\{0, 2, 3, 3, 2\}, \\
 &\{0, 1, 1\}, \\
 &\{0, 4\}
 \end{aligned} \quad (\text{A.83})$$

form the Dynkin diagram of $A_4 \times A_2 \times A_1$:

$$\begin{array}{ccccccc}
 \circ & \circ & \circ & \circ & \circ & \circ & \circ \\
 2 & 3 & 3 & 2 & 1 & 1 & 4
 \end{array} \quad (\text{A.84})$$

The number of conjugacy classes in $\Gamma_{1,f}$ matches the flavor rank $f = 4$. Note that the A_4 singularity only has contribution $f = 2$ and the A_2 singularity only has contribution $f = 1$.

The singular equation is

$$\begin{aligned}
0 = & 10125w^2 - 13071240x^4y^2z + 446240256x^9y^2 - 408197440x^6y^3 + 174372625x^3y^4 \\
& + 25927020x^2yz^2 + 40449024x^7yz - 245088256x^{12}y - 17622576x^5z^2 - 13658112x^{10}z \\
& + 54329344x^{15} - 21994875xy^3z - 18907875y^5 - 2777895z^3.
\end{aligned} \tag{A.85}$$

In this case we find an A_4 singularity along the locus

$$\{w = 35y - 32x^3 = 95z - 64x^5 = 0\} \subset \mathbb{C}^4, \tag{A.86}$$

an A_1 singularity along the locus

$$\{w = y - x^3 = z - x^5 = 0\} \subset \mathbb{C}^4 \tag{A.87}$$

and an A_2 singularity along the locus

$$\{w = 63y - 64x^3 = 1539z - 1600x^5 = 0\} \subset \mathbb{C}^4. \tag{A.88}$$

Due to monodromy, the A_4 factor is reduced to flavor rank 2 and the A_2 factor is reduced to flavor rank 1.

A.4 H_{72}

There are in total 16 conjugacy classes. The representatives of each conjugacy classes are

$$\begin{aligned}
M_1 &= \begin{pmatrix} 0 & -1 & 0 \\ -w & 0 & 0 \\ 0 & 0 & -w^2 \end{pmatrix}, \quad M_2 = \begin{pmatrix} 0 & -1 & 0 \\ -w^2 & 0 & 0 \\ 0 & 0 & -w \end{pmatrix}, \quad M_3 = \begin{pmatrix} 0 & 0 & 1 \\ 1 & 0 & 0 \\ 0 & 1 & 0 \end{pmatrix}, \\
M_4 &= \begin{pmatrix} -1 & 0 & 0 \\ 0 & 0 & -1 \\ 0 & -1 & 0 \end{pmatrix}, \quad M_5 = \frac{1}{3} \begin{pmatrix} -w+1 & -w+1 & -w+1 \\ -w+1 & -w-2 & 2w+1 \\ -w+1 & 2w+1 & -w-2 \end{pmatrix}, \\
M_6 &= \frac{1}{3} \begin{pmatrix} -w+1 & -w+1 & -w+1 \\ 2w+1 & -w+1 & -w-2 \\ -w-2 & -w+1 & 2w+1 \end{pmatrix}, \quad M_7 = \begin{pmatrix} -w+1 & -w+1 & 2w+1 \\ -w+1 & -w-2 & -w-2 \\ -w-2 & -w+1 & -w-2 \end{pmatrix}, \\
M_8 &= \frac{1}{3} \begin{pmatrix} -w+1 & -w+1 & 2w+1 \\ 2w+1 & -w+1 & -w+1 \\ 2w+1 & -w-2 & 2w+1 \end{pmatrix}, \quad M_9 = \frac{1}{3} \begin{pmatrix} -w+1 & -w+1 & -w-2 \\ -w+1 & -w-2 & -w+1 \\ 2w+1 & -w-2 & -w-2 \end{pmatrix}, \\
M_{10} &= \frac{1}{3} \begin{pmatrix} -w+1 & -w+1 & -w-2 \\ 2w+1 & -w+1 & 2w+1 \\ -w+1 & 2w+1 & 2w+1 \end{pmatrix}, \quad M_{11} = \frac{1}{3} \begin{pmatrix} w+2 & w+2 & w+2 \\ w+2 & w-1 & -2w-1 \\ w+2 & -2w-1 & w-1 \end{pmatrix}, \\
M_{12} &= \frac{1}{3} \begin{pmatrix} w+2 & w+2 & -2w-1 \\ w+2 & w-1 & w-1 \\ w-1 & w+2 & w-1 \end{pmatrix}, \quad M_{13} = \frac{1}{3} \begin{pmatrix} w+2 & w+2 & w-1 \\ w+2 & w-1 & w+2 \\ -2w-1 & w-1 & w-1 \end{pmatrix}, \\
M_{14} &= \begin{pmatrix} w^2 & 0 & 0 \\ 0 & w^2 & 0 \\ 0 & 0 & w^2 \end{pmatrix}, \quad M_{15} = \begin{pmatrix} w & 0 & 0 \\ 0 & w & 0 \\ 0 & 0 & w \end{pmatrix}
\end{aligned}$$

where $w = e^{2\pi i/3}$.

There are in total 31 abelian subgroups. There are 9 of them that are $\mathbb{Z}_4 \times \mathbb{Z}_3$ whose types are

$$r(G^A) = \{0, 8, 4, 8, \overline{15}, \overline{13}, 2, \overline{13}, \underline{14}, \underline{7}, \overline{1}, \underline{7}\}, \quad (\text{A.89})$$

there are 9 of them that are $\mathbb{Z}_4 \times \mathbb{Z}_3$ whose types are

$$r(G^A) = \{0, 6, 4, 6, \overline{15}, \overline{11}, 2, \overline{11}, \underline{14}, \underline{5}, \overline{1}, \underline{5}\}, \quad (\text{A.90})$$

there are 9 of them that are $\mathbb{Z}_4 \times \mathbb{Z}_3$ whose types are

$$r(G^A) = \{0, 10, 4, 10, \overline{15}, \overline{12}, 2, \overline{12}, \underline{14}, \underline{9}, \overline{1}, \underline{9}\}, \quad (\text{A.91})$$

and there are 4 of them that are $\mathbb{Z}_3 \times \mathbb{Z}_3$ whose types are

$$r(G^A) = \{0, \overline{15}, \underline{14}, 3, 3, 3, 3, 3, 3\}. \quad (\text{A.92})$$

The maximal \mathbb{Z}_N subgroups

$$\begin{aligned} & \{0, 8, 4, 8\} , \\ & \{0, 6, 4, 6\} , \\ & \{0, 10, 4, 10\} , \\ & \{0, 3, 3\} \end{aligned} \quad (\text{A.93})$$

form the Dynkin diagram of $D_4 \times A_2$:

$$\begin{array}{ccccccc} & & & \circ & 10 & & \\ & & & | & & & \\ \circ & - & \circ & - & \circ & - & \circ \\ 8 & & 4 & & 6 & & 3 & 3 \end{array} \quad (\text{A.94})$$

The number of conjugacy classes in $\Gamma_{1,f}$ matches the flavor rank $f = 5$. Note that the A_2 singularity only has contribution $f = 1$.

The singular equation is

$$(-w^3 + 3wy + 432x^2)^2 - 4(3y^2z - 3yz^2 + z^3) = 0. \quad (\text{A.95})$$

There are an A_2 singularity along the locus

$$\{x = y - w^2 = z - w^2 = 0\} \subset \mathbb{C}^4 \quad (\text{A.96})$$

and a D_4 singularity along the locus

$$\{432x^2 - w^3 = y = z = 0\} \subset \mathbb{C}^4. \quad (\text{A.97})$$

Due to monodromy, the A_2 factor is reduced to flavor rank 1.

A.5 H_{168}

There are in total 6 conjugacy classes. The representatives of each non-trivial conjugacy classes are

$$M_1 = \begin{pmatrix} 0 & 0 & 1 \\ 1 & 0 & 0 \\ 0 & 1 & 0 \end{pmatrix},$$

$$M_2 = \frac{1}{7} \begin{pmatrix} -w^5 - w^4 + 2w^2 - 2w + 2 & -3w^5 - 2w^4 - 4w^3 - 2w^2 - w & 3w^5 + w^4 + w^3 + 2w^2 - 1 \\ -w^5 + 2w^4 + 2w^3 - w^2 - 2 & 2w^4 - w^3 - 2w^2 - w + 2 & 4w^5 + 2w^4 + w^3 + w^2 + 2w + 4 \\ -w^5 + 3w^3 + w^2 + w + 3 & -2w^5 - 3w^4 - 3w^3 - 2w^2 - 4 & w^5 - w^4 + w^3 + 3w + 3 \end{pmatrix},$$

$$M_3 = \frac{1}{7} \begin{pmatrix} -2w^5 - 2w^4 - 3w^2 - 4w - 3 & -w^5 - w^4 + 2w^2 - 2w + 2 & 3w^5 + 3w^4 + w^2 - w + 1 \\ w^4 + w^3 - w^2 + 3w + 1 & -3w^4 - 2w^3 - 4w^2 - 2w - 3 & 2w^4 - w^3 - 2w^2 - w + 2 \\ w^5 - w^4 + w^3 + 3w + 3 & -3w^5 - 4w^4 - 3w^3 - 2w - 2 & 2w^5 - 2w^4 + 2w^3 - w - 1 \end{pmatrix},$$

$$M_4 = \begin{pmatrix} w^4 & 0 & 0 \\ 0 & w & 0 \\ 0 & 0 & w^2 \end{pmatrix},$$

$$M_5 = \frac{1}{7} \begin{pmatrix} 3w^5 + w^4 + w^3 + 3w^2 - 1 & -w^5 - w^4 + 2w^2 - 2w + 2 & -3w^5 - 2w^4 - 4w^3 - 2w^2 - 3w \\ 4w^5 + 2w^4 + 1w^3 + 1w^2 + 2w + 4 & -w^5 + 2w^4 + 2w^3 - w^2 - 2 & 2w^4 - 1w^3 - 2w^2 - w + 2 \\ w^5 - w^4 + w^3 + 3w + 3 & -w^5 + 3w^3 + w^2 + w + 3 & -2w^5 - 3w^4 - 3w^3 - 2w^2 - 4 \end{pmatrix}$$

where $w = e^{2\pi i/7}$.

There are in total 65 abelian subgroups. There are 8 of them that are \mathbb{Z}_7 whose types are

$$r(G^A) = \{0, \bar{4}, \bar{4}, \underline{3}, \bar{4}, \underline{3}, \underline{3}\}, \quad (\text{A.98})$$

there are 28 of them that are \mathbb{Z}_3 whose types are

$$r(G^A) = \{0, 1, 1\}, \quad (\text{A.99})$$

there are 8 of them that are $\mathbb{Z}_2 \times \mathbb{Z}_2$ whose types are

$$r(G^A) = \{0, 5, 5, 5\}, \quad (\text{A.100})$$

and there are 21 of them that are \mathbb{Z}_4 whose types are

$$r(G^A) = \{0, 2, 5, 2\}, \quad (\text{A.101})$$

The maximal \mathbb{Z}_N subgroups

$$\begin{aligned} & \{0, 2, 5, 2\}, \\ & \{0, 1, 1\} \end{aligned} \quad (\text{A.102})$$

form the Dynkin diagram of $A_3 \times A_2$:

$$\begin{array}{ccccc} \circ & \text{---} & \circ & \text{---} & \circ & \text{---} & \circ & \text{---} & \circ \\ 2 & & 5 & & 2 & & 1 & & 1 \end{array} \quad (\text{A.103})$$

The number of conjugacy classes in $\Gamma_{1,f}$ matches the flavor rank $f = 3$. Note that the A_3 singularity only has contribution $f = 2$ and the A_2 singularity only has contribution $f = 1$.

The singular equation is

$$z^3 + 1728y^7 + 1008zy^4x - 88z^2yx^2 - 60032y^5x^3 + 1088zy^2x^4 + 22016y^3x^6 - 256zx^7 - 2048yx^9 - w^2 = 0. \quad (\text{A.104})$$

There are an A_3 singularity along the locus

$$\{w = y^2 + 4x^3 = z^2 + 20736x^7 = 0\} \subset \mathbb{C}^4 \quad (\text{A.105})$$

and an A_2 singularity along the locus

$$\{w = 27y^2 + 4x^3 = 243z^2 + 256x^7 = 0\} \subset \mathbb{C}^4. \quad (\text{A.106})$$

Due to monodromy reduction, the A_3 factor is reduced to flavor rank 2 and the A_2 factor is reduced to flavor rank 1.

A.6 H_{216}

There are in total 24 conjugacy classes. The representatives of each non-trivial conjugacy classes are

$$\begin{aligned} M_1 &= \begin{pmatrix} w^6 & 0 & 0 \\ 0 & w^6 & 0 \\ 0 & 0 & w^6 \end{pmatrix}, M_2 = \begin{pmatrix} w^3 & 0 & 0 \\ 0 & w^3 & 0 \\ 0 & 0 & w^3 \end{pmatrix}, M_3 = \begin{pmatrix} 1 & 0 & 0 \\ 0 & w^3 & 0 \\ 0 & 0 & w^6 \end{pmatrix}, \\ M_4 &= \begin{pmatrix} -1 & 0 & 0 \\ 0 & 0 & -1 \\ 0 & -1 & 0 \end{pmatrix}, M_5 = \begin{pmatrix} -w^6 & 0 & 0 \\ 0 & 0 & -w^6 \\ 0 & -w^6 & 0 \end{pmatrix}, M_6 = \begin{pmatrix} -w^3 & 0 & 0 \\ 0 & 0 & -w^3 \\ 0 & -w^3 & 0 \end{pmatrix}, \\ M_7 &= \frac{1}{3} \begin{pmatrix} -2w^3 - 1 & -2w^3 - 1 & -2w^3 - 1 \\ -2w^3 - 1 & w^3 + 2 & w^3 - 1 \\ -2w^3 - 1 & w^3 - 1 & w^3 + 2 \end{pmatrix}, M_8 = \frac{1}{3} \begin{pmatrix} w^3 - 1 & w^3 - 1 & w^3 - 1 \\ w^3 - 1 & -2w^3 - 1 & w^3 + 2 \\ w^3 - 1 & w^3 + 2 & -2w^3 - 1 \end{pmatrix}, \\ M_9 &= \frac{1}{3} \begin{pmatrix} w^3 + 2 & w^3 + 2 & w^3 + 2 \\ w^3 + 2 & w^3 - 1 & -2w^3 - 1 \\ w^3 + 2 & -2w^3 - 1 & w^3 - 1 \end{pmatrix}, M_{10} = \begin{pmatrix} w^2 & 0 & 0 \\ 0 & w^2 & 0 \\ 0 & 0 & w^5 \end{pmatrix}, M_{11} = \begin{pmatrix} w^8 & 0 & 0 \\ 0 & w^8 & 0 \\ 0 & 0 & w^2 \end{pmatrix}, \\ M_{12} &= \begin{pmatrix} w^5 & 0 & 0 \\ 0 & w^5 & 0 \\ 0 & 0 & w^8 \end{pmatrix}, M_{13} = \begin{pmatrix} 0 & 0 & w^2 \\ w^2 & 0 & 0 \\ 0 & w^5 & 0 \end{pmatrix}, M_{14} = \begin{pmatrix} -w^2 & 0 & 0 \\ 0 & 0 & -w^2 \\ 0 & -w^5 & 0 \end{pmatrix}, \\ M_{15} &= \begin{pmatrix} -w^8 & 0 & 0 \\ 0 & 0 & -w^8 \\ 0 & -w^2 & 0 \end{pmatrix}, M_{16} = \begin{pmatrix} -w^5 & 0 & 0 \\ 0 & 0 & -w^5 \\ 0 & -w^8 & 0 \end{pmatrix}, M_{17} = \begin{pmatrix} w^4 & 0 & 0 \\ 0 & w^4 & 0 \\ 0 & 0 & w^1 \end{pmatrix}, \\ M_{18} &= \begin{pmatrix} w & 0 & 0 \\ 0 & w & 0 \\ 0 & 0 & w^7 \end{pmatrix}, M_{19} = \begin{pmatrix} w^7 & 0 & 0 \\ 0 & w^7 & 0 \\ 0 & 0 & w^4 \end{pmatrix}, M_{20} = \begin{pmatrix} 0 & 0 & w^4 \\ w^4 & 0 & 0 \\ 0 & w & 0 \end{pmatrix}, \\ M_{21} &= \begin{pmatrix} -w^4 & 0 & 0 \\ 0 & 0 & -w^4 \\ 0 & -w & 0 \end{pmatrix}, M_{22} = \begin{pmatrix} -w & 0 & 0 \\ 0 & 0 & -w \\ 0 & -w^7 & 0 \end{pmatrix}, M_{23} = \begin{pmatrix} -w^7 & 0 & 0 \\ 0 & 0 & -w^7 \\ 0 & -w^4 & 0 \end{pmatrix}. \end{aligned}$$

where $w = e^{2\pi i/9}$.

There are in total 91 abelian subgroups. There are 4 of them that are $\mathbb{Z}_9 \times \mathbb{Z}_3$ whose types are

$$\begin{aligned} r(G_A) = \{ & 0, \overline{10}, \overline{17}, \underline{1}, \underline{11}, \overline{18}, \overline{2}, \underline{12}, \underline{19}, , \\ & 3, \underline{11}, \overline{17}, 3, \underline{12}, \overline{18}, 3, \overline{10}, \underline{19}, \\ & 3, \overline{10}, \underline{19}, 3, \underline{11}, \overline{18}, 3, \underline{12}, \overline{18} \}, \end{aligned} \quad (\text{A.107})$$

there are 36 of them that are $\mathbb{Z}_9 \times \mathbb{Z}_2$ whose types are

$$\begin{aligned} r(G^A) = \{ & 0, \overline{17}, \underline{11}, \overline{2}, \underline{19}, \overline{10}, \underline{1}, \overline{18}, \underline{12}, \\ & 4, \underline{22}, \underline{14}, \underline{6}, \underline{21}, \overline{16}, \overline{5}, \overline{23}, \overline{15} \}, \end{aligned} \quad (\text{A.108})$$

there are 27 of them that are $\mathbb{Z}_4 \times \mathbb{Z}_3$ whose types are

$$\begin{aligned} r(G^A) = \{ & 0, 7, 4, 7, \\ & \overline{2}, \overline{9}, \underline{6}, \overline{9}, \\ & \underline{1}, \underline{8}, \overline{5}, \underline{8}, \end{aligned} \quad (\text{A.109})$$

and there are 24 of them that are $\mathbb{Z}_3 \times \mathbb{Z}_3$ whose types are

$$\begin{aligned} r(G^A) = \{ & 0, \underline{1}, \overline{2}, \\ & 13, 13, 13, \\ & 20, 20, 20 \}. \end{aligned} \quad (\text{A.110})$$

The maximal \mathbb{Z}_N subgroups

$$\begin{aligned} & \{0, 3, 3\} , \\ & \{0, 7, 4, 7\} , \\ & \{0, 13, 20\} \end{aligned} \quad (\text{A.111})$$

form the Dynkin diagram of $A_3 \times A_2 \times A_2$:

$$\begin{array}{ccccccc} \circ & \text{---} & \circ & & \circ & \text{---} & \circ & \text{---} & \circ & & \circ & \text{---} & \circ \\ 3 & & 3 & & 7 & & 4 & & 7 & & 13 & & 20 \end{array} \quad (\text{A.112})$$

The number of conjugacy classes in $\Gamma_{1,f}$ matches the flavor rank $f = 5$. Note that the A_3 singularity only has contribution $f = 2$ and one of the A_2 singularity only has contribution $f = 1$.

The singular equation is

$$y^3 - \frac{1}{4}z \left((432w^2 - z - 3y)^2 - 6912x^3 \right) = 0. \quad (\text{A.113})$$

There are an A_2 singularity along the locus

$$\{w = x = y - z = 0\} \subset \mathbb{C}^4 \quad (\text{A.114})$$

and a second A_2 singularity along the locus

$$\{x^3 - 27w^4 = y = z = 0\} \subset \mathbb{C}^4. \quad (\text{A.115})$$

There is another D_4 singularity along the locus

$$\{x = y = z - 432w^2 = 0\} \subset \mathbb{C}^4. \quad (\text{A.116})$$

Therefore the total codimension 2 ADE singularity is $D_4 \times A_2^2$. Due to monodromy reduction, the D_4 is reduced to flavor rank 3 and the two A_2 s are reduced to flavor rank 1.

A.7 H_{360}

There are in total 17 conjugacy classes. The representatives of each non-trivial conjugacy classes are

$$\begin{aligned} M_1 &= \begin{pmatrix} -w^5 - 1 & 0 & 0 \\ 0 & -w^5 - 1 & 0 \\ 0 & 0 & -w^5 - 1 \end{pmatrix}, \\ M_2 &= \begin{pmatrix} w^5 & 0 & 0 \\ 0 & w^5 & 0 \\ 0 & 0 & w^5 \end{pmatrix}, \\ M_3 &= \begin{pmatrix} -1 & 0 & 0 \\ 0 & w^7 + w^2 & -w^3 \\ 0 & 0 & 0 \end{pmatrix}, \\ M_4 &= \begin{pmatrix} w^5 + 1 & 0 & 0 \\ 0 & w^7 - w^5 + w^4 + w - 1 & 0 \\ 0 & 0 & 0 \end{pmatrix}, \\ M_5 &= \begin{pmatrix} -w^5 & 0 & 0 \\ 0 & -w^2 & -w^7 + w^5 - w^4 + w^3 - w + 1 \\ 0 & 0 & 0 \end{pmatrix}, \\ M_6 &= \frac{1}{5} \begin{pmatrix} -2w^7 + 2w^3 - 2w^2 + 1 & 2w^6 + w^3 + 2 & w^7 - 2w^6 - 2w^3 + w^2 \\ -4w^7 + 4w^3 - 4w^2 + 2 & -w^6 - 3w^3 - 1 & -3w^7 + w^6 + w^3 - 3w^2 \\ -4w^7 + 4w^3 - 4w^2 + 2 & -w^6 + 2w^3 - 1 & 2w^7 + w^6 + w^3 + 2w^2 \end{pmatrix}, \\ M_7 &= \frac{1}{5} \begin{pmatrix} -w^5 + 2w^4 + 2w - 1 & \frac{3}{2}w^7 - \frac{1}{2}w^5 + \frac{1}{2}w^4 + \frac{5}{2}w^2 - \frac{1}{2} & w^7 - \frac{3}{2}w^5 + w^4 - \frac{5}{2}w^3 + \frac{3}{2}w - \frac{3}{2} \\ 6w^7 - 5w^6 + 3w^4 - 5w^3 + 5w^2 + w - 5 & -w^7 + w^5 - 3w + 1 & 3w^7 - w^5 + w^4 - 1 \\ -w^7 + 5w^6 + w^5 + 2w + 1 & -3w^7 + 2w^5 - 3w^4 - 2w + 2 & w^7 - 2w^4 + w \end{pmatrix}, \\ M_8 &= \frac{1}{5} \begin{pmatrix} -2w^5 - w^4 - w - 2 & -\frac{5}{2}w^7 + w^6 + w^5 + 2w^3 - \frac{3}{2}w^2 - \frac{1}{2}w + \frac{3}{2} & -w^6 + \frac{1}{2}w^4 + \frac{1}{2}w^3 - w^2 + w - \frac{1}{2} \\ -6w^7 + 2w^6 + 5w^5 - 4w^4 + 4w^3 - 3w^2 - w + 1 & -w^7 - w^6 + w^5 - 2w^4 + 3w^3 - w^2 - 2w + 3 & w^7 - \frac{3}{2}w^5 + 2w^4 - 2 & -4w^7 + w^6 + w^5 - 2w^4 + 2w^3 - 4w^2 - 2w + 4 \\ -6w^7 + 2w^6 + 5w^5 - 4w^4 + 4w^3 - 3w^2 - w + 1 & -w^7 - w^6 + w^5 - 2w^4 + 3w^3 - w^2 - 2w + 3 & w^7 - \frac{3}{2}w^5 + 2w^4 - 2 & -4w^7 + w^6 + w^5 - 2w^4 + 2w^3 - 4w^2 - 2w + 4 \end{pmatrix}, \\ M_9 &= \frac{1}{5} \begin{pmatrix} w^7 + 2w^5 + w^4 - w^3 + w^2 + w - 1 & -\frac{1}{2}w^7 + \frac{1}{2}w^6 + \frac{1}{2}w^5 - 2w^4 - w^2 - \frac{1}{2}w + \frac{3}{2} & -\frac{1}{2}w^6 + w^5 - w^4 + \frac{1}{2}w^3 + \frac{1}{2}w^2 - \frac{5}{2}w + \frac{3}{2} \\ 3w^7 - w^6 - 2w^5 - 4w^3 + w^2 + w - 1 & -2w^7 + 2w^6 + 2w^5 - 2w^4 + 2w^3 - w^2 + 2 & -w^4 - 2w^3 + 2w^2 - 2w - 1 & 4w^7 - 2w^5 - 2w^3 + 2w^2 + w - 3 \\ 3w^7 - w^6 - 2w^5 - 4w^3 + w^2 + w - 1 & -2w^7 + 2w^6 + 2w^5 - 2w^4 + 2w^3 - w^2 + 2 & -w^4 - 2w^3 + 2w^2 - 2w - 1 & w^7 - 2w^6 + w^5 + w^4 - w^3 - w - 1 \end{pmatrix}, \\ M_{10} &= \frac{1}{5} \begin{pmatrix} -w^7 + w^3 - w^2 + 3 & 3w^7 - \frac{3}{2}w^6 - \frac{3}{2}w^5 + 2w^4 - 2w^3 + \frac{5}{2}w^2 + w - 3 & \frac{3}{2}w^6 - w^5 + \frac{1}{2}w^4 - w^3 + \frac{1}{2}w^2 + \frac{3}{2}w - 1 \\ -2w^7 + 3w^6 - 2w^5 + w^4 - w^3 - w^2 + 3w - 3 & w^7 + w^6 - w^5 + 3w^4 - w^3 - w^2 + 4w - 2 & w^7 - 2w^6 - 2w^3 + w^2 & -w^6 + w^5 + 2w^4 + 2w^2 + \frac{w}{2} + 1 \\ -2w^7 + 3w^6 - 2w^5 + w^4 - w^3 - w^2 + 3w - 3 & w^7 + w^6 - w^5 + 3w^4 - w^3 - w^2 + 4w - 2 & w^7 - 2w^6 - 2w^3 + w^2 & -w^6 + w^5 + 2w^4 + 2w^2 + \frac{w}{2} + 1 \end{pmatrix}, \\ M_{11} &= \frac{1}{5} \begin{pmatrix} w^5 - 2w^4 - 2w + 1 & -2w^7 + 2w^5 - w + 2 & 2w^7 + w^4 + 2w \\ -2w^7 - 2w^5 - 2w^4 + 2w - 2 & -w^7 - 3w^4 - w & 2w^7 + w^5 - w^4 + 1 \\ 2w^7 - 4w^5 + 4w^4 - 4 & -2w^7 + 3w^5 - 2w^4 - 3w + 3 & w^7 - w^5 - 2w - 1 \end{pmatrix}, \\ M_{12} &= \frac{1}{5} \begin{pmatrix} 2w^7 - w^5 + 2w^4 - 2w^3 + 2w^2 + 2w - 2 & w^6 - 2w^5 - 2w^2 + w & -w^7 - w^6 - w^4 + w^3 + w^2 - 2w + 1 \\ 2w^7 - 4w^6 + 2w^5 + 2w^4 - 2w^3 - 2w^2 + 4 & 3w^7 - 2w^6 + 3w^4 - 3w^3 + 2w^2 + w - 3 & w^7 - w^6 - w^5 + w^4 - w^3 + 3w^2 - 1 \\ -4w^7 + 4w^6 + 4w^5 - 4w^4 + 4w^3 - 2w^2 + 4 & 2w^7 + w^6 - 3w^5 + 2w^4 - 2w^3 + 3w - 2 & 2w^6 + w^5 + w^2 + 2w \end{pmatrix}, \\ M_{13} &= \frac{1}{5} \begin{pmatrix} -2w^7 + 2w^3 - 2w^2 + 1 & 2w^7 - w^6 + 2w^2 - 2 & -w^7 + w^6 - w^3 - w^2 - 1 \\ 4w^6 + 2w^3 + 4 & -2w^7 + 2w^6 + 3w^3 - 2w^2 + 3 & -3w^7 + w^6 + w^3 - 3w^2 \\ 2w^7 - 4w^6 - 4w^3 + 4 & -w^6 + 2w^3 - 1 & -w^7 - 2w^5 - w^2 + 1 \end{pmatrix}, \\ M_{14} &= \frac{1}{5} \begin{pmatrix} -w^7 + w^3 - w^2 - 2 & -w^7 + w^6 + \frac{1}{2}w^5 + w^4 + \frac{1}{2}w^3 + \frac{1}{2}w + \frac{3}{2} & \frac{3}{2}w^7 - w^6 - \frac{1}{2}w^5 + \frac{3}{2}w^4 - w^3 + \frac{1}{2}w^2 + 2w - \frac{1}{2} \\ 4w^7 - 2w^6 + w^6 + w^5 + 3w^4 - 5w^3 + 2w^2 + 4w - 3 & 2w^7 - 2w^6 - 3w^5 + 4w^4 - 2w^3 + w^2 + 2w - 3 & -w^7 + w^6 - w^3 - w^2 - 1 & 2w^7 - w^6 + 2w^5 - 2 & -w^7 + 2w^6 - 2w^5 + w^4 + w^3 + 3w \end{pmatrix}, \\ M_{15} &= \frac{1}{5} \begin{pmatrix} 3w^5 - w^4 - w + 3 & -\frac{3}{2}w^7 + \frac{1}{2}w^6 - w^5 - \frac{3}{2}w^4 + w^3 - 2w^2 + \frac{1}{2} & -w^7 - \frac{1}{2}w^6 - \frac{1}{2}w^5 - \frac{1}{2}w^4 + \frac{3}{2}w^3 - \frac{1}{2}w^2 - 2w + \frac{1}{2} \\ -5w^7 + w^6 - w^5 - w^4 + 2w^3 - 4w^2 + w + 2 & -3w^7 + 2w^6 + w^5 - 2w^4 + 4w^3 - 3w^2 - 2w + 2 & 2w^7 + w^4 + 2w & -2w^7 - 2w^6 + w^5 - 2w^4 + w^3 - 2w^2 - 2w \\ -w^6 - 2w^5 + 2w^4 + 3w^3 - w^2 & -3w^7 + 2w^6 + w^5 - 2w^4 + 4w^3 - 3w^2 - 2w + 2 & -2w^7 + w^4 + 2w & -2w^7 - 2w^6 + w^5 - 2w^4 + w^3 - 2w^2 - 2w \end{pmatrix}, \\ M_{16} &= \frac{1}{5} \begin{pmatrix} w^7 - 3w^5 + w^4 - w^3 + w^2 + w - 1 & \frac{5}{2}w^7 - \frac{3}{2}w^6 + \frac{1}{2}w^5 + \frac{1}{2}w^4 - \frac{3}{2}w^3 + 2w^2 - \frac{1}{2}w - 2 & -\frac{1}{2}w^7 + \frac{3}{2}w^6 + w^5 - w^4 - \frac{1}{2}w^3 \\ 3w^7 - 2w^6 - w^4 - w^3 - 2w - 2 & w^7 + 2w^5 - 2w^4 - 2w^3 + 2w^2 + 1 & w^6 - 2w^5 - 2w^2 + w \\ -4w^7 + 2w^6 + 3w^5 - 5w^4 + 2w^3 - w^2 - 4w + 3 & -w^7 - w^6 - w^4 + w^3 + w^2 - 2w + 1 & 3w^7 + w^5 + w^4 - 2w^3 + 2w^2 - w \end{pmatrix} \end{aligned}$$

where $w = e^{2\pi i/15}$.

There are in total 143 abelian subgroups. There are 36 of them that are $\mathbb{Z}_5 \times \mathbb{Z}_3$ whose types are

$$\begin{aligned} r(G^A) &= \{0, 16, 13, 13, 16, \\ &\quad \underline{1}, \underline{14}, \underline{11}, \underline{11}, \underline{14}, \\ &\quad \underline{2}, \underline{15}, \underline{12}, \underline{12}, \underline{15}\}, \end{aligned} \quad (\text{A.117})$$

there are of 38 them that are $\mathbb{Z}_6 \times \mathbb{Z}_2$ whose types are

$$r(G^A) = \{0, \bar{4}, \bar{2}, 3, \underline{1}, \underline{5}, \\ 3, \bar{4}, \underline{5}, 3, \bar{4}, \underline{5}\}, \quad (\text{A.118})$$

there are 29 of them that are $\mathbb{Z}_4 \times \mathbb{Z}_3$ whose types are

$$r(G^A) = \{0, 10, 3, 10, \\ \bar{2}, \bar{9}, \underline{5}, \bar{9}, \\ \underline{1}, \underline{8}, \bar{4}, \underline{8}\}, \quad (\text{A.119})$$

there are of 20 them that are $\mathbb{Z}_3 \times \mathbb{Z}_3$ whose types are

$$r(G^A) = \{0, \underline{1}, \bar{2}, \\ 6, 6, 6, \\ 6, 6, 6\}. \quad (\text{A.120})$$

and there are 20 of them that are $\mathbb{Z}_3 \times \mathbb{Z}_3$ whose types are

$$r(G^A) = \{0, \underline{1}, \bar{2}, \\ 7, 7, 7, \\ 7, 7, 7\}. \quad (\text{A.121})$$

The maximal \mathbb{Z}_N subgroups

$$\begin{aligned} &\{0, 16, 13, 13, 16\} , \\ &\{0, 10, 3, 10\} , \\ &\{0, 6, 6\} , \\ &\{0, 7, 7\} \end{aligned} \quad (\text{A.122})$$

form the Dynkin diagram of $A_4 \times A_3 \times A_2 \times A_2$:

$$\begin{array}{cccc} \circ & \circ & \circ & \circ \\ \text{---} & \text{---} & \text{---} & \text{---} \\ 16 & 13 & 13 & 16 \end{array} \quad \begin{array}{ccc} \circ & \circ & \circ \\ \text{---} & \text{---} & \text{---} \\ 10 & 3 & 10 \end{array} \quad \begin{array}{cc} \circ & \circ \\ \text{---} & \text{---} \\ 6 & 6 \end{array} \quad \begin{array}{cc} \circ & \circ \\ \text{---} & \text{---} \\ 7 & 7 \end{array} \quad (\text{A.123})$$

The number of conjugacy classes in $\Gamma_{1,f}$ matches the flavor rank $f = 6$. Note that the A_4 singularity and A_3 singularity only has contribution $f = 2$, each of the two A_2 singularities only has contribution $f = 1$.

B More examples

B.1 $E^{(6)}$

B.1.1 6d interpretation

The equation is a complete intersection in \mathbb{C}^5 :

$$\begin{cases} y^2 = x^3 - 108z^2 \\ u^2 - vz = 0, \end{cases} \quad (\text{B.1})$$

which takes the form of a Weierstrass model over a base B_2 with A_1 singularity at $u = v = z = 0$. We can replace

$$u = st, \quad z = s^2, \quad v = t^2. \quad (\text{B.2})$$

After the resolving the base $(u, v, z; \delta_1)$, we get the Weierstrass model on the tensor branch

$$y^2 = x^3 - 108s^4\delta_1^2. \quad (\text{B.3})$$

Since there is a (f, g) vanishes to order $(4, 6)$ at $s = \delta_1 = 0$, we need to further blow up $(s, \delta_1; \delta_2)$ on the base

The final tensor branch is then

$$\frac{\text{su}(3)}{3} - 1 - [E_6]. \quad (\text{B.4})$$

B.1.2 5d interpretation

We start with the complete intersection

$$\begin{cases} y^3 - z^2 = 108x^2 \\ u^2 - vx = 0 \end{cases} \quad (\text{B.5})$$

We first do the blow up sequence

$$(u, v, x; \delta_1) \quad (\text{B.6})$$

and get

$$\begin{cases} y^3 - z^2 = 108x^2\delta_1^2 \\ u^2 - vx = 0 \end{cases} \quad (\text{B.7})$$

We then work in the patch of $v = 1$, and substitute $x = u^2$ into the first equation:

$$y^3 - z^2 = 108u^4\delta_1^2 \quad (\text{B.8})$$

We further blow up

$$\begin{aligned} &(y^{(2)}, z^{(3)}, u^{(1)}, \delta_1^{(1)}; \delta_2) \\ &(y, z, \delta_1; \delta_3) \end{aligned} \quad (\text{B.9})$$

and the E_6 singularity at $u = y = z = 0$:

$$(u, y, z; u_1), (u_1, y, z; u_2), (z, u_1; u_3), (u_2, u_3; u_4), (u_3, u_4; u_5), (u_1, u_3; u_6). \quad (\text{B.10})$$

The resolved equation is

$$y^3\delta_3u_1u_2^2u_4 - z^2u_3 = 108u^4\delta_1^2u_1^2u_3u_6^2. \quad (\text{B.11})$$

The compact divisor $\delta_3 = 0$ has two components:

$$\begin{aligned} S_1 : \quad &\delta_3 = z + 6\sqrt{3}iu^2\delta_1u_1u_6 = 0 \\ S_3 : \quad &\delta_3 = z - 6\sqrt{3}iu^2\delta_1u_1u_6 = 0. \end{aligned} \quad (\text{B.12})$$

Along with $S_2 : \delta_2 = 0$, the rank of the 5d SCFT is $r = 3$. The 5d geometry can also be thought as the decoupling of vertical divisor over the (-3) -curve, from the 6d geometry (B.3).

We use a notation similar to [19] to show the triple intersection numbers in a picture:

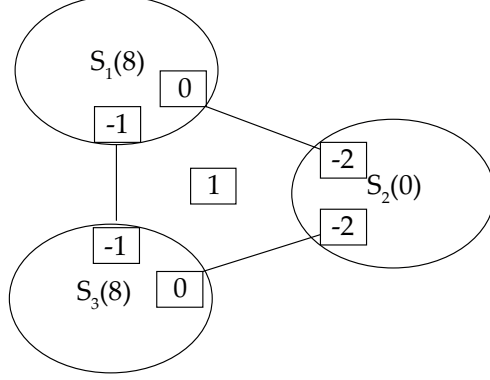

(B.13)

The number n in the bracket $S_i(n)$ denotes the self-triple intersection number S_i^3 , and the number in a square box inside S_i is equal to $S_i S_j^2$ for the corresponding intersection curve $S_i \cdot S_j$. The number among three divisors S_i , S_j and S_k is the triple intersection number $S_i \cdot S_j \cdot S_k$.

The theory has an IR description of $SU(3)_0 - SU(2) - 5F$ and UV flavor symmetry

$$G_F = E_6 \times SU(2) \times U(1). \quad (\text{B.14})$$

The 5d geometry can be obtained by the decoupling of the vertical divisor over the (-3) -curve in the 6d theory (B.4).

B.2 $E^{(7)}$

We present the detail of the 6d SCFT T_X^{6d} associated to $\mathbb{C}^3/E^{(7)}$, which is non-very-Higgsable.

After shifting and rescaling variables, the equation is a complete intersection in \mathbb{C}^5 :

$$\begin{cases} zv - u^3 = 0 \\ y^2 = x^3 - \frac{1}{3 \times 4^{1/3}} zx, \end{cases} \quad (\text{B.15})$$

which takes the form of a Weierstrass model over a base B_2 with A_2 singularity at $u = v = z = 0$. We can replace

$$u = st, \quad z = s^3, \quad v = t^3. \quad (\text{B.16})$$

After resolving A_2 base singularity, we get the Weierstrass model on the tensor branch

$$y^2 = x^3 - \frac{1}{3 \times 4^{1/3}} s^3 \delta_1^2 \delta_2 x. \quad (\text{B.17})$$

We need to do the further base blow-ups to remove cod-2 (4, 6) singularities:

$$(s, \delta_1; \delta_3), \quad (s, \delta_3; \delta_4). \quad (\text{B.18})$$

The final Weierstrass model is

$$y^2 = x^3 - \frac{1}{3 \times 4^{1/3}} s^3 \delta_1^2 \delta_2 \delta_3 x. \quad (\text{B.19})$$

The final tensor branch is

$$\frac{\mathfrak{su}(2)}{2} - \frac{\mathfrak{so}(7)}{3} - \frac{\mathfrak{su}(2)}{2} - 1 - [E_7]. \quad (\text{B.20})$$

B.3 \mathbb{C}^3/H_{36}

In this case, T_X^{6d} is also non-very-Higgsable, and to get T_X^{5d} one needs to decouple three vector multiplets from the KK theory.

B.3.1 6d interpretation

In this case \mathbb{C}^3/H_{36} is described by the following complete intersection in \mathbb{C}^5

$$\begin{cases} 3u^2x + 2u^3 - 36uz - 36vx - x^3 + 432y^2 = 0, \\ u^2v - u^2z - 12v^2 + 9z^2 = 0. \end{cases} \quad (\text{B.21})$$

We do the coordinate transformation

$$\begin{aligned} y &\rightarrow \frac{1}{12\sqrt{3}}y \\ z &= -\frac{2}{\sqrt{3}}z_1 - \frac{1}{24\sqrt{3}}v_1 + \frac{2i}{3}u_1^2 \\ v &= z_1 - \frac{1}{48}v_1 + \frac{i}{2}u_1^2 \\ u &= -2\sqrt{3}e^{\pi i/4}u_1, \end{aligned} \quad (\text{B.22})$$

and rewrite the equations as

$$\begin{cases} y^2 = x^3 + (36z_1 - 18iu_1^2 - \frac{3}{4}v_1)x + 3e^{\pi i/4}u_1(v_1 + 48z_1), \\ z_1v_1 = u_1^4. \end{cases} \quad (\text{B.23})$$

The first equation is a Weierstrass model over a base B_2 with A_3 singularity at $z_1 = v_1 = u_1 = 0$. One can also introduce new base coordinates (s, t) :

$$z_1 = s^4, \quad v_1 = t^4, \quad u_1 = st. \quad (\text{B.24})$$

The base has an A_3 singularity at $s = t = 0$, and it has the following toric resolution $\phi: \tilde{B}_2 \rightarrow B_2$. The resolved base \tilde{B}_2 is

$$(\text{B.25})$$

The exceptional base divisors are $\delta_k = 0$ ($k = 1, 2, 3$), which one-to-one corresponds to lattice points $(1 - k, -k)$ in the N lattice. For the line bundle $\mathcal{O}(-nK_{\tilde{B}_2})$, the monomial generator associated to the point (p, q) in the dual lattice M of N is (for example see [104])

$$m_{(p,q)} = s^{p+n} t^{-3p-4q+n} \delta_1^{-q+n} \delta_2^{-p-2q+n} \delta_3^{-2p-3q+n}. \quad (\text{B.26})$$

Thus the Weierstrass model after resolution is

$$y^2 = x^3 + \left(36s^4 \delta_1^2 - 18is^2 t^2 \delta_1 \delta_3 - \frac{3}{4} t^4 \delta_3^2 \right) \delta_1 \delta_2^2 \delta_3 x + 3e^{\pi i/4} st (48s^4 \delta_1 + t^4 \delta_3) \delta_1^2 \delta_2^3 \delta_3^2. \quad (\text{B.27})$$

$$\Delta = \frac{27}{16} \delta_1^3 \delta_2^6 \delta_3^3 \left((-24i \delta_1 \delta_3 s^2 t^2 - \delta_3^2 t^4 + 48 \delta_1^2 s^4)^3 + 144i \delta_1 \delta_3 s^2 t^2 (\delta_3^2 t^4 + 48 \delta_1^2 s^4)^2 \right). \quad (\text{B.28})$$

The tensor branch is

$$\begin{array}{c} [2\mathbf{F}] \\ | \\ \text{su}(2) \quad \mathfrak{g}_2 \quad \text{su}(2) \\ 2 \quad - \quad 2 \quad - \quad 2 \end{array}. \quad (\text{B.29})$$

Note that the central G_2 gauge theory on a (-2) -curve should be $G_2 + 4\mathbf{F}$ due to anomaly cancellation, and the extra matter $2\mathbf{F}$ locates on the I_1 loci.

B.3.2 5d interpretation

We start with the singular equation in (B.23)

$$\begin{cases} y^2 = x^3 + (36z_1 - 18iu_1^2 - \frac{3}{4}v_1) x + 3e^{\pi i/4} u_1 (v_1 + 48z_1), \\ z_1 v_1 = u_1^4. \end{cases} \quad (\text{B.30})$$

We do the following resolution sequence

$$\begin{aligned} & (z_1, u_1, v_1; \delta_1), (z_1, v_1, \delta_1; \delta_2), (x, y, \delta_1; \delta_3), (x, y, \delta_2; \delta_4) \\ & (y, \delta_4; \delta_5), (\delta_4, \delta_5; \delta_6). \end{aligned} \quad (\text{B.31})$$

The resulting equation is

$$\begin{cases} y^2 \delta_5 = x^3 \delta_3 \delta_4 + (36z_1 - 18iu_1^2 \delta_1 \delta_3 - \frac{3}{4}v_1) \delta_1 \delta_2^2 \delta_4 x + 3e^{\pi i/4} u_1 (v_1 + 48z_1) \delta_1^2 \delta_2^3 \delta_4, \\ z_1 v_1 = u_1^4 \delta_1^2 \delta_3. \end{cases} \quad (\text{B.32})$$

The compact divisors are

$$\begin{aligned} S_1 : \quad & \delta_3 = z_1 = 0 \\ S_2 : \quad & \delta_3 = v_1 = 0 \\ S_3 : \quad & \delta_5 = 0 \\ S_4 : \quad & \delta_6 = 0. \end{aligned} \quad (\text{B.33})$$

The triple intersection numbers are

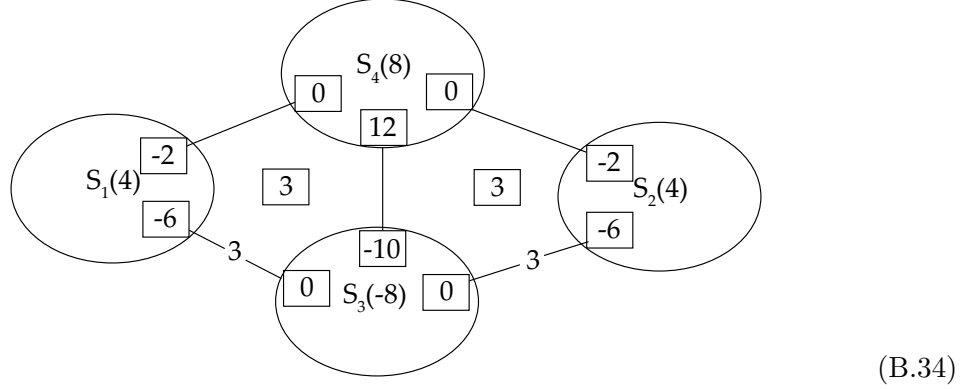

The rank-4 SCFT has an IR gauge theory description of

$$\begin{array}{c} 2\mathbf{F} \\ | \\ SU(2)_0 - G_2 - SU(2)_0 \end{array} \quad (\text{B.35})$$

The UV flavor symmetry should be enhanced to

$$G_F = SU(4) \times Sp(2), \quad (\text{B.36})$$

where $SU(4)$ comes from the A_3 singularity, and $Sp(2)$ comes from the classical flavor symmetry of $G_2 + 2\mathbf{F}$. The 5d theory is generated by taking the KK reduction of T_X^{6d} in (B.29), and decoupling the three vertical divisors over the (-2) -curves.

B.4 \mathbb{C}^3/H_{60}

In this case after rescaling and shifting the coordinates we obtain a Weierstrass model defined by

$$\begin{aligned} f &= \frac{1}{27}z(-237160w^2z^3 + 15435w^3 + 1214080wz^6 - 2070784z^9), \\ g &= \frac{1}{729}(-2327256960w^2z^9 + 423097360w^3z^6 - 38139885w^4z^3 \\ &\quad + 1361367w^5 + 6355937280wz^{12} - 6902276096z^{15}) \end{aligned} \quad (\text{B.37})$$

whose discriminant is

$$\Delta = \frac{49}{2187}(5z^3 - w)^2(32z^3 - 7w)^5(320z^3 - 63w)^3. \quad (\text{B.38})$$

The above Weierstrass model involves no codimension-two $(4, 6)$ points hence there is no tensor branch. The 6D physics is given by the F-theory compactification on a local elliptic CY3 on which there is a type I_2 fibration along $w - 5z^3 = 0$, a type $I_{5,ns}$ fibration along $7w - 32z^3 = 0$ and a type $I_{3,ns}$ fibration along $63w - 320z^3 = 0$ all of which meet at the point $w = z = 0$ where the degree of (f, g, Δ) enhances to $(4, 5, 10)$.

B.5 \mathbb{C}^3/H_{168}

B.5.1 6d interpretation

In this case the Weierstrass model is given by

$$\begin{aligned} f &= \frac{16}{3}z(-280w^2z^3 + 189w^4 - 48z^6), \\ g &= \frac{64}{27}w(1456w^2z^6 - 12852w^4z^3 + 729w^6 - 4032z^9) \end{aligned} \quad (\text{B.39})$$

whose discriminant is

$$\Delta = -4096(4z^3 - 27w^2)^3(w^2 + 4z^3)^4. \quad (\text{B.40})$$

At $w = z = 0$ the order of (f, g, Δ) is greater than $(4, 6, 12)$ therefore a base blow-up at $w = z = 0$ can be performed to obtain a minimal elliptic fibration given by

$$\begin{aligned} f &= -\frac{16}{3}\delta z(280\delta w^2z^3 - 189w^4 + 48\delta^2z^6), \\ g &= \frac{64}{27}\delta w(1456\delta^2w^2z^6 - 12852\delta w^4z^3 + 729w^6 - 4032\delta^3z^9) \end{aligned} \quad (\text{B.41})$$

whose discriminant is

$$\Delta = 4096\delta^2(27w^2 - 4\delta z^3)^3(w^2 + 4\delta z^3)^4 \quad (\text{B.42})$$

where w and z cannot vanish simultaneously. The base blow-up is shown schematically in figure 3.

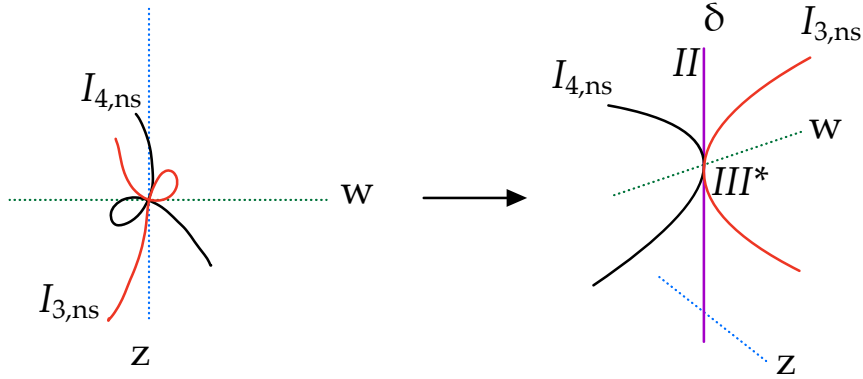

Figure 3: Before the base blow-up there are two self-intersecting divisors intersect at $w = z = 0$. After the base blow-up at $w = z = 0$ the $w = 0$ line and the $z = 0$ line are separated by the compact curve $\delta = 0$ on the base over which there is a type II elliptic fibration except at the point $\delta = w = 0$.

Clearly at $\delta = z = 0$ nothing interesting happens but at $\delta = w = 0$ we see that all the three irreducible components of the discriminant locus given by (B.42) intersect and

the order of (f, g, Δ) on $\delta = 0$ enhances from $(1, 1, 2)$ to $(3, 5, 9)$. At this point we can let $z = 1$ hence we will study the Weierstrass model $y^2 = x^3 + fx + g$ where

$$\begin{aligned} f &= -\frac{16}{3}\delta (48\delta^2 + 280\delta w^2 - 189w^4), \\ g &= \frac{64}{27}\delta w (-4032\delta^3 + 1456\delta^2 w^2 - 12852\delta w^4 + 729w^6). \end{aligned} \quad (\text{B.43})$$

The discriminant of this Weierstrass model is

$$\Delta = 4096\delta^2 (27w^2 - 4\delta)^3 (w^2 + 4\delta)^4 \quad (\text{B.44})$$

from which one can see that there is a type $I_{4,ns}$ fibration over $w^2 + 4\delta = 0$, a type $I_{3,ns}$ fibration over $27w^2 - 4\delta = 0$ and a type II fibration over $\delta = 0$.

Now we try to resolve the singular equation $y^2 - x^3 - fx - g$ with (B.43). In this case we keep track of the new coordinates after the i -th blow up using subscripts b_i . We first perform a shift

$$x = x_{s_1} - \frac{32}{3}w^3, \quad \delta = \delta_{s_1} - \frac{1}{4}w^2 \quad (\text{B.45})$$

to put one of the codimension-two singularity along $x_{s_1} = y = \delta_{s_1} = 0$. We then apply the first blow-up

$$(x_{s_1}, y, \delta_{s_1}; e_1) \quad (\text{B.46})$$

whose proper transformation is

$$\begin{aligned} 0 &= 258048\delta_{s_1 b_1}^4 e_1^2 w + 6912\delta_{s_1 b_1}^3 e_1^2 x_{s_1 b_1} - 424960\delta_{s_1 b_1}^3 e_1 w^3 + 35136\delta_{s_1 b_1}^2 e_1 w^2 x_{s_1 b_1} \\ &\quad - 27e_1 x_{s_1 b_1}^3 + 614400\delta_{s_1 b_1}^2 w^5 + 864w^3 x_{s_1 b_1}^2 - 46080\delta_{s_1 b_1} w^4 x_{s_1 b_1} + 27y_{b_1}^2. \end{aligned} \quad (\text{B.47})$$

We then perform a second shift

$$x_{s_1 b_1} = x_{s_2 b_1} + \frac{80}{3}w\delta_{s_1 b_1} \quad (\text{B.48})$$

and a second blow-up

$$(e_1, x_{s_2 b_1}, y_{b_1}; e_2) \quad (\text{B.49})$$

whose proper transformation is

$$\begin{aligned} 0 &= 16384\delta_{s_1 b_1}^4 e_{1b_1}^2 w + 64\delta_{s_1 b_1}^2 e_{1b_1} (4\delta_{s_1 b_1} e_{1b_1} e_2 - 13w^2) x_{s_2 b_2} \\ &\quad + 16w(-5\delta_{s_1 b_1} e_{1b_1} e_2 + 2w^2) x_{s_2 b_2}^2 - e_{1b_1} e_2^2 x_{s_2 b_2}^3 + y_{b_2}^2. \end{aligned} \quad (\text{B.50})$$

We then perform a third shift in the patch $x_{s_2 b_2} \neq 0$:

$$w = w_{s_1} - \frac{8\delta_{s_1 b_1}^2 e_{1b_1}}{x_{s_2 b_2}}, \quad e_2 = e_{2s_1} + \frac{448\delta_{s_1 b_1}^3 e_{1b_1}}{x_{s_2 b_2}^2} \quad (\text{B.51})$$

After the third blow-up

$$(w_{s_1}, e_{2s_1}, y_{b_2}; d_1) \quad (\text{B.52})$$

whose proper transformation is

$$32x_{s_2 b_2}^2 d_1 w_{s_1}^3 - x_{s_2 b_2} e_{1b_1} (x_{s_2 b_2} e_{2s_1 b_1} + 40\delta_{s_1 b_1} w_{s_1 b_1})^2 + y_{b_3}^2 = 0, \quad (\text{B.53})$$

one can check that there are no more codimension-two singularities in the above proper transformation.

The projective relations of the blow-ups are

$$\begin{aligned} & (x_{s_2 b_2} d_1 e_{2s_1 b_1}, d_1^2 y_{b_3} e_{2s_1 b_1}, \delta_{s_1 b_1}) \\ & (e_{1b_1} e_{2s_1 b_1} d_1, x_{s_2 b_2}, y_{b_3} e_{2s_1 b_1} d_1) \\ & (w_{s_1 b_1}, e_{2s_1 b_1}, y_{b_3}). \end{aligned} \quad (\text{B.54})$$

Note that the original surface $S : \delta = 0$ becomes

$$-\frac{1}{4} d_1^2 w_{s_1 b_1}^2 x_{s_2 b_2}^2 + 432 \delta_{s_1 b_1}^4 e_{1b_1}^2 + x_{s_2 b_2} d_1 \delta_{s_1 b_1} e_{1b_1} (4 \delta_{s_1 b_1} w_{s_1 b_1} + e_{2s_1 b_1} x_{s_2 b_2}) = 0. \quad (\text{B.55})$$

To see the geometry of S , we define the following curves on S

$$\begin{aligned} C_1 : & d_1 = e_{1b_1} = y_{b_3} = 0 \\ C_2 : & e_{1b_1} = w_{s_1 b_1} = y_{b_3} = 0 \\ C_3 : & e_{2s_1 b_1} = 32 x_{s_2 b_2}^2 d_1 w_{s_1 b_1}^3 - 1600 x_{s_2 b_2} e_{1b_1} \delta_{s_1 b_1}^2 w_{s_1 b_1}^2 + y_{b_3}^2 \\ & = -\frac{1}{4} d_1^2 w_{s_1 b_1}^2 x_{s_2 b_2}^2 + 432 \delta_{s_1 b_1}^4 e_{1b_1}^2 + 4 x_{s_2 b_2} d_1 \delta_{s_1 b_1}^2 e_{1b_1} w_{s_1 b_1} = 0 \\ C_4 : & w_{s_1 b_1} = y_{b_3}^2 - x_{s_2 b_2}^3 e_{1b_1} e_{2s_1 b_1}^2 = 432 \delta_{s_1 b_1} e_{1b_1} + x_{s_2 b_2}^2 d_1 e_{2s_1 b_1} = 0 \\ C_5 : & \delta_{s_1 b_1} = w_{s_1 b_1} = y_{b_3}^2 - x_{s_2 b_2}^3 e_{1b_1} e_{2s_1 b_1}^2. \end{aligned} \quad (\text{B.56})$$

Note that S has a curve of double point singularity along C_1 . The intersection relation between these curves are

$$(\text{B.57})$$

The exceptional divisors of $Sp(2)$ are $e_{1b_1} = 0$, $e_{2s_2 b_1} = 0$ and the affine node $\delta_{s_1 b_1} = 0$. The exceptional divisors of $Sp(1)$ are $d_1 = 0$ and the affine node $w_{s_1 b_1} = 0$. Hence from the (-1) -curves on S , we derive the matter spectrum on the 6d tensor branch under the representations of flavor symmetry group $Sp(2) \times Sp(1)$:

$$C_1 \rightarrow (\mathbf{5}, \mathbf{2}), \quad C_2 \rightarrow (\mathbf{1}, \mathbf{2}). \quad (\text{B.58})$$

One can check that the above matter representations satisfy the 6d gauge anomaly cancellation conditions.

Similar to the discussions of $\Delta(48)$ in section 4.1.1, the 6d SCFT is different from the rank-1 E-string since the contributions to gravitational anomaly ($\Delta H_{\text{localized}} = 41$) and flavor rank (3 instead of 8) are both different from those of a rank-1 E-string.

B.5.2 5d interpretation

In the 5d case, the first blow up is a weighted blow up

$$(x^{(2)}, y^{(3)}, z^{(1)}, w^{(1)}; \delta_1) \quad (\text{B.59})$$

instead of blowing up the base. We will not repeat the details of the resolution. In the end, the curves on the compact divisor $S_1 : \delta_1 = 0$ are

$$\quad (\text{B.60})$$

Note that the curve C_5 corresponds to the affine node of $Sp(2)$ and $Sp(1)$, which becomes a (-1) -curve after the blow down of S from the 6d geometry. The flavor symmetry factors read off from the geometry are $G_F = SU(2)^2 \times U(1)$.

Note that the resolution of (A.104) is also discussed in [105].

B.6 $E^{(2)}$

We start with the singular equation

$$z^3 - w(y^3 + 12\sqrt{3}ix^2) = 0, \quad (\text{B.61})$$

and do the blow up sequence

$$(x, y, z, w; \delta_1), (x, y, z; \delta_2), (x, \delta_2; \delta_3), (\delta_2, \delta_3; \delta_4). \quad (\text{B.62})$$

We get

$$z^3\delta_2 - w(y^3\delta_1\delta_2 + 12\sqrt{3}ix^2\delta_3) = 0. \quad (\text{B.63})$$

Now we define

$$U = y^3\delta_1\delta_2 + 12\sqrt{3}ix^2\delta_3. \quad (\text{B.64})$$

After the blow up

$$(z, w, U; \delta_5), (\delta_5, w; \delta_6), \quad (\text{B.65})$$

the resolved equation is a complete intersection

$$\begin{cases} U\delta_5\delta_6 = y^3\delta_1\delta_2 + 12\sqrt{3}ix^2\delta_3 \\ z^3\delta_5 = wU. \end{cases} \quad (\text{B.66})$$

Since $\delta_2 = 0$ is an empty set, the variable δ_2 can be dropped from the equations.

The compact divisor $S_1 : \delta_1 = 0$ has equation

$$\begin{cases} U\delta_5\delta_6 = 12\sqrt{3}ix^2\delta_3 \\ z^3\delta_5 = wU. \end{cases} \quad (\text{B.67})$$

Now we discuss the flavor symmetry G_F from non-compact divisors. We plot the configuration of curves on $\delta_1 = 0$:

$$\begin{aligned} C_1 : \quad & \delta_1 = \delta_3 = U = z = 0 \\ C_2 : \quad & \delta_1 = \delta_4 = U\delta_5\delta_6 - 12\sqrt{3}i\delta_3 = z^3\delta_5\delta_6 - wU = 0 \\ C_3 : \quad & \delta_1 = \delta_5 = x = U = 0 \\ C_4 : \quad & \delta_1 = \delta_6 = x = z^3\delta_5 - wU = 0 \\ C_5 : \quad & \delta_1 = x = z = U = 0. \end{aligned} \quad (\text{B.68})$$

$$(\text{B.69})$$

Note that C_1 and C_2 come from the resolution of the codimension-two D_4 singularity, while C_3 and C_4 come from the A_2 singularity. C_5 is the curve of cusp singularity $x = z = U = 0$.

A non-trivial fact is that the curve C_1 has normal bundle $\mathcal{O}(-1) \oplus \mathcal{O}(-1)$. From the perspective of D_4 singularity over the δ_1 -axis, the fiber $\delta_3 = 0$ has three \mathbb{P}^1 components over any point $\delta_1 \neq 0$. The point $\delta_1 = 0$ is exactly the location where the fiber $\delta_3 = 0$ degenerates. Since the degenerate \mathbb{P}^1 fiber $\delta_1 = \delta_3 = 0$ is rigid, it should have normal bundle $\mathcal{O}(-1) \oplus \mathcal{O}(-1)$. Note that in the context of elliptic Calabi-Yau threefolds, the degenerate point is exactly the ramification point in presence of Tate monodromy [91].

Hence from the (-2) -curves on S_1 , we can read off flavor symmetry factors $G_F = SU(3) \times SU(2) \times U(1)$.

B.7 $E^{(4)}$

We start with the singular equation

$$z^2 - w(108x^4 - y^3) = 0, \quad (\text{B.70})$$

and do the blow up sequence

$$\begin{aligned} & (x^{(1)}, y^{(1)}, z^{(2)}, w^{(1)}; \delta_1), (x, y, z; \delta_2), (y, z, \delta_2; \delta_3), (\delta_2, z; \delta_4) \\ & (\delta_3, \delta_4; \delta_5), (\delta_4, \delta_5; \delta_6), (\delta_2, \delta_4; \delta_7). \end{aligned} \quad (\text{B.71})$$

We get

$$z^2 - w(108x^4\delta_1\delta_2^2\delta_4\delta_7^2 - y^3\delta_2\delta_3^2\delta_5) = 0. \quad (\text{B.72})$$

Now we define

$$U = 108x^4\delta_1\delta_2^2\delta_4\delta_7^2 - y^3\delta_2\delta_3^2\delta_5. \quad (\text{B.73})$$

After the blow up

$$(z, w, U; \delta_8) \quad (\text{B.74})$$

the resolved equation is a complete intersection

$$\begin{cases} U\delta_8 = 108x^4\delta_1\delta_2^2\delta_4\delta_7^2 - y^3\delta_2\delta_3^2\delta_5 \\ z^2 = wU. \end{cases} \quad (\text{B.75})$$

Since $\delta_2 = 0$ and $\delta_4 = 0$ are empty sets, the variables δ_2 and δ_4 can be dropped from the equations.

The compact divisor $S_1 : \delta_1 = 0$ has the equation

$$\begin{cases} U\delta_8 + y^3\delta_3^2\delta_5 = 0 \\ z^2 = wU. \end{cases} \quad (\text{B.76})$$

We plot the \mathbb{P}^1 curves on S_1 :

$$\begin{aligned} C_1 : \quad & \delta_1 = \delta_3 = U = z = 0 \\ C_2 : \quad & \delta_1 = \delta_5 = U = z = 0 \\ C_3 : \quad & \delta_1 = \delta_6 = U\delta_8 + y^3\delta_3^2\delta_5 = z^2 - wU = 0 \\ C_4 : \quad & \delta_1 = \delta_7 = U\delta_8 + y^3\delta_3^2\delta_5 = z^2 - wU = 0 \\ C_5 : \quad & \delta_1 = \delta_8 = y = z^2 - wU = 0 \\ C_6 : \quad & \delta_1 = y = z = U = 0. \end{aligned} \quad (\text{B.77})$$

$$(\text{B.78})$$

The curves C_1 , C_2 , C_3 and C_4 comes from the resolution of codimension-two E_6 singularity. Similar to the case in the previous section, the curves C_1 and C_2 are exactly the degenerate \mathbb{P}^1 s at the ramification point of the E_6 singularity. From the curves on S_1 , one can read off the flavor symmetry factors $G_F = SU(3) \times SU(2) \times U(1)^2$.

B.8 G'_m with odd m

The singular equation is

$$\begin{cases} u^2 - y(x + 4y^m) = 0 \\ v^2 - xz = 0 \end{cases} \quad (\text{B.79})$$

The codimension-two singularities are $D_{m+2} \times A_1^2$.

When $m = 1$, the singular equation is a complete intersection of two quadratics in \mathbb{C}^5 , and after the resolution

$$(x, y, z, u, v; \delta_1), \quad (\text{B.80})$$

the compact divisor $\delta_1 = 0$ is a smooth dP_5 . The 5d SCFT T_X^{5d} is the Seiberg rank-1 E_5 theory. Note that the flavor symmetry factors $SU(4) \times SU(2)^2$ from the codimension-two singularities is enhanced to

$$G_F = SO(10). \quad (\text{B.81})$$

When $m = 2k + 1 > 1$, the resolution sequence that gives rise to the compact divisors is

$$\begin{aligned} & (x, y, z, u, v; \delta_1) \\ & (x^{(2)}, u^{(1)}, v^{(1)}, \delta_j^{(1)}; \delta_{j+1}) \quad (j = 1, \dots, k). \end{aligned} \quad (\text{B.82})$$

The resolved equation is

$$\begin{cases} u^2 - y \left(x + 4y^{2k+1} \prod_{j=1}^k \delta_j^{2k+2-2j} \right) = 0 \\ v^2 - xz = 0 \end{cases} \quad (\text{B.83})$$

The triple intersection numbers among $S_j : \delta_j = 0$ are

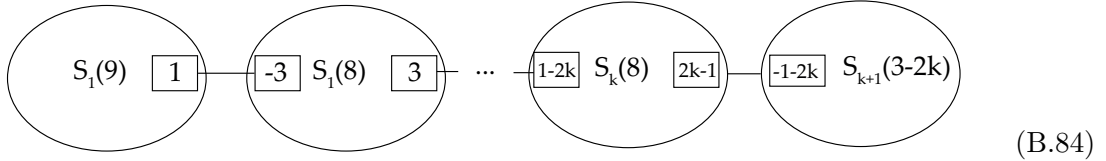

$$(\text{B.84})$$

After a series flops that blow down S_{k+1} and blow up S_1 , the new triple intersection numbers are

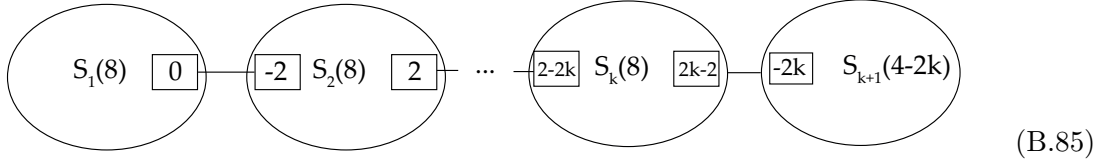

$$(\text{B.85})$$

The 5d IR gauge theory description is

$$4\mathbf{F} - SU(2) - SU(2)_0 - \dots - SU(2)_0. \quad (\text{B.86})$$

The flavor symmetry factors $SO(2m + 4) \times SU(2)^2$ are generally enhanced to

$$G_F = SO(2m + 8). \quad (\text{B.87})$$

B.9 $\mathbb{C}^3/\Delta(6n^2)$, $n = 2k$

The singularity $\mathbb{C}^3/\Delta(6n^2)$ ($n = 2k$) has the following hypersurface equation

$$-20w^{\frac{n}{2}+1}x^3 + 36w^{\frac{n}{2}+1}xy + 108w^{n+1} + 5wx^2y^2 - 4wx^4y + wx^6 - 2wy^3 + 4z^2 = 0. \quad (\text{B.88})$$

Apart from cod-3 singularity at $x = y = z = w = 0$, there are also cod-2 singularities at

$$\begin{aligned} A_1 : y - \frac{x^2}{2} = z = w = 0 \\ D_{\frac{n}{2}+2} : y - x^2 = z = w = 0 \\ A_1 : y - \frac{x^2}{3} = z = x^3 - 27w^{\frac{n}{2}} = 0. \end{aligned} \quad (\text{B.89})$$

If $3 \nmid n$, the last cod-2 loci is singular. If $3 \mid n$, the last cod-2 loci is smooth with three irreducible components.

For $n = 4$, we first do coordinate substitution

$$y = y_2 + \frac{x^2}{3}, \quad (\text{B.90})$$

and rewrite the singular equation as

$$\begin{cases} 0 = 4z^2 - 2wy_2^3 + 3wx^2y_2^2 - \frac{4}{3}wxy_2U + \frac{4}{27}wU^2 \\ U = x^3 - 27w^2. \end{cases} \quad (\text{B.91})$$

We use the following resolution sequence

$$(y_2, z, U; \delta_1), (x, z, w, U, \delta_1; \delta_2), (z, w, \delta_1, \delta_2; \delta_3) \quad (\text{B.92})$$

to get

$$\begin{cases} 0 = 4z^2 - 2wy_2^3\delta_1 + 3wx^2y_2^2\delta_2 - \frac{4}{3}wxy_2U\delta_2 + \frac{4}{27}wU^2\delta_2 \\ 0 = x^3\delta_2 - 27w^2\delta_3 - U\delta_1. \end{cases} \quad (\text{B.93})$$

Then we look at the patch of $\delta_1 \neq 0$, and plug

$$U = \frac{x^3\delta_2 - 27w^2\delta_3}{\delta_1} \quad (\text{B.94})$$

into the first equation. After the shifting

$$y_3 = y_2 - \frac{2\delta_2x^2}{3\delta_1}, \quad (\text{B.95})$$

the first equation becomes

$$108\delta_2\delta_3^2w^5 + 16\delta_2^2\delta_3w^3x^3 + 36\delta_1\delta_2\delta_3w^3xy_3 - \delta_1^2\delta_2wx^2y_3^2 - 2\delta_1^3wy_3^3 + 4\delta_1^2z^2 = 0. \quad (\text{B.96})$$

We can do the further blow ups and resolve the remaining D_4 and A_1 codimension-two singularities

$$(z, w, y_3; \delta_4), (z, \delta_4; \delta_5), (\delta_4, \delta_5; \delta_6), (z, w, \delta_2x^2 + 2\delta_1\delta_4\delta_5\delta_6^2y_3; \delta_7) \quad (\text{B.97})$$

The resolved equation is

$$\begin{aligned} & \delta_4 w (4\delta_2 \delta_3 \delta_7 w^2 (27\delta_3 \delta_4^2 \delta_5^2 \delta_6^4 \delta_7^2 w^2 + 4\delta_2 x^3) + 36\delta_1 \delta_2 \delta_3 \delta_4 \delta_5 \delta_6^2 \delta_7 w^2 x y_3 \\ & - \delta_1^2 y_3^2 (\delta_2 x^2 + 2\delta_1 \delta_4 \delta_5 \delta_6^2 y_3)) + 4\delta_1^2 \delta_5 z^2 = 0 \end{aligned} \quad (\text{B.98})$$

The two compact divisors are $S_2 : \delta_2 = 0$ and $S_3 : \delta_3 = 0$. The other divisors are non-compact, $S_1 : \delta_1 = 0$, $S_6 : \delta_6 = 0$ and $S_7 : \delta_7 = 0$ are irreducible while $S_5 : \delta_5 = 0$ has two components. This exactly matches $r = 2$, $f = 5$.

B.10 $C_{3l,l}^{(1)}, 3 \mid l$

Start from the singular equation

$$w^l x^2 + 3w^{2l} x - 6w^l y z + 9w^{3l} - x y z + y^3 + z^3 = 0, \quad (\text{B.99})$$

one can always do the following sequence of resolutions

$$\begin{aligned} & (x, y, z, w; \delta_1) \\ & (x, y, z, \delta_i; \delta_{i+1}) \quad (i = 1, \dots, l-1). \end{aligned} \quad (\text{B.100})$$

Nonetheless, the resulting equation is still singular and more blow ups need to be done. For $l = 3$, the resolution sequence giving rise to compact divisors are

$$\begin{aligned} & (x, y, z, w; \delta_1) \\ & (x, y, z, \delta_1; \delta_2) \\ & (x, y, z, \delta_2; \delta_3) \\ & (y, z, \delta_1; \delta_4). \end{aligned} \quad (\text{B.101})$$

The equation after this is

$$w^3 x^2 \delta_1^2 \delta_2 + 3w^6 x \delta_1^4 \delta_2^2 \delta_4^2 - 6w^3 y z \delta_1^2 \delta_2 \delta_4^2 + 9w^9 \delta_1^6 \delta_2^3 \delta_4^4 - x y z + y^3 \delta_4 + z^3 \delta_4 = 0. \quad (\text{B.102})$$

The compact divisors are $S_i : \delta_i = 0$, ($i = 1, \dots, 4$). Then intersection numbers among them are

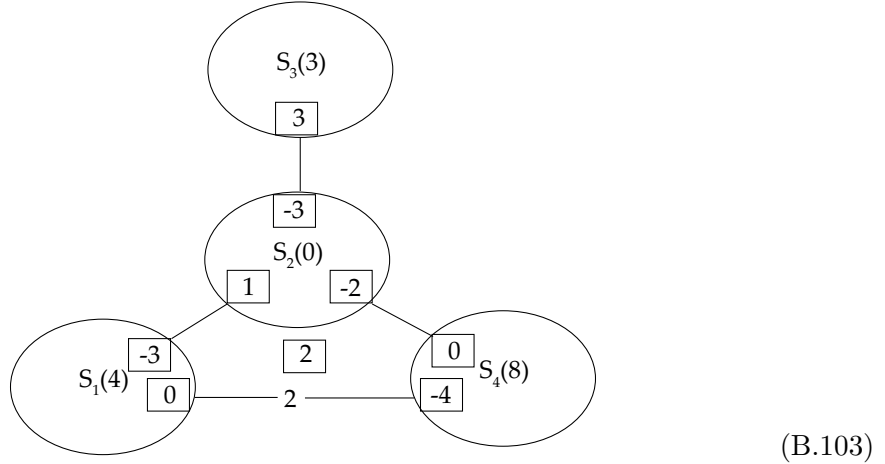

The number “2” on a edge means that the intersection curve $S_1 \cdot S_4$ has two irreducible components, and $S_1 S_2 S_4 = 2$.

After this, there are still codimension-two singularities which can be resolved without changing the triple intersection numbers among compact divisors.

B.11 $D_{3l,l}^{(1)}$, $l = 2k$

We study the $D_{3l,l}^{(1)}$ singularity with $l = 2$. The singular equation is a complete intersection

$$\begin{cases} 4v^2u + 12vu^2 - 6x^2u + 6zu + 36u^3 - vx^2 + vz + x^3 + 3xz = 0, \\ y^2 - uz = 0. \end{cases} \quad (\text{B.104})$$

The resolution sequence that generates compact divisors are

$$(x, y, z, u, v; \delta_1), (\delta_1, z; \delta_2), (\delta_2, y; \delta_3), (\delta_2, \delta_3; \delta_4), (\delta_3, z; \delta_5). \quad (\text{B.105})$$

The transformed equation is

$$\begin{cases} (4v^2u + 12vu^2 + 36u^3 - vx^2 - 6x^2u + x^3)\delta_1 + z(6u + v + 3x)\delta_5 = 0, \\ y^2\delta_3 - uz\delta_2 = 0. \end{cases} \quad (\text{B.106})$$

The irreducible compact divisors are $S_1 : \delta_1 = 0$, $S_2 : \delta_3 = 0$, $S_3 : \delta_4 = 0$ and $S_4 : \delta_5 = 0$. The triple intersection numbers are computed with the methods in section 2.2.2:

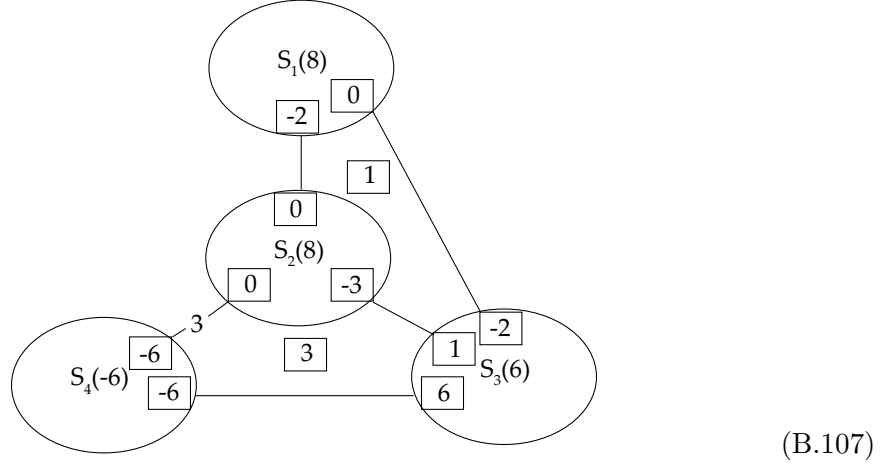

The geometry does not have a ruling structure since the curve $S_1 \cdot S_3$ is a section curve on S_1 but a ruling curve on S_3 .

B.12 H_{72}

We start with the singular equation

$$0 = -236117700w^3x^2 + 2526543w^2y^2 - 1744878w^4y + 321071w^6 \quad (\text{B.108})$$

$$+ 638296200wx^2y + 43435278000x^4 - 1102736y^3 + 1608714000z^3 \quad (\text{B.109})$$

We first do the resolution

$$(x, y, z, w; \delta_1) \quad (\text{B.110})$$

and get the equation

$$\begin{aligned} 0 = & -236117700w^3x^2\delta_1^2 + 2526543w^2y^2\delta_1 - 1744878w^4y\delta_1^2 + 321071w^6\delta_1^3 \\ & + 638296200wx^2y\delta_1 + 43435278000x^4\delta_1 - 1102736y^3 + 1608714000z^3. \end{aligned} \quad (\text{B.111})$$

The equation is still singular at the loci

$$\begin{aligned} 432x^2 - w^3\delta_1 &= 164y - 9\delta_1w^2 = z = 0 \\ x = y - \delta_1w^2 &= z = 0. \end{aligned} \quad (\text{B.112})$$

Now we substitute

$$y = y_2 + \frac{9\delta_1w^2}{164}, \quad (\text{B.113})$$

and rewrite (B.111) as

$$\begin{aligned} (3723875\delta_1^3w^6)/16 - 1102736y_2^3 - \frac{72075}{2}\delta_1^2w^3(5580x^2 + 41wy_2) + \\ 1395\delta_1(5580x^2 + 41wy_2)^2 + 1608714000z^3 = 0 \end{aligned} \quad (\text{B.114})$$

Now we can rewrite the equation as a complete intersection with the new variable Δ

$$\begin{cases} (3723875\delta_1^3w^6)/16 - 1102736y_2^3 - \frac{72075}{2}\delta_1^2w^3\Delta + 1395\delta_1\Delta^2 + 1608714000z^3 = 0 \\ \Delta - (5580x^2 + 41wy_2) = 0 \end{cases} \quad (\text{B.115})$$

After the resolution

$$(\delta_1, y_2, \Delta, z; \delta_2), \quad (\text{B.116})$$

the equations become

$$\begin{cases} (3723875\delta_1^3w^6)/16 - 1102736y_2^3 - \frac{72075}{2}\delta_1^2w^3\Delta + 1395\delta_1\Delta^2 + 1608714000z^3 = 0 \\ \Delta\delta_2 - (5580x^2 + 41wy_2\delta_2) = 0 \end{cases} \quad (\text{B.117})$$

The first equation is still singular at

$$12\Delta - 155\delta_1w^3 = y_2 = z = 0. \quad (\text{B.118})$$

Now we substitute

$$\Delta = \Delta_2 + \frac{155\delta_1w^3}{12}, \quad (\text{B.119})$$

and rewrite the first equation of (B.117) as

$$1395\delta_1\Delta_2^2 - 1102736y_2^3 + 1608714000z^3 = 0. \quad (\text{B.120})$$

The singularity at $\Delta_2 = y_2 = z = 0$ is of du Val type D_4 , and we can perform the following resolution sequence

$$(\Delta_2, y_2, z; \delta_3), (\Delta_2, \delta_3; \delta_4), (\delta_3, \delta_4; \delta_5) \quad (\text{B.121})$$

Finally, we use the resolutions

$$(x, \delta_2; \delta_6), (\delta_2, \delta_6; \delta_7) \quad (\text{B.122})$$

to make the second equation in (B.117) smooth as well. The final equations are

$$\begin{cases} 1395\delta_1\Delta_2^2\delta_4 + (-1102736y_2^3 + 1608714000z^3)\delta_3 = 0 \\ (\Delta_2\delta_3\delta_4^2\delta_5^3 + \frac{155\delta_1w^3}{12} + 41wy_2\delta_3\delta_4\delta_5^2)\delta_2 - 5580x^2\delta_6 = 0 \end{cases} \quad (\text{B.123})$$

The compact divisors are $\delta_1 = 0$, $\delta_6 = 0$ and $\delta_7 = 0$. The equation for $\delta_1 = 0$ is

$$\begin{cases} -1102736y_2^3 + 1608714000z^3 = 0 \\ (\Delta_2\delta_3\delta_4^2\delta_5^3 + 41wy_2\delta_3\delta_4\delta_5^2)\delta_2 - 5580x^2\delta_6 = 0 \end{cases} \quad (\text{B.124})$$

The first equation is reducible, hence $\delta_1 = 0$ has three irreducible components. The other compact divisors are irreducible, and we get the correct 5d rank $r = 5$.

For the flavor rank, note that the sequence in (B.121) gives new non-compact divisors $\delta_4 = 0$ and $\delta_5 = 0$ as the same way as the resolution of a D_4 singularity. $\delta_4 = 0$ has three irreducible components and $\delta_5 = 0$ is irreducible. Along with the non-compact divisor $\Delta = 0$, they give rise to the correct flavor rank $f = 5$.

B.13 H_{216}

Starting from the singular equation

$$\begin{aligned} 0 = & 7996685367948717077820w^2x^3 + 5751067536004617099w^2y^2 - 52005772276829280w^2yz \\ & + 131753659993217447094w^4y + 201282072182100w^2z^2 - 1056790655463324600w^4z \\ & + 1112324224808258441343w^6 + 21970495217646693900x^3y + 826556965553185776x^3z \\ & + 17145803149032y^2z - 8560505896492y^3 - 8610088608588yz^2 + 24791356048z^3, \end{aligned} \quad (\text{B.125})$$

we first substitute variables

$$z \rightarrow z - 12420w^2, \quad y \rightarrow y + \frac{112887w^2}{1093}. \quad (\text{B.126})$$

The equation is rewritten as

$$\begin{cases} -4778596(1791427y - 5188z)(y - z)^2 + 804043740810492U(27325y + 1028z) + \\ 3038392539w^2(66673y - 516z)(27325y + 1028z) = 0 \\ U = x^3 + 27w^4 \end{cases} \quad (\text{B.127})$$

We do the following resolution sequence

$$\begin{aligned} & (y, z, U; \delta_1), (U, \delta_1, x, w; \delta_2), (x, U, \delta_1, \delta_2; \delta_3), (U, \delta_1, \delta_2, \delta_3; \delta_4) \\ & (\delta_1, \delta_2; \delta_5), (\delta_1, 27325y + 1028z; \delta_6), (\delta_2, \delta_6; \delta_7), (\delta_5, 27325y + 1028z; \delta_8) \\ & (U, \delta_2; \delta_9), (\delta_1, \delta_9; \delta_{10}), (\delta_5, \delta_9; \delta_{11}). \end{aligned} \quad (\text{B.128})$$

The resolved equation is

$$\begin{cases} -4778596(1791427y - 5188z)(y - z)^2\delta_1\delta_5 + 804043740810492U(27325y + 1028z)\delta_9 + \\ 3038392539w^2(66673y - 516z)(27325y + 1028z)\delta_2\delta_5\delta_7\delta_8\delta_9 = 0 \\ U\delta_1\delta_6 = x^3\delta_2\delta_3^2\delta_4 + 27w^4\delta_2^2\delta_5\delta_7\delta_8\delta_9\delta_{10}\delta_{11}. \end{cases} \quad (\text{B.129})$$

The compact divisors are $S_1 : \delta_3 = 0$, $S_2 : \delta_4 = 0$, $S_3 : \delta_6 = 0$, $S_4 : \delta_7 = 0$, $S_5 : \delta_8 = 0$, $S_6 : \delta_9 = y - z = 0$, $S_7 : \delta_9 = 1791427y - 5188z = 0$, $S_8 : \delta_{10} = 0$, $S_9 : \delta_{11} = 0$. Note that the equation of $\delta_9 = 0$ has two irreducible components. The number of irreducible compact surfaces exactly matches the expected rank $r = 9$.

References

- [1] N. Seiberg, *Five-dimensional SUSY field theories, nontrivial fixed points and string dynamics*, *Phys. Lett.* **B388** (1996) 753–760, [[hep-th/9608111](#)].
- [2] D. R. Morrison and N. Seiberg, *Extremal transitions and five-dimensional supersymmetric field theories*, *Nucl. Phys.* **B483** (1997) 229–247, [[hep-th/9609070](#)].
- [3] K. A. Intriligator, D. R. Morrison and N. Seiberg, *Five-dimensional supersymmetric gauge theories and degenerations of Calabi-Yau spaces*, *Nucl. Phys.* **B497** (1997) 56–100, [[hep-th/9702198](#)].
- [4] J. Eckhard, S. Schäfer-Nameki and Y.-N. Wang, *Trifectas for T_N in 5d*, *JHEP* **07** (2020) 199, [[2004.15007](#)].
- [5] D. Xie and S.-T. Yau, *Three dimensional canonical singularity and five dimensional $\mathcal{N} = 1$ SCFT*, *JHEP* **06** (2017) 134, [[1704.00799](#)].
- [6] C. Closset, S. Schafer-Nameki and Y.-N. Wang, *Coulomb and Higgs Branches from Canonical Singularities: Part 0*, *JHEP* **02** (2021) 003, [[2007.15600](#)].
- [7] C. Closset, S. Giacomelli, S. Schafer-Nameki and Y.-N. Wang, *5d and 4d SCFTs: Canonical Singularities, Trinions and S-Dualities*, *JHEP* **05** (2021) 274, [[2012.12827](#)].
- [8] C. Closset, S. Schäfer-Nameki and Y.-N. Wang, *Coulomb and Higgs Branches from Canonical Singularities, Part 1: Hypersurfaces with Smooth Calabi-Yau Resolutions*, [[2111.13564](#)].
- [9] F. Apruzzi, L. Lin and C. Mayrhofer, *Phases of 5d SCFTs from M-/F-theory on Non-Flat Fibrations*, *JHEP* **05** (2019) 187, [[1811.12400](#)].
- [10] F. Apruzzi, C. Lawrie, L. Lin, S. Schäfer-Nameki and Y.-N. Wang, *5d Superconformal Field Theories and Graphs*, *Phys. Lett. B* **800** (2020) 135077, [[1906.11820](#)].
- [11] F. Apruzzi, C. Lawrie, L. Lin, S. Schafer-Nameki and Y.-N. Wang, *Fibers add Flavor, Part I: Classification of 5d SCFTs, Flavor Symmetries and BPS States*, *JHEP* **11** (2019) 068, [[1907.05404](#)].
- [12] F. Apruzzi, C. Lawrie, L. Lin, S. Schäfer-Nameki and Y.-N. Wang, *Fibers add Flavor, Part II: 5d SCFTs, Gauge Theories, and Dualities*, *JHEP* **03** (2020) 052, [[1909.09128](#)].
- [13] F. Apruzzi, S. Schafer-Nameki and Y.-N. Wang, *5d SCFTs from Decoupling and Gluing*, *JHEP* **08** (2020) 153, [[1912.04264](#)].
- [14] M. Hubner, *5d SCFTs from (E_n, E_m) conformal matter*, *JHEP* **12** (2020) 014, [[2006.01694](#)].
- [15] P. Jefferson, H.-C. Kim, C. Vafa and G. Zafrir, *Towards Classification of 5d SCFTs: Single Gauge Node*, [[1705.05836](#)].
- [16] P. Jefferson, S. Katz, H.-C. Kim and C. Vafa, *On Geometric Classification of 5d SCFTs*, *JHEP* **04** (2018) 103, [[1801.04036](#)].
- [17] L. Bhardwaj and P. Jefferson, *Classifying 5d SCFTs via 6d SCFTs: Rank one*, *JHEP* **07** (2019) 178, [[1809.01650](#)].
- [18] L. Bhardwaj and P. Jefferson, *Classifying 5d SCFTs via 6d SCFTs: Arbitrary rank*, *JHEP* **10** (2019) 282, [[1811.10616](#)].
- [19] L. Bhardwaj, *On the classification of 5d SCFTs*, *JHEP* **09** (2020) 007, [[1909.09635](#)].

- [20] L. Bhardwaj, *Dualities of 5d gauge theories from S-duality*, *JHEP* **07** (2020) 012, [[1909.05250](#)].
- [21] L. Bhardwaj, *Do all 5d SCFTs descend from 6d SCFTs?*, *JHEP* **04** (2021) 085, [[1912.00025](#)].
- [22] L. Bhardwaj and G. Zafrir, *Classification of 5d $\mathcal{N} = 1$ gauge theories*, *JHEP* **12** (2020) 099, [[2003.04333](#)].
- [23] L. Bhardwaj, *Flavor symmetry of 5d SCFTs. Part I. General setup*, *JHEP* **09** (2021) 186, [[2010.13230](#)].
- [24] L. Bhardwaj, *Flavor symmetry of 5d SCFTs. Part II. Applications*, *JHEP* **04** (2021) 221, [[2010.13235](#)].
- [25] A. P. Braun, J. Chen, B. Haghighat, M. Sperling and S. Yang, *Fibre-base duality of 5d KK theories*, *JHEP* **05** (2021) 200, [[2103.06066](#)].
- [26] L. Bhardwaj, P. Jefferson, H.-C. Kim, H.-C. Tarazi and C. Vafa, *Twisted Circle Compactifications of 6d SCFTs*, *JHEP* **12** (2020) 151, [[1909.11666](#)].
- [27] L. Bhardwaj, *More 5d KK theories*, [2005.01722](#).
- [28] C. Closset, M. Del Zotto and V. Saxena, *Five-dimensional SCFTs and gauge theory phases: an M-theory/type IIA perspective*, *SciPost Phys.* **6** (2019) 052, [[1812.10451](#)].
- [29] C. Closset and M. Del Zotto, *On 5d SCFTs and their BPS quivers. Part I: B-branes and brane tilings*, [1912.13502](#).
- [30] V. Saxena, *Rank-two 5d SCFTs from M-theory at isolated toric singularities: a systematic study*, *JHEP* **04** (2020) 198, [[1911.09574](#)].
- [31] A. Collinucci and R. Valandro, *The role of $U(1)$'s in 5d theories, Higgs branches, and geometry*, *JHEP* **10** (2020) 178, [[2006.15464](#)].
- [32] C. Closset and H. Magureanu, *The U -plane of rank-one 4d $\mathcal{N} = 2$ KK theories*, *SciPost Phys.* **12** (2022) 065, [[2107.03509](#)].
- [33] O. Aharony and A. Hanany, *Branes, superpotentials and superconformal fixed points*, *Nucl. Phys.* **B504** (1997) 239–271, [[hep-th/9704170](#)].
- [34] O. Aharony, A. Hanany and B. Kol, *Webs of (p,q) five-branes, five-dimensional field theories and grid diagrams*, *JHEP* **01** (1998) 002, [[hep-th/9710116](#)].
- [35] O. DeWolfe, A. Hanany, A. Iqbal and E. Katz, *Five-branes, seven-branes and five-dimensional $E(n)$ field theories*, *JHEP* **03** (1999) 006, [[hep-th/9902179](#)].
- [36] O. Bergman, D. Rodríguez-Gómez and G. Zafrir, *5-Brane Webs, Symmetry Enhancement, and Duality in 5d Supersymmetric Gauge Theory*, *JHEP* **03** (2014) 112, [[1311.4199](#)].
- [37] G. Zafrir, *Duality and enhancement of symmetry in 5d gauge theories*, *JHEP* **12** (2014) 116, [[1408.4040](#)].
- [38] G. Zafrir, *Instanton operators and symmetry enhancement in 5d supersymmetric USp , SO and exceptional gauge theories*, *JHEP* **07** (2015) 087, [[1503.08136](#)].
- [39] O. Bergman and G. Zafrir, *5d fixed points from brane webs and $O7$ -planes*, *JHEP* **12** (2015) 163, [[1507.03860](#)].
- [40] G. Zafrir, *Brane webs, 5d gauge theories and 6d $\mathcal{N} = (1, 0)$ SCFT's*, *JHEP* **12** (2015) 157, [[1509.02016](#)].

- [41] H. Hayashi, S.-S. Kim, K. Lee, M. Taki and F. Yagi, *A new 5d description of 6d D-type minimal conformal matter*, *JHEP* **08** (2015) 097, [[1505.04439](#)].
- [42] G. Zafrir, *Brane webs and O5-planes*, *JHEP* **03** (2016) 109, [[1512.08114](#)].
- [43] H. Hayashi, S.-S. Kim, K. Lee and F. Yagi, *6d SCFTs, 5d Dualities and Tao Web Diagrams*, *JHEP* **05** (2019) 203, [[1509.03300](#)].
- [44] G. Ferlito, A. Hanany, N. Mekareeya and G. Zafrir, *3d Coulomb branch and 5d Higgs branch at infinite coupling*, *JHEP* **07** (2018) 061, [[1712.06604](#)].
- [45] S. Cabrera, A. Hanany and F. Yagi, *Tropical Geometry and Five Dimensional Higgs Branches at Infinite Coupling*, *JHEP* **01** (2019) 068, [[1810.01379](#)].
- [46] H. Hayashi, S.-S. Kim, K. Lee and F. Yagi, *5-brane webs for 5d $\mathcal{N} = 1$ G_2 gauge theories*, *JHEP* **03** (2018) 125, [[1801.03916](#)].
- [47] H. Hayashi, S.-S. Kim, K. Lee and F. Yagi, *Dualities and 5-brane webs for 5d rank 2 SCFTs*, *JHEP* **12** (2018) 016, [[1806.10569](#)].
- [48] A. Bourget, S. Cabrera, J. F. Grimminger, A. Hanany, M. Sperling, A. Zajac et al., *The Higgs mechanism — Hasse diagrams for symplectic singularities*, *JHEP* **01** (2020) 157, [[1908.04245](#)].
- [49] A. Bourget, J. F. Grimminger, A. Hanany, M. Sperling and Z. Zhong, *Magnetic Quivers from Brane Webs with O5 Planes*, *JHEP* **07** (2020) 204, [[2004.04082](#)].
- [50] M. Akhond, F. Carta, S. Dwivedi, H. Hayashi, S.-S. Kim and F. Yagi, *Five-brane webs, Higgs branches and unitary/orthosymplectic magnetic quivers*, *JHEP* **12** (2020) 164, [[2008.01027](#)].
- [51] M. Akhond and F. Carta, *Magnetic quivers from brane webs with $O7^+$ -planes*, *JHEP* **10** (2021) 014, [[2107.09077](#)].
- [52] M. van Beest, A. Bourget, J. Eckhard and S. Schafer-Nameki, *(Symplectic) Leaves and (5d Higgs) Branches in the Poly(go)nesian Tropical Rain Forest*, *JHEP* **11** (2020) 124, [[2008.05577](#)].
- [53] M. Van Beest, A. Bourget, J. Eckhard and S. Schäfer-Nameki, *(5d RG-flow) Trees in the Tropical Rain Forest*, *JHEP* **03** (2021) 241, [[2011.07033](#)].
- [54] M. van Beest and S. Giacomelli, *Connecting 5d Higgs branches via Fayet-Iliopoulos deformations*, *JHEP* **12** (2021) 202, [[2110.02872](#)].
- [55] M. Reid, *Mckay correspondence*, [alg-geom/9702016](#).
- [56] Y. Ito and M. Reid, *The mckay correspondence for finite subgroups of $sl(3, c)$* , in *Higher Dimensional Complex Varieties*, pp. 221–240. de Gruyter, 2011. [arXiv:alg-geom/9411010](#).
- [57] G. A. Miller, H. F. Blichfeldt and I. Dickson, *Theory and Applications of Finite Groups*. John Wiley & Sons, Incorporated, 1916, <https://doi.org/10.1038/098225b0>.
- [58] W. M. Fairbairn, T. Fulton and W. H. Klink, *Finite and Disconnected Subgroups of SU_3 and their Application to the Elementary-Particle Spectrum*, *J. Math. Phys.* **5** (1964) 1038.
- [59] A. Bovier, M. Lüling and D. Wyler, *Finite subgroups of $su(3)$* , *Journal of Mathematical Physics* **22** (1981) 1543–1547.
- [60] W. Fairbairn and T. Fulton, *Some comments on finite subgroups of $su(3)$* , *Journal of Mathematical Physics* **23** (1982) 1747–1748.

- [61] A. Hanany and A. M. Uranga, *Brane boxes and branes on singularities*, *JHEP* **05** (1998) 013, [[hep-th/9805139](#)].
- [62] A. Hanany and Y.-H. He, *NonAbelian finite gauge theories*, *JHEP* **02** (1999) 013, [[hep-th/9811183](#)].
- [63] T. Muto, *D-branes on three-dimensional nonAbelian orbifolds*, *JHEP* **02** (1999) 008, [[hep-th/9811258](#)].
- [64] B. Feng, A. Hanany and Y.-H. He, *The $Z(k) \times D(k\text{-prime})$ brane box model*, *JHEP* **09** (1999) 011, [[hep-th/9906031](#)].
- [65] B. Feng, A. Hanany and Y.-H. He, *D-brane gauge theories from toric singularities and toric duality*, *Nucl. Phys. B* **595** (2001) 165–200, [[hep-th/0003085](#)].
- [66] I. de Medeiros Varzielas, S. F. King and G. G. Ross, *Tri-bimaximal neutrino mixing from discrete subgroups of $SU(3)$ and $SO(3)$ family symmetry*, *Phys. Lett. B* **644** (2007) 153–157, [[hep-ph/0512313](#)].
- [67] C. Luhn, S. Nasri and P. Ramond, *The Flavor group $\Delta(3n^2)$* , *J. Math. Phys.* **48** (2007) 073501, [[hep-th/0701188](#)].
- [68] J. A. Escobar and C. Luhn, *The Flavor Group $\Delta(6n^2)$* , *J. Math. Phys.* **50** (2009) 013524, [[0809.0639](#)].
- [69] C. Luhn, *Spontaneous breaking of $SU(3)$ to finite family symmetries: a pedestrian's approach*, *JHEP* **03** (2011) 108, [[1101.2417](#)].
- [70] C. Hagedorn, A. Meroni and L. Vitale, *Mixing patterns from the groups $\Sigma(n\phi)$* , *J. Phys. A* **47** (2014) 055201, [[1307.5308](#)].
- [71] S.-T. Yau, S. S.-T. Yau and Y. Yu, *Gorenstein quotient singularities in dimension three*, vol. 505. American Mathematical Soc., 1993, [10.1090/memo/0505](#).
- [72] J. Serrano, *Finite subgroups of $sl(2, c)$ and $sl(3, c)$* , Notes, Warwick (2014), [<https://homepages.warwick.ac.uk/~masda/McKay/CarrascoProject.pdf>].
- [73] D. Jurciukonis and L. Lavoura, *GAP listing of the finite subgroups of $U(3)$ of order smaller than 2000*, *PTEP* **2017** (2017) 053A03, [[1702.00005](#)].
- [74] K.-i. Watanabe and D. Rotillon, *Invariant subrings of $\mathbb{C}[x, y, z]$ which are complete intersections*, *manuscripta mathematica* **39** (1982) 339–357.
- [75] J. J. Heckman, D. R. Morrison and C. Vafa, *On the Classification of 6D SCFTs and Generalized ADE Orbifolds*, *JHEP* **05** (2014) 028, [[1312.5746](#)].
- [76] J. J. Heckman, D. R. Morrison, T. Rudelius and C. Vafa, *Atomic Classification of 6D SCFTs*, *Fortsch. Phys.* **63** (2015) 468–530, [[1502.05405](#)].
- [77] J. J. Heckman and T. Rudelius, *Top Down Approach to 6D SCFTs*, *J. Phys. A* **52** (2019) 093001, [[1805.06467](#)].
- [78] L. Bhardwaj, *Revisiting the classifications of 6d SCFTs and LSTs*, *JHEP* **03** (2020) 171, [[1903.10503](#)].
- [79] K. Ohmori, H. Shimizu, Y. Tachikawa and K. Yonekura, *6d $\mathcal{N} = (1, 0)$ theories on S^1/T^2 and class S theories: part II*, *JHEP* **12** (2015) 131, [[1508.00915](#)].
- [80] D. R. Morrison, S. Schafer-Nameki and B. Willett, *Higher-Form Symmetries in 5d*, *JHEP* **09** (2020) 024, [[2005.12296](#)].

- [81] L. Bhardwaj and S. Schäfer-Nameki, *Higher-form symmetries of 6d and 5d theories*, *JHEP* **02** (2021) 159, [2008.09600].
- [82] F. Apruzzi, F. Bonetti, I. n. G. Etzebarria, S. S. Hosseini and S. Schafer-Nameki, *Symmetry TFTs from String Theory*, 2112.02092.
- [83] F. Apruzzi, L. Bhardwaj, J. Oh and S. Schafer-Nameki, *The Global Form of Flavor Symmetries and 2-Group Symmetries in 5d SCFTs*, 2105.08724.
- [84] Y. Ito and M. Reid, *The McKay correspondence for finite subgroups of $SL(3, C)$* , [alg-geom/9411010](https://arxiv.org/abs/alg-geom/9411010).
- [85] V. I. Danilov, *The geometry of toric varieties*, *Russian Mathematical Surveys* **33** (1978) 97.
- [86] W. Fulton, *Introduction to toric varieties*. No. 131. Princeton University Press, 1993, <https://doi.org/10.1515/9781400882526>.
- [87] D. A. Cox, J. B. Little and H. K. Schenck, *Toric varieties*. American Mathematical Soc., 2011, <http://dx.doi.org/10.1090/gsm/124>.
- [88] C. Lawrie and S. Schafer-Nameki, *The Tate Form on Steroids: Resolution and Higher Codimension Fibers*, *JHEP* **04** (2013) 061, [1212.2949].
- [89] M. Caibar, *Minimal models of canonical singularities and their cohomology*. PhD thesis, Ph. D. thesis, University of Warwick, 1999. <https://people.math.osu.edu/caibar.1/teza.pdf>.
- [90] M. Caibar, *Minimal models of canonical 3-fold singularities and their betti numbers*, *International Mathematics Research Notices* **2005** (2005) 1563–1581.
- [91] A. Grassi and D. R. Morrison, *Anomalies and the Euler characteristic of elliptic Calabi-Yau threefolds*, *Commun. Num. Theor. Phys.* **6** (2012) 51–127, [1109.0042].
- [92] F. Benini, S. Benvenuti and Y. Tachikawa, *Webs of five-branes and $N=2$ superconformal field theories*, *JHEP* **09** (2009) 052, [0906.0359].
- [93] F. Benini, Y. Tachikawa and D. Xie, *Mirrors of 3d Sicilian theories*, *JHEP* **09** (2010) 063, [1007.0992].
- [94] D. S. Park, *Anomaly Equations and Intersection Theory*, *JHEP* **01** (2012) 093, [1111.2351].
- [95] P. S. Aspinwall, S. H. Katz and D. R. Morrison, *Lie groups, Calabi-Yau threefolds, and F theory*, *Adv. Theor. Math. Phys.* **4** (2000) 95–126, [[hep-th/0002012](https://arxiv.org/abs/hep-th/0002012)].
- [96] Y. Ito and H. Nakajima, *Mckay correspondence and hilbert schemes in dimension three*, *Topology* **39** (2000) 1155–1191, [[arXiv:math/9803120](https://arxiv.org/abs/math/9803120)].
- [97] T. Bridgeland, A. King and M. Reid, *The McKay correspondence as an equivalence of derived categories*, *J. Am. Math. Soc.* **14** (2001) 535–554.
- [98] X. L. Hu, N. Jing and W. X. Cai, *Generalized mckay quivers of rank three*, *Acta Mathematica Sinica, English Series* **29** (Mar, 2013) 1351–1368.
- [99] F. Butin and G. S. Perets, *Branching law for finite subgroups of $sl(3, c)$ and mckay correspondence*, *Journal of Group Theory* **17** (2014) 191–251.
- [100] B. Acharya, N. Lambert, M. Najjar, E. E. Svanes and J. Tian, *Gauging Discrete Symmetries of T_N -theories in Five Dimensions*, 2110.14441.
- [101] D. R. Morrison and T. Rudelius, *F-theory and Unpaired Tensors in 6D SCFTs and LSTs*, *Fortsch. Phys.* **64** (2016) 645–656, [1605.08045].

- [102] A. N. de Celis, *Dihedral g -hlib via representations of the mckay quiver*, *Proceedings of the Japan Academy, Series A, Mathematical Sciences* **88** (2012) 78–83.
- [103] Á. N. de Celis, *On reid's recipe for non abelian groups*, [2109.10039](#).
- [104] D. R. Morrison and W. Taylor, *Toric bases for 6D F-theory models*, *Fortsch. Phys.* **60** (2012) 1187–1216, [[1204.0283](#)].
- [105] D. Markushevich, *Resolution of c^3/h_{168}* , *Mathematische Annalen* **308** (Jun, 1997) 279–289.