GCNSCHEDULER: SCHEDULING DISTRIBUTED COMPUTING APPLICATIONS USING GRAPH CONVOLUTIONAL NETWORKS

Mehrdad Kiamari and Bhaskar Krishnamachari

Electrical and Computer Engineering Department,
Viterbi School of Engineering,
University of Southern California, Los Angeles, USA
{kiamari, bkrishna}@usc.edu

ABSTRACT

We consider the classical problem of scheduling task graphs corresponding to complex applications on distributed computing systems. A number of heuristics have been previously proposed to optimize task scheduling with respect to metrics such as makespan and throughput. However, they tend to be slow to run, particularly for larger problem instances, limiting their applicability in more dynamic systems. Motivated by the goal of solving these problems more rapidly, we propose, for the first time, a graph convolutional network-based scheduler (GCN-Scheduler). By carefully integrating an inter-task data dependency structure with network settings into an input graph and feeding it to an appropriate GCN, the GCNScheduler can efficiently schedule tasks of complex applications for a given objective. We evaluate our scheme with baselines through simulations. We show that not only can our scheme quickly and efficiently learn from existing scheduling schemes, but also it can easily be applied to large-scale settings where current scheduling schemes fail to handle. We show that it achieves better makespan than the classic HEFT algorithm, and almost the same throughput as throughput-oriented HEFT (TP-HEFT), while providing several orders of magnitude faster scheduling times in both cases. For example, for makespan minimization, GCNScheduler schedules 50-node task graphs in about 4 milliseconds while HEFT takes more than 1500 seconds; and for throughput maximization, GCNScheduler schedules 100-node task graphs in about 3.3 milliseconds, compared to about 6.9 seconds for TP-HEFT.

1 INTRODUCTION

Successfully running complex graph-based applications, ranging from edge-cloud processing in IoT systems Cheng et al. (2019)-Kaur et al. (2018) to processing astronomical observations Garcia-Piquer, A. et al. (2017), heavily relies on executing all sub-components of such applications through an efficient task-scheduling. Not only does efficient task scheduling play a crucial role in improving the utilization of computing resources and reducing the required time to executing tasks, it can also lead to significant profits to service providers Barroso et al. (2013). In this framework, any application consists of multiple tasks with a given inter-task data dependency structure, i.e. each task generates inputs for certain other tasks. Such dependencies can be expressed via a directed acyclic graph (DAG), also known as *task graph*, where vertices and edges represent tasks and inter-task data dependencies, respectively. An input job for an application is completed once all the tasks are executed by compute machines according to the inter-task dependencies.

There are two commonly used metrics for schedulers to optimize: makespan and throughput. The required time to complete all tasks for a single input is called the makespan. The maximum steady state rate at which inputs can be processed in a pipelined manner is called throughput. Makespan minimization and throughput maximization can each be achieved through relevant *task-scheduling* algorithms that assign tasks to appropriate distributed computing resources to be executed.

The underlying methodology for task scheduling can be categorized into heuristic-based (e.g. Eskandari et al. (2018)- Pham et al. (2017)), meta-heuristic ones (e.g. Kennedy & Eberhart (1997), Addya et al. (2017)-Fan et al. (2013), Shishido et al. (2018), Dasgupta et al. (2013), Izadkhah & Li (2019)), and optimization-based schemes (e.g. Azar & Epstein (2005)-Skutella (2001)).

One of the most well-known heuristic scheduling schemes for makespan minimization is the heterogeneous earliest-finish time (HEFT) algorithm Topcuoglu et al. (2002), which will be considered as one of our benchmarks. For throughput maximization, we benchmark against the algorithm presented in Gallet et al. (2009) which we refer to as TP-HEFT.

One of the fundamental disadvantages of all the above-mentioned scheduling schemes is that they work well only in relatively small settings; once a task graph becomes large or extremely large, they require very long computation times. We anticipate that applications in many domains, such as IoT for smart cities will result in increasingly complex applications with numerous inter-dependent tasks, and scheduling may need to be repeated quite frequently in the presence of network or resource dynamics Dustdar et al. (2017); Syed et al. (2021). Therefore, it is essential to design a faster method to schedule tasks for such large-scale task graphs.

A promising alternative is to apply machine learning techniques for function approximation to this problem, leveraging the fact that scheduling essentially has to do with finding a function mapping tasks to compute machines. Given the graph structure of applications, we propose to use an appropriate graph convolutional network (GCN) Kipf & Welling (2017) to schedule tasks through learning the inter-task dependencies of the task graph as well as network settings (i.e., execution speed of compute machines and communication bandwidth across machines) in order to extract the relationship between different entities. The GCN has attracted significant attention in the literature for its ability in addressing many graph-based applications to perform semi-supervised link prediction Zhang & Chen (2018) and node classification Kipf & Welling (2017). The idea behind GCN is to construct node embeddings layer by layer. In each layer, a node embedding is achieved by aggregating its neighbors' embeddings, followed by a neural network (i.e. a linear transformations and nonlinear activation). In case of node classification, the last layer embedding is given to a softmax operator to predict node labels, and consequently the parameters of GCN can be learned in an end-to-end manner. In general, there are two types of GCNs, namely spectral-based GCNs Defferrard et al. (2016) and special-based ones Hamilton et al. (2017). To obtain node embedding, the former requires matrix decomposition of Laplacian matrix (which results in scalability issues due to non-linear computation complexity of the decomposition) while the latter does not have such complexity thanks to the idea of message-passing.

To the best of our knowledge, there is no prior work that has proposed a pure *spatial-based* GCN, incorporated with carefully-designed the features of both nodes and edges for task graphs, to perform scheduling over distributed computing systems.

The main contributions of this paper are as follows:

- We propose GCNScheduler, which can quickly schedules tasks by carefully integrating a task graph with network settings into a single input graph and feeding it to an appropriate GCN model.
- Any existing scheduling algorithm can be used as a teacher to train GCNScheduler, for any metric. We illustrate this by training GCNScheduler using HEFT Topcuoglu et al. (2002) for makespan minimization, and TP-HEFT Gallet et al. (2009) for throughput maximization.
- We evaluate the performance of our proposed scheme and show that, not only can our GCNScheduler be trained in a very short period of time¹, it also gives scheduling performance comparable to the teacher algorithm. We show our approach gives comparable or better scheduling performance in terms of makespan with respect to HEFT and throughput with respect to TP-HEFT, respectively.
- We show that GCNScheduler is several orders of magnitude faster than previous heuristic algorithms in obtaining the schedule for a given task graph. For example, for makespan minimization, GCNScheduler schedules 50-node task graphs in about 4 milliseconds while HEFT takes more than 1500 seconds; and for throughput maximization, GCNScheduler

¹For instance, it takes around <15 seconds to train a graph with 8,000 nodes.

schedules 100-node task graphs in about 3.3 milliseconds, compared to about 6.9 seconds for TP-HEFT.

- We show that GCNScheduler is able to efficiently perform scheduling for *any size* task graph. In particular, we show that our proposed scheme is able to operate over large-scale task graphs where existing schemes require excessive computational resources.

1.1 RELATED WORK

Task scheduling can be categorized into multiple groups from different perspectives. One way of categorizing task scheduling schemes has to do with the type of algorithms used for assigning tasks to compute resources. Heuristic, meta-heuristic, and optimization-based are three categories of task scheduling schemes. Heuristic task scheduling schemes can be divided into quite a few sub categories based on their approach, such as load balancing Ren et al. (2012), Bhatia et al. (2012), Kumar & Sharma (2017), priority-based scheduling Topcuoglu et al. (2002), Sudarsan & Ribbens (2016), Dubey et al. (2015), Chrétienne et al. (1995), task duplication Ishfaq Ahmad & Yu-Kwong Kwok (1998), and clustering Palis et al. (1996).

Since heuristic algorithms may sometimes perform poorly compared to optimal task scheduling, meta-heuristic (e.g. Particle Swarm Optimization Kennedy & Eberhart (1997), Simulated Annealing Addya et al. (2017)-Fan et al. (2013), Genetic-based approach Shishido et al. (2018), Dasgupta et al. (2013), Izadkhah & Li (2019)) and optimization-based schemes (e.g. Azar & Epstein (2005)-Skutella (2001)), which aim at approximating the NP-hard optimization of task scheduling, have attracted significant attention. However, all the above-mentioned heuristic, meta-heuristic and optimization-based schemes tend to run extremely slowly as number of tasks becomes large due to iterative nature of these methods, which requires excessive computations. Moreover, this issue makes the aforementioned schemes unable to handle large-scale task graphs.

As obtaining the optimal scheduler is basically the same as finding an appropriate mapper function, which maps tasks to compute machines, machine-learning based scheduling has begun emerging as an alternative thanks to advances in fundamental learning methods, such as deep learning Goodfellow et al. (2016) and reinforcement learning (RL) Sutton & Barto (2018). Sun *et. al.* proposed DeepWave Sun et al. (2020), a scheduler which reduces job completion time using RL while specifying a priority list² as the action and the completion time of a job DAG as the reward. Furthermore, Decima Mao et al. (2019) schedules tasks over a spark cluster by training a neural network using RL with scheduling the next task for execution as the action and a high-level scheduling objective of minimizing the makespan as the reward. The aforementioned RL-based schemes suffer from having a huge action space (i.e., the space of scheduling decisions).

While Decima Mao et al. (2019) only operates in homogeneous environment, Luo *et. al.* proposed Lachesis Luo et al. (2021) to operate over heterogeneous environment. Lachesis combines three different components, a GCN, an RL policy network, and a heuristic task mapper. There are three main differences from our work with respect to their use of GCN: first, they use the GCN to embed task nodes only without taking network settings into account as we do; second, they use a regular GCN which does not explicitly account for directed nodes while we use an EDGNN Jaume et al. (2019) which does; and finally, the GCN in Lachesis does not do scheduling (only task node embedding), whereas we are the first to propose to use a GCN directly for task scheduling.

The remaining of the paper is organized as follows: In the next section, we elaborate upon the problem formulation. In section 3, we overview GCNs and explain in detail on how our proposed scheme works. Finally, in section 4, we show the numerical results on the performance of our proposed scheme against well-known approaches.

2 PROBLEM STATEMENTS

We now elaborate upon formally representing the minimization of makespan and the maximization of throughput as optimization problems. Every application/job is comprised of inter-task data dependencies. In order to finish a job, all its tasks require to be executed at least on a single compute

²Which indicates the scheduling priority of edges in a job DAG.

machine. As far as compute machines are concerned, they are interconnected via communication links.

Before expressing the definition of makespan and throughput, let us explain about task dependencies, referred to as *task graph*, and network settings.

Task Graph: Since there are dependencies across different tasks, meaning that a task generates inputs for certain other tasks, we can model this dependency through a *DAG* as depicted in Fig. 1. Suppose we have N_T tasks $\{T_i\}_{i=1}^{N_T}$ with a given task graph $G_{Task} := (V_{Task}, E_{Task})$ where $V_{Task} := \{T_i\}_{i=1}^{N_T}$ and $E_{Task} := \{e_{i,i'}\}_{(i,i') \in \Omega}$ respectively represent the set of vertices and edges (task dependencies) with $\Omega := \{(i, i') \mid \text{if task } T_i \text{ generates inputs for task } T_{i'}\}$. Let us define vector $\mathbf{p} := [p_1, \dots, p_{N_T}]^T$ as the amount of computations required by tasks. For every tasks T_i and T_j , $\forall i, j$ where $e_{i,j} \in E_{Task}$, task T_i produces $d_{i,j}$ amount of data for task T_j after being executed by a machine.

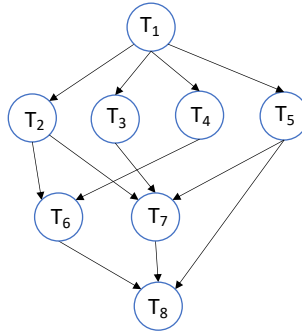

Figure 1: An example of task graph, which is in the form of a DAG, with eight tasks. For instance, task T_7 requires tasks T_2 , T_3 , and T_5 to be first executed and generate their outputs before executing task T_7 .

Network Settings: Each task is required to be executed on a *compute* node (machine) which is connected to other compute nodes (machines) through communication links (compute node and machine are interchangeably used in this paper). Let us suppose to have N_C compute nodes $\{C_j\}_{j=1}^{N_C}$. Regarding the execution speed of compute nodes, we consider vector $\mathbf{e} := [e_1, \dots, e_{N_C}]^T$ as the executing speed of machines. The communication link delay between any two compute nodes can be characterized by bandwidth. Let us denote $B_{i,j}$ as the communication bandwidth of the link from compute node C_i to compute node C_j . In case of two machines not being connected to each other, we can assume the corresponding bandwidth is zero (infinite time for communication delay).

In general, a task-scheduling scheme maps tasks to compute nodes according to a given objective. Formally speaking, a task scheduler can be represented as a function $m(\cdot) : V_{Task} \rightarrow \{C_k\}_{k=1}^{N_C}$ where task T_i , $\forall i$, is assigned to machine $m(i)$. We next present two well-known objectives, namely the makespan-minimization and the throughput-maximization.

Objective 1: The first objective function for the task assignment we consider is the makespan-minimization. In particular, we need to find a scheduler that assigns tasks to compute machines such that the resulting makespan is minimized. Our proposed scheme aims at obtaining such scheduler by utilizing a carefully-designed GCN where it is able to classify tasks into machines³.

Before formally defining the *makespan*, we need to define *Earliest Start Time (EST)*, *Earliest Finish Time (EFT)*, *Actual Start Time (AST)*, and *Actual Finish Time (AFT)* as follows:

Definition 1: $EST(T_i, C_j)$ denotes the earliest execution start time for task T_i being executed on compute node C_j . Note that $EST(T_0, C_j) = 0, \forall j$.

Definition 2: $EFT(T_i, C_j)$ denotes the earliest execution finish time for task T_i being executed on compute node C_j .

³Each machine represents a class in our problem.

Definition 3: $AST(T_i)$ and $AFT(T_i)$ denote the actual start time and the actual finish time of task T_i .

Regarding the computations of the aforementioned definitions for each task, one can recursively compute them starting from task T_1 according to the following formula Topcuoglu et al. (2002):

$$\begin{aligned} EST(T_i, C_j) &= \max\{avail[j], \max_{T_k: e_k, i \in ET_{ask}} (AFT(T_k) + comm_{k,i})\}, \\ EFT(T_i, C_j) &= EST(T_i, C_j) + \frac{p_i}{e_j}, \end{aligned} \quad (1)$$

where $comm_{i,j} := \frac{data_{i,j}}{B_{m(T_i), m(T_j)}}$ and $avail[j]$ indicate the earliest time at which compute node C_j is ready to execute a task.

Definition 4 (Makespan): After all tasks are assigned to compute nodes for execution, the actual time for completion of a job is equal to the actual finish time of the last task. Therefore, the makespan can be represented as

$$makespan = \max\{AFT(T_{N_T})\}. \quad (2)$$

Objective 2: The second objective function that we consider for task-scheduling is the throughput maximization. Unlike makespan which is the overall execution time for a given input, the throughput stands for the average number of inputs that can be executed per unit-time in steady state. By assuming the number of inputs to be infinite and denoting $N(t)$ as the number of inputs completely executed by a scheduler at time t , the throughput would be $\lim_{t \rightarrow \infty} \frac{N(t)}{t}$. In Gallet et al. (2009), authors showed that the following definition characterize the throughput of a scheduler.

Definition 5 (Throughput Gallet et al. (2009)): For a given task-assignment, the throughput of a scheduler is $1/\tau$ where τ is the time taken by any resource to execute an input, and it can be written as

$$\tau := \max\{\max_{C_q} \{t_q^{comp}, t_q^{out}, t_q^{in}\}, \max_{C_q \rightarrow C_r} t_{q,r}\}, \quad (3)$$

with

- t_q^{comp} : representing the computation time of compute machine C_q for a single input (i.e. $t_q^{comp} = \frac{\sum_{i: m(T_i)=C_q} p_i}{e_q}$),
- t_q^{out} : representing the time taken by compute machine C_q for outgoing interface (i.e. $t_q^{out} = \frac{\sum_r d_{q,r}^{(node)}}{B_q^{out}}$ where $d_{q,r}^{(node)}$ and B_q^{out} respectively indicate amount of data transferred from compute machine C_q to C_r and maximum outgoing bandwidth of compute machine C_q),
- t_q^{in} : representing the time taken by compute machine C_q for incoming interface (i.e. $t_q^{in} = \frac{\sum_r d_{r,q}^{(node)}}{B_q^{in}}$ where B_q^{in} indicates the maximum incoming bandwidth of compute machine C_q),
- $t_{q,r}$: representing the communication time taken to transfer data from compute machine C_q to compute machine C_r (i.e. $t_{q,r} = d_{q,r}^{(node)} / B_{q,r}$).

Remark: other objectives could also be considered in the future.

3 PROPOSED GCNSCHEDULER

We present a novel machine-learning based task scheduler which can be trained with respect to aforementioned objectives. Since the nature of task-scheduling problem has to do with graphs (i.e. task graph), it is essential to utilize a machine-learning approach designed for capturing the underlying graph-based relationships of the task-scheduling problem. To do so, we employ a suitable GCNJaume et al. (2019), in order to obtain a model which can automatically assign tasks to compute machines. We need to point out there is no prior GCN-based scheduling scheme incorporated with both carefully-designed features of nodes and edges. This novel idea has significant advantages

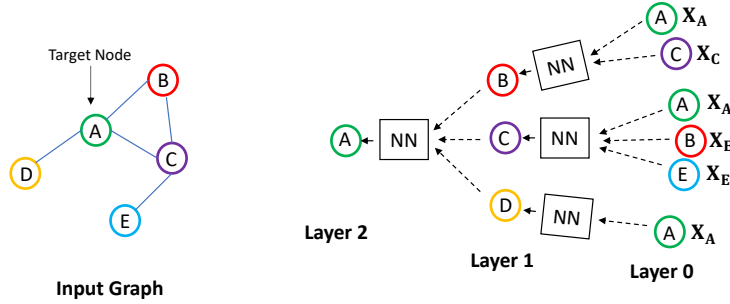

Figure 2: An illustration of message-passing for the input graph shown on the left side. Regarding the notation, X_A represents node A’s feature. Each square box indicates a deep neural network and arrows shows the average messages from neighbors.

over the conventional scheduling schemes. First, it can remarkably reduce the computational complexity compared to previous scheduling algorithms. Second, after training an appropriate GCN, our scheme can handle any large-scale task graph while conventional schemes severely suffer from the scalability issue.

3.1 OVERVIEW OF GRAPH NEURAL NETWORKS

Conceptually speaking, the idea of GCN is closely related to neighborhood-aggregation encoder algorithm Hamilton et al. (2018). However, instead of aggregating information from neighbors, the intuition behind GCNs is to view graphs from the perspective of *message passing* algorithm between nodes Scarselli et al. (2009). An illustration of message passing is depicted in Fig. 2. In the GCN framework, every node is initialized with an embedding which is the same as its feature vector. At each layer of the GCN algorithm, nodes take the average of neighbor messages and apply a neural network on that as follows

$$\mathbf{h}_v^{(t)} = \sigma(\mathbf{W}_1^{(t)} \mathbf{h}_v^{(t-1)} + \mathbf{W}_2^{(t)} \sum_{u:u \in \mathcal{N}(v)} \mathbf{h}_u^{(t-1)}), \quad (4)$$

where $\mathbf{h}_v^{(t)}$, $\mathbf{W}_1^{(t)}$, $\mathbf{W}_2^{(t)}$, and σ respectively represent the hidden vector of node v at layer t , weight matrix at layer t for self node, weight matrix at layer t for neighboring nodes, and a non-linear function (e.g. ReLU). Furthermore, $\mathcal{N}(v)$ indicates the neighbors of node v . After K -layers of neighborhood aggregation, we get output embedding for each node. We can use these embeddings along with any loss function and running stochastic gradient descent to train GCN model parameters.

The above scheme is suitable for undirected graphs where edges show reciprocal relationship between ending nodes.

3.2 OVERVIEW OF GCNS FOR DIRECTED GRAPHS

In real applications such as social media where relations between nodes are not reciprocal, using regular GCN-based schemes might not be useful. An alternative for this type of situations is to utilize schemes designed for directed graphs such as EDGNN Jaume et al. (2019) where incoming and outgoing edges are treated differently in order to capture nonreciprocal relationship between nodes. In other words, EDGNN considers different weights for outgoing and incoming edges in addition to weights set for neighboring nodes. In particular, the embedding of node v would be as

follows:

$$\begin{aligned}
\mathbf{h}_{n,v}^{(t)} &= \sigma(\mathbf{W}_1^{(t)} \mathbf{h}_{n,v}^{(t-1)} + \mathbf{W}_2^{(t)} \sum_{u:u \in \mathcal{N}(v)} \mathbf{h}_{n,u}^{(t-1)} \\
&\quad + \mathbf{W}_3^{(t)} \sum_{u:e_{u,v} \in E_{Task}} \mathbf{h}_{e,(u,v)}^{(t-1)} \\
&\quad + \mathbf{W}_4^{(t)} \sum_{u:e_{v,u} \in E_{Task}} \mathbf{h}_{e,(v,u)}^{(t-1)}),
\end{aligned} \tag{5}$$

where $\mathbf{W}_1^{(t)}$, $\mathbf{W}_2^{(t)}$, $\mathbf{W}_3^{(t)}$, and $\mathbf{W}_4^{(t)}$ represent weight matrices of layer t for embedding of self node, neighboring nodes, incoming edges, and outgoing edges, respectively. Moreover, $\mathbf{h}_{n,v}^{(t)}$ and $\mathbf{h}_{e,(u,v)}^{(t)}$ respectively denote embedding of node v and the embedding of the edge from node u to node v at layer t .

3.3 PROPOSED INPUT GRAPH

In order to train an EDGNN-based model, we need to carefully design the input graph components, namely adjacency matrix, nodes' features, edges' features, and labels. It should be noted that our scheme is not tailored to a particular criterion as we will show later that it can learn from two scheduling schemes with different objectives. Our designed input graph can be fed into the EDGNN and the model will be trained according to labels generated from a given scheduling scheme. We next explain how we carefully design the input graph.

Designed Input Graph: We start from the original task graph and consider the same set of nodes and edges for our input graph as the task graph. In other words, by representing the input graph as $G_{input} := (V_{input}, E_{input})$, we have $V_{input} := V_{Task}$ and $E_{input} := E_{Task}$. The crucial part for having an efficacious GCN-based scheduler has to do with carefully designing the features of nodes and edges as well as the labels.

- The feature of node $T_i, \forall T_i \in V_{input}$, is denoted by $\mathbf{x}_{n,i}$ and it has the following N_C -dimension features:

$$\mathbf{x}_{n,i} := \left(\frac{p_i}{e_1}, \frac{p_i}{e_2}, \dots, \frac{p_i}{e_{N_C}} \right)^T \in \mathbb{R}^{N_C}.$$

The intuition behind $\mathbf{x}_{n,i}$ is that these features represent the required computational time of task T_i across all compute machines.

- The feature of edge $e_{u,v}, \forall e_{u,v} \in E_{input}$, is denoted by $\mathbf{x}_{e,(u,v)}$ and it has the following N_C^2 -dimension features:

$$\mathbf{x}_{e,(u,v)} := \left(\frac{d_{u,v}}{B_{1,1}}, \frac{d_{u,v}}{B_{1,2}}, \dots, \frac{d_{u,v}}{B_{N_C,N_C}} \right)^T \in \mathbb{R}^{N_C^2}.$$

The intuition behind $\mathbf{x}_{e,(u,v)}$ is that these features represent the required time for transferring the result of executing task T_u to the following task T_v across all possible pair-wise compute machines. An illustration of our designed input graph for the task graph of Fig. 1 is depicted in Fig. 3.

Objective-Dependent Labeling: Based on what task scheduler our method should learn from (which we refer to as the ‘‘teacher’’ scheduler, namely, HEFT for makespan minimization and TP-HEFT for throughput maximization), we label all nodes as well as edges. Let us define $L_{n,v}$ and $L_{e,(u,v)}$ as labels of node v and edge $e_{u,v}$, respectively. Regarding nodes' labeling, we consider the label of node $T_i, \forall i$, as the index of compute node that the teacher algorithm assigns task T_i to run on.

Thus, for makespan minimization, we have that: $L_{n,v} = m_{HEFT}(v) \forall v \in V_{input}$ where $m_{HEFT}(\cdot)$ is the mapper function of HEFT algorithm.

And for throughgput maximization, we have that:

$L_{n,v} = m_{TP-HEFT}(v) \forall v \in V_{input}$ where $m_{TP-HEFT}(\cdot)$ is the mapper function of the TP-HEFT algorithm.

Finally, we label each edge according to the label of the ending vertex it is from. In other words, $L_{e,(u,v)} = L_{n,u} \forall u, v$ such that $e_{u,v} \in E_{input}$. We should note that this edge-labeling is crucial in

enforcing the model to learn to label out-going edges of a node with same label as its corresponding node’s label.

3.4 IMPLEMENTATION

As far as the model parameters are concerned, we consider a 4-layer EDGCN with 128 nodes per layer with *ReLU* activation function and 0 dropout. Since we suppose nodes and edges have features, we let both nodes and edges to be embedded.

For training our model, we need to create a sufficiently large graph. However, since the HEFT and TP-HEFT algorithms are extremely slow in performing task-scheduling for large-scale task graphs, obtaining labels (i.e. determining the machine each task need to be executed on) for a single large graph is cumbersome. Therefore, we create a large graph G_{union} by taking the union of disjoint medium-size graphs G_i ’s (i.e., $G_{union} := \{G_i\}_{i=1}^{N_g}$) such that HEFT and TP-HEFT can handle scheduling tasks over each of them. Regarding splitting dataset, we consider 60%, 20%, and 20% of the disjoint graphs for training, validation, and test, respectively. This allows us to apply the teacher algorithms to train our GCNScheduler for even larger graphs than the teacher algorithms themselves can handle efficiently.

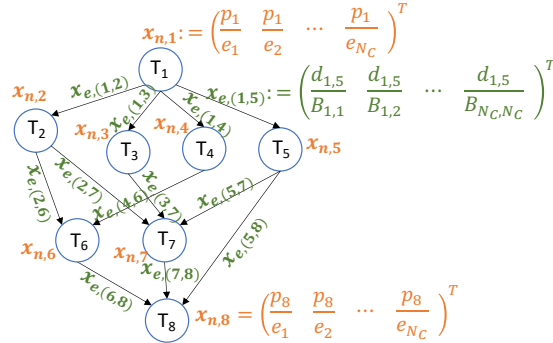

Figure 3: An illustration of designed input graph fed into the EDGNN model for the example of the task graph shown in Fig. 1. Node and edge features are represented with brown and green colors, respectively.

4 EXPERIMENTAL RESULTS

In this section, we evaluate the performance of our proposed GCNScheduler in terms of two criteria, namely the makespan minimization and the throughput maximization, for various task graphs (medium-scale and large-scale task graphs as well as the task graphs of three real perception applications considered in Ra et al. (2011)). For each criterion, we measure the performance of GCNScheduler as well as the time it takes to assign tasks and compare these values with the corresponding values of our benchmarks (i.e. HEFT/TP-HEFT and the random task-scheduler). We evaluate all schemes by running them on our local cluster which has 16 CPUs (with 8 cores and 2 threads per core) of Intel(R) Xeon(R) E5-2620 v4 @ 2.10GHz.

As far as network settings are concerned, the computation amount of tasks, the execution speed of compute machines, and the communication bandwidth are drawn randomly from uniform distributions. For simplicity, we assume each task produces the same amount of data after being executed. Regarding task graphs, we generate random DAGs in two different ways: 1) establishing an edge between any two tasks with a given probability (which we call *edge probability (EP)*), then pruning⁴ them such that it forms a DAG, 2) specifying the width and depth of the graph, then randomly selecting successive tasks for each task.

⁴Only keep edges between nodes u and v if $u < v$.

4.1 MAKESPAN MINIMIZATION

For training the model, since the teacher scheduler, i.e. the HEFT algorithm Topcuoglu et al. (2002), is extremely slow in generating labels for large task graphs⁵, we create sufficient number (approximately 400) of random medium-size task graphs (i.e. each has ≤ 50 nodes with either an $EP=0.25$ or a width and depth of 5 and 10, respectively) and label tasks for each of these medium-size task graphs according to the HEFT algorithm Topcuoglu et al. (2002). By doing so, we create a single large-scale graph which is the union of disjoint medium-size graphs. On the significance of our proposed scheme, it only takes < 15 seconds to train our model with such a large graph using just CPU’s (no GPU’s or other specialized hardware). After training the model, we consider both medium-scale and large-scale task graphs as input samples. Then our model labels the tasks and determines what machine will execute each task. We next measure the performance of GCNScheduler over medium-scale and large-scale task graphs as well as the task graphs of the three real perception applications provided in Ra et al. (2011).

4.1.1 MEDIUM-SCALE TASK GRAPHS

Fig. 4 shows the average makespan of GCNScheduler (with the makespan-minimization objective) compared to HEFT Topcuoglu et al. (2002) and the random task-scheduler for medium-size task graphs with different number of tasks. Our model significantly outperforms the random task-scheduler and considerably improves the makespan compared to HEFT, specially as number of tasks increases. The accuracy of GCNScheduler is around %75 with respect to replicating the schedules produced by HEFT; however, we should note that ultimately the makespan of executing all tasks is more important rather than the accuracy of labeling tasks, and in this regard GCNScheduler does better than HEFT. To gain some intuitive understanding for why GCNScheduler outperforms HEFT in terms of makespan, we manually examined and observed the schedules produced by GCNScheduler and HEFT for many scenarios. We found that the HEFT is sometimes unable to prevent assigning tasks to machines with poor communication bandwidth while GCNScheduler is able to learn to do so more consistently. We believe this is due to the carefully-designed features of edges in the input to GCNScheduler which explicitly take communication bandwidth between machines into account.

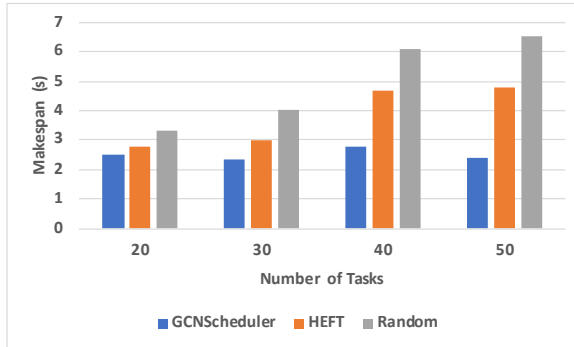

Figure 4: Makespan of GCNScheduler, HEFT Topcuoglu et al. (2002), and the random scheduler in small settings for different number of tasks with $EP = 0.25$.

The time taken to assign tasks to compute machines for both GCNScheduler and HEFT Topcuoglu et al. (2002) is presented in Table 1. As one can easily see, our GCNScheduler outperforms HEFT by 3-7 orders of magnitude. This clearly shows GCNScheduler is a game-changer for task scheduling.

4.1.2 LARGE-SCALE TASK GRAPHS

In addition to the promising results on the medium-size settings, we now focus on large-scale task graphs where HEFT algorithm Topcuoglu et al. (2002) is extremely slow to operate; hence we compare the performance of our GCNScheduler with only possible benchmark which is the random

⁵We observed that HEFT is incapable of conducting task-assignment running on a commodity PC when the task graph become large, on the order of 100 nodes, see table 1 for the increasing trend in compute time with task graph size.

Table 1: Time taken (in seconds) by GCNScheduler and HEFT to perform scheduling for medium-scale task graphs with different number of tasks.

	N_T			
	20	30	40	50
GCNSch.	0.0026	0.0027	0.0029	0.0037
HEFT	0.6764	9.4330	117.35	1552.0

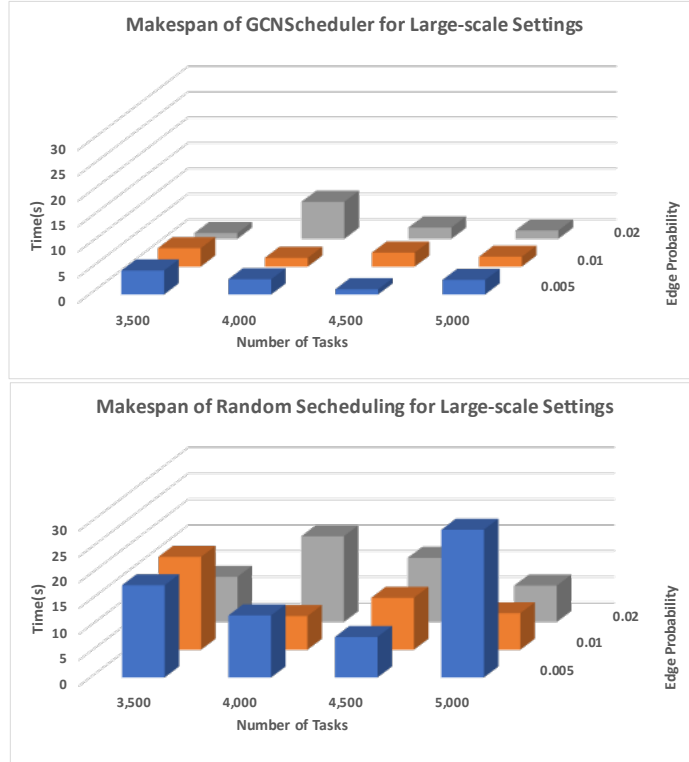

Figure 5: Makespan of GCNScheduler and the random scheduler for large-scale task graphs with different number of tasks and different EP .

task-scheduler. Fig. 5 shows the average makespan of our proposed GCNScheuler (top plot) and the random task-scheduler (bottom plot) in large-scale settings where number of tasks varies from 3,500 to 5,000 and the edge probability (i.e. EP) takes 0.005, 0.01, and 0.02. One can easily observe that our proposed GCNScheduler significantly reduces makespan by a factor of 8 (for larger EP). The intuition behind the significant gain for larger EP (i.e. node’s degrees are larger) is that some tasks may require more predecessor tasks to be executed in advance (because of having larger nodes’ degree), hence randomly assigning tasks may potentially assign one of the predecessor task to a machine with poor computing power or communication bandwidth, resulting in a larger average makespan. However, GCNScheuler efficiently exploits inter-task dependencies as well as network settings information (i.e. execution speed of machines and communication bandwidth across machines) through carefully-designed node and edge features; therefore it leads to a remarkably lower makespan.

Finally, Fig. 6 illustrates the inference time (i.e. time taken to assigning tasks to compute machines) of our proposed GCNScheduler for different number of tasks and different EP . Our GCNScheduler takes < 80 milliseconds to obtain labels for each of these large-scale task graphs. This clearly shows the great advantage of our proposed scheme which makes it an ideal alternative to state-of-the-art scheduling schemes which fail to efficiently operate over complicated jobs each of which may have thousands of tasks with any inter-task dependencies.

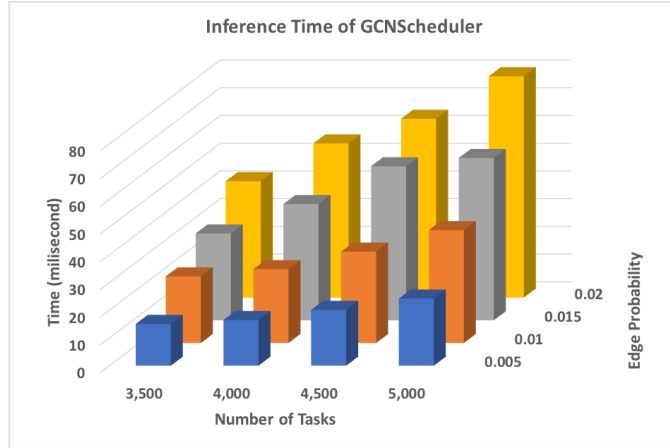

Figure 6: Inference time of our GCNScheduler for large-scale task graphs with different number of tasks and different EP .

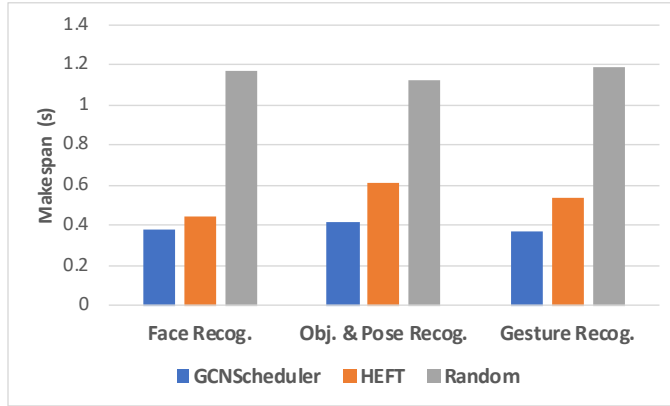

Figure 7: Makespan of GCNScheduler (with the makespan-minimization objective), HEFT, and the random task-scheduler for the three real perception applications considered in Ra et al. (2011).

4.1.3 REAL APPLICATION BENCHMARKS

To show the significance of our proposed scheme on real applications, we consider the three real perception applications provided in Ra et al. (2011), namely the face recognition, the object-and-pose recognition, and the gesture recognition with corresponding task graphs depicted in Fig. 8 (Please see Ra et al. (2011) for more detail regarding each task). We measure the makespan of each application by running GCNScheduler (with the makespan-minimization objective) over the carefully-designed input graphs (obtained from original task graphs). Fig. 7 illustrates the makespan of GCNScheduler (with the makespan-minimization objective) against HEFT Topcuoglu et al. (2002) and the random task-scheduler for the three perception applications. While our GCNScheduler leads to a slightly better makespan performance compared to HEFT Topcuoglu et al. (2002), it significantly

Table 2: Time taken (in **milliseconds**) by GCNScheduler and HEFT Topcuoglu et al. (2002) to perform scheduling for the task graph of the three real perception applications considered in Ra et al. (2011).

	Face Recog.	Pose Recog.	Gesture Recog.
GCNSch.	0.460	0.524	0.621
HEFT	227.7	1484	443.0

Table 3: Throughput of GCNScheduler (with the throughput-maximization objective), Throughput(TP)-HEFT algorithm, and the random task-scheduler for medium-size task graphs with different number of tasks.

	N_T			
	100	200	300	400
GCNSch.	3.1254	3.1251	3.1261	3.1185
TP-HEFT	2.1731	2.1690	1.8034	2.0046
Random	0.0193	0.01801	0.0174	0.0177

Table 4: Time taken (in seconds) by GCNScheduler (with the throughput-maximization objective) and TP-HEFT to schedule for medium-size task graphs with different number of tasks.

	N_T			
	100	200	300	400
GCNSch.	0.0033	0.0049	0.0071	0.0078
TP-HEFT	6.9235	27.229	70.940	115.221

(by 3-4 orders of magnitude) reduces the time taken to perform scheduling as it is shown in Table 2. This remarkable time reduction demonstrates the importance of our scheme to other applications (in business or security) used/built upon these perception applications.

4.2 THROUGHPUT MAXIMIZATION

For the purpose of maximizing the throughput, we use the TP-HEFT algorithm Gallet et al. (2009) as the teacher scheduler for training our GCNScheduler. Since the TP-HEFT scheduler Gallet et al. (2009), similar to the HEFT algorithm Topcuoglu et al. (2002), excessively becomes slow in generating labels for large task graphs, we create sufficient number of random medium-size task graphs (i.e. each of which has around 40 tasks with the width and depth of 5 and 8, respectively) and label tasks according to the TP-HEFT algorithm Gallet et al. (2009). We then build a single large-scale graph, which is the union of disjoint medium-size graphs, and train GCNScheduler with the throughput-maximization objective. Similarly, we test our GCNScheduler over medium-scale and large-scale task graphs as well as the task graph of the three perception applications.

4.2.1 MEDIUM-SCALE TASK GRAPHS

Table 3 shows the throughput of GCNScheduler (with the throughput-maximization objective) compared to TP-HEFT Gallet et al. (2009) and the random task-schedulers for medium-size task graphs with different number of tasks. GCNScheduler leads to slightly higher throughput compared to TP-HEFT Gallet et al. (2009) scheduler, while it significantly outperforms random task-scheduler. Table 4 also shows the time taken to schedule tasks. Moreover, the accuracy of our model is around %95.

4.2.2 LARGE-SCALE TASK GRAPHS

Since TP-HEFT Gallet et al. (2009) and other existing scheduling schemes are extremely slow for very large task graphs (e.g. task graphs with few thousands tasks), we only compare the throughput of SCNScheduler against the random task-scheduler, as shown in Table 5. Further, Table 6 shows the time taken for assigning tasks to compute nodes for large-scale task graphs. One can easily see GCNScheduler (with the throughput-maximization objective) is remarkably fast while handling large-scale task graphs.

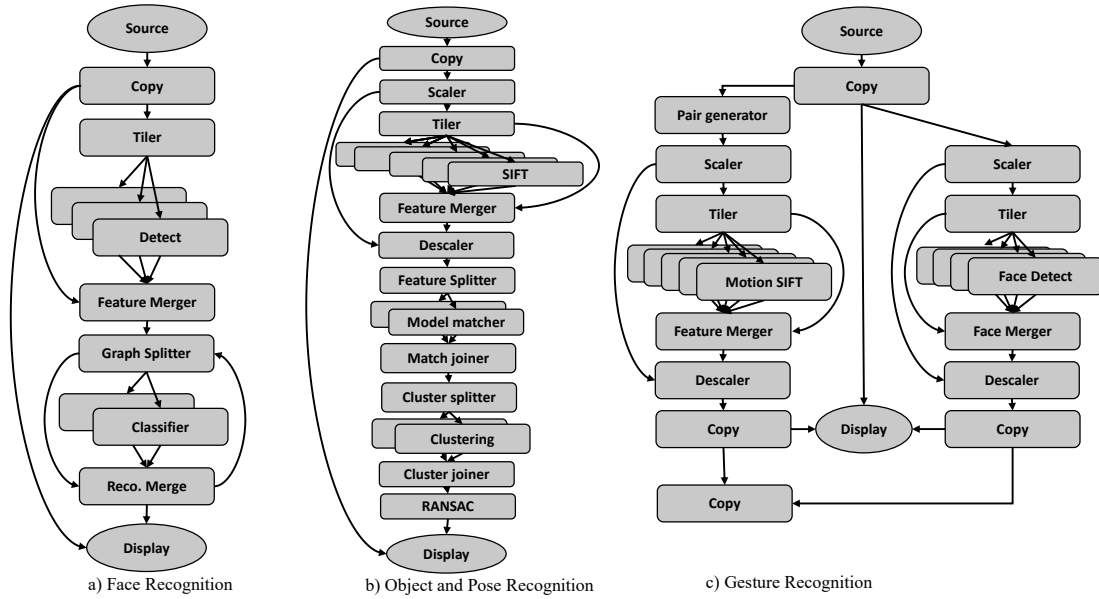

Figure 8: Task graphs of the three perception application considered in Ra et al. (2011).

Table 5: Throughput of GCNScheduler (with the throughput-maximization objective) and the random task-scheduler for large-scale task graphs.

	N_T			
	3,500	4,000	4,500	5,000
GCNSch.	2.9737	2.9731	2.9733	2.9734
Random	0.6344	0.6336	0.6332	0.6331

Table 6: Time taken (in **milliseconds**) by GCNScheduler (with throughput objective) to schedule.

	N_T			
	3,500	4,000	4,500	5,000
GCNSch.	66.050	74.978	83.817	87.388

Table 7: Time taken (in **milliseconds**) by GCNScheduler (with the throughput-maximization objective) and TP-HEFT to perform scheduling for the task graph of the three real perception applications.

	Face Recog.	Pose Recog.	Gesture Recog.
GCNSch.	0.488	0.511	0.560
TP-HEFT	87.34	257.8	290.1

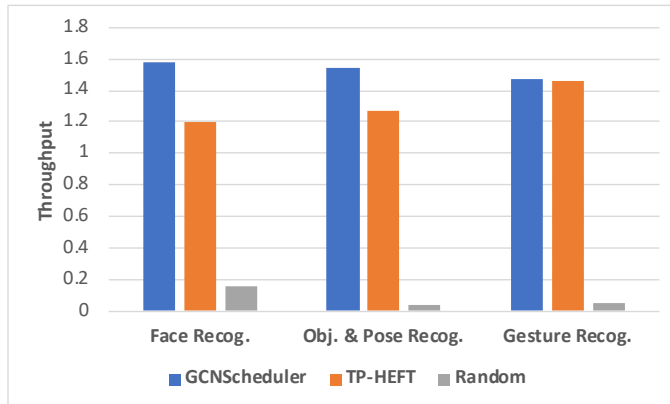

Figure 9: Throughput of GCNScheduler (with throughput objective), TP-HEFT, and random scheduler for the task graph of the three real perception applications.

4.2.3 REAL APPLICATION BENCHMARKS

We now evaluate the throughput of our GCNScheduler, given the task graph of the three real perception applications provided in Ra et al. (2011), namely the face recognition, the object-and-pose recognition, and the gesture recognition. In particular, we run our trained GCNScheduler (with the throughput-maximization objective) over the carefully-designed input graphs and measure the throughput for each application. Fig. 9 shows the throughput of our GCNScheduler (with the throughput-maximization objective) compared to TP-HEFT Gallet et al. (2009) and the random task-scheduler for the three perception applications. While our GCNScheduler leads to a marginally better throughput performance compared to TP-HEFT scheduler Gallet et al. (2009), it significantly (2-3 orders of magnitude) reduces the time taken to perform task-assignment as it is shown in Table 7.

5 CONCLUSION

We proposed GCNScheduler, a scalable and fast task-scheduling scheme which can perform scheduling according to different objectives (such as minimizing the makespan or maximizing the throughput). By evaluating our scheme against benchmarks through simulations, we show that not only can our scheme easily handle large-scale settings where existing scheduling schemes are unable to do, but also it can lead to a better performance with significant lower required time (i.e., several orders of magnitude faster) to perform scheduling. As our future direction, we aim at investigating the performance of our proposed GCNScheduler with respect to other objectives with other teacher schedulers.

ACKNOWLEDGMENTS

This material is based upon work supported in part by Defense Advanced Research Projects Agency (DARPA) under Contract No. HR001117C0053 and by the Army Research Laboratory under Cooperative Agreement W911NF-17-2-0196. Any views, opinions, and/or findings expressed are those of the author(s) and should not be interpreted as representing the official views or policies of the Department of Defense or the U.S. Government.

REFERENCES

- Sourav Kanti Addya, Ashok Kumar Turuk, Bibhudatta Sahoo, Mahasweta Sarkar, and Sanjay Kumar Biswash. Simulated annealing based vm placement strategy to maximize the profit for cloud service providers. *Engineering Science and Technology, an International Journal*, 20(4):1249–1259, 2017. ISSN 2215-0986.
- Yossi Azar and Amir Epstein. Convex programming for scheduling unrelated parallel machines. In *Proceedings of the Thirty-Seventh Annual ACM Symposium on Theory of Computing*, STOC '05, pp. 331–337, New York, NY, USA, 2005. Association for Computing Machinery. ISBN 1581139608.
- Luiz André Barroso, Jimmy Clidaras, and Urs Hölzle. *The Datacenter as a Computer: An Introduction to the Design of Warehouse-Scale Machines, Second Edition*. 2013. URL <http://dx.doi.org/10.2200/S00516ED2V01Y201306CAC024>.
- J. Bhatia, T. Patel, H. Trivedi, and V. Majmudar. Htv dynamic load balancing algorithm for virtual machine instances in cloud. In *2012 International Symposium on Cloud and Services Computing*, pp. 15–20, 2012. doi: 10.1109/ISCOS.2012.25.
- Nan Cheng, Feng Lyu, Wei Quan, Conghao Zhou, Hongli He, Weisen Shi, and Xuemin Shen. Space/aerial-assisted computing offloading for iot applications: A learning-based approach. *IEEE Journal on Selected Areas in Communications*, 37(5):1117–1129, 2019. doi: 10.1109/JSAC.2019.2906789.
- P. Chrétienne, E.G. Coffman, J.K. Lenstra, and Zhen Liu (eds.). *Scheduling theory and its applications*. Wiley, United States, 1995. ISBN 0-471-94059-3.
- Kousik Dasgupta, Brototi Mandal, Paramartha Dutta, Jyotsna Kumar Mandal, and Santanu Dam. A genetic algorithm (ga) based load balancing strategy for cloud computing. *Procedia Technology*, 10:340–347, 2013. ISSN 2212-0173. First International Conference on Computational Intelligence: Modeling Techniques and Applications (CIMTA) 2013.
- Michaël Defferrard, Xavier Bresson, and Pierre Vandergheynst. Convolutional neural networks on graphs with fast localized spectral filtering. In *Proceedings of the 30th International Conference on Neural Information Processing Systems*, NIPS'16, pp. 3844–3852, Red Hook, NY, USA, 2016. Curran Associates Inc. ISBN 9781510838819.
- K. Dubey, M. Kumar, and M. A. Chandra. A priority based job scheduling algorithm using iba and easy algorithm for cloud metascheduler. In *2015 International Conference on Advances in Computer Engineering and Applications*, pp. 66–70, 2015. doi: 10.1109/ICACEA.2015.7164647.
- Schahram Dustdar, Stefan Nastić, and Ognjen Šćekić. Smart cities. In *The Internet of Things, People and Systems*. Springer, 2017.
- Leila Eskandari, Jason Mair, Zhiyi Huang, and David Eyers. Iterative scheduling for distributed stream processing systems. In *Proceedings of the 12th ACM International Conference on Distributed and Event-Based Systems*, DEBS '18, pp. 234–237, New York, NY, USA, 2018. Association for Computing Machinery. ISBN 9781450357821. doi: 10.1145/3210284.3219768. URL <https://doi.org/10.1145/3210284.3219768>.
- Z. Fan, H. Shen, Y. Wu, and Y. Li. Simulated-annealing load balancing for resource allocation in cloud environments. In *2013 International Conference on Parallel and Distributed Computing, Applications and Technologies*, pp. 1–6, 2013. doi: 10.1109/PDCAT.2013.7.
- M. Gallet, L. Marchal, and F. Vivien. Efficient scheduling of task graph collections on heterogeneous resources. In *IEEE International Symposium on Parallel Distributed Processing*, pp. 1–11, 2009. doi: 10.1109/IPDPS.2009.5161045.
- García-Piquer, A., Morales, J. C., Ribas, I., Colomé, J., Guàrdia, J., Perger, M., Caballero, J. A., Cortés-Contreras, M., Jeffers, S. V., Reiners, A., Amado, P. J., Quirrenbach, A., and Seifert, W. Efficient scheduling of astronomical observations - application to the carmenes radial-velocity survey. *A&A*, 604:A87, 2017. doi: 10.1051/0004-6361/201628577. URL <https://doi.org/10.1051/0004-6361/201628577>.

-
- Ian Goodfellow, Yoshua Bengio, and Aaron Courville. *Deep Learning*. MIT Press, 2016. <http://www.deeplearningbook.org>.
- William L. Hamilton, Rex Ying, and Jure Leskovec. Inductive representation learning on large graphs. In *Proceedings of the 31st International Conference on Neural Information Processing Systems, NIPS'17*, pp. 1025–1035, Red Hook, NY, USA, 2017. Curran Associates Inc. ISBN 9781510860964.
- William L. Hamilton, Rex Ying, and Jure Leskovec. Inductive representation learning on large graphs, 2018.
- Ishfaq Ahmad and Yu-Kwong Kwok. On exploiting task duplication in parallel program scheduling. *IEEE Transactions on Parallel and Distributed Systems*, 9(9):872–892, 1998. doi: 10.1109/71.722221.
- Habib Izadkhah and Yangming Li. Learning based genetic algorithm for task graph scheduling. *Appl. Comp. Intell. Soft Comput.*, 2019, January 2019. ISSN 1687-9724. doi: 10.1155/2019/6543957. URL <https://doi.org/10.1155/2019/6543957>.
- Guillaume Jaume, An phi Nguyen, María Rodríguez Martínez, Jean-Philippe Thiran, and Maria Gabrani. edggn: a simple and powerful gnn for directed labeled graphs, 2019.
- Kuljeet Kaur, Sahil Garg, Gagangeet Singh Aujla, Neeraj Kumar, Joel J. P. C. Rodrigues, and Mohsen Guizani. Edge computing in the industrial internet of things environment: Software-defined-networks-based edge-cloud interplay. *IEEE Communications Magazine*, 56(2):44–51, 2018. doi: 10.1109/MCOM.2018.1700622.
- J. Kennedy and R. C. Eberhart. A discrete binary version of the particle swarm algorithm. In *1997 IEEE International Conference on Systems, Man, and Cybernetics. Computational Cybernetics and Simulation*, volume 5, pp. 4104–4108 vol.5, 1997. doi: 10.1109/ICSMC.1997.637339.
- Thomas N. Kipf and Max Welling. Semi-supervised classification with graph convolutional networks, 2017.
- Mohit Kumar and S.C. Sharma. Dynamic load balancing algorithm for balancing the workload among virtual machine in cloud computing. *Procedia Computer Science*, 115:322–329, 2017. ISSN 1877-0509. 7th International Conference on Advances in Computing and Communications, ICACC-2017, 22-24 August 2017, Cochin, India.
- Jinhong Luo, Xijun Li, Mingxuan Yuan, Jianguo Yao, and Jia Zeng. Learning to optimize DAG scheduling in heterogeneous environment. *CoRR*, abs/2103.06980, 2021. URL <https://arxiv.org/abs/2103.06980>.
- Hongzi Mao, Malte Schwarzkopf, Shaileshh Bojja Venkatakrishnan, Zili Meng, and Mohammad Alizadeh. Learning scheduling algorithms for data processing clusters. In *Proceedings of the ACM Special Interest Group on Data Communication, SIGCOMM '19*, pp. 270–288, New York, NY, USA, 2019. Association for Computing Machinery. ISBN 9781450359566. doi: 10.1145/3341302.3342080. URL <https://doi.org/10.1145/3341302.3342080>.
- Michael A. Palis, Jing-Chiou Liou, and David S. L. Wei. Task clustering and scheduling for distributed memory parallel architectures. *IEEE Trans. Parallel Distributed Syst.*, 7(1):46–55, 1996. doi: 10.1109/71.481597. URL <https://doi.org/10.1109/71.481597>.
- Xuan-Quy Pham, Nguyen Doan Man, Nguyen Dao Tan Tri, Ngo Quang Thai, and Eui-Nam Huh. A cost- and performance-effective approach for task scheduling based on collaboration between cloud and fog computing. *International Journal of Distributed Sensor Networks*, 13(11): 1550147717742073, 2017. doi: 10.1177/1550147717742073. URL <https://doi.org/10.1177/1550147717742073>.
- Moo-Ryong Ra, Anmol Sheth, Lily Mummert, Padmanabhan Pillai, David Wetherall, and Ramesh Govindan. Odessa: Enabling interactive perception applications on mobile devices. In *Proceedings of the 9th International Conference on Mobile Systems, Applications, and Services*, pp. 43–56, New York, NY, USA, 2011. Association for Computing Machinery. ISBN 9781450306430. doi: 10.1145/1999995.2000000. URL <https://doi.org/10.1145/1999995.2000000>.

-
- H. Ren, Y. Lan, and C. Yin. The load balancing algorithm in cloud computing environment. In *Proceedings of 2012 2nd International Conference on Computer Science and Network Technology*, pp. 925–928, 2012. doi: 10.1109/ICCSNT.2012.6526078.
- F. Scarselli, M. Gori, A. C. Tsoi, M. Hagenbuchner, and G. Monfardini. The graph neural network model. *IEEE Transactions on Neural Networks*, 20(1):61–80, 2009. doi: 10.1109/TNN.2008.2005605.
- Henrique Yoshikazu Shishido, Júlio Cezar Estrella, Claudio Fabiano Motta Toledo, and Marcio Silva Arantes. Genetic-based algorithms applied to a workflow scheduling algorithm with security and deadline constraints in clouds. *Computers and Electrical Engineering*, 69:378–394, 2018. ISSN 0045-7906.
- Martin Skutella. Convex quadratic and semidefinite programming relaxations in scheduling. *J. ACM*, 48(2):206–242, March 2001. ISSN 0004-5411. doi: 10.1145/375827.375840. URL <https://doi.org/10.1145/375827.375840>.
- Rajesh Sudarsan and Calvin J. Ribbens. Combining performance and priority for scheduling resizable parallel applications. *Journal of Parallel and Distributed Computing*, 87:55–66, 2016. ISSN 0743-7315.
- Penghao Sun, Zehua Guo, Junchao Wang, Junfei Li, Julong Lan, and Yuxiang Hu. Deepweave: Accelerating job completion time with deep reinforcement learning-based coflow scheduling. In *IJCAI*, 2020.
- Richard S. Sutton and Andrew G. Barto. *Reinforcement Learning: An Introduction*. A Bradford Book, Cambridge, MA, USA, 2018. ISBN 0262039249.
- Abbas Shah Syed, Daniel Sierra-Sosa, Anup Kumar, and Adel Elmaghraby. Iot in smart cities: A survey of technologies, practices and challenges. *Smart Cities*, 4(2):429–475, 2021.
- H. Topcuoglu, S. Hariri, and Min-You Wu. Performance-effective and low-complexity task scheduling for heterogeneous computing. *IEEE Transactions on Parallel and Distributed Systems*, 13(3): 260–274, 2002. doi: 10.1109/71.993206.
- Muhan Zhang and Yixin Chen. Link prediction based on graph neural networks, 2018.