

Compositionality as we see it, everywhere around us

Bob Coecke
Cambridge Quantum Ltd.
Compositional Intelligence team, Oxford.
bob.coecke@cambridgequantum.com

October 26, 2021

Abstract

There are different meanings of the term “compositionality” within science: what one researcher would call compositional, is not at all compositional for another researcher. The most established conception is usually attributed to Frege, and is characterised by a bottom-up flow of meanings: the meaning of the whole can be derived from the meanings of the parts, and how these parts are structured together.

Inspired by work on compositionality in quantum theory, and categorical quantum mechanics in particular, we propose the notions of Schrödinger, Whitehead, and complete compositionality. Accounting for recent important developments in quantum technology and artificial intelligence, these do not have the bottom-up meaning flow as part of their definitions.

Schrödinger compositionality accommodates quantum theory, and also meaning-as-context. Complete compositionality further strengthens Schrödinger compositionality in order to single out theories like ZX-calculus, that are complete with regard to the intended model. All together, our new notions aim to capture the fact that compositionality is at its best when it is ‘real’, ‘non-trivial’, and even more when it also is ‘complete’.

At this point we only put forward the intuitive and/or restricted formal definitions, and leave a fully comprehensive definition to future collaborative work.

1 Introduction

I was invited to write this paper for a special issue, aimed to celebrate Andrei Khrennikov’s 60 birthday in recognition of his contributions to the quantum foundations community, as well as Andrei being one of the frontrunners in using quantum structures in areas other than physics – see Section 8 for a picture of us. In particular, we were asked to discuss why it makes sense to use certain quantum structures outside of physics, and in particular, why quantum physics provides structures that are useful outside of physics – a question initially posed by Anton Zeilinger.

In my work, already for some 20 years, the quantum structure that has taken the centre stage is the quantum compositional structure. By this we refer to the particular manner in which quantum systems compose, which Schrödinger singled out as the key characteristic of quantum theory. All-together, we provided a novel formalism for quantum theory entirely based on composition of systems, casting orthonormal bases [44], measurements [43], classicality [42], and (strong) complementarity [30, 31, 32], entirely in compositional terms. The formalism can now be used to give a fully compositional account of all that what one expects to get in a course

on quantum foundations and quantum computing [38]. It is also now being used in quantum industry, e.g. ZX-calculus based circuit optimisation techniques such as [53, 83, 50, 5] are now internal to Cambridge Quantum’s $t|ket\rangle$ [108]. Other uses in industry include [63], and there are also efforts by major quantum computing companies to push our compositional quantum formalism as the number one educational tool for quantum computing. The key reason for that is that compositionality yields an entirely pictorial quantum formalism, usually referred to as ‘quantum pictorialism’ [24].

There of course have been earlier attempts to provide quantum theory with a novel formalism, see e.g. [40] for an overview. While this quest was initiated by the great John von Neumann [111, 12], it is fair to say that none of those approaches have been successful – with the exception of some applications outside of physics, e.g. in NLP [114, 115]. One of the major issues of these attempts was their failure to account for quantum composition. Meanwhile, many approaches in quantum foundations now also recognise the importance of the compositional backbone [71, 18, 33, 19, 104, 105, 101]. All of this seems to strongly confirm Schrödinger’s hunch that compositionality underpins quantum theory.

With respect to using quantum structures in other areas, in 2008 we used quantum compositional structure in order to solve a then open problem [22, 46]: how can we combine meanings of words in order to produce the meaning of a sentence, with meanings represented as vectors, as is standardly done in modern natural language processing (NLP) [55, 72, 98]. The crux was the fact that quantum compositional structure is, category-theoretically speaking, exactly the same as grammatical structure [21]. This correspondence has recently resulted in implementations of NLP on existing quantum computers, by ourselves at Cambridge Quantum [28, 29, 90, 87, 76]. We provide more details on this in Sections 5.1 and 6.

Now, speaking about different disciplines, the term “compositionality” has different incarnations within different communities, and even within single communities there have been contradictory conceptions. In the recently emerging and flourishing Applied Category Theory community, which considers very similar compositional structures as the ones discussed above, there does seem to be a common understanding of what compositionality means. In many cases it also manifests itself in terms of a pictorial formalism. Within this community, compositionality has become a discipline transcending vehicle, that provides a bridge for exchanging concepts, methods and results. Within one discipline it can provide a radically new perspective, putting the focus on how things interact, rather than what they are made up from. However, as far as we know, nobody within this community has ever attempted to define what the particular brands of compositionality in use are. This paper is our attempt to do so.

So in mathematical terms, compositionality is closely related to category theory. However, there are some caveats. Firstly, category theory was proposed as a meta-theory of mathematics, and the CT community at large pushed this view, while for us compositionality is all about real-world phenomena. Secondly, many subfields of category theory favour so-called cartesian categories, while compositionally speaking these are the much less interesting categories.

The multidisciplinary community mentioned above has its own journal and conference, although with different names, Compositionality and Applied Category Theory respectively. Why? This dual terminology is a result of a compromise between communities with very different cultures. We favour “Compositionality” as it clearly emphasises the key foundational concept that governs the work, while “applied [something]” somewhat goes against the spirit of being of a foundational nature. On the other hand, in defence of the term “Applied Category Theory”, it refers to a clear community shift within the new generation of category-theoreticians, not just focusing on mathematics anymore. This shift has many different dimensions to it, one

being the desire to solve important real-world problems.

The oldest area doing practical ACT is computer science, thinking of data-types as systems, and programs as processes [2]. There is a huge literature, and every year conferences produce a humongous amount of new papers – some more history on compositionality in computer science is in [96]. Other papers giving nice overviews of compositional structures in a variety of fields include [8, 56], and a number of recent papers showing the wide range of topics currently addressed are [62, 95, 14, 7, 73, 13, 61, 109, 107].

2 Compositionality in linguistics and quantum physics

The area mostly associated with a formal definition of compositionality is formal linguistics, where its definition is usually stated as follows:

- The meaning of a whole (cf. sentence) should only depend on the meanings of its parts (cf. words) and how they are fitted together (cf. grammar).

A prominent argument for this notion, put forward by Frege [58], is that without compositionality it would be impossible for us to understand a sentence that we have never heard before. Broadly speaking, this is of course indeed the case. However, interestingly Frege himself mentions in ‘Grundlagen der Arithmetik’ [57, 74]:

- “Never ask for the meaning of a word in isolation, but only in the context of a sentence.”

This is called ‘the context principle’ [116], and indeed:

- In language, meanings are to a great extent induced by the context. For example, ambiguous words such as **Alice** could point at either of these two incarnations of **Alice**:

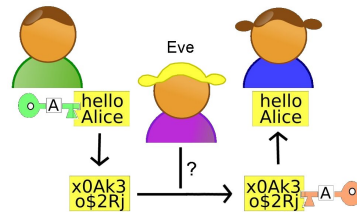

We may disambiguate **Alice** by other words in the sentence or larger text, or by non-linguistic features, like the conversation taking place between two children impersonating fairytale characters, or between security protocol experts. Even within the restricted context of gothic rock fans **Alice** could still have two meanings, two cases being:



There are some more refined formulations of linguistic compositionality that aim to account for context-dependent word ambiguities, however, the following is harder to get around:

- In language, separation between word meanings and how they grammatically fit together doesn't always make sense, as the grammar can depend on the overall meaning, which may need additional context to be disambiguated. For example, in **black metal fan** the grammar depends on the meanings:¹

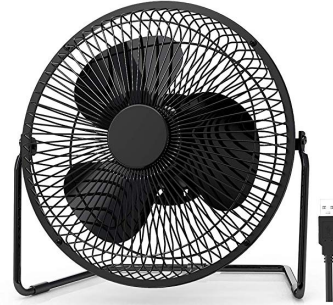

Using the language of [27], the respective grammatical parsings proofs are:

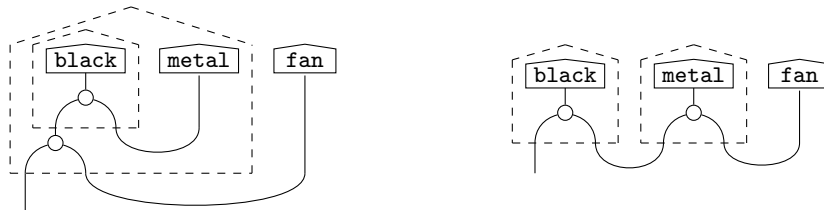

It is not as important to understand them, than just to observe that they are different, so there is no fixed grammar until the overall meaning has been unambiguously established.

In the linguistic context the fundamental problem with the above stated notion of compositionality is that it puts a special focus on bottom-up meaning-flows, the meaning of the whole being induced by the meanings of the parts. However, meaning-flows within a composite can equally well travel top-down along the same structure, that is, the meaning of the whole can contribute to meanings of parts. So what we are aiming for is some network structure that allows for such two-way meaning-flows. Maybe even better put, a network structure that allows for meaning-relationships along the different scales, cf. word vs. sentence vs. text.

In quantum theory the situation gets even more extreme:

- For entangled states the idea that subsystems have meanings breaks down, and so does Frege compositionality. For example, the pure Bell-state's sub-systems are in the state of total noise when conceived individually. In addition to these individual descriptions, in order to know that the overall state is the Bell-state, one needs the entire description of the Bell-state itself.

So there is no meaningful decomposition of the whole in terms of parts plus structure. Yet both language and quantum theory are perfectly compositional as far as we are concerned. How?

¹We took this particular example from [39], but there are of course many more.

3 Process-theoretic compositionality

Let's take quantum theory as our starting point and see how we can associate a notion of compositionality to it that generalises to language. As already pointed out in the introduction, Schrödinger singled out the nature of composition of systems in quantum theory not as just a, but as the defining feature of the theory [102]:

“Entanglement is not one but rather the characteristic trait of quantum mechanics.”

Formally, (pure-state) entanglement means:

$$|\psi_{AB}\rangle \neq |\psi_A\rangle \otimes |\psi_B\rangle \quad (1)$$

that is, the state of two systems A and B doesn't factor as a state $|\psi_A\rangle$ of A and a state $|\psi_B\rangle$ of B . We can write (1) diagrammatically as follows [23, 38]:

$$\begin{array}{c} \psi_{AB} \\ \hline \end{array} \neq \begin{array}{c} \psi_A \\ \hline \end{array} \begin{array}{c} \psi_B \\ \hline \end{array} \quad (2)$$

This notation of states is a special case of representing processes as boxes:

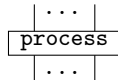

which can be composed to form *diagrams*:

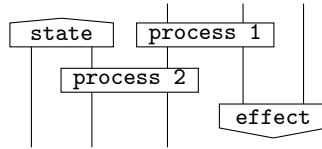

An example of a maximally entangled state/effect are the *Bell-state/effect*, which we denote as:

$$\begin{array}{c} \cup \\ \hline \end{array} = |00\rangle + |11\rangle \quad \begin{array}{c} \cup \\ \hline \end{array} = \langle 00| + \langle 11|$$

With this state and effect our diagram becomes:

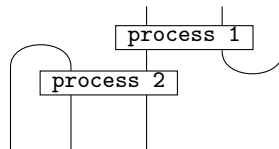

The claim we made earlier that the Bell-state's sub-systems are in the state of noise when conceived individually, diagrammatically takes the form:

$$\begin{array}{c} \cup \\ \hline \end{array} = \begin{array}{c} \cup \\ \hline \end{array} \quad \begin{array}{c} \cup \\ \hline \end{array} \quad \begin{array}{c} \cup \\ \hline \end{array}$$

system A is being discarded - - \rightarrow \leftarrow - - system B is now maximal noise

We refer to a situation where the composite of two systems cannot be meaningfully described in terms of its parts as *non-trivial composition*. Others may call it wholistic. The Bell-states,

as well as any other maximally entangled states, can be shown to constitute an extremal example of non-trivial composition [34, 65]. Formally, the possible states of two systems are then isomorphically related to the processes that each system can undergo as follows:

$$\left\{ \begin{array}{c} \text{state} \\ \downarrow \downarrow \end{array} \right\} = \left\{ \begin{array}{c} \text{process} \\ \uparrow \downarrow \end{array} \right\} \simeq \left\{ \begin{array}{c} \text{process} \\ \downarrow \downarrow \end{array} \right\}$$

where the isomorphism is established by the following equation:

$$\begin{array}{c} \text{U-shaped line} \\ \downarrow \downarrow \end{array} = \begin{array}{c} | \\ \downarrow \downarrow \end{array}$$

which is characteristic for extremal non-trivial composition.

What makes these kinds of states (and effects) interesting is not what they are, but what one can do with them. That is, what happens when one processes them. This for example leads to features like quantum teleportation [11, 118, 15], quantum non-locality [10, 67] and, measurement-based quantum computing [66, 99], among many more, each of these having no non-trivial classical counterparts.

This means that a general notion of compositionality should apply to general theories of processes, not just theories of states. With the advent of our compositional quantum formalism, a.k.a. categorical quantum mechanics [1, 38], a.k.a. quantum picturalism [24], we know that such a presentation leads to a much more intuitive purely diagrammatic formalism, important computational advantages, e.g. in quantum computing [54, 51, 52, 82], and bridges disciplines giving rise to new technologies such as quantum natural language processing [117, 28, 87]. The paper [35] lists recent compositionality-driven advances for the specific case of the ZX-calculus.

The idea of focusing on processes instead of states is of course not new, and even goes back to the pre-Socratic Heraclitus’ “panta rhei”, a.k.a. everything flows, and in more recent times was advocated by Whitehead in “Process and Reality” [113]. His stance departs from our typical Western metaphysics in which we start with a static kinematic layer with dynamics as a secondary derivative [103]. Whitehead’s work however did not explicitly consider a non-trivial *parallel* composition as in (2), and therefore we will introduce two notions of compositionality, distinguishing between Whitehead and Schrödinger compositionality.

Diagrammatically, we can think of Whitehead compositionality as diagrams like this:

$$\begin{array}{c} \text{process 1} \\ \downarrow \\ \text{process 2} \\ \vdots \\ \text{process } n \end{array} \tag{3}$$

Condition (2) for two systems A and B ‘separated in space’, has an analogue for processes with input A and output B ‘separated in time’:

$$\begin{array}{c} \text{process } f \\ \downarrow \downarrow \end{array} \neq \begin{array}{c} \psi_A \\ \downarrow \\ \psi_B \\ \downarrow \downarrow \end{array} \tag{4}$$

This is satisfied for any reasonable theory for processes, since otherwise we would obtain a theory only containing constant processes that produce output $|\psi_B\rangle$ for any possible input:

$$f(|\phi\rangle) = |\psi_B\rangle\langle\psi_A|\phi\rangle \simeq |\psi_B\rangle$$

Similarly, processes also enjoy non-triviality by analogy, given that what they typically do is relate varying inputs to corresponding outputs. Hence deriving them from a fixed input-output pair doesn't make much sense.

For illustrative purposes we will mainly make use of the conception of process theory as in [37, 38]. It has meanwhile been established that the process theory format provides a useful complementary presentation of quantum theory as compared the the usual Hilbert space formulation. In particular, in the foundations of quantum theory a process-theoretic backbone is now a dominant feature for many developments – see e.g. [71, 18, 33, 19, 104, 105, 101].

Definition 3.1. [37, 38] A *process theory* is defined to consist of:

- a collection of systems (or types, or interfaces) S represented by wires,
- a collection of processes P represented by boxes, and where each process in P has a number of input wires and a number of output wires taken from S , and
- a means of composing processes, represented by wiring boxes together, and the result of doing so should again be a process in P .

While in quantum theory one can interpret these processes as taking place in space and time, this doesn't always have to be the case, for example, wirings can be physical wires:

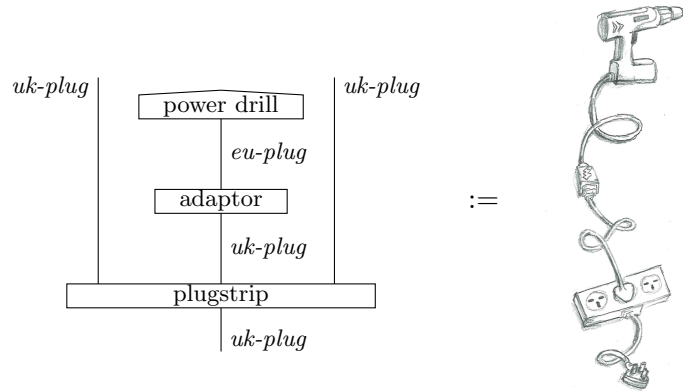

or, more abstract connections like in a flow-chart [64].

However, the definition of process theories stated above is by no means the most general notion conceivable of a compositional theory. For example, besides processes a theory could also specify transformations of processes (a.k.a. higher-order processes—see e.g. [20, 94, 81]), and it could also have transformations of interfaces etc. In the case of the latter, one could think of these diagrammatically as surfaces connecting wires, and processes transforming processes are typically denoted as ‘combs’ [17]:

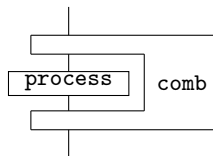

We could then also have hyper-combs transforming combs, and so on. The bottom line is that our definitions below also apply to these more general notions of compositional theories that stretch well beyond the notion of process theory stated above.

Some of the above can also be framed in the language of category theory. In the case of process theories à la Whitehead we would be talking about ordinary categories, possibly cartesian, while in the case of process theories à la Schrödinger we would be talking about proper (strict) symmetric monoidal categories [88, 41]. In the extremal case of Bell-states we are talking about compact closed categories [78, 79, 1, 41]. Going beyond process theories by considering transformations of processes and so on takes us into higher category theory [86].

4 Kinds of compositionality

4.1 Schrödinger compositionality

Definition 4.1. A *Schrödinger compositional theory* is a compositional theory in the sense of the previous section, subject to two conditions:

- Composition is non-trivial, that is, the description of a whole cannot always be decomposed in any meaningful way—cf. given the description of parts, one may still require a full description of the whole in order to derive the latter.
- The ingredients of a compositional theory—e.g. the ingredients in Defn. 3.1—all have clear meaningful ontological counterparts in reality.

The first condition of non-triviality is what makes the passage to a compositional description worthwhile. If it is trivial (cf. cartesian categories), then there really is not much point to elevate composition to a 1st class citizen. In fact, it is our belief that pretty much everything in the real world admits non-trivial composition when regarded in process-theoretic terms.

The second condition of the compositional structure ‘being real’ is essential in that it provides a model for the theory, hence establishing its consistency, and much more importantly, makes the theory relevant. It also provides us with our daily intuition as guidance for studying it, in the same way that Euclid relied on physical space to establish geometry. Finally, for the specific case of AI, compositionality then becomes a vehicle for incorporating embodiment in a compositional fashion, as for example in [13, 112].

So a slogan could be:

Compositionality is at its best when it is non-trivial and real.

The main purpose of the following definition is just to contrast it with Defn. 4.1:

Definition 4.2. A *Whitehead compositional theory* is the same as a Schrödinger compositional theory except for the fact that composition is only one-dimensional—cf. (3).

4.2 Complete compositionality

One issue with Schrödinger compositionality as we defined it is that we assumed processes to be ‘black-boxes’, that is, they don’t necessarily interact in any obvious way. Ultimately, this boils down to what the equational structure of the process theory is: some may have a lot of equations between diagrams, other few, or none at all if they are free theories. However,

there are some very special kinds of process theories around with a very rich compositional structure. They typically have a number of generating processes, which have a very easily understood interaction structure, and also generate a very rich class of processes by plugging them together. This results in a very powerful reasoning system.

One example of such a rich compositional theory is the ZX-calculus [30, 31], where, for example, a CNOT-gate arises from two generating processes [35]:

$$(5)$$

These generating processes respectively correspond to Z- and X-copying, or more generally, the respective ‘spiders’ they generate:

$$\begin{aligned}
 \begin{array}{c} \dots \\ \circ \\ \alpha \\ \dots \end{array} & := |0 \dots 0\rangle \langle 0 \dots 0| + e^{i\alpha} |1 \dots 1\rangle \langle 1 \dots 1| \\
 \begin{array}{c} \dots \\ \circ \\ \alpha \\ \dots \end{array} & := |+\dots+\rangle \langle +\dots+| + e^{i\alpha} |-\dots-\rangle \langle -\dots-|
 \end{aligned}$$

These spiders have an interaction structure that can be written down in only 4 equations, but at the same time generate all matrices over arrays of qubits [38]. Another example of a complete compositional theory is ZW-calculus [36, 69], for which the generating processes are the GHZ-state and the W-state.

How can we qualify the richness of such a theory? We can do this in terms of how much of all the intended equations between diagrams can be derived from the interaction rules for the generating processes. In the case of the ZX-calculus and the ZW-calculus, in fact, all equations that can be derived using linear algebra can be derived from the interaction rules [70]. We say that both of these calculi are *complete*. This completeness caused quite some noise at the time, but it didn’t come entirely out of the blue, some earlier work including [4, 6, 69, 75], and there also are some further elaborations [47, 110].

Definition 4.3. A *complete compositional theory* is a Schrödinger compositional theory with a complete compositional structure in the above sense.

Our slogan now becomes:

Compositionality is at its best when it is non-trivial, real and complete.

There is one subtlety however...

4.3 Relativity of compositionality

In the case of ZX-calculus by ‘real’ we mean that each spider corresponds to a physical process that may occur. We say ‘may’, as most spiders cannot be realised in a deterministic fashion: they can only occur as a branch in a non-deterministic process, e.g. an appropriately crafted measurement. In other words, they are not ‘causal’ [18, 25, 80].

Now, rather than considering all quantum processes, one could restrict to unitary ones. In that context, the ZX-spiders are not ‘real’ anymore and only occur as ‘1/2 of a CNOT-gate’, as in (5). So now real processes are further decomposed in smaller bits. These smaller bits greatly facilitate computation as compared to the unitary processes.

Definition 4.4. *Lego compositionality* is a generalisation of Schrödinger compositionality in that processes may be broken down in smaller pieces that have no counterpart in reality.

5 Examples and non-examples

5.1 Natural language processing

Our approach to natural language from [22, 46, 68, 77] called DisCoCat, which combines meaning and linguistic structure, is Schrödinger compositional, and has equally non-trivial composition as quantum theory. Boxes in diagrams such as:

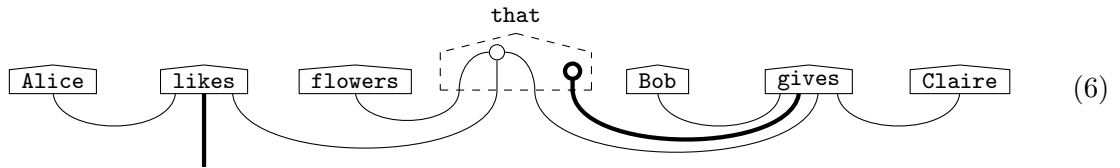

correspond to word-meanings, the wirings correspond to grammatical structure, and the resulting state is the meaning of the sentence. Hence the compositional structure is clearly ‘real’.

The word-meanings themselves have composite types, and a transitive verb box such as:



evidently satisfies (2) since otherwise the subject and the object would play no role in the overall meaning of the sentence. An adjective like:²



cannot really be assigned any meaning until we actually know what its context is, so there clearly is no meaningful decomposition of it over parts and structure.

The wiring of **that** in terms of spiders taken from [100] can be considered as complete compositional, given that a single relative pronoun is broken down in smaller bits – formally, when interpreted in vector space, a GHZ-state and a $|+\rangle$ -state. We recently proposed many more such decompositions in [49], and there is a case to be made that they are in fact ‘real’, as they result in new truths about grammar not previously recorded.

These language diagrams can be equivalently interpreted as quantum physics diagrams [21, 28], a connection that can only be established when conceiving both theories in the compositional manner we casted them in. This is an important feature about of shared compositional structure: it enables one to map seemingly entirely different areas onto each other, and enables an exchange of concepts and tools. In fact, in this particular case it gets even better, as this connection effectively enabled us to process natural language on a quantum computer [117, 89, 90, 28, 87, 76]. For doing so, a language diagram, now interpreted as a quantum

²This example was 1st pointed out to us by Fabrizio Genovese.

process, still needs to be compiled so that it fits on quantum hardware. Again this compilation is enabled by compositional structure, in this case the complete compositionality of the ZX-calculus, by ‘filling’ the meaning-boxes with ZX-diagrams, which can then be put in circuit-form [28]:

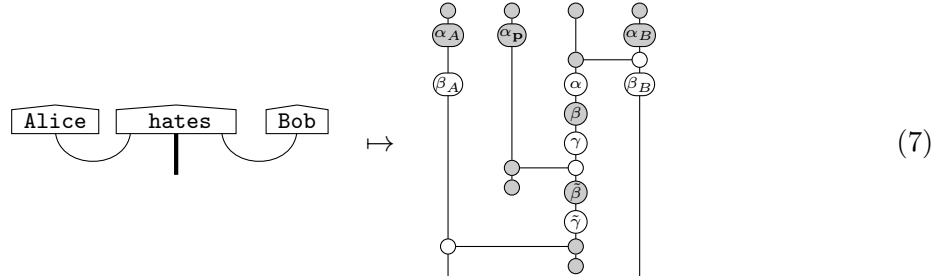

5.2 Neural networks and tensor networks

In neural networks, individual neurons typically have no clear counterpart in reality, and due to how the non-linearities are inserted, have no comprehensible interaction rule. Hence standard neural networks do not satisfy the definitions of compositionality put forward here.

In the case of tensor networks in physics, nodes can have counterparts in condensed matter, but in many cases again there is no rich structure of interaction rules. Hence, tensor networks can be Schrödinger compositional, but are typically nowhere near complete compositional.

5.3 Can maths be Schrödinger compositional?

Well, it kind of depends whether one conceives maths as either real or not, so it is to some extent subjective. Something that one can do is to recast mathematical structures in Schrödinger compositional terms. We for example did this with convex structures in [13], which following Gärdenfors [60, 59] can be interpreted as related to our sensual perception, and our theory then expresses how different senses compose, generating more sophisticated concepts from simple concepts. Similarly, in [112] we take 3(+1)D cartesian space, and recast it as compositional spatial relations that represent how entities within physical space are related.

6 Top-down flow and ambiguity

Formal linguistics is the area most associated with compositionality. But, categorial grammars such as in [3, 9, 84, 91, 92, 85] have a surprising limitation in that compositionality doesn’t stretch beyond the sentence level, while, of course, when we speak/write we compose sentences in order to form larger chunks of text. DisCoCat, as described above, having been built on top of categorial grammars and is therefore also limited to relating meanings of words to those of sentences, and not to larger text.

Our attempt to fix this shortcoming was started in [27] under the name DisCoCirc and is being pushed further in [48]. The main slogan of our work is:

A sentence is a process that alters the meanings of its inhabitants.

The idea is to move from diagrams like (6) to circuits:

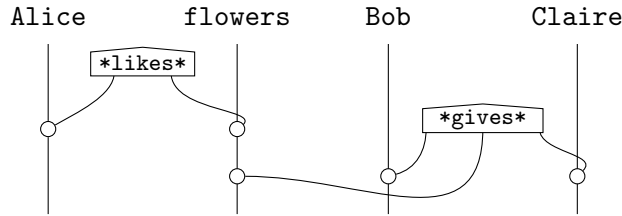

which can then be composed further:

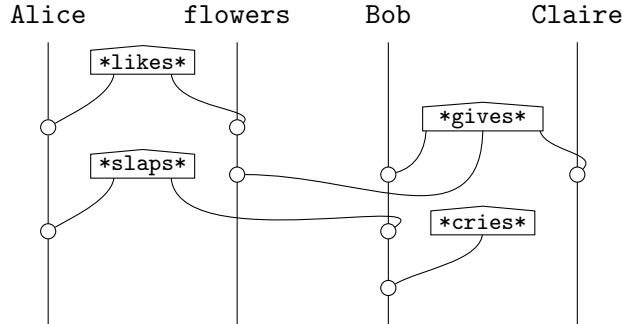

A major feature about these *language circuits* is that they can be interpreted bottom-up, as well as top-down, or a hybrid that expresses relationships between different levels. For example, we could have the meanings of a circuit as a given, and from these deduce the meanings of the words in it. This is in fact what we did in our QNLP-work [90, 28, 87, 76], obtaining the word-meanings from a corpus of sentences we knew to be truthful. The reason for doing so in that particular case is that currently there is no better way available to load classical data on a quantum computer. So this is a case where a top-down interpretation is imposed by the technology.

As mentioned in the beginning of this paper, one of the key features of language is ambiguity, which manifests in many different ways. Evidently, when reasoning top-down, there initially will be ambiguity about the parts. In modern natural language processing meanings are represented by vectors. But wait a minute, we know how to deal with ambiguity in quantum theory: mixed states. We can now use our compositional correspondence to transfer von Neumann’s quantum account on ambiguity in terms of density matrices to language [97]:

$$\begin{aligned}
 \rho_{\text{queen}} &= |\text{queen-royal}\rangle\langle\text{queen-royal}| \\
 &+ |\text{queen-band}\rangle\langle\text{queen-band}| \\
 &+ |\text{queen-bee}\rangle\langle\text{queen-bee}| \\
 &+ |\text{queen-chess}\rangle\langle\text{queen-chess}| \\
 &+ |\text{queen-card}\rangle\langle\text{queen-card}| \\
 &+ \dots
 \end{aligned}$$

This can then be extended to all kinds of ambiguities, including different grammars with different meanings like in the case of **black metal fan**:

$$\left| \begin{array}{c} \text{Black Metal Band} \\ \text{Black Metal Fan} \end{array} \right\rangle \left\langle \begin{array}{c} \text{Black Metal Band} \\ \text{Black Metal Fan} \end{array} \right| + \left| \begin{array}{c} \text{Black Metal Band} \\ \text{Black Metal Fan} \end{array} \right\rangle \left\langle \begin{array}{c} \text{Black Metal Band} \\ \text{Black Metal Fan} \end{array} \right| \quad (8)$$

The top-down meaning-flow will then disambiguate such mixtures.

You may think that the sum in (8) takes us out of the fully compositional paradigm, but in 2005 Selinger put forward a paradigm that generates mixedness just using diagrams [106], used throughout our book [38]. It’s where the ‘ground’ notation also entered the quantum formalism [45]:

$$\begin{array}{c} \text{---} \\ | \end{array}$$

It has even recently obtained the status of being completely compositional in [16].

7 Final considerations

Why quantum? So why did the notion of Schrödinger compositionality emerge from quantum theory? No particular reason, really. Historically, of course, the Western metaphysical bottom-up perspective favoured reductionist interpretations. What quantum added to the picture was that it puts a case forward that simply couldn’t be ignored. We also strongly believe that this is the kind of math that is very needed in humanities and social sciences, so that we finally can relieve ourselves of the mindlessness of mostly doing statistics. Ultimately, we think of these compositional structures as everywhere around us, a case that we have made at a number of previous occasions [24, 26, 29].

What’s next? Admittedly, we kept things informal, adopting a restricted notion of processes, and stated the conditions on Schrödinger and complete compositionality only informally. We are currently working towards a fully-formal characterisation of several notions of compositionality.

8 Pic with Andrei

One of my first better-known papers in the area of compositionality was the transcription of a talk at Andrei Khrennikov’s annual quantum foundations conference, in 2005, called Kindergarten Quantum Mechanics [23]. The next year, in 2006, Andrei got us in the local Swedish newspaper after I gave a talk “In the beginning God created \otimes ”, translated as “I begynnelsen

skapade Gud spännmuskeln som en bild”:

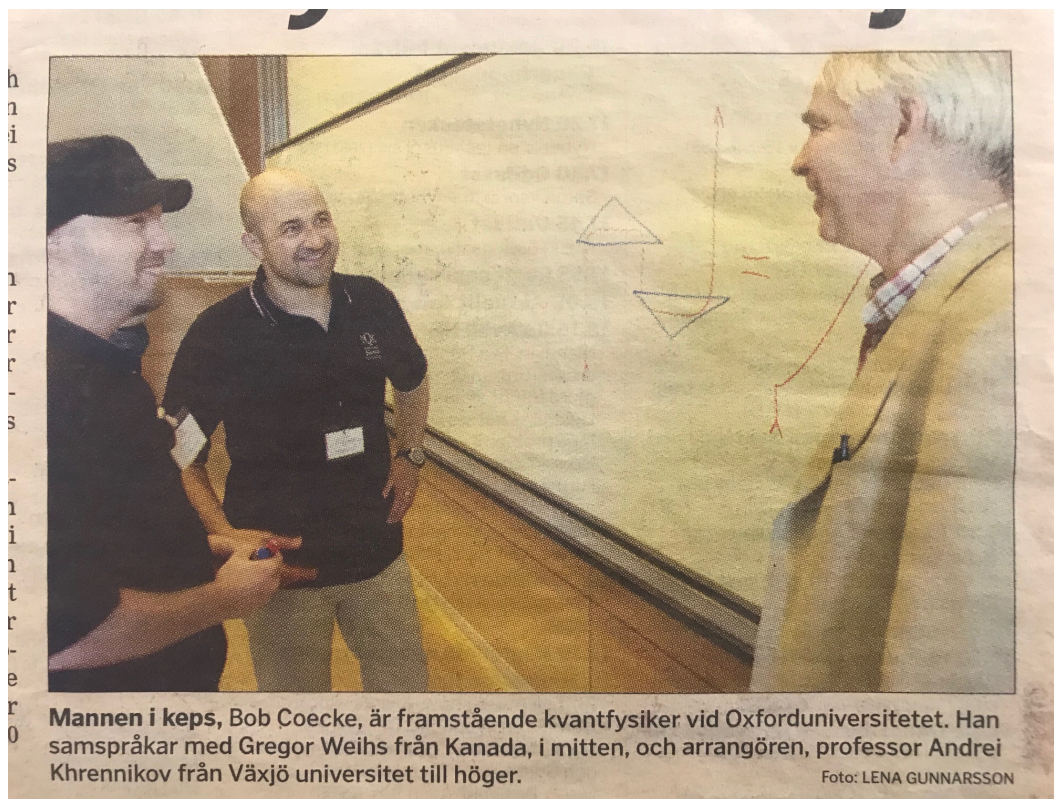

Mannen i keps, Bob Coecke, är framstående kvantfysiker vid Oxforduniversitetet. Han samspråkar med Gregor Weihs från Kanada, i mitten, och arrangören, professor Andrei Khrennikov från Växjö universitet till höger.

Foto: LENA GUNNARSSON

We thank Vincent Wang for proofreading this manuscript. At the time that this picture was taken, Vincent was still playing with teddy bears. Stephen Clark, Amar Hadzihasanovic, Arkady Plotnitsky, Ilyas Khan and Ian Durham also provided feed-back. Peter Stannack pointed out that this paper can be conceived as providing a response to a puzzle put forward by Ryan Nefdt in [93].

References

- [1] S. Abramsky and B. Coecke. A categorical semantics of quantum protocols. In *Proceedings of the 19th Annual IEEE Symposium on Logic in Computer Science (LICS)*, pages 415–425, 2004. arXiv:quant-ph/0402130.
- [2] S. Abramsky and N. Tzevelekos. Introduction to categories and categorical logic. In B. Coecke, editor, *New Structures for Physics*, Lecture Notes in Physics, pages 3–94. Springer-Verlag, 2011.
- [3] K. Ajdukiewicz. Die syntaktische konnexität. *Studia Philosophica*, 1:1–27, 1937.
- [4] M. Backens. The ZX-calculus is complete for stabilizer quantum mechanics. *New Journal of Physics*, 16:093021, 2014. arXiv:1307.7025.
- [5] M. Backens, H. Miller-Bakewell, G. de Felice, and J. van de Wetering. There and back again: A circuit extraction tale. *arXiv preprint arXiv:2003.01664*, 2020.

- [6] Miriam Backens. The ZX-calculus is complete for the single-qubit clifford+t group. In B. Coecke, I. Hasuo, and P. Panangaden, editors, *Proceedings of the 11th workshop on Quantum Physics and Logic*, volume 172 of *Electronic Proceedings in Theoretical Computer Science*, pages 293–303. Open Publishing Association, 2014.
- [7] J. C. Baez and B. Fong. A compositional framework for passive linear networks. *arXiv:1504.05625*, 2015.
- [8] J. C. Baez and M. Stay. Physics, topology, logic and computation: a Rosetta stone. In B. Coecke, editor, *New Structures for Physics*, Lecture Notes in Physics, pages 95–172. Springer, 2011.
- [9] Y. Bar-Hillel. A quasiarithmetical notation for syntactic description. *Language*, 29:47–58, 1953.
- [10] J. S. Bell. On the Einstein-Podolsky-Rosen paradox. *Physics*, 1(3):195–200, 1964.
- [11] C. H. Bennett, G. Brassard, C. Crepeau, R. Jozsa, A. Peres, and W. K. Wootters. Teleporting an unknown quantum state via dual classical and Einstein-Podolsky-Rosen channels. *Physical Review Letters*, 70(13):1895–1899, 1993.
- [12] G. Birkhoff and J. von Neumann. The logic of quantum mechanics. *Annals of Mathematics*, 37:823–843, 1936.
- [13] J. Bolt, B. Coecke, F. Genovese, M. Lewis, D. Marsden, and R. Piedeleu. Interacting conceptual spaces I: Grammatical composition of concepts. In M. Kaipainen, A. Hautamäki, P. Gärdenfors, and F. Zenker, editors, *Concepts and their Applications*, Synthese Library, Studies in Epistemology, Logic, Methodology, and Philosophy of Science. Springer, 2018. to appear.
- [14] F. Bonchi, P. Sobocinski, and F. Zanasi. A categorical semantics of signal flow graphs. In *CONCUR’14: Concurrency Theory.*, volume 8704 of *Lecture Notes in Computer Science*, pages 435–450. Springer, 2014.
- [15] D. Bouwmeester, J.-W. Pan, K. Mattle, M. Eibl, H. Weinfurter, and A. Zeilinger. Experimental quantum teleportation. *Nature*, 390(6660):575–579, 1997.
- [16] T. Carrette, E. Jeandel, S. Perdrix, and R. Vilmart. Completeness of graphical languages for mixed states quantum mechanics. *arXiv preprint arXiv:1902.07143*, 2019.
- [17] G. Chiribella, G. M. D’Ariano, and P. Perinotti. Quantum circuit architecture. *Physical Review Letters*, 101:060401, 2008.
- [18] G. Chiribella, G. M. D’Ariano, and P. Perinotti. Probabilistic theories with purification. *Physical Review A*, 81(6):062348, 2010.
- [19] G. Chiribella, G. M. D’Ariano, and P. Perinotti. Informational derivation of quantum theory. *Physical Review A*, 84(1):012311, 2011.
- [20] G. Chiribella, G. M. D’Ariano, P. Perinotti, and B. Valiron. Quantum computations without definite causal structure. *Physical Review A*, 88(2):022318, 2013.

- [21] S. Clark, B. Coecke, E. Grefenstette, S. Pulman, and M. Sadrzadeh. A quantum teleportation inspired algorithm produces sentence meaning from word meaning and grammatical structure. *Malaysian Journal of Mathematical Sciences*, 8:15–25, 2014. arXiv:1305.0556.
- [22] S. Clark, B. Coecke, and M. Sadrzadeh. A compositional distributional model of meaning. In *Proceedings of the Second Quantum Interaction Symposium (QI-2008)*, pages 133–140, 2008.
- [23] B. Coecke. Kindergarten quantum mechanics. In A. Khrennikov, editor, *Quantum Theory: Reconsiderations of the Foundations III*, pages 81–98. AIP Press, 2005. arXiv:quant-ph/0510032.
- [24] B. Coecke. Quantum picturalism. *Contemporary Physics*, 51:59–83, 2009. arXiv:0908.1787.
- [25] B. Coecke. Terminality implies no-signalling... and much more than that. *New Generation Computing*, 34:69–85, 2016.
- [26] B. Coecke. From quantum foundations via natural language meaning to a theory of everything. In S. B. Cooper and M. I. Soskova, editors, *The Incomputable: Journeys Beyond the Turing Barrier*, Theory and Applications of Computability, pages 63–80. Springer International Publishing, 2017. arXiv:1602.07618.
- [27] B. Coecke. The mathematics of text structure, 2019. arXiv:1904.03478.
- [28] B. Coecke, G. de Felice, K. Meichanetzidis, and A. Toumi. Foundations for near-term quantum natural language processing, 2020.
- [29] B. Coecke, G. de Felice, K. Meichanetzidis, and A. Toumi. How to make qubits speak. In E. R. Miranda, editor, *Quantum Computing in the Arts and Humanities*, page to appear. Springer, 2021.
- [30] B. Coecke and R. Duncan. Interacting quantum observables. In *Proceedings of the 37th International Colloquium on Automata, Languages and Programming (ICALP)*, Lecture Notes in Computer Science, 2008.
- [31] B. Coecke and R. Duncan. Interacting quantum observables: categorical algebra and diagrammatics. *New Journal of Physics*, 13:043016, 2011. arXiv:quant-ph/09064725.
- [32] B. Coecke, R. Duncan, A. Kissinger, and Q. Wang. Strong complementarity and non-locality in categorical quantum mechanics. In *Proceedings of the 27th Annual IEEE Symposium on Logic in Computer Science (LICS)*, 2012. arXiv:1203.4988.
- [33] B. Coecke, B. Edwards, and R. W. Spekkens. Phase groups and the origin of non-locality for qubits. *Electronic Notes in Theoretical Computer Science*, 270(2):15–36, 2011. arXiv:1003.5005.
- [34] B. Coecke, F. Genovese, S. Gogioso, D. Marsden, and R. Piedeleu. Uniqueness of composition in quantum theory and linguistics. In *Proceedings of QPL*, 2018. arXiv:1803.00708.
- [35] B. Coecke, D. Horsman, A. Kissinger, and Q. Wang. Kindergarten quantum mechanics graduates (... or how i learned to stop gluing lego together and love the ZX-calculus). *arXiv preprint arXiv:2102.10984*, 2021.

- [36] B. Coecke and A. Kissinger. The compositional structure of multipartite quantum entanglement. In *Automata, Languages and Programming*, Lecture Notes in Computer Science, pages 297–308. Springer, 2010. arXiv:1002.2540.
- [37] B. Coecke and A. Kissinger. Categorical quantum mechanics I: causal quantum processes. In E. Landry, editor, *Categories for the Working Philosopher*. Oxford University Press, 2016. arXiv:1510.05468.
- [38] B. Coecke and A. Kissinger. *Picturing Quantum Processes. A First Course in Quantum Theory and Diagrammatic Reasoning*. Cambridge University Press, 2017.
- [39] B. Coecke and K. Meichanetzidis. Meaning updating of density matrices. *Journal of Applied Logics*, 2631(5):745, 2020. arXiv:2001.00862.
- [40] B. Coecke, D. J. Moore, and A. Wilce. Operational quantum logic: An overview. In B. Coecke, D.J. Moore, and A. Wilce, editors, *Current Research in Operational Quantum Logic: Algebras, Categories and Languages*, volume 111 of *Fundamental Theories of Physics*, pages 1–36. Springer-Verlag, 2000. arXiv:quant-ph/0008019.
- [41] B. Coecke and É. O. Paquette. Categories for the practicing physicist. In B. Coecke, editor, *New Structures for Physics*, Lecture Notes in Physics, pages 167–271. Springer, 2011. arXiv:0905.3010.
- [42] B. Coecke, É. O. Paquette, and D. Pavlović. Classical and quantum structuralism. In S. Gay and I. Mackie, editors, *Semantic Techniques in Quantum Computation*, pages 29–69. Cambridge University Press, 2010. arXiv:0904.1997.
- [43] B. Coecke and D. Pavlovic. Quantum measurements without sums. In G. Chen, L. Kauffman, and S. Lamonaco, editors, *Mathematics of Quantum Computing and Technology*, pages 567–604. Taylor and Francis, 2007. arXiv:quant-ph/0608035.
- [44] B. Coecke, D. Pavlović, and J. Vicary. A new description of orthogonal bases. *Mathematical Structures in Computer Science*, to appear, 23:555–567, 2013. arXiv:quant-ph/0810.1037.
- [45] B. Coecke and S. Perdrix. Environment and classical channels in categorical quantum mechanics. In *Proceedings of the 19th EACSL Annual Conference on Computer Science Logic (CSL)*, volume 6247 of *Lecture Notes in Computer Science*, pages 230–244, 2010. Extended version: arXiv:1004.1598.
- [46] B. Coecke, M. Sadrzadeh, and S. Clark. Mathematical foundations for a compositional distributional model of meaning. In J. van Benthem, M. Moortgat, and W. Buszkowski, editors, *A Festschrift for Jim Lambek*, volume 36 of *Linguistic Analysis*, pages 345–384. 2010. arxiv:1003.4394.
- [47] B. Coecke and Q. Wang. ZX-rules for 2-qubit clifford+T quantum circuits. In Jarkko Kari and Irek Ulidowski, editors, *Reversible Computation - 10th International Conference, RC 2018, Leicester, UK, September 12-14, 2018, Proceedings*, volume 11106 of *Lecture Notes in Computer Science*, pages 144–161. Springer, 2018.
- [48] B. Coecke and V. Wang. Distilling grammar into circuits (or, de-humanising grammar for efficient machine use). 2021.

- [49] B. Coecke and V. Wang. Grammar equations. *arXiv preprint arXiv:2106.07485*, 2021.
- [50] N. de Beaudrap, X. Bian, and Q. Wang. Fast and effective techniques for t-count reduction via spider nest identities. In *15th Conference on the Theory of Quantum Computation, Communication and Cryptography (TQC 2020)*. Schloss Dagstuhl-Leibniz-Zentrum für Informatik, 2020. arXiv:2004.05164.
- [51] N. de Beaudrap and D. Horsman. The ZX calculus is a language for surface code lattice surgery. *arXiv preprint arXiv:1704.08670*, 2017.
- [52] R. Duncan, A. Kissinger, S. Pedrix, and J. van de Wetering. Graph-theoretic simplification of quantum circuits with the ZX-calculus. *arXiv preprint arXiv:1902.03178*, 2019.
- [53] R. Duncan, A. Kissinger, S. Perdrix, and J. Van De Wetering. Graph-theoretic simplification of quantum circuits with the ZX-calculus. *Quantum*, 4:279, 2020.
- [54] R. Duncan and S. Perdrix. Rewriting measurement-based quantum computations with generalised flow. In *Proceedings of ICALP*, Lecture Notes in Computer Science, pages 285–296. Springer, 2010.
- [55] J. R. Firth. A Synopsis of Linguistic Theory, 1930-1955. *Studies in Linguistic Analysis*, pages 1–32, 1957.
- [56] B. Fong and D. I. Spivak. Seven sketches in compositionality: An invitation to applied category theory. *arXiv preprint arXiv:1803.05316*, 2018.
- [57] G. Frege. *Die Grundlagen der Arithmetik: eine logisch mathematische Untersuchung über den Begriff der Zahl*. w. Koebner, 1884.
- [58] G. Frege. Letter to Jourdain. *Philosophical and mathematical correspondence*, pages 78–80, 1914.
- [59] P. Gärdenfors. *Conceptual spaces: the geometry of thought*. MIT Press, 2000.
- [60] P. Gärdenfors. *The Geometry of Meaning: Semantics Based on Conceptual Spaces*. MIT Press, 2014.
- [61] N. Ghani, J. Hedges, V. Winschel, and P. Zahn. Compositional game theory. In *Proceedings of the 33rd Annual ACM/IEEE Symposium on Logic in Computer Science*, pages 472–481. ACM, 2018.
- [62] D. R. Ghica. Geometry of synthesis: a structured approach to vlsi design. In *Proceedings of the 34th annual ACM SIGPLAN-SIGACT symposium on Principles of programming languages*, pages 363–375, 2007.
- [63] C. Gidney and A. G. Fowler. Efficient magic state factories with a catalyzed $|CCZ\rangle$ to $2|T\rangle$ transformation. *Quantum*, 3:135, April 2019.
- [64] F. B. Gilbreth and L. M. Gilbreth. Process charts and their place in management. *Mechanical engineering*, 70:38–41, 1922.
- [65] S. Gogioso, D. Marsden, and B. Coecke. Symmetric monoidal structure with local character is a property. In *Proceedings of QPL*, 2018. arXiv:1805.12088.

- [66] D. Gottesman and I. L. Chuang. Demonstrating the viability of universal quantum computation using teleportation and single-qubit operations. *Nature*, 402(6760):390–393, 1999.
- [67] D. M. Greenberger, M. A. Horne, A. Shimony, and A. Zeilinger. Bell’s theorem without inequalities. *American Journal of Physics*, 58:1131–1143, 1990.
- [68] E. Grefenstette and M. Sadrzadeh. Experimental support for a categorical compositional distributional model of meaning. In *The 2014 Conference on Empirical Methods on Natural Language Processing.*, pages 1394–1404, 2011. arXiv:1106.4058.
- [69] A. Hadzihasanovic. A diagrammatic axiomatisation for qubit entanglement. In *Proceedings of the 30th Annual IEEE Symposium on Logic in Computer Science (LICS)*, 2015. arXiv:1501.07082.
- [70] A. Hadzihasanovic, K. F. Ng, and Q. Wang. Two complete axiomatisations of pure-state qubit quantum computing. In *Proceedings of the 33rd Annual ACM/IEEE Symposium on Logic in Computer Science*, pages 502–511. ACM, 2018.
- [71] L. Hardy. Foliabile operational structures for general probabilistic theories. In H. Halvorson, editor, *Deep Beauty: Understanding the Quantum World through Mathematical Innovation*, pages 409–442. Cambridge University Press, 2011. arXiv:0912.4740.
- [72] Z. S. Harris. Distributional structure. *Word*, 10(2-3):146–162, 1954.
- [73] R. Hinze and D. Marsden. Equational reasoning with lollipops, forks, cups, caps, snakes, and speedometers. *Journal of Logical and Algebraic Methods in Programming*, pages –, 2016.
- [74] T. M. V. Janssen. Frege, contextuality and compositionality. *Journal of Logic, Language and Information*, 10(1):115–136, 2001.
- [75] E. Jeandel, S. Perdrix, and R. Vilmart. A complete axiomatisation of the ZX-calculus for clifford+t quantum mechanics. In *Proceedings of the 33rd Annual ACM/IEEE Symposium on Logic in Computer Science*, pages 559–568, 2018. arXiv preprint arXiv:1705.11151.
- [76] D. Kartsaklis, I. Fan, R. Yeung, A. Pearson, R. Lorenz, A. Toumi, G. de Felice, K. Meichanetzidis, S. Clark, and B. Coecke. lambeq: An efficient high-level Python library for quantum NLP. *arXiv preprint arXiv:2110.04236*, 2021.
- [77] D. Kartsaklis and M. Sadrzadeh. Prior disambiguation of word tensors for constructing sentence vectors. In *The 2013 Conference on Empirical Methods on Natural Language Processing.*, pages 1590–1601. ACL, 2013.
- [78] G. M. Kelly. Many-variable functorial calculus I. In G. M. Kelly, M. Laplaza, G. Lewis, and S. Mac Lane, editors, *Coherence in Categories*, volume 281 of *Lecture Notes in Mathematics*, pages 66–105. Springer-Verlag, 1972.
- [79] G. M. Kelly and M. L. Laplaza. Coherence for compact closed categories. *Journal of Pure and Applied Algebra*, 19:193–213, 1980.
- [80] A. Kissinger, M. Hoban, and B. Coecke. Equivalence of relativistic causal structure and process terminally. *arXiv:1708.04118 [quant-ph]*, 2017.

- [81] A. Kissinger and S. Uijlen. A categorical semantics for causal structure. In *2017 32nd Annual ACM/IEEE Symposium on Logic in Computer Science (LICS)*, pages 1–12. IEEE, 2017.
- [82] A. Kissinger and J. van de Wetering. PyZX: Large scale automated diagrammatic reasoning. *arXiv preprint arXiv:1904.04735*, 2019.
- [83] A. Kissinger and J. van de Wetering. Reducing the number of non-clifford gates in quantum circuits. *Phys. Rev. A*, 102:022406, Aug 2020.
- [84] J. Lambek. The mathematics of sentence structure. *American Mathematics Monthly*, 65, 1958.
- [85] J. Lambek. From word to sentence. *Polimetrica, Milan*, 2008.
- [86] T. Leinster. *Higher Operads, Higher Categories*. Cambridge University Press, 2004.
- [87] R. Lorenz, A. Pearson, K. Meichanetzidis, D. Kartsalkis, and B. Coecke. Qnlp in practice: Running compositional models of meaning on a quantum computer. *arXiv preprint arXiv:2102.12846*, 2021.
- [88] S. Mac Lane. *Categories for the working mathematician*. Springer-verlag, 1998.
- [89] K. Meichanetzidis, S. Gogioso, G. de Felice, A. Toumi, N. Chiappori, and B. Coecke. Quantum natural language processing on near-term quantum computers. *Accepted for QPL 2020*, 2020. arXiv preprint arXiv:2005.04147.
- [90] K. Meichanetzidis, A. Toumi, G. de Felice, and B. Coecke. Grammar-aware question-answering on quantum computers. *arXiv preprint arXiv:2012.03756*, 2020.
- [91] R. Montague. Universal grammar. *Theoria*, 36:373–398, 1970.
- [92] R. Montague. The proper treatment of quantification in ordinary English. In *Approaches to natural language*, pages 221–242. Springer, 1973.
- [93] R. M. Nefdt. A puzzle concerning compositionality in machines. *Minds & Machines*, 30(1), 2020.
- [94] O. Oreshkov, F. Costa, and Č. Brukner. Quantum correlations with no causal order. *Nature communications*, 3:1092, 2012.
- [95] D. Pavlovic. Monoidal computer i: Basic computability by string diagrams. *Information and computation*, 226:94–116, 2013.
- [96] D. Pavlovic. Twitter replies, 2021.
- [97] R. Piedeleu, D. Kartsaklis, B. Coecke, and M. Sadrzadeh. Open system categorical quantum semantics in natural language processing. In *6th Conference on Algebra and Coalgebra in Computer Science (CALCO 2015)*. Schloss Dagstuhl-Leibniz-Zentrum fuer Informatik, 2015.
- [98] S. Pulman. Distributional semantic models. In C. Heunen, M. Sadrzadeh, and E. Grefenstette, editors, *Quantum Physics and Linguistics. A Compositional, Diagrammatic Discourse*, pages 333 – 358. Oxford University Press, 2013.

- [99] R. Raussendorf, D.E. Browne, and H.J. Briegel. Measurement-based quantum computation on cluster states. *Physical Review A*, 68(2):22312, 2003.
- [100] M. Sadrzadeh, S. Clark, and B. Coecke. The Frobenius anatomy of word meanings I: subject and object relative pronouns. *Journal of Logic and Computation*, 23:1293–1317, 2013. arXiv:1404.5278.
- [101] D. Schmid, J. H. Selby, and R. W. Spekkens. Unscrambling the omelette of causation and inference: The framework of causal-inferential theories. *arXiv preprint arXiv:2009.03297*, 2020.
- [102] E. Schrödinger. Discussion of probability relations between separated systems. *Mathematical Proceedings of the Cambridge Philosophical Society*, 31:555–563, 1935.
- [103] J. Seibt. Process philosophy. *Stanford Encyclopedia of Philosophy*, 2012.
- [104] J. H. Selby and B. Coecke. Leaks: quantum, classical, intermediate and more. *Entropy*, 19(4):174, 2017.
- [105] J. H. Selby, C. M. Scandolo, and B. Coecke. Reconstructing quantum theory from diagrammatic postulates. *arXiv preprint arXiv:1802.00367*, 2018.
- [106] P. Selinger. Dagger compact closed categories and completely positive maps. *Electronic Notes in Theoretical Computer Science*, 170:139–163, 2007.
- [107] D. Shiebler, B. Gavranović, and P. Wilson. Category theory in machine learning. *arXiv preprint arXiv:2106.07032*, 2021.
- [108] S. Sivarajah, S. Dilkes, A. Cowtan, W. Simmons, A. Edgington, and R. Duncan. $t|ket\rangle$: A retargetable compiler for NISQ devices. *arXiv preprint arXiv:2003.10611*, 2020.
- [109] T. St Clere Smithe. Bayesian updates compose optically. *arXiv preprint arXiv:2006.01631*, 2020.
- [110] R. Vilmart. A near-minimal axiomatisation of ZX-calculus for pure qubit quantum mechanics. In *2019 34th Annual ACM/IEEE Symposium on Logic in Computer Science (LICS)*, pages 1–10. IEEE, 2019.
- [111] J. von Neumann. *Mathematische Grundlagen der Quantenmechanik*. Springer-Verlag, 1932. Translation, *Mathematical foundations of quantum mechanics*, Princeton University Press, 1955.
- [112] V. Wang-Mascianica and B. Coecke. Talking space: inference from spatial linguistic meanings. *arXiv preprint arXiv:2109.06554*, 2021.
- [113] A. N. Whitehead. *Process and reality*. Harper & Row, 1957.
- [114] D. Widdows. Orthogonal negation in vector spaces for modelling word-meanings and document retrieval. In *41st Annual Meeting of the Association for Computational Linguistics*, Japan, 2003.
- [115] D. Widdows and S. Peters. Word vectors and quantum logic: Experiments with negation and disjunction. *Mathematics of language*, 8(141-154), 2003.

- [116] L. Wittgenstein. *Philosophical Investigations*. Blackwell Publishing, 1953.
- [117] W. Zeng and B. Coecke. Quantum algorithms for compositional natural language processing. *Electronic Proceedings in Theoretical Computer Science*, 221, 2016. arXiv:1608.01406.
- [118] M. Zukowski, A. Zeilinger, M. A. Horne, and A. K. Ekert. Event-ready-detectors Bell experiment via entanglement swapping. *Physical Review Letters*, 71:4287–4290, 1993.