

Parallel Actors and Learners: A Framework for Generating Scalable RL Implementations*

Chi Zhang

Department of Computer Science
University of Southern California
Los Angeles, USA
zhan527@usc.edu

Sanmukh Rao Kuppannagari, Viktor K Prasanna

Department of Electrical and Computer Engineering
University of Southern California
Los Angeles, USA
kuppanna@usc.edu, prasanna@usc.edu

Abstract—Reinforcement Learning (RL) has achieved significant success in application domains such as robotics, games, health care and others. However, training RL agents is very time consuming. Current implementations exhibit poor performance due to challenges such as irregular memory accesses and synchronization overheads.

In this work, we propose a framework for generating scalable reinforcement learning implementations on multicore systems. Replay Buffer is a key component of RL algorithms which facilitates storage of samples obtained from environmental interactions and their sampling for the learning process. We define a new data structure for prioritized replay buffer based on K -ary sum tree that supports asynchronous parallel insertions, sampling, and priority updates. To address the challenge of irregular memory accesses, we propose a novel data layout to store the nodes of the sum tree that reduces the number of cache misses. Additionally, we propose *lazy writing* mechanism to reduce synchronization overheads of the replay buffer. Our framework employs parallel actors to concurrently collect data via environmental interactions, and parallel learners to perform stochastic gradient descent using the collected data. Our framework supports a wide range of reinforcement learning algorithms including DQN, DDPG, TD3, SAC, etc. We demonstrate the effectiveness of our framework in accelerating RL algorithms by performing experiments on CPU + GPU platform using OpenAI benchmarks. Our results show that the performance of our approach scales linearly with the number of cores. Compared with the baseline approaches, we reduce the convergence time by 3.1x~10.8x. By plugging our replay buffer implementation into existing open source reinforcement learning frameworks, we achieve 1.1x~2.1x speedup for sequential executions.

Index Terms—parallel reinforcement learning, prioritized replay buffer, parameter server

I. INTRODUCTION

Reinforcement Learning (RL) has shown great success in a wide range of applications including board games [1], strategy games [2], energy systems [3], robotics [4], recommendation systems [5], hyperparameter selection [6] etc. Typically, RL algorithms train by iteratively collecting the data by interacting with a simulator of the environment, and learning a model using the collected data. However, it takes a considerable amount of time to train a reinforcement learning agent to converge. This is because: 1) the speed of data collection is

limited by the complexity of the environment simulator which needs to accurately represent the real world physical system; 2) the large state space needed to represent a typical real-world physical system makes it necessary to gather a large amount of data to successfully train a RL agent. We show the training time versus the size of the state space of three popular environments used in RL training in Figure 1. On Mujoco [7], which is a physics engine to simulate robotics, biomechanics, etc., it takes around 3 hours to train an agent using Pytorch [8] on a 4-core machine with a GTX 1060 GPU. On Atari [9], which is a game simulator, it takes around 12 hours to train on the same machine. The state-of-the-art RL algorithm for playing Go — AlphaGo Zero [10] was trained on 4 TPUs [11] for 21 days. Thus, developing faster reinforcement learning algorithms is an important research direction.

Prior work tackles this problem by deploying parallel agents that can collect data simultaneously [12]–[15]. [12] introduces a parallel framework for Deep Q Network (DQN) [16]. It accelerates the training by using independent actors collecting data asynchronously. The data is stored in a shared replay buffer. Meanwhile, parallel learners sample data uniformly from the replay buffer and compute the gradients. The gradients are sent to the central parameter server [17] for neural network weights update. [13] improves the performance of [12] by using prioritized replay buffer so that important data is sampled with higher weights to accelerate the training.

In these works, replay buffer management becomes a limiting factor in achieving high scalability when increasing parallelism. Improving the performance of parallel replay buffer management via techniques such as careful data structure design or low overhead synchronization has not received much attention. In this work, we optimize the implementation of replay buffer management and propose a framework for generating scalable reinforcement learning implementations. The generated RL implementations are composed of parallel actors and learners executing on computing platforms such as CPUs, GPUs, or FPGAs with replay buffer management executing on a CPU platform. We illustrate our framework by generating RL algorithms targeting a multicore platform. Our key contributions are summarized as follows:

- We propose a new data structure for the prioritized replay buffer based on K -ary sum tree that supports

This work has been sponsored by the U.S. Army Research Office (ARO) under award number W911NF1910362 and the U.S. National Science Foundation (NSF) under award numbers 1911229 and 2009057.

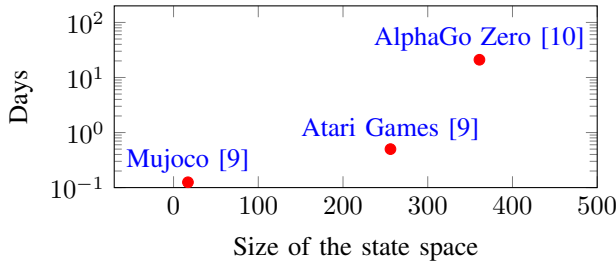

Figure 1. Training time of various environments versus the size of the state space

asynchronous parallel insertions, sampling and priority update.

- We propose a novel data layout to store the nodes of the sum tree to minimize the number of cache misses.
- We propose *lazy writing* mechanism to minimize the synchronization overhead of various operations of the replay buffer.
- Given a hardware configuration, our framework automatically decides the number of actors and learners such that the desired ratio between the throughput of the data collection and the throughput of the learning is achieved.
- Our framework supports a wide range of reinforcement learning algorithms including DQN [16], DDQN [18], DDPG [19], TD3 [20], SAC [21], etc.
- We demonstrate the effectiveness of our framework in accelerating RL algorithms by performing experiments on CPU + GPU platforms using OpenAI [9] benchmarks. Our results show that the performance of our approach scales in linear with the number of cores.
- Compared with the baseline approaches, we reduce the convergence time by $3.1x \sim 10.8x$. By plugging our replay buffer implementation into existing open source reinforcement learning frameworks, we achieve $1.1x \sim 2.1x$ speedup.

II. BACKGROUND

A. Markov Decision Process

Reinforcement learning algorithms aim to solve Markov Decision Process (MDP) with unknown dynamics. A Markov Decision Process [22] is also referred as *world* or *environment* in this context. An environment has five key components as follows:

- State space \mathcal{S} : the set of all possible states in an environment. For example, in the Go game, the state space is all the possible positions of the stones.
- Action space \mathcal{A} : the set of all possible actions. For example, in the Go game, the action space is all the possible moves in the current state.
- System dynamics \mathcal{P} : the function that computes the next state given the current state and the action.
- Reward function \mathcal{R} : the intermediate reward
- Initial state distribution μ : the distribution of states where the agents will be initially at.

We define an episode as one trajectory of the agent acting from the initial state to the terminal state. The policy $\pi(a|s)$ is defined as a stationary function that maps from the state space to the action space. The objective of reinforcement learning is to learn the policy such that the expected long-term accumulated rewards in an episode is maximized.

High level abstractions and APIs Reinforcement learning improves the performance of the agent by learning from the data collected from interacting with the environment. To facilitate the understanding from a system level, we introduce the high level APIs inspired from the ones used in OpenAI gym [9] in Python programming language [23]:

- `def reset () -> S`: return a state by sampling from the initial state distribution μ .
- `def step(a: A) -> (S, float, bool)`: return a tuple of state, reward (float type) and done signal (bool type) by taking action a . The done signal indicates whether the current episode is done. If the current episode is done, call the reset to restart the episode. The environment class maintains its own internal state.
- `def act(s: S) -> A`: the acting function of the agent that takes the current state and outputs the action.
- `def learn(data: Data)`: the learning function of the agent that takes the data and updates its internal weights to improve the performance. The standard Data type contains a tuple consisting of a transition (state (s), action (a), next_state (s'), reward (r)).

B. Reinforcement Learning

In reinforcement learning, a replay buffer is employed [24] to store all the collected data. The agent is updated using data sampled from the replay buffer. We show a generic paradigm of reinforcement learning algorithms in Figure 2. Typical reinforcement learning algorithms include DQN [16], DDQN [18], DDPG [19], TD3 [20], SAC [21], etc. These algorithms only differ in how the learning is performed while the training loop is the same.

C. Prioritized Replay Buffer

To illustrate the motivation of using a prioritized replay buffer [24], we start by examining how the learning is performed in DQN [16]. Deep Q Network (DQN) trains a Q network parameterized by ψ by minimizing the following objective:

$$\min_{\psi} \frac{1}{N} \sum_{i=1}^N (Q_{\psi}(s_i, a_i) - (r_i + \gamma \max_{a'_i} Q_{\psi}(s'_i, a'_i)))^2 \quad (1)$$

where $Q_{\psi}(s, a) - (r + \gamma \max_{a'} Q_{\psi}(s', a'))$ is the temporal difference (TD) error. Uniform sampling from the replay buffer to update the TD error is less effective because the sampled data may already have low TD error. Prioritized replay buffer [24] is proposed to mitigate this problem by assigning a priority to each data point using the TD error:

$$P(i) = |Q_{\psi}(s_i, a_i) - (r_i + \gamma \max_{a'_i} Q_{\psi}(s'_i, a'_i))| \quad (2)$$

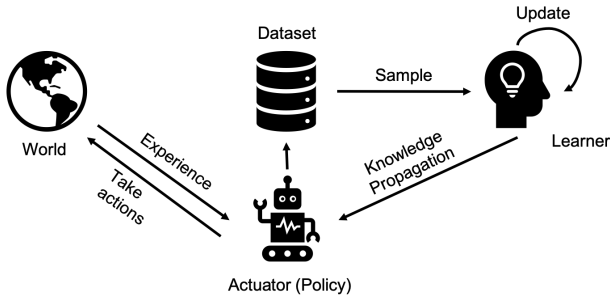

Figure 2. A generic paradigm of reinforcement learning algorithms

Algorithm 1 Generic Reinforcement Learning

```

1: Input: Environment  $env$ , Agent  $\pi_\theta$ , Replay buffer  $\mathcal{B}$ .
2: Output: Trained agent  $\pi_\theta$ .
3: for  $i = 1$ ;  $i \leq \text{iterations}$ ;  $i++$  do
4:   if done then
5:      $obs = env.reset()$ ;  $\triangleright$  Episode terminates
6:   end if
7:    $action = agent.act(obs)$ ;  $\triangleright$  Agent select action
8:    $next\_obs, reward, done = env.step(action)$ ;  $\triangleright$  Actuator
9:    $\mathcal{B}.insert(obs, action, next\_obs, done)$ ;
10:   $obs = next\_obs$ ;
11:  if  $i \% \text{update\_interval} == 0$  then
12:     $index, data = \mathcal{B}.sample(\text{batch\_size})$ ;
13:     $priority = \mathcal{B}.get\_priority(index)$ ;
14:    for  $i$  in  $index$  do
15:       $is(i) = (\frac{1}{N} \cdot \frac{\sum_i P(i)}{P(i)})^\beta$ ;  $\triangleright$  importance weights
16:    end for
17:     $new\_priority = agent.learn(data, is)$ ;
18:     $\mathcal{B}.update\_priority(index, new\_priority)$ ;
19:  end if
20: end for

```

where $P(i)$ denotes the priority of data i . Then, the data is sampled according to the probability proportional to the priority. To fix the bias introduced by the prioritized sampling, importance weights are computed as $is(i) = (\frac{1}{N} \cdot \frac{\sum_i P(i)}{P(i)})^\beta$, where $is(i)$ denotes the importance weights for data i and β is a hyper-parameter. The learning step of DQN using prioritized replay buffer is:

$$\min_{\psi} \frac{1}{N} \sum_{i=1}^N is(i) \cdot (Q_{\psi}(s_i, a_i) - (r_i + \gamma \max_{a'_i} Q_{\psi}(s'_i, a'_i)))^2 \quad (3)$$

After each Q update, the new priority is stored in the replay buffer. A complete training process is shown in Algorithm 1. Other algorithms follow the same structure but differ slightly in the technique used to update the Q function.

III. RELATED WORK

A. Parallel and Distributed Reinforcement Learning

Existing works that aim to improve the execution time of Reinforcement Learning (RL) algorithms focus on increasing

the parallelism by increasing the number of actors and learners. GORILA [12] proposes the first parallel architecture of DQN [16] to play Atari games [9]. They employ independent actors and learners in parallel with a global parameter server. Our method follows the general architecture of GORILA [12] at a high level and proposes detailed data structures and synchronization mechanism to maximize the scalable performance. A3C [14] uses asynchronous actors to collect the data and update the agent using actor critic algorithms without using a replay buffer. Due to synchronization overhead, A3C doesn't scale very well. IMPALA [15] relaxes the synchronization overhead of A3C by using importance sampling. RLlib [25] proposes abstractions for distributed reinforcement learning for software developers built on top of the Ray library [25] written in Python [23]. PAAC [26] proposes parallel advantaged actor critic. They synchronize the actors after every environmental step. This significantly slows down the entire system. In contrast, our actors act independently in parallel. [27] proposes parallel reinforcement learning using popular MapReduce [28] framework with linear function approximation. [29] proposes to use parallel actors to learn in tabular MDP while our method can tackle general continuous space MDP with neural network policies.

A key bottleneck in these works is the management of replay buffer. Synchronization overheads and irregular memory accesses while accessing replay buffer lead to poor scalability when parallelism is increased by adding more hardware resources. Ape-X [13] proposes distributed prioritized replay buffer with parallel actors and a single learner to accelerate reinforcement learning algorithms on large scale clusters. However, to the best of our knowledge, our approach is the first to explicitly focus on improving the efficiency of Replay Buffer management on multi-core platforms by developing a novel data structure and low overhead synchronization mechanisms to enable high throughput parallel replay buffer management.

In addition to these works, specialized hardware designs to accelerate reinforcement learning have also emerged recently. [30] proposes customised Pearlmutter Propagation on FPGAs to accelerate conjugate gradient method used in TRPO [31]. [32] proposes a systolic-array based architecture on FPGAs to accelerate PPO [33]. These works do not require the use of replay buffer.

B. Parallel Stochastic Gradient Descent

We also review techniques for performing parallel stochastic gradient descent as it is used in our learner implementation. [17] proposes parameter server to facilitate parallel stochastic gradient descent. Each worker samples a batch of data, computes the gradients and send them to the central parameter server. The parameter server aggregates the gradients and performs the update. The workers then pull the updated weights from the parameter server. [34] proposes asynchronous stochastic gradient descent to reduce the negative impact of asynchrony with general convergence time bounds.

Algorithm 2 Key operations of the N-ary sum tree.

```

1: function UPDATEVALUE(idx, value)
2:   node_idx = CONVERTTONODEIDX(idx);
3:   Δ = value - GETVALUE(node_idx);
4:   while !ISROOT(node_idx) do
5:     new_value = GETVALUE(node_idx) + Δ;
6:     SETVALUE(node_idx, new_value);
7:     node_idx = GETPARENT(node_idx);
8:   end while
9: end function
10:
11: function GETPREFIXSUMIDX(prefixSum)
12:   node_idx = GETROOT();
13:   while !isLeaf(node_idx) do
14:     node_idx = GETLEFTCHILD(node_idx);
15:     partialSum = 0;
16:     for  $i = 0; i < \text{fan\_out}; i++$  do
17:       sum = partialSum + GETVALUE(node_idx);
18:       if  $\text{sum} \geq \text{prefixSum}$  then
19:         break;
20:       end if
21:       partialSum = sum;
22:       node_idx = GETNEXTSIBLING(node_idx);
23:     end for
24:     prefixSum = prefixSum - partialSum;
25:   end while
26:   idx = CONVERTTODATAIDX(node_idx);
27:   return idx;
28: end function

```

For simplicity, we adopt the parameter server [17] framework and leave advanced asynchronous methods for future work.

IV. PARALLEL PRIORITIZED REPLAY BUFFER

In this section, we discuss in detail the design of our parallel prioritized replay buffer. We start by introducing the key operations that need to be supported.

A. Operations

1) *Insertion*: Given a new data point x , find the next available index i . If the replay buffer is full, find the index using the eviction policy. Set the priority at index i as $P(i) = P_{\max}$, where $P(i)$ is the priority at index i and P_{\max} is the maximum priority in the replay buffer.

2) *Sampling*: Sample a data point x_i according to the probability distribution $Pr(i) = P(i)/\sum_i P(i), i = 1, 2, \dots, N$, where N is the size of the replay buffer. To do so, we first sample x from uniform distribution $U(0, 1)$. Then, we compute the cumulative density function (cdf) as $\text{cdf}(i) = \sum_{j=1}^i Pr(j), i = 1, 2, \dots, N$. Finally, the sampled index $i = \text{cdf}^{-1}(x)$. Mathematically, this is equivalent to finding the

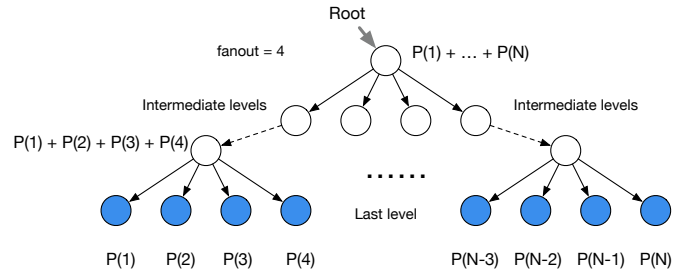

Figure 3. The overall structure of a 4-ary sum tree.

minimum index i , such that the **prefix sum** of the probability from 0 to i is greater than or equal to x :

$$\min_i \sum_{j=1}^i Pr(j) \geq x \Rightarrow \min_i \sum_{j=1}^i P(j) \geq x \cdot \sum_{j=1}^N P(j) \quad (4)$$

3) *Priority retrieval*: Given index i , return the priority $P(i)$.

4) *Priority update*: Given index i , update the priority $P(i)$.

B. Frequency of the Operations and Runtime Requirements

As shown in Algorithm 1, the insertion is executed once per iteration. The sampling, priority retrieval and priority update are executed once every `update_interval`. Directly storing the priority in an array incurs a runtime complexity of $\Theta(N)$ for sampling and $\Theta(1)$ for priority retrieval and priority update. Directly storing the prefix sum in an array incurs a runtime of $\Theta(\log N)$ in sampling, $\Theta(1)$ in priority retrieval and $\Theta(N)$ in priority update. Based on the frequency of the operations, both these implementations incur a runtime complexity of $\Theta(N)$. In this paper, we proposed to use K -ary sum tree to implement the prioritized replay buffer to achieve $\Theta(\log N)$ runtime complexity for both sampling and priority update and thus for the entire implementation.

C. K -ary Sum Tree

We show an example of a K -ary sum tree for $K = 4$ in Figure 3 ($K = 4$). Each node has K child nodes. The value stored in the parent node is the sum of all the values stored in the child nodes. The leaf nodes hold the actual priorities.

1) *Priority retrieval*: In order to obtain the priority for the index i , we create an array of pointers, each pointing to its corresponding leaf node that holds the priority value. Thus, priority retrieval using K -ary sum tree requires $\Theta(1)$ time.

2) *Priority update*: To update the priority of index i , we first obtain its leaf node. We compute the change of the priority by subtracting the old value from the new value. Then, we propagate the change of the priority from the leaf node to the root node by traversing along the parent nodes. We show a detailed function in Algorithm 2 and an example in Figure 4. It is easy to see that this operation requires $\Theta(\log_K N)$ time.

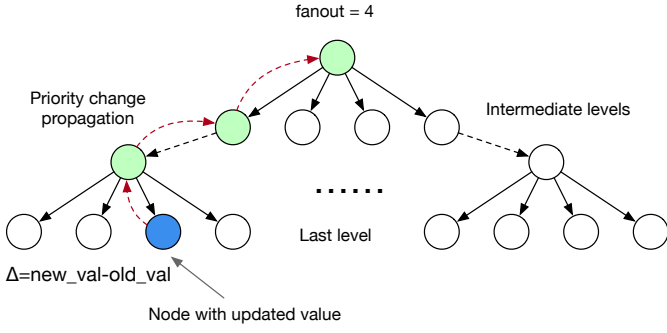

Figure 4. Illustration of the process when updating the value in the K -ary sum tree with fanout=4 as shown in Algorithm 2. The blue node denotes the leaf node that holds the priority. The green nodes denote the intermediate sums that are updated by propagating the change of the priority from the leaf to the root. The red dotted arrow shows the direction of the value propagation.

3) *Prefix sum index computation:* Given a randomly sampled number $x \sim U(0, 1)$, the objective is to compute index $i = \min_i \sum_{j=1}^i P(j) \geq x \cdot \sum_{j=1}^N P(j)$ as discussed in Section IV-A. The sum of all the priorities in the replay buffer $\sum_{j=1}^N P(j)$ can be computed in $\Theta(1)$ by simply retrieving the value stored in the root node. To design an algorithm that obtains the target index, we start by proving Lemma 1 and theorem 2:

Lemma 1. *Let the value of the i -th node at level m be $P_{i,m}$. Assume the height of the tree is H . Then, at level $1 \leq m \leq H$, there exists index j , $1 \leq j \leq K^{m-1}$, such that $\sum_{i=1}^j P_{m,i} \geq x \cdot \sum_{i=1}^N P(i)$, for any $x \in (0, 1)$.*

Proof. According to the definition, the leaf node holds the priority value. Thus, $P_{i,H} = P(i), \forall i = 1, 2, \dots, K^{H-1}$. Since $x \in (0, 1)$, we obtain $x \cdot \sum_{i=1}^N P(i) \leq \sum_{i=1}^N P(i) \leq \sum_{i=1}^{K^{H-1}} P_{i,H}$. Because the priority values are non-negative, there must exist index j , $1 \leq j \leq K^{H-1}$, such that $\sum_{i=1}^j P_{H,i} \geq x \cdot \sum_{i=1}^N P(i)$. According to the property of the sum tree, the value of the parent is the sum of all its children. Thus, $\sum_{i=1}^{K^{H-1}} P_{H,i} = \sum_{i=1}^{K^{m-1}} P_{m,i}, \forall m = 1, 2, \dots, H-1$. Therefore, the same argument holds for each level. This concludes the proof for Lemma 1. \square

Theorem 2. *Let $j_m = \min_{j'} \sum_{i=1}^{j'} P_{m,i} \geq x \cdot \sum_{i=1}^N P(i)$. Then, j_m is the parent node of j_{m+1} , $\forall m = 1, 2, \dots, H-1$.*

Proof. The child nodes of index j at level m are $K \cdot (j-1) + 1, \dots, K \cdot j$ at level $m+1$. According to the definition of the sum tree and the property of j_m , we obtain $\sum_{i=1}^{j_m-1} P_{m,i} = \sum_{i=1}^{K \cdot (j_m-1)} P_{m+1,i} < x \cdot \sum_{i=1}^N P(i)$. Thus, the index of the cutoff node at level $m+1$ must be $j_{m+1} \geq K \cdot (j_m-1) + 1$. Noticing that $\sum_{i=1}^{j_m} P_{m,i} = \sum_{i=1}^{K \cdot (j_m)} P_{m+1,i} \geq x \cdot \sum_{i=1}^N P(i)$. Thus, the index of the cutoff node at level $m+1$ satisfies $j_{m+1} \leq K \cdot j_m$. Combining $K \cdot (j_m-1) \leq j_{m+1} \leq K \cdot j_m$, we obtain j_m is the parent node of j_{m+1} . \square

We refer such node j_m as the *cutoff node* at level m . The goal of sampling is to find the index of the cutoff node at

the last level of the tree. According to Theorem 2, the cutoff node at level m is the parent of the cutoff node at level $m+1$. Therefore, we can start from the root node and perform the search only using the child nodes. To obtain which child node is the cutoff node, we maintain a cumulative sum of all the nodes left to the cutoff at each level. Please refer to Algorithm 2 for details. We also illustrate an example of the process in Figure 5, where $K = 4$ and $H = 6$.

4) *Data layout:* Maintaining the explicit tree data structure using pointers significantly degrades the cache performance of modern CPUs. In this work, we implement the tree data structure implicitly using an array as shown in Figure 6. The sampling process requires traversing all the nodes under the same parent. To maximize the cache performance, it is desired that each group of child nodes under the same parent is cache aligned. Assume that one cacheline can store C nodes, then we choose K , such that $K \% C = 0$. We pad the root node with $K-1$ so that it is also cache aligned.

5) *Theoretical performance analysis:*

a) *Space complexity:* The space complexity is proportional to the number of nodes in the tree. Assume the size of the replay buffer is N , which is equal to the number of nodes in the last level of the tree. Thus, the total number of nodes in the tree is: $\Theta(\frac{K^H-1}{K-1}) = \Theta(\frac{K^{H-1} \cdot K-1}{K-1}) = \Theta(\frac{N \cdot K-1}{K-1}) = \Theta(N + \frac{N-1}{K-1})$. Clearly, as K increases, the space complexity reduces due to the decrease of the number of intermediate nodes.

b) *Runtime complexity:* It is clear that the priority retrieval runs in $\Theta(1)$ and priority update runs in $\Theta(\log_K N)$. For prefix sum index computation, the loops runs $H = \lceil \log_K N \rceil + 1$ times. The memory access inside loop has K/C cache misses and $K \cdot (1 - 1/C)$ cache hit, where C is the number of nodes in one cacheline. Thus, the time complexity of prefix sum index computation is $\Theta((\log_K N + 1)(T_{miss} \cdot \frac{K}{C} + T_{hit} \cdot K \cdot (1 - 1/C)))$, where T_{miss} is the execution time of one cache miss and T_{hit} is the execution time of one cache hit. Note that this function has a local minimum in terms of K . In practice, we profile the performance of various K values based on the size of the cacheline and choose the one that yields the best performance.

D. Thread-safe Prioritized Replay Buffer

In order to support parallel actors and learners, it is crucial to design thread-safe prioritized replay buffer. We summarize the resource utilization of various operations in Table I. We design the thread-safe prioritized replay buffer using locking mechanism such that the duration of holding a lock is minimized.

1) *Synchronization of the sum tree:* We use two locks to synchronize the sum tree: one to synchronize the read/write of the last level of the tree and the other to synchronize the read/write of all the levels. A detailed procedure of priority update and priority retrieval is shown in Algorithm 3. Using this technique, reading of the priority value and updating of the intermediate levels of the sum tree can be executed in parallel. Note that it will cause inconsistencies if we acquire

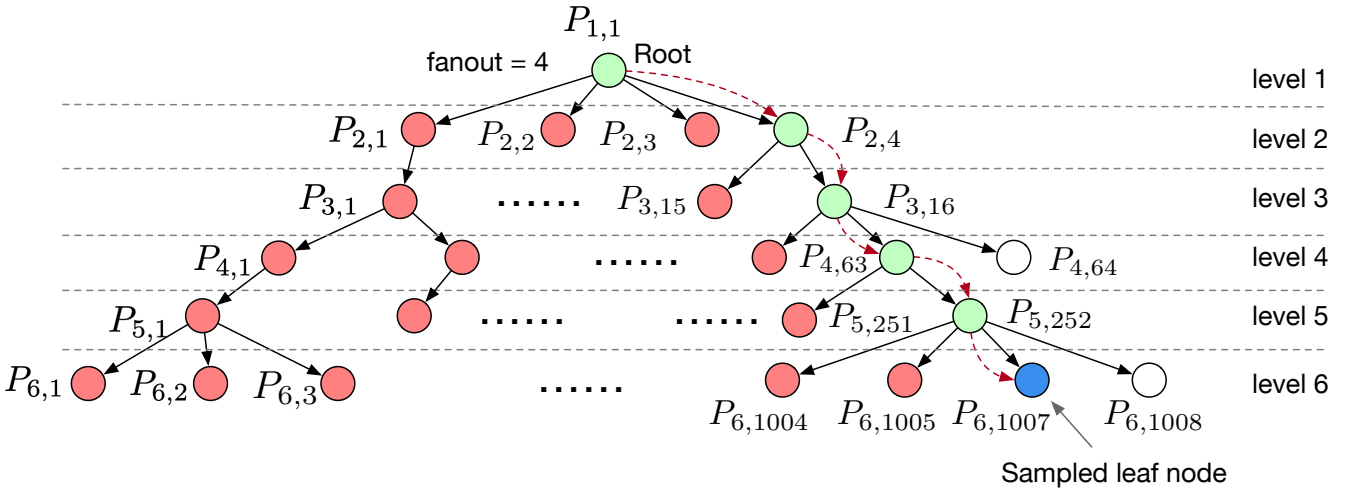

Figure 5. Illustration of the process when sampling index according to the priority in the K -ary sum tree with $\text{fanout}=4$ as shown in Algorithm 2. Starting from the root node, the green nodes denote the cutoff node during traversal and the blue node denotes the leaf node sampled. The red dotted arrow shows the direction of the tree traversal.

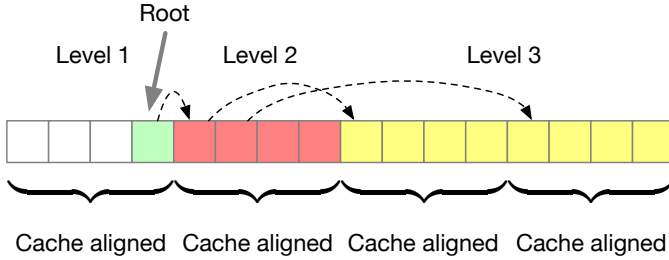

Figure 6. Data layout of the proposed sum tree with $K = 4$. The black arrow shows the first child of the parent node. The color indicates the level of the node in the tree.

the `global_tree_lock` after releasing the `last_level_lock` lock when two priority update queries arrive at the same time.

2) *Synchronization of insertion and sampling*: During insertion, the replay buffer finds an available index. Then, it writes the data to the storage and updates the priority to the maximum priority in the replay buffer. Compared with index searching and priority update, data writing takes more time due to explicit copy of the memory data. Thus, it is important not to hold the lock while performing the data writing. To do so, we propose *lazy writing*: 1) We set the priority to zero atomically; ii) we perform data writing; iii) we reset the priority to the maximum priority in the replay buffer atomically. Since the priority is zero during data writing, it will never be sampled. This makes sampling only needs to synchronize prefix sum index computation. A detailed procedure is shown in Algorithm 3.

3) *Write after read vs. read after write*: The parallelism of the priority update and the data sampling causes data dependency issues: the same data is sampling using the old priority before the new priority gets updated (write after read). Mathematically, only read after write is valid and write after read produces inconsistent results. However, it has little impact

Algorithm 3 Synchronization of the prioritized replay buffer

```

1: function PRIORITYUPDATE(idx, new_priority)
2:   ACQUIRE(global_tree_lock);
3:   ACQUIRE(last_level_lock);
4:   UPDATELASTLEVEL();
5:   RELEASE(last_level_lock);
6:   UPDATEINTERMEDIATELEVEL();
7:   RELEASE(global_tree_lock);
8: end function
9:
10: function PRIORITYRETRIEVAL(idx)
11:   ACQUIRE(last_level_lock);
12:   priority = GETPRIORITY(idx);
13:   RELEASE(last_level_lock);
14:   return priority;
15: end function
16:
17: function INSERT(idx, data)
18:   UPDATEPRIORITY(idx, 0);
19:   WRITESTORAGE(idx, data);
20:   UPDATEPRIORITY(idx, max_priority);
21: end function
22:
23: function SAMPLE()
24:   ACQUIRE(global_tree_lock);
25:   idx, priority = GETPREFIXSUMINDEX();
26:   RELEASE(global_tree_lock);
27:   return idx, priority;
28: end function

```

in practice as neural network training is stochastic in nature and robust to such transient inconsistencies.

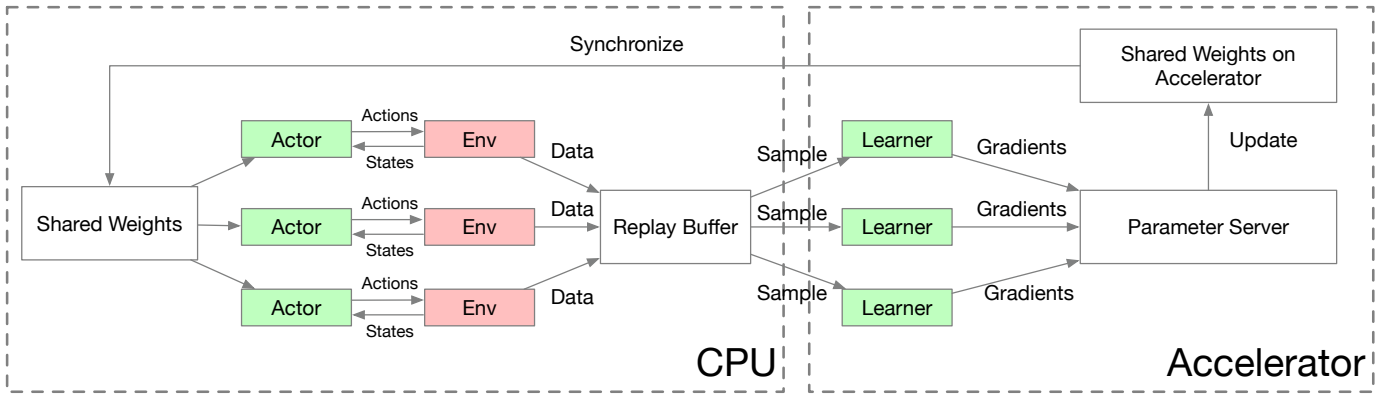

Figure 7. Overall system architecture

Operations	Resource Utilization
Insertion	modify the entire tree, modify the storage
Sampling	access the entire tree, access the storage
Priority retrieval	access the last level of the tree
Priority update	modify the entire tree

V. OVERALL FRAMEWORK

The overall system architecture is shown in Figure 7. We employ parallel actors to collect data and parallel learners to compute the gradients for neural network weights update.

A. Asynchronous Actors

Asynchronous actors collect the data simultaneously by interacting with their own instance of the environment using the shared weights. The data is then added to the replay buffer. It is worth noting that no synchronization is required because the inference doesn't alter the weights.

B. Parallel Learners

Deploying parallel actors increases the throughput of data collection. In order to increase the throughput of the learning, we employ parallel learners with a central parameter server [17]. Each learner independently samples one batch of data from the replay buffer and computes the sub-gradients. The parameter server aggregates the gradients and updates the weights.

C. Framework Specification

Our framework supports a wide range of reinforcement learning algorithms including DQN [16], DDQN [18], DDPG [19], SAC [21], TD3 [20] and so on. The target platform of our framework is processor + accelerator platforms, where the processor is the CPU the accelerator is either the GPU or the FPGA. The input of our framework includes:

- The overall throughput of the data collection vs. the number of CPU cores.
- The overall throughput of the data consumption vs. the number of CPU cores.

- Total number of cores in the CPU.

The throughput of the data collection by a single actor is affected by i) the time of a single environment step function defined in Section II-A; ii) The specifications of the neural networks used in the actors including the architecture (fully-connected vs. convolution networks), the size of each layer, etc. iii) the speed of the processor. The throughput of a single learner is affected by i) the reinforcement learning algorithm; ii) the optimizer iii) the speed of the accelerator.

D. Design Space Exploration

The objective of is to choose the number of actor threads and the number of learner threads such that the ratio between the throughput of the data collection vs. data consumption is the same as the single thread implementation (update_interval denoted in Algorithm 1). In order to obtain the allocation of the cores, we profile the overall throughput of the data collection vs. the number of CPU cores and denote the curve as $f_a(x)$, where x is the number of cores. Similarly, we profile the overall throughput of the data consumption vs. the number of CPU cores and denote the curve as $f_l(x)$. Let the total number of CPU cores be M . Then, the design space exploration is the solution of equation 5:

$$\begin{aligned} f_a(x_a) &= \text{update_interval} \times f_l(x_l) \\ x_a + x_l &\leq M \end{aligned} \quad (5)$$

where x_a and x_l is the allocated number of cores for actors and learners, respectively. If the parallel actors and/or learners are deployed on an accelerator such as GPU or FPGA, instead of CPU, profiling similar to the one described above can be used to perform the design space exploration.

VI. EXPERIMENTS

We design the experiments aim to answer the following questions:

- 1) How does our proposed framework compare against existing baseline approaches? (See Section VI-C)
- 2) How does our proposed locking mechanisms for the prioritized replay buffer reduce the synchronization

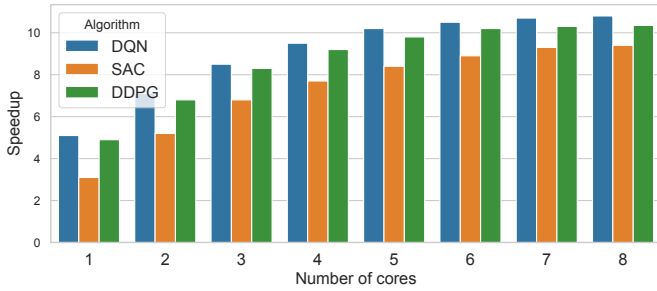

Figure 8. Comparison with the baseline approach

overhead compared with using a global lock? (See Section VI-D)

- 3) Does the performance of our proposed prioritized replay buffer follow the theoretical analysis in Section IV-C in terms of the fanout size K ? (See Section VI-D)
- 4) How does the performance of our proposed framework scale w.r.t the number of CPU cores? (See Section VI-E)
- 5) What is the performance improvement when plugging in our prioritized replay buffer implementation into existing RL frameworks? (See Section VI-F)

A. Experimental Setup

We conduct our experiments on 8-core Intel i7-6700 3.4GHz CPU with 24GB DDR4 memory and a Nvidia GeForce GTX 1650 GPU with 4GB GDDR6 memory as the accelerator. We implement the synchronization mechanism using pthreads [35] and the training of neural networks using LibTorch [8]. We test our framework on 3 reinforcement learning algorithms including DQN [16], DDPG [19], and SAC [21]. DQN targets at discrete action space while DDPG and SAC targets at continuous action space. We use *LunarLander-v2* [9] environment to test the algorithms targeted at discrete action space and *Ant-v2* [7], [9] environment to test the algorithms targeted at continuous action space. In all our experiments, the desired ratio between the throughput of the data collection and the data learning (update_interval) is set to 1.

B. Baseline Approach

In this work, we use RLlib [25] as our baseline. RLlib is an open source implementation of parallel and distributed framework for training reinforcement learning agents written in Python [23]. For fair comparison, we use the same amount of cores when running the experiments.

C. Comparison with Baseline Approaches

We show the performance comparison with RLlib on three RL algorithms with various number of CPU cores in Figure 8. Overall, our approach improves the baseline approach by $3.1x \sim 10.8x$. We observe that with the increase of the number of CPU cores, the speedup increases. This indicates our approach has better scalability in terms of the CPU cores. However, the performance gain eventually saturates. This is because the GPU becomes the main computational bottleneck when the number of learner increases.

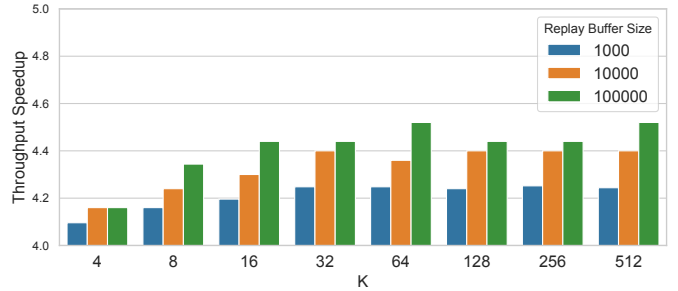

Figure 9. Speedup of the K -ary sum tree compared with binary sum tree

D. Performance of the Prioritized Replay Buffer

In order to answer question 2 and 3, we compare the throughput speedup of our proposed prioritized replay buffer using K -ary sum tree with the implementation using a binary sum tree with a single global lock. To do so, we spawn 4 threads, each thread runs sampling and priority update on the shared replay buffer using random data 1000 times. The throughput speedup is shown in Figure 9. First, we notice that all the throughput speedup is above 4. This is because using a global lock on the replay buffer limits the maximum number of running thread to 1. On the contrary, our proposed locking mechanism provides linear scalability.

To answer question 3, we observe that there exists a local maximum of the throughput speedup when increasing the fanout size of the sum tree K . For example, we choose $K = 256$ when the size of the replay buffer is 1000, $K = 128$ when the size of the replay buffer is 10000 and $K = 64$ when the size of the replay buffer is 100000. It is also worth noticing that the optimal K decreases as the size of the replay buffer increases. This is because as the size of the replay buffer increases, the linear search of the child nodes in one level dominates.

E. Scalability Analysis

We compare our proposed parallel framework with various CPU cores against the sequential version on various RL algorithms. We show the scalability of our propose framework in Figure 10. We notice that the performance scales in linear when the number of CPU cores is below 4. The scalability saturates when the number of cores is above 6. The reason is that the bottleneck of the system becomes the GPU, which performs gradient computations and aggregations.

F. Performance improvement of existing frameworks using our proposed replay buffer

In order to show the superiority of our proposed prioritized replay buffer, we write a Python binding of the C++ implementation and plug it into existing open source RL frameworks including tianshou [36], PFRL [37] and rlpyt [38]. We show the speed up of five RL algorithms in Figure 11. Overall, we achieve $1.1x \sim 2.1x$ performance improvement. The performance improvement of tianshou library is minimal as they implement the prioritized replay buffer using CPython

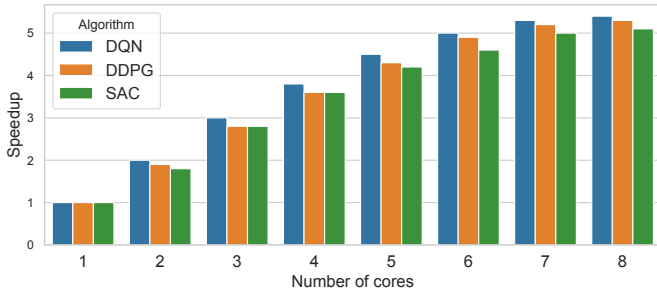

Figure 10. Scalability of various algorithms

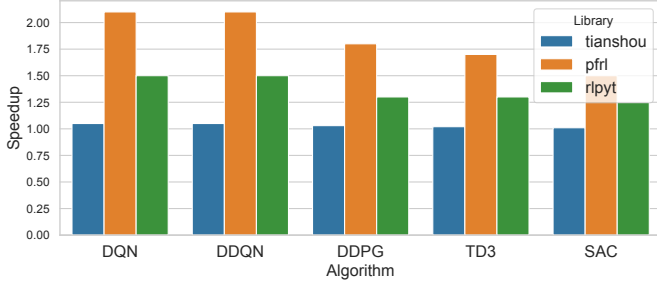

Figure 11. Overall speedup by plugging our prioritized replay buffer implementation into existing open source reinforcement learning libraries.

while the other two libraries use pure Python implementations. The speedup decreases as the computational complexity of the RL algorithms increases because the proportion of the replay buffer operations time decreases.

G. Design Space Exploration

As discussed in Section V-D, the objective is to allocate the number of cores for actors and learners, respectively such that the desired throughput ratio of the data collection and the data consumption is met. Our framework will first profile the throughput curve of actors and learners. We show an example in Figure 12, where the desired throughput ratio is 1. Then, we perform exhaustive search to find the solution x_a and x_b of Equation 5. The time complexity of the exhaustive search is $O(M^2)$, where M is the total number of cores in the processor.

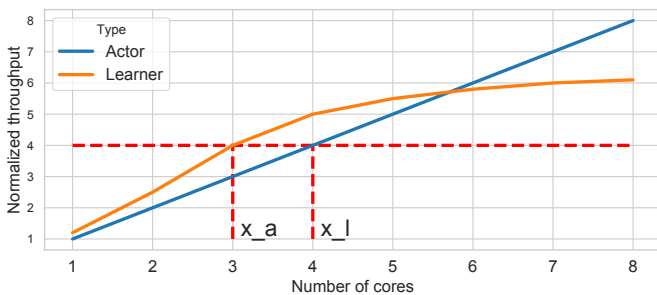

Figure 12. Illustration of design space exploration

H. Impact of the Data Layout

The total size of the sum tree used in a typical replay buffer of size 1 million is less 10 KB. This makes the whole sum tree fit into the L2 cache of the modern CPUs. Thus, we only observe around 1% benefit of our proposed cache aligned data layout. However, as the increase of the replay buffer size on larger problems, the superiority of our proposed data layout will appear.

VII. CONCLUSIONS AND FUTURE WORK

In this work, we propose a framework for generating scalable RL implementations on processor with accelerator platforms. We propose to use parallel actors and learners to increase the throughput of the data collection and the data consumption. To support asynchronous actors and learners, we propose a prioritized replay buffer based on K -ary sum tree data structure. We propose *lazy writing* locking mechanism to minimize the synchronization effort. Our experiments demonstrate that our proposed framework is superior to baseline approaches and scales in linear w.r.t the number of cores. Given hardware resources, our framework can automatically generate the number of actor threads and learner threads such that the desired ratio between data collection and data consumption is met. Future work includes implementation of the learners on various accelerator types including GPU clusters and FPGAs.

REFERENCES

- [1] D. Silver, A. Huang, C. J. Maddison, A. Guez, L. Sifre, G. van den Driessche, J. Schrittwieser, I. Antonoglou, V. Panneershelvam, M. Lanctot, S. Dieleman, D. Grewe, J. Nham, N. Kalchbrenner, I. Sutskever, T. Lillicrap, M. Leach, K. Kavukcuoglu, T. Graepel, and D. Hassabis, “Mastering the game of go with deep neural networks and tree search,” *Nature*, vol. 529, pp. 484–503, 2016. [Online]. Available: <http://www.nature.com/nature/journal/v529/n7587/full/nature16961.html>
- [2] O. Vinyals, I. Babuschkin, J. Chung, M. Mathieu, M. Jaderberg, W. Czarnecki, A. Dudzik, A. Huang, P. Georgiev, R. Powell, T. Ewalds, D. Horgan, M. Kroiss, I. Danihelka, J. Agapiou, J. Oh, V. Dalibard, D. Choi, L. Sifre, Y. Sulsky, S. Vezhnevets, J. Molloy, T. Cai, D. Budden, T. Paine, C. Gulcehre, Z. Wang, T. Pfaff, T. Pohlen, D. Yogatama, J. Cohen, K. McKinney, O. Smith, T. Schaul, T. Lillicrap, C. Apps, K. Kavukcuoglu, D. Hassabis, and D. Silver, “AlphaStar: Mastering the Real-Time Strategy Game StarCraft II,” <https://deepmind.com/blog/alphastar-mastering-real-time-strategy-game-starcraft-ii/>, 2019.
- [3] C. Zhang, S. R. Kuppannagari, R. Kannan, and V. K. Prasanna, “Building hvac scheduling using reinforcement learning via neural network based model approximation,” in *Proceedings of the 6th ACM International Conference on Systems for Energy-Efficient Buildings, Cities, and Transportation*, ser. BuildSys ’19. New York, NY, USA: Association for Computing Machinery, 2019, pp. 287–296. [Online]. Available: <https://doi.org/10.1145/3360322.3360861>
- [4] L.-J. Lin, “Reinforcement learning for robots using neural networks,” Ph.D. dissertation, USA, 1992.
- [5] S. Choi, H. Ha, U. Hwang, C. Kim, J.-W. Ha, and S. Yoon, “Reinforcement learning based recommender system using biclustering technique,” *ArXiv*, vol. abs/1801.05532, 2018.
- [6] H. Zhan, G. Gomes, X. S. Li, K. Madduri, and K. Wu, “Efficient online hyperparameter learning for traffic flow prediction,” in *2018 21st International Conference on Intelligent Transportation Systems (ITSC)*, 2018, pp. 164–169.
- [7] E. Todorov, T. Erez, and Y. Tassa, “Mujoco: A physics engine for model-based control,” in *2012 IEEE/RSJ International Conference on Intelligent Robots and Systems*, 2012, pp. 5026–5033.

- [8] A. Paszke, S. Gross, F. Massa, A. Lerer, J. Bradbury, G. Chanan, T. Killeen, Z. Lin, N. Gimelshein, L. Antiga, A. Desmaison, A. Kopf, E. Yang, Z. DeVito, M. Raison, A. Tejani, S. Chilamkurthy, B. Steiner, L. Fang, J. Bai, and S. Chintala, "Pytorch: An imperative style, high-performance deep learning library," in *Advances in Neural Information Processing Systems* 32, H. Wallach, H. Larochelle, A. Beygelzimer, F. d'Alché-Buc, E. Fox, and R. Garnett, Eds. Curran Associates, Inc., 2019, pp. 8024–8035. [Online]. Available: <http://papers.nips.cc/paper/9015-pytorch-an-imperative-style-high-performance-deep-learning-library.pdf>
- [9] G. Brockman, V. Cheung, L. Pettersson, J. Schneider, J. Schulman, J. Tang, and W. Zaremba, "Openai gym," 2016.
- [10] D. Silver, J. Schrittwieser, K. Simonyan, I. Antonoglou, A. Huang, A. Guez, T. Hubert, L. Baker, M. Lai, A. Bolton, Y. Chen, T. Lillicrap, F. Hui, L. Sifre, G. van den Driessche, T. Graepel, and D. Hassabis, "Mastering the game of go without human knowledge," *Nature*, vol. 550, no. 7676, pp. 354–359, 2017. [Online]. Available: <https://doi.org/10.1038/nature24270>
- [11] N. P. Jouppi, C. Young, N. Patil, D. A. Patterson, G. Agrawal, R. Bajwa, S. Bates, S. Bhatia, N. Boden, A. Borchers, R. Boyle, P. Cantin, C. Chao, C. Clark, J. Coriell, M. Daley, M. Dau, J. Dean, B. Gelb, T. V. Ghemmaghami, R. Gottipati, W. Gulland, R. Hagmann, R. C. Ho, D. Hogberg, J. Hu, R. Hundt, D. Hurt, J. Ibarz, A. Jaffey, A. Jaworski, A. Kaplan, H. Khaitan, A. Koch, N. Kumar, S. Lacy, J. Laudon, J. Law, D. Le, C. Leary, Z. Liu, K. Lucke, A. Lundin, G. MacKean, A. Maggiore, M. Mahony, K. Miller, R. Nagarajan, R. Narayanaswami, R. Ni, K. Nix, T. Norrie, M. Omernick, N. Penukonda, A. Phelps, J. Ross, A. Salek, E. Samadiani, C. Severn, G. Sizikov, M. Snellham, J. Souter, D. Steinberg, A. Swing, M. Tan, G. Thorson, B. Tian, H. Toma, E. Tuttle, V. Vasudevan, R. Walter, W. Wang, E. Wilcox, and D. H. Yoon, "In-datacenter performance analysis of a tensor processing unit," *CoRR*, vol. abs/1704.04760, 2017. [Online]. Available: <http://arxiv.org/abs/1704.04760>
- [12] A. Nair, P. Srinivasan, S. Blackwell, C. Alcicek, R. Fearon, A. D. Maria, V. Panneershelvam, M. Suleyman, C. Beattie, S. Petersen, S. Legg, V. Mnih, K. Kavukcuoglu, and D. Silver, "Massively parallel methods for deep reinforcement learning," *CoRR*, vol. abs/1507.04296, 2015. [Online]. Available: <http://arxiv.org/abs/1507.04296>
- [13] D. Horgan, J. Quan, D. Budden, G. Barth-Maron, M. Hessel, H. van Hasselt, and D. Silver, "Distributed prioritized experience replay," *CoRR*, vol. abs/1803.00933, 2018. [Online]. Available: <http://arxiv.org/abs/1803.00933>
- [14] V. Mnih, A. P. Badia, M. Mirza, A. Graves, T. P. Lillicrap, T. Harley, D. Silver, and K. Kavukcuoglu, "Asynchronous methods for deep reinforcement learning," *CoRR*, vol. abs/1602.01783, 2016. [Online]. Available: <http://arxiv.org/abs/1602.01783>
- [15] L. Espeholt, H. Soyer, R. Munos, K. Simonyan, V. Mnih, T. Ward, Y. Doron, V. Firoiu, T. Harley, I. Dunning, S. Legg, and K. Kavukcuoglu, "IMPALA: scalable distributed deep-rl with importance weighted actor-learner architectures," *CoRR*, vol. abs/1802.01561, 2018. [Online]. Available: <http://arxiv.org/abs/1802.01561>
- [16] V. Mnih, K. Kavukcuoglu, D. Silver, A. Graves, I. Antonoglou, D. Wierstra, and M. A. Riedmiller, "Playing atari with deep reinforcement learning," *CoRR*, vol. abs/1312.5602, 2013. [Online]. Available: <http://arxiv.org/abs/1312.5602>
- [17] M. Li, D. G. Andersen, J. W. Park, A. J. Smola, A. Ahmed, V. Josifovski, J. Long, E. J. Shekita, and B.-Y. Su, "Scaling distributed machine learning with the parameter server," in *Proceedings of the 11th USENIX Conference on Operating Systems Design and Implementation*, ser. OSDI'14. USA: USENIX Association, 2014, pp. 583–598.
- [18] H. V. Hasselt, "Double q-learning," in *Advances in Neural Information Processing Systems 23*, J. D. Lafferty, C. K. I. Williams, J. Shawe-Taylor, R. S. Zemel, and A. Culotta, Eds. Curran Associates, Inc., 2010, pp. 2613–2621. [Online]. Available: <http://papers.nips.cc/paper/3964-double-q-learning.pdf>
- [19] T. P. Lillicrap, J. J. Hunt, A. Pritzel, N. M. O. Heess, T. Erez, Y. Tassa, D. Silver, and D. Wierstra, "Continuous control with deep reinforcement learning," *CoRR*, vol. abs/1509.02971, 2016.
- [20] S. Fujimoto, H. V. Hoof, and D. Meger, "Addressing function approximation error in actor-critic methods," *ArXiv*, vol. abs/1802.09477, 2018.
- [21] T. Haarnoja, A. Zhou, P. Abbeel, and S. Levine, "Soft actor-critic: Off-policy maximum entropy deep reinforcement learning with a stochastic actor," *CoRR*, vol. abs/1801.01290, 2018. [Online]. Available: <http://arxiv.org/abs/1801.01290>
- [22] R. S. Sutton and A. G. Barto, *Reinforcement Learning: An Introduction*. Cambridge, MA, USA: A Bradford Book, 2018.
- [23] G. van Rossum, "Python tutorial," Centrum voor Wiskunde en Informatica (CWI), Amsterdam, Tech. Rep. CS-R9526, May 1995.
- [24] T. Schaul, J. Quan, I. Antonoglou, and D. Silver, "Prioritized experience replay," 2015, cite arxiv:1511.05952Comment: Published at ICLR 2016. [Online]. Available: <http://arxiv.org/abs/1511.05952>
- [25] E. Liang, R. Liaw, R. Nishihara, P. Moritz, R. Fox, J. Gonzalez, K. Goldberg, and I. Stoica, "Ray rllib: A composable and scalable reinforcement learning library," *CoRR*, vol. abs/1712.09381, 2017. [Online]. Available: <http://arxiv.org/abs/1712.09381>
- [26] A. V. Clemente, H. N. C. Martínez, and A. Chandra, "Efficient parallel methods for deep reinforcement learning," *CoRR*, vol. abs/1705.04862, 2017. [Online]. Available: <http://arxiv.org/abs/1705.04862>
- [27] Y. Li and D. Schuurmans, "Mapreduce for parallel reinforcement learning," in *Recent Advances in Reinforcement Learning*, S. Sanner and M. Hutter, Eds. Berlin, Heidelberg: Springer Berlin Heidelberg, 2012, pp. 309–320.
- [28] J. Dean and S. Ghemawat, "Mapreduce: Simplified data processing on large clusters," *Commun. ACM*, vol. 51, no. 1, pp. 107–113, Jan. 2008. [Online]. Available: <https://doi.org/10.1145/1327452.1327492>
- [29] R. M. Kretschmar, "Parallel reinforcement learning," in *The 6th World Conference on Systemics, Cybernetics, and Informatics*. Citeseer, 2002.
- [30] S. Shao and W. Luk, "Customised pearlmuter propagation: A hardware architecture for trust region policy optimisation," in *2017 27th International Conference on Field Programmable Logic and Applications (FPL)*, 2017, pp. 1–6.
- [31] J. Schulman, S. Levine, P. Moritz, M. I. Jordan, and P. Abbeel, "Trust region policy optimization," *CoRR*, vol. abs/1502.05477, 2015. [Online]. Available: <http://arxiv.org/abs/1502.05477>
- [32] Y. Meng, S. Kuppannagari, and V. Prasanna, "Accelerating proximal policy optimization on cpu-fpga heterogeneous platforms," in *2020 IEEE 28th Annual International Symposium on Field-Programmable Custom Computing Machines (FCCM)*, 2020, pp. 19–27.
- [33] J. Schulman, F. Wolski, P. Dhariwal, A. Radford, and O. Klimov, "Proximal policy optimization algorithms," *CoRR*, vol. abs/1707.06347, 2017. [Online]. Available: <http://arxiv.org/abs/1707.06347>
- [34] K. Bäckström, M. Papatriantafyllou, and P. Tsigas, "Mindthestepp-asynpsgd: Adaptive asynchronous parallel stochastic gradient descent," *CoRR*, vol. abs/1911.03444, 2019. [Online]. Available: <http://arxiv.org/abs/1911.03444>
- [35] G. Narlikar and G. Blleloch, "Pthreads for dynamic parallelism," 1998.
- [36] J. W. et al, "Tianshou," <https://github.com/thu-ml/tianshou>, 2020.
- [37] Y. Fujita, P. Nagarajan, T. Kataoka, and T. Ishikawa, "Chainerrl: A deep reinforcement learning library," *Journal of Machine Learning Research*, vol. 22, no. 77, pp. 1–14, 2021. [Online]. Available: <http://jmlr.org/papers/v22/20-376.html>
- [38] A. Stooke and P. Abbeel, "rlpyt: A research code base for deep reinforcement learning in pytorch," *CoRR*, vol. abs/1909.01500, 2019. [Online]. Available: <http://arxiv.org/abs/1909.01500>