

Spirality and Rectilinear Planarity Testing of Independent-Parallel SP-Graphs^{*}

Walter Didimo¹, Michael Kaufmann², Giuseppe Liotta¹, Giacomo Ortali¹

¹ Università degli Studi di Perugia, Italy
 {walter.didimo,giuseppe.liotta}@unipg.it,
 giacomo.ortali@studenti.unipg.it

² University of Tübingen, Germany
 mk@informatik.uni-tuebingen.de

Abstract. We study the long-standing open problem of efficiently testing rectilinear planarity of series-parallel graphs (SP-graphs) in the variable embedding setting. A key ingredient behind the design of a linear-time testing algorithm for SP-graphs of vertex-degree at most three is that one can restrict the attention to a constant number of “rectilinear shapes” for each series or parallel component. To formally describe these shapes the notion of spirality can be used. This key ingredient no longer holds for SP-graphs with vertices of degree four, as we prove a logarithmic lower bound on the spirality of their components. The bound holds even for the independent-parallel SP-graphs, in which no two parallel components share a pole. Nonetheless, by studying the spirality properties of the independent-parallel SP-graphs, we are able to design a linear-time rectilinear planarity testing algorithm for this graph family.

Keywords: Orthogonal drawings · Variable embedding · Rectilinear planarity testing · Series-parallel graphs.

1 Introduction

Rectilinear planarity testing asks whether a planar 4-graph (i.e., with vertex-degree at most four) admits a planar orthogonal drawing without edge bends. It is a classical subject of study in graph drawing, partly for its theoretical beauty and partly because it is at the heart of the algorithms that compute bend-minimum orthogonal drawings, which find applications in several domains (see, e.g. [4,9,11,18,19,20]). Rectilinear planarity testing is NP-complete [14], it belongs to the XP-class when parameterized by treewidth [6], and it is FPT tractable when parameterized by the number of degree-4 vertices [8]. Polynomial-time solutions exist for restricted versions of the problem. Namely, if the algorithm must preserve a given planar embedding, rectilinear planarity testing can

* This work is partially supported by: (i) MIUR, grant 20174LF3T8 “AHeAD: efficient Algorithms for HArnessing networked Data”, (ii) Dipartimento di Ingegneria - Università degli Studi di Perugia, grants RICBA19FM: “Modelli, algoritmi e sistemi per la visualizzazione di grafi e reti” and RICBA20EDG: “Algoritmi e modelli per la rappresentazione visuale di reti”.

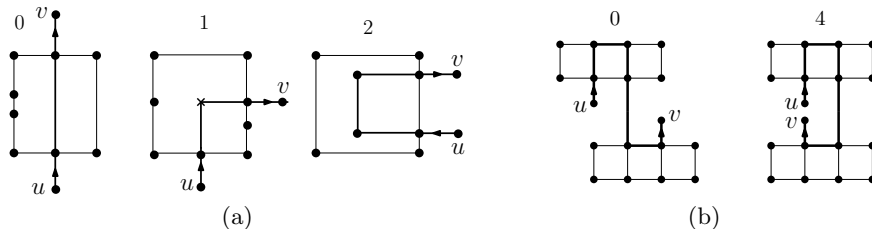

Fig. 1. Two components that are: (a) rectilinear planar for spiralities 0 and 2, but not 1 (which requires a bend, shown as a cross); (b) rectilinear planar only for spiralities 0 and 4. In bold, an arbitrary path from the pole u to the pole v .

be solved in subquadratic time for general graphs [2,13], and in linear time for planar 3-graphs [22] and for biconnected series-parallel graphs (SP-graphs for short) [7]. When the planar embedding is not fixed, linear-time solutions exist for (families of) planar 3-graphs [10,16,21,24] and for outerplanar graphs [12]. A polynomial-time solution for SP-graphs has been known for a long time [5], but establishing whether there is a linear-time algorithm for this graph family remains a long-standing open problem [1]; to date, the most efficient algorithm for n -vertex SP-graphs has complexity $O(n^3 \log n)$ [6].

This paper sheds new light on this long-standing open problem. We study it along the lines that led to linear-time testing algorithms for degree-3 SP-graphs [24] and for general planar 3-graphs [10]. We highlight some of the difficulties that stem from the degree-4 vertices and show how to overcome them to design a linear-time algorithm for a class of degree-4 SP-graphs that properly includes all biconnected degree-3 SP-graphs. To better describe our contribution, we briefly recall some fundamental aspects of these previous approaches.

In a nutshell, the linear-time algorithms of [10,24] are based on recursive approaches that, at each step determine if a (series or parallel) component of the graph is rectilinear planar by suitably combining rectilinear representations of its sub-components. For both algorithms, a key ingredient to achieve linear-time complexity is that it is enough to consider a constant number of rectilinear planar representations at each composition step. Another key ingredient is that the “shapes” of these representations can be succinctly described in $O(1)$. In [10] the shape is described by using the concept of *spirality*, a number that describes how much a rectilinear planar representation is “rolled up”. Roughly, the spirality of a representation is the number of right minus left turns in any oriented path between the poles of its corresponding component (see Section 2 and Fig. 1 for an example). It is easy to see that also the shapes considered in [24] can be described in terms of spirality. Hence, the possible representations for each component are succinctly described by a set of spirality values of constant size.

A first difficulty in extending the above approaches to degree-4 SP-graphs is that we lose one of the key ingredients: As we show in Section 3.1, there exist n -vertex SP-graphs whose rectilinear planar representations require components

with $\Omega(\log n)$ spirality. For these instances a testing algorithm may need to take into account $\Omega(\log n)$ rectilinear planar representations per component. To complicate matters even further, it is not obvious how to use the spirality to construct a succinct description of these $\Omega(\log n)$ representations. Consider, for example, the component of Fig. 1(a): It is rectilinear planar for spirality 0, it is not rectilinear planar for spirality 1, but it becomes rectilinear planar again when the spirality is 2. As another example, the component of Fig. 1(b) is rectilinear planar for spirality 0 and 4, but not for any intermediate value of spirality. The absence of regularity is an obstacle to the design of a succinct description based on whether a component is rectilinear planar for consecutive spirality values.

We study a class of 4-graphs called *independent-parallel SP-graphs*, which are such that no two parallel components share a pole; see Fig. 2(a). The component in Fig. 1(a) and the graphs used to prove the $\Omega(\log n)$ spirality lower bound (see Section 3.1) are independent-parallel. By carefully analyzing the spirality properties of independent-parallel SP-graphs (see Section 3.2), we can overcome the previously described difficulties and design a linear-time rectilinear planarity testing algorithm for this graph family (see Section 4). The algorithm uses a set of composition techniques to compute in constant time a succinct description of the rectilinear representations of each component. Future research directions are discussed in Section 5. For space reasons, some proofs are in the appendix.

2 Preliminaries

Orthogonal drawings and representations. A *planar orthogonal drawing* Γ of a planar graph G is a crossing-free drawing that maps each vertex of G to a distinct point of the plane and each edge of G to a sequence of horizontal and vertical segments between its end-points [4,11,20]. A graph is *rectilinear planar* if it admits a planar orthogonal drawing without bends. An *orthogonal representation* H describes the shape of a class of orthogonal drawings in terms of sequences of bends along the edges and angles at the vertices. A drawing Γ of H can be computed in linear time [23]. If H has no bend, it is a *rectilinear representation*.

SP-graphs and SPQ-trees. Let G be a biconnected graph. The *SPQR-tree* T of G describes the decomposition of G into its triconnected components, and can be computed in linear time [4,15,17]. If every triconnected component of G is not a triconnected graph, G is a *series-parallel graph*, or *SP-graph* for short. In this case T is simply called SPQ-tree and contains three types of nodes: *S-nodes*, *P-nodes*, and *Q-nodes*. The degree-1 nodes of T are Q-nodes, each corresponding to a distinct edge of G . If ν is an S-node (resp. a P-node) it represents a series-component (resp. parallel-component), denoted as $\text{skel}(\nu)$ and called the *skeleton* of ν . If ν is an S-node, $\text{skel}(\nu)$ is a simple cycle of length at least three; if ν is a P-node, $\text{skel}(\nu)$ is a bundle of at least three multiple edges. Any two S-nodes (resp. P-nodes) are never adjacent in T . A *real edge* (resp. *virtual edge*) in $\text{skel}(\nu)$ corresponds to a Q-node (resp. an S- or a P-node) adjacent to ν in T .

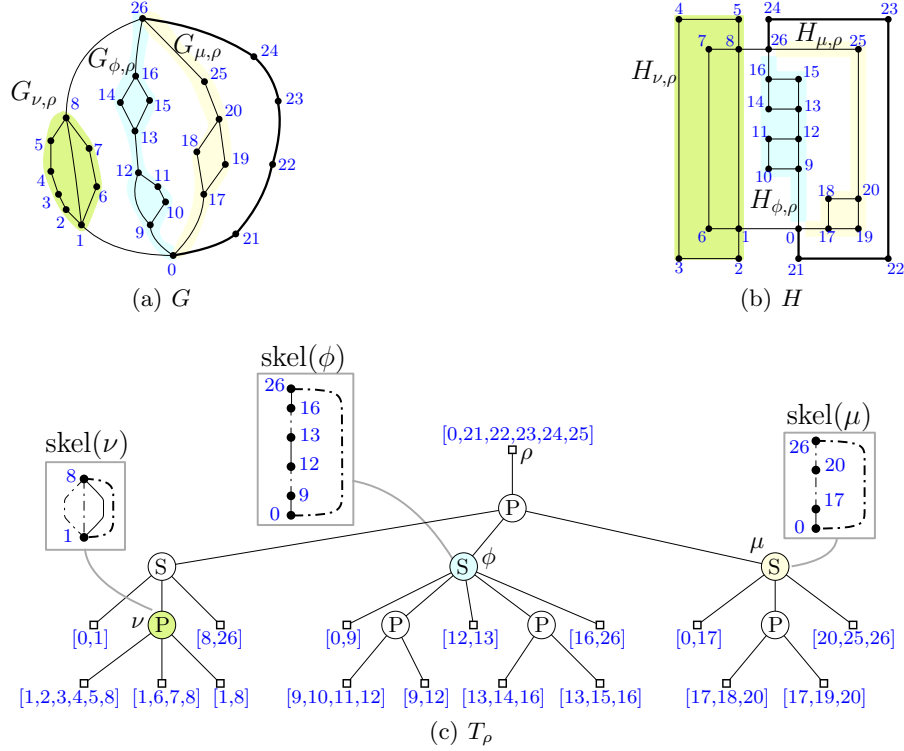

Fig. 2. (a) An (independent-parallel) SP-graph G . (b) A rectilinear representation H of G . (c) The SPQ*-tree T_ρ of G , where ρ represents the thick chain; Q*-nodes are small squares; the left-to-right order of the children of each P-node reflects the embedding of H . The components of the nodes ν , μ , ϕ are shown, as well as their skeletons: virtual edges are dashed and the reference is thicker.

SPQ*-trees. Testing whether a simple cycle is rectilinear planar is trivial (if and only if it has at least four vertices). Hence, we shall assume that G is a biconnected SP-graph different from a simple cycle and we use a variant of the SPQ-tree called *SPQ*-tree* (refer to Fig. 2). In an SPQ*-tree, each degree-1 node of T is a Q*-node, and represents a maximal chain of edges of G (possibly a single edge) starting and ending at vertices of degree larger than two and passing through a sequence of degree-2 vertices only (possibly none). If ν is an S- or a P-node, an edge of $\text{skel}(\nu)$ corresponding to a Q*-node μ is virtual if μ is a chain of at least two edges, else it is a real edge. For any given Q*-node ρ of T , denote by T_ρ the tree T rooted at ρ . The chain of edges represented by ρ is the *reference chain* of G with respect to T_ρ . If ν is an S- or a P-node distinct from the root child of T_ρ , then $\text{skel}(\nu)$ contains a virtual edge that has a counterpart in the skeleton of its parent; this edge is the *reference edge* of $\text{skel}(\nu)$. If ν is the root child, the *reference edge* of $\text{skel}(\nu)$ is the edge corresponding to ρ . For any S- or

P-node ν of T_ρ , the end-vertices of the reference edge of $\text{skel}(\nu)$ are the *poles* of ν and of $\text{skel}(\nu)$. We remark that $\text{skel}(\nu)$ does not change if we change ρ . However, if ν is an S-node, its poles depend on ρ ; namely, if ρ' is a Q*-node in the subtree of T_ρ rooted at ν , the poles of ν in $T_{\rho'}$ are different from those in T_ρ . Conversely, the poles of a P-node stay the same independent of the root of T . For a Q*-node ν of T_ρ (including ρ), the *poles* of ν are the end-vertices of the corresponding chain, and do not change when the root of T changes. For any S- or P-node ν of T_ρ , the *pertinent graph* $G_{\nu,\rho}$ of ν is the subgraph of G formed by the union of the chains represented by the leaves in the subtree of T_ρ rooted at ν . The *poles* of $G_{\nu,\rho}$ are the poles of ν . The *pertinent graph* of a Q*-node ν (including the root) is the chain represented by ν , and its *poles* are the poles of ν . Any graph $G_{\nu,\rho}$ is also called a *component* of G (with respect to ρ). If μ is a child of ν , we call $G_{\mu,\rho}$ a *child component* of ν . If H is a rectilinear representation of G , for any node ν of T_ρ , the restriction $H_{\nu,\rho}$ of H to $G_{\nu,\rho}$ is a *component* of H (with respect to ρ).

Encoding of planar embeddings. A rooted SPQ*-tree T_ρ of an SP-graph G is used to describe all planar embeddings of G having the reference chain on the external face (in every planar embedding of G , all the edges in the chain represented by a Q*-node belong to the same two faces). These embeddings are obtained by permuting in all possible ways the edges of the skeletons of the P-nodes distinct from the reference edges, around the poles. Namely, assume given an *st*-numbering of G such that s and t coincide with the poles of ρ . For each P-node ν of T_ρ , let u and v be its poles where u precedes v in the *st*-numbering. Denote by e_ν the reference edge of $\text{skel}(\nu)$, by e_1, \dots, e_h the edges of $\text{skel}(\nu)$ distinct from e_ν , and by μ_1, \dots, μ_h the children of ν corresponding to e_1, \dots, e_h . Each permutation of e_1, \dots, e_h defines a class of planar embeddings of $G_{\nu,\rho}$ with u and v on the external face, where the components $G_{\mu_1,\rho}, \dots, G_{\mu_h,\rho}$ are incident to u and v in the order of the permutation. More precisely, if e_{i_1}, \dots, e_{i_h} is one of these permutations ($i_j \in \{1, \dots, h\}$), the clockwise (resp. counterclockwise) sequence of edges incident to u (resp. v) in $\text{skel}(\nu)$ is $e_\nu, e_{i_1}, \dots, e_{i_h}$; we say that, according to this permutation, $\mu_{i_1}, \dots, \mu_{i_h}$ and their corresponding components appear in this left-to-right order.

Independent-parallel SP-graphs. Let G be an SP-graph and let T be its SPQ*-tree. We say that G is *independent-parallel* if no two P-nodes of T have a pole in common (see, e.g., Fig. 2(a)). Let ρ be a Q*-node of T . For a pole w of a node ν of T_ρ , let $\text{indeg}_\nu(w)$ and $\text{outdeg}_\nu(w)$ be the degree of w inside and outside $G_{\nu,\rho}$, respectively. If G is independent-parallel, each pole w of a P-node ν of T_ρ is such that $\text{outdeg}_\nu(w) = 1$; if ν is an S-node, either $\text{indeg}_\nu(w) = 1$ or $\text{outdeg}_\nu(w) = 1$. In all cases, $\text{outdeg}_\nu(w) = 1$ when $\text{indeg}_\nu(w) > 1$.

Spirality. Let G be a degree-4 SP-graph and let H be a rectilinear planar representation of G . Let T_ρ be a rooted SPQ*-tree of G , let $H_{\nu,\rho}$ be a component of H , and let $\{u, v\}$ be the poles of ν , conventionally ordered according to an *st*-numbering of G , where s and t are the poles of ρ . Since we deal with independent-parallel SP-graphs, $\text{outdeg}_\nu(w) = 1$ when $\text{indeg}_\nu(w) > 1$. Define the *alias vertex* w' of w as follows: If $\text{indeg}_\nu(w) = 1$, then $w' = w$; else w' is a dummy vertex that

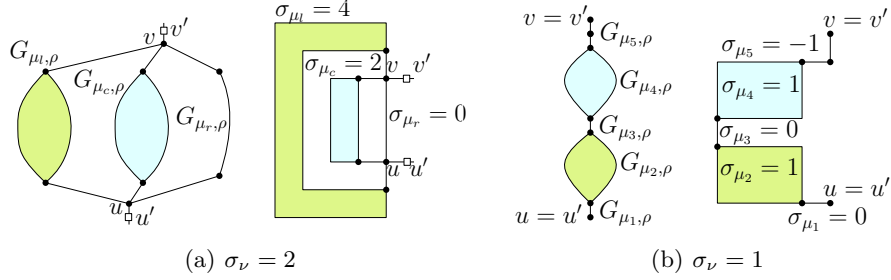

Fig. 3. Schematic illustration of the concept of spirality and of the relationships given by: (a) Lemma 1 (alias vertices are small squares); and (b) Lemma 2.

subdivides the edge incident to w outside $H_{\nu,\rho}$. Let P^{uv} be any simple path from u to v inside $H_{\nu,\rho}$ and let u' (resp. of v') be the alias vertex of u (resp. v). The path $S^{u'v'}$ obtained concatenating (u', u) , P^{uv} , and (v, v') is a *spine* of $H_{\nu,\rho}$. The *spirality* $\sigma(H_{\nu,\rho})$ of $H_{\nu,\rho}$ in H is the number of right turns minus the number of left turns along $S^{u'v'}$ while moving from u' to v' . See, e.g., Figs. 1 and 3. Di Battista et al. [5] show that the spirality of $H_{\nu,\rho}$ does not depend on the choice of P^{uv} ; also any component of H can be replaced by another component with the same spirality. In Fig. 2(b), the spiralities of $H_{\nu,\rho}$, $H_{\mu,\rho}$, and $H_{\phi,\rho}$ are 2, -2, and 0, respectively. For brevity, we shall denote by σ_ν the spirality of a rectilinear representation of $G_{\nu,\rho}$. We say that $G_{\nu,\rho}$ *admits spirality* σ_ν or, equivalently, that ν *admits spirality* σ_ν , if there exists a rectilinear planar representation $H_{\nu,\rho}$ with spirality σ_ν in some rectilinear planar representation H of G .

3 Spirality of Independent-Parallel SP-graphs

We first show that the components of a degree-4 SP-graph G with n vertices may require a spirality that is logarithmic in n (Section 3.1), even if G is independent-parallel. Next, we characterize the spirality values for which the components of independent-parallel SP-graphs can be rectilinear planar (Section 3.2).

3.1 Spirality Lower Bound

The proof of the lower bound (Theorem 1) uses Lemma 1, which relates the spirality of a P-component with three children to the spiralities of its child components; see Fig. 3(a) for an illustration.

Lemma 1 ([5]). *Let ν be a P-node of T_ρ with three children μ_l , μ_c , and μ_r . $G_{\nu,\rho}$ admits spirality σ_ν with $G_{\mu_l,\rho}$, $G_{\mu_c,\rho}$, $G_{\mu_r,\rho}$ in this left-to-right order if and only if there exist three values σ_{μ_l} , σ_{μ_c} , and σ_{μ_r} such that: (i) $G_{\mu_l,\rho}$, $G_{\mu_c,\rho}$, $G_{\mu_r,\rho}$ admit spirality σ_{μ_l} , σ_{μ_c} , σ_{μ_r} , respectively; and (ii) $\sigma_\nu = \sigma_{\mu_l} - 2 = \sigma_{\mu_c} = \sigma_{\mu_r} + 2$.*

Theorem 1. *For infinitely many integer values of n , there exists an n -vertex independent-parallel SP-graph for which every rectilinear planar representation has a component with spirality $\Omega(\log n)$.*

Proof. For any arbitrarily large even integer $N \geq 2$, we construct an independent-parallel SP-graph G with $n = O(3^N)$ vertices such that every rectilinear planar representation of G has a component with spirality larger than N . Let $L = \frac{N}{2} + 1$. For any $k \in \{0, \dots, L\}$, let G_k be the SP-graph inductively defined as follows: (i) G_0 is a chain of $N + 4$ vertices; (ii) G_1 is a parallel of three copies of G_0 , with coincident poles (Fig. 4(a)); (iii) for $k \geq 2$, G_k is a parallel composition of three series, each starting and ending with an edge, and having G_{k-1} in the middle (Fig. 4(b)). The graph G is obtained by composing in a cycle two chains p_1 and p_2 , of two edges each, with two copies of G_L (Fig. 4(c)). The graph G_L for $N = 4$ is in Fig. 4(d). About the number n of vertices of G , let n_k be the number of vertices of G_k . We have $n_0 = N + 4$ and $n_k = O(3^k N)$ for $k \leq N$. Hence, $n_L = O(3^{\frac{N}{2}} N)$ and, since $N \leq 3^{\frac{N}{2}}$, $n_L = O(3^N)$. It follows that $n = O(3^N)$.

Consider first the rooted SPQ*-tree T_ρ of G , where ρ represents p_1 . All the planar embeddings of G encoded by T_ρ have p_1 (and p_2) on the external face of G , and by symmetry of the construction they are all equivalent. Any rectilinear planar representation H of G with an embedding encoded by T_ρ requires that the restriction of H to each copy of G_L has spirality zero and, at the same time, the restriction of H to one of the copies of G_0 in G_L has spirality $N + 2$. Indeed, due to Lemma 1, for each rectilinear planar representation H_k of G_k , the leftmost (resp. rightmost) child component of H_k has spirality that is two units larger (resp. smaller) than the spirality of H_k . Hence, if there existed a rectilinear representation of G_L with spirality greater (resp. smaller) than zero, it would contain a representation of a copy of G_0 with spirality greater than $N + 2$ (resp. less than $-(N + 2)$), which is impossible, as the absolute value of spirality of any copy of G_0 is at most $N + 2$. See Fig. 4(e), where $N = 4$.

On the other hand, if we consider the planar embeddings encoded by T when rooted at a Q*-node whose chain p belongs to a copy of G_L , the same argument as above applies to the copy of G_L that does not contain p ; namely, any rectilinear representation of this copy must contain a component with spirality $N + 2$.

3.2 Rectilinear Spirality Sets

Let G be a rectilinear planar SP-graph, T_ρ be a rooted SPQ*-tree of G , and $\nu \neq \rho$ be a node of T_ρ . The *rectilinear spirality set* $\Sigma_{\nu,\rho}$ of ν in T_ρ (and of $G_{\nu,\rho}$) is the set of spirality values for which $G_{\nu,\rho}$ admits a rectilinear planar representation. We will prove that there is some regularity in the rectilinear spirality sets of independent-parallel SP-graphs. Denote by $\Sigma_{\nu,\rho}^+$ (resp. $\Sigma_{\nu,\rho}^-$) the subset of non-negative (resp. non-positive) values of $\Sigma_{\nu,\rho}$. Clearly, $\Sigma_{\nu,\rho} = \Sigma_{\nu,\rho}^+ \cup \Sigma_{\nu,\rho}^-$. Note that, for any value $\sigma_\nu \in \Sigma_{\nu,\rho}$, we also have that $-\sigma_\nu \in \Sigma_\nu$. Indeed, if $G_{\nu,\rho}$ admits a rectilinear representation with spirality σ_ν for some embedding, by flipping this embedding around the poles of $G_{\nu,\rho}$, we can obtain a rectilinear representation

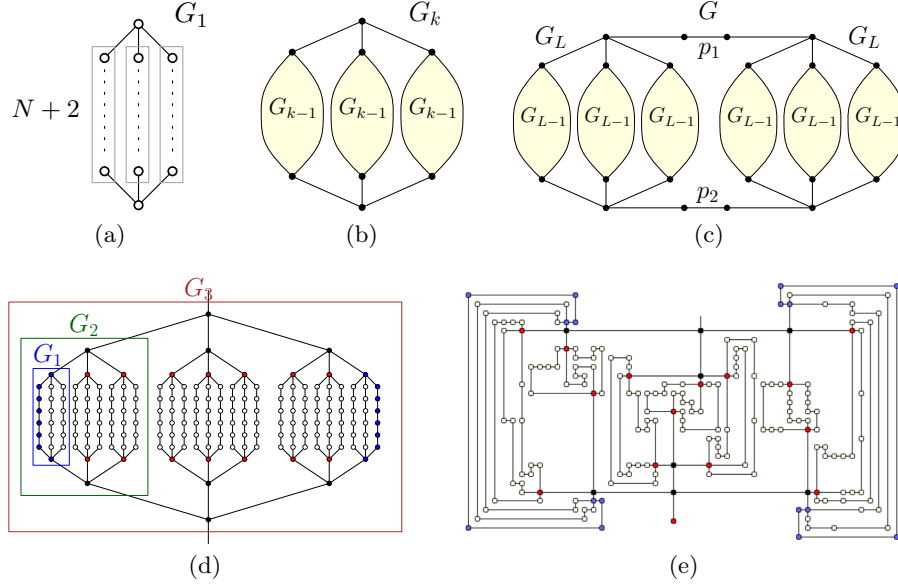

Fig. 4. (a)–(c) The graph family of Theorem 1; (d) $G_L = G_3$ ($N = 4$, $L = \frac{N}{2} + 1$); (e) A rectilinear planar representation of G_L (automatically computed by the GDToolkiy library [3]); the two G_0 components with blue vertices have spirality $N + 2 = 6$ (left) and $-(N + 2) = -6$ (right), respectively.

of $G_{\nu,\rho}$ with spirality $-\sigma_\nu$. Hence, $\sigma_\nu \in \Sigma_{\nu,\rho}^+$ if and only if $-\sigma_\nu \in \Sigma_{\nu,\rho}^-$, and we can restrict the study of the properties of $\Sigma_{\nu,\rho}$ to $\Sigma_{\nu,\rho}^+$, which we call the *non-negative rectilinear spirality set* of ν in T_ρ (or of $G_{\nu,\rho}$).

The main result of this subsection is Theorem 2, which proves that if G is an independent-parallel SP-graph, there is a limited number of possible structures for the sets $\Sigma_{\nu,\rho}^+$. Let m and M be two non-negative integers such that $m < M$: (i) $[M]$ is a *trivial interval* and denotes the singleton $\{M\}$; (ii) $[m, M]^1$ is a *jump-1 interval* and denotes the set of all integers in the interval $[m, M]$. i.e., $\{m, m + 1, \dots, M - 1, M\}$; (iii) If m and M have the same parity, $[m, M]^2$ is a *jump-2 interval* and denotes the set of values $\{m, m + 2, \dots, M - 2, M\}$.

Theorem 2. *Let G be a rectilinear planar independent-parallel SP-graph and let $G_{\nu,\rho}$ be a component of G . The non-negative rectilinear spirality set $\Sigma_{\nu,\rho}^+$ of $G_{\nu,\rho}$ has one the following six structures: $[0]$, $[1]$, $[1, 2]^1$, $[0, M]^1$, $[0, M]^2$, $[1, M]^2$.*

Theorem 2 relies on some key technical results. Lemma 2 relates the spirality of an S-component to those of its child components (see Fig. 3(b)).

Lemma 2 ([5]). *Let ν be an S-node of T_ρ with children μ_1, \dots, μ_h . The component $G_{\nu,\rho}$ admits spirality σ_ν if and only if $\sigma_\nu = \sum_{i=1}^h \sigma_{\mu_i}$, where σ_{μ_i} is a spirality value admitted by $G_{\mu_i,\rho}$ ($1 \leq i \leq h$).*

The next lemmas refer to (components of) independent-parallel SP-graphs. As for Lemmas 1 and 2, the next lemma shows the relationship between the spirality of a parallel component with two children and the spiralities of its child components. In the lemma, if $H_{\nu,\rho}$ is a rectilinear representation of $G_{\nu,\rho}$ with spirality σ_ν , the value α_w^l (resp. α_w^r) is used to represent the left (resp. right) outside angle at w ; namely, $\alpha_w^l = 0$ (resp. $\alpha_w^r = 0$) if the left (resp. right) angle at w is of 180° . Conversely, $\alpha_w^l = 1$ (resp. $\alpha_w^r = 1$) if the left (resp. right) angle at w is of 90° .

Lemma 3 ([5]). *Let ν be a P-node of T_ρ with two children μ_l and μ_r , and with poles u and v . The component $G_{\nu,\rho}$ admits spirality σ_ν with $G_{\mu_l,\rho}$ and $G_{\mu_r,\rho}$ in this left-to-right order if and only if there exist six values σ_{μ_l} , σ_{μ_r} , α_u^l , α_u^r , α_v^l , and α_v^r such that: (i) $G_{\mu_l,\rho}$ and $G_{\mu_r,\rho}$ admit spirality σ_{μ_l} and σ_{μ_r} , respectively; (ii) $\alpha_w^l \in \{0, 1\}$, $\alpha_w^r \in \{0, 1\}$, and $1 \leq \alpha_w^l + \alpha_w^r \leq 2$ for any $w \in \{u, v\}$; and (iii) $\sigma_\nu = \sigma_{\mu_l} - \alpha_u^l - \alpha_v^l = \sigma_{\mu_r} + \alpha_u^r + \alpha_v^r$.*

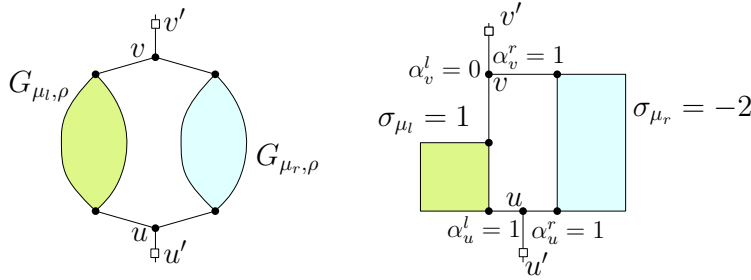

Fig. 5. Illustration for Lemma 3: the component has spirality 0; alias vertices are small squares.

Lemma 4. *Let $G_{\nu,\rho}$ be a component that admits spirality $\sigma_\nu \geq 2$. The following properties hold: (a) if $\sigma_\nu = 2$, $G_{\nu,\rho}$ admits spirality $\sigma'_\nu = 0$ or $\sigma'_\nu = 1$; (b) if $\sigma_\nu > 2$, $G_{\nu,\rho}$ admits spirality $\sigma'_\nu = \sigma_\nu - 2$; (c) if $\sigma_\nu = 4$, $G_{\nu,\rho}$ admits spirality $\sigma'_\nu = 0$.*

Proof. The proof is by induction on the depth of the subtree of T_ρ rooted at ν . In the base case ν is a Q^* -node and the three properties trivially hold for $G_{\nu,\rho}$. In the inductive case, ν is either an S-node or a P-node.

– ν is an S-node. We inductively prove the three properties.

Proof of Property (a). If ν admits spirality $\sigma_\nu = 2$, by Lemma 2, ν has a child μ that admits spirality $\sigma_\mu > 0$. If $\sigma_\mu = 1$, μ also admits spirality -1, and ν admits spirality 0. If $\sigma_\mu = 2$, by inductively using Property (a), μ also admits 0 or 1, and so does ν . If $\sigma_\mu > 2$, by inductively using Property (b), μ admits spirality $\sigma_\mu - 2$, and ν admits spirality 0.

Proof of Property (b). If ν admits spirality $\sigma_\nu > 2$, by Lemma 2, ν has child μ that admits spirality $\sigma_\mu > 2$. By inductively using Property (b), μ admits spirality

$\sigma_\mu - 2$ and by Lemma 2 ν admits spirality $\sigma_\nu - 2$. If ν has child μ such that μ admits spirality 1, then μ admits spirality -1, and ν admits spirality $\sigma_\nu - 2$. Else, ν has two children μ_1 and μ_2 such that μ_1 and μ_2 both admit spirality 2. By inductively using Property (a), either one of them also admits spirality 0 or they both admit spirality 1. In any case, ν admits spirality $\sigma_\nu - 2$.

Proof of Property (c). If ν admits spirality $\sigma_\nu = 4$, by Lemma 2 one of the following cases applies: (i) ν has a child μ that admits spirality 4; if so, by inductively using Property (c), ν admits spirality 0. (ii) ν has a child μ that admits spirality $\sigma_\mu > 4$; if so, by inductively applying Property (b) twice, μ admits spirality $\sigma_\mu - 4$, and hence ν admits spirality 0. (iii) ν has two children μ_1 and μ_2 such that each of them admits spirality either 1 or 3; observe that if μ_i ($i \in \{1, 2\}$) admits spirality 1, it also admits spirality -1 and if μ_i admits spirality 3, it also admits spirality 1 by inductively using Property (b); this implies that ν admits spirality $\sigma_\nu - 4$.

– ν is a P-node with three children. Let $H_{\nu,\rho}$ be a rectilinear planar representation of $G_{\nu,\rho}$ with spirality σ_ν . Let μ_l , μ_c , and μ_r be the children of ν such that $G_{\mu_l,\rho}$, $G_{\mu_c,\rho}$, and $G_{\mu_r,\rho}$ appear in this left-to-right order in $H_{\nu,\rho}$. By Lemma 1, $\sigma_{\mu_l} = \sigma_\nu + 2$, $\sigma_{\mu_c} = \sigma_\nu$, and $\sigma_{\mu_r} = \sigma_\nu - 2$.

Proof of Property (a). If $\sigma_\nu = 2$, we have $\sigma_{\mu_l} = 4$, $\sigma_{\mu_c} = 2$, and $\sigma_{\mu_r} = 0$; see Fig. 6(a). By inductively using Property (b), μ_l admits spirality 2. Also μ_c admits spirality -2. Hence, exchanging G_{μ_c} with G_{μ_r} in the left-to-right order, by Lemma 1, ν admits spirality 0; see Fig. 6(d).

Proof of Property (b). If $\sigma_\nu > 2$, we distinguish three cases:

- (i) $\sigma_\nu = 3$, which implies $\sigma_{\mu_l} = 5$, $\sigma_{\mu_c} = 3$, and $\sigma_{\mu_r} = 1$; see Fig. 6(b). By inductively using Property (b), μ_l and μ_c admit spirality 3 and 1, respectively. Also, μ_r admits spirality -1. By Lemma 1, ν admits spirality $\sigma_\nu - 2 = 1$; see Fig. 6(e).
- (ii) $\sigma_\nu = 4$, which implies $\sigma_{\mu_l} = 6$, $\sigma_{\mu_c} = 4$, and $\sigma_{\mu_r} = 2$; see Fig. 6(c). By inductively using Property (b), μ_l admits spirality 4; also, by inductively using Property (c), μ_c admits spirality 0. Hence, exchanging G_{μ_c} with G_{μ_r} in the left-to-right order, by Lemma 1, ν admits spirality $\sigma_\nu - 2 = 2$; see Fig. 6(f).
- (iii) $\sigma_\nu > 4$, which implies $\sigma_{\mu_r} > 2$. By inductively using Property (b), μ_l , μ_c , μ_r admit spirality $\sigma_{\mu_l} - 2$, $\sigma_{\mu_c} - 2$, $\sigma_{\mu_r} - 2$, and hence ν admits spirality $\sigma_\nu - 2$.

Proof of Property (c). If $\sigma_\nu = 4$ then $\sigma_{\mu_l} = 6$, $\sigma_{\mu_c} = 4$, $\sigma_{\mu_r} = 2$. By inductively using Property (b) twice, μ_l admits spirality 2. By inductively using Property (c), μ_c admits spirality 0. Since μ_r admits spirality -2, ν admits spirality $\sigma_\nu - 4 = 0$.

– ν is a P-node with two children

Let $H_{\nu,\rho}$ be a rectilinear planar representation of $G_{\nu,\rho}$ with spirality σ_ν . Let $G_{\mu_l,\rho}$ and $G_{\mu_r,\rho}$ be the left child and the right child of $G_{\nu,\rho}$ in $H_{\nu,\rho}$, respectively. By Lemma 3 we have $\sigma_\nu = \sigma_{\mu_l} - \alpha_u^l - \alpha_v^l = \sigma_{\mu_r} + \alpha_u^r + \alpha_v^r$. Lemma 3 implies $\sigma_{\mu_l} - \sigma_{\mu_r} \in [2, 4]$. Without loss of generality, we assume that $\alpha_v^l \geq \alpha_u^l$.

Proof of Property (a). If $\sigma_\nu = 2$, we distinguish three cases depending on the value of $\sigma_{\mu_l} - \sigma_{\mu_r}$. Suppose first that $\sigma_{\mu_l} - \sigma_{\mu_r} = 2$. There are three subcases:

- (i) $\sigma_{\mu_l} = 2$, $\sigma_{\mu_r} = 0$, and $\alpha_u^l = \alpha_v^l = 0$; see Fig. 7(a). For $\alpha_u^l = \alpha_v^l = 1$ and $\alpha_u^r = \alpha_v^r = 0$, by Lemma 3, $G_{\nu,\rho}$ admits spirality $\sigma_\nu - 2 = 0$; see Fig. 7(b).

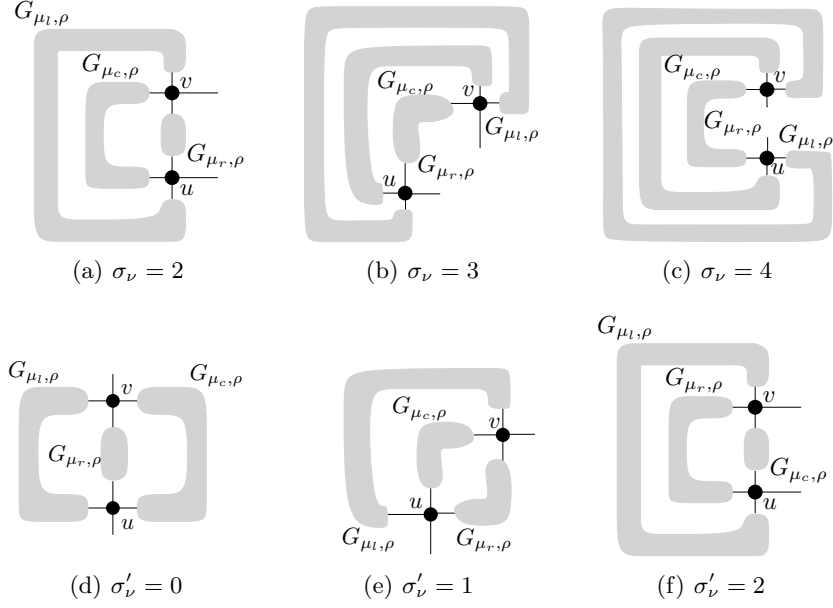

Fig. 6. Illustration of Lemma 4 for a P-node with three children.

- (ii) $\sigma_{\mu_l} = 3$, $\sigma_{\mu_r} = 1$, $\alpha_v^r = 0$, and $\alpha_u^l = 0$; see Fig. 7(c). By inductively using Property (b), $G_{\mu_l, \rho}$ admits spirality 1. Also, $G_{\mu_r, \rho}$ admit spirality $\sigma_{\mu_r} = -1$. For $\alpha_u^l = \alpha_v^r = 0$ (which implies $\alpha_u^r = \alpha_v^l = 1$), by Lemma 3, $G_{\nu, \rho}$ admits spirality 0; see Fig. 7(d).
- (iii) $\sigma_{\mu_l} = 4$, $\sigma_{\mu_r} = 2$, and $\alpha_u^r = \alpha_v^r = 1$; see Fig. 7(e). By inductively using Property (c), $G_{\mu_l, \rho}$ admits spirality 0. Hence, exchanging $G_{\mu_l, \rho}$ and $G_{\mu_r, \rho}$ in the left-to-right order, and for $\alpha_u^r = \alpha_v^r = 0$, by Lemma 3, $G_{\nu, \rho}$ admits spirality 0; see Fig. 7(f).

Suppose now that $\sigma_{\mu_l} - \sigma_{\mu_r} = 3$. In this case, for one of the two poles $\{u, v\}$ of ν , say v , we have $\alpha_v^l = \alpha_v^r = 1$. There are two subcases:

- (iv) $\sigma_{\mu_l} = 3$ and $\sigma_{\mu_r} = 0$; see Fig. 8(a). In this case $\alpha_u^r = 1$. For $\alpha_u^r = 0$, by Lemma 3, $G_{\nu, \rho}$ admits spirality 1; see Fig. 8(b).
- (v) $\sigma_{\mu_l} = 4$ and $\sigma_{\mu_r} = 1$; see Fig. 8(c). By inductively using Property (b), $G_{\mu_l, \rho}$ admits spirality 2. Also, $G_{\mu_r, \rho}$ admits spirality -1. For $\alpha_u^r = 0$, by Lemma 3, $G_{\nu, \rho}$ admits spirality 0; see Fig. 8(d).

Finally, suppose $\sigma_{\mu_l} - \sigma_{\mu_r} = 4$; see Fig. 8(e). We have $\sigma_{\mu_l} = 4$ and $\sigma_{\mu_r} = 0$. By inductively using Property (b), $G_{\mu_l, \rho}$ admits spirality 2. For $\alpha_u^l = \alpha_v^l = 0$, by Lemma 3, $G_{\nu, \rho}$ admits spirality 0; see Figure 8(f).

Proof of Property (b). If $\sigma_\nu > 2$, we have three cases: $\sigma_\nu = 3$; $\sigma_\nu = 4$; $\sigma_\nu > 4$.

– $\sigma_\nu = 3$. As before, we perform a case analysis based on the value of $\sigma_{\mu_l} - \sigma_{\mu_r}$. Suppose first that $\sigma_{\mu_l} - \sigma_{\mu_r} = 2$. There are three subcases:

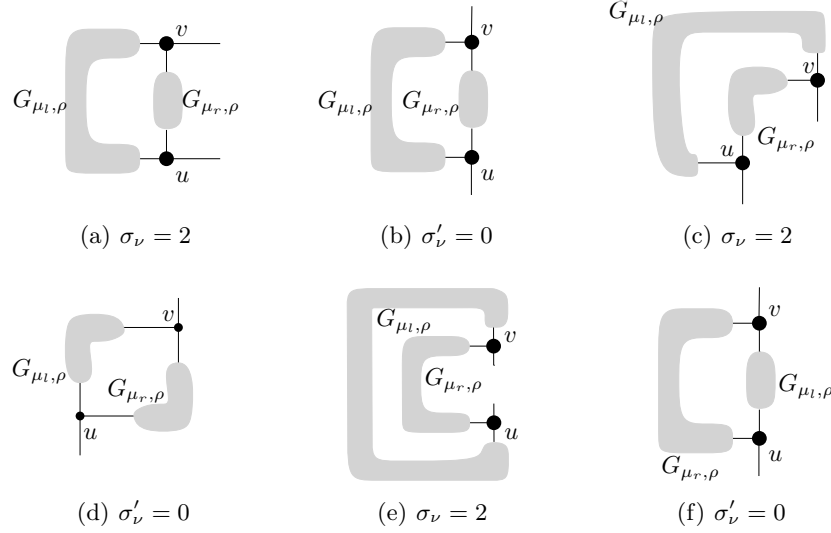

Fig. 7. Illustration for the proof Property (a) of Lemma 4 for a P-component with two children for the case $\sigma_{\mu_l} - \sigma_{\mu_r} = 2$.

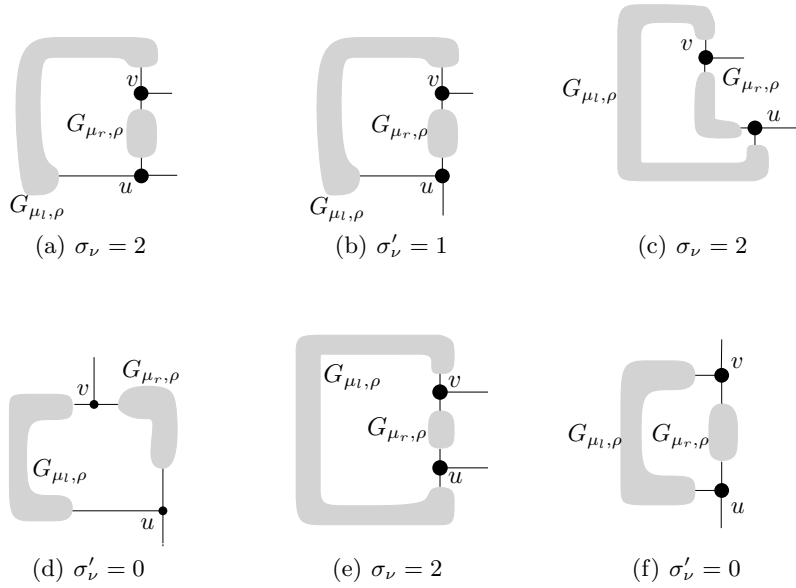

Fig. 8. Illustration for the proof Property (a) of Lemma 4 for a P-component with two children for the cases $\sigma_{\mu_l} - \sigma_{\mu_r} = 3$ and $\sigma_{\mu_l} - \sigma_{\mu_r} = 4$.

- (i) If $\sigma_{\mu_l} = 3$ and $\sigma_{\mu_r} = 1$, we have $\alpha_u^r = \alpha_v^r = 0$. For $\alpha_u^r = \alpha_v^r = 1$ and $\alpha_u^l = \alpha_v^l = 0$, by Lemma 3, $G_{\nu,\rho}$ admits spirality $\sigma_\nu - 2 = 1$.
- (ii) If $\sigma_{\mu_l} = 4$ and $\sigma_{\mu_r} = 2$, by inductively using Property (c), $G_{\mu_l,\rho}$ admits spirality 0. Exchanging $G_{\mu_l,\rho}$ and $G_{\mu_r,\rho}$ in the left-to-right order and for $\alpha_u^l = \alpha_v^l = 0$, by Lemma 3, $G_{\nu,\rho}$ admits spirality $\sigma_\nu - 2 = 1$.
- (iii) If $\sigma_{\mu_l} = 5$ and $\sigma_{\mu_r} = 3$, by inductively using Property (b), $G_{\mu_l,\rho}$ and $G_{\mu_r,\rho}$ admit spiralities $\sigma_{\mu_l} - 2$ and $\sigma_{\mu_r} - 2$, respectively. Hence $G_{\nu,\rho}$ admits spirality $\sigma_\nu - 2 = 1$.

Suppose now that $\sigma_{\mu_l} - \sigma_{\mu_r} = 3$. As in proof for Property (a), assume, without loss of generality, that $\alpha_u^l = \alpha_v^r = 1$. The following subcases hold:

- (iv) If $\sigma_{\mu_l} = 4$ and $\sigma_{\mu_r} = 1$, by inductively using Property (b), $G_{\mu_l,\rho}$ admits spirality 2. Also, G_{μ_r} admits spirality -1. For $\alpha_u^l = 0$, by Lemma 3, $G_{\nu,\rho}$ admits spirality $\sigma_\nu - 2 = 1$.
- (v) If $\sigma_{\mu_l} = 5$ and $\sigma_{\mu_r} = 2$, by inductively using Property (a), G_{μ_r} admits spirality either 1 or 0. Suppose first that G_{μ_r} admits spirality 1. By inductively using Property (b), $G_{\mu_l,\rho}$ admits spirality 3. For $\alpha_v^r = \alpha_u^r = 0$, by Lemma 3, $G_{\nu,\rho}$ admits spirality $\sigma_\nu - 2 = 1$. Suppose now that $G_{\mu_r,\rho}$ admits spirality 0. As before, $G_{\mu_l,\rho}$ admits spirality 3. For $\alpha_u^r = 0$, we have again that $G_{\nu,\rho}$ admits spirality $\sigma_\nu - 2 = 1$; see Fig. 8(b).

Suppose finally that $\sigma_{\mu_l} - \sigma_{\mu_r} = 4$. We have $\sigma_{\mu_l} = 5$ and $\sigma_{\mu_r} = 1$. By inductively using Property (b), $G_{\mu_l,\rho}$ admits spirality 3, and then for $\alpha_v^r = 0$ and $\alpha_u^r = 0$, we have that $G_{\nu,\rho}$ admits spirality $\sigma_\nu - 2 = 1$.

- $\sigma_\nu = 4$. Consider the subcase where $\sigma_{\mu_l} - \sigma_{\mu_r} = 2$.

- (vi) If $\sigma_{\mu_l} = 4$ and $\sigma_{\mu_r} = 2$, we have $\alpha_u^l = \alpha_v^l = 0$. For $\alpha_u^l = \alpha_v^l = 1$ and $\alpha_u^r = \alpha_v^r = 0$, by Lemma 3, $G_{\nu,\rho}$ admits spirality $\sigma_\nu - 2 = 2$.
- (vii) If $\sigma_{\mu_l} = 5$ and $\sigma_{\mu_r} = 3$ or $\sigma_{\mu_l} = 6$ and $\sigma_{\mu_r} = 4$, by inductively using Property (b), $G_{\mu_l,\rho}$ and $G_{\mu_r,\rho}$ admit spiralities $\sigma_{\mu_l} - 2$ and $\sigma_{\mu_r} - 2$, respectively. Hence, $G_{\nu,\rho}$ admits spirality $\sigma_\nu - 2 = 2$.

Suppose now that $\sigma_{\mu_l} - \sigma_{\mu_r} = 3$.

- (viii) If $\sigma_{\mu_l} = 5$ and $\sigma_{\mu_r} = 2$, by inductively using Property (b), G_{μ_l} admits spirality 3. Also, by inductively using Property (a), G_{μ_r} admits spirality either 0 or 1. In the first case, for $\alpha_u^l = 0$, we have that $G_{\nu,\rho}$ admits spirality $\sigma_\nu - 2 = 2$; see Fig. 8(a) the property holds for $\alpha_u^r = 0$; Fig. 8(c).
- (ix) If $\sigma_{\mu_l} = 6$ and $\sigma_{\mu_r} = 3$, by inductively using Property (b), $G_{\mu_l,\rho}$ and $G_{\mu_r,\rho}$ admit spiralities $\sigma_{\mu_l} - 2$ and $\sigma_{\mu_r} - 2$, respectively. Hence, $G_{\nu,\rho}$ admits spirality $\sigma_\nu - 2 = 2$.

Suppose finally that $\sigma_{\mu_l} - \sigma_{\mu_r} = 4$; we have $\sigma_{\mu_l} = 6$ and $\sigma_{\mu_r} = 2$. By Property (b), G_{μ_l} admits spirality 4, and by for $\alpha_u^l = \alpha_v^l = 1$, $G_{\nu,\rho}$ admits spirality $\sigma_\nu - 2 = 2$; see Fig. 7(e).

- $\sigma_\nu > 4$. We always have $\sigma_{\mu_r} > 2$ (and $\sigma_{\mu_l} > 2$). By inductively using Property (b), $G_{\mu_l,\rho}$ and $G_{\mu_r,\rho}$ admit spiralities $\sigma_{\mu_l} - 2$ and $\sigma_{\mu_r} - 2$, respectively. Hence, $G_{\nu,\rho}$ admits spirality $\sigma_\nu - 2 = 2$.

Proof of Property (c). If $\sigma_\nu = 4$, we still consider perform a case analysis based on the value of $\sigma_{\mu_l} - \sigma_{\mu_r}$. Suppose first that $\sigma_{\mu_l} - \sigma_{\mu_r} = 2$. There are three subcases.

- (i) Suppose $\sigma_{\mu_l} = 4$ and $\sigma_{\mu_r} = 2$. By inductively using Property (c), G_{μ_l} admits spirality 0. Exchanging $G_{\mu_l, \rho}$ and $G_{\mu_r, \rho}$, and for $\alpha_u^l = \alpha_v^l = 0$, we have that $G_{\nu, \rho}$ admits spirality 0.
- (ii) Suppose $\sigma_{\mu_l} = 5$ and $\sigma_{\mu_r} = 3$. By inductively using Property (b) (applied twice), $G_{\mu_l, \rho}$ and $G_{\mu_r, \rho}$ admit spirality 1; hence, G_{μ_r} also admits -1. For $\alpha_v^r = \alpha_u^l = 0$, we have that $G_{\nu, \rho}$ admits spirality 0; see Fig. 7(d).
- (iii) Suppose $\sigma_{\mu_l} = 6$ and $\sigma_{\mu_r} = 4$. By inductively using Property (b) (applied twice), $G_{\mu_l, \rho}$ admits spirality 2, and hence, by inductively using Property (c), it also admits spirality 0. For $\alpha_u^l = \alpha_v^l = 0$, $G_{\nu, \rho}$ admits spirality 0; see Fig. 7(b).

Suppose now that $\sigma_{\mu_l} - \sigma_{\mu_r} = 3$. We have the following subcases.

- (iv) Suppose $\sigma_{\mu_l} = 5$ and $\sigma_{\mu_r} = 2$. By inductively using Property (b) (applied twice), $G_{\mu_l, \rho}$ admits spirality 1. Also, $G_{\mu_l, \rho}$ admits spirality -2. For $\alpha_v^l = 0$, $G_{\nu, \rho}$ admits spirality 0.
- (v) Suppose $\sigma_{\mu_l} = 6$ and $\sigma_{\mu_r} = 3$. By inductively using Property (b) (applied twice), $G_{\mu_l, \rho}$ admits spirality 2 and $G_{\mu_r, \rho}$ admits spirality 1, and hence also spirality -1. For $\alpha_u^l = 0$, we have that $G_{\nu, \rho}$ admits spirality 0.

Finally, suppose that $\sigma_{\mu_l} - \sigma_{\mu_r} = 4$. We have $\sigma_{\mu_l} = 6$ and $\sigma_{\mu_r} = 4$. By inductively using Property (b) (applied twice), $G_{\mu_l, \rho}$ admits spirality 2, and by inductively using Property (c), $G_{\mu_r, \rho}$ admits spirality 0. For $\alpha_u^l = \alpha_v^l = 0$, $G_{\nu, \rho}$ admits spirality 0; see Fig. 7(b).

Lemma 4 immediately implies Corollary 1.

Corollary 1. *If $G_{\nu, \rho}$ admits spirality $\sigma_\nu > 2$, $G_{\nu, \rho}$ admits spirality for every value in $[1, \sigma_\nu]^2$, when σ_ν is odd, or for every value in $[0, \sigma_\nu]^2$, when σ_ν is even.*

The next lemma states an interesting property that is used to prove Lemma 6.

Lemma 5. *Let ν be a P-node with two children and suppose that $G_{\nu, \rho}$ admits spirality $\sigma_\nu \geq 0$. There exists a rectilinear planar representation of $G_{\nu, \rho}$ with spirality σ_ν such that the difference of spirality between the left child component and the right child component of $G_{\nu, \rho}$ is either 2 or 3.*

Proof. Let $H_{\nu, \rho}$ be any rectilinear planar representation of $G_{\nu, \rho}$ with spirality σ_ν . Also, let σ_{μ_l} and σ_{μ_r} be the spiralities of the left child component $H_{\mu_l, \rho}$ and of the right child component $H_{\mu_r, \rho}$ of $H_{\nu, \rho}$, respectively. Let $G_{\mu_l, \rho}$ and $G_{\mu_r, \rho}$ be the underlying graphs of $H_{\mu_l, \rho}$ and $H_{\mu_r, \rho}$. By Lemma 3, we have $2 \leq \sigma_{\mu_l} - \sigma_{\mu_r} \leq 4$. We show that if $\sigma_{\mu_l} - \sigma_{\mu_r} = 4$, one can construct a representation $H'_{\nu, \rho}$ of $G_{\nu, \rho}$ with spirality $\sigma'_\nu = \sigma_\nu$ such $\sigma'_{\mu_l} - \sigma'_{\mu_r} \in [2, 3]$. Since $\sigma_{\mu_l} - \sigma_{\mu_r} = 4$, we have $\alpha_u^l = \alpha_v^l = \alpha_u^r = \alpha_v^r = 1$, where u and v are the poles of ν . We distinguish between two cases:

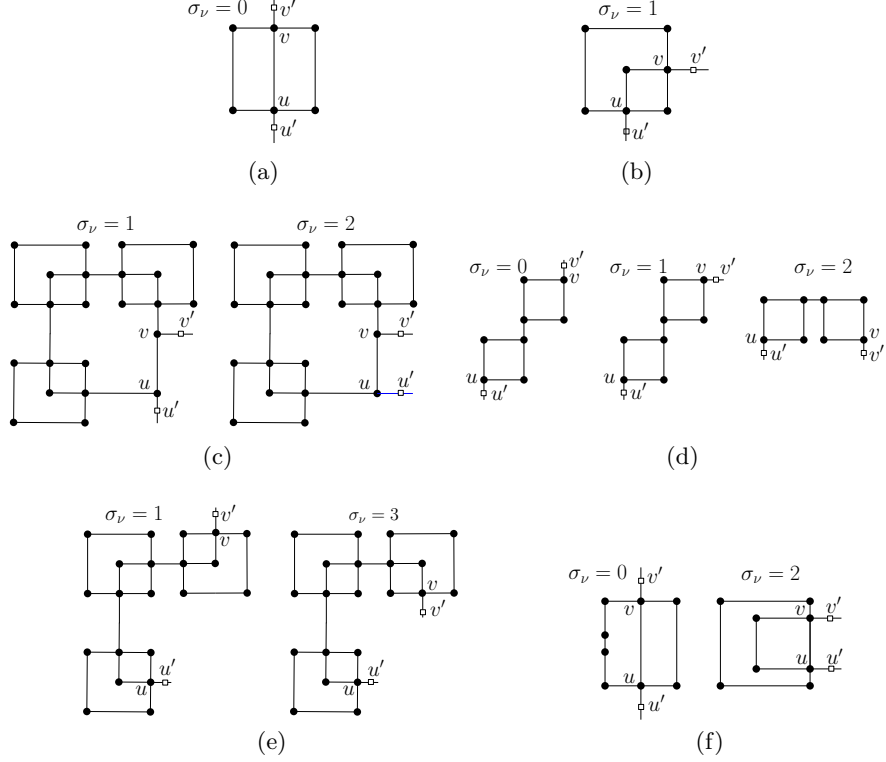

Fig. 9. Examples of non-negative spirality sets for each of the six structures in Theorem 2: (a) $[0]$; (b) $[1]$; (c) $[1, 2]^1$; (d) $[0, 2]^1$; (e) $[1, 3]^2$; (f) $[0, 2]^2$.

– Case $\sigma_\nu = 0$: In this case, $\sigma_{\mu_l} = 2$ and $\sigma_{\mu_r} = -2$. See Fig. 10(a). By Property (a) of Lemma 4, both $G_{\mu_l, \rho}$ and $G_{\mu_r, \rho}$ admit spirality 0 or 1. Assume first that $G_{\mu_l, \rho}$ admits spirality 1. We can construct $H'_{\nu, \rho}$ by merging in parallel two representations $H'_{\mu_l, \rho}$ of $G_{\mu_l, \rho}$ and $H'_{\mu_r, \rho}$ of $G_{\mu_r, \rho}$ (in the same left-to-right order they have in $H_{\nu, \rho}$) in such a way that: $H'_{\mu_l, \rho}$ has spirality $\sigma'_{\mu_l} = 1$, $\sigma'_{\mu_r} = \sigma_{\mu_r} = -2$, $\alpha'_u = 0$, and $\alpha'_v = \alpha'_u = \alpha'_v = 1$; see Figure 10(b). Assume now that $G_{\mu_l, \rho}$ does not admit spirality 1 but admits spirality 0. We can construct $H'_{\nu, \rho}$ by merging in parallel two representations $H'_{\mu_l, \rho}$ of $G_{\mu_l, \rho}$ and $H'_{\mu_r, \rho}$ of $G_{\mu_r, \rho}$ (in the same left-to-right order they have in $H_{\nu, \rho}$) in such a way that: $H'_{\mu_l, \rho}$ has spirality $\sigma'_{\mu_l} = 0$, $\sigma'_{\mu_r} = \sigma_{\mu_r} = -2$, $\alpha'_u = \alpha'_v = 0$, and $\alpha'_u = \alpha'_v = 1$; see Fig. 10(c). In both cases $H'_{\nu, \rho}$ has spirality $\sigma'_\nu = \sigma_\nu$ and $\sigma'_{\mu_l} - \sigma'_{\mu_r} \in [2, 3]$.

– Case $\sigma_\nu > 0$: In this case, $\sigma_{\mu_l} > 3$ (because $\sigma_\nu = \sigma_{\mu_l} - \alpha_u^l - \alpha_v^l$ by Lemma 3, and $\alpha_u^l + \alpha_v^l = 2$ by hypothesis). See Fig. 10(d), where $\sigma_\nu = 2$. Hence, by Property (b) of Lemma 4, $G_{\mu_l, \rho}$ admits spirality $\sigma'_{\mu_l} = \sigma_{\mu_l} - 2$. We can construct $H'_{\nu, \rho}$ by merging in parallel two representations $H'_{\mu_l, \rho}$ of $G_{\mu_l, \rho}$ and $H'_{\mu_r, \rho}$ of $G_{\mu_r, \rho}$

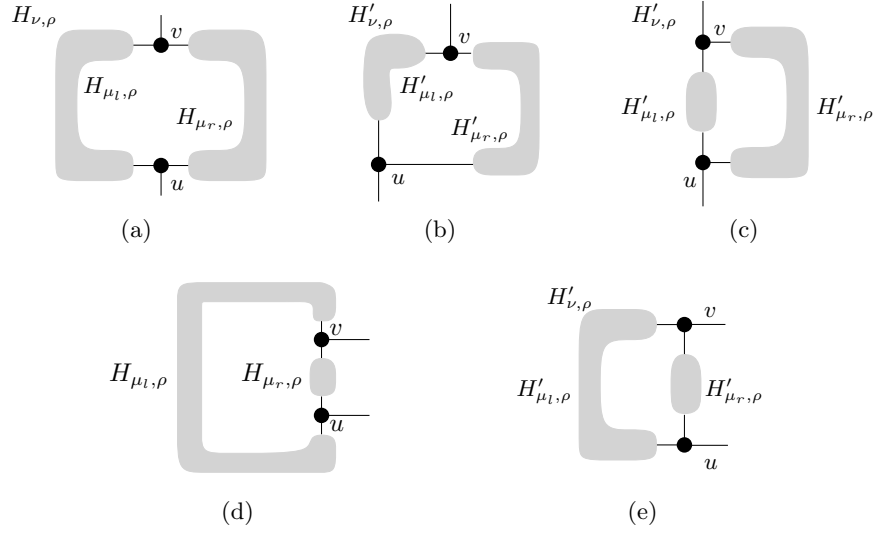

Fig. 10. Illustration for the proof of Lemma 4.

(in the same left-to-right order they have in $H_{\nu, \rho}$) in such a way that: $H'_{\mu_l, \rho}$ has spirality $\sigma'_{\mu_l} = \sigma_{\mu_l} - 2$, $\sigma'_{\mu_r} = \sigma_{\mu_r}$, $\alpha^l_u = \alpha^l_v = 0$, and $\alpha^r_u = \alpha^r_v = 1$. This way, $H_{\nu, \rho}$ has spirality $\sigma'_\nu = \sigma_\nu$ and $\sigma'_{\mu_l} - \sigma'_{\mu_r} = 2$. See Fig. 10(e), where $\sigma_\nu = 2$.

Lemma 6. Let $\Sigma_{\nu, \rho}^+$ be a non-trivial interval with maximum value $M > 2$. If $\Sigma_{\nu, \rho}^+$ contains an integer with parity different from that of M , $\Sigma_{\nu, \rho}^+ = [0, M]^1$.

Proof. Assume that M is odd (if M is even, the proof is similar). By hypothesis $M \geq 3$. We prove that, if Σ_{ν}^+ contains a value σ_ν whose parity is different from the one of M , then $\Sigma_{\nu, \rho}^+ = [0, M]^1$. The proof is by induction on the depth of the subtree of T_ρ rooted at ν . If ν is a Q^* -node, then $\Sigma_{\nu, \rho}^+ = [0, M]^1$ and the statement trivially holds. In the inductive case, ν is either an S-node or a P-node. By Corollary 1, $G_{\nu, \rho}$ admits spirality σ'_ν for every $\sigma'_\nu \in [1, M]^2$. Below, we analyze separately the case when ν is an S-node, a P-node with three children, or a P-node with two children.

– ν is an S-node. We prove that for any value $\sigma'_\nu \in [1, M]^2$, $G_{\nu, \rho}$ also admits spirality $\sigma'_\nu - 1$. This immediately implies that $\Sigma_{\nu, \rho}^+ = [0, M]^1$. We first prove the following claim:

Claim. There exists a child μ of ν in T_ρ that is jump-1.

Claim Proof. Let $H_{\nu, \rho}$ be a representation of $G_{\nu, \rho}$ with spirality σ_ν and let $H'_{\nu, \rho}$ be a representation of $G_{\nu, \rho}$ with spirality $\sigma'_\nu = \sigma_\nu + 1$. Note that $\sigma'_\nu \in [1, M]^2$, thus $H'_{\nu, \rho}$ exists. By Lemma 2, since the spiralities of $H_{\nu, \rho}$ and of $H'_{\nu, \rho}$ have different parities, ν must have a child μ such that $H_{\mu, \rho}$ has odd spirality in

$H_{\nu,\rho}$ and even spirality in $H'_{\nu,\rho}$, or vice versa. Let M_μ be the maximum spirality admitted by μ . Since μ admits both an even and an odd value of spirality, we have: If $M_\mu = 1$, μ admits 0 and $\Sigma_{\mu,\rho}^+ = [0, 1]^1$; if $M_\mu = 2$, by Property (a) of Lemma 4 and since μ admits spirality 1, either $\Sigma_{\mu,\rho}^+ = [0, 2]^1$ or $\Sigma_{\mu,\rho}^+ = [1, 2]^1$; if $M_\mu > 2$, by inductive hypothesis $\Sigma_{\mu,\rho}^+ = [0, M_\mu]^1$. Hence, μ is always jump-1. ■

Let μ be a child of ν having a jump-1 interval, which always exists by the previous claim. For any value $\sigma'_\nu \in [1, M]^2$, let $H'_{\nu,\rho}$ be a rectilinear representation of $G_{\nu,\rho}$ with spirality σ'_ν . Let σ_μ be the spirality of the restriction of $H'_{\nu,\rho}$ to $G_{\mu,\rho}$. Suppose first that $\sigma_\mu > -M_\mu$. Since by inductive hypothesis μ admits spirality $\sigma_\mu - 1$ then, by Lemma 2, ν admits $\sigma'_\nu - 1$. Suppose now that $\sigma_\mu = -M_\mu$. Since $\sigma'_\nu > 0$, by Lemma 2, there exists a child $\phi \neq \mu$ of ν such that the restriction of $H'_{\nu,\rho}$ to $G_{\phi,\rho}$ has spirality $\sigma_\phi > 0$. Observe that ϕ also admits either spirality $\sigma_\phi - 1$ or spirality $\sigma_\phi - 2$. Indeed, if $\sigma_\phi > 2$, then ϕ admits spirality $\sigma_\phi - 2$ by Property (b) of Lemma 4; if $\sigma_\phi = 2$ it also admits spirality 0 or 1 by Property (a) of Lemma 4; if $\sigma_\phi = 1$ then it also admits spirality -1. In the case that ϕ admits spirality $\sigma_\phi - 1$, by Lemma 2, ν admits spirality $\sigma'_\nu - 1$. In the case that ϕ admits spirality $\sigma_\phi - 2$, then μ admits spirality $\sigma_\mu + 1$ (because μ is jump-1 and we are assuming $\sigma_\mu = -M_\mu < M_\mu$), and hence ν admits spirality $\sigma_\phi - 2 + 1 = \sigma'_\nu - 1$.

$-\nu$ is a P-node with three children. In this case every child μ of ν is jump-1. Indeed, since ν admits an even and an odd value of spirality, by Lemma 1, the same holds for μ . As for the case of an S-node, if M_μ is the maximum value of spirality admitted by ν , we have the following: If $M_\mu = 1$, $\Sigma_\mu^+ = [0, 1]^1$; if $M_\mu = 2$, either $\Sigma_{\mu,\rho}^+ = [0, 2]^1$ or $\Sigma_{\mu,\rho}^+ = [1, 2]^1$; if $M_\mu > 2$, by inductive hypothesis $\Sigma_{\mu,\rho}^+ = [0, M_\mu]^1$. Hence, μ is jump-1.

Assume first that $M > 3$. Let $H_{\nu,\rho}$ be a representation of $G_{\nu,\rho}$ with spirality M . By Lemma 1, every child μ of ν , is such that the restriction of $H_{\nu,\rho}$ to $G_{\mu,\rho}$ has spirality $\sigma_\mu \geq 2$. Since μ is jump-1, then μ also admits spirality $\sigma_\mu - 1$. This implies that, ν admits a representation with spirality $M - 1$. Since $M - 1 > 2$, by Corollary 1, ν admits all values of spirality in the set $[0, M - 1]^2$, and hence $\Sigma_{\nu,\rho}^+ = [0, M - 1]^2 \cup [1, M]^2 = [0, M]^1$.

Assume now that $M = 3$. Let $H_{\nu,\rho}$ be a representation of $G_{\nu,\rho}$ with spirality M . The restrictions of $H_{\nu,\rho}$ to the three child components $G_{\mu_l,\rho}$, $G_{\mu_c,\rho}$, and $G_{\mu_r,\rho}$ of $G_{\nu,\rho}$, have spiralities 5, 3, and 1, respectively. Since μ_l is jump-1, by the inductive hypothesis it admits spirality for all values in the set $[0, 5]^1$. Similarly, since μ_c is jump-1, by the inductive hypothesis it admits spirality for all values in the set $[0, 3]^1$. Also, since μ_r is jump-1, it admits spirality 0 or 2. If μ_r admits spirality 0, then ν admits spirality $M - 1 = 2$ for a representation in which $G_{\mu_l,\rho}$, $G_{\mu_c,\rho}$, and $G_{\mu_r,\rho}$ appear in this left-to-right order (and have spiralities 4, 2, and 0, respectively). If μ_r admits spirality 2 but not spirality 0, then ν admits spirality $M - 1 = 2$ for a representation in which $G_{\mu_l,\rho}$, $G_{\mu_r,\rho}$, and $G_{\mu_c,\rho}$ appear in this order (and again have spiralities 4, 2, and 0, respectively). Hence, so far we have proved that ν admits spirality for all values in the set $[1, 3]^1$. Finally, as showed in the proof of Property (a) of Lemma 4 for a P-node with three children, the fact that ν admits spirality 2 implies that it also admits spirality 0 (see Figs. 6(a) and 6(d)).

– ν is a P-node with two children. Let $H_{\nu,\rho}$ be a rectilinear planar representation of $G_{\nu,\rho}$ with spirality M . Let σ_{μ_l} and σ_{μ_r} be the spiralities of the restrictions of $H_{\nu,\rho}$ to the left and right child components $G_{\mu_l,\rho}$ and $G_{\mu_r,\rho}$ of $G_{\nu,\rho}$, respectively. Also, let $\{u, v\}$ be the poles of ν . By Lemma 5, we can assume $\sigma_{\mu_l} - \sigma_{\mu_r} \in [2, 3]$, which implies that there exists $w \in \{u, v\}$ such that $\alpha_w^l = 0$, as $H_{\nu,\rho}$ has the maximum value of spirality admitted by ν . By Lemma 3, for $\alpha_w^l = 1$ and $\alpha_w^r = 0$ we can obtain a rectilinear planar representation of $G_{\nu,\rho}$ with spirality $M - 1$. If $M > 3$ then $M - 1 > 2$ and, by Corollary 1, ν admits spirality for all values in the set $[0, M - 1]^2$, and hence $\Sigma_{\mu,\rho}^+ = [0, M - 1]^2 \cup [1, M]^2 = [0, M]^1$. If $M = 3$, by Property (a) of Lemma 4, we have either $[0, 3]^1 \in \Sigma_{\mu,\rho}^+$ or $[1, 3]^1 \in \Sigma_{\mu,\rho}^+$. In the former case, $\Sigma_{\mu}^+ = [0, M]^1$. In the latter case, using a case analysis similar to the proof of Property (a) of Lemma 4 for the P-nodes with two children, it can be proved that 0 is also admitted by ν , and again $\Sigma_{\mu}^+ = [0, M]^1$.

Proof of Theorem 2. Let M be the maximum value in $\Sigma_{\nu,\rho}^+$. If $M = 0$ then $\Sigma_{\nu,\rho}^+ = [0]$. If $M = 1$ then either $\Sigma_{\nu,\rho}^+ = [1]$ or $\Sigma_{\nu,\rho}^+ = [0, 1]^1 = [0, M]^1$. Suppose $M = 2$; by Property (a) of Lemma 4, $G_{\nu,\rho}$ admits spirality 0, or 1, or both, i.e., $\Sigma_{\nu,\rho}^+ = [0, 2]^2 = [0, M]^2$, or $\Sigma_{\nu,\rho}^+ = [1, 2]^1$, or $\Sigma_{\nu,\rho}^+ = [0, 2]^1 = [0, M]^1$. Finally, suppose that $M > 2$. If $G_{\nu,\rho}$ admits a value of spirality whose parity is different from M , by Lemma 6 $\Sigma_{\nu,\rho}^+ = [0, M]^1$; else, by Corollary 1, either $\Sigma_{\nu,\rho}^+ = [1, M]^2$ (if M is odd) or $\Sigma_{\nu,\rho}^+ = [0, M]^2$ (if M is even).

Figure 9 shows examples of the non-negative spirality sets in Theorem 2.

4 Rectilinear Planarity Testing

Let G be a biconnected independent-parallel SP-graph that is not a simple cycle, T be its SPQ*-tree, and $\{\rho_1, \dots, \rho_h\}$ be the Q*-nodes of T . For each possible choice of the root $\rho \in \{\rho_1, \dots, \rho_h\}$, the algorithm visits T_ρ bottom-up in post-order and computes, for each visited node ν , the non-negative spirality set $\Sigma_{\nu,\rho}^+$, based on the sets of the children of ν . $\Sigma_{\nu,\rho}^+$ is representative of all “shapes” that $G_{\nu,\rho}$ can take in a rectilinear planar representation of G with the reference chain on the external face. The key lemmas used to show that we can efficiently execute this procedure over all SPQ*-tree T_ρ of G are Lemmas 7, 9, 10, and 13. From now on, we say that a node ν in T_ρ is *trivial*, or *jump-1*, or *jump-2*, if $\Sigma_{\nu,\rho}^+$ is a trivial interval, or a jump-1 interval, or a jump-2 interval, respectively.

Q*-nodes. Each chain of length ℓ can turn at most $\ell - 1$ times (one turn for each vertex). Therefore, for a Q*-node ν of T_ρ , we have $\Sigma_{\nu,\rho}^+ = [0, \ell - 1]^1$, and the following lemma holds, assuming that each Q*-node is equipped with the length of its corresponding chain when we compute the SPQ*-tree T of G .

Lemma 7. *Let G be an independent-parallel SP-graph, T_ρ be a rooted SPQ*-tree of G , and ν be a Q*-node of T_ρ . The set $\Sigma_{\nu,\rho}^+$ can be computed in $O(1)$ time.*

S-nodes. To prove Lemma 9 we first state a property of S-nodes of independent-parallel SP-graphs.

Lemma 8. *Let ν be an S -node of T_ρ . Node ν is jump-1 if and only if at least one of its children is jump-1. Also, $\Sigma_{\nu,\rho}^+ = [1, 2]^1$ if and only if ν has exactly one child with non-negative rectilinear spirality set $[1, 2]^1$ and all the other children with non-negative rectilinear spirality set $[0]$.*

Proof. We prove that ν is jump-1 if and only if at least one of its children is jump-1. Suppose first that ν is jump-1 and suppose by contradiction that all its children are trivial or jump-2. This implies that for each child μ of ν , $\Sigma_{\mu,\rho}^+$ contains only even values or only odd values. Denote by j the number of children of ν whose non-negative rectilinear spirality set contain only odd values. By Lemma 2, the spirality of any rectilinear representation of $G_{\nu,\rho}$ is the sum of the spiralities of all child components. It follows that $G_{\nu,\rho}$ admits only even values of spiralities if j is even and only odd values of spiralities if j is odd, which contradicts the hypothesis that ν is jump-1. Suppose vice versa that ν has at least a child μ that is jump-1. Denote by M the maximum value in $\Sigma_{\nu,\rho}^+$ and by M_μ the maximum value in $\Sigma_{\mu,\rho}^+$. Let $H_{\nu,\rho}$ be any rectilinear planar representation of $G_{\nu,\rho}$ having spirality M , and let $H_{\mu,\rho}$ be its restriction to $G_{\mu,\rho}$. By Lemma 2, $H_{\mu,\rho}$ has spirality M_μ . Also, since μ is jump-1, by Lemma 2 we can obtain a rectilinear representation $H'_{\nu,\rho}$ of $G_{\nu,\rho}$ with spirality $M - 1$ by simply replacing $H_{\mu,\rho}$ in $H_{\nu,\rho}$ with a rectilinear representation of $G_{\mu,\rho}$ having spirality $M_\mu - 1$. Therefore, by Theorem 2, ν is jump-1.

We now show the second part of the lemma. Suppose first that ν has exactly one child μ with non-negative rectilinear spirality set $[1, 2]^1$ and all the other children with non-negative rectilinear spirality set $[0]$. Clearly, by Lemma 2, $\Sigma_{\nu,\rho}^+ = \Sigma_{\mu,\rho}^+$, i.e., $\Sigma_{\nu,\rho}^+ = [1, 2]^1$. Suppose vice versa that $\Sigma_{\nu,\rho}^+ = [1, 2]^1$. By Lemma 2, the sum of the spiralities admitted by the child components of ν cannot be larger than two. If exactly one child of ν has non-negative rectilinear spirality set $[1, 2]^1$ and all the other children have non-negative rectilinear spirality set $[0]$, we are done. Otherwise, one of the following two cases must be considered: (i) There are two children μ and μ' of ν such that the maximum value of spirality admitted by $G_{\mu,\rho}$ and $G_{\mu',\rho}$ is 1 and any other child ν has non-negative rectilinear spirality set $[0]$; this case is ruled out by observing that $G_{\mu,\rho}$ (and $G_{\mu',\rho}$) would also admit spirality -1 and thus, by Lemma 2, $G_{\nu,\rho}$ would also admit spirality 0. (ii) ν has a child μ for which either $\Sigma_{\mu,\rho}^+ = [0, 2]^1$ or $\Sigma_{\mu,\rho}^+ = [0, 2]^2$ and any other child of ν has non-negative rectilinear spirality set $[0]$; again, this case is ruled out because it would imply that also $G_{\nu,\rho}$ admits spirality 0.

Lemma 9. *Let G be an independent-parallel SP-graph, T be the SPQ^* -tree of G , ν be an S -node of T with n_ν children, and $\rho_1, \rho_2, \dots, \rho_h$ be the Q^* -nodes of T . Assume that, for each child μ of ν in T_{ρ_i} , Σ_{μ,ρ_i}^+ is given. The set Σ_{ν,ρ_i}^+ can be computed in $O(n_\nu)$ time for $i = 1$ and in $O(1)$ time for $2 \leq i \leq h$.*

Proof. For any $i = 1, \dots, h$, let x_{ν,ρ_i} and y_{ν,ρ_i} be the number of children of ν in T_{ρ_i} with non-negative spirality set $[0]$ and $[1, 2]^1$, respectively. Also, let z_{ν,ρ_i} be the number of children that are jump-1 (clearly, $z_{\nu,\rho_i} \geq y_{\nu,\rho_i}$). Let M_{ν,ρ_i} be the maximum value in Σ_{ν,ρ_i}^+ . First, we show how to compute Σ_{ν,ρ_i}^+ in $O(1)$ time given

$x_{\nu,\rho_i}, y_{\nu,\rho_i}, z_{\nu,\rho_i}, M_{\nu,\rho_i}$. By Lemma 8, Σ_{ν,ρ_i}^+ is jump-1 if and only if $z_{\nu,\rho_i} > 0$. Suppose that Σ_{ν,ρ_i}^+ is jump-1. If $M_{\nu,\rho_i} \neq 2$, by Theorem 2, $\Sigma_{\nu,\rho_i}^+ = [0, M_{\nu,\rho_i}]^1$. If $M_{\nu,\rho_i} = 2$, Lemma 8 implies $\Sigma_{\nu,\rho_i}^+ = [1, 2]^1$ if $x_{\nu,\rho_i} + y_{\nu,\rho_i} = n_\nu$ and $y_{\nu,\rho_i} = 1$; otherwise $\Sigma_{\nu,\rho_i}^+ = [0, 2]^1$. Suppose now that Σ_{ν,ρ_i}^+ is not jump-1. By Theorem 2 we have: $\Sigma_{\nu,\rho_i}^+ = [0]$ if $M_{\nu,\rho_i} = 0$ and $\Sigma_{\nu,\rho_i}^+ = [1]$ if $M_{\nu,\rho_i} = 1$; $\Sigma_{\nu,\rho_i}^+ = [1, M_{\nu,\rho_i}]^2$ if $M_{\nu,\rho_i} > 1$ and M_{ν,ρ_i} is odd; $\Sigma_{\nu,\rho_i}^+ = [0, M_{\nu,\rho_i}]^2$ if $M_{\nu,\rho_i} > 1$ and M_{ν,ρ_i} is even.

We now show how to compute $x_{\nu,\rho_i}, y_{\nu,\rho_i},$ and z_{ν,ρ_i} for $i = 1, \dots, h$. If $i = 1$, given Σ_{μ,ρ_1}^+ for every child μ of ν in T_{ρ_1} , then $x_{\nu,\rho_1}, y_{\nu,\rho_1},$ and z_{ν,ρ_1} are computed in $O(n_\nu)$ time by just visiting each child of ν . Also, since by Lemma 2 the maximum spirality admitted by $G_{\nu,\rho}$ is the sum of the maximum spiralities admitted by the children of ν in T_{ρ_1} , we also compute M_{ν,ρ_1} and Σ_{ν,ρ_1}^+ in $O(n_\nu)$ time. We store at ν the values $x_{\nu,\rho_1}, y_{\nu,\rho_1}, z_{\nu,\rho_1},$ and M_{ν,ρ_1} .

Let $i \in \{2, \dots, h\}$. Let μ_1 be the parent of ν in T_{ρ_1} and let μ_i be the parent of ν in T_{ρ_i} . Note that, μ_1 is a child of ν in T_{ρ_i} and μ_i is a child of ν in T_{ρ_1} . Any other child of ν in T_{ρ_1} is also a child of ν in T_{ρ_i} and vice versa. To compute Σ_{ν,ρ_i}^+ in $O(1)$ time, we compute $x_{\nu,\rho_i}, y_{\nu,\rho_i}, z_{\nu,\rho_i}, M_{\nu,\rho_i}$ as follows: (i) Let $g_{\mu_i} = 1$ if $\Sigma_{\mu_i,\rho_1}^+ = [0]$ and $g_{\mu_i} = 0$ otherwise. Also, let $g_{\mu_1} = 1$ if $\Sigma_{\mu_1,\rho_i}^+ = [0]$ and $g_{\mu_1} = 0$ otherwise. We have $x_{\nu,\rho_i} = x_{\nu,\rho_1} - g_{\mu_i} + g_{\mu_1}$. (ii) Let $g'_{\mu_i} = 1$ if $\Sigma_{\mu_i,\rho_1}^+ = [1, 2]^1$ and $g'_{\mu_i} = 0$ otherwise. Also, let $g'_{\mu_1} = 1$ if $\Sigma_{\mu_1,\rho_i}^+ = [1, 2]^1$ and $g'_{\mu_1} = 0$ otherwise. We have $y_{\nu,\rho_i} = y_{\nu,\rho_1} - g'_{\mu_i} + g'_{\mu_1}$. (iii) Let $g''_{\mu_i} = 1$ if Σ_{μ_i,ρ_1}^+ is jump-1 and $g''_{\mu_i} = 0$ otherwise. Also, let $g''_{\mu_1} = 1$ if Σ_{μ_1,ρ_i}^+ is jump-1 and $g''_{\mu_1} = 0$ otherwise. We have $z_{\nu,\rho_i} = z_{\nu,\rho_1} - g''_{\mu_i} + g''_{\mu_1}$. (iv) $M_{\nu,\rho_i} = M_{\nu,\rho_1} - M_{\mu_i,\rho_1} + M_{\mu_1,\rho_i}$.

P-nodes. For a P-node ν , $\Sigma_{\nu,\rho}^+$ can be computed in $O(1)$ time, independent of ρ .

Lemma 10. *Let G be an independent-parallel SP-graph and let T_ρ be a rooted SPQ*-tree of G . Let ν be a P-node of T_ρ and assume that, for each child μ of ν in T_ρ , the set $\Sigma_{\mu,\rho}^+$ is given. The set $\Sigma_{\nu,\rho}^+$ can be computed in $O(1)$ time.*

To prove Lemma 10, we prove Lemmas 11 and 12, which treat separately the case of a P-node with three children and the case of a P-node with two children.

Lemma 11. *Let G be an independent-parallel SP-graph and let T_ρ be a rooted SPQ*-tree of G . Let ν be a P-node of T_ρ with three children and assume that, for each child μ of ν in T_{ρ_i} , the set Σ_{μ,ρ_i}^+ is given. The set $\Sigma_{\nu,\rho}^+$ can be computed in $O(1)$ time.*

Proof. Observe that, by Lemma 1, for any given integer value $\sigma_\nu \geq 0$, one can test in $O(1)$ time whether $G_{\nu,\rho}$ admits spirality σ_ν . It suffices to test if there exists a child of ν that admits spirality σ_ν , another child that admits spirality $\sigma_\nu + 2$, and the remaining child that admits spirality $\sigma_\nu - 2$. Testing this condition requires a constant number of checks.

By Theorem 2, $G_{\nu,\rho}$ is rectilinear planar if and only if it admits spirality either 0 or 1. Based on the previous observation, we can check this property in $O(1)$ time; if it does not hold, then $\Sigma_{\nu,\rho}^+ = \emptyset$. Otherwise, we determine the maximum value M in $\Sigma_{\nu,\rho}^+$. By Theorem 2, it suffices to find a value σ_ν such that ν admits spirality σ_ν but it does not admit spirality $\sigma_\nu + 1$ and $\sigma_\nu + 2$; if

we find such a value, then $M = \sigma_\nu$. Using this observation, we prove that one can find M in $O(1)$ time.

For each $i = 0, \dots, 4$, we can first check in $O(1)$ time whether $M = i$. If this is not the case, then $M > 4$. To find M in this case, we first claim an interesting property. Consider the maximum values in the non-negative rectilinear spirality sets of the children of ν . Denote by μ_{\max} (resp. μ_{\min}) any child of ν whose maximum value is not smaller than (resp. the larger than) any other maximum values. Also denote by μ_{mid} the remaining child. We prove the following claim.

Claim. Let M be the maximum value in $\Sigma_{\nu,\rho}^+$. If $M > 4$ then $G_{\nu,\rho}$ admits spirality M for an embedding where $G_{\mu_{\max},\rho}$, $G_{\mu_{\text{mid}},\rho}$, and $G_{\mu_{\min},\rho}$ appear in this left-to-right order.

Claim Proof. Let $H_{\nu,\rho}$ be a rectilinear planar representation of $G_{\nu,\rho}$ with spirality $M > 4$. If $G_{\mu_{\max},\rho}$, $G_{\mu_{\text{mid}},\rho}$, and $G_{\mu_{\min},\rho}$ appear in this order in $H_{\nu,\rho}$ we are done. Hence, suppose this is not the case; we prove that there exists another rectilinear planar representation $H'_{\nu,\rho}$ of $G_{\nu,\rho}$ with spirality M and such that $G_{\mu_{\max},\rho}$, $G_{\mu_{\text{mid}},\rho}$, and $G_{\mu_{\min},\rho}$ appear in this left-to-right order in the planar embedding of $H'_{\nu,\rho}$.

Let μ_l , μ_c , and μ_r be the children of ν that correspond to the left, the central, and the right component of $H_{\nu,\rho}$, respectively. Denote by σ_{μ_d} the spirality of the restriction of $H_{\nu,\rho}$ to $G_{\mu_d,\rho}$, with $d \in \{l, c, r\}$. By Lemma 1, it suffices to show that $G_{\mu_{\max},\rho}$, $G_{\mu_{\text{mid}},\rho}$, and $G_{\mu_{\min},\rho}$ admit spiralities σ_{μ_l} , σ_{μ_c} , and σ_{μ_r} , respectively. Observe that, since $M > 4$, by Lemma 1 we have $\sigma_{\mu_d} > 0$.

Let $d, d' \in \{l, c, r\}$ with $d \neq d'$ and let M_{μ_d} be the maximum value of spirality in $\Sigma_{\mu_d,\rho}^+$. We claim that if $\sigma_{\mu_{d'}} \leq M_{\mu_d}$ then $G_{\mu_d,\rho}$ admits spirality $\sigma_{\mu_{d'}}$: Since $M > 4$, by Lemma 1 we have $M_{\mu_d} \geq 3$ and if μ_d is jump-1, the claim holds by Theorem 2; if μ_d is not jump-1, by Lemma 1 it follows that M , M_{μ_d} , and $\sigma_{\mu_{d'}}$ have the same parity and, by Theorem 2 the claim holds.

We now show separately that: (a) $G_{\mu_{\max},\rho}$ admits spirality σ_{μ_l} , (b) $G_{\mu_{\text{mid}},\rho}$ admits spirality σ_{μ_c} , and (c) $G_{\mu_{\min},\rho}$ admits spirality σ_{μ_r} .

Proof of (a): Since by definition $M_{\mu_{\max}} \geq M_{\mu_l} \geq \sigma_{\mu_l}$, by the claim above we have that $G_{\mu_{\max},\rho}$ admits spirality σ_{μ_l} .

Proof of (b): If $\mu_{\text{mid}} = \mu_c$ we are done. Else, suppose that $\mu_{\text{mid}} = \mu_l$. Since $\sigma_{\mu_l} \geq \sigma_{\mu_c}$, we have $M_{\text{mid}} = M_l \geq \sigma_{\mu_l} > \sigma_{\mu_c}$ and, consequently, by the claim $G_{\mu_{\text{mid}},\rho}$ admits spirality σ_{μ_c} . Finally, suppose that $\mu_{\text{mid}} = \mu_r$. If $\mu_{\min} = \mu_c$ then $M_{\mu_{\text{mid}}} \geq M_{\mu_{\min}} \geq \sigma_{\mu_c}$; if $\mu_{\min} = \mu_l$ then $M_{\mu_{\text{mid}}} \geq M_{\mu_{\min}} \geq \sigma_{\mu_l} > \sigma_{\mu_c}$. Hence, by the claim, $G_{\mu_{\text{mid}},\rho}$ admits spirality σ_{μ_c} .

Proof of (c): Since $\sigma_{\mu_r} < \sigma_{\mu_c} < \sigma_{\mu_l}$, for any $\mu \in \{\mu_{\min}, \mu_{\text{mid}}, \mu_{\max}\}$, $\sigma_{\mu_r} \leq M_\mu$. Hence, by the claim, $G_{\mu_{\min},\rho}$ admits spirality σ_{μ_r} . ■

By the claim, to compute M when $M > 4$, we can restrict to consider only rectilinear planar representations of $G_{\nu,\rho}$ where $G_{\mu_{\max},\rho}$, $G_{\mu_{\text{mid}},\rho}$, and $G_{\mu_{\min},\rho}$ occur in this left-to-right order. Let $\bar{M} = \min\{M_{\mu_{\max}} - 2, M_{\mu_{\text{mid}}}, M_{\mu_{\min}} + 2\}$. By Lemma 1, we have $M \leq \bar{M}$. We test in $O(1)$ time whether ν is jump-1; by Theorem 2, it is sufficient to check whether $G_{\nu,\rho}$ either admits both spiralities 0

and 1 or both spiralities 1 and 2. If ν is jump-1, by Lemma 1, all the children of ν are jump-1. Hence, μ_{\max} , μ_{mid} , and μ_{\min} admit spiralities $\overline{M} - 2$, \overline{M} , and $\overline{M} + 2$, respectively, which implies that $M = \overline{M}$. Suppose vice versa that ν is not jump-1. In this case, we check in $O(1)$ if $G_{\nu,\rho}$ admits spirality \overline{M} . If so, $M = \overline{M}$. Otherwise, M and \overline{M} have opposite parity, which implies that M and $\overline{M} - 1$ have the same parity, and $M \leq \overline{M} - 1$. Since $\overline{M} - 1 = \min\{M_{\mu_{\max}} - 2, M_{\mu_{\text{mid}}}, M_{\mu_{\min}} + 2\} - 1$, we have that μ_{\max} , μ_{mid} , and μ_{\min} admit spiralities $(\overline{M} - 2) - 1$, $\overline{M} - 1$, and $(\overline{M} + 2) - 1$, respectively, i.e., $M = \overline{M} - 1$.

Based on M , we finally determine the structure of $\Sigma_{\nu,\rho}^+$ in $O(1)$ time. Namely, we check in $O(1)$ time if ν is jump-1; thanks to Theorem 2 it suffices to check whether $G_{\nu,\rho}$ admits spiralities 0 and 1 or spiralities 1 and 2. Suppose that ν is jump-1; if it contains 0, then $\Sigma_{\nu,\rho}^+ = [0, M]^1$; else $\Sigma_{\nu,\rho}^+ = [1, 2]^1$. Suppose vice versa that ν is not jump-1. If $M \leq 1$ then $\Sigma_{\nu,\rho}^+ = [M]$. Otherwise, if M is odd $\Sigma_{\nu,\rho}^+ = [1, M]^2$ and if M is even $\Sigma_{\nu,\rho}^+ = [0, M]^2$.

Lemma 12. *Let G be an independent-parallel SP-graph and let T_ρ be a rooted SPQ*-tree of G . Let ν be a P-node of T_ρ with two children and assume that, for each child μ of ν in T_{ρ_i} , the set Σ_{μ,ρ_i}^+ is given. The set $\Sigma_{\nu,\rho}^+$ can be computed in $O(1)$ time.*

Proof. We follow the same proof strategy as for Lemma 11. By Lemma 3, for any given integer σ_ν , one can test in $O(1)$ time whether $G_{\nu,\rho}$ admits spirality σ_ν . Indeed, it suffices to test whether there are four binary numbers α_u^l , α_v^l , α_u^r , and α_v^r such that $1 \leq \alpha_u^l + \alpha_u^r \leq 2$, $1 \leq \alpha_v^l + \alpha_v^r \leq 2$, and for which one child of ν admits spirality $\sigma_\nu + \alpha_u^l + \alpha_v^l$ and the other child of ν admits spirality $\sigma_\nu - \alpha_u^r + \alpha_v^r$. Testing this condition requires a constant number of checks.

By Theorem 2, $G_{\nu,\rho}$ is rectilinear planar if and only if it admits spirality either 0 or 1. Based on the reasoning above, we can check this property in $O(1)$ time; if it does not hold, then $\Sigma_{\nu,\rho}^+ = \emptyset$. Otherwise, we determine the maximum value M in $\Sigma_{\nu,\rho}^+$. By Theorem 2, it suffices to find a value σ_ν such that ν admits spirality σ_ν but it does not admit spirality $\sigma_\nu + 1$ and $\sigma_\nu + 2$; if we find such a value, then $M = \sigma_\nu$. We prove how to find M in $O(1)$ time.

For each $i = 0, \dots, 4$, we first check in $O(1)$ time whether $M = i$. If this is not the case, then $M > 4$. To find M in this case, we claim a property similar to the case of a P-node with three children. Denote by μ_{\max} a child of ν whose maximum value is not smaller than the other. Let μ_{\min} be the remaining child.

Claim. Let M be the maximum value in $\Sigma_{\nu,\rho}^+$. If $M > 4$, there exists a rectilinear planar representation of $G_{\nu,\rho}$ with spirality M where $G_{\mu_{\max},\rho}$ and $G_{\mu_{\min},\rho}$ appear in this left-to-right order.

Claim Proof. Let $H_{\nu,\rho}$ be a rectilinear planar representation of $G_{\nu,\rho}$ with spirality M . If $G_{\mu_{\max},\rho}$ is the left child in $H_{\nu,\rho}$, we are done. Otherwise we show that there exists a rectilinear planar representation $H'_{\nu,\rho}$ of $G_{\nu,\rho}$ with spirality M such that $G_{\mu_{\max},\rho}$ is the left child. Since $H_{\nu,\rho}$ has the maximum possible value of spirality, we have $\alpha_u^r = \alpha_v^r = 1$. Since μ_{\min} is the left child

in $H_{\nu,\rho}$ and $M > 4$, by Lemma 3, $\sigma_{\mu_{\min}} > 2$. By Property (b) of Lemma 4, there exists a rectilinear planar representation $H'_{\mu_{\min},\rho}$ of $G_{\mu_{\min},\rho}$ with spirality $\sigma'_{\mu_{\min},\rho} = \sigma_{\mu_{\min}} - 2$. Also, by Lemma 5 we can assume that $\sigma_{\mu_{\min}} - \sigma_{\mu_{\max}} = g$, with $2 \leq g \leq 3$. We have $M_{\mu_{\max}} \geq M_{\mu_{\min}} \geq \sigma_{\mu_{\min}} = g + \sigma_{\mu_{\max}}$. Hence, by Theorem 2, if $\sigma_{\mu_{\max}}$ and $M_{\mu_{\max}}$ have different parities, then μ_{\max} is jump-1, otherwise it is jump-2. In both cases, μ_{\max} admits spirality $\sigma'_{\mu_{\max}} = \sigma_{\mu_{\max}} + 2$. We have $\sigma'_{\mu_{\max}} - \sigma'_{\mu_{\min}} = \sigma_{\mu_{\max}} + 2 - \sigma_{\mu_{\min}} - 2 = \sigma_{\mu_{\max}} - \sigma_{\mu_{\min}} = g$. Hence, by Lemma 3, there exists a rectilinear planar representation $H'_{\nu,\rho}$ that contains $H'_{\mu_{\min},\rho}$ and $H'_{\mu_{\max},\rho}$ in this left-to-right order and such. The spirality σ'_ν of $H'_{\nu,\rho}$ is $\sigma'_\nu = \sigma'_{\mu_{\min}} + 2 = \sigma_{\mu_{\min}} \geq \sigma_{\mu_{\max}} + 2 = M$. ■

When $M > 4$, by Lemma 3, we have $M_{\mu_{\min}} > 2$ and $M_{\mu_{\max}} > 2$. By the claim above we can restrict to consider only rectilinear planar representations of $G_{\nu,\rho}$ where $G_{\mu_{\max},\rho}$ and $G_{\mu_{\min},\rho}$ are the left and right child, respectively. Also, we can restrict to consider $\alpha_u^r = \alpha_v^r = 1$. By Lemma 3, $M \leq \min\{M_{\mu_{\max}}, M_{\mu_{\min}} + 2\}$.

Suppose first that $M_{\mu_{\max}} \geq M_{\mu_{\min}} + 2$, which implies $M \leq M_{\mu_{\min}} + 2$. We show that in fact $M = M_{\mu_{\min}} + 2$, i.e., ν admits spirality $M_{\mu_{\min}} + 2$. Since $M_{\mu_{\max}} \geq M_{\mu_{\min}} + 2$, we have that μ_{\max} admits spirality $M_{\mu_{\min}} + 2$ or $M_{\mu_{\min}} + 3$. Since $M_{\mu_{\max}} \geq M_{\mu_{\min}} + 2$, we have that μ_{\max} admits spirality $M_{\mu_{\min}} + 2$ or $M_{\mu_{\min}} + 3$; this implies that we can realize a rectilinear planar representation of $G_{\nu,\rho}$ whose restrictions to $G_{\mu_{\min},\rho}$ and to $G_{\mu_{\max},\rho}$ have spiralities $\sigma_{\mu_{\min}} = M_{\mu_{\min}}$ and $\sigma_{\mu_{\max}} \in [M_{\mu_{\min}} + 2, M_{\mu_{\min}} + 3]$, respectively. By Lemma 3, if $\sigma_{\mu_{\max}} = M_{\mu_{\min}} + 2$ then $G_{\nu,\rho}$ admits spirality $M_{\mu_{\min}} + 2$ for $\alpha_u^l = \alpha_v^l = 0$. If $\sigma_{\mu_{\max}} = M_{\mu_{\min}} + 3$ then $G_{\nu,\rho}$ admits spirality $M_{\mu_{\min}} + 2$ for $\alpha_u^l = 1$ and $\alpha_v^l = 0$.

Suppose vice versa that $M_{\mu_{\max}} < M_{\mu_{\min}} + 2$, which implies $M \leq M_{\mu_{\max}}$. In this case we show that either $M = M_{\mu_{\max}}$ or $M = M_{\mu_{\max}} - 1$. Since $M_{\mu_{\min}} > M_{\mu_{\max}} - 2$, we have that μ_{\min} admits spirality $M_{\mu_{\max}} - 2$ or $M_{\mu_{\max}} - 3$. If μ_{\min} admits spirality $M_{\mu_{\max}} - 2$, then we can realize a rectilinear planar representation of $G_{\nu,\rho}$ whose restrictions to $G_{\mu_{\min},\rho}$ and to $G_{\mu_{\max},\rho}$ have spiralities $\sigma_{\mu_{\max}} = M_{\mu_{\max}}$ and $\sigma_{\mu_{\min}} = M_{\mu_{\max}} - 2$, respectively. By Lemma 3, this representation has spirality $M_{\mu_{\max}}$, which implies $M = M_{\mu_{\max}}$. If μ_{\min} does not admit spirality $M_{\mu_{\max}} - 2$, it admits spirality $M_{\mu_{\max}} - 3$ and $M \leq M_{\mu_{\max}} - 1$. In this case we realize a rectilinear representation of $G_{\nu,\rho}$ whose restrictions to $G_{\mu_{\min},\rho}$ and to $G_{\mu_{\max},\rho}$ have spiralities $\sigma_{\mu_{\max}} = M_{\mu_{\max}}$ and $\sigma_{\mu_{\min}} = M_{\mu_{\max}} - 3$. By Lemma 3, this representation has spirality $M_{\mu_{\max}} - 1$, which implies that $M = M_{\mu_{\max}} - 1$.

Based on M , we finally determine the structure of $\Sigma_{\mu,\rho}^+$ in $O(1)$ time. We have that G_ν admits a rectilinear planar representation with spirality M and $M - 1$. Indeed, if ν has spirality M , then $\alpha_u^r = \alpha_v^r = 1$ and, by Lemma 5, at least one of α_u^l and α_v^l equals 0, say for example $\alpha_u^l = 0$. For $\alpha_u^l = 1$ we get spirality $M - 1$. Hence, by Theorem 2, ν is jump-1: If $M = 2$ and G_ν does not admit a representation with spirality 0, $\Sigma_{\mu,\rho}^+ = [1, 2]^1$. Otherwise, $\Sigma_{\mu,\rho}^+ = [0, M]^1$.

Testing algorithm. Let G be an independent-parallel SP-graph different from a simple cycle, T_ρ be a rooted SPQ*-tree of G , and ν be the child of ρ in T_ρ . At the level of the root the test consists of verifying whether ν and ρ admit spirality values $\sigma_\nu \in \Sigma_{\nu,\rho}^+$ and $\sigma_\rho \in \Sigma_{\rho,\rho}^+$, respectively, such that $\sigma_\nu + \sigma_\rho = 4$.

Lemma 13. *Let G be an independent-parallel SP-graph, T_ρ be a rooted SPQ*-tree of G , and ν be the child of ρ in T_ρ . If $G_{\nu,\rho}$ is rectilinear planar, one can test whether G is rectilinear planar in $O(1)$ time.*

Proof. The child ν of the root ρ in T_ρ is either a P-node or an S-node with poles u and v of indegree two. In both cases, the alias vertices associated with u and v are dummy vertices that subdivide the reference chain represented by ρ . Let ℓ be the length of the reference chain represented by ρ ; we know that $\Sigma_{\rho,\rho}^+ = [0, \ell - 1]^1$. In every cycle C of a rectilinear representation of G , the difference between the number of right turns and the number left turns, while walking along the boundary of C clockwise, is equal to four. Hence, G is rectilinear planar if and only if we can find a value $\sigma_\nu \in \Sigma_{\nu,\rho}^+$ and a value $0 \leq k \leq \ell - 1$ such that $\sigma_\nu + k = 4$. Hence, for any pair $\sigma_\nu \in \{0, 1, 2, 3, 4\}$ and $k \in \{0, 1, 2, 3, 4\}$ such that $\sigma_\nu + k = 4$ we just test whether $\sigma_\nu \in \Sigma_{\nu,\rho}^+$ and $k \in \{0, \dots, \ell - 1\}$. This requires a constant number of checks.

Theorem 3. *Let G be an independent-parallel SP-graph with n vertices. There exists an $O(n)$ -time algorithm that tests whether G is rectilinear planar.*

Proof. If G is a simple cycle, the test is trivial, as G is rectilinear planar if and only if it contains at least four vertices. Assume that G is not a simple cycle. Let T be the SPQ*-tree of G , and let ρ_1, \dots, ρ_h be the Q*-nodes of T . For each $i = 1, \dots, h$, the testing algorithm performs a post-order visit of T_{ρ_i} . During this visit, for every non-root node ν of T_{ρ_i} the algorithm computes Σ_{ν,ρ_i}^+ by using Lemmas 7, 9, and 10. If $\Sigma_{\nu,\rho_i}^+ = \emptyset$, the algorithm stops the visit, discards T_{ρ_i} , and starts visiting $T_{\rho_{i+1}}$ (if $i < h$). If the algorithm achieves the root child ν and if $\Sigma_{\nu,\rho_i}^+ \neq \emptyset$, it checks whether G is rectilinear planar by using Lemma 13: if so, the test is positive and the algorithm does not visit the remaining trees; otherwise it discards T_{ρ_i} and starts visiting $T_{\rho_{i+1}}$ (if $i < h$).

We now analyze the time complexity of the testing algorithm. When the algorithm visits T_{ρ_1} , for any ν with n_ν children it computes Σ_{ν,ρ_1}^+ in $O(n_\nu)$ time if ν is an S-node (Lemma 9) and in $O(1)$ time otherwise (Lemmas 7 and 10). Hence, since T has $O(n)$ nodes and the sum of the degree of its nodes is $O(n)$, T_{ρ_1} is visited in $O(n)$ time. For every other visit of a tree T_{ρ_i} ($i = 2, \dots, h$), the algorithm spends $O(1)$ to compute the non-negative spirality set of each node ν , even when ν is an S-node (Lemma 9). Also, the algorithm does not need to recompute Σ_{ν,ρ_i}^+ if the parent of ν in T_{ρ_i} coincides with the parent of T_{ρ_j} for some $j \in \{1, \dots, i - 1\}$; in fact, in this case, Σ_{ν,ρ_i}^+ coincides with Σ_{ν,ρ_j}^+ , which was previously computed and can be simply reused. Therefore, since every node ν with n_ν children changes its parent node n_ν times over all visits of T_{ρ_i} ($i = 2, \dots, h$), and since the sum of the degree of the nodes of T is $O(n)$, the algorithm needs to compute $O(n)$ non-negative spirality sets in total, each requiring $O(1)$ time. Thus, the testing algorithm takes $O(n)$ time.

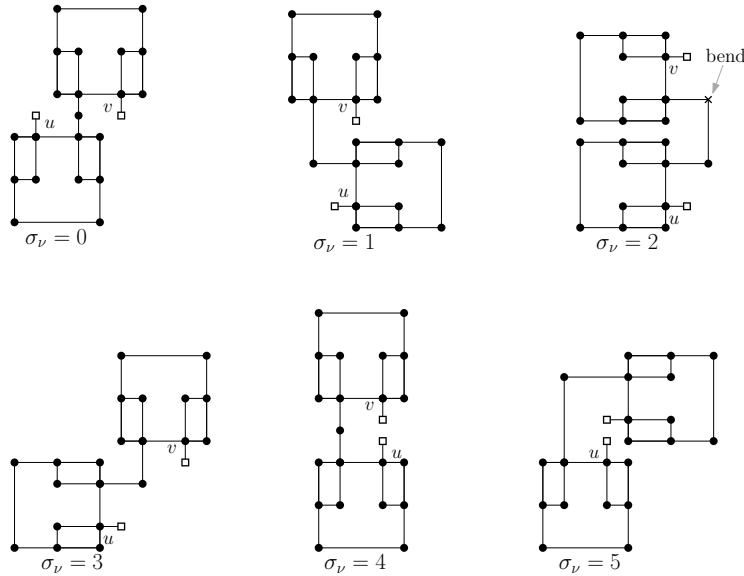

Fig. 11. Component that admits spiralities 0,1,3,4,5. Spirality 2 needs a bend (\times).

5 Final Remarks

In this paper we showed that rectilinear planarity for independent-parallel SP-graphs can be tested in linear time in the variable embedding setting. It is not difficult to see that if the testing is positive, a rectilinear planar representation of G can also be constructed in linear time by a variant of the technique described in [7]: Visit T_ρ top-down and for each node ν compute a target value of spirality in $\Sigma_{\nu,\rho}^+$, based on whether ν is an S-node, a P-node, or a Q^* -node.

The problem about whether the result of Theorem 3 can be extended to every SP-graph remains open. We just observe here that the spirality set of a component of an SP-graph that is not independent-parallel may not exhibit a behavior like the one described in Theorem 2. For example, the component shown in Fig. 11 is rectilinear planar for all spirality values from 0 to 5 except 2.

References

1. F. Brandenburg, D. Eppstein, M. T. Goodrich, S. G. Kobourov, G. Liotta, and P. Mutzel. Selected open problems in graph drawing. In G. Liotta, editor, *Graph Drawing, 11th International Symposium, GD 2003, Perugia, Italy, September 21-24, 2003, Revised Papers*, volume 2912 of *Lecture Notes in Computer Science*, pages 515–539. Springer, 2003. URL: https://doi.org/10.1007/978-3-540-24595-7_55, doi:10.1007/978-3-540-24595-7_55.

2. S. Cornelsen and A. Karrenbauer. Accelerated bend minimization. *J. Graph Algorithms Appl.*, 16(3):635–650, 2012. URL: <https://doi.org/10.7155/jgaa.00265>, doi:10.7155/jgaa.00265.
3. G. Di Battista and W. Didimo. Gdtoolkit. In *Handbook of Graph Drawing and Visualization*, pages 571–597. Chapman and Hall/CRC, 2013.
4. G. Di Battista, P. Eades, R. Tamassia, and I. G. Tollis. *Graph Drawing: Algorithms for the Visualization of Graphs*. Prentice-Hall, 1999.
5. G. Di Battista, G. Liotta, and F. Vargiu. Spirality and optimal orthogonal drawings. *SIAM J. Comput.*, 27(6):1764–1811, 1998. URL: <https://doi.org/10.1137/S0097539794262847>, doi:10.1137/S0097539794262847.
6. E. Di Giacomo, G. Liotta, and F. Montecchiani. Sketched representations and orthogonal planarity of bounded treewidth graphs. In *Graph Drawing*, volume 11904 of *Lecture Notes in Computer Science*, pages 379–392. Springer, 2019.
7. W. Didimo, M. Kaufmann, G. Liotta, and G. Ortali. Rectilinear planarity testing of plane series-parallel graphs in linear time. In *Graph Drawing*, volume 12590 of *Lecture Notes in Computer Science*, pages 436–449. Springer, 2020.
8. W. Didimo and G. Liotta. Computing orthogonal drawings in a variable embedding setting. In *ISAAC*, volume 1533 of *Lecture Notes in Computer Science*, pages 79–88. Springer, 1998.
9. W. Didimo and G. Liotta. Mining graph data. In D. J. Cook and L. B. Holder, editors, *Graph Visualization and Data Mining*, pages 35–64. Wiley, 2007.
10. W. Didimo, G. Liotta, G. Ortali, and M. Patrignani. Optimal orthogonal drawings of planar 3-graphs in linear time. In S. Chawla, editor, *Proceedings of the 2020 ACM-SIAM Symposium on Discrete Algorithms, SODA 2020, Salt Lake City, UT, USA, January 5-8, 2020*, pages 806–825. SIAM, 2020. URL: <https://doi.org/10.1137/1.9781611975994.49>, doi:10.1137/1.9781611975994.49.
11. C. A. Duncan and M. T. Goodrich. Planar orthogonal and polyline drawing algorithms. In R. Tamassia, editor, *Handbook on Graph Drawing and Visualization.*, pages 223–246. Chapman and Hall/CRC, 2013. URL: <https://www.crcpress.com/Handbook-of-Graph-Drawing-and-Visualization/Tamassia/9781584884125>.
12. F. Frati. Planar rectilinear drawings of outerplanar graphs in linear time. In *Graph Drawing*, volume 12590 of *Lecture Notes in Computer Science*, pages 423–435. Springer, 2020.
13. A. Garg and R. Tamassia. A new minimum cost flow algorithm with applications to graph drawing. In S. C. North, editor, *Graph Drawing, Symposium on Graph Drawing, GD '96, Berkeley, California, USA, September 18-20, Proceedings*, volume 1190 of *Lecture Notes in Computer Science*, pages 201–216. Springer, 1996. URL: https://doi.org/10.1007/3-540-62495-3_49, doi:10.1007/3-540-62495-3_49.
14. A. Garg and R. Tamassia. On the computational complexity of upward and rectilinear planarity testing. *SIAM J. Comput.*, 31(2):601–625, 2001. URL: <https://doi.org/10.1137/S0097539794277123>, doi:10.1137/S0097539794277123.
15. C. Gutwenger and P. Mutzel. A linear time implementation of spqr-trees. In J. Marks, editor, *Graph Drawing, 8th International Symposium, GD 2000, Colonial Williamsburg, VA, USA, September 20-23, 2000, Proceedings*, volume 1984 of *Lecture Notes in Computer Science*, pages 77–90. Springer, 2000. URL: https://doi.org/10.1007/3-540-44541-2_8, doi:10.1007/3-540-44541-2_8.
16. M. M. Hasan and M. S. Rahman. No-bend orthogonal drawings and no-bend orthogonally convex drawings of planar graphs (extended abstract). In D. Du,

- Z. Duan, and C. Tian, editors, *Computing and Combinatorics - 25th International Conference, COCOON 2019, Xi'an, China, July 29-31, 2019, Proceedings*, volume 11653 of *Lecture Notes in Computer Science*, pages 254–265. Springer, 2019. URL: https://doi.org/10.1007/978-3-030-26176-4_21, doi:10.1007/978-3-030-26176-4_21.
17. J. E. Hopcroft and R. E. Tarjan. Dividing a graph into triconnected components. *SIAM J. Comput.*, 2(3):135–158, 1973. URL: <https://doi.org/10.1137/0202012>, doi:10.1137/0202012.
 18. M. Jünger and P. Mutzel, editors. *Graph Drawing Software*. Springer, 2004. URL: <https://doi.org/10.1007/978-3-642-18638-7>, doi:10.1007/978-3-642-18638-7.
 19. M. Kaufmann and D. Wagner, editors. *Drawing Graphs, Methods and Models (the book grow out of a Dagstuhl Seminar, April 1999)*, volume 2025 of *Lecture Notes in Computer Science*. Springer, 2001. URL: <https://doi.org/10.1007/3-540-44969-8>, doi:10.1007/3-540-44969-8.
 20. T. Nishizeki and M. S. Rahman. *Planar Graph Drawing*, volume 12 of *Lecture Notes Series on Computing*. World Scientific, 2004.
 21. M. S. Rahman, N. Egi, and T. Nishizeki. No-bend orthogonal drawings of subdivisions of planar triconnected cubic graphs. *IEICE Trans. Inf. Syst.*, 88-D(1):23–30, 2005. URL: http://search.ieice.org/bin/summary.php?id=e88-d_1_23&category=D&year=2005&lang=E&abst=.
 22. M. S. Rahman, T. Nishizeki, and M. Naznin. Orthogonal drawings of plane graphs without bends. *J. Graph Algorithms Appl.*, 7(4):335–362, 2003. URL: <http://jgaa.info/accepted/2003/Rahman+2003.7.4.pdf>.
 23. R. Tamassia. On embedding a graph in the grid with the minimum number of bends. *SIAM J. Comput.*, 16(3):421–444, 1987. URL: <https://doi.org/10.1137/0216030>, doi:10.1137/0216030.
 24. X. Zhou and T. Nishizeki. Orthogonal drawings of series-parallel graphs with minimum bends. *SIAM J. Discret. Math.*, 22(4):1570–1604, 2008. URL: <https://doi.org/10.1137/060667621>, doi:10.1137/060667621.