

# BORDERED MANIFOLDS WITH TORUS BOUNDARY AND THE LINK SURGERY FORMULA

IAN ZEMKE

ABSTRACT. In this paper, we develop a theory of bordered  $HF^-$  using the link surgery formula of Manolescu and Ozsváth. We interpret their link surgery complexes as type- $D$  modules over an associative algebra  $\mathcal{K}$ , which we introduce. We prove a connected sum formula, which we interpret as an  $A_\infty$ -tensor product over our algebra  $\mathcal{K}$ . Topologically, this connected sum formula may be viewed as a formula for gluing along torus boundary components. We compute several important examples. We show that the dual knot formula of Hedden–Levine and Eftekhary may be interpreted as the  $DA$ -bimodule for a particular diffeomorphism of the torus. As another example, if  $K_1$  and  $K_2$  are knots in  $S^3$ , and  $Y$  is obtained by gluing the complements of  $K_1$  and  $K_2$  together using an orientation reversing diffeomorphism of their boundaries, then our theory may be used to compute  $CF^-(Y)$  from  $CFK^\infty(K_1)$  and  $CFK^\infty(K_2)$ . We additionally compute the type- $D$  modules for rationally framed solid tori. Our theory also computes the Heegaard Floer homology of all 3-manifolds which bound a plumbing of a tree of disk bundles over 2-spheres. In a subsequent article, we use this work to verify Némethi’s conjecture about lattice homology.

## CONTENTS

1. Introduction	4
1.1. The knot surgery algebra	4
1.2. Surgery formulas as $\mathcal{K}$ -modules	5
1.3. Pairing theorems	6
1.4. Splicing knot complements	7
1.5. Dual knots	8
1.6. Examples	8
1.7. Arc-systems	9
1.8. General bordered manifolds with torus boundary	10
1.9. Acknowledgments	10
2. Hypercubes and Heegaard Floer homology	10
2.1. Background on Heegaard Floer homology	11
2.2. Hyperboxes of chain complexes	12
2.3. Compressing hyperboxes	13
2.4. Hypercubes of attaching curves	13
2.5. More hypercubes	14
3. $A_\infty$ -modules	16
3.1. Type- $A$ and type- $D$ modules	16
3.2. Bimodules	16
3.3. The Lipshitz–Ozsváth–Thurston box tensor product	17

---

IZ was partially supported by NSF grants DMS-1703685 and 2204375.

3.4.	Morphisms of modules and bimodules	17
3.5.	External tensor products	19
3.6.	Hypercubes as type- $D$ modules	24
4.	Homological perturbation theory	26
4.1.	$A_\infty$ -modules	26
4.2.	$DA$ -bimodules	27
4.3.	Hypercubes	28
4.4.	Hypercubes of $DA$ -bimodules	29
5.	Linear topological spaces	30
5.1.	Linear maps	31
5.2.	Filtrations and direct products	31
5.3.	Linear compactness	32
5.4.	Tensor products	32
5.5.	Associativity and commutativity relations	33
5.6.	Tree topologies	35
6.	The knot surgery algebra	38
6.1.	The algebras $\mathcal{K}$ and $\mathcal{L}$	38
6.2.	Topologies on $\mathcal{K}$ and $\mathcal{L}$	39
6.3.	Alexander modules	41
6.4.	Split Alexander modules	42
6.5.	External tensor products	42
6.6.	Box tensor products	45
6.7.	Finitely generated $\mathcal{K}$ -modules	46
7.	The link surgery formula	47
7.1.	Statement of the link surgery formula	47
7.2.	Gradings and algebraic reduction maps	48
7.3.	On the algebra of the link surgery formula	51
8.	Link surgery modules over $\mathcal{K}$ and $\mathcal{L}$	54
8.1.	The type- $D$ module for a solid torus	54
8.2.	The type- $A$ module for a solid torus	55
8.3.	The merge bimodule	56
8.4.	The type- $A$ identity bimodule	59
8.5.	The knot surgery formula over $\mathcal{K}$	59
8.6.	The link surgery formula over $\mathcal{L}$	61
9.	$\sigma$ -basic systems of Heegaard diagrams	62
9.1.	Systems of arcs	62
9.2.	$\sigma$ -basic systems of Heegaard diagrams	63
9.3.	Meridional $\sigma$ -basic systems	64
9.4.	Basic systems for general systems of arcs	65
9.5.	Tensor products of hypercubes of attaching curves	67
9.6.	Basic systems and connected sums	68
10.	Hypercubes and disjoint unions	69
10.1.	Small translate theorems	70
10.2.	Disconnected Heegaard surfaces	71
11.	Hypercubes and connected sums	75
11.1.	Cylindrical boundary degenerations	77

11.2.	The 0-dimensional case	78
11.3.	Connected sums and hypercubes	85
12.	The pairing theorem	91
12.1.	The statement	92
12.2.	Unpacking the statement	92
12.3.	Proof of the pairing theorem	93
13.	Arc systems and the link surgery formula	96
13.1.	Basepoint moving maps on hypercubes	97
13.2.	Basepoint actions on hypercubes	99
13.3.	Homology actions on hypercubes	101
13.4.	Free stabilization	106
13.5.	Algebraic relations and the diffeomorphism action	108
13.6.	Relating homology actions and basepoint actions	114
13.7.	Properties of the $U$ -action on link surgery complexes	116
14.	The alpha-beta transformer	118
14.1.	The bimodule	119
14.2.	Basepoint actions as $A_\infty$ -morphisms	119
14.3.	The transformer as a mapping cone bimodule	121
14.4.	Properties of the transformer bimodule	122
14.5.	Proof of Theorem 14.1	123
15.	The pair-of-pants bimodules	124
15.1.	The $W_r$ and $W_l$ bimodules	125
15.2.	Proof of Theorem 15.2	126
15.3.	Relation to the $AA$ -identity bimodule	127
16.	The link surgery complex of Hopf links	130
16.1.	Computation of the surgery complex	130
16.2.	The Hopf link complex as a type- $D$ module	138
16.3.	The $\alpha\beta$ -model of the Hopf link complex	139
17.	Minimal models for the Hopf link surgery complex	140
17.1.	$DA$ -perspectives on the Hopf link complex	140
17.2.	Minimal models for the Hopf link Floer complex	141
17.3.	Minimal models over $\mathcal{K}$	145
18.	Examples and basic properties	149
18.1.	Meridional Dehn twists	149
18.2.	The type- $D$ invariants of solid tori	153
18.3.	The surgery exact triangle	157
18.4.	Finite generation	158
	Appendix A. Splicing operations	162
A.1.	Splices and connected sums	162
A.2.	The Hopf link and changes of parametrization	163
	References	163

## 1. INTRODUCTION

In this paper, we define several algebraic objects associated to compact, oriented 3-manifolds with parametrized torus boundary, and prove a gluing formula. For the purposes of this paper, we use the following definition (compare [LOT18, Section 1.1]):

**Definition 1.1.** A *bordered manifold with torus boundary* consists of a compact and oriented manifold  $M$  such that  $\partial M \cong \mathbb{T}^2$  and  $M$  is equipped with a choice of oriented basis  $(\mu, \lambda)$  of  $H_1(\partial M)$ .

If  $M_1$  and  $M_2$  are two bordered manifolds with torus boundaries, a natural gluing operation is to glue  $\mu_1$  to  $\mu_2$  and glue  $\lambda_1$  to  $-\lambda_2$ . This is motivated by the following fact. Suppose that  $M_1$  and  $M_2$  are the complements of two oriented knots  $K_1$  and  $K_2$  in  $S^3$ , which are given integral framings  $\lambda_1$  and  $\lambda_2$ . Let  $\phi: \partial M_1 \rightarrow \partial M_2$  denote the orientation reversing diffeomorphism which sends  $\mu_1$  to  $\mu_2$  and  $\lambda_1$  to  $-\lambda_2$ . Then there is a diffeomorphism

$$M_1 \cup_{\phi} M_2 \cong S_{\lambda_1 + \lambda_2}^3(K_1 \# K_2).$$

This basic topological fact is reviewed in Appendix A.

The algebraic objects we define are reformulations of Manolescu and Ozsváth's link surgery formula [MO10], recast using the framework of type- $D$  and type- $A$  modules of Lipshitz, Ozsváth and Thurston [LOT18].

Using the above topological observation about surgeries on connected sums, our gluing formula amounts to a formula for the behavior of the link surgery formula under connected sums.

**1.1. The knot surgery algebra.** We begin by describing our associative algebra  $\mathcal{K}$ , which is an algebra over the idempotent ring  $\mathbf{I} = \mathbf{I}_0 \oplus \mathbf{I}_1$ . Here each  $\mathbf{I}_i$  is a copy of  $\mathbb{F} = \mathbb{Z}/2\mathbb{Z}$ . We define

$$\mathbf{I}_0 \cdot \mathcal{K} \cdot \mathbf{I}_0 = \mathbb{F}[\mathcal{U}, \mathcal{V}] \quad \text{and} \quad \mathbf{I}_1 \cdot \mathcal{K} \cdot \mathbf{I}_1 = \mathbb{F}[\mathcal{U}, \mathcal{V}, \mathcal{V}^{-1}],$$

where  $\mathbb{F}[\mathcal{U}, \mathcal{V}]$  denotes a polynomial ring in two variables and  $\mathbb{F}[\mathcal{U}, \mathcal{V}, \mathcal{V}^{-1}]$  is its localization at  $\mathcal{V}$ . We set  $\mathbf{I}_0 \cdot \mathcal{K} \cdot \mathbf{I}_1 = \{0\}$ . There are two special algebra elements  $\sigma, \tau \in \mathbf{I}_1 \cdot \mathcal{K} \cdot \mathbf{I}_0$ , and we define

$$\mathbf{I}_1 \cdot \mathcal{K} \cdot \mathbf{I}_0 = \mathbb{F}[\mathcal{U}, \mathcal{V}, \mathcal{V}^{-1}] \otimes \langle \sigma \rangle \oplus \mathbb{F}[\mathcal{U}, \mathcal{V}, \mathcal{V}^{-1}] \otimes \langle \tau \rangle$$

where  $\langle \sigma \rangle$  and  $\langle \tau \rangle$  denote copies of  $\mathbb{F}$ . The elements  $\sigma$  and  $\tau$  satisfy the relations

$$\sigma \mathcal{U} = \mathcal{U} \sigma \quad \text{and} \quad \sigma \mathcal{V} = \mathcal{V} \sigma$$

$$\tau \mathcal{U} = \mathcal{V}^{-1} \tau \quad \text{and} \quad \tau \mathcal{V} = \mathcal{U} \mathcal{V}^2 \tau.$$

The algebra  $\mathcal{K}$  is an associative algebra, i.e. we can think of it as an  $A_{\infty}$ -algebra which has vanishing actions  $\mu_j$  for  $j \neq 2$ . Although seemingly asymmetric between  $\mathcal{U}$  and  $\mathcal{V}$ , as well as between  $\sigma$  and  $\tau$ , the above algebra admits a more symmetrical description. See Remark 6.1.

**1.2. Surgery formulas as  $\mathcal{K}$ -modules.** Ozsváth and Szabó [OS08b] proved that if  $K \subseteq S^3$  is a knot, then the Heegaard Floer homology groups  $HF^-(S^3_\lambda(K))$  are computable from the knot Floer complex of  $K$  [OS04a] [Ras03]. If  $\lambda$  is an integral framing on  $K$ , their construction produced a mapping cone complex  $\mathbb{X}_\lambda(K)$ , which satisfied

$$H_*(\mathbb{X}_\lambda(K)) \cong \mathbf{HF}^-(S^3_\lambda(K)).$$

(The bold font denotes coefficients in the power series ring  $\mathbb{F}[[U]]$ ).

Manolescu and Ozsváth [MO10] extended this formula to links in  $S^3$ . They proved that if  $L \subseteq S^3$  is a link with integral framing  $\Lambda$ , then there is a complex  $\mathcal{C}_\Lambda(L)$ , defined using the link Floer homology of  $L$  [OS08a], such that

$$H_*(\mathcal{C}_\Lambda(L)) \cong \mathbf{HF}^-(S^3_\Lambda(L)).$$

In Section 8.5, we describe how to naturally interpret Ozsváth and Szabó’s mapping cone complex  $\mathbb{X}_\lambda(K)$  as both a right type- $D$  module  $\mathcal{X}_\lambda(K)^\mathcal{K}$  and a left type- $A$  module  ${}_\mathcal{K}\mathcal{X}_\lambda(K)$ .

In Section 8.6, we extend this interpretation to the link surgery formula. If  $\ell$  is a positive integer, we define the  $\ell$ -component *link algebra* to be

$$\mathcal{L}_\ell = \otimes_{\mathbb{F}}^\ell \mathcal{K} = \mathcal{K} \otimes_{\mathbb{F}} \cdots \otimes_{\mathbb{F}} \mathcal{K}.$$

To an  $\ell$ -component link  $L \subseteq S^3$ , we define in Section 8.6 a type- $D$  module

$$\mathcal{X}_\Lambda(L)^{\mathcal{L}_\ell}.$$

*Remark 1.2.* We think of the map  $v$  in Ozsváth and Szabó’s mapping cone formula as being encoded by the algebra element  $\sigma \in \mathcal{K}$ . The map  $h$  is encoded by the algebra element  $\tau \in \mathcal{K}$ .

The description of the link surgery formula given by Manolescu and Ozsváth is an infinite direct product of free modules over  $\mathbb{F}[[U_1, \dots, U_\ell]]$ . In particular, it is very large and sometimes challenging to do direct computations with. On the other hand, the type- $D$  module  $\mathcal{X}_\Lambda(L)^{\mathcal{L}_\ell}$  that we describe contains all of the algebraic information of the link surgery formula, but is always finite-dimensional over  $\mathbb{F}$ . For example, the complement of the 0-framed trefoil has the type- $D$  module shown in Figure 1.1.

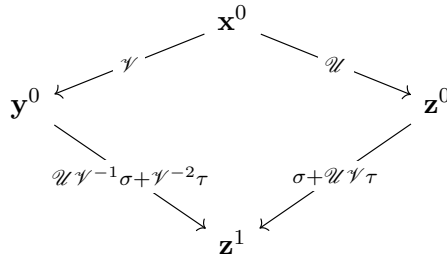

FIGURE 1.1. The type- $D$  module for the 0-framed trefoil complement. The superscript indicates the idempotent.

In our paper, the most fundamental object is the type- $D$  module  $\mathcal{X}_\Lambda(L)^{\mathcal{L}_\ell}$ . To change a type- $D$  algebra factor of  $\mathcal{K}$  to a type- $A$  algebra factor, we tensor with an algebraically defined “identity bimodule”

$$\mathcal{K} | \mathcal{K} [\mathbb{I}^\otimes].$$

Ignoring completions,  $\kappa|\mathcal{K}[\mathbb{I}^\ominus]$  is a type- $A$  module over  $\mathcal{K} \otimes_{\mathbb{F}} \mathcal{K}$ . (We write  $\mathcal{K}|\mathcal{K}$  instead of  $\mathcal{K} \otimes_{\mathbb{F}} \mathcal{K}$  to indicate a specific behavior with respect to completions, which we call the *split Alexander condition*).

The bimodule  $\kappa|\mathcal{K}[\mathbb{I}^\ominus]$  extends to a type- $AA$  bimodule  $\kappa|\mathcal{K}[\mathbb{I}^\ominus]_{\mathbb{F}[U]}$ , which is also useful to consider. Unlike the type- $D$  modules  $\mathcal{X}_\Lambda(L)^{\mathcal{L}^\ell}$ , which are all finitely generated over  $\mathbb{F}$ , the type- $A$  and  $DA$  bimodules in our theory are usually not finitely generated.

Manolescu and Ozsváth’s link surgery formula  $\mathcal{C}_\Lambda(L)$  is recovered by tensoring our type- $D$  module  $\mathcal{X}_\Lambda(L)^{\mathcal{L}^\ell}$  with  $\ell$ -copies of the 0-framed solid torus module, which we denote by  $\kappa[\mathcal{D}_0]_{\mathbb{F}[U]}$ . Here, a “0-framed solid torus” refers to the complement of a 0-framed unknot in  $S^3$ .

Algebraic completions (e.g. direct products and power series coefficients) interact with the algebra  $\mathcal{K}$  in subtle and interesting ways. The algebra  $\mathcal{K}$  has a natural filtration by right ideals

$$J_0 \supseteq J_1 \supseteq \cdots .$$

This filtration equips  $\mathcal{K}$  with a topology where the subspaces  $J_n$  form a basis of opens centered at 0. This equips  $\mathcal{K}$  with the structure of a *linear topological algebra*, which is important for our theory. In Section 6, we define algebraic categories of *Alexander modules*, which consist of linear topological vector spaces with appropriately continuous actions of  $\mathcal{K}$ . These are the categories where our link surgery modules live.

**1.3. Pairing theorems.** One of the central results of our paper is a connected sum formula for the Manolescu–Ozsváth integer surgery formula. Suppose  $L_1$  and  $L_2$  are two links in  $S^3$ , which have framings  $\Lambda_1$  and  $\Lambda_2$ , as well as distinguished components  $K_1 \subseteq L_1$  and  $K_2 \subseteq L_2$ . In Section 8.6, we describe how to compute  $\mathcal{C}_{\Lambda_1 + \Lambda_2}(L_1 \# L_2)$  in terms of  $\mathcal{C}_{\Lambda_1}(L_1)$  and  $\mathcal{C}_{\Lambda_2}(L_2)$ . Here,  $L_1 \# L_2$  denotes the connected sum of  $L_1$  and  $L_2$  along  $K_1$  and  $K_2$ , and  $\Lambda_1 + \Lambda_2$  denotes the framing where we sum the framings on  $K_1$  and  $K_2$  and leave the others unchanged. We will interpret this connected sum formula as an  $A_\infty$  tensor product over the algebra  $\mathcal{K}$ . We use the algebraic formalism of Lipshitz, Ozsváth and Thurston [LOT18] [LOT15] [LOT20], though our proof of the pairing theorem is independent of their proof in the standard bordered setting [LOT18].

Our formula is simplest to state when we are working with knots:

**Theorem 1.3.** *Suppose that  $(Y_1, K_1)$  and  $(Y_2, K_2)$  are two knots in integer homology 3-spheres with integral framings  $\lambda_1$  and  $\lambda_2$ . Then*

$$\mathbb{X}_{\lambda_1 + \lambda_2}(Y_1 \# Y_2, K_1 \# K_2) \simeq \mathcal{X}_{\lambda_1}(Y_1, K_1)^{\mathcal{K}} \hat{\boxtimes}_{\mathcal{K}} \mathcal{X}_{\lambda_2}(Y_2, K_2).$$

Here,  $\hat{\boxtimes}$  denotes a completed version of Lipshitz, Ozsváth and Thurston’s box tensor product [LOT18]. There is also a version of the above theorem for links:

**Theorem 1.4.** *Suppose that  $L_1$  and  $L_2$  are two links in  $S^3$  with integral framings  $\Lambda_1$  and  $\Lambda_2$ , and that we have two distinguished components  $K_1 \subseteq L_1$  and  $K_2 \subseteq L_2$ . Then*

$$\mathcal{C}_{\Lambda_1 + \Lambda_2}(L_1 \# L_2) \simeq \mathcal{X}_{\Lambda_1}(L_1)^{\mathcal{K}} \hat{\boxtimes}_{\mathcal{K}} \mathcal{X}_{\Lambda_2}(L_2).$$

In Section 8.6 we describe several more general versions of the pairing theorem. One version allows us to compute

$$\mathcal{X}_{\Lambda_1 + \Lambda_2}(L_1 \# L_2)^{\mathcal{L}^{\ell_1 + \ell_2 - 1}} \hat{\boxtimes}_{\mathcal{K}} \kappa[\mathcal{D}_0]_{\mathbb{F}[U]}. \tag{1.1}$$

In the above,  $\mathcal{D}_0$  denotes the module for the 0-framed solid torus, and the  $\mathcal{K}$ -action on  $\mathcal{D}_0$  is tensored with the  $\mathcal{K}$ -factor of  $\mathcal{L}_{\ell_1+\ell_2-1}$  corresponding to  $K_1\#K_2$ . The reader should think of tensoring  $\mathcal{D}_0$  as corresponding to gluing in a solid torus  $K_1\#K_2$ .

We will show in Section 15.3 that the module in Equation (1.1) is homotopy equivalent to an appropriate tensor product of the three modules

$$\mathcal{X}_{\Lambda_1}(L_1)^{\mathcal{L}_{\ell_1}}, \quad \mathcal{X}_{\Lambda_2}(L_2)^{\mathcal{L}_{\ell_2}}, \quad \text{and} \quad \kappa|_{\mathcal{K}}[\mathbb{I}^{\ominus}]_{\mathbb{F}[U]}.$$

We think of tensoring with  $\kappa|_{\mathcal{K}}[\mathbb{I}^{\ominus}]_{\mathbb{F}[U]}$  as corresponding to gluing torus boundary components together.

In some sense, the tensor product formulas above use up the two actions of  $\mathcal{K}$ , and hence are not convenient for taking connected sums of more than two links along a single component. To take the connected sum of more than two components, we define *pair-of-pants* bimodules

$$\kappa|_{\mathcal{K}}W_r^{\mathcal{K}} \quad \text{and} \quad \kappa|_{\mathcal{K}}W_l^{\mathcal{K}}$$

in Section 15, which can be used to compute the type- $D$  module over  $\mathcal{K}$  after taking the connected sum of link components. There are two models due to asymmetries in the construction of the link surgery formula. In a future work [Zem], we will relate these bimodules to a surgery description of the 3-manifold  $P \times S^1$ , where  $P$  is a pair-of-pants (i.e. a twice punctured disk).

*Remark 1.5.* The above pairing theorems give formulas for gluing two bordered manifolds along torus boundary components. Another important operation is to glue two boundary components of a single bordered 3-manifold together (i.e. self-gluing). Our pairing theorems do not cover this. We will investigate this in a future work.

**1.4. Splicing knot complements.** A basic topological operation is to glue the complements of two knots together using an orientation reversing diffeomorphism of their boundaries. 3-manifolds obtained in this manner are referred to as *splices*. Dehn surgery is a special case of splicing.

Splicing in the context of Heegaard Floer homology has been studied by many authors. See [Eft15] [HL16] [Han17] [KLT21] for some examples. Using bordered Heegaard Floer homology [LOT18], it is possible to compute  $\widehat{HF}$  of spliced manifolds. Despite the interest in splicing, there is to date no general description of  $HF^-$  of splices.

In this paper, we give a description of  $HF^-$  of splices in terms of knot Floer homology. If  $\phi: \mathbb{T}^2 \rightarrow \mathbb{T}^2$  is an orientation preserving diffeomorphism, then we will describe a bimodule  $\kappa[\phi]^{\mathcal{K}}$ . We think of this bimodule as the bordered invariant for  $[0, 1] \times \mathbb{T}^2$  with basis  $(\mu, -\lambda)$  on  $\{0\} \times \mathbb{T}^2$  (where we write  $\mu$  and  $\lambda$  for a standard basis of  $H_1(\mathbb{T}^2)$ ), and  $(\phi(\mu), \phi(\lambda))$  on  $\{1\} \times \mathbb{T}^2$ .

**Theorem 1.6.** *Let  $K_1$  and  $K_2$  be knots in  $S^3$  and let  $M_1$  and  $M_2$  be their complements. Let  $\phi: \partial M_1 \rightarrow -\partial M_2$  be an orientation preserving diffeomorphism. Then*

$$\mathbf{CF}^-(M_1 \cup_{\phi} M_2)_{\mathbb{F}[U]} \simeq \mathcal{X}_{\lambda_1}(K_1)^{\mathcal{K}} \hat{\boxtimes} \kappa[\phi]^{\mathcal{K}} \hat{\boxtimes} \kappa\mathcal{X}_{\lambda_2}(K_2)_{\mathbb{F}[U]}.$$

The bimodule  $\kappa[\phi]^{\mathcal{K}}$  is constructed by factoring the diffeomorphism  $\phi$  into the following generators of  $\text{MCG}(\mathbb{T}^2)$ :

- (1)  $\phi(\mu) = \mu$  and  $\phi(\lambda) = \lambda \pm \mu$ .
- (2)  $\phi(\mu) = \pm\lambda$  and  $\phi(\lambda) = \mp\mu$ .

In both of the above cases, the bimodule  $\kappa[\phi]^\mathcal{K}$  is obtained from the surgery complex for the Hopf link. We obtain small models using the homological perturbation lemma. We remark that the Hopf link has complement  $[0, 1] \times \mathbb{T}^2$ , so taking a connected sum with the Hopf link and then surgering on the original knot has the effect of changing the boundary parametrization.

In general, we do not yet have a closed formula for the bimodule  $\kappa[\phi]^\mathcal{K}$  for an arbitrary diffeomorphism  $\phi$ , nor do our techniques imply independence of the bimodule  $\kappa[\phi]^\mathcal{K}$  from the above presentation. We plan to address both of these questions in a future work.

*Remark 1.7.* When  $K_1$  and  $K_2$  are knots in  $S^3$ , the modules  $\mathcal{X}_{\lambda_1}(K_1)^\mathcal{K}$  and  $\kappa\mathcal{X}_{\lambda_2}(K_2)_{\mathbb{F}[[U]]}$  are determined by the full knot Floer complexes  $CFK^\infty(K_1)$  and  $CFK^\infty(K_2)$ , up to homotopy equivalence.

**1.5. Dual knots.** As a special case, our techniques recover the dual knot formula of Eftekhary [Eft06] and Hedden–Levine [HL19] by taking a connected sum with the Hopf link. We recall that they computed the knot Floer complex of the dual knot  $\mu \subseteq S_\lambda^3(K)$  in terms of the knot Floer homology  $CFK^\infty(K)$ . Note that the dual knot  $\mu \subseteq S_\lambda^3(K)$  may be obtained by taking the connected sum of  $K$  with a Hopf link, and then performing  $\lambda$ -framed surgery on  $K$ .

In our present paper case, taking the connected sum of  $K$  with a Hopf link and performing  $\lambda$ -framed surgery corresponds to taking the tensor product of  $\mathcal{X}_\lambda(K)^\mathcal{K}$  with the Hopf link surgery complex, viewed as a  $DA$ -bimodule  $\kappa\mathcal{H}_\Lambda^\mathcal{K}$ . Using homological perturbation theory we describe a smaller model, which we denote by  $\kappa\mathcal{Z}_\Lambda^\mathcal{K}$ . Taking the box tensor product with this minimal model and then restricting to idempotent  $\mathbf{I}_0$  recovers the model of Eftekhary and Hedden–Levine (modulo differing notational conventions).

Our analysis of the Hopf link complex builds off of joint work of the author with Hendricks, Hom and Stoffregen in [HHSZ22], where an extension of the dual knot formula is proven for Hendricks and Manolescu’s involutive knot Floer homology [HM17].

**1.6. Examples.** We compute many basic examples in this paper. The most fundamental is the type- $D$  module for the Hopf link. We compute this in Section 16, and compute a minimal model of the corresponding  $DA$ -bimodule in Section 17. This example is important for applications and computations. Combined with the tensor product formulas, it also gives a computation of the Heegaard Floer homology of all 3-manifolds obtained as the boundary of a plumbing of disk bundles over  $S^2$ , plumbed along a tree. This is explored further in [Zem21], wherein the equivalence of Heegaard Floer homology and the lattice homology of Némethi [Ném05] [Ném08] is proven.

In Section 18.2 we describe the type- $D$  modules of rationally framed solid tori  $\mathcal{D}_{p/q}^\mathcal{K}$  for  $p/q \in \mathbb{Q} \cup \{\infty\}$ . The type- $D$  modules  $\mathcal{D}_{p/q}^\mathcal{K}$  can be viewed as naturally recovering the rational surgeries complex  $\mathbb{X}_{p/q}(K)$  of Ozsváth and Szabó [OS11] in the sense that

$$\mathbb{X}_{p/q}(K) \cong \mathcal{D}_{p/q}^\mathcal{K} \hat{\boxtimes} \kappa\mathcal{X}_0(K)$$

for any knot  $K$  in  $S^3$ .

As another example, we show that there is a homotopy equivalence of type- $D$  modules

$$\mathcal{D}_\infty^\mathcal{K} \simeq \text{Cone}(f^1: \mathcal{D}_n^\mathcal{K} \rightarrow \mathcal{D}_{n+1}^\mathcal{K}),$$



for some type- $D$  morphism  $f^1$ . Tensoring with this homotopy equivalence recovers the surgery exact triangle in Heegaard Floer homology. This example is reminiscent of the original setting of bordered Heegaard Floer homology [LOT18, Section 11.2]

**1.7. Arc-systems.** We also prove several important technical results about the link surgery formula of Manolescu and Ozsváth [MO10]. We recall that the link surgery formula requires, for each knot component  $K_i \subseteq L$ , a choice of embedded arc  $\lambda_i \subseteq S^3$  which connects two basepoints on  $K_i$ . We furthermore require the arcs to be pairwise disjoint and to be disjoint from  $L$  except at their endpoints. We call any such collection  $\mathcal{A}$  a *system of arcs*.

To a system of arcs, Manolescu and Ozsváth's construction produces a chain complex  $\mathcal{C}_\Lambda(L, \mathcal{A})$ . In our present setting, the system of arcs  $\mathcal{A}$  can be viewed as being a piece of auxiliary data in the construction of the complex  $\mathcal{C}_\Lambda(L, \mathcal{A})$  and the type- $D$  module  $\mathcal{X}_\Lambda(L, \mathcal{A})^{\mathcal{L}}$ . Manolescu and Ozsváth focus on the case that the arcs  $\mathcal{A}$  are isotopic to subarcs of  $L$ . We say that such arcs are *alpha* or *beta-parallel* (depending on their orientation relative to that of  $L$ ).

Manolescu and Ozsváth's result may be interpreted as showing if each arc of  $\mathcal{A}$  is alpha-parallel or beta-parallel, then

$$\mathbf{HF}^-(S_\Lambda^3(L)) \cong H_*(\mathcal{C}_\Lambda(L, \mathcal{A}))$$

as modules over  $\mathbb{F}[[U]]$ . It does not immediately follow from their work that  $H_*(\mathcal{C}_\Lambda(L, \mathcal{A}))$  is independent of the choice of arcs.

In our work, we will show that any such system of arcs may be used to compute the link surgery formula, though the dependence on arcs is somewhat subtle:

**Theorem 1.8.** *If  $\mathcal{A}$  is any system of arcs for  $L$ , then there is relatively graded isomorphism of vector spaces*

$$\mathbf{HF}^-(S_\Lambda^3(L)) \cong H_*(\mathcal{C}_\Lambda(L, \mathcal{A})).$$

*If the arc  $\lambda_i \in \mathcal{A}$  is either alpha or beta-parallel, then the isomorphism is of  $\mathbb{F}[[U]]$ -modules, where  $U$  acts by  $U_i$  on  $H_*(\mathcal{C}_\Lambda(L, \mathcal{A}))$ .*

The isomorphism between the link surgery complexes for different systems of arcs is somewhat subtle. For example, we will construct two systems of arcs  $\mathcal{A}_1$  and  $\mathcal{A}_2$  on the Hopf link  $H$  for which

$$\mathcal{X}_\Lambda(H, \mathcal{A}_1)^{\mathcal{L}_2} \not\cong \mathcal{X}_\Lambda(H, \mathcal{A}_2)^{\mathcal{L}_2} \tag{1.2}$$

as type- $D$  modules.

In Section 13, we will describe a general formula for the effect of changing the arcs in the link surgery formula. One important special case is when we want to change an arc from alpha-parallel to beta-parallel, or vice versa. This may be achieved by tensoring with a rank 1  $DA$ -bimodule  ${}_{\mathcal{K}}\mathcal{T}^{\mathcal{K}}$ . In Section 14 we study this bimodule. It is algebraically related to the basepoint moving map investigated by Sarkar [Sar15] and later by the author [Zem17].

Another instance where we use our description of the effect of changing arcs is when constructing the pair-of-pants bimodules in Section 15.

**1.8. General bordered manifolds with torus boundary.** The connected sum formula of Theorem 1.4 and the topological interpretation of surgeries on connected sums in terms of gluing torus boundary components motivate a definition of a potential invariant of bordered 3-manifold with torus boundary components.

We suppose that  $M$  is a bordered 3-manifold with  $n$  toroidal boundary components. We may describe  $M$  as surgery on a link  $L$ , in the complement of an unlink  $\mathbb{U}_n$  in  $S^3$ , in a way which is compatible with the parametrization of  $\partial M$ .

We may define a type- $D$  module  $\mathcal{X}(M)^{\mathcal{L}_n}$  as follows. We begin with the link surgery formula for  $L \cup \mathbb{U}_n$ , interpreted as a type- $D$  module over our algebra  $\mathcal{L}_{n+\ell}$ , where  $\ell = |L|$ . We write  $\mathcal{X}_\Lambda(L \cup \mathbb{U}_n)^{\mathcal{L}_{n+\ell}}$  for this module. We define  $\mathcal{X}(M)^{\mathcal{L}_n}$  by tensoring the module  $\mathcal{X}_\Lambda(L \cup \mathbb{U}_n)^{\mathcal{L}_{n+\ell}}$  with  $\ell$  type- $A$  modules for 0-framed solid tori. This corresponds topologically to performing Dehn surgery on the components  $L$ , while identifying the components of  $\partial\nu(\mathbb{U}_n)$  with  $\partial M$ . Theorem 1.4 may be interpreted as a pairing theorem for gluing two bordered 3-manifolds with torus boundary components together. We prove in Section 18.4 that the modules  $\mathcal{X}(M)^{\mathcal{L}_n}$ , as defined above, are always homotopy equivalent to finitely generated type- $D$  modules, i.e., the underlying vector space  $\mathcal{X}(M)$  may be taken to be finite-dimensional over  $\mathbb{F}$ .

In a future work, we hope to understand in what sense  $\mathcal{X}(M)^{\mathcal{L}_n}$ , defined as above, is an invariant of the bordered manifold  $M$ . We note that, in light of Equation (1.2), the modules will in general depend on the choice of system of arcs  $\mathcal{A}$  in  $S^3$ . We make the following conjecture:

**Conjecture 1.9.** *If  $M$  is a bordered manifold with toroidal boundary components which is equipped with a system of arcs  $\mathcal{A} \subseteq M$ , then the type- $D$  module  $\mathcal{X}(M, \mathcal{A})^{\mathcal{L}}$  is an invariant of  $(M, \mathcal{A})$  up to homotopy equivalence.*

We plan to address the above conjecture in a future work.

*Remark 1.10.* Our bordered modules  $\mathcal{X}(M)^{\mathcal{K}}$  give useful surgery formulas for homologically essential knots in 3-manifolds with  $b_1 > 0$ . This is a setting where the techniques of Ozsváth and Szabó [OS08b] do not have a seemingly simple adaptation. As a concrete example, the  $\infty$ -framed solid torus may be viewed as the knot complement of a fiber in  $S^1 \times \{pt\} \subseteq S^1 \times S^2$ . We compute in Section 18.2 the associated type- $D$  module, which is concentrated in idempotent 1 and has two generators, and has  $\delta^1$  encoded by the diagram

$$\mathbf{x}^1 \text{ --- } 1+\nu \text{ --- } \mathbf{y}^1.$$

**1.9. Acknowledgments.** The author would like to thank A. Alfieri, R. Lipshitz, C. Manolescu, and P. Ozsváth for helpful conversations. The author would like to thank K. Hendricks, J. Hom and M. Stoffregen for helpful conversations and the collaboration [HHSZ22], where some of the results on the hypercube homological perturbation lemma and the minimal model of the Hopf link complex were discovered. The author would also like to thank collaborators M. Borodzik and B. Liu for interesting discussions and helpful insights on related work.

## 2. HYPERCUBES AND HEEGAARD FLOER HOMOLOGY

In this section, we describe some background on Heegaard Floer homology and also some algebraic background on hypercubes.

**2.1. Background on Heegaard Floer homology.** We will assume that the reader is familiar with the basics of Heegaard Floer homology [OS04b], as well as its refinements for knots [OS04a] [Ras03] and links [OS08a]. We provide a brief review to establish notation.

**Definition 2.1** ([OS08a, Definition 3.1]).

(1) A *multi-pointed Heegaard diagram* consists of a tuple

$$(\Sigma, \boldsymbol{\alpha} = \{\alpha_1, \dots, \alpha_{g+n-1}\}, \boldsymbol{\beta} = \{\beta_1, \dots, \beta_{g+n-1}\}, \mathbf{w} = \{w_1, \dots, w_n\})$$

such that  $n \geq 1$  and  $\boldsymbol{\alpha}$  (resp.  $\boldsymbol{\beta}$ ) are pairwise disjoint, simple closed curves on  $\Sigma$  which are linearly independent in  $H_1(\Sigma \setminus \mathbf{w})$ . In particular,  $\Sigma \setminus \boldsymbol{\alpha}$  consists of  $n$  components, each of which contains a single basepoint  $w_i \in \mathbf{w}$ , and similarly for  $\Sigma \setminus \boldsymbol{\beta}$ .

(2) A *Heegaard link diagram with free basepoints* consists of a tuple

$$(\Sigma, \boldsymbol{\alpha} = \{\alpha_1, \dots, \alpha_{g+n-1}\}, \boldsymbol{\beta} = \{\beta_1, \dots, \beta_{g+n-1}\}, \mathbf{w} = \{w_1, \dots, w_m\}, \mathbf{z} = \{z_1, \dots, z_j\}),$$

satisfying the following. We assume that  $\boldsymbol{\alpha}$  and  $\boldsymbol{\beta}$  each span a  $g$ -dimensional subspace of  $H_1(\Sigma)$ . Furthermore, each component of  $\Sigma \setminus \boldsymbol{\alpha}$  (resp.  $\Sigma \setminus \boldsymbol{\beta}$ ) contains either a single basepoint of  $\mathbf{w} \cup \mathbf{z}$ , or contains one basepoint from  $\mathbf{w}$  and one basepoint from  $\mathbf{z}$ . Furthermore, if  $p \in \mathbf{w} \cup \mathbf{z}$ , then  $p$  is the sole basepoint in a component of  $\Sigma \setminus \boldsymbol{\alpha}$ , if and only if  $p$  is also the sole basepoint of a component of  $\Sigma \setminus \boldsymbol{\beta}$ . We call such a basepoint a *free basepoint*. We refer to the other basepoints as *link basepoints*.

*Remark 2.2.* Usually we assume all free basepoints are in  $\mathbf{w}$ , for notational simplicity. Also, sometimes it will be convenient to write  $(\Sigma, \boldsymbol{\alpha}, \boldsymbol{\beta}, \mathbf{w}, \mathbf{z}, \mathbf{f})$  for a Heegaard link diagram with free basepoints, where  $\mathbf{w}$  and  $\mathbf{z}$  are the link basepoints, and  $\mathbf{f}$  are the free basepoints.

The curves  $\boldsymbol{\alpha}, \boldsymbol{\beta} \subseteq \Sigma$  determine two handlebodies,  $U_\alpha$  and  $U_\beta$ , with boundary  $\Sigma$ . A Heegaard link diagram with free basepoints determines a 3-manifold  $Y$  and an oriented link  $L \subseteq Y$ . In  $U_\alpha$  we assume that the link  $L$  is a push-off of a collection of smoothly embedded, pairwise disjoint arcs in  $\Sigma \setminus \boldsymbol{\alpha}$  which connect the link-basepoints of  $\mathbf{w}$  to the link-basepoints of  $\mathbf{z}$ . In  $U_\beta$ , we assume  $L$  is a push off of a collection of smoothly embedded, pairwise disjoint arcs which connect the link-basepoints of  $\mathbf{z}$  to the link-basepoints of  $\mathbf{w}$ . We follow the orientation convention that  $L$  intersects  $\Sigma$  positively at  $\mathbf{z}$  and negatively at  $\mathbf{w}$ .

If  $\mathcal{H} = (\Sigma, \boldsymbol{\alpha}, \boldsymbol{\beta}, \mathbf{w})$  is a multi-pointed Heegaard diagram for  $Y$  and  $\mathfrak{s} \in \text{Spin}^c(Y)$ , we define  $CF^-(\mathcal{H}, \mathfrak{s})$  to be the free  $\mathbb{F}[U_1, \dots, U_n]$ -module generated by intersection points  $\mathbf{x}$  of the Lagrangian tori

$$\mathbb{T}_\alpha = \alpha_1 \times \dots \times \alpha_{g+n-1} \quad \text{and} \quad \mathbb{T}_\beta = \beta_1 \times \dots \times \beta_{g+n-1}$$

in the symmetric product  $\text{Sym}^{g+n-1}(\Sigma)$ , such that  $\mathfrak{s}_\mathbf{w}(\mathbf{x}) = \mathfrak{s}$ . See [OS04b, Section 2.6] for the definition of the map  $\mathfrak{s}_\mathbf{w}: \mathbb{T}_\alpha \cap \mathbb{T}_\beta \rightarrow \text{Spin}^c(Y)$ .

The differential counts pseudo-holomorphic representatives of Maslov index 1 flow-lines in  $\text{Sym}^{g+n-1}(\Sigma)$  via the formula

$$\partial(\mathbf{x}) = \sum_{\substack{\phi \in \pi_2(\mathbf{x}, \mathbf{y}) \\ \mu(\phi)=1}} \#(\mathcal{M}(\phi)/\mathbb{R}) U_1^{n_{w_1}(\phi)} \dots U_n^{n_{w_n}(\phi)} \cdot \mathbf{y}, \quad (2.1)$$

extended equivariantly over  $\mathbb{F}[U_1, \dots, U_n]$ .

We will frequently make use of Lipshitz's *cylindrical reformulation* of Heegaard Floer homology [Lip06]. In this formulation, the differential counts holomorphic curves of potentially higher genus in  $\Sigma \times [0, 1] \times \mathbb{R}$ . We refer the reader to [Lip06] for additional background.

**Definition 2.3** ([OS04b]). A *periodic domain* on  $\mathcal{H} = (\Sigma, \boldsymbol{\alpha}, \boldsymbol{\beta}, \mathbf{w})$  is a 2-chain  $P$  on  $\Sigma$  such that  $\partial P$  is an integral linear combination of  $\boldsymbol{\alpha}$  and  $\boldsymbol{\beta}$  and  $n_{\mathbf{w}}(P) = 0$ . A diagram  $\mathcal{H}$  is *weakly admissible* if each non-trivial periodic domain has both positive and negative multiplicities. If  $\mathcal{H} = (\Sigma, \boldsymbol{\alpha}, \boldsymbol{\beta}, \mathbf{w}, \mathbf{z}, \mathbf{f})$  is a Heegaard link diagram, where  $\mathbf{f}$  denote the free basepoints on the diagram, we say that  $\mathcal{H}$  is weakly admissible if  $(\Sigma, \boldsymbol{\alpha}, \boldsymbol{\beta}, \mathbf{w} \cup \mathbf{f})$  is weakly admissible.

Given a weakly admissible Heegaard diagram  $\mathcal{H}$ , we can define a completed version of Heegaard Floer homology  $\mathbf{CF}^-(\mathcal{H})$ , which is freely generated by  $\mathbf{x} \in \mathbb{T}_{\boldsymbol{\alpha}} \cap \mathbb{T}_{\boldsymbol{\beta}}$  (with no restriction on  $\text{Spin}^c$  structures) over the ring  $\mathbb{F}[[U_1, \dots, U_n]]$ .

We now discuss link Floer homology. In this paper, we use a slightly different version of link Floer homology than appeared in [OS08a]. Instead, we use a version which is a free, finitely generated chain complex over the ring  $\mathbb{F}[\mathcal{U}_1, \dots, \mathcal{U}_n, \mathcal{V}_1, \dots, \mathcal{V}_n]$ . This version was considered in [Zem17] and [Zem19b]. We define  $\mathcal{CFL}^-(\Sigma, \boldsymbol{\alpha}, \boldsymbol{\beta}, \mathbf{w}, \mathbf{z}, \mathbf{s})$  to be generated over  $\mathbb{F}[\mathcal{U}_1, \dots, \mathcal{U}_n, \mathcal{V}_1, \dots, \mathcal{V}_n]$  by intersection points  $\mathbf{x} \in \mathbb{T}_{\boldsymbol{\alpha}} \cap \mathbb{T}_{\boldsymbol{\beta}}$  such that  $\mathfrak{s}_{\mathbf{w}}(\mathbf{x}) = \mathbf{s}$ . The differential is similar to (2.1), except that we weight a holomorphic curve by

$$\prod_{i=1}^n \mathcal{U}_i^{n_{w_i}(\phi)} \mathcal{V}_i^{n_{z_i}(\phi)}.$$

In the case of a doubly pointed Heegaard knot diagram,  $\mathcal{H} = (\Sigma, \boldsymbol{\alpha}, \boldsymbol{\beta}, w, z)$ , we write  $\mathcal{CFK}^-(\mathcal{H}, \mathfrak{s})$  for the complex which is freely generated over  $\mathbb{F}[\mathcal{U}, \mathcal{V}]$  by intersection points  $\mathbf{x} \in \mathbb{T}_{\boldsymbol{\alpha}} \cap \mathbb{T}_{\boldsymbol{\beta}}$ .

*Remark 2.4.* To avoid cluttering the notation, we will usually write  $CF(Y)$  and  $\mathcal{CFK}(K)$  instead of  $CF^-(Y)$  or  $\mathcal{CFK}^-(K)$ .

**2.2. Hyperboxes of chain complexes.** We now describe Manolescu and Ozsváth's algebraic formalism of *hypercubes of chain complexes* [MO10, Section 5]. Define

$$\mathbb{E}_n := \{0, 1\}^n \subseteq \mathbb{R}^n,$$

with the convention that  $\mathbb{E}_0 = \{0\}$ . If  $\mathbf{d} = (d_1, \dots, d_n) \in \mathbb{Z}^{\geq 0}$ , we define

$$\mathbb{E}(\mathbf{d}) := \{(i_1, \dots, i_n) \in \mathbb{Z}^n : 0 \leq i_j \leq d_j, \forall j\}.$$

If  $\varepsilon, \varepsilon' \in \mathbb{E}(\mathbf{d})$ , we write  $\varepsilon \leq \varepsilon'$  if the inequality holds for each coordinate of  $\varepsilon$  and  $\varepsilon'$ . We write  $\varepsilon < \varepsilon'$  if  $\varepsilon \leq \varepsilon'$  and strict inequality holds at one or more coordinates.

**Definition 2.5.** An *n-dimensional hypercube of chain complexes*  $(C_{\varepsilon}, D_{\varepsilon, \varepsilon'})_{\varepsilon \in \mathbb{E}_n}$  consists of the following:

- (1) A group  $C_{\varepsilon}$  for each  $\varepsilon \in \mathbb{E}_n$ .
- (2) For each pair of indices  $\varepsilon, \varepsilon' \in \mathbb{E}_n$  such that  $\varepsilon \leq \varepsilon'$ , a linear map

$$D_{\varepsilon, \varepsilon'} : C_{\varepsilon} \rightarrow C_{\varepsilon'}.$$

Furthermore, we assume the following compatibility condition holds whenever  $\varepsilon \leq \varepsilon''$ :

$$\sum_{\substack{\varepsilon' \in \mathbb{E}_n \\ \varepsilon \leq \varepsilon' \leq \varepsilon''}} D_{\varepsilon', \varepsilon''} \circ D_{\varepsilon, \varepsilon'} = 0. \quad (2.2)$$

**Definition 2.6.** If  $\mathbf{d} \in (\mathbb{Z}^{>0})^n$ , a *hyperbox of chain complexes of size  $\mathbf{d}$*  consists of a collection of groups  $(C_\varepsilon)_{\varepsilon \in \mathbb{E}(\mathbf{d})}$ , together with a linear map  $D_{\varepsilon, \varepsilon'}$  whenever  $\varepsilon \leq \varepsilon'$  and  $|\varepsilon' - \varepsilon|_{L^\infty} \leq 1$ . Furthermore, we assume that the analog of (2.2) holds whenever  $\varepsilon \leq \varepsilon''$  and  $|\varepsilon'' - \varepsilon|_{L^\infty} \leq 1$ .

*Remark 2.7.* In Section 3.6 we will give an alternate perspective on hypercubes, and show that the category of hypercubes of chain complexes is equivalent to the category of type- $D$  modules over a certain algebra.

**2.3. Compressing hyperboxes.** Manolescu and Ozsváth [MO10, Section 5] describe an operation called *compression* which takes a hyperbox  $\mathcal{C} = (C_\varepsilon, D_{\varepsilon, \varepsilon'})_{\varepsilon \in \mathbb{E}(\mathbf{d})}$  of size  $\mathbf{d} = (d_1, \dots, d_n)$  and returns an  $n$ -dimensional hypercube  $\widehat{\mathcal{C}} = (\widehat{C}_\varepsilon, \widehat{D}_{\varepsilon, \varepsilon'})_{\varepsilon \in \mathbb{E}_n}$ . The underlying complexes are given by the formula

$$\widehat{C}_{(\varepsilon_1, \dots, \varepsilon_n)} = C_{(d_1 \varepsilon_1, \dots, d_n \varepsilon_n)}.$$

The hypercube structure maps are more complicated. We first illustrate the construction in the 1-dimensional case. Suppose  $\mathcal{C}$  is the 1-dimensional hyperbox of chain complexes

$$C_0 \xrightarrow{f_{0,1}} C_1 \xrightarrow{f_{1,2}} \dots \xrightarrow{f_{n-1,n}} C_n.$$

The compression of the above hyperbox is the hypercube

$$C_0 \xrightarrow{f_{n-1,n} \circ \dots \circ f_{0,1}} C_n.$$

The same description also works for hyperboxes of size  $(1, \dots, 1, d)$ . That is, we view  $\mathcal{C}$  as a 1-dimensional hyperbox where the complex at each point of  $\mathbb{E}(d)$  is a hypercube of dimension  $n - 1$ . Compression in this case is given by function composition.

For a hyperbox  $C$  of size  $(d_1, \dots, d_n)$ , the compression may be defined by iterating the above construction. Doing so requires a choice of ordering of the axis directions. As a first step, view  $C$  as a collection of  $d_1 \cdots d_{n-1}$  hyperboxes of size  $(1, \dots, 1, d_n)$ . We compress each of these hyperboxes using the function-composition description above. Stacking these hyperboxes results in a hyperbox of size  $(d_1, \dots, d_{n-1}, 1)$ . We view this as a collection of  $d_1 \cdots d_{n-2}$  hypercubes of size  $(1, \dots, 1, d_{n-1}, 1)$ , which we compress using the function-composition description. Stacking the resulting hyperboxes gives a hyperbox of size  $(d_1, \dots, d_{n-2}, 1, 1)$ . Repeating this procedure gives the compression of  $C$ . It is possible to relate this description to the description in terms of the algebra of songs in [MO10], cf. [Liu14, Section 4.1.2]. Additionally, in Section 3.6 we give an alternate description of compression in terms of box-tensor products of  $DA$ -bimodules over a certain algebra.

**2.4. Hypercubes of attaching curves.** The notion of a hypercube of chain complexes adapts to other categories. We now describe the appropriate notion of a hypercube in the Fukaya category. See [MO10, Section 8] and [LOT14, Section 3], where such objects are referred to as *hyperboxes of Heegaard diagrams*, and *chain complexes of attaching curves*, respectively.

**Definition 2.8.** A hypercube of handleslide equivalent beta attaching curves  $\mathcal{L}_\beta = (\beta_\varepsilon, \Theta_{\varepsilon, \varepsilon'})_{\varepsilon \in \mathbb{E}_n}$  on  $(\Sigma, \mathbf{w})$  consists of a collection of beta attaching curves  $\beta_\varepsilon$ , which are each pairwise related by a sequence of handleslides and isotopies, together with distinguished morphisms  $\Theta_{\varepsilon, \varepsilon'} \in \mathbf{CF}(\Sigma, \beta_\varepsilon, \beta_{\varepsilon'}, \mathbf{w})$  whenever  $\varepsilon < \varepsilon'$ . We assume furthermore that the Heegaard  $2^n$ -tuple containing all beta curves is weakly admissible. Finally, we assume that for each pair  $\varepsilon < \varepsilon' \in \mathbb{E}_n$ , the following relation is satisfied:

$$\sum_{\varepsilon=\varepsilon_1 < \dots < \varepsilon_n = \varepsilon'} f_{\beta_{\varepsilon_1}, \dots, \beta_{\varepsilon_n}}(\Theta_{\varepsilon_1, \varepsilon_2}, \dots, \Theta_{\varepsilon_{n-1}, \varepsilon_n}) = 0. \quad (2.3)$$

In the above,  $f_{\beta_{\varepsilon_1}, \dots, \beta_{\varepsilon_n}}$  denotes the holomorphic polygon counting map.

A hypercube of handleslide equivalent *alpha* attaching curves is similar: For each  $\varepsilon < \varepsilon'$  we have a chain  $\Theta_{\varepsilon', \varepsilon} \in \mathbf{CF}(\Sigma, \alpha_{\varepsilon'}, \alpha_\varepsilon, \mathbf{w})$ , and the compatibility condition in Equation (2.3) holds, as long as we write the indices in the opposite order.

If  $\mathcal{L}_\alpha$  and  $\mathcal{L}_\beta$  are hypercubes of handleslide equivalent attaching curves on  $(\Sigma, \mathbf{w})$ , of dimension  $m$  and  $n$  respectively, then there is an  $(n + m)$ -dimensional hypercube of chain complexes

$$(C_{(\varepsilon, \nu)}, D_{(\varepsilon, \nu), (\varepsilon', \nu')})_{(\varepsilon, \nu) \in \mathbb{E}_n \times \mathbb{E}_m} = \mathbf{CF}(\Sigma, \mathcal{L}_\alpha, \mathcal{L}_\beta, \mathbf{w}),$$

whenever the diagram containing all attaching curves is weakly admissible. For each  $(\varepsilon, \nu) \in \mathbb{E}_{n+m}$ , we set

$$C_{(\varepsilon, \nu)} = \mathbf{CF}(\Sigma, \alpha_\varepsilon, \beta_\nu, \mathbf{w}).$$

The structure maps are given by the following formula:

$$D_{(\varepsilon, \nu), (\varepsilon', \nu')}(\mathbf{x}) = \sum_{\substack{\varepsilon=\varepsilon_1 < \dots < \varepsilon_i = \varepsilon' \\ \nu=\nu_1 < \dots < \nu_j = \nu'}} f_{\alpha_{\varepsilon_i}, \dots, \alpha_{\varepsilon_1}, \beta_{\nu_1}, \dots, \beta_{\nu_j}}(\Theta_{\varepsilon_i, \varepsilon_{i-1}}, \dots, \Theta_{\varepsilon_2, \varepsilon_1}, \mathbf{x}, \Theta_{\nu_1, \nu_2}, \dots, \Theta_{\nu_{j-1}, \nu_j}). \quad (2.4)$$

It is straightforward to see that  $\mathbf{CF}(\Sigma, \mathcal{L}_\alpha, \mathcal{L}_\beta, \mathbf{w})$  is a hypercube of chain complexes.

The case when there are both  $\mathbf{w}$  and  $\mathbf{z}$  basepoints is a straightforward modification of the above construction.

**2.5. More hypercubes.** We now collect several additional constructions and basic properties. Firstly, if  $\mathcal{C} = (C_\varepsilon, D_{\varepsilon, \varepsilon'})_{\varepsilon \in \mathbb{E}_n}$  and  $\mathcal{C}' = (C'_\nu, D'_{\nu, \nu'})_{\nu \in \mathbb{E}_m}$  are two hypercubes of chain complexes over a ring  $R$ , we may define their *external tensor product*

$$\mathcal{E} := \mathcal{C} \otimes_R \mathcal{C}',$$

as follows. The hypercube  $\mathcal{E} = (E_{(\varepsilon, \nu)}, \delta_{(\varepsilon, \nu), (\varepsilon', \nu')})_{(\varepsilon, \nu) \in \mathbb{E}_n \times \mathbb{E}_m}$  is the tensor product in the ordinary sense: As groups, we set

$$E_{(\varepsilon, \nu)} = C_\varepsilon \otimes_R C'_\nu$$

and the structure maps are given by

$$\delta_{(\varepsilon, \nu), (\varepsilon', \nu')} = \begin{cases} D_{\varepsilon, \varepsilon'} \otimes \text{id} & \text{if } \nu = \nu' \\ \text{id} \otimes D'_{\nu, \nu'} & \text{if } \varepsilon = \varepsilon' \\ 0 & \text{if } \varepsilon < \varepsilon' \text{ and } \nu < \nu'. \end{cases}$$

Additionally, if  $\mathcal{C}$  and  $\mathcal{C}'$  are two hyperboxes of size  $\mathbf{d}_0 \times \{d\}$  and  $\mathbf{d}_0 \times \{d'\}$ , such that the restrictions  $\mathcal{C}|_{\mathbb{E}(\mathbf{d}_0) \times \{d\}}$  and  $\mathcal{C}'|_{\mathbb{E}(\mathbf{d}_0) \times \{0\}}$  coincide (in both underlying groups and structure morphisms), then we may stack  $\mathcal{C}$  and  $\mathcal{C}'$  to obtain a hyperbox of size

$\mathbf{d}_0 \times \{d+d'\}$ , which we denote  $\text{St}(\mathcal{C}, \mathcal{C}')$ . The following lemma records some interactions between stacking and the external tensor product.

**Lemma 2.9.**

- (1) *Stacking hyperboxes of attaching curves commutes with pairing: If  $\mathcal{L}_\alpha$ ,  $\mathcal{L}_\beta$  and  $\mathcal{L}_{\beta'}$  are hyperboxes of attaching curves, and  $\mathcal{L}_\beta$  and  $\mathcal{L}_{\beta'}$  may be stacked along a codimension 1 face, then*

$$\text{St}(CF(\mathcal{L}_\alpha, \mathcal{L}_\beta), CF(\mathcal{L}_\alpha, \mathcal{L}_{\beta'})) \cong CF(\mathcal{L}_\alpha, \text{St}(\mathcal{L}_\beta, \mathcal{L}_{\beta'})).$$

- (2) *Stacking hyperboxes of chain complexes commutes with tensoring hyperboxes: If  $\mathcal{C}$  and  $\mathcal{C}'$  are stackable hyperboxes of chain complexes, and  $\mathcal{D}$  is another hyperbox of chain complexes, then*

$$\text{St}(\mathcal{C}, \mathcal{C}') \otimes \mathcal{D} \cong \text{St}(\mathcal{C}, \mathcal{D}) \otimes \text{St}(\mathcal{C}', \mathcal{D}).$$

- (3) *Compressing hyperboxes of chain complexes commutes with tensor products of hyperboxes. If  $\mathcal{C}$  and  $\mathcal{D}$  are hyperboxes of chain complexes, and  $\widehat{\mathcal{C}}$  denotes compression, then there is a choice of ordering of the axis directions used to compute the compression so that*

$$\widehat{\mathcal{C}} \otimes \widehat{\mathcal{D}} \cong \widehat{\mathcal{C} \otimes \mathcal{D}}.$$

*Proof.* Claim (1) is essentially the definition of the pairing between hyperboxes. Similarly (2) is clear. For claim (3), we use the inductive perspective on compression from Section 2.3. Compress the axis directions for  $\mathcal{C}$  first, and then compress the axis directions for  $\mathcal{D}$ . Write  $\mathbf{d}_1$  for the size of  $\mathcal{C}$  and  $\mathbf{d}_2$  for the size of  $\mathcal{D}$ . Consider the effect of compressing the last axis direction of  $\mathcal{D}$ . Write  $\mathbf{d}_2 = (d_{2,1}, \dots, d_{2,n})$ . Recall that we construct  $\widehat{\mathcal{D}}$  by writing  $\mathcal{D}$  as the stacking of  $d_{2,1} \cdots d_{2,n-1}$  hyperboxes of size  $(1, 1, \dots, 1, d_{2,n})$ , each of which we compress by function composition, and then restack to obtain a hyperbox  $\mathcal{D}_n$  of size  $(d_{2,1}, d_{2,2}, \dots, d_{2,n-1}, 1)$ . We then repeat this procedure  $n$  times. If  $\mathcal{D}^s$  was one of the constituent hyperboxes of size  $(1, 1, \dots, d_{2,n})$ , we wrote  $\mathcal{D}^s$  as 1-dimensional hyperbox

$$\mathcal{D}^s = \mathcal{D}_1^s \xrightarrow{f_{1,2}} \dots \xrightarrow{f_{d_{2,n-1}, d_{2,n}}} \mathcal{D}_{d_{2,n}}^s.$$

We then tensor with  $\mathcal{C}$  to obtain

$$\mathcal{C} \otimes \mathcal{D}^s = \mathcal{C} \otimes \mathcal{D}_1^s \xrightarrow{\text{id}_{\mathcal{C}} \otimes f_{1,2}} \dots \xrightarrow{\text{id}_{\mathcal{C}} \otimes f_{d_{2,n-1}, d_{2,n}}} \mathcal{C} \otimes \mathcal{D}_{d_{2,n}}^s.$$

The composition of the above maps is

$$(f_{d_{2,n-1}, d_{2,n}} \circ \dots \circ f_{1,2}) \otimes \text{id}_{\mathcal{D}}$$

Hence, if  $\mathcal{D}_n$  denotes the hyperbox obtained from  $\mathcal{D}$  by compressing the last axis, then compressing the last axis of  $\mathcal{C} \otimes \mathcal{D}$  gives

$$\mathcal{C} \otimes \mathcal{D}_n.$$

Performing the above procedure inductively to the remaining directions corresponding to  $\mathcal{D}$ , and then the directions corresponding to  $\mathcal{C}$ , we obtain that the compression of  $\mathcal{C} \otimes \mathcal{D}$  is itself  $\widehat{\mathcal{C}} \otimes \widehat{\mathcal{D}}$ .  $\square$

A more sophisticated extension of Lemma 2.9 concerns commuting a tensor product operation on attaching curves and the pairing operation on hypercubes of attaching curves. See Propositions 10.1 and 11.8.

### 3. $A_\infty$ -MODULES

In this section, we recall some background about  $A_\infty$  modules. We follow the notation of [LOT18] [LOT15]. See [Kel01] [Kel02] for further background and historical context.

**3.1. Type- $A$  and type- $D$  modules.** In this section and throughout the paper, we work over characteristic 2.

**Definition 3.1.** Suppose  $\mathcal{A}$  is an associative algebra. A left  $A_\infty$ -module  ${}_{\mathcal{A}}M$  over  $\mathcal{A}$  is a left  $\mathbf{k}$ -module  $M$  equipped with  $\mathbf{k}$ -module map

$$m_{j+1}: \mathcal{A}^{\otimes j} \otimes_{\mathbf{k}} M \rightarrow M$$

for each  $j \geq 0$ , such that if  $a_n, \dots, a_1 \in \mathcal{A}$  and  $\mathbf{x} \in M$ , then

$$\sum_{j=0}^n m_{n-j+1}(a_n, \dots, a_{j+1}, m_{j+1}(a_j, \dots, a_1, \mathbf{x})) + \sum_{k=1}^{n-1} m_n(a_n, \dots, a_{k+1}a_k, \dots, a_1, \mathbf{x}) = 0.$$

An  $A_\infty$  module  ${}_{\mathcal{A}}M$  is *strictly unital* if  $m_2(1, \mathbf{x}) = \mathbf{x}$  for all  $\mathbf{x} \in M$ , and such that for each  $j > 1$ ,  $m_{j+1}(a_j, \dots, a_1, \mathbf{x}) = 0$  if  $a_i \in \mathbf{k}$  for some  $i$ .

**Definition 3.2.** If  $\mathcal{A}$  is an associative algebra over  $\mathbf{k}$ , a right type- $D$  module  $N^{\mathcal{A}}$  is right  $\mathbf{k}$ -module  $N$ , equipped with a  $\mathbf{k}$ -linear structure map

$$\delta^1: N \rightarrow N \otimes_{\mathbf{k}} \mathcal{A},$$

which satisfies

$$(\text{id}_N \otimes \mu_2) \circ (\delta^1 \otimes \text{id}_{\mathcal{A}}) \circ \delta^1 = 0.$$

Note that in the above, we are only considering associative algebras, instead of  $dg$ -algebras or  $A_\infty$ -algebras. See [LOT15, Definition 2.2.23] for the general definition.

*Remark 3.3.* Some care must be taken in translating the results of [LOT18] and [LOT15] to our present situation. For example Lipshitz, Ozsváth and Thurston work exclusively with algebras which are *nilpotent* ([LOT15, Definition 2.19]), which our algebra  $\mathcal{K}$  is not. Most of their algebraic framework still holds, but some subtleties arise when considering  $DD$  bimodules, which do not appear extensively in our paper. See [LOT15, Remark 2.3.12].

**3.2. Bimodules.** We also need to consider  $A_\infty$ -bimodules. Our exposition and notation follows [LOT15], though we restrict to the case of associative algebras (as opposed to  $dg$ -algebras or  $A_\infty$ -algebras).

**Definition 3.4.** Suppose that  $\mathcal{A}$  and  $\mathcal{B}$  are algebras over  $\mathbf{j}$  and  $\mathbf{k}$ , respectively. A type  $DA$  bimodule, denoted  ${}_{\mathcal{A}}M^{\mathcal{B}}$ , consists of a  $(\mathbf{j}, \mathbf{k})$ -module  $M$ , equipped with  $(\mathbf{j}, \mathbf{k})$ -linear structure morphisms

$$\delta_{j+1}^1: \mathcal{A}^{\otimes j} \otimes_{\mathbf{j}} M \rightarrow M \otimes_{\mathbf{k}} \mathcal{B},$$



which satisfy the following structure relation:

$$\begin{aligned} & \sum_{j=0}^n ((\text{id}_M \otimes \mu_2) \circ (\delta_{n-j+1}^1 \otimes \text{id}_{\mathcal{B}}))(a_n, \dots, a_{j+1}, \delta_{j+1}^1(a_j, \dots, a_1, \mathbf{x})) \\ & + \sum_{k=1}^{n-1} \delta_n^1(a_n, \dots, a_{k+1} a_k, \dots, a_1, \mathbf{x}) = 0. \end{aligned}$$

**3.3. The Lipshitz–Ozsváth–Thurston box tensor product.** In this section, we recall the *box tensor product* of Lipshitz, Ozsváth and Thurston [LOT18, Section 2.4].

Suppose that  $\mathcal{A}$  is an associative algebra over  $\mathbf{k}$ . If  $N^{\mathcal{A}}$  is a type- $D$  module and  ${}_{\mathcal{A}}M$  is a type- $A$  module, then the *box tensor product*  $N^{\mathcal{A}} \boxtimes {}_{\mathcal{A}}M$  is the chain complex  $N \otimes_{\mathbf{k}} M$ , with differential  $\partial^{\boxtimes}$  as follows. Following [LOT18], it is convenient to make the inductive notation that  $\delta^j: N \rightarrow N \otimes \mathcal{A}^{\otimes j}$  is the map given inductively by  $\delta^j = (\text{id}_{\mathcal{A}^{\otimes j-1}} \otimes \delta^1) \circ \delta^{j-1}$  and  $\delta^0 = \text{id}$ . Then the differential has the formula

$$\partial^{\boxtimes}(\mathbf{x} \otimes \mathbf{y}) = \sum_{j=0}^{\infty} (\text{id}_N \otimes m_{j+1})(\delta^j(\mathbf{x}), \mathbf{y}).$$

The differential is usually depicted via the following diagram:

$$\partial^{\boxtimes}(\mathbf{x} \otimes \mathbf{y}) = \begin{array}{ccc} & \mathbf{x} & \mathbf{y} \\ & \downarrow & \downarrow \\ & \delta & \\ & \searrow & \downarrow \\ & & m \\ & \downarrow & \downarrow \end{array} \quad (3.1)$$

According to [LOT18, Lemma 2.30], the map  $\partial^{\boxtimes}$  is a differential whenever one of  $M$  or  $N$  satisfies a *boundedness* assumption; see [LOT15, Definitions 2.2.18 and 2.2.29].

There are also versions for pairing  $DA$  bimodules. Below, we give the schematic for pairings of the form  $AD \boxtimes AD$ ,  $AD \boxtimes A$  and  $D \boxtimes AD$ :

$$\delta^{AD \boxtimes AD} = \begin{array}{ccc} \mathbf{a} & \mathbf{x} & \mathbf{y} \\ \searrow & \downarrow & \downarrow \\ & \delta & \\ & \searrow & \downarrow \\ & & \delta^1 \\ & \downarrow & \downarrow \end{array} \quad \delta^{AD \boxtimes A} = \begin{array}{ccc} \mathbf{a} & \mathbf{x} & \mathbf{y} \\ \searrow & \downarrow & \downarrow \\ & \delta & \\ & \searrow & \downarrow \\ & & m \\ & \downarrow & \downarrow \end{array} \quad \delta^{D \boxtimes AD} = \begin{array}{ccc} & \mathbf{x} & \mathbf{y} \\ & \downarrow & \downarrow \\ & \delta & \\ & \searrow & \downarrow \\ & & \delta^1 \\ & \downarrow & \downarrow \end{array} .$$

**3.4. Morphisms of modules and bimodules.** We now recall the definitions of morphisms of type- $D$ , type- $A$  and type- $DA$  modules and bimodules from [LOT15]. We assume that all algebras are associative algebras with vanishing differential. We refer the reader to [LOT15] for the case of  $dg$  or  $A_{\infty}$ -algebras.

Suppose  $\mathcal{A}$  is an algebra over  $\mathbf{k}$  and  $N^{\mathcal{A}}$  and  $M^{\mathcal{A}}$  are two type- $D$  modules. A morphism  $f^1: N^{\mathcal{A}} \rightarrow M^{\mathcal{A}}$  is a  $\mathbf{k}$ -linear map

$$f^1: N \rightarrow M \otimes_{\mathbf{k}} \mathcal{A}.$$

There is a morphism differential, given by

$$\partial_{\text{Mor}}(f^1) = (\text{id}_M \otimes \mu_2) \circ (f^1 \otimes \text{id}_{\mathcal{A}}) \circ \delta^1 + (\text{id}_M \otimes \mu_2) \circ (\delta^1 \otimes \text{id}_{\mathcal{A}}) \circ f^1.$$

The map  $\partial_{\text{Mor}}$  squares to zero. A type- $D$  homomorphism (or cycle) is a morphism which satisfies  $\partial_{\text{Mor}}(f^1) = 0$ .

A morphism  $f_*$  between two type- $A$  modules  ${}_A M$  and  ${}_A N$  is a collection of  $\mathbf{k}$ -linear maps

$$f_{j+1}: \mathcal{A}^{\otimes j} \otimes_{\mathbf{k}} M \rightarrow N.$$

There is a morphism differential  $\partial_{\text{Mor}}(f_*)$  given by

$$\begin{aligned} \partial_{\text{Mor}}(f_*)_{n+1}(a_n, \dots, a_1, \mathbf{x}) &= \sum_{j=0}^n f_{n-j+1}(a_n, \dots, a_{j+1}, f_{j+1}(a_j, \dots, a_1, \mathbf{x})) \\ &\quad + \sum_{i=1}^{n-1} f_n(a_n, \dots, a_{i+1}a_i, \dots, a_1, \mathbf{x}). \end{aligned}$$

Finally, if  ${}_A M^{\mathcal{B}}$  and  ${}_A N^{\mathcal{B}}$  are  $DA$ -bimodules, then a morphism is a collection of maps  $f_*^1 = (f_{j+1}^1)_{j \geq 0}$  as follows:

$$f_{j+1}^1: \mathcal{A}^{\otimes j} \otimes M \rightarrow N \otimes \mathcal{B}.$$

The morphism differential is given by

$$\begin{aligned} &\partial_{\text{Mor}}(f_*^1)_{n+1}(a_n, \dots, a_1, \mathbf{x}) \\ &= \sum_{j=0}^n (\text{id}_N \otimes \mu_2)(f_{n-j+1}^1 \otimes \text{id}_{\mathcal{B}})(a_n, \dots, a_{j+1}, f_{j+1}^1(a_j, \dots, a_1, \mathbf{x})) \\ &\quad + \sum_{i=1}^{n-1} f_n^1(a_n, \dots, a_{i+1}a_i, \dots, a_1, \mathbf{x}). \end{aligned}$$

If  $f_*^1: {}_A M^{\mathcal{B}} \rightarrow {}_A N^{\mathcal{B}}$  and  $g_*^1: {}_A P^{\mathcal{B}} \rightarrow {}_A Q^{\mathcal{B}}$  are  $DA$ -bimodule morphisms, Lipshitz–Ozsváth–Thurston define the composition  $f_*^1 \circ g_*^1$  via the following diagram:

$$\begin{array}{ccc} \mathbf{a} & & \mathbf{x} \\ \Downarrow & & \downarrow \\ \Delta & \searrow & f_*^1 \\ & \searrow & \downarrow \\ & & g_*^1 \\ & & \downarrow \\ & & \mu_2 \end{array} \quad (3.2)$$

In Equation (3.2),  $\Delta$  denotes the co-multiplication

$$\Delta: \mathcal{A}^{\otimes n} \rightarrow \bigoplus_{i=0}^n \mathcal{A}^{\otimes i} \otimes \mathcal{A}^{\otimes (n-i)}$$

given by

$$\Delta(a_1 | \dots | a_n) = \sum_{i=1}^n (a_1 | \dots | a_i) \otimes (a_{i+1} | \dots | a_n).$$

In the above,  $|$  denotes tensor product.

We now discuss pairing morphisms of modules and bimodules. We focus on the case of  $DA$ -bimodule morphisms. The other types of pairings which are relevant to our paper are defined by forgetting about the input algebra or output algebra in the diagrams below. The natural algebraic operation is to pair a bimodule morphism with the identity (as opposed to pairing two morphisms together). Suppose that  ${}_{\mathcal{A}}N^{\mathcal{B}}$  and  ${}_{\mathcal{A}}M^{\mathcal{B}}$  and  ${}_{\mathcal{B}}P^{\mathcal{C}}$  are  $DA$ -bimodules, and

$$f_*^1: {}_{\mathcal{A}}N^{\mathcal{B}} \rightarrow {}_{\mathcal{A}}M^{\mathcal{B}}$$

is a morphism of  $DA$ -bimodules. There is a morphism of  $DA$ -bimodules  $f_*^1 \boxtimes \mathbb{I}: N \boxtimes P \rightarrow M \boxtimes P$ , defined by the following diagram

$$f_*^1 \boxtimes \mathbb{I} =$$

If instead  $g_*^1: {}_{\mathcal{B}}P^{\mathcal{C}} \rightarrow {}_{\mathcal{B}}Q^{\mathcal{C}}$  is a morphism of type- $DA$  modules, then  $\mathbb{I} \boxtimes g_*^1$  is given by the diagram

**3.5. External tensor products.** In this section, we recall a basic algebraic operation called the *external tensor product*. We consider these for type- $D$  and type- $DA$  modules over  $dg$ -algebras, and we prove some basic properties.

We begin with the setting of type- $D$  modules. Let  $\mathcal{A}$  and  $\mathcal{B}$  be  $dg$ -algebras, and let  $N^{\mathcal{A}} = (N, \delta^1)$  and  $M^{\mathcal{B}} = (M, d^1)$  be type- $D$  modules. Then the *external tensor product*, denoted  $(N \otimes_{\mathbb{F}} M)^{\mathcal{A} \otimes_{\mathbb{F}} \mathcal{B}}$ , is the group  $M \otimes_{\mathbb{F}} N$  equipped with the structure map  $\text{id}_N \otimes 1_{\mathcal{A}} \otimes d^1 + \delta^1 \otimes \text{id}_M \otimes 1_{\mathcal{B}}$  (with tensor factors reordered).

The external tensor product of two type- $DA$  bimodules is more complicated. In general, one must choose a cellular diagonal of the associahedron. We follow the presentation Lipshitz, Ozsváth and Thurston [LOT18] [LOT20]. The main goal of this section is to give a concrete formula (not involving diagonals of the associahedron) of the external tensor product of two  $DA$ -bimodules, which we use throughout the paper. The description is given below in Equation (3.4).

Our description is in terms of a more basic operation, which we call *extension of scalars* (and is also inspired by [LOT15]). Suppose that  $\mathcal{A}$ ,  $\mathcal{B}$  and  $\mathcal{C}$  are  $dg$ -algebras over rings  $\mathbf{i}$ ,  $\mathbf{j}$  and  $\mathbf{k}$ , respectively. If  ${}_{\mathcal{A}}N^{\mathcal{B}}$  is a bimodule, then we will describe a

bimodule  ${}_{\mathcal{A} \otimes \mathcal{C}} \mathcal{E}(N; \mathcal{C})^{\mathcal{B} \otimes \mathcal{C}}$  which we say is formed by extension of scalars. We will relate this operation with an external tensor product with the identity bimodule  ${}_{\mathcal{C}} \mathbb{I}^{\mathcal{C}}$  in Lemma 3.11.

As an  $(\mathbf{i} \otimes \mathbf{k}, \mathbf{j} \otimes \mathbf{k})$ -module, we declare  $\mathcal{E}(N; \mathcal{C}) := N \otimes_{\mathbb{F}} \mathbf{k}$ . If  $k \in \mathbf{k}$ , then we define

$$\delta_{j+1}^1(a_j | c_j, \dots, a_1 | c_1, \mathbf{x} | k) = \delta_{j+1}^1(a_j, \dots, a_1, \mathbf{x}) \otimes k \otimes (c_j \cdots c_1). \quad (3.3)$$

Note that  $\delta_1^1(\mathbf{x} | k) = \delta_1^1(\mathbf{x}) \otimes k \otimes 1_{\mathcal{C}}$ . (Note we are implicitly reordering the  $k$  factor and the  $\mathcal{B}$  factor above).

Given a morphism of  $DA$ -bimodules  $f_*^1: {}_{\mathcal{A}} N^{\mathcal{B}} \rightarrow {}_{\mathcal{A}} M^{\mathcal{B}}$ , there is a morphism

$$\mathcal{E}(f)_*^1: {}_{\mathcal{A} \otimes \mathcal{C}} \mathcal{E}(N; \mathcal{C})^{\mathcal{B} \otimes \mathcal{C}} \rightarrow {}_{\mathcal{A} \otimes \mathcal{C}} \mathcal{E}(M; \mathcal{C})^{\mathcal{B} \otimes \mathcal{C}}$$

given by replacing  $\delta_{j+1}^1$  with  $f_{j+1}^1$  in (3.3).

*Remark 3.5.* If  ${}_{\mathcal{A}} M^{\mathcal{B}}$  is operationally bounded (i.e.  $\delta_j^1 = 0$  for large  $j$ ), then the same is true for  $\mathcal{E}(M, \mathcal{C})$ . A similar statement holds for morphisms.

*Remark 3.6.* We will usually drop the  $\mathcal{E}$  symbol when performing extension of scalars, since it is cumbersome.

**Lemma 3.7.** *Suppose that  $\mathcal{A}$ ,  $\mathcal{B}$ , and  $\mathcal{C}$  are dg-algebras and suppose that  ${}_{\mathcal{A}} N^{\mathcal{B}}$  is a  $DA$ -bimodule.*

- (1)  ${}_{\mathcal{A} \otimes \mathcal{C}} \mathcal{E}(N; \mathcal{C})^{\mathcal{B} \otimes \mathcal{C}}$  satisfies the  $DA$ -bimodule structure relations.
- (2) If  $f_*^1$  is a morphism of  $DA$ -bimodules, then  $\partial_{\text{Mor}}(\mathcal{E}(f_*^1)) = \mathcal{E}(\partial_{\text{Mor}}(f_*^1))$ .
- (3) If  ${}_{\mathcal{A}} M^{\mathcal{B}}$  and  ${}_{\mathcal{B}} N^{\mathcal{D}}$  are bimodules and  ${}_{\mathcal{B}} N^{\mathcal{D}}$  is operationally bounded, then there is a canonical isomorphism of  $DA$ -bimodules

$${}_{\mathcal{A} \otimes \mathcal{C}} \mathcal{E}({}_{\mathcal{A}} M^{\mathcal{B}} \boxtimes {}_{\mathcal{B}} N^{\mathcal{D}}; \mathcal{C})^{\mathcal{D} \otimes \mathcal{C}} \cong {}_{\mathcal{A} \otimes \mathcal{C}} \mathcal{E}(M; \mathcal{C})^{\mathcal{B} \otimes \mathcal{C}} \boxtimes {}_{\mathcal{B} \otimes \mathcal{C}} \mathcal{E}(N; \mathcal{C})^{\mathcal{D} \otimes \mathcal{C}}.$$

- (4) With respect to the above isomorphism, we also have

$$\mathcal{E}(f_*^1 \boxtimes \mathbb{I}) = \mathcal{E}(f_*^1) \boxtimes \mathbb{I} \quad \text{and} \quad \mathcal{E}(\mathbb{I} \boxtimes g_*^1) = \mathbb{I} \boxtimes \mathcal{E}(g_*^1),$$

for any  $DA$ -bimodule morphisms  $f_*^1$  and  $g_*^1$ .

*Proof.* We consider the first claim. Consider the bimodule structure relation, applied to sequence  $(b_n | c_n), \dots, (b_1 | c_1), \mathbf{x} | 1_{\mathbf{k}}$ . There are two types of terms: those with  $\mu_1$  applied to some  $c_i$  on the incoming or outgoing algebra elements, and those without a  $\mu_1$  applied to an algebra element of  $\mathcal{C}$ . Separating these terms, the bimodule relations for  $\mathcal{E}(\delta_*^1)$  follow from the bimodule relations for  $\delta_*^1$ , and the Leibniz rule for  $\mathcal{C}$ .

For the second claim, we note that each term of  $\partial_{\text{Mor}}(\mathcal{E}(f_*^1))$ , when evaluated on  $(b_n | c_n), \dots, (b_1 | c_1), \mathbf{x} | 1_{\mathbf{k}}$ , is either equal to a corresponding term of  $\partial_{\text{Mor}}(f_*^1)$ , evaluated on  $b_n, \dots, b_1, \mathbf{x}$  and tensored with  $c_1 \cdots c_n$ , or involves a  $\mu_1(c_i)$ . It is easy to see that all of the terms cancel.

For the third claim, the map is  $f_1^1(\mathbf{x} \otimes \mathbf{y}) = \mathbf{x} \otimes \mathbf{y} \otimes 1_{\mathcal{A} \otimes \mathcal{C}}$  and  $f_j^1 = 0$  if  $j > 1$ . It is easy to see that this is an isomorphism of  $DA$  bimodules.

The final claim is verified in a similar manner.  $\square$

We now consider an additional commutativity property of extension of scalars. For our proof, we recall Lipshitz, Ozsváth and Thurston's notion of a *bonsai* bimodule. Suppose  $T$  is a planar tree with  $n$  inputs, and one output. We label the rightmost input as the module input. There is an induced map  $\delta_T^1$  obtained by applying  $\mu_2$  or  $\delta_j^1$  to the inputs, according to  $T$ , and then multiplying all of the output algebra elements.

We say that a bimodule is *bonsai* if  $\delta_T^1 = 0$  whenever  $\deg(T) = \sum_{v \in V_{\text{int}}(T)} (\deg(v) - 3)$  is sufficiently large, where  $\deg(v)$  is the valence of a vertex, and  $V_{\text{int}}(T)$  denotes the vertices of valence at least 3.

**Proposition 3.8.** *Suppose that  ${}_{\mathcal{A}}M^{\mathcal{B}}$  and  ${}_{\mathcal{C}}N^{\mathcal{D}}$  are  $DA$ -bimodules over  $dg$ -algebras which are *bonsai*. Then*

$${}_{\mathcal{A} \otimes \mathcal{C}}\mathcal{E}(M, \mathcal{C})^{\mathcal{B} \otimes \mathcal{C}} \boxtimes {}_{\mathcal{B} \otimes \mathcal{C}}\mathcal{E}(N, \mathcal{B})^{\mathcal{B} \otimes \mathcal{D}} \quad \text{and} \quad {}_{\mathcal{A} \otimes \mathcal{C}}\mathcal{E}(N, \mathcal{A})^{\mathcal{A} \otimes \mathcal{D}} \boxtimes {}_{\mathcal{A} \otimes \mathcal{D}}\mathcal{E}(M, \mathcal{D})^{\mathcal{B} \otimes \mathcal{D}}$$

are homotopy equivalent as  $DA$ -bimodules.

*Remark 3.9.* If one of  $M$  and  $N$  has the property that  $\delta_j^1 = 0$  for  $j > 2$ , then the above Proposition may be easily proven directly since the structure maps on the two tensor products are identical.

Proposition 3.8 is most naturally proven by considering a more general tensor product operation on bimodules, called the *external tensor product*. The construction requires a choice of a cellular diagonal of Stasheff's associahedron  $K_n$  [Sta61]. We recall some background about diagonals presently. Our exposition will follow the notation of Lipshitz, Ozsváth and Thurston [LOT20], though we refer the reader to earlier work of Saneblidze-Umble [SU04] on diagonals of the associahedron. See also [MS06] and [Lod11].

We recall that the associahedron  $K_n$  has a cell decomposition such that the cells are in bijection with planar trees which have  $n + 1$  valence 1 vertices, which are partitioned into  $n$  input vertices and 1 output vertex. The dimension of a cell  $[T]$  corresponds to  $\deg(T)$ , defined above. We write  $C_*^{\text{cell}}(K_n)$  for the corresponding chain complex. The differential corresponds to summing all ways of splitting an interior vertex into two vertices connected by an edge.

The external tensor product operation has as input a pair of  $DA$ -bimodules  ${}_{\mathcal{A}}M^{\mathcal{B}}$  and  ${}_{\mathcal{C}}N^{\mathcal{D}}$ , and has as output a  $DA$ -bimodule  ${}_{\mathcal{A} \otimes \mathcal{C}}(M \otimes_{\Gamma} N)^{\mathcal{B} \otimes \mathcal{D}}$ , which depends on a cellular diagonal of the associahedron, as below. We recall that an associahedron diagonal  $\Gamma$  consists of a collection of degree preserving chain maps

$$\Gamma_n: C_*^{\text{cell}}(K_n) \rightarrow C_*^{\text{cell}}(K_n) \otimes_{\mathbb{F}} C_*^{\text{cell}}(K_n),$$

for  $n \geq 2$ , which are compatible with concatenation of trees, and such that  $\Gamma_2$  is the canonical isomorphism between  $C_*^{\text{cell}}(K_2) \cong \mathbb{F}$  and  $C_*^{\text{cell}}(K_2) \otimes_{\mathbb{F}} C_*^{\text{cell}}(K_2) \cong \mathbb{F}$ . See [LOT20, Definition 2.13] for a precise statement. We write  $\Psi_n$  for the top degree element of  $C_*^{\text{cell}}(K_n)$ , which has homological degree  $n - 2$ . The generator  $\Psi_n$  is called the *corolla* with  $n$ -inputs.

Lipshitz, Ozsváth and Thurston also define a slightly more general notion, called a *module diagonal* [LOT20, Definition 2.22], which relaxes the compatibility condition for splicing slightly. We refer the reader to [LOT20, Section 2.3] for a precise definition.

If  ${}_{\mathcal{A}}M^{\mathcal{B}} = (M, \delta_*^1)$  is a  $DA$ -bimodule, then to each planar tree  $T$  with  $n + 1$ -inputs, we may form an evaluation map  $\delta_T^1: \mathcal{A}^{\otimes n} \otimes M \rightarrow M \otimes \mathcal{B}$  by composing the structure maps of  $M$  as well as  $\mu_2^{\mathcal{A}}$  according to the tree  $T$ , and then multiplying via  $\mu_2^{\mathcal{B}}$  all of the algebra outputs. More generally, we may view the structure maps of  $M$  as giving a map

$$\delta_{\text{ev}}^1: C_*^{\text{cell}}(K_{n+1}) \rightarrow \text{Hom}_{(\mathbf{k}, \mathbf{j})}(\mathcal{A}^{\otimes n} \otimes M, M \otimes \mathcal{B}).$$

We may equip  $\mathrm{Hom}_{(\mathbf{k}, \mathbf{j})}(\mathcal{A}^{\otimes n} \otimes M, M \otimes \mathcal{B})$  with a differential so that  $\partial(f_{n+1}^1)$  is the sum of the terms of  $\partial_{\mathrm{Mor}}(f_{n+1}^1)$  which involve only  $\mu_1^A$ ,  $\mu_1^B$ , or  $\delta_1^1$  and  $\mu_2^B$ . The statement that  $\delta_*^1$  satisfies the  $DA$ -bimodule relations is equivalent to the statement that  $M^B \boxtimes_{\mathcal{B}} \mathcal{B}$  is a chain complex, and that  $\delta_{\mathrm{ev}}^1$  is a chain map.

We define  $\delta_1^1$  on  $M \otimes_{\mathbb{F}} N$  via the Leibniz rule, and for  $n > 0$  we define the structure map  $\delta_{n+1}^1$  as the composition of  $\Gamma_{n+1}$  together with the tensor product  $\delta_{\mathrm{ev}}^1 \otimes \delta_{\mathrm{ev}}^1$  of the structure maps from  $M$  and  $N$ . The fact that a  $DA$ -bimodule is immediate.

Using the technique of acyclic models, as in [LOT20], it is straightforward to show that any two choices of cellular associahedron diagonals (or module diagonals) give homotopy equivalent type- $DA$  bimodules  ${}_{\mathcal{A} \otimes \mathcal{C}}(M \otimes_{\Gamma} N)^{\mathcal{B} \otimes \mathcal{D}}$ .

**Lemma 3.10.** *Suppose that  $\Gamma$  is a cellular diagonal of the associahedron (or more generally, a module diagonal). For each  $n$ , write  $\Gamma_n(\Psi_n) = \Psi_n \otimes X + Y$ , where  $X$  has degree 0 and  $Y \in \bigoplus_{i=1}^{n-2} C_{n-i-2}^{\mathrm{cell}}(K_n) \otimes C_i^{\mathrm{cell}}(K_n)$ . Write  $X = x_1 + \cdots + x_j$ , where each  $x_i$  is a tree of degree 0. Then  $j \equiv 1 \pmod{2}$ .*

*Proof.* There is a quasi-isomorphism  $\pi_n: C_*^{\mathrm{cell}}(K_n) \rightarrow \mathbb{F}$ , which is 0 on  $C_{>0}^{\mathrm{cell}}(K_n)$ . The map  $\pi_n$  sends a tree in grading 0 to 1, and is 0 on all other trees. It is straightforward to check that  $\pi_n$  is a chain map. By tensoring, we obtain a quasi-isomorphism  $\mathrm{id} \otimes \pi_n: C_*^{\mathrm{cell}}(K_n) \otimes C_*^{\mathrm{cell}}(K_n) \rightarrow C_*^{\mathrm{cell}}(K_n)$ .

The claim in the statement equivalent to the claim that  $(\mathrm{id} \otimes \pi_n)(\Gamma_n(\Psi_n))$  is non-zero. To see this, we argue by induction. The case that  $n = 2$  is clear.

By induction and the fact that  $\Gamma_n$  is compatible with respect to splicing trees, we observe that  $(\mathrm{id} \otimes \pi_n)(\Gamma_n(\partial\Psi_n)) = \partial\Psi_n$ . On the other hand,

$$(\mathrm{id} \otimes \pi_n)(\Gamma_n(\partial\Psi_n)) = \partial(\mathrm{id} \otimes \pi_n)(\Gamma_n(\Psi_n)).$$

For this to be  $\partial\Psi_n$ , we must have that  $(\mathrm{id} \otimes \pi_n)(\Gamma_n(\Psi_n))$  is non-zero, so the proof is complete.  $\square$

**Lemma 3.11.** *If  ${}_{\mathcal{A}}N^{\mathcal{B}}$  is a  $DA$ -bimodule and  $\mathcal{C}$  is a  $dg$ -algebra, then  $\mathcal{E}(N, \mathcal{C})$  is isomorphic to the external tensor product of  ${}_{\mathcal{A}}N^{\mathcal{B}}$  and  ${}_{\mathcal{C}}[\mathbb{I}]^{\mathcal{C}}$ , for any choice of cellular diagonal of the associahedron (or more generally, module diagonal).*

*Proof.* The map  $\delta_{n+1}^1$  on the external tensor product is determined by the structure map on  $N$  as well as the chain  $\Gamma_{n+1}(\Psi_{n+1})$ . If  $T_i \otimes S_j$  is any summand of  $\Gamma_{n+1}(\Psi_{n+1})$ , where  $T_i$  and  $S_j$  are trees with  $n+1$  inputs of degree  $i$  and  $j$ , respectively, then the corresponding summand of  $\delta_{n+1}^1$  on  $\mathcal{E}(N, \mathcal{C})$  will vanish unless  $j = 0$  and  $i = n-1$  since  $\mathcal{C}$  is a  $dg$ -algebra. In particular, the only contributions to  $\delta_{n+1}^1$  will be from tree pairs of the form  $\Psi_{n+1} \otimes T_0$ , where  $T_0$  is a degree 0 tree. By Lemma 3.10 there are an odd number of such summands of  $\Gamma_{n+1}(\Psi_{n+1})$ . It follows that the external tensor product is exactly the extension of scalars construction we gave earlier.  $\square$

*Proof of Proposition 3.8.* The proof follows from the work of Lipshitz, Ozsváth and Thurston [LOT20], as we now describe. Since the proof is mostly a consequence of their work, we will be terse with the details.

Firstly, we observe that the structure map on  $\mathcal{E}(N, \mathcal{C}) \boxtimes \mathcal{E}(M, \mathcal{B})$  can be viewed as summing over a very particular set of trees in  $C_*^{\mathrm{cell}}(K_n) \otimes C_*^{\mathrm{cell}}(K_n)$ . To describe these tree pairs, we define the *right-join* of two input-trees to be the tree obtained by stacking the output of  $T_1$  into the right most vertex of  $T_1$ . (This is the mirror of Lipshitz, Ozsváth

and Thurston's *left-join*, as adapted to our handedness conventions on modules). If  $T_1, \dots, T_n$  are  $n$  trees, the *root-join* of  $T_1, \dots, T_n$  is obtained by adjoining the outputs of  $T_1, \dots, T_n$  into a single corolla  $\Psi_n$ . See [LOT20, Definition 2.28].

Next, we arbitrarily pick for each  $n > 1$  a degree 0 tree  $S_n \in C_*^{\text{cell}}(K_n)$ .

The trees counted by  $\mathcal{E}(N, \mathcal{C}) \boxtimes \mathcal{E}(M, \mathcal{B})$  consist of pairs  $T \otimes S$  where  $T$  is the right-join of  $k$  corollas  $\Psi_{n_1}, \dots, \Psi_{n_k}$  (for some  $k > 0$ ) and  $S$  is the root-join of the tree  $\downarrow \in C_0(K_1)$  and degree 0 trees  $S_{n_1}, \dots, S_{n_k}$  in our list of standard degree 0 trees  $\{S_1, S_2, S_3, \dots\}$ . This root join is taken in such a way that  $\downarrow$  corresponds to the module input of the tree. See Figure 3.1.

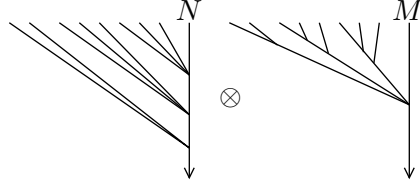

FIGURE 3.1. A pair of trees contributing to the box tensor product  $\mathcal{E}(N) \boxtimes \mathcal{E}(M)$ .

We claim that

$$\mathcal{A}_{\otimes \mathcal{C}}(\mathcal{E}(N, \mathcal{C}) \boxtimes \mathcal{E}(M, \mathcal{B}))^{\mathcal{B} \otimes \mathcal{D}} \cong \mathcal{A}_{\otimes \mathcal{C}}(N \otimes_{\Gamma} M)^{\mathcal{B} \otimes \mathcal{D}} \quad (3.4)$$

for some choice of module diagonal  $\Gamma$ . This clearly implies the claim, because any two choices of module diagonals give homotopic bimodules by the technique of acyclic models, as in [LOT20]. To prove Equation (3.4), we use the construction of module diagonals due to Lipshitz, Ozsváth and Thurston using *module diagonal primitives*. A module diagonal primitive  $\mathbf{p}$  consists of a choice for each  $n$  of a degree  $n - 2$  chain

$$\mathbf{p}_n \in C_*^{\text{cell}}(K_n) \otimes C_*^{\text{cell}}(K_{n-1})$$

which satisfies several compatibility conditions. The first compatibility condition reads that  $\mathbf{p}_2 = \Psi_2 \otimes \downarrow$ . The second compatibility condition is that

$$\partial \mathbf{p} = LR(\mathbf{p}^{\otimes \bullet}) + \mathbf{p} \circ' \gamma,$$

where  $\mathbf{p} = \sum_n \mathbf{p}_n$  and  $\mathbf{p}^{\otimes \bullet} = \sum_{n \geq 0} \mathbf{p}^{\otimes n}$  and  $\circ'$  is an operation on trees defined in [LOT20, Definition 2.28]. In [LOT20, Definition 2.34], Lipshitz, Ozsváth and Thurston describe a natural procedure for constructing a module diagonal from a module diagonal primitive.

We claim that the structure relations on  $\mathcal{E}(N, \mathcal{C}) \boxtimes \mathcal{E}(M, \mathcal{B})$  coincide with those on the external tensor product  $N \otimes_{\Gamma} M$  for any module diagonal  $\Gamma$  which is obtained from a module diagonal primitive. Given the explicit description from [LOT20, Definition 2.34], this follows from the claim that if  $\pi_n$  is the quasi-isomorphism described in the proof of Lemma 3.10, then

$$(\text{id} \otimes \pi_{n-1})(\mathbf{p}_n) = \Psi_n. \quad (3.5)$$

The above is proven by induction similarly to Lemma 3.10. Namely, the claim is clearly true for  $\mathbf{p}_2$ . Next, we observe that  $\partial(\text{id} \otimes \pi_{n-1})(\mathbf{p}_n) = (\text{id} \otimes \pi_n)(\partial \mathbf{p}_n)$ . We leave it as a straightforward exercise to the reader to verify that the compatibility conditions for module diagonal primitives [LOT20, Definition 2.29], together with the inductive

hypothesis, and also the fact that  $\pi_{n-1}$  vanishes on trees of degree greater than 0, imply that

$$(\text{id} \otimes \pi_{n-1})(\partial \mathbf{p}_n) = \partial \Psi_n,$$

from which Equation (3.5) follows. The main claim follows.  $\square$

**3.6. Hypercubes as type- $D$  modules.** In this section, we present a helpful perspective of hypercubes and hyperboxes in terms of type- $D$  modules over certain algebras which we call the *cube* and *box* algebras. Many natural hyperbox operations, such as compression, have natural interpretations as  $A_\infty$ -module operations with respect to these algebras. This material is new to this article.

We will not use the cube and box algebras explicitly in this paper, but they are related to our reinterpretation of the Manolescu and Ozsváth's link surgery formula in terms of type- $D$  modules over the algebra  $\mathcal{L}$ .

We begin with the 1-dimensional cube algebra  $\mathcal{C}_1$ . The algebra  $\mathcal{C}_1$  is an algebra over the idempotent ring  $\mathbf{I}_0 \oplus \mathbf{I}_1$ , where  $\mathbf{I}_\varepsilon \cong \mathbb{F}$ . We set  $\mathbf{I}_\varepsilon \cdot \mathcal{C}_1 \cdot \mathbf{I}_\varepsilon = \mathbf{I}_\varepsilon$ , and we set

$$\mathbf{I}_1 \cdot \mathcal{C}_1 \cdot \mathbf{I}_0 = \langle \theta \rangle,$$

i.e. we set  $\mathbf{I}_1 \cdot \mathcal{C}_1 \cdot \mathbf{I}_0 \cong \mathbb{F}$ , generated by an element  $\theta$ .

Next, we introduce the *cube algebra*  $\mathcal{C}_n$ . The definition is

$$\mathcal{C}_n = \mathcal{C}_1 \otimes_{\mathbb{F}} \cdots \otimes_{\mathbb{F}} \mathcal{C}_1 = \otimes_{\mathbb{F}}^n \mathcal{C}_1.$$

Note that this is an algebra over the idempotent ring  $\mathbf{E}_n = \otimes_{\mathbb{F}}^n \mathbf{I}$ .

The importance of the cube algebra is the following:

**Lemma 3.12.** *The category of  $n$ -dimensional hypercubes of chain complexes is equivalent to the category of type- $D$  modules over  $\mathcal{C}_n$ .*

*Proof.* We describe how to obtain a type- $D$  module over  $\mathcal{C}_n$  from a hypercube of chain complexes. Suppose that  $X = (X_\varepsilon, D_{\varepsilon, \varepsilon'})_{\varepsilon \in \mathbb{E}_n}$  is a hypercube of chain complexes. We define a type- $D$  module  $\mathcal{X}^{\mathcal{C}_n}$  as follows. The underlying group of  $\mathcal{X}$  is the total space of  $X$ , i.e.  $\mathcal{X} = \bigoplus_{\varepsilon \in \mathbb{E}_n} X_\varepsilon$ . This is naturally a module over the idempotent ring  $\mathbf{E}_n$ .

We define  $\delta^1: \mathcal{X} \rightarrow \mathcal{X} \otimes_{\mathbf{E}_n} \mathcal{C}_n$  as follows. If  $\varepsilon \leq \varepsilon'$ , there is an algebra element  $\theta_{\varepsilon, \varepsilon'}$  which is the product of  $\theta_i$  over all  $i$  such that  $\varepsilon_i < \varepsilon'_i$ . If  $\varepsilon = \varepsilon'$ , we set  $\theta_{\varepsilon, \varepsilon} = i_\varepsilon$ . With this notation, we set

$$\delta^1(\mathbf{x}) = \sum_{\varepsilon \leq \varepsilon'} D_{\varepsilon, \varepsilon'}(\mathbf{x}) \otimes \theta_{\varepsilon, \varepsilon'}.$$

The type- $D$  structure relations for  $(\mathcal{X}, \delta^1)$  are straightforward to verify.

If  $X = (X_\varepsilon, D_{\varepsilon, \varepsilon'})$  and  $Y = (Y_\varepsilon, D'_{\varepsilon, \varepsilon'})$  are two  $n$ -dimensional hypercubes of chain complexes, it is straightforward to extend the above construction to give an isomorphism between morphism sets

$$F: \text{Mor}_{\mathbb{E}_n}(X, Y) \rightarrow \text{Mor}^{\mathcal{C}_n}(\mathcal{X}^{\mathcal{C}_n}, \mathcal{Y}^{\mathcal{C}_n}),$$

where  $\text{Mor}_{\mathbb{E}_n}$  denotes the group of hypercube morphisms and  $\text{Mor}^{\mathcal{C}_n}$  denotes the group of type- $D$  morphisms. Clearly  $F$  is an isomorphism and  $F(f \circ g) = F(f) \circ F(g)$ . Hence, we have constructed a functor from the category of  $n$ -dimensional hypercubes to the category of type- $D$  modules over  $\mathcal{C}_n$ . An inverse functor is straightforward to describe.  $\square$



The above construction extends naturally to the setting of hyperboxes, as we now describe. We begin with the 1-dimensional box algebra  $\mathcal{B}_{(d)}$  of size  $d > 0$ . This is an algebra over the idempotent ring

$$\mathbf{I}_{(d)} := \mathbf{I}_0 \oplus \mathbf{I}_1 \oplus \cdots \oplus \mathbf{I}_d,$$

where each  $\mathbf{I}_i \cong \mathbb{F}$ . We set

$$\mathbf{I}_i \cdot \mathcal{B}_{(d)} \cdot \mathbf{I}_i = \mathbb{F}.$$

We set

$$\mathbf{I}_j \cdot \mathcal{B}_{(d)} \cdot \mathbf{I}_i = \begin{cases} \langle \theta_{i,i+1} \rangle & \text{if } j = i + 1 \\ \{0\} & \text{otherwise.} \end{cases}$$

Multiplication is given by setting  $\theta_{j,j+1} \cdot \theta_{i,i+1} = 0$  for all  $i$  and  $j$ .

If  $\mathbf{d} = (d_1, \dots, d_n)$  is a tuple of positive integers, we define the *hyperbox algebra* of size  $\mathbf{d}$ , denoted  $\mathcal{B}_{\mathbf{d}}$  to be the tensor product

$$\mathcal{B}_{\mathbf{d}} := \mathcal{B}_{(d_1)} \otimes_{\mathbb{F}} \cdots \otimes_{\mathbb{F}} \mathcal{B}_{(d_n)}.$$

We have the following straightforward extension of Lemma 3.12:

**Lemma 3.13.** *The category of hyperboxes of size  $\mathbf{d}$  is equivalent to the category of type- $D$  modules over the algebra  $\mathcal{B}_{\mathbf{d}}$ .*

Manolescu and Ozsváth's compression operation also has a conceptually simple description in terms of the cube and box algebras. With the present perspective, compression takes the form of a  $DA$  bimodule

$$\mathcal{B}_{(d)}[\mathfrak{C}_{(d)}]^{C_1},$$

defined as follows.

If  $d = 1$ , we define  $\mathfrak{C}_{(d)}$  to be the identity bimodule. Henceforth, assume  $d > 1$ . As a group  $\mathfrak{C}_{(d)}$  is a copy of  $\mathbf{I} = \mathbf{I}_0 \oplus \mathbf{I}_1$ . Right right action of  $\mathbf{I}$  is the obvious one. The left action of the box idempotent ring  $\mathbf{I}_{(d)}$  is given by having  $\mathbf{I}_{(0)}$  and  $\mathbf{I}_{(d)}$  act by  $\mathbf{I}_0$  and  $\mathbf{I}_1$ , respectively, and having  $\mathbf{I}_j$  act trivially for  $j = 1, \dots, d-1$ .

The bimodule  $[\mathfrak{C}_d]$  has  $\delta_j^1 = 0$  for all  $j$  except  $\delta_2^1$  and  $\delta_{d+1}^1$ . We set  $\delta_2^1$  to be the unique map satisfying  $\delta_2^1(i_\varepsilon, i_\nu) = (i_\varepsilon \cdot i_\nu) \otimes 1$ , where  $\varepsilon \in \{0, \dots, d\}$  and  $\nu \in \{0, 1\}$ , and such that  $\delta_2^1(\theta_{i,i+1}, i_\nu) = 0$  for all  $i$ . We define

$$\delta_{d+1}^1(\theta_{d-1,d}, \dots, \theta_{0,1}, i_0) = i_1 \otimes \theta.$$

*Example 3.14.* Consider a hyperbox of dimension 1:

$$X = \left( C_0 \xrightarrow{f_{1,0}} C_1 \xrightarrow{f_{2,1}} \cdots \xrightarrow{f_{d-1,d}} C_d \right)$$

The associated type- $D$  module over  $\mathcal{B}_{(d)}$  takes the following form:

$$\mathcal{X}^{\mathcal{B}_{(d)}} = \left( C_0 \xrightarrow{f_{0,1} \otimes \theta_{0,1}} C_1 \xrightarrow{f_{1,2} \otimes \theta_{1,2}} \cdots \xrightarrow{f_{d-1,d} \otimes \theta_{d-1,d}} C_d \right)$$

The underlying group of the box tensor product  $\mathcal{X}^{\mathcal{B}_{(d)}} \boxtimes_{\mathcal{B}_{(d)}} [\mathfrak{C}_{(d)}]^{C_1}$  is  $C_0 \oplus C_d$ . One easily computes that the differential on this box tensor product is

$$\mathcal{X}^{\mathcal{B}_{(d)}} \boxtimes_{\mathcal{B}_{(d)}} [\mathfrak{C}_{(d)}]^{C_1} = \left( C_0 \xrightarrow{(f_{d-1,d} \circ \cdots \circ f_{0,1}) \otimes \theta} C_d \right).$$

The right hand side is the compression of  $X$ , viewed as a type- $D$  module over  $\mathcal{C}_1$ , because it coincides with the function composition description of compression that is discussed in Section 2.3

More generally, if  $\mathbf{d} = (d_1, \dots, d_n)$  is an  $n$ -tuple of positive integers, we can define a bimodule  $\mathcal{B}_{\mathbf{d}}[\mathfrak{C}_{\mathbf{d}}]^{\mathcal{C}_n}$  as the external tensor product of the  $DA$ -bimodules  $\mathcal{B}_{(d_i)}[\mathfrak{C}_{(d_i)}]^{\mathcal{C}_1}$  ranging over  $i = 1, \dots, n$ . Note that defining the external tensor product requires a choice of ordering of the axis directions, cf. Section 3.5.

Since compression of hyperboxes has the interpretation in terms of function composition from Section 2.3, we obtain immediately the following:

**Lemma 3.15.** *If  $X$  is a hyperbox of size  $\mathbf{d} = (d_1, \dots, d_n)$ , and  $\mathcal{X}^{\mathcal{B}_{\mathbf{d}}}$  is the corresponding type- $D$  module, then the compression of  $X$  coincides with the hypercube corresponding to  $\mathcal{X}^{\mathcal{B}_{\mathbf{d}}} \boxtimes_{\mathcal{B}_{\mathbf{d}}}[\mathfrak{C}_{\mathbf{d}}]^{\mathcal{C}_n}$ .*

#### 4. HOMOLOGICAL PERTURBATION THEORY

In this section, we describe several versions of the homological perturbation lemma.

**4.1.  $A_{\infty}$ -modules.** Kadeishvili proved that  $A_{\infty}$ -algebra structures could be transferred along homotopy equivalences of the underlying chain complex, when coefficients were in a field [Kad82]. A formula for the perturbed  $A_{\infty}$ -module structure in terms of trees may be found in work of Kontsevich and Soibelman [KS01, Section 6.4]. See [Kel01, Section 3.3] or [Sei08, Remark 1.15] for more historical context and development of ideas. The following is a statement of the homological perturbation lemma for  $A_{\infty}$ -modules.

**Lemma 4.1.** *Suppose that  $\mathcal{A}$  is a dg-algebra over  $\mathbf{k}$ , and  ${}_{\mathcal{A}}M$  is an  $A_{\infty}$ -module,  $(Z, m_1^Z)$  is a chain complex over  $\mathbf{k}$ , and that we have three maps of left  $\mathbf{k}$ -modules*

$$i: Z \rightarrow M, \quad \pi: M \rightarrow Z \quad \text{and} \quad h: M \rightarrow M$$

*satisfying the following:*

- (1)  $i$  and  $\pi$  are chain maps.
- (2)  $\pi \circ i = \text{id}_Z$ .
- (3)  $i \circ \pi = \text{id}_M + \partial_{\text{Mor}}(h)$ .
- (4)  $h \circ i = 0$ .
- (5)  $\pi \circ h = 0$ .
- (6)  $h \circ h = 0$ .

*In the above,  $\partial_{\text{Mor}}(h) = h \circ m_1^M + m_1^M \circ h$ . Then there is an  $A_{\infty}$ -module structure on  $Z$ , extending  $m_1^Z$ , such that the maps  $\pi$ ,  $i$  and  $h$  extend to  $A_{\infty}$ -module morphisms which satisfy all of the above relations as  $A_{\infty}$ -module maps.*

One extremely useful aspect of the homological perturbation lemma is that all of the maps have a concrete description. The structure maps on  $Z$  are given by the diagrams shown in Figure 4.1. Therein  $m_{>1}$  denotes the  $A_{\infty}$  structure maps of  $M$ , with  $m_1$  excluded.

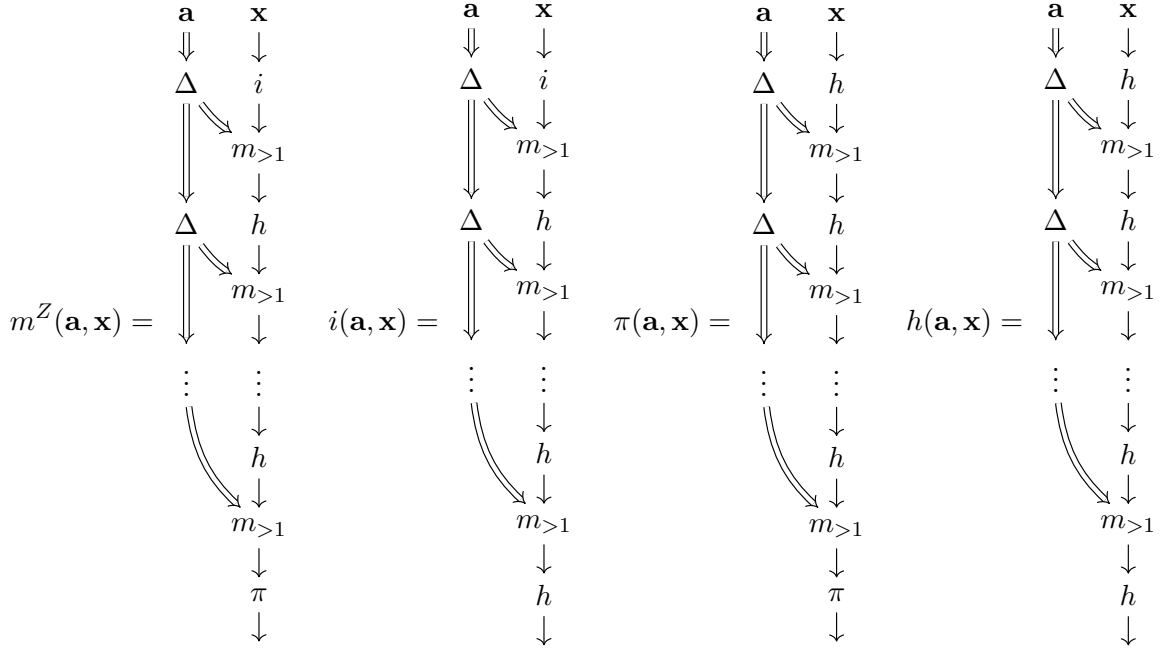

FIGURE 4.1. The maps appearing in the homological perturbation lemma for  $A_\infty$ -modules.

**4.2.  $DA$ -bimodules.** There is a homological perturbation lemma for  $DA$ -bimodules, which we will use extensively. The statement and proof are similar to the statement for  $A_\infty$ -modules. If  $(\mathcal{A}M^{\mathcal{B}}, \delta_j^1)$  is a  $DA$ -bimodule, we will write  $M^{\mathcal{B}}$  for the associated type- $D$  module which has the same generators as  $\mathcal{A}M^{\mathcal{B}}$ , and whose structure map is given by the map  $\delta_1^1$  from  $\mathcal{A}M^{\mathcal{B}}$ .

**Lemma 4.2.** *Suppose that  $\mathcal{A}$  and  $\mathcal{B}$  are dg-algebras, and that  $\mathcal{A}M^{\mathcal{B}}$  is a strictly unital type- $DA$  bimodule,  $Z^{\mathcal{B}}$  is a type- $D$  module over  $\mathcal{B}$ , and that we have three morphisms of type- $D$  modules*

$$i^1: Z^{\mathcal{B}} \rightarrow M^{\mathcal{B}}, \quad \pi^1: M^{\mathcal{B}} \rightarrow Z^{\mathcal{B}} \quad \text{and} \quad h^1: M^{\mathcal{B}} \rightarrow M^{\mathcal{B}}$$

*satisfying the following:*

- (1)  $i^1$  and  $\pi^1$  are homomorphisms of type- $D$  modules (i.e. cycles).
- (2)  $\pi^1 \circ i^1 = \text{id}_{Z^{\mathcal{B}}}$ .
- (3)  $i^1 \circ \pi^1 = \text{id}_{M^{\mathcal{B}}} + \partial_{\text{Mor}}(h^1)$ .
- (4)  $h^1 \circ i^1 = 0$ .
- (5)  $\pi^1 \circ h^1 = 0$ .
- (6)  $h^1 \circ h^1 = 0$ .

*Then there is an induced  $DA$ -bimodule structure on  $\mathcal{A}Z^{\mathcal{B}}$ , extending  $Z^{\mathcal{B}}$ , such that the maps  $\pi^1$ ,  $i^1$  and  $h^1$  extend to  $DA$ -bimodule morphisms which satisfy all of the above relations as  $DA$ -bimodule morphisms.*

$$\begin{array}{ccc}
\mathbf{a} & & \mathbf{x} \\
\Downarrow & & \downarrow \\
\Delta & \searrow & i^1 \\
\Downarrow & \searrow & \delta_{>1}^1 \\
\Delta & \searrow & h^1 \\
\Downarrow & \searrow & \delta_{>1}^1 \\
\vdots & \searrow & \vdots \\
& \searrow & h^1 \\
& \searrow & \delta_{>1}^1 \\
& \searrow & \pi^1 \\
& & \downarrow \\
& & \Pi \\
& & \downarrow
\end{array}
\tag{4.1}$$

$\delta_{j+1}^1(\mathbf{a}, \mathbf{x}) =$

FIGURE 4.2. The structure relation  $\delta_{j+1}^1$  from the homological perturbation lemma for  $DA$ -bimodules.

We refer the reader to [OS18, Lemma 2.12] for a proof. Note that the maps are similar to those appearing in Figure 4.1. The structure map  $\delta_{j+1}^1$  is indicated in Figure 4.2. The other maps  $i_j^1$ ,  $\pi_j^1$  and  $h_j^1$  are constructed by a similar modification of the other maps in Figure 4.1. Here,  $\delta_{>1}^1$  denotes  $\delta_j^1$  for some  $j > 1$ . The final  $\Pi$  map means to multiply all of the inputs using several applications of  $\mu_2$ .

**4.3. Hypercubes.** In this section, we review a version of the homological perturbation lemma for hypercubes. This version of the homological perturbation lemma is from [HHSZ22], where a proof may be found. Lemma 4.3 is similar to other formulations of the homological perturbation lemma in the context of filtered chain complexes. For example, see work of Huebschmann–Kadeishvili [HK91]. A similar, though slightly less explicit, construction for transferring hypercube structures along homotopy equivalences is described by Liu [Liu14, Section 5.6].

**Lemma 4.3.** *Suppose that  $\mathcal{C} = (C_\varepsilon, D_{\varepsilon, \varepsilon'})_{\varepsilon \in \mathbb{E}_n}$  is a hypercube of chain complexes, and  $(Z_\varepsilon)_{\varepsilon \in \mathbb{E}_n}$  is a collection of chain complexes, indexed by  $\varepsilon \in \mathbb{E}_n$ . Furthermore, suppose that for each  $\varepsilon \in \mathbb{E}_n$ , we have chosen maps*

$$\pi_\varepsilon: C_\varepsilon \rightarrow Z_\varepsilon \quad i_\varepsilon: Z_\varepsilon \rightarrow C_\varepsilon \quad h_\varepsilon: C_\varepsilon \rightarrow C_\varepsilon,$$

satisfying

$$\pi_\varepsilon \circ i_\varepsilon = \text{id}, \quad i_\varepsilon \circ \pi_\varepsilon = \text{id} + [\partial, h_\varepsilon], \quad h_\varepsilon \circ h_\varepsilon = 0, \quad \pi_\varepsilon \circ h_\varepsilon = 0 \quad \text{and} \quad h_\varepsilon \circ i_\varepsilon = 0$$

and such that  $\pi_\varepsilon$  and  $i_\varepsilon$  are chain maps. With the above data chosen, there are canonical hypercube structure maps  $\delta_{\varepsilon, \varepsilon'}: Z_\varepsilon \rightarrow Z_{\varepsilon'}$  so that  $\mathcal{Z} = (Z_\varepsilon, \delta_{\varepsilon, \varepsilon'})$  is a hypercube of chain complexes, and also there are morphisms of hypercubes

$$\Pi: \mathcal{C} \rightarrow \mathcal{Z}, \quad I: \mathcal{Z} \rightarrow \mathcal{C} \quad \text{and} \quad H: \mathcal{C} \rightarrow \mathcal{C}$$

such that  $I$  and  $\Pi$  are chain maps, and

$$\Pi \circ I = \text{id}_{\mathcal{Z}} \quad \text{and} \quad I \circ \Pi = \text{id}_{\mathcal{C}} + \partial_{\text{Mor}}(H).$$

It is important to understand that the structure maps  $\delta_{\varepsilon, \varepsilon'}$  and the morphisms  $\Pi$  and  $I$  are determined completely by an explicit formula. We now describe  $\delta_{\varepsilon, \varepsilon'}$ . Suppose that  $\varepsilon < \varepsilon'$  are points in  $\mathbb{E}_n$ . The hypercube structure maps  $\delta_{\varepsilon, \varepsilon'}$  are given by the following sum:

$$\delta_{\varepsilon, \varepsilon'} := \sum_{\varepsilon = \varepsilon_1 < \dots < \varepsilon_j = \varepsilon'} \pi_{\varepsilon'} \circ D_{\varepsilon_{j-1}, \varepsilon_j} \circ h_{\varepsilon_{j-1}} \circ D_{\varepsilon_{j-2}, \varepsilon_{j-1}} \circ \dots \circ h_{\varepsilon_2} \circ D_{\varepsilon_1, \varepsilon_2} \circ i_\varepsilon.$$

The component of the map  $I$  sending coordinate  $\varepsilon$  to coordinate  $\varepsilon'$  is given via the formula

$$I_{\varepsilon, \varepsilon'} := \sum_{\varepsilon = \varepsilon_1 < \dots < \varepsilon_j = \varepsilon'} h_{\varepsilon_j} \circ D_{\varepsilon_{j-1}, \varepsilon_j} \circ \dots \circ h_{\varepsilon_2} \circ D_{\varepsilon_1, \varepsilon_2} \circ i_\varepsilon.$$

Similarly,  $\Pi$  is given by the formula

$$\Pi_{\varepsilon, \varepsilon'} := \sum_{\varepsilon = \varepsilon_1 < \dots < \varepsilon_j = \varepsilon'} \pi_{\varepsilon'} \circ D_{\varepsilon_{j-1}, \varepsilon_j} \circ h_{\varepsilon_{j-1}} \circ D_{\varepsilon_{j-2}, \varepsilon_{j-1}} \circ \dots \circ D_{\varepsilon_1, \varepsilon_2} \circ h_{\varepsilon_1}.$$

**4.4. Hypercubes of  $DA$ -bimodules.** There is a version of the homological perturbation lemma which naturally generalizes both the homological perturbation lemmas for  $DA$ -bimodules and hypercubes of chain complexes.

**Definition 4.4.** A *hypercube of  $DA$ -bimodules* consists of a  $DA$ -bimodule  $(C, \delta_*^1)$ , such that  $C$  decomposes as  $C = \bigoplus_{\varepsilon \in \mathbb{E}_n} C_\varepsilon$ , where each  $C_\varepsilon$  is itself a  $(\mathbf{j}, \mathbf{k})$ -module. Furthermore, the structure map  $\delta_{j+1}^1$  decomposes as a sum of maps

$$\delta_{j+1, \varepsilon, \varepsilon'}^1: \mathcal{A}^{\otimes j} \otimes C_\varepsilon \rightarrow C_{\varepsilon'} \otimes \mathcal{B}.$$

where  $j \geq 0$ , and  $\varepsilon \leq \varepsilon'$ .

The above definition is a special case of Lipshitz, Ozsváth and Thurston's notion of a *filtered  $DA$ -bimodule* [LOT14, Section 2.2].

**Lemma 4.5.** Suppose that  $\mathcal{A}$  and  $\mathcal{B}$  are dg-algebras. Suppose also that  $\mathcal{A}\mathcal{C}^\mathcal{B} = (\mathcal{A}C_\varepsilon^\mathcal{B}, D_{*, \varepsilon, \varepsilon'}^1)_{\varepsilon \in \mathbb{E}_n}$  is a hypercube of  $DA$ -bimodules, and suppose that we for each  $\varepsilon \in \mathbb{E}_n$  we have chosen type- $D$  modules  $(Z_\varepsilon^\mathcal{B})_{\varepsilon \in \mathbb{E}_n}$ , as well as morphisms of type- $D$  modules

$$\pi_\varepsilon^1: C_\varepsilon^\mathcal{B} \rightarrow Z_\varepsilon^\mathcal{B}, \quad i_\varepsilon^1: Z_\varepsilon^\mathcal{B} \rightarrow C_\varepsilon^\mathcal{B} \quad \text{and} \quad h_\varepsilon^1: C_\varepsilon^\mathcal{B} \rightarrow C_\varepsilon^\mathcal{B}$$

satisfying

$$\pi_\varepsilon^1 \circ i_\varepsilon^1 = \text{id}_{Z_\varepsilon^\mathcal{B}}, \quad i_\varepsilon^1 \circ \pi_\varepsilon^1 + \text{id}_{C_\varepsilon^\mathcal{B}} = \partial_{\text{Mor}}(h_\varepsilon^1), \quad h_\varepsilon^1 \circ h_\varepsilon^1 = 0, \quad h_\varepsilon^1 \circ i_\varepsilon^1 = 0, \quad \text{and} \quad \pi_\varepsilon^1 \circ h_\varepsilon^1 = 0,$$

and such that  $\pi_\varepsilon^1$  and  $i_\varepsilon^1$  are homomorphisms of  $DA$ -bimodules (i.e. cycles). Such data determines structure maps  $\delta_{j+1,\varepsilon,\varepsilon'}^1: \mathcal{A}^{\otimes j} \otimes Z_\varepsilon \rightarrow Z_{\varepsilon'} \otimes \mathcal{B}$ , which make  ${}_{\mathcal{A}}\mathcal{Z}^{\mathcal{B}} = ({}_{\mathcal{A}}\mathcal{Z}_\varepsilon^{\mathcal{B}}, \delta_{*,\varepsilon,\varepsilon'}^1)$  a hypercube of  $DA$ -bimodules. Furthermore, there are morphisms of hypercubes of  $DA$ -bimodules

$$\Pi_*^1: {}_{\mathcal{A}}\mathcal{C}^{\mathcal{B}} \rightarrow {}_{\mathcal{A}}\mathcal{Z}^{\mathcal{B}} \quad I_*^1: {}_{\mathcal{A}}\mathcal{Z}^{\mathcal{B}} \rightarrow {}_{\mathcal{A}}\mathcal{C}^{\mathcal{B}} \quad \text{and} \quad H_*^1: {}_{\mathcal{A}}\mathcal{C}^{\mathcal{B}} \rightarrow {}_{\mathcal{A}}\mathcal{C}^{\mathcal{B}},$$

which satisfy analogous relations to  $i_\varepsilon^1$ ,  $\pi_\varepsilon^1$  and  $h_\varepsilon^1$ .

We now describe the maps  $\delta_*^1$ ,  $\Pi_*^1$ ,  $I_*^1$  and  $H_*^1$ . We focus on the structure map  $\delta_{j+1,\varepsilon,\varepsilon'}^1$ . This map is defined by modifying Figure 4.2 as follows. In place of each  $\delta_{>1}^1$  labeled therein, we are allowed one of two maps:

- (1) A hypercube map  $D_{j+1,\varepsilon,\varepsilon'}^1$  for  $\mathcal{C}$ , such that  $\varepsilon < \varepsilon'$ . Furthermore, we assume only that  $j \geq 0$  (so that we allow the case that there are no algebra inputs here).
- (2) An internal structure map  $D_{>1,\varepsilon,\varepsilon}^1$  of some  ${}_{\mathcal{A}}\mathcal{C}_\varepsilon^{\mathcal{B}}$  (so in this case we do not allow instances of the internal  $D_{1,\varepsilon,\varepsilon}^1$ ).

The maps  $\Pi_*^1$ ,  $I_*^1$  and  $H_*^1$  are defined by small modifications, similar to Figure 4.1. We leave the proof of the above lemma to the reader, as it is a straightforward variation of Lemma 4.2.

## 5. LINEAR TOPOLOGICAL SPACES

In this section, we recall basic background on algebraic completions. See [AM69, Section 10] and [Lef42, Chapter 2] for related background. This material is used to define our module categories in Section 6.

**Definition 5.1.** A *vector space with linear topology* (abbr. *linear topological space*) consists of a vector space  $\mathcal{X}$  equipped with a topology which admits a basis of open sets centered at 0 consisting of vector subspaces, such that furthermore the addition map  $\mathcal{X} \times \mathcal{X} \rightarrow \mathcal{X}$  is continuous.

If  $R$  is a ring, an  *$R$ -module with linear topology* is defined similarly, except that there is a basis of 0 consisting of  $R$ -submodules.

Vector spaces with linear topologies are usually specified by picking a decreasing filtration consisting of subspaces  $X_i \subseteq \mathcal{X}$  indexed by  $i \in I$ , where  $I$  is some directed set. Such a filtration determines a topology, where we declare a basis to be the sets of the form  $x + X_i$ , where  $i \in I$  and  $x \in \mathcal{X}$ .

Given a filtration  $(X_i)_{i \in I}$  on a vector space  $\mathcal{X}$ , the *completion* is defined as the inverse limit

$$\mathcal{X} := \varprojlim_{i \in I} \mathcal{X}/X_i.$$

Rather than working with inverse limits, it is sometimes easier to work with Cauchy sequences and nets. Since some of the spaces we are working with are not first countable, we work with Cauchy *nets* instead of the perhaps more familiar Cauchy *sequences*.

We recall that a *net* in a topological space  $\mathcal{X}$  is a map  $\mathbf{x}: I \rightarrow \mathcal{X}$ , where  $I$  is a partially ordered, directed set. We usually write  $\mathbf{x} = (x_i)_{i \in I}$  for a net. When  $\mathcal{X}$  is a linear topological vector space, we say that a net  $(x_i)_{i \in I}$  is *Cauchy* if for each open subspace  $E \subseteq \mathcal{X}$ , there is an  $i_0 \in I$  such that if  $i, j \geq i_0$ , then  $x_i - x_j \in E$ .

If  $(x_i)_{i \in I}$  and  $(y_j)_{j \in J}$  are two nets in  $\mathcal{X}$ , their sum is the net  $(x_i + y_j)_{(i,j) \in I \times J}$ . Two Cauchy nets are *equivalent* if their difference converges to  $0 \in \mathcal{X}$  as a net. We note that the collection of nets in  $\mathcal{X}$  forms a proper class, though the set of Cauchy equivalence classes is a set. The following is well known and is elementary to prove:

**Lemma 5.2.** *If  $\mathcal{X}$  is a linear topological space, then the completion  $\mathcal{X}$  is canonically isomorphic to the vector space of equivalence classes of Cauchy nets in  $\mathcal{X}$ .*

**5.1. Linear maps.** If  $\mathcal{X}$  and  $\mathcal{Y}$  are linear topological vector spaces, then a continuous map  $f: \mathcal{X} \rightarrow \mathcal{Y}$  naturally induces a map on completions. We recall the following basic principle, whose proof is elementary:

**Lemma 5.3.** *Suppose that  $\mathcal{X}$  and  $\mathcal{Y}$  are linear topological spaces. A linear map  $f: \mathcal{X} \rightarrow \mathcal{Y}$  is continuous if and only if it is continuous at 0.*

If  $\mathcal{X}$  and  $\mathcal{Y}$  are linear topological spaces, we write  $\text{Hom}(\mathcal{X}, \mathcal{Y})$  for the space of continuous linear maps. For our module categories, it is usually more natural to consider linear maps between the completions and consider  $\text{Hom}(\mathcal{X}, \mathcal{Y})$ .

**Definition 5.4.** We define the category of *linear topological vector spaces* over  $\mathbb{F}$ , denoted  $\text{LTS}_{\mathbb{F}}$  to have objects linear topological vector spaces over  $\mathbb{F}$ . We define the set of morphisms from  $\mathcal{X}$  to  $\mathcal{Y}$  in this category to be  $\text{Hom}(\mathcal{X}, \mathcal{Y})$  (i.e. continuous maps between completions).

*Remark 5.5.* By definition,  $\mathcal{X}$  and  $\mathcal{X}$  are isomorphic in the category  $\text{LTS}_{\mathbb{F}}$  for any linear topological space  $\mathcal{X}$ .

**5.2. Filtrations and direct products.** We now describe how to view the direct product as a completion of the direct sum, equipped with a natural topology. This perspective is particularly important for our purposes because of the role that direct products play in the surgery formula from [MO10].

**Definition 5.6.** If  $(X_i)_{i \in I}$  is a family of linear topological spaces, the *direct product* of topological vector spaces  $\mathcal{X} = \prod_{i \in I} X_i$  coincides with the direct product in the category of topological spaces. More explicitly, a subspace  $E \subseteq \bigoplus_{i \in I} X_i$  is open if and only if there is some finite set  $S \subseteq I$  and a set of open subspaces  $U_s \subseteq X_s$  ranging over  $s \in S$ , such that

$$\prod_{i \in I \setminus S} X_i \oplus \bigoplus_{s \in S} U_s \subseteq E.$$

We declare the product topology on  $\bigoplus_{i \in I} X_i$  to be the subspace topology.

Note that if  $\mathcal{X} = \bigoplus_{i \in I} \mathcal{X}_i$  is equipped with the product topology, then  $\mathcal{X} \cong \prod_{i \in I} \mathcal{X}_i$ .

In our work we consider frequently the case where  $S = \mathbb{Z}$  and each  $X_i = \mathbb{F}$ , equipped with the discrete topology. In this case, we write

$$\mathcal{X}_{\text{co}(S)} = \bigoplus_{i \notin S} X_i$$

for the fundamental basis of opens.

The following example illustrates the meaning of a continuous map between direct products equipped with the product topologies:

*Example 5.7.* Suppose that  $F: \prod_{i \in I} X_i \rightarrow \prod_{j \in J} Y_j$  is a linear map and each  $X_i$  and  $Y_j$  is equipped with the discrete topology. Write  $F_{j,i}$  for  $\Pi_j \circ f \circ I_i$ , where  $\Pi_j$  and  $I_i$  are projections and inclusions. Then  $F$  is continuous with respect to the product topologies if and only if for each  $j$ , there are only finitely many  $i$  such that  $F_{j,i} \neq 0$ , and furthermore  $F = \sum_{j,i} F_{j,i}$ .

**5.3. Linear compactness.** We now recall the notion of linear compactness. This definition is important for the module categories in Section 6 since all of the modules considered in this paper have underlying vector spaces which are linearly compact. Many basic statements about compact sets from point-set topology carry over to the case of linearly compact spaces, even though linear compactness and point-set compactness are not equivalent in general. There are several equivalent definitions of linear compactness, though the following is the most useful for our purposes:

**Definition 5.8.** A linear topological space  $\mathcal{X}$  is *linearly compact* if each open subspace  $U \subseteq \mathcal{X}$  has finite codimension, i.e.  $\dim(\mathcal{X}/U) < \infty$ .

*Remark 5.9.* (1) The notion of linear compactness may be found in the classical work of Lefschetz [Lef42, Chapter 2]. Note that Lefschetz formulates linear compactness in terms of the finite intersection property for closed affine subspaces, though this turns out to be equivalent. Since we will not revisit the work of Lefschetz, we will not describe the equivalence.

(2) If  $\mathcal{X}$  is first countable, Hausdorff, linearly compact and infinite dimensional, then it is an easy exercise to show that  $\mathcal{X}$  has an infinite dimensional subspace  $\bigoplus_{\mathbb{N}} \mathbb{F}$ , equipped with the product topology, which is dense. In particular  $\mathcal{X} \cong \prod_{\mathbb{N}} \mathbb{F}$ , equipped with the product topology.

(3) The direct product of linearly compact spaces is linearly compact.

**5.4. Tensor products.** Given linear topological vector spaces  $\mathcal{X}$  and  $\mathcal{Y}$ , there are many different ways to topologize the tensor product  $\mathcal{X} \otimes \mathcal{Y}$ . This phenomenon goes back to work Grothendieck [Gro54] in the setting of functional analysis and Banach spaces. Despite fundamental differences between the Banach spaces and linear topological vector spaces, similar phenomena occur in both settings.

In this paper, we focus on three natural topologies on tensor products:

- (1) The *standard topology*  $\mathcal{X} \otimes^! \mathcal{Y}$ .
- (2) The *\*-topology*  $\mathcal{X} \otimes^* \mathcal{Y}$ .
- (3) The *arrow-topology*  $\mathcal{X} \vec{\otimes} \mathcal{Y}$ .

The following inclusions are continuous

$$\mathcal{X} \otimes^* \mathcal{Y} \subseteq \mathcal{X} \vec{\otimes} \mathcal{Y} \subseteq \mathcal{X} \otimes^! \mathcal{Y}.$$

The topologies  $\otimes^*$  and  $\vec{\otimes}$  are due to Beilinson [Bei08]. Additional exposition and analysis of these constructions is given by Positelski [Pos20, Sections 12 and 13], wherein many basic properties, subtleties and counterexamples to natural conjectures are described. These topologies are defined as follows:

**Definition 5.10.** Suppose that  $\mathcal{X}$  and  $\mathcal{Y}$  are linear topological spaces.

- (1) A subspace  $E \subseteq \mathcal{X} \otimes^! \mathcal{Y}$  is open if and only if: There are open subspaces  $U \subseteq \mathcal{X}$  and  $V \subseteq \mathcal{Y}$  such that  $U \otimes \mathcal{Y} \subseteq E$  and  $\mathcal{X} \otimes V \subseteq E$ .



- (2) A subspace  $E \subseteq \mathcal{X} \otimes^* \mathcal{Y}$  is open if and only if: There are open subspaces  $U \subseteq \mathcal{X}$  and  $V \subseteq \mathcal{Y}$  such that  $U \otimes V \subseteq E$ ; and for each  $x \in \mathcal{X}$  and  $y \in \mathcal{Y}$ , there are open subspaces  $U_y \subseteq \mathcal{X}$  and  $V_x \subseteq \mathcal{Y}$  such that  $x \otimes V_x \subseteq E$  and  $U_y \otimes y \subseteq E$ .
- (3) A subspace  $E \subseteq \mathcal{X} \vec{\otimes} \mathcal{Y}$  is open if and only if: There is an open subspace  $U \subseteq \mathcal{X}$  so that  $U \otimes \mathcal{Y} \subseteq E$ ; and for each  $x \in \mathcal{X}$ , there is an open  $V_x \subseteq \mathcal{Y}$  such that  $x \otimes V_x \subseteq E$ .

The topologies  $\otimes^*$  and  $\otimes^!$  are symmetric between  $\mathcal{X}$  and  $\mathcal{Y}$ , though  $\vec{\otimes}$  is assymmetric. The motivation for  $\vec{\otimes}$  is that it is a natural topology for an algebra whose topology is given by one-sided ideals. This perspective is of particular importance because our algebra  $\mathcal{K}$  is most naturally topologized using a family of right ideals.

*Remark 5.11.* If  $\mathcal{X}$  and  $\mathcal{Y}$  are equipped with filtrations  $(X_i)_{i \in \mathbb{N}}$  and  $(Y_i)_{i \in \mathbb{N}}$ , such that  $X_0 = \mathcal{X}$  and  $Y_0 = \mathcal{Y}$ , then the topology on  $\mathcal{X} \otimes^! \mathcal{Y}$  is equivalent to the one induced by the filtration  $(\mathcal{X} \otimes \mathcal{Y})_n = \sum_{i+j=n} X_i \otimes Y_j$ . This is because

$$X_{2n} \otimes \mathcal{Y} \oplus \mathcal{X} \otimes Y_{2n} \subseteq \sum_{i+j=2n} X_i \otimes Y_j \subseteq X_n \otimes \mathcal{Y} + \mathcal{X} \otimes Y_n$$

This is not in general true if we work with filtrations over  $\mathbb{Z}$  instead of  $\mathbb{N}$ , or if we relax the assumption that  $X_0 = \mathcal{X}$  and  $Y_0 = \mathcal{Y}$ .

**5.5. Associativity and commutativity relations.** In this section, we recall some basic properties about the tensor products  $\otimes^!$ ,  $\vec{\otimes}$  and  $\otimes^*$ . We begin with associativity:

**Lemma 5.12.** *If  $\circ$  is one of  $\{*,!,\rightarrow\}$ , then the canonical map*

$$\mathcal{X} \otimes^\circ (\mathcal{Y} \otimes^\circ \mathcal{Z}) \cong (\mathcal{X} \otimes^\circ \mathcal{Y}) \otimes^\circ \mathcal{Z}$$

*is a homeomorphism.*

The reader may consult [Pos20, Proposition 13.4] for details. In contrast, the different tensor product operations are not mutually associative. Nonetheless, there are some relations between different parenthesizations of the tensor products. One important and well-known example is the following (we give a proof for the benefit of the reader):

**Lemma 5.13.** *Suppose that  $\mathcal{X}_1, \mathcal{X}_2, \mathcal{Y}_1,$  and  $\mathcal{Y}_2$  are linear topological vector spaces. The natural map*

$$(\mathcal{X}_1 \otimes^! \mathcal{Y}_1) \vec{\otimes} (\mathcal{X}_2 \otimes^! \mathcal{Y}_2) \rightarrow (\mathcal{X}_1 \vec{\otimes} \mathcal{X}_2) \otimes^! (\mathcal{Y}_1 \vec{\otimes} \mathcal{Y}_2)$$

*is continuous.*

*Proof.* A subspace  $E \subseteq (\mathcal{X}_1 \vec{\otimes} \mathcal{X}_2) \otimes^! (\mathcal{Y}_1 \vec{\otimes} \mathcal{Y}_2)$  is open if

- (s) There are open  $U_1 \subseteq \mathcal{X}_1$  and  $V_1 \subseteq \mathcal{Y}_1$ , and for each  $x_1 \in \mathcal{X}_1$  and  $y_1 \in \mathcal{Y}_1$  there are open  $U_2^{x_1} \subseteq \mathcal{X}_2$  and  $V_2^{y_1} \subseteq \mathcal{Y}_2$  so that  $\mathcal{X}_1 \otimes \mathcal{X}_2 \otimes V_1 \otimes \mathcal{Y}_2$ ,  $\mathcal{X}_1 \otimes \mathcal{X}_2 \otimes y_1 \otimes V_2^{y_1}$ ,  $U_1 \otimes \mathcal{X}_2 \otimes \mathcal{Y}_1 \otimes \mathcal{Y}_2$ , and  $x_1 \otimes U_2^{x_1} \otimes \mathcal{Y}_1 \otimes \mathcal{Y}_2$  are contained in  $E$ .

A subspace  $E \subseteq (\mathcal{X}_1 \otimes^! \mathcal{Y}_1) \vec{\otimes} (\mathcal{X}_2 \otimes^! \mathcal{Y}_2)$  is open if

- (t-1) There are open  $U_1 \subseteq \mathcal{X}_1$  and  $V_1 \otimes \mathcal{Y}_1$  so that  $U_1 \otimes \mathcal{Y}_1 \otimes \mathcal{X}_2 \otimes \mathcal{Y}_2$ , and  $\mathcal{X}_1 \otimes V_1 \otimes \mathcal{X}_2 \otimes \mathcal{Y}_2$  are contained in  $E$ .
- (t-2) For each  $x_1 \in \mathcal{X}_1$  and  $y_1 \in \mathcal{Y}_1$ , there is an open  $U_2^{x_1, y_1} \subseteq \mathcal{X}_2$  so that  $x_1 \otimes y_1 \otimes U_2^{x_1, y_1} \otimes \mathcal{Y}_2 \subseteq E$ .

(t-3) For each  $x_1 \in \mathcal{X}_1$ ,  $y_1 \in \mathcal{Y}_1$ ,  $x_2 \in \mathcal{X}_2$ , there is an open  $V_2^{x_1, y_1, x_2} \subseteq \mathcal{Y}_2$  so that  $x_1 \otimes y_1 \otimes x_2 \otimes V_2^{x_1, y_1, x_2} \subseteq E$ .

Any subspace  $E$  satisfying (s) satisfies (t-1), (t-2) and (t-3), so the stated map is continuous.  $\square$

Applying Lemma 5.13 repeatedly gives the following:

**Corollary 5.14.** *Suppose that  $\mathcal{X}_1, \dots, \mathcal{X}_n$  and  $\mathcal{Y}_1, \dots, \mathcal{Y}_n$  are linear topological vector spaces.*

(1) *The map*

$$(\mathcal{X}_1 \otimes^! \mathcal{Y}_1) \vec{\otimes} \cdots \vec{\otimes} (\mathcal{X}_n \otimes^! \mathcal{Y}_n) \rightarrow (\mathcal{X}_1 \vec{\otimes} \cdots \vec{\otimes} \mathcal{X}_n) \otimes^! (\mathcal{Y}_1 \vec{\otimes} \cdots \vec{\otimes} \mathcal{Y}_n)$$

*is continuous.*

(2) *The map*

$$(\mathcal{X}_1 \otimes^! \cdots \otimes^! \mathcal{X}_n) \vec{\otimes} (\mathcal{Y}_1 \otimes^! \cdots \otimes^! \mathcal{Y}_n) \rightarrow (\mathcal{X}_1 \vec{\otimes} \mathcal{Y}_1) \otimes^! \cdots \otimes^! (\mathcal{X}_n \vec{\otimes} \mathcal{Y}_n)$$

*is continuous.*

The following is well-known:

**Lemma 5.15.** *Suppose that  $\mathcal{X}$  and  $\mathcal{Y}$  are filtered spaces. If either:*

(1)  *$\mathcal{X}$  is linearly compact; or*

(2)  *$\mathcal{Y}$  is discrete,*

*then  $\mathcal{X} \vec{\otimes} \mathcal{Y} \cong \mathcal{X} \otimes^! \mathcal{Y}$ .*

*Proof.* Consider the case that  $\mathcal{X}$  is linearly compact and suppose that  $E \subseteq \mathcal{X} \vec{\otimes} \mathcal{Y}$  is an open subspace. By assumption, there is some open subspace  $U \subseteq \mathcal{X}$  so that  $U \otimes \mathcal{Y} \subseteq E$ . Since  $\mathcal{X}$  is linearly compact, we may pick  $x_1, \dots, x_n \in \mathcal{X}$  spanning a complementary vector space to  $U$ . By assumption, there are open subspaces  $V_1, \dots, V_n \subseteq \mathcal{Y}$  so that  $x_i \otimes V_i \subseteq E$ . Therefore

$$U \otimes \mathcal{Y} + \mathcal{X} \otimes (V_1 \cap \cdots \cap V_n) \subseteq U \otimes \mathcal{Y} + x_1 \otimes V_1 + \cdots + x_n \otimes V_n \subseteq E$$

so the map  $\mathcal{X} \otimes^! \mathcal{Y} \rightarrow \mathcal{X} \vec{\otimes} \mathcal{Y}$  is continuous. The map in the opposite direction is obviously continuous, so they are isomorphic.

The claim when  $\mathcal{Y}$  is discrete is similar.  $\square$

*Remark 5.16.* If both  $\mathcal{X}$  and  $\mathcal{Y}$  are linearly compact, or both are discrete, then all three tensor products  $\mathcal{X} \otimes^! \mathcal{Y}$ ,  $\mathcal{X} \vec{\otimes} \mathcal{Y}$  and  $\mathcal{X} \otimes^* \mathcal{Y}$  coincide. Similarly, if  $\mathcal{X}$  is linearly compact and discrete (i.e. finite dimensional), then all three tensor products coincide.

*Remark 5.17.* Even if  $\mathcal{X}$  and  $\mathcal{Y}$  are first countable, it may not be the case that  $\mathcal{X} \vec{\otimes} \mathcal{Y}$  is first countable. For example, if  $\mathcal{X} = \bigoplus_{i \in \mathbb{Z}} \mathbb{F}$  is given the discrete topology and  $\mathcal{Y} = \mathbb{F}[[U]]$  (equipped with the  $U$ -adic topology) then it is not hard to see that  $\mathcal{X} \vec{\otimes} \mathcal{Y}$  is not first countable. See [Pos20, Example 13.1 and Lemma 7.4].

Morphisms may also be tensored. We state the following well-known result:

**Lemma 5.18.** *All three tensor product operations  $\otimes^!$ ,  $\otimes^*$  and  $\vec{\otimes}$  are functorial with respect to morphisms, i.e., if  $f$  and  $g$  are continuous morphisms, then  $f \otimes^\circ g$  is also continuous for  $\circ \in \{!, *, \vec{\otimes}\}$ .*

See [Pos20, Lemma 12.3] for a detailed exposition.



**Definition 5.19.** Suppose that  $\Gamma$  is a strongly directed tree. We say a subspace  $E \subseteq \mathcal{X}_\Gamma$  is open if and only if for each admissible labeling  $s$  of  $\Gamma$  and each point-enhancement  $\mathbf{p}$  of  $s$ , there is an open-enhancement  $\mathcal{U}_\mathbf{p}$  of  $s$  so that

$$\mathcal{W}_{\mathbf{p}, \mathcal{U}_\mathbf{p}} \subseteq E.$$

*Example 5.20.* If  $\Gamma$  is a linearly ordered graph with vertices  $v_1 > v_2 > \cdots > v_n$ , and  $\mathcal{X}_{v_i}$  are spaces, then

$$\mathcal{X}_\Gamma = \mathcal{X}_{v_1} \vec{\otimes} \cdots \vec{\otimes} \mathcal{X}_{v_n}.$$

*Remark 5.21.* We warn the reader that there are some related (but subtly non-isomorphic) topologies that one can define on graphs. As an example, consider a graph  $\Gamma$  with a central root vertex  $v_0$ , and two rays pointing into  $v_0$ , labeled by vertices  $w_1, \dots, w_n$  and  $u_1, \dots, u_m$ . We designate  $v_0$  is minimal, and  $w_n$  and  $u_m$  are maximal. See below:

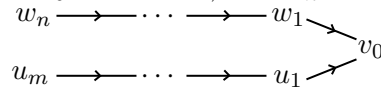

Note that the topology

$$\mathcal{Y} := ((\mathcal{X}_{w_1} \vec{\otimes} \cdots \vec{\otimes} \mathcal{X}_{w_n}) \otimes^* (\mathcal{X}_{u_1} \vec{\otimes} \cdots \vec{\otimes} \mathcal{X}_{u_m})) \vec{\otimes} \mathcal{X}_{v_0}$$

is similar to the tree topology  $\mathcal{X}_\Gamma$ , but is not isomorphic in general. The open subspaces of  $\mathcal{Y}$  may also be described in terms of admissible labelings of  $\Gamma$ , however the description has some subtle differences. For example, given an admissible labeling  $s$  with point-enhancements  $\mathbf{p}$ , the open subspaces in an open-enhancement  $\mathcal{U}_\mathbf{p}$  for  $\mathcal{X}_\Gamma$  may vary as we change  $\mathbf{p}$ . For  $\mathcal{Y}$ , the open set at a vertex labeled  $\mathcal{O}$  can only depend on the values of  $\mathbf{p}$  for vertices above that vertex. On the other hand, the map

$$\mathcal{X}_\Gamma \rightarrow \mathcal{Y}$$

is continuous. Compare Proposition 5.23 and Remark 5.24, below.

*Remark 5.22.* Suppose that  $\Gamma$  is a star with a minimal root  $v_0$ , and  $n$  vertices  $w_1, \dots, w_n$ , each connected to  $v_0$  (and no additional vertices).

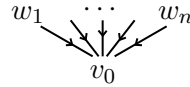

If  $\mathcal{X}_{v_0}, \mathcal{X}_{w_1}, \dots, \mathcal{X}_{w_n}$  are spaces indexed by the vertices, then

$$\mathcal{X}_\Gamma = (\mathcal{X}_{w_1} \otimes^* \cdots \otimes^* \mathcal{X}_{w_n}) \vec{\otimes} \mathcal{X}_{v_0}.$$

**Proposition 5.23.** Suppose that  $\Gamma$  is a strongly directed tree and  $\Gamma_0 \subseteq \Gamma$  is a connected subtree. Let  $L$  denote a linearly ordered graph. Let  $(\mathcal{X}_v)_{v \in V(\Gamma)}$  and  $(\mathcal{Y}_v)_{v \in V(L)}$  denote collections of spaces, and suppose that

$$f: \mathcal{X}_{\Gamma_0} \rightarrow \mathcal{Y}_L$$

is a continuous map. Construct a graph  $\Gamma'$  as follows. First remove all vertices of  $\Gamma_0$  from  $\Gamma$ , and then adjoin  $L$ . Any edge of  $\Gamma$  which points into  $\Gamma_0$  is replaced by an edge pointing to the highest vertex of  $L$ . Any edge pointing out of  $\Gamma_0$  is replaced by an edge starting at the lowest vertex of  $L$ . We extend  $\mathcal{Y}_v$  over all  $v \in V(\Gamma')$  by declaring  $\mathcal{Y}_v = \mathcal{X}_v$  for  $v \in V(\Gamma) \setminus V(\Gamma_0)$ . The map

$$f \otimes \text{id}: \mathcal{X}_\Gamma \rightarrow \mathcal{Y}_{\Gamma'}$$

is continuous.

See Figure 5.2 for a schematic.

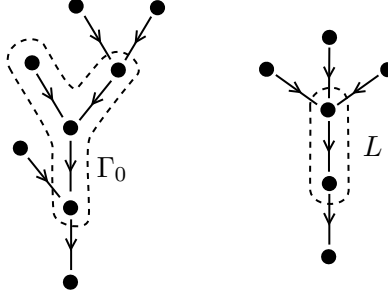

FIGURE 5.2. The operation considered in Proposition 5.23. On the left is  $\Gamma$  and on the right  $\Gamma'$ . The regions enclosed by dashes indicate  $\Gamma_0$  and  $L$ .

*Proof.* We let  $V \subseteq \mathcal{Y}_{\Gamma'}$  be open. Let  $s$  be an admissible labeling of  $\Gamma$ , and let  $\mathbf{p}$  be a point-enhancement of  $s$ . We describe three distinct sets of admissible labelings  $s$ , enumerated as follows:

- (1) ( $p$ -type)  $s|_{\Gamma_0} \equiv p$ .
- (2) ( $\mathcal{O}$ -type)  $s|_{\Gamma_0}$  is not constantly  $p$ , and all edges pointing into  $\Gamma_0$  take value  $p$ .
- (3) ( $X$ -type)  $s|_{\Gamma_0}$  is not constantly  $p$ , and there is at least one edge pointing into  $\Gamma_0$  which takes value  $\mathcal{O}$  or  $X$ .

We break the proof into cases depending on which condition  $s$  satisfies.

Given  $s$ , we now describe one or several admissible labelings  $s'$  on  $\Gamma'$ , depending on which condition is satisfied by  $s$ :

- (1) If  $s$  is  $p$ -type, define a labeling  $s'$  on  $\Gamma'$  which is  $p$  on  $L$ , and agrees with  $s$  elsewhere.
- (2) If  $s$  is  $\mathcal{O}$ -type, we consider  $n = |V(L)|$  labelings  $s'_1, \dots, s'_n$  corresponding to the  $n$  ways of placing an  $\mathcal{O}$  on  $L$ , with  $p$ 's above and  $X$ 's below. We declare  $s'_i$  to agree with  $s$  elsewhere.
- (3) If  $s$  is  $X$  type, we define the labeling  $s'$  to be  $s$  away from  $L$ , and to be constantly  $X$  on  $L$ .

We make the following claims:

- (1) If  $s$  is an admissible labeling of  $\Gamma$  and  $s'$  is a labeling as above (for any of the three cases) then  $s'$  is admissible.
- (2) If  $s$  is  $\mathcal{O}$ -type, then  $s|_{\Gamma_0}$  and  $s'|_L$  are admissible labelings.

We leave it to the reader to verify both of the above two claims, as they are straightforward though somewhat tedious.

Suppose  $s$  is  $X$ -type, and consider the point-enhancement  $\mathbf{p}'$  of  $s'$  obtained by using the points of  $\mathbf{p}$  for vertices in  $V(\Gamma) \setminus V(\Gamma_0)$ . Since  $V$  is open, there is an open-enhancement  $\mathcal{V}_{\mathbf{p}'}$  so that  $\mathcal{W}_{\mathcal{V}_{\mathbf{p}'}, \mathbf{p}'} \subseteq V$ . We pick an open-enhancement of  $s$  and  $\mathbf{p}$  by using the same opens as  $\mathcal{V}_{\mathbf{p}'}$  for  $v \in V(\Gamma) \setminus V(\Gamma_0)$ , as well as the open subspace  $\mathcal{X}_v$  for any  $v \in V(\Gamma_0)$  such that  $s(v) = \mathcal{O}$ . Since  $s'$  labels all vertices of  $L$  by  $X$ , we have

$$(f \otimes \text{id})(\mathcal{W}_{\mathcal{U}_{\mathbf{p}}, \mathbf{p}}) \subseteq \mathcal{W}_{\mathcal{U}_{\mathbf{p}'}, \mathbf{p}'} \subseteq V.$$

The case when  $s$  is  $p$ -type instead is similar, and we leave it to the reader.

We now consider the case that  $s$  is  $\mathcal{O}$ -type. In this case, let  $\mathbf{p}'$  be the points of  $\mathbf{p}$  which lie outside of  $V(\Gamma)$ . Using the definition of an open subspace of  $\mathcal{Y}_{\Gamma'}$ , we observe that there are open subspaces  $U_{w,\mathbf{p}'} \subseteq \mathcal{X}_w$  ranging over  $w \in V(\Gamma) \setminus V(\Gamma_0)$ , as well as an open subspace  $V_{L,\mathbf{p}'} \subseteq \mathcal{Y}_L$  so that if  $\mathcal{W}'$  denotes the tensor product of the  $V_w$ ,  $V_{L,\mathbf{p}'}$  and the span of the tensor of  $\mathbf{p}'$ , then

$$\mathcal{W}' \subseteq V.$$

By continuity, the preimage of under  $f$  of  $V_{L,\mathbf{p}'}$  is open. Since  $s|_{\Gamma_0}$  is admissible, we may find an open-enhancement  $\mathcal{U}_{\Gamma_0,\mathbf{p}}$  of  $s|_{\Gamma_0}$  so that

$$f(\mathcal{W}_{\mathcal{U}_{\Gamma_0,\mathbf{p}},\mathbf{p}_0}) \subseteq V_{L,\mathbf{p}'}$$

Here,  $\mathbf{p}_0$  denotes the elements of  $\mathbf{p}$  for vertices in  $V(\Gamma_0)$ . In particular, we form the open-enhancement  $\mathcal{U}_{\mathbf{p}}$  of  $\mathbf{p}$  consisting of the elements of  $\mathcal{U}_{\Gamma_0,\mathbf{p}}$  (for vertices in  $w \in V(\Gamma_0)$  which have  $s(w) = \mathcal{O}$ ) and the opens  $V_{w,\mathbf{p}'}$  for  $w \in V(\Gamma) \setminus V(\Gamma_0)$  which have  $s(w) = \mathcal{O}$ . By construction,

$$(f \otimes \text{id})(\mathcal{W}_{\mathcal{U}_{\mathbf{p}},\mathbf{p}}) \subseteq V$$

so  $f \otimes \text{id}$  is continuous, and the proof is complete.  $\square$

We highlight an important application of Proposition 5.23:

*Remark 5.24.* If  $\Gamma$  is a strongly directed graph and  $(\mathcal{X}_v)_{v \in V(\Gamma)}$  is a family of spaces, we can form another collection of spaces by “adding parentheses”, in the following sense. Let  $\Gamma_0 \subseteq \Gamma$  be a tree, and consider the tree  $\Gamma/\Gamma_0$  obtained by collapsing to vertices and edges of  $\Gamma_0$  to a single vertex, denoted  $[\Gamma_0]$ . We can define a collection of spaces indexed by  $\Gamma/\Gamma_0$ , by setting  $\mathcal{Y}_v = \mathcal{X}_v$  if  $v \notin V(\Gamma_0)$  and  $\mathcal{Y}_{[\Gamma_0]} = \mathcal{X}_{\Gamma_0}$ . Proposition 5.23 shows that the map

$$\mathcal{X}_{\Gamma} \rightarrow \mathcal{Y}_{\Gamma/\Gamma_0}$$

is continuous.

## 6. THE KNOT SURGERY ALGEBRA

In this section, we introduce our algebras  $\mathcal{K}$  and  $\mathcal{L}$ . We also describe natural filtrations on  $\mathcal{K}$  and  $\mathcal{L}$ . Using these filtrations, we describe our module categories.

**6.1. The algebras  $\mathcal{K}$  and  $\mathcal{L}$ .** We recall the *knot surgery algebra*  $\mathcal{K}$  from the introduction. We define  $\mathcal{K}$  to be an algebra over the idempotent ring

$$\mathbf{I} = \mathbf{I}_0 \oplus \mathbf{I}_1,$$

where each of  $\mathbf{I}_i$  is rank 1 over  $\mathbb{F}_2$ . We write  $i_0$  and  $i_1$  for the generators of  $\mathbf{I}_0$  and  $\mathbf{I}_1$ , respectively. We set

$$\mathbf{I}_0 \cdot \mathcal{K} \cdot \mathbf{I}_0 = \mathbb{F}[\mathcal{U}, \mathcal{V}] \quad \text{and} \quad \mathbf{I}_1 \cdot \mathcal{K} \cdot \mathbf{I}_1 \cong \mathbb{F}[\mathcal{U}, \mathcal{V}, \mathcal{V}^{-1}].$$

Also

$$\mathbf{I}_0 \cdot \mathcal{K} \cdot \mathbf{I}_1 = 0.$$

There are two special algebra elements,  $\sigma, \tau \in \mathbf{I}_1 \cdot \mathcal{K} \cdot \mathbf{I}_0$ . These algebra elements satisfy the relation

$$\sigma \cdot f = I(f) \cdot \sigma \quad \text{and} \quad \tau \cdot f = T(f) \cdot \tau,$$

for  $f \in \mathbb{F}[\mathcal{U}, \mathcal{V}] = \mathbf{I}_0 \cdot \mathcal{K} \cdot \mathbf{I}_0$ . Here  $T: \mathbb{F}[\mathcal{U}, \mathcal{V}] \rightarrow \mathbb{F}[\mathcal{U}, \mathcal{V}, \mathcal{V}^{-1}]$  is the algebra homomorphism satisfying  $T(\mathcal{U}) = \mathcal{V}^{-1}$  and  $T(\mathcal{V}) = \mathcal{U}\mathcal{V}^2$ . The map  $I: \mathbb{F}[\mathcal{U}, \mathcal{V}] \rightarrow \mathbb{F}[\mathcal{U}, \mathcal{V}, \mathcal{V}^{-1}]$  is the canonical inclusion.

In particular,  $\mathbf{I}_1 \cdot \mathcal{K} \cdot \mathbf{I}_0$  is generated by two special algebra elements  $\sigma$  and  $\tau$ , together with the left action of  $\mathbb{F}[\mathcal{U}, \mathcal{V}, \mathcal{V}^{-1}]$ , which satisfy the relations

$$\begin{aligned} \sigma\mathcal{U} &= \mathcal{U}\sigma & \text{and} & & \sigma\mathcal{V} &= \mathcal{V}\sigma \\ \tau\mathcal{U} &= \mathcal{V}^{-1}\tau & \text{and} & & \tau\mathcal{V} &= \mathcal{U}\mathcal{V}^2\tau. \end{aligned}$$

The link algebra  $\mathcal{L}_\ell$  is defined as

$$\mathcal{L}_\ell := \mathcal{K} \otimes_{\mathbb{F}} \cdots \otimes_{\mathbb{F}} \mathcal{K}.$$

We often write just  $\mathcal{L}$ , when  $\ell$  is determined by context. We view  $\mathcal{L}_\ell$  as being an algebra over the idempotent ring

$$\mathbf{E}_\ell := \mathbf{I} \otimes_{\mathbb{F}} \cdots \otimes_{\mathbb{F}} \mathbf{I}.$$

*Remark 6.1.* The algebra  $\mathcal{K}$  admits a more symmetric basis, as follows. We may view  $\mathbf{I}_1 \cdot \mathcal{K} \cdot \mathbf{I}_1$  as being  $\mathbb{F}[U, T, T^{-1}]$ , where  $U = \mathcal{U}\mathcal{V}$  and  $T = \mathcal{V}$ . Then the above relations become

$$\begin{aligned} \sigma\mathcal{U} &= UT^{-1}\sigma & \text{and} & & \sigma\mathcal{V} &= T\sigma \\ \tau\mathcal{U} &= T^{-1}\tau & \text{and} & & \tau\mathcal{V} &= UT\tau. \end{aligned}$$

*Remark 6.2.* The above symmetry may be packaged into an algebra homomorphism

$$\mathcal{E}: \mathcal{K} \rightarrow \mathcal{K},$$

as follows. On  $\mathbf{I}_0 \cdot \mathcal{K} \cdot \mathbf{I}_0$ , we set

$$\mathcal{E}(\mathcal{U}) = \mathcal{V} \quad \text{and} \quad \mathcal{E}(\mathcal{V}) = \mathcal{U}.$$

On  $\mathbf{I}_1 \cdot \mathcal{K} \cdot \mathbf{I}_1$ , we set

$$\mathcal{E}(U) = U \quad \text{and} \quad \mathcal{E}(\mathcal{V}^i) = \mathcal{V}^{-i}.$$

On  $\mathbf{I}_1 \cdot \mathcal{K} \cdot \mathbf{I}_0$ , we set

$$\mathcal{E}(\sigma) = \tau \quad \text{and} \quad \mathcal{E}(\tau) = \sigma.$$

**6.2. Topologies on  $\mathcal{K}$  and  $\mathcal{L}$ .** In this section, we describe the topologies on  $\mathcal{K}$  and  $\mathcal{L}$  which we use throughout the paper.

**Definition 6.3.** Suppose that  $n \in \mathbb{N}$  is fixed. We define  $J_n \subseteq \mathcal{K}$  to be the  $\mathbb{F}$  span of following set of generators:

- (1) In  $\mathbf{I}_0 \cdot \mathcal{K} \cdot \mathbf{I}_0$ , the generators  $\mathcal{U}^i\mathcal{V}^j$ , for  $i \geq n$  or  $j \geq n$  (i.e.  $\max(i, j) \geq n$ ).
- (2) In  $\mathbf{I}_1 \cdot \mathcal{K} \cdot \mathbf{I}_0$ , the generators  $\mathcal{U}^i\mathcal{V}^j\sigma$  for  $i \geq n$  or  $j \geq n$ .
- (3) In  $\mathbf{I}_1 \cdot \mathcal{K} \cdot \mathbf{I}_0$ , the generators  $\mathcal{U}^i\mathcal{V}^j\tau$  for  $j \leq 2i - n$  or  $i \geq n$ .
- (4) In  $\mathbf{I}_1 \cdot \mathcal{K} \cdot \mathbf{I}_1$ , the generators  $\mathcal{U}^i\mathcal{V}^j$  where  $i \geq n$ .

The subspace  $J_n$  is illustrated in Figure 6.1.

We observe that

$$J_0 = \mathcal{K}, \quad J_{n+1} \subseteq J_n, \quad \text{and} \quad \bigcap_{n \in \mathbb{N}} J_n = \{0\}.$$

We will use the subspaces  $J_n$  as a fundamental basis of 0 in our topology on  $\mathcal{K}$ .

For our purposes, the most natural topology on the link algebra is the !-topology:

$$\mathcal{L}_\ell = \mathcal{K} \otimes_{\mathbb{F}}^! \cdots \otimes_{\mathbb{F}}^! \mathcal{K}.$$

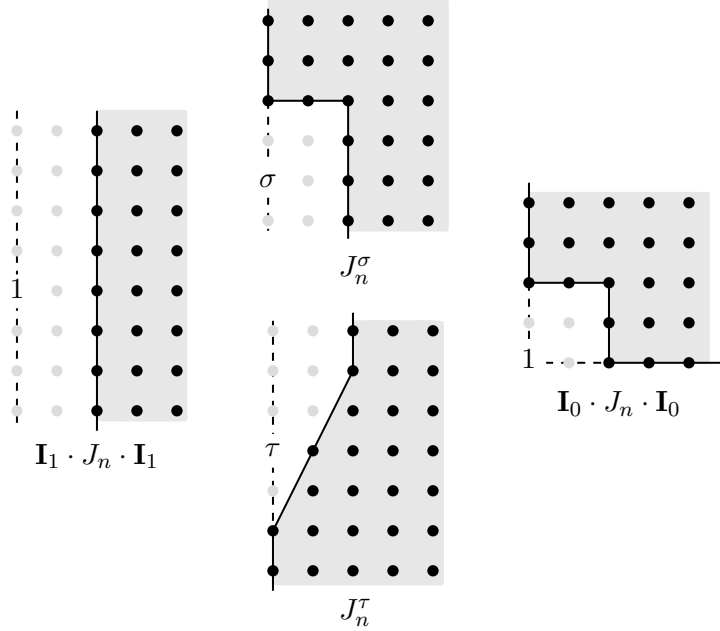

FIGURE 6.1. The subspace  $J_n \subseteq \mathcal{K}$ , indicated by the shaded regions. Here  $J_n^\sigma$  and  $J_n^\tau$  denote the subspaces of  $J_n$  which are in the  $\mathcal{K}$ -span of  $\sigma$  and  $\tau$ . The dots indicate monomials in the algebra. The horizontal direction indicates the power of  $\mathcal{U}$ , and the vertical direction indicates the power of  $\mathcal{V}$ .

This topology first countable, with a basis of opens given by

$$\mathcal{J}_{\ell,n} := \sum_{i=0}^{\ell-1} \mathcal{K}^{\otimes i} \otimes_{\mathbb{F}} J_n \otimes_{\mathbb{F}} \mathcal{K}^{\otimes \ell-i-1} \subseteq \mathcal{L}_{\ell}.$$

A fundamental result to our paper is the following:

**Proposition 6.4.** *The map  $\mu_2: \mathcal{K} \vec{\otimes}_{\mathbb{I}} \mathcal{K} \rightarrow \mathcal{K}$  is continuous.*

*Remark 6.5.* Multiplication is not continuous on  $\mathcal{K} \otimes_{\mathbb{I}}^1 \mathcal{K}$ . As an example  $\mathcal{V}^{-i} \otimes \mathcal{V}^i \sigma \rightarrow 0$  in  $\mathcal{K} \otimes_{\mathbb{I}} \mathcal{K}$  as  $i \rightarrow \infty$ , whereas  $\mu_2(\mathcal{V}^{-i} \otimes \mathcal{V}^i) = \sigma \not\rightarrow 0$ .

Proposition 6.4 follows immediately from the following lemma and the definition of  $\vec{\otimes}$  in Section 5.4:

**Lemma 6.6.** *Let  $J_n \subseteq \mathcal{K}$  be the subspace defined in Equation (6.3).*

- (1) *For all  $n$ ,  $\mu_2(J_n \otimes \mathcal{K}) \subseteq J_n$  (i.e.  $J_n$  is a right ideal of  $\mathcal{K}$ ).*
- (2) *Suppose  $x \in \mathcal{K}$  and  $n \in \mathbb{N}$  are fixed. Then for sufficiently large  $m$ ,*

$$\mu_2(x \otimes J_m) \subseteq J_n.$$

*Proof.* We consider the first claim. We wish to show that  $\mu_2(x \otimes a) \in J_n$  whenever  $x \in J_n$  and  $a \in \mathcal{K}$ . We break the argument into cases, depending on the idempotents of  $x$  and  $a$ . If  $x, a \in \mathbf{I}_1 \cdot \mathcal{K} \cdot \mathbf{I}_1$ , the claim follows because  $w_U(x \cdot a) \geq w_U(x) + w_U(a)$ , where  $w_U$  is the  $U$ -adic weight (i.e.  $w_U(a) = \max\{i : \exists a', a = U^i \cdot a'\}$ ). The same



argument applies if  $x \in \mathbf{I}_1 \cdot \mathcal{K} \cdot \mathbf{I}_1$  and  $a \in \mathbf{I}_1 \cdot \mathcal{K} \cdot \mathbf{I}_0$ . The situation that  $x, a \in \mathbf{I}_0 \cdot \mathcal{K} \cdot \mathbf{I}_0$  is also clear. We now consider the case that  $x \in \mathbf{I}_1 \cdot \mathcal{K} \cdot \mathbf{I}_0$  and  $a \in \mathbf{I}_0 \cdot \mathcal{K} \cdot \mathbf{I}_0$ . Suppose first that  $x = \mathcal{U}^i \mathcal{V}^j \sigma$  and  $a = \mathcal{U}^s \mathcal{V}^t$  (for  $s, t \geq 0$ ). Then  $x \cdot a = \mathcal{U}^{i+s} \mathcal{V}^{j+t} \sigma$ , which is clearly also in  $J_n$ . Similarly, if  $x = \mathcal{U}^i \mathcal{V}^j \tau$  and  $a = \mathcal{U}^s \mathcal{V}^t$ , then

$$x \cdot a = \mathcal{U}^{i+t} \mathcal{V}^{j-s+2t} \tau.$$

By assumption, either  $i \geq n$  or  $j \leq 2i - n$ . If  $i \geq n$ , then  $i + t \geq n$  so  $x \cdot a \in J_n$ . The second case is equivalent to  $2i - j - n \geq 0$ . We note that

$$2(i + t) - (j - s + 2t) - n = s + 2i - j - n \geq 0$$

so  $x \cdot a \in J_n$ . This completes the first part of the claim.

We leave the second claim to the reader, as it may be handled similarly.  $\square$

Combining Corollary 5.14 and Proposition 6.4 we also obtain:

**Corollary 6.7.** *Suppose  $\mathcal{L}$  is topologized as  $\mathcal{K} \otimes^! \cdots \otimes^! \mathcal{K}$ . Then the map*

$$\mu_2: \mathcal{L} \vec{\otimes}_{\mathbf{E}} \mathcal{L} \rightarrow \mathcal{L}$$

*is continuous.*

**6.3. Alexander modules.** In this section, we describe our categories of type- $D$ ,  $A$  and  $DA$  modules. We will refer to these categories as the categories of *Alexander modules*.

**Definition 6.8.** A *type- $D$  Alexander module* consists of a pair  $(\mathcal{X}, \delta^1)$  where  $\mathcal{X}$  is a linear topological right  $\mathbf{E}$ -module and

$$\delta^1: \mathcal{X} \rightarrow \mathcal{X} \vec{\otimes}_{\mathbf{E}} \mathcal{L}$$

is linear topological morphism which satisfies

$$(\text{id} \otimes \mu_2) \circ (\delta^1 \otimes \text{id}_{\mathcal{L}}) \circ \delta^1 = 0.$$

Recall that a linear topological morphism is the same as a continuous linear map on completions. If  $\mathcal{X}^{\mathcal{L}}$  and  $\mathcal{Y}^{\mathcal{L}}$ , we define  $\text{Mor}(\mathcal{X}^{\mathcal{L}}, \mathcal{Y}^{\mathcal{L}})$  to be the space of linear topological morphisms

$$f^1: \mathcal{X} \rightarrow \mathcal{Y} \vec{\otimes}_{\mathbf{E}} \mathcal{L}.$$

We write  $\text{Mod}_{\mathbf{a}}^{\mathcal{K}}$  for the category of Alexander type- $D$  modules.

Type- $A$  Alexander modules are similar:

**Definition 6.9.** A *type- $A$  Alexander module*  $(\mathcal{X}, m_j)$  over  $\mathcal{L}$  consists of a linear topological left  $\mathbf{E}$ -module  $\mathcal{X}$  and a collection of linear topological morphisms

$$m_{j+1}: \mathcal{L} \vec{\otimes}_{\mathbf{E}} \cdots \vec{\otimes}_{\mathbf{E}} \mathcal{L} \vec{\otimes}_{\mathbf{E}} \mathcal{X} \rightarrow \mathcal{X},$$

satisfying the  $A_{\infty}$ -relations.

Type- $DA$  Alexander modules are defined by the obvious amalgamation of the above notions.

**6.4. Split Alexander modules.** We now define the notion of a *split* Alexander type- $A$  or  $DA$  module. Consider the link algebra  $\mathcal{L}_\ell$  and suppose that  $\mathbb{P}$  is a partition of  $\{1, \dots, \ell\}$ . Suppose that  $\mathcal{X}$  is a linear topological left  $\mathbf{E}_\ell$ -module. A  $\mathbb{P}$ -*split continuous* linear topological morphism

$$f_{j+1}: \mathcal{L}_\ell \otimes_{\mathbf{E}} \cdots \otimes_{\mathbf{E}} \mathcal{L}_\ell \otimes_{\mathbf{E}} \mathcal{X} \rightarrow \mathcal{X}$$

is a continuous map on completions, where we give  $\mathcal{T}^j \mathcal{L}_\ell \otimes \mathcal{X}$  a tree shaped topology from Section 5.6, where  $\mathcal{X}$  is the central vertex and we have  $|\mathbb{P}|$ -rays of length  $j$  extending from this vertex. If  $p_1, \dots, p_{|\mathbb{P}|}$  are the sizes of the elements of  $\mathbb{P}$ , then each non-root vertex of the  $i$ -th ray is labeled with  $\mathcal{L}_{p_i}$  (topologized using the  $!$ -topology).

Note that  $\mathbb{P}$ -split continuity is preserved by  $A_\infty$ -composition of such maps by Proposition 5.23.

**Definition 6.10.** Suppose that  $\mathbb{P}$  is a partition of  $\{1, \dots, \ell\}$ . A  $\mathbb{P}$ -*split type- $A$  Alexander module* consists of a linear topological  $\mathbf{E} = \mathbf{E}_\ell$ -module  $\mathcal{X}$ , equipped with a  $\mathbb{P}$ -split linear topological morphism

$$m_{j+1}: \mathcal{L}_\ell \otimes_{\mathbf{E}} \cdots \otimes_{\mathbf{E}} \mathcal{L}_\ell \otimes_{\mathbf{E}} \mathcal{X} \rightarrow \mathcal{X},$$

which satisfies the  $A_\infty$ -module relations.

If  $\mathbb{P}$  is a partition of  $\{1, \dots, \ell\}$  and  $i_1, \dots, i_n$  are the sizes of the partition elements (so  $i_1 + \cdots + i_n = \ell$ ), we will write

$$\mathcal{L}_{i_1 | \cdots | \mathcal{L}_{i_n}} \mathcal{X}$$

for a  $\mathbb{P}$ -split Alexander module.  $\mathbb{P}$ -Split Alexander type- $DA$  modules are defined by the obvious modification.

Once we introduce box tensor products of split Alexander modules, we will prove in Lemma 6.15 that the split-Alexander condition is strictly weaker than the Alexander condition. In particular, any type- $A$  Alexander module  $\mathcal{L}\mathcal{X}$  is also a split type- $A$  Alexander module for any partition.

**6.5. External tensor products.** We now discuss external tensor products, focusing on subtleties involving completions.

We first discuss type- $D$  modules. Suppose that  $\mathcal{X}^{\mathcal{L}_m}$  and  $\mathcal{Y}^{\mathcal{L}_n}$  are type- $D$  Alexander modules. To form the external tensor products, we assume that  $\mathcal{X}$  and  $\mathcal{Y}$  are linearly compact, so that  $\mathcal{X} \vec{\otimes} \mathcal{L}_m \cong \mathcal{X} \otimes^! \mathcal{L}_m$  by Lemma 5.15, and similarly for  $\mathcal{Y} \vec{\otimes} \mathcal{L}_n$ . Under this assumption, we may define the structure map on the tensor product as  $\delta_{\mathcal{X}}^1 \otimes \text{id}_{\mathcal{Y}} \otimes 1_{\mathcal{L}_n} + \text{id}_{\mathcal{X}} \otimes 1_{\mathcal{L}_m} \otimes \delta_{\mathcal{Y}}^1$ , with tensor factors reordered, as indicated below:

$$\mathcal{X} \otimes^! \mathcal{Y} \rightarrow (\mathcal{X} \vec{\otimes} \mathcal{L}_m) \otimes^! (\mathcal{Y} \vec{\otimes} \mathcal{L}_n) \cong \mathcal{X} \otimes^! \mathcal{L}_m \otimes^! \mathcal{Y} \otimes^! \mathcal{L}_n \cong (\mathcal{X} \otimes^! \mathcal{Y}) \vec{\otimes} (\mathcal{L}_m \otimes^! \mathcal{L}_n).$$

Next, we consider tensoring (split) type- $A$  modules. Suppose that  $\mathbb{P}$  is a partition of  $\{1, \dots, s\}$  and  $\mathbb{P}'$  is a partition of  $\{1, \dots, r\}$ . Let us write  $i_1, \dots, i_m$  for the sizes of the elements of  $\mathbb{P}$ , and  $j_1, \dots, j_n$  for those of  $\mathbb{P}'$ . Suppose that we have  $\mathbb{P}$  and  $\mathbb{P}'$  split modules

$$\mathcal{L}_{i_1 | \cdots | \mathcal{L}_{i_m}} \mathcal{X} \quad \text{and} \quad \mathcal{L}_{j_1 | \cdots | \mathcal{L}_{j_n}} \mathcal{Y}.$$

We will describe two versions of the external tensor product, namely

$$\mathcal{L}_{i_1 | \cdots | \mathcal{L}_{i_m+j_1} | \cdots | \mathcal{L}_{j_n}} (\mathcal{X} \otimes^! \mathcal{Y}) \quad \text{and} \quad \mathcal{L}_{i_1 | \cdots | \mathcal{L}_{i_m} | \mathcal{L}_{j_1} | \cdots | \mathcal{L}_{j_n}} (\mathcal{X} \otimes^! \mathcal{Y}).$$

We topologize  $\mathcal{T}^j \mathcal{L}_{r+s} \otimes \mathcal{X} \otimes \mathcal{Y}$  using the tree topology for a star with  $m+n-1$  (resp.  $m+n$  rays). We label the root  $\mathcal{X} \otimes^! \mathcal{Y}$ , and we label each other vertex with a  $\otimes^!$ -tensor product of copies of  $\mathcal{K}$ .

To construct the external tensor product, one must also pick a cellular diagonal of the associahedron. This construction is recalled in Section 3.5. The fact that the external tensor product behaves well with completions is implied by the following result:

**Proposition 6.11.** *Suppose that  $\mathbb{P}$  and  $\mathbb{P}'$  are partitions of  $\{1, \dots, r\}$  and  $\{1, \dots, s\}$ , respectively, and that*

$$f_{j+1}: \mathcal{T}^j \mathcal{L}_r \otimes \mathcal{X} \rightarrow \mathcal{X} \quad \text{and} \quad g_{j+1}: \mathcal{T}^j \mathcal{L}_s \otimes \mathcal{Y} \rightarrow \mathcal{Y}$$

are  $\mathbb{P}$  and  $\mathbb{P}'$  split continuous, then their tensor product  $f_{j+1} \otimes g_{j+1}$  is both  $\mathbb{P} \sqcup \mathbb{P}'$  and  $(\mathbb{P} \sqcup \mathbb{P}')_{p \sim p'}$  split continuous, for any  $p \in \mathbb{P}$  and  $p' \in \mathbb{P}'$ . (Here we write  $(\mathbb{P} \sqcup \mathbb{P}')_{p \sim p'}$  for the partition obtained by merging  $p$  and  $p'$  in  $\mathbb{P} \sqcup \mathbb{P}'$ ).

We will prove Proposition 6.11 for the module  $\mathcal{L}_{i_1 | \dots | \mathcal{L}_{i_m+j_1} | \dots | \mathcal{L}_{j_n}}(\mathcal{X} \otimes^! \mathcal{Y})$ . We will later see in Lemma 6.15 that the module  $\mathcal{L}_{i_1 | \dots | \mathcal{L}_{i_m} | \mathcal{L}_{j_1} | \dots | \mathcal{L}_{j_n}}(\mathcal{X} \otimes^! \mathcal{Y})$  is a box tensor product of this module with a split Alexander bimodule  $\mathcal{L}_{i_m | \mathcal{L}_{j_1}}[\mathbb{I}]^{\mathcal{L}_{i_m+j_1}}$ , and hence is also a split Alexander module.

The proof Proposition 6.11 is an immediate consequence of the following general result about tree topologies:

**Lemma 6.12.** *Let  $\Gamma_n^k$  denote the star which has  $n$  rays of length  $k$ , which all point towards a root vertex  $v_0$ . Let  $(\mathcal{X}_v)_{v \in V(\Gamma_n^k)}$  and  $(\mathcal{Y}_v)_{v \in V(\Gamma_m^k)}$  denote two families of spaces. Pick a distinguished ray from each of  $\Gamma_n^k$  and  $\Gamma_m^k$ . Form a new collection of spaces  $(\mathcal{Z}_v)_{v \in \Gamma_{m+n-1}^k}$  as follows. View  $\Gamma_{m+n-1}^k$  as being obtained by merging vertices of the same height along the distinguished rays. We define  $\mathcal{Z}_v$  to be either  $\mathcal{X}_v$  or  $\mathcal{Y}_v$  for  $v$  not along the merged ray. For  $v$  along the merged ray, we define  $\mathcal{Z}_v$  to be  $\mathcal{X}_v \otimes^! \mathcal{Y}_v$ . Then the natural map*

$$\mathcal{Z}_{\Gamma_{m+n-1}^k} \rightarrow \mathcal{X}_{\Gamma_n^k} \otimes^! \mathcal{Y}_{\Gamma_m^k}$$

is continuous.

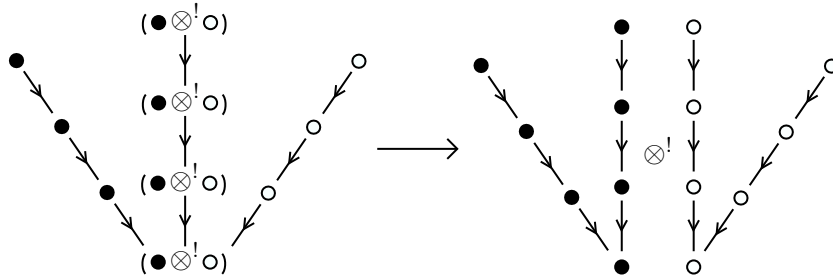

FIGURE 6.2. A schematic of Lemma 6.12. Solid dots denote  $\mathcal{X}_v$  and open dots denote  $\mathcal{Y}_v$ .

*Proof.* We abbreviate  $\mathcal{X}_{\Gamma_n^k}$ ,  $\mathcal{Y}_{\Gamma_m^k}$  and  $\mathcal{Z}_{\Gamma_{m+n-1}^k}$  by  $\mathcal{X}$ ,  $\mathcal{Y}$  and  $\mathcal{Z}$ , respectively.

Let

$$U_{\mathcal{X}} \otimes \mathcal{Y} + \mathcal{X} \otimes V_{\mathcal{Y}} \subseteq \mathcal{X}_{\Gamma_n^k} \otimes^! \mathcal{Y}_{\Gamma_m^k}$$

be an open subspace, where  $U_{\mathcal{X}}$  and  $V_{\mathcal{Y}}$  are open subspaces.

Let  $s$  be an admissible labeling of  $\Gamma_{n+m-1}^k$ . There are two induced admissible labelings  $s_{\mathcal{X}}$  and  $s_{\mathcal{Y}}$  of  $\Gamma_n^k$  and  $\Gamma_m^k$ , obtained by restricting  $s$ .

Suppose that  $\mathbf{p}$  is a point-enhancement of  $s$ . We obtain a finite sum of point-enhancements  $\mathbf{p}_{\mathcal{X},i}, \mathbf{p}_{\mathcal{Y},j}$  for  $s_{\mathcal{X}}$  and  $s_{\mathcal{Y}}$ , corresponding to decomposing points in tensor products along the merged ray into elementary tensors. To simplify the notation, assume that there each point of  $\mathbf{p}$  along the merged ray consists of an elementary tensor, so that we obtain just two point-enhancements  $\mathbf{p}_{\mathcal{X}}$  and  $\mathbf{p}_{\mathcal{Y}}$ .

Along the merged ray, there is at most one vertex  $v$  for which  $s(v) = \mathcal{O}$ . If there is no vertex along this ray for which  $s(v) = \mathcal{O}$ , then  $s$  takes value  $X$  at the root, and value  $p$  at all other vertices on this ray.

Consider first the case that  $s$  does not take the value  $\mathcal{O}$  along the merged ray. By definition, there are open-enhancements  $\mathcal{U}_{\mathbf{p}_{\mathcal{X}}}$  and  $\mathcal{V}_{\mathbf{p}_{\mathcal{Y}}}$  so that

$$\mathcal{W}_{\mathcal{U}_{\mathbf{p}_{\mathcal{X}}}, \mathbf{p}_{\mathcal{X}}} \subseteq U_{\mathcal{X}} \quad \text{and} \quad \mathcal{W}_{\mathcal{V}_{\mathbf{p}_{\mathcal{Y}}}, \mathbf{p}_{\mathcal{Y}}} \subseteq U_{\mathcal{Y}}.$$

We define an open-enhancement  $\mathcal{E}_{\mathbf{p}}$  of  $s$  to be the union of  $\mathcal{U}_{\mathbf{p}_{\mathcal{X}}}$  and  $\mathcal{V}_{\mathbf{p}_{\mathcal{Y}}}$ . We observe that

$$\mathcal{W}_{\mathcal{E}_{\mathbf{p}}, \mathbf{p}} = \mathcal{W}_{\mathcal{U}_{\mathbf{p}_{\mathcal{X}}}, \mathbf{p}_{\mathcal{X}}} \otimes \mathcal{W}_{\mathcal{V}_{\mathbf{p}_{\mathcal{Y}}}, \mathbf{p}_{\mathcal{Y}}} \subseteq U_{\mathcal{X}} \otimes \mathcal{Y} + \mathcal{X} \otimes V_{\mathcal{Y}}.$$

Next, we consider the case that there is some  $v_0$  along the merged ray where  $s(v) = \mathcal{O}$ . In this case, we form  $p_{\mathcal{X}}, p_{\mathcal{Y}}, s_{\mathcal{X}}$  and  $s_{\mathcal{Y}}$  as above.

We let  $\mathcal{U}_{\mathbf{p}_{\mathcal{X}}}$  and  $\mathcal{V}_{\mathbf{p}_{\mathcal{Y}}}$  be open-enhancements, as above. We define an open-enhancement  $\mathcal{E}_{\mathbf{p}}$  of  $\mathbf{p}$  to consist of the opens from  $\mathcal{U}_{\mathbf{p}_{\mathcal{X}}}$  and  $\mathcal{V}_{\mathbf{p}_{\mathcal{Y}}}$  for the vertices  $v \neq v_0$ . For  $v_0$ , we use the open subspace

$$U_{\mathbf{p}_{\mathcal{X}}, u_0} \otimes \mathcal{Y}_{w_0} + \mathcal{X}_{u_0} \otimes V_{\mathbf{p}_{\mathcal{Y}}, w_0}$$

where  $u_0$  and  $w_0$  are the vertices of  $\Gamma_n^k$  and  $\Gamma_m^k$  which correspond to  $v_0$ . We observe that

$$\mathcal{W}_{\mathcal{E}_{\mathbf{p}}, \mathbf{p}} \subseteq \mathcal{W}_{\mathcal{U}_{\mathbf{p}_{\mathcal{X}}}, \mathbf{p}_{\mathcal{X}}} \otimes \mathcal{Y} + \mathcal{X} \otimes \mathcal{W}_{\mathcal{V}_{\mathbf{p}_{\mathcal{Y}}}, \mathbf{p}_{\mathcal{Y}}} \subseteq U_{\mathcal{X}} \otimes \mathcal{Y} + \mathcal{X} \otimes V_{\mathcal{Y}}.$$

Therefore the preimage of  $U_{\mathcal{X}} \otimes \mathcal{Y} + \mathcal{X} \otimes V_{\mathcal{Y}}$  is open, and so the map  $\mathcal{Z} \rightarrow \mathcal{X} \otimes \mathcal{Y}$  is continuous.  $\square$

Taking the external tensor product of two type- $DA$  Alexander modules, when the underlying spaces of the modules are linearly compact, is a straightforward extension.

*Remark 6.13.* We can see more directly that if  $\mathcal{L}_i \mathcal{X}$  and  $\mathcal{L}_j \mathcal{Y}$  are type- $A$  Alexander modules, then  $\mathcal{L}_{i+j}(\mathcal{X} \otimes^! \mathcal{Y})$  is also an Alexander module. Consider two continuous maps

$$f_{j+1}: \vec{\mathcal{T}}^j \mathcal{L}_n \vec{\otimes} \mathcal{X} \rightarrow \mathcal{X} \quad \text{and} \quad g_{j+1}: \vec{\mathcal{T}}^j \mathcal{L}_m \vec{\otimes} \mathcal{X} \rightarrow \mathcal{X}$$

The external tensor product of  $f_{j+1}$  and  $g_{j+1}$  is continuous since it may be written as the following sequence of continuous maps:

$$\begin{aligned} & \vec{\mathcal{T}}^j (\mathcal{L}_n \otimes^! \mathcal{L}_m) \vec{\otimes} (\mathcal{X} \otimes^! \mathcal{Y}) \\ & \rightarrow \left( \vec{\mathcal{T}}^j \mathcal{L}_n \vec{\otimes} \mathcal{X} \right) \otimes^! \left( \vec{\mathcal{T}}^j \mathcal{L}_m \vec{\otimes} \mathcal{Y} \right) \\ & \rightarrow \mathcal{X} \otimes^! \mathcal{Y}. \end{aligned}$$

The first map is from Corollary 5.14 and the second map is  $f_{j+1} \otimes g_{j+1}$ .

**6.6. Box tensor products.** In this section, we describe the interaction of Lipshitz, Ozsváth and Thurston's box tensor product operation with Alexander modules. The simplest case is boxing an Alexander type- $D$  module  $\mathcal{X}^{\mathcal{L}}$  with an Alexander type- $A$  module  $\mathcal{L}\mathcal{Y}$ . In this case,

$$\delta^1: \mathcal{X} \rightarrow \mathcal{X} \vec{\otimes}_{\mathbb{E}} \mathcal{L} \quad \text{and} \quad m_{j+1}: \mathcal{L} \vec{\otimes}_{\mathbb{E}} \cdots \vec{\otimes}_{\mathbb{E}} \mathcal{L} \vec{\otimes}_{\mathbb{E}} \mathcal{Y} \rightarrow \mathcal{Y},$$

are continuous linear maps on the completions. Hence, assuming an appropriate boundedness condition so that only finitely many terms contribute to the box tensor product (e.g.  $m_j = 0$  for  $j \gg 0$ ), the differential  $\partial^{\boxtimes}$  will be a sum of finitely many continuous maps. Type- $DA$  modules present no additional complications.

Box tensor products involving split Alexander type- $A$  and  $DA$  modules is more subtle. If  ${}_{\mathcal{L}_{i_1}|\dots|\mathcal{L}_{i_n}}\mathcal{Y}$  is a split Alexander type- $A$  module, it seems only possible to tensor with an Alexander type- $D$  module which is itself an external tensor product of  $n$  modules

$$\mathcal{X}_1^{\mathcal{L}_{i_1}}, \dots, \mathcal{X}_n^{\mathcal{L}_{i_n}}.$$

In this case, we write

$$(\mathcal{X}_1^{\mathcal{L}_{i_1}}, \dots, \mathcal{X}_n^{\mathcal{L}_{i_n}}) \hat{\boxtimes}_{\mathcal{L}_{i_1}|\dots|\mathcal{L}_{i_n}} \mathcal{Y}$$

for the resulting tensor product. Ignoring completions, the tensor product is formed by taking the external tensor product of the type- $D$  modules  $\mathcal{X}_j^{\mathcal{L}_{i_j}}$  to obtain a type- $D$  module over  $\mathcal{L}_{i_1+\dots+i_n}$ . This type- $D$  module is then tensored with the type- $A$  module using the standard definition (see Equation (3.1)). We topologize the underlying space of the tensor product

$$(\mathcal{X}_1 \otimes \cdots \otimes \mathcal{X}_n) \otimes \mathcal{Y}$$

using the graph topology from Section 5.6 for a tree with one root and  $n$  rays. Here,  $\mathcal{Y}$  is labeled as the root, and  $\mathcal{X}_1, \dots, \mathcal{X}_n$  each form a ray, with an edge pointing to  $\mathcal{Y}$ . Proposition 5.23 shows that the structure operations are continuous.

We may also form the tensor product when  $\mathcal{Y}$  or some of the  $\mathcal{X}_i$  are split  $DA$  Alexander bimodules. The output will be a split Alexander  $DA$ -bimodule, whose tensor splitting of the incoming algebras is the concatenation of the tensor-splittings for each of the  $\mathcal{X}_i$ . To illustrate, if  ${}_{\mathcal{L}_{i_1}|\mathcal{L}_{i_2}}\mathcal{Y}^{\mathcal{L}}$ ,  ${}_{\mathcal{L}_{j_1}|\dots|\mathcal{L}_{j_m}}\mathcal{X}_1^{\mathcal{L}_{i_1}}$  and  ${}_{\mathcal{L}_{k_1}|\dots|\mathcal{L}_{k_t}}\mathcal{X}_2^{\mathcal{L}_{i_2}}$  are split Alexander  $DA$ -bimodules, then their tensor product,  $N$ , will be a split module as indicated in the following equation:

$$\left( {}_{\mathcal{L}_{j_1}|\dots|\mathcal{L}_{j_m}}\mathcal{X}_1^{\mathcal{L}_{i_1}}, {}_{\mathcal{L}_{k_1}|\dots|\mathcal{L}_{k_t}}\mathcal{X}_2^{\mathcal{L}_{i_2}} \right) \hat{\boxtimes}_{\mathcal{L}_{i_1}|\mathcal{L}_{i_2}} \mathcal{Y}^{\mathcal{L}} = {}_{\mathcal{L}_{j_1}|\dots|\mathcal{L}_{j_m}|\mathcal{L}_{k_1}|\dots|\mathcal{L}_{k_t}} N^{\mathcal{L}}.$$

*Remark 6.14.* The box tensor product operation of split Alexander modules is most natural when the underlying vector spaces of our modules are linearly compact. In this case, the underlying vector spaces of a tensor product  $(\mathcal{X}^{\mathcal{K}}, \mathcal{Y}^{\mathcal{K}}) \hat{\boxtimes}_{\mathcal{K}|\mathcal{K}} \mathcal{Z}$  is the standard tensor product  $\mathcal{X} \otimes^! \mathcal{Y} \otimes^! \mathcal{Z}$  by Lemma 5.15. Furthermore, assuming linear compactness, the completed box tensor product operation satisfies the following associativity property:

$$(\mathcal{X}^{\mathcal{K}}, \mathcal{Y}^{\mathcal{K}}) \hat{\boxtimes}_{\mathcal{K}|\mathcal{K}} \mathcal{Z} \cong \mathcal{X}^{\mathcal{K}} \hat{\boxtimes}_{\mathcal{K}} ((\mathcal{K} \mathbb{I}^{\mathcal{K}}, \mathcal{Y}^{\mathcal{K}}) \hat{\boxtimes}_{\mathcal{K}|\mathcal{K}} \mathcal{Z}) \cong \mathcal{Y}^{\mathcal{K}} \hat{\boxtimes}_{\mathcal{K}} ((\mathcal{X}^{\mathcal{K}}, \mathcal{K} \mathbb{I}^{\mathcal{K}}) \hat{\boxtimes}_{\mathcal{K}|\mathcal{K}} \mathcal{Z}).$$

Note that all of the bordered link surgery modules considered in this paper are countable direct products of  $\mathbb{F}$ , so are linearly compact.

As an example, we now describe a split type- $DA$  Alexander bimodule  ${}_{\mathcal{K}|\mathcal{K}}[\mathbb{I}]^{\mathcal{L}_2}$  which transforms any Alexander module  ${}_{\mathcal{L}_2}\mathcal{X}$  into a split module  ${}_{\mathcal{K}|\mathcal{K}}\mathcal{X}$ . The structure maps are the same as for the identity module.

**Lemma 6.15.** *The bimodule  ${}_{\mathcal{K}|\mathcal{K}}[\mathbb{I}]^{\mathcal{L}_2}$  is a split Alexander bimodule. More generally, if  $\mathbb{P}$  is a partition of  $\{1, \dots, \ell\}$ , and  $\ell_1, \dots, \ell_j$  are the sizes of the partition elements, then  ${}_{\mathcal{L}_{\ell_1}|\dots|\mathcal{L}_{\ell_j}}[\mathbb{I}]^{\mathcal{L}_\ell}$  is a split Alexander bimodule.*

*Proof.* Consider first  ${}_{\mathcal{K}|\mathcal{K}}[\mathbb{I}]^{\mathcal{L}_2}$ . In this case, the claim follows from Remark 5.22 and the fact that the natural map

$$\mathcal{K} \otimes_{\mathbb{F}}^* \mathcal{K} \rightarrow \mathcal{K} \otimes_{\mathbb{F}}^! \mathcal{K}$$

is continuous. The case of general  $\ell$  and  $\mathbb{P}$  is proven by the same argument.  $\square$

*Remark 6.16.* Lemma 6.15 implies that the ordinary Alexander module condition is stronger than the split Alexander module condition. In particular, given a type- $A$  Alexander module  ${}_{\mathcal{L}_\ell}\mathcal{X}$ , we may always view  $\mathcal{X}$  as a split Alexander module for any partition of  $\{1, \dots, \ell\}$ .

**6.7. Finitely generated  $\mathcal{K}$ -modules.** In this section, we discuss the category of finitely generated type- $D$  modules over  $\mathcal{L}$ .

We denote by  $\mathcal{K}$  the completion of the algebra  $\mathcal{K}$  with respect to the topology described above. As a vector space, we have the following isomorphisms:

$$\begin{aligned} \mathbf{I}_0 \cdot \mathcal{K} \cdot \mathbf{I}_0 &\cong \mathbb{F}[[\mathcal{U}, \mathcal{V}]] \\ \mathbf{I}_1 \cdot \mathcal{K} \cdot \mathbf{I}_0 &\cong \mathbb{F}[\mathcal{V}, \mathcal{V}^{-1}][[\mathcal{U}]]\langle\tau\rangle \oplus \mathbb{F}[\mathcal{V}, \mathcal{V}^{-1}][[\mathcal{U}]]\langle\sigma\rangle \\ \mathbf{I}_1 \cdot \mathcal{K} \cdot \mathbf{I}_1 &\cong \mathbb{F}[\mathcal{V}, \mathcal{V}^{-1}][[\mathcal{U}]]. \end{aligned}$$

We may consider the completion of the link algebra  $\mathcal{L}$  as well.

Since multiplication is continuous by Proposition 6.4 and Corollary 6.7, we obtain a well-defined map on the completed algebras

$$\mu_2: \mathcal{L} \overset{\vec{\otimes}}{\otimes}_{\mathbb{E}} \mathcal{L} \rightarrow \mathcal{L}$$

Since  $\mathcal{L}$  is an algebra, we may also consider the ordinary category of type- $D$  modules over this algebra (i.e. ordinary modules and algebras, with no topologies). Of particular interest to us is the category of finitely generated type- $D$  modules. We write  $\text{Mod}_{fg}^{\mathcal{L}}$  for this category.

There is a related category,  $\text{Mod}_{fg,a}^{\mathcal{L}}$ , consisting of Alexander type- $D$  modules over  $\mathcal{L}$  which are finitely generated over  $\mathbb{F}$ .

**Proposition 6.17.** *The categories  $\text{Mod}_{fg,a}^{\mathcal{L}}$  and  $\text{Mod}_{fg}^{\mathcal{L}}$  are equivalent.*

*Proof.* We define functors in both directions. The functor

$$F: \text{Mod}_{fg,a}^{\mathcal{L}} \rightarrow \text{Mod}_{fg}^{\mathcal{L}}$$

is obtained by taking completions, noting that the completion of  $\mathcal{X} \otimes \mathcal{L}$  coincides with  $\mathcal{X} \otimes \mathcal{L}$  when  $\mathcal{X}$  is finitely generated. (Note that when  $\mathcal{X}$  is finite dimensional,  $\mathcal{X} \cong \mathcal{X}$  if and only if  $\mathcal{X}$  is Hausdorff).

The functor

$$G: \text{Mod}_{fg}^{\mathcal{L}} \rightarrow \text{Mod}_{fg,a}^{\mathcal{L}}$$

sends a type- $D$  module  $(\mathcal{X}, \delta^1)$  to itself, where  $\mathcal{X}$  is equipped with the discrete topology. This is well-defined due to the fact that if  $\mathcal{X}$  and  $\mathcal{Y}$  are equipped with the discrete topology, then a map

$$f^1: \mathcal{X} \rightarrow \mathcal{Y} \vec{\otimes} \mathcal{L}$$

is automatically continuous, since  $\{0\} \subseteq \mathcal{X}$  is open. We observe that  $F \circ G$  is the identity functor.

On the other hand,  $G \circ F$  maps  $(\mathcal{X}, \delta^1)$  to  $(\mathcal{X}, \delta^1)$ . Note that in the category  $\text{LTS}_{\mathbb{E}}$ , these objects are canonically isomorphic, since morphisms are continuous linear maps on completions. See Definition 5.4 and Remark 5.5. In particular, there is a natural transformation from  $G \circ F$  to the identity. The proof is complete.  $\square$

## 7. THE LINK SURGERY FORMULA

In this section, we give some background on the link surgery formula of Manolescu and Ozsváth [MO10], and prove some important preliminary results.

**7.1. Statement of the link surgery formula.** In this section, we state Manolescu and Ozsváth's link surgery formula. We will describe more detail about the construction in Section 9.

If  $L \subseteq S^3$  is a link, write  $K_1, \dots, K_\ell$  for the components of  $L$ . Manolescu and Ozsváth define the affine lattice over  $\mathbb{Z}^\ell$

$$\mathbb{H}(L) := \prod_{i=1}^{\ell} (\text{lk}(K_i, L - K_i)/2 + \mathbb{Z}).$$

Whenever  $M \subseteq L$ , Manolescu and Ozsváth define a reduction map

$$\psi^M: \mathbb{H}(L) \rightarrow \mathbb{H}(L - M).$$

Manolescu and Ozsváth also define a version of the map  $\psi^M$  for oriented sublinks of  $L$ . See [MO10, Section 3.7]. In our work, we only need the case where  $M$  is consistently oriented to  $L$ .

**Definition 7.1.** A Heegaard link diagram  $(\Sigma, \boldsymbol{\alpha}, \boldsymbol{\beta}, \mathbf{w}, \mathbf{z})$  for  $(Y, L)$  is *link minimal* if each link component of  $L$  has exactly two basepoints on it.

Let  $\mathcal{H} = (\Sigma, \boldsymbol{\alpha}, \boldsymbol{\beta}, \mathbf{w}, \mathbf{z})$  be a link-minimal Heegaard diagram for an oriented link  $L \subseteq S^3$ . If  $M \subseteq L$ , we write  $\mathcal{H}^{L-M}$  for the diagram obtained by deleting  $z_i \in \mathbf{z}$  for each component  $K_i \subseteq L$ . Note that Manolescu also define a reduction  $\mathcal{H}^{L-\vec{M}}$  when  $\vec{M}$  is equipped with an orientation. In this case, we delete  $z_i$  for each positively oriented component of  $M$ , and we delete  $w_i$  for each negatively oriented component of  $M$ .

Recall that if  $(\Sigma, \boldsymbol{\alpha}, \boldsymbol{\beta}, \mathbf{w}, \mathbf{z})$  is a link-minimal Heegaard link diagram for  $L$ , then there is an  $\ell$ -component Alexander grading

$$A = (A_1, \dots, A_\ell): \mathbb{T}_\alpha \cap \mathbb{T}_\beta \rightarrow \mathbb{H}(L).$$

Suppose  $\mathcal{H}$  is a link minimal Heegaard diagram for  $L \subseteq S^3$  and  $\mathcal{H}$  has no free basepoints. If  $\mathbf{s} \in \mathbb{H}(L)$ , then Manolescu and Ozsváth define

$$\mathfrak{A}^-(\mathcal{H}^{L-M}, \mathbf{s})$$

to be the free  $\mathbb{F}[[U_1, \dots, U_n]]$ -module generated by monomials

$$U_1^{i_1} \dots U_n^{i_n} \cdot \mathbf{x}$$

where  $\mathbf{x} \in \mathbb{T}_\alpha \cap \mathbb{T}_\beta$ , which satisfy  $i_j \geq 0$  for all  $j$ , and  $A_j(\mathbf{x}) \leq s_j + i_j$  whenever  $K_j \subseteq L - M$ . Manolescu and Ozsváth equip  $\mathfrak{A}^-(\mathcal{H}^L, \mathbf{s})$  with the differential which counts Maslov index 1 holomorphic disks, weighted by the product of  $U_i^{n_{w_i}(\phi)}$ .

We will also occasionally write

$$A^-(\mathcal{H}^L, \mathbf{s})$$

for the free  $\mathbb{F}[U_1, \dots, U_n]$ -module which has the same generators as  $\mathfrak{A}^-(\mathcal{H}^L, \mathbf{s})$ .

Let  $\Lambda$  denote an integral framing on  $L$ . The underlying group of the link surgery complex is defined to be

$$\mathcal{C}_\Lambda(L) = \bigoplus_{M \subseteq L} \prod_{\mathbf{s} \in \mathbb{H}(L)} \mathfrak{A}^-(\mathcal{H}^{L-M}, \psi^M(\mathbf{s})).$$

The differential  $\mathcal{D}: \mathcal{C}_\Lambda(L) \rightarrow \mathcal{C}_\Lambda(L)$  decomposes as a sum

$$\mathcal{D} = \sum_{N \subseteq L} \sum_{\vec{N} \in \Omega(N)} \Phi^{\vec{N}},$$

where  $\Omega(N)$  denotes the set of orientations on  $N$ .

Given an oriented sublink  $\vec{N} \subseteq L$  (with orientation potentially different than  $L$ ), Manolescu and Ozsváth define

$$\Lambda_{L, \vec{N}} \in \mathbb{Z}^\ell$$

to be the sum of the longitudes of the negatively oriented components of  $\vec{N}$ , under the canonical isomorphism  $H_1(S^3 \setminus L) \cong \mathbb{Z}^\ell$ .

Suppose  $\vec{N} \subseteq L$  is an oriented sublink, and that  $L_0 \subseteq L$  is a sublink which contains  $N$ . Write  $L_1 = L_0 - N$ . In this case, the summand  $\Phi^{\vec{N}}$  of  $\mathcal{D}$  maps  $\mathfrak{A}^-(\mathcal{H}^{L_0}, \psi^{L-L_0}(\mathbf{s}))$  to  $\mathfrak{A}^-(\mathcal{H}^{L_1}, \psi^{L-L_1}(\mathbf{s} + \Lambda_{L, \vec{N}}))$ .

We write  $\Phi_{L_0, L_1}^{\vec{N}}$  for the component of  $\Phi^{\vec{N}}$  as follows:

$$\Phi_{L_0, L_1}^{\vec{N}}: \prod_{\mathbf{s} \in \mathbb{H}(L)} \mathfrak{A}^-(\mathcal{H}^{L_0}, \psi^{L-L_0}(\mathbf{s})) \rightarrow \prod_{\mathbf{s} \in \mathbb{H}(L)} \mathfrak{A}^-(\mathcal{H}^{L_1}, \psi^{L-L_1}(\mathbf{s} + \Lambda_{L, \vec{N}})).$$

Finally, we note that it is often convenient to view  $\mathcal{C}_\Lambda(L, \mathcal{A})$  as a one dimensional mapping cone, so we establish some notation for this purpose. If  $J \subseteq L$  is a component, and  $\nu \in \{0, 1\}$ , then we write  $\mathcal{C}_\Lambda^\nu(L)$  for the subcube consisting of  $\mathcal{C}_\varepsilon \subseteq \mathcal{C}_\Lambda(L, \mathcal{A})$  ranging over  $\varepsilon$  with  $J$  component equal to  $\nu$ . We may decompose

$$\mathcal{C}_\Lambda(L) \cong \text{Cone} \left( \mathcal{C}_\Lambda^0(L) \xrightarrow{F^J + F^{-J}} \mathcal{C}_\Lambda^1(L) \right).$$

In the above,  $F^J$  (resp.  $F^{-J}$ ) denotes the sum of  $\Phi^{\vec{N}}$  for every oriented sublink  $\vec{N}$  of  $L$  such that  $K \subseteq \vec{N}$  (resp.  $-K \subseteq \vec{N}$ ).

We will review the construction of the hypercube maps  $\Phi^{\vec{N}}$  in more detail in Section 9.

**7.2. Gradings and algebraic reduction maps.** In this section, we state several grading formulas which are useful when working with the link surgery formula.

**Definition 7.2.** Suppose that  $\mathcal{H} = (\Sigma, \alpha, \beta, \mathbf{w}, \mathbf{z})$  is a link minimal Heegaard diagram. We call a subset  $\mathcal{W} \subseteq \mathbf{w} \cup \mathbf{z}$  a *complete set of basepoints* on  $\mathcal{H}$  if  $\mathcal{W}$  contains each free basepoint on  $\mathcal{H}$  and  $\mathcal{W}$  contains exactly one basepoint from each link component.



Suppose  $\mathcal{H}$  is a diagram for a link  $L$  in  $Y$ , each of whose components is null-homologous, and  $\mathfrak{s} \in \text{Spin}^c(Y)$  is torsion. Given a complete set of basepoints  $\mathcal{W}$  on  $\mathcal{H}$ , there is a well defined Maslov grading  $\text{gr}_{\mathcal{W}}$  on  $\mathcal{CFL}(\mathcal{H}, \mathfrak{s})$ . The grading  $\text{gr}_{\mathcal{W}}$  is induced from the absolute grading of  $CF^-(Y, \mathcal{W}, \mathfrak{s})$  by declaring the natural quotient map  $\mathcal{CFL}(\mathcal{H}, \mathfrak{s}) \rightarrow CF^-(Y, \mathcal{W}, \mathfrak{s})$  to be grading preserving. There is also an  $\ell$ -component Alexander grading  $A^{\mathcal{W}} = (A_1^{\mathcal{W}}, \dots, A_{\ell}^{\mathcal{W}})$ . Note that a complete set of basepoints also determines an orientation on  $L$ , via the convention that  $L$  intersects the Heegaard surface  $\Sigma$  negatively at  $\mathcal{W}$ . In particular, we may equivalently specify the Alexander grading  $A^L$  by picking an orientation on  $L$ .

The variable  $\mathcal{U}_i$  has  $\text{gr}_{\mathcal{W}}$ -grading  $-2$  if  $w_i \in \mathcal{W}$ , and  $0$  if  $w_i \notin \mathcal{W}$ . Similarly  $\mathcal{V}_i$  has  $\text{gr}_{\mathcal{W}}$ -grading  $-2$  if  $z_i \in \mathcal{W}$  and  $0$  otherwise.

*Remark 7.3.* There are two natural conventions for defining the absolute grading for multi-pointed 3-manifolds. We recall that adding a basepoint has the effect on  $\widehat{HF}$  of tensoring with a 2-dimensional vector space  $V = \mathbb{F} \oplus \mathbb{F}$ . See [OS08a, Section 6]. In this paper, we use the convention that the top degree element of  $V$  has absolute grading  $0$ . This is different than the TQFT convention of [Zem19a], where  $V$  is supported in gradings  $1/2$  and  $-1/2$ .

The following is implicit in the work of Manolescu and Ozsváth [MO10] (see in particular [MO10, Section 12]). In particular, the results are not new to our paper, however the presentation is helpful.

**Lemma 7.4.** *Let  $L = K_1 \cup \dots \cup K_{\ell}$  denote an  $\ell$ -component link in a 3-manifold  $Y$ , such that each component is null-homologous, and suppose  $Y$  is equipped with a torsion  $\text{Spin}^c$  structure  $\mathfrak{s}$ . Let  $\mathcal{H} = (\Sigma, \alpha, \beta, \mathbf{w}, \mathbf{z})$  be a link minimal Heegaard diagram. Let  $\mathcal{C}$  denote the full link Floer complex  $\mathcal{CFL}(\mathcal{H}, \mathfrak{s})$  over  $\mathbb{F}[\mathcal{U}_1, \dots, \mathcal{U}_n, \mathcal{V}_1, \dots, \mathcal{V}_{\ell}]$ , where  $n = |\mathbf{w}|$  and  $\ell = |\mathbf{z}|$ . (In particular, we assume that all free basepoints are in  $\mathbf{w}$ , to simplify the notation).*

- (1) *If  $\mathcal{W}$  is complete collection of basepoints on  $\mathcal{H}$ , and  $z_i \notin \mathcal{W}$ , then the quotient map*

$$\mathcal{Q}_{\mathcal{V}_i}: \mathcal{C} \rightarrow \mathcal{C}/(\mathcal{V}_i - 1)$$

*is grading preserving with respect to  $\text{gr}_{\mathcal{W}}$ . Similarly, the quotient map*

$$\mathcal{Q}_{\mathcal{U}_i}: \mathcal{C} \rightarrow \mathcal{C}/(\mathcal{U}_i - 1),$$

*is grading preserving if  $w_i \notin \mathcal{W}$ .*

- (2) *Suppose that  $K_j$  is a component of  $L$ , and let  $\mathcal{W}_0 \cup \{w_j\}$  be a complete collection of basepoints, and write  $\{w_j, z_j\} = K_j \cap (\mathbf{w} \cup \mathbf{z})$ . Let  $L$  and  $K_j$  have orientations induced by  $\mathcal{W}_0 \cup \{w_j\}$ . Then*

$$\text{gr}_{\mathcal{W}_0 \cup \{w_j\}} - \text{gr}_{\mathcal{W}_0 \cup \{z_j\}} = 2A_j^{\mathcal{W}_0 \cup \{w_j\}} - \text{lk}(L \setminus K_j, K_j).$$

- (3) *Suppose that  $\mathcal{W}$  and  $\mathcal{W}'$  are two complete collections of basepoints which coincide at index  $j$ . Then*

$$A_j^{\mathcal{W}} = A_j^{\mathcal{W}'}$$

- (4) *Let  $K_i \subseteq L$ , and orient both using the basepoints  $\mathcal{W} = \mathbf{w}$ , and suppose  $i \neq j$ . Give  $\mathcal{C}$  and  $\mathcal{C}/(\mathcal{V}_i - 1)$  the grading  $A_j$  induced by the basepoints  $\mathcal{W} = \mathbf{w}$ . For*

$j \neq i$ ,

$$A_j(\mathcal{Q}_{\mathcal{V}_i}) = -\frac{1}{2}\text{lk}(K_i, K_j).$$

(5) Let  $K_i \subseteq L$ , and orient both using the basepoints  $\mathcal{W} = \mathbf{w}$ , and suppose  $j \neq i$ . Give  $\mathcal{C}$  and  $\mathcal{C}/(\mathcal{Z}_i - 1)$  the grading  $A_j$  induced by the basepoints  $\mathcal{W}$  and  $(\mathcal{W} \setminus \{w_i\}) \cup \{z_i\}$ , respectively. Then,

$$A_j(\mathcal{Q}_{\mathcal{Z}_i}) = \frac{1}{2}\text{lk}(K_i, K_j).$$

*Proof.* Following [Zem19a], the Alexander and Maslov gradings may be defined by representing  $Y \setminus N(L)$  as surgery on the complement of an  $\ell$ -component unlink in  $S^3$ . We pick a Heegaard triple  $\mathcal{T} = (\Sigma, \boldsymbol{\alpha}, \boldsymbol{\beta}_0, \boldsymbol{\beta}, \mathbf{w}, \mathbf{z})$  which represents this 2-handle cobordism. We pick a triangle class  $\psi \in \pi_2(\mathbf{x}, \mathbf{y}, \mathbf{z})$  on  $\mathcal{T}$ . Formulas for the Maslov and Alexander gradings of  $\mathbf{z}$  are described in [Zem19a, Section 5.5]. Note that since  $(\Sigma, \boldsymbol{\alpha}, \boldsymbol{\beta}_0, \mathbf{w}, \mathbf{z})$  and  $(\Sigma, \boldsymbol{\beta}_0, \boldsymbol{\beta}, \mathbf{w}, \mathbf{z})$  both represent an unlink in  $S^3$  or in  $\#^N(S^1 \times S^2)$ , we may assume that  $\text{gr}_{\mathcal{W}}(\mathbf{x}) = \text{gr}_{\mathcal{W}'}(\mathbf{x})$  and  $A_j^{\mathcal{W}}(\mathbf{x}) = 0$  for any complete collection of basepoints  $\mathcal{W}$ , and similarly for  $\mathbf{y}$ .

With the above in place, claim (1) follows because the formula for  $\text{gr}_{\mathcal{W}}$  does not change if we delete a basepoint which is not in  $\mathcal{W}$ .

Consider now claim (2). Write  $U_j \subseteq S^3$  for the unknot corresponding to  $K_j \subseteq Y$  in our surgery presentation, and write  $S_j$  for the properly embedded surface  $U_j \times [0, 1]$  in the 2-handle cobordism. We pick integral 2-chains  $F_j$  in  $Y$  such that  $\partial F_j = -K_j$ , and write  $\hat{S}_j$  for the closed surface obtained by capping  $S_j$  with  $F_j$  and Seifert disks for the unlink in  $S^3$ . Let  $[\hat{S}]$  denote the sum of the classes  $[\hat{S}_i]$ .

An identical argument to [Zem19a, Lemma 3.8] implies that if  $\psi$  is a homology class of triangles on the surgery diagram for the above cobordism, then

$$\mathfrak{s}_{\mathcal{W}_0 \cup \{w_j\}}(\psi) - \mathfrak{s}_{\mathcal{W}_0 \cup \{z_j\}}(\psi) = PD[S_j]. \quad (7.1)$$

Consider  $\text{gr}_{\mathcal{W}_0 \cup \{w_j\}} - \text{gr}_{\mathcal{W}_0 \cup \{z_j\}}$ . We may subtract the formulas in [Zem19a, Equation 5.22] and apply equation (7.1) to obtain

$$\begin{aligned} & \text{gr}_{\mathcal{W}_0 \cup \{w_j\}}(\mathbf{z}) - \text{gr}_{\mathcal{W}_0 \cup \{z_j\}}(\mathbf{z}) \\ &= \frac{c_1^2(\mathfrak{s}_{\mathcal{W}_0 \cup \{w_j\}}(\psi)) - \left(c_1(\mathfrak{s}_{\mathcal{W}_0 \cup \{w_j\}}(\psi)) - 2PD[S_j]\right)^2}{4} - 2(n_{z_j} - n_{w_j})(\psi). \end{aligned}$$

We may rearrange the above to see that

$$\begin{aligned} & \text{gr}_{\mathcal{W}_0 \cup \{w_j\}}(\mathbf{z}) - \text{gr}_{\mathcal{W}_0 \cup \{z_j\}}(\mathbf{z}) \\ &= \langle c_1(\mathfrak{s}_{\mathcal{W}_0 \cup \{w_j\}}(\psi)), \hat{S}_j \rangle - [\hat{S}_j] \cdot [\hat{S}_j] - 2(n_{z_j} - n_{w_j})(\psi) \\ &= \langle c_1(\mathfrak{s}_{\mathcal{W}_0 \cup \{w_j\}}(\psi)), \hat{S}_j \rangle - [\hat{S}] \cdot [\hat{S}_j] - 2(n_{z_j} - n_{w_j})(\psi) + [\hat{S} \setminus \hat{S}_j] \cdot [\hat{S}] \\ &= 2A_j^{\mathcal{W}_0 \cup \{w_j\}}(\mathbf{z}) + [\hat{S} \setminus \hat{S}_j] \cdot [\hat{S}_j] \\ &= 2A_j^{\mathcal{W}_0 \cup \{w_j\}}(\mathbf{z}) - \text{lk}(L \setminus K_j, K_j). \end{aligned}$$

In the last line, we used the equality  $[\hat{S} \setminus \hat{S}_j] \cdot [\hat{S}_j] = -\text{lk}(L \setminus K_j, K_j)$ , which follows since we capped with negative Seifert surfaces of  $L$  (and since we are using the outward normal first convention for boundary orientations).

We now consider claim (3). We consider the case when  $\mathcal{W}$  and  $\mathcal{W}'$  differ only at a single index  $i \neq j$ . Assume that  $\mathcal{W}$  contains  $w_i$  and that  $\mathcal{W}'$  contains  $z_i$ . Write  $L'$  for  $L$  with the orientation of  $K_i$  reversed. Computing directly from the definition, shows that

$$2(A_j^{\mathcal{W}} - A_j^{\mathcal{W}'}) = \langle c_1(\mathfrak{s}_{\mathcal{W}}(\psi)) - c_1(\mathfrak{s}_{\mathcal{W}'}(\psi)), \hat{S}_j \rangle - \hat{S} \cdot \hat{S}_j + \hat{S}' \cdot \hat{S}_j.$$

Here  $\hat{S}' = \hat{S} - 2\hat{S}_i$ . As before  $\mathfrak{s}_{\mathcal{W}} - \mathfrak{s}_{\mathcal{W}'} = PD[S_i]$ . Hence, the above equation gives

$$A_j^{\mathcal{W}} - A_j^{\mathcal{W}'} = 0$$

Consider claim (4) now. For this claim, we apply claim (2), with  $\mathcal{W}_0 = \mathcal{W} \setminus \{w_j\}$ . Since  $z_i \notin \mathcal{W}_0 \cup \{w_j\}$  and  $z_i \notin \mathcal{W}_0 \cup \{z_j\}$ , by part (1) we know that  $\mathcal{Q}_{\mathcal{V}_i}$  is homogeneously graded with respect to  $\text{gr}_{\mathcal{W}_0 \cup \{w_j\}}$  and  $\text{gr}_{\mathcal{W}_0 \cup \{z_j\}}$ . Using claim (2), we obtain

$$2\Delta(A_j) = \text{lk}(L \setminus (K_i \cup K_j), K_j) - \text{lk}(L \setminus K_j, K_j) = -\text{lk}(K_i, K_j).$$

We now consider claim (5). By claim (3), it is sufficient to compute the grading change of  $A_j^{\mathcal{W}'}$  where  $\mathcal{W}' = (\mathbf{w} \setminus \{w_i\}) \cup \{z_i\}$ . We use part (4), but note that with respect to  $\mathcal{W}'$ , the orientation of  $K_i$  is reversed, while the orientation of  $K_j$  is unchanged.  $\square$

**7.3. On the algebra of the link surgery formula.** In this section, we reformulate the algebra of the link surgery formula slightly. We begin with a convenient description of the underlying group:

**Lemma 7.5.** *Suppose that  $\mathcal{H}$  is a link minimal Heegaard diagram for a link  $L$  in  $S^3$ , which has no free basepoints. Let  $M$  be a sublink of  $L$ . Write  $S_M \subseteq \mathbb{F}[\mathcal{U}_1, \dots, \mathcal{U}_\ell, \mathcal{V}_1, \dots, \mathcal{V}_\ell]$  for the multiplicatively closed subset generated by  $\mathcal{V}_i$  for  $i$  such that  $K_i \subseteq M$ . Then there is an  $\mathbb{F}[U_1, \dots, U_\ell]$ -equivariant chain isomorphism*

$$\bigoplus_{\mathbf{s} \in \mathbb{H}(L)} A^-(\mathcal{H}^{L-M}, \psi^M(\mathbf{s})) \cong S_M^{-1} \cdot \mathcal{CFL}(\mathcal{H}),$$

where we view  $U_i$  as acting by  $\mathcal{U}_i \mathcal{V}_i$  on the right-hand side. Furthermore, if  $\mathbf{s} \in \mathbb{H}(L)$ , this isomorphism intertwines the summand  $A^-(\mathcal{H}^{L-M}, \psi^M(\mathbf{s}))$  with the subspace of  $S_M^{-1} \cdot \mathcal{CFL}(\mathcal{H})$  in Alexander multi-grading  $\mathbf{s}$ .

*Proof.* The module  $S_M^{-1} \cdot \mathcal{CFL}(\mathcal{H})$  decomposes over Alexander gradings  $\mathbf{s} \in \mathbb{H}(L)$ . Hence, it is sufficient to identify the subspace in Alexander grading  $\mathbf{s}$  with

$$A^-(\mathcal{H}^{L-M}, \psi^M(\mathbf{s}))$$

in a way which commutes with the action of  $\mathbb{F}[U_1, \dots, U_\ell]$ . We recall that  $A^-(\mathcal{H}^{L-M}, \psi^M(\mathbf{s}))$  is generated by monomials  $U_1^{i_1} \cdots U_\ell^{i_\ell} \cdot \mathbf{x}$  such that  $i_j \geq 0$  for all  $j$ , and

$$A_j^{L-M}(\mathbf{x}) - i_j \leq \psi_j^M(s_j)$$

for each  $j$  such that  $K_j \not\subseteq M$ . Here, we are writing  $\mathbf{s} = (s_1, \dots, s_\ell)$ . Note that by definition of  $\psi_j^M(s_j)$  (see [MO10, Section 3.7]), we have

$$A_j^L(\mathbf{x}) - A_j^{L-M}(\mathbf{s}) = s_j - \psi_j^M(s_j).$$

Compare Lemma 7.4. Hence we may think of  $A^-(\mathcal{H}^{L-M}, \psi^M(\mathbf{s}))$  as being generated by monomials  $U_1^{i_1} \cdots U_\ell^{i_\ell} \cdot \mathbf{x}$  such that  $i_j \geq 0$  for all  $j$  and such that

$$A_j^L(\mathbf{x}) - i_j \leq s_j$$

whenever  $K_j \notin M$ . We may define a map

$$A^-(\mathcal{H}^{L-M}, \psi^M(\mathbf{s})) \rightarrow S_M^{-1} \cdot \mathcal{CFL}(\mathcal{H})$$

via the formula

$$U_1^{i_1} \cdots U_\ell^{i_\ell} \cdot \mathbf{x} \mapsto \mathcal{U}_1^{i_1} \cdots \mathcal{U}_\ell^{i_\ell} \mathcal{V}_1^{s_1 - A_1^L(\mathbf{x}) + i_1} \cdots \mathcal{V}_\ell^{s_\ell - A_\ell^L(\mathbf{x}) + i_\ell} \cdot \mathbf{x}.$$

The map is clearly a chain isomorphism onto the subspace in Alexander grading  $\mathbf{s}$ .  $\square$

*Remark 7.6.* Manolescu and Ozsváth also define an inclusion map

$$\mathcal{I}_\mathbf{s}^{\vec{N}} : \mathfrak{A}^-(\mathcal{H}^{L-M}, \psi^M(\mathbf{s})) \rightarrow \mathfrak{A}^-(\mathcal{H}^{L-M-N}, p^{\vec{N}}(\psi^M(\mathbf{s}))),$$

whenever  $\vec{N}$  is an oriented sublink of  $L - M$  (possibly with a different orientation than  $L$ ). See [MO10, Section 3.8]. (For the definition of  $p^{\vec{N}}$ , see [MO10, Section 3.7]). It is straightforward to extend Lemma 7.5 to see there are isomorphisms

$$\bigoplus_{\mathbf{s} \in \mathbb{H}(L)} A^-(\mathcal{H}^{L-M}, p^{\vec{N}}(\psi^M(\mathbf{s}))) \cong S_{M \cup \vec{N}}^{-1} \cdot \mathcal{CFL}(\mathcal{H})$$

where  $S_{M \cup \vec{N}}$  denotes the multiplicatively closed subset of  $\mathbb{F}[\mathcal{U}_1, \dots, \mathcal{U}_\ell, \mathcal{V}_1, \dots, \mathcal{V}_\ell]$ -generated by  $\mathcal{U}_i$  for  $K_i \subseteq \vec{N}$  which is oriented oppositely to  $L$ , and  $\mathcal{V}_i$  for  $K_i \subseteq M + \vec{N}$  which are oriented coherently with  $L$ . Furthermore, the Manolescu–Ozsváth inclusion maps  $\mathcal{I}^{\vec{N}}$  are intertwined with the canonical maps from localization.

We now discuss some algebraic properties of the maps in the link surgery hypercube. Manolescu and Ozsváth prove that the hypercube maps in their surgery formula  $\mathcal{C}_\Lambda(L)$  are  $\mathbb{F}[U_1, \dots, U_\ell]$ -equivariant. By the previous lemma, there is a more refined action of  $\mathbb{F}[\mathcal{U}_1, \dots, \mathcal{U}_\ell, \mathcal{V}_1, \dots, \mathcal{V}_\ell]$  on the complex  $\mathcal{C}_\Lambda(L)$ , though the hypercube differential does not commute with this action. We now describe how the hypercube maps interact with the action of this larger ring.

Firstly, we define a ring homomorphism

$$T : \mathbb{F}[\mathcal{U}, \mathcal{V}] \rightarrow \mathbb{F}[\mathcal{U}, \mathcal{V}, \mathcal{V}^{-1}]$$

via the formula

$$T(\mathcal{U}) = \mathcal{V}^{-1} \quad \text{and} \quad T(\mathcal{V}) = \mathcal{U} \mathcal{V}^2.$$

We write  $I : \mathbb{F}[\mathcal{U}, \mathcal{V}] \rightarrow \mathbb{F}[\mathcal{U}, \mathcal{V}, \mathcal{V}^{-1}]$  for the canonical inclusion.

We view  $S_M^{-1} \cdot \mathbb{F}[\mathcal{U}_1, \dots, \mathcal{U}_\ell, \mathcal{V}_1, \dots, \mathcal{V}_\ell]$  as the tensor product over  $\mathbb{F}$  of  $\ell$  different rings, which are each isomorphic to  $\mathbb{F}[\mathcal{U}, \mathcal{V}]$  or  $\mathbb{F}[\mathcal{U}, \mathcal{V}, \mathcal{V}^{-1}]$ .

If  $N \subseteq L - M$ , then we define the ring homomorphism

$$T^{\vec{N}} : S_M^{-1} \cdot \mathbb{F}[\mathcal{U}_1, \dots, \mathcal{U}_\ell, \mathcal{V}_1, \dots, \mathcal{V}_\ell] \rightarrow S_{M \cup N}^{-1} \cdot \mathbb{F}[\mathcal{U}_1, \dots, \mathcal{U}_\ell, \mathcal{V}_1, \dots, \mathcal{V}_\ell]$$

by tensoring the map  $T$  for each component  $K_i \subseteq \vec{N}$  which is oriented oppositely to  $L$ , tensoring  $I$  for each component  $K_i \subseteq \vec{N}$  which is oriented consistently with  $L$ , and tensoring the identity map for the remaining components of  $L$ .

**Lemma 7.7.** *Suppose that  $N \subseteq M \subseteq L$ , and let  $\vec{N}$  denote  $N$  with a choice of orientation. If  $a \in S_M^{-1} \cdot \mathbb{F}[\mathcal{U}_1, \dots, \mathcal{U}_\ell, \mathcal{V}_1, \dots, \mathcal{V}_\ell]$ , and  $\mathbf{x} \in S_M^{-1} \cdot \mathcal{CFL}(\mathcal{H})$ , then*

$$\Phi^{\vec{N}}(a \cdot \mathbf{x}) = T^{\vec{N}}(a) \cdot \Phi^{\vec{N}}(\mathbf{x}).$$

*Proof.* We focus on the length 1 maps in the surgery hypercube. The maps of higher length are analyzed using the same argument. In this case, write  $N = K_i$ , where  $K_i$  is a component of  $L$ . To simplify the notation further, we focus on the case that  $M = \emptyset$ . Let  $K_i$ , (resp.  $-K_i$ ), denote  $K_i$  equipped with the orientation which coincides with (resp. is opposite to) the orientation from  $L$ . The map  $\Phi_{L,L-K_i}^{K_i}$  is the canonical inclusion map

$$\mathcal{CFL}(\mathcal{H}) \hookrightarrow \mathcal{V}_i^{-1} \cdot \mathcal{CFL}(\mathcal{H}),$$

which is clearly  $\mathbb{F}[\mathcal{U}_1, \dots, \mathcal{U}_\ell, \mathcal{V}_1, \dots, \mathcal{V}_\ell]$ -equivariant. Note that  $T^{K_i}$  is just the canonical inclusion of  $\mathbb{F}[\mathcal{U}_1, \dots, \mathcal{U}_\ell, \mathcal{V}_1, \dots, \mathcal{V}_\ell]$  into  $\mathcal{V}_i^{-1} \cdot \mathbb{F}[\mathcal{U}_1, \dots, \mathcal{U}_\ell, \mathcal{V}_1, \dots, \mathcal{V}_\ell]$ .

The map  $\Phi_{L,L-K_i}^{-K_i}$  is more complicated, as we now describe. Similarly to Lemma 7.5, there are canonical isomorphisms

$$\begin{aligned} \phi_i: \mathcal{U}_i^{-1} \cdot \mathcal{CFL}(\mathcal{H}) &\rightarrow \mathcal{CFL}(\mathcal{H})/(\mathcal{U}_i - 1) \otimes \mathbb{F}[\mathbb{H}_i(L)], \quad \text{and} \\ \psi_i: \mathcal{V}_i^{-1} \cdot \mathcal{CFL}(\mathcal{H}) &\rightarrow \mathcal{CFL}(\mathcal{H})/(\mathcal{V}_i - 1) \otimes \mathbb{F}[\mathbb{H}_i(L)]. \end{aligned}$$

Here  $\mathbb{F}[\mathbb{H}_i(L)]$  denotes the  $\mathbb{F}[t, t^{-1}]$ -module generated by  $t^\alpha$  where  $\alpha \in \mathbb{H}_i(L)$ . Here,  $t$  is a formal variable.

The map  $\phi_i$  is given as follows. Write

$$\mathcal{Q}_{\mathcal{U}_i}: \mathcal{U}_i^{-1} \mathcal{CFL}(\mathcal{H}) \rightarrow \mathcal{CFL}(\mathcal{H})/(\mathcal{U}_i - 1)$$

for the quotient map. Then  $\phi_i$  is given by the formula

$$\phi_i(x) = \mathcal{Q}_{\mathcal{U}_i}(x) \otimes t^{A_i^L(x)}.$$

The map  $\psi_i$  is defined similarly.

Finally, write  $\mathcal{I}_i$  for the inclusion of  $\mathcal{CFL}(\mathcal{H})$  into  $\mathcal{U}_i^{-1} \cdot \mathcal{CFL}(\mathcal{H})$ .

Moving the basepoint  $z_i$  to  $w_i$  along a subarc of  $K_i$  determines a homotopy equivalence

$$\Psi_{z_i \rightarrow w_i}: \mathcal{CFL}(\mathcal{H})/(\mathcal{U}_i - 1) \rightarrow \mathcal{CFL}(\mathcal{H})/(\mathcal{V}_i - 1)$$

which preserves  $A_j^{L-K_i}$  for  $j \neq i$ . The map  $\Psi_{z_i \rightarrow w_i}$  sends  $\mathcal{V}_i$  to  $\mathcal{U}_i$ , and is equivariant with respect to the other variables.

The map  $\Phi_{L,L-K_i}^{-K_i}$  is defined as the composition

$$\Phi_{L,L-K_i}^{-K_i} := \psi_i^{-1} \circ (\Psi_{z_i \rightarrow w_i} \otimes t^{\lambda_i}) \circ \phi_i \circ \mathcal{I}_i.$$

We consider the interaction with  $\mathcal{U}_i$  and  $\mathcal{V}_i$ . The map  $\mathcal{I}_i$  commutes with  $\mathcal{U}_i$  and  $\mathcal{V}_i$ . The map  $\phi_i$  has the property that

$$\phi_i(\mathcal{U}_i^n \cdot x) = t^{-n} \cdot \phi_i(x) \quad \text{and} \quad \phi_i(\mathcal{V}_i^n \cdot x) = \mathcal{V}_i^n t^n \cdot \phi_i(x).$$

Also

$$(\Psi_{z_i \rightarrow w_i} \otimes \text{id})(\mathcal{V}_i^n t^m \cdot x) = \mathcal{U}_i^n t^m \cdot (\Psi_{z_i \rightarrow w_i} \otimes \text{id})(x).$$

Similarly

$$\psi_i(\mathcal{U}_i^n \cdot x) = \mathcal{U}_i^n t^{-n} \cdot \psi_i(x) \quad \text{and} \quad \psi_i(\mathcal{V}_i^n \cdot x) = t^n \cdot \psi_i(x),$$

which implies that

$$\psi_i^{-1}(t^n \cdot x) = \mathcal{V}_i^n \cdot \psi_i^{-1}(x) \quad \text{and} \quad \psi_i^{-1}(\mathcal{U}_i^n \cdot x) = \mathcal{U}_i^n \mathcal{V}_i^n \cdot \psi_i^{-1}(x).$$

From these relations, it follows that

$$\Phi_{L,L-K_i}^{-K_i}(\mathcal{U}_i \cdot \mathbf{x}) = \mathcal{V}_i^{-1} \cdot \Phi_{L,L-K_i}^{-K_i}(\mathbf{x}) \quad \text{and} \quad \Phi_{L,L-K_i}^{-K_i}(\mathcal{V}_i \cdot \mathbf{x}) = \mathcal{U}_i \mathcal{V}_i^2 \cdot \Phi_{L,L-K_i}^{-K_i}(\mathbf{x}),$$

completing the proof.  $\square$

*Example 7.8.* We now describe the surgery complex for the unknot  $\mathbb{O}$  in our present notation, and compare it to the traditional notation of [OS08b]. The complex  $\mathcal{CFK}(\mathbb{O})$  has one generator, 1, over  $\mathbb{F}[\mathcal{U}, \mathcal{V}]$ . In our notation,  $v$  sends  $\mathcal{U}^i \mathcal{V}^j \in \mathcal{CFK}(\mathbb{O})$  to  $\mathcal{U}^i \mathcal{V}^j \in \mathcal{V}^{-1} \mathcal{CFK}(\mathbb{O})$ . Similarly  $h_\lambda$  sends  $\mathcal{U}^i \mathcal{V}^j$  to  $\mathcal{V}^\lambda T(\mathcal{U}^i \mathcal{V}^j) = \mathcal{U}^j \mathcal{V}^{2j-i+\lambda}$ .

Traditionally, one works with the mapping cone formula over  $\mathbb{F}[U]$ . We identify both  $A(\mathbb{O}, s) \subseteq \mathcal{CFK}(\mathbb{O})$  and  $B(\mathbb{O}, s) \subseteq \mathcal{V}^{-1} \mathcal{CFK}(\mathbb{O})$  with  $\mathbb{F}[U]$  (where  $U$  acts by  $\mathcal{U}\mathcal{V}$ ). We identify  $\mathcal{U}^i \mathcal{V}^j \in \mathcal{CFK}(\mathbb{O})$  with  $U^{\min(i,j)} \in A(\mathbb{O}, s)$ , and we identify  $\mathcal{U}^i \mathcal{V}^j \in \mathcal{V}^{-1} \mathcal{CFK}(\mathbb{O})$  with  $U^i \in B(\mathbb{O}, s)$ . We can view the previous identification as giving two isomorphisms

$$\mathcal{CFK}(\mathbb{O}) \cong \bigoplus_{s \in \mathbb{Z}} \mathbb{F}[U] \quad \text{and} \quad \mathcal{V}^{-1} \mathcal{CFK}(\mathbb{O}) \cong \bigoplus_{s \in \mathbb{Z}} \mathbb{F}[U].$$

In the original notation of Ozsváth and Szabó

$$v(U^i) = \begin{cases} U^{i-s} & \text{if } s \leq 0, \\ U^i & \text{if } s \geq 0 \end{cases} \quad h_\lambda(U^i) = \begin{cases} U^i & \text{if } s \leq 0, \\ U^{i+s} & \text{if } s \geq 0. \end{cases}$$

The map  $h_\lambda$  sends  $A(\mathbb{O}, s)$  to  $B(\mathbb{O}, s + \lambda)$ . It is straightforward to see that the above maps form a commutative diagram

$$\begin{array}{ccc} \mathcal{CFK}(\mathbb{O}) & \xrightarrow{f} & \mathcal{V}^{-1} \mathcal{CFK}(\mathbb{O}) \\ \downarrow \cong & & \downarrow \cong \\ \bigoplus_{s \in \mathbb{Z}} A(\mathbb{O}, s) & \xrightarrow{f} & \bigoplus_{s \in \mathbb{Z}} B(\mathbb{O}, s) \end{array}$$

whenever  $f$  is one of  $v$  or  $h_\lambda$ .

## 8. LINK SURGERY MODULES OVER $\mathcal{K}$ AND $\mathcal{L}$

In this section, we describe some basic link surgery modules over the algebras  $\mathcal{K}$  and  $\mathcal{L}$ . We begin by defining the type- $D$  and type- $A$  modules for a solid torus and the algebraic merge module. Subsequently, we interpret the knot and link surgery formulas as type- $D$  modules over  $\mathcal{K}$  and  $\mathcal{L}$ .

**8.1. The type- $D$  module for a solid torus.** If  $\lambda$  is an integer, we refer to the complement of a  $\lambda$ -framed unknot in  $S^3$  as the  $\lambda$ -framed solid torus. We will define a type- $D$  module  $\mathcal{D}_\lambda^{\mathcal{K}}$  for the  $\lambda$ -framed solid torus as follows. We set

$$\mathcal{D}_\lambda^{\mathcal{K}} \cdot \mathbf{I}_0 = \langle \mathbf{x}^0 \rangle \quad \text{and} \quad \mathcal{D}_\lambda^{\mathcal{K}} \cdot \mathbf{I}_1 = \langle \mathbf{x}^1 \rangle,$$

where  $\langle \mathbf{x}^\varepsilon \rangle = \mathbb{F}$ , spanned by  $\mathbf{x}^\varepsilon$ . We define the structure map via the formula

$$\delta^1(\mathbf{x}^0) = \mathbf{x}^1 \otimes (\sigma + \mathcal{V}^n \tau).$$

**8.2. The type- $A$  module for a solid torus.** Suppose that  $\lambda$  is an integer. We now define the type- $A$  module  ${}_{\mathcal{K}}\mathcal{D}_\lambda$  for the solid torus as follows. We set

$$\mathbf{I}_0 \cdot \mathcal{D}_\lambda = \mathbb{F}[\mathcal{U}, \mathcal{V}] \quad \text{and} \quad \mathbf{I}_1 \cdot \mathcal{D}_\lambda = \mathbb{F}[\mathcal{U}, \mathcal{V}, \mathcal{V}^{-1}].$$

We define the type- $A$  structure map  $m_j$  on  $\mathcal{D}_\lambda$  to be 0 unless  $j = 2$ . We define  $m_2$  on  $\mathcal{D}_\lambda$  as follows. If  $f \in \mathbf{I}_i \cdot \mathcal{K} \cdot \mathbf{I}_i$  and  $x \in \mathbf{I}_j \cdot \mathcal{D}_j$ , then we define  $m_2(f, x)$  to be  $f \cdot x$  (ordinary multiplication of polynomials) if  $i = j$  and to be 0 otherwise. If  $x \in \mathbf{I}_0 \cdot \mathcal{D}_\lambda$ , we define

$$m_2(\sigma, x) = I(x) \in \mathbb{F}[\mathcal{U}, \mathcal{V}, \mathcal{V}^{-1}] = \mathbf{I}_1 \cdot \mathcal{D}_\lambda.$$

Similarly, we define

$$m_2(\tau, x) = \mathcal{V}^\lambda \cdot T(x) \in \mathbb{F}[\mathcal{U}, \mathcal{V}, \mathcal{V}^{-1}],$$

where  $\cdot$  denotes ordinary multiplication of polynomials.

We view  $\mathcal{D}_\lambda$  as being the direct sum of the 1-dimensional spans of monomials, and give  $\mathcal{D}_\lambda$  the product topology with respect to this decomposition. See Definition 5.6. With respect to this topology, the completion is given by

$$\mathbf{I}_0 \cdot \mathcal{D}_\lambda = \mathbb{F}[[\mathcal{U}, \mathcal{V}]], \quad \text{and} \quad \mathbf{I}_1 \cdot \mathcal{D}_\lambda = \mathbb{F}[[\mathcal{U}, \mathcal{V}, \mathcal{V}^{-1}]].$$

(Note that the latter object is defined only as a vector space, and not as a ring, since we are taking completions with respect to  $\mathcal{V}$  and  $\mathcal{V}^{-1}$ ).

**Lemma 8.1.** *The map*

$$m_2: \mathcal{K} \otimes_{\mathbf{I}} \mathcal{D}_\lambda \rightarrow \mathcal{D}_\lambda$$

*is continuous.*

*Proof.* Write  $\mathcal{D}$  for  $\mathcal{D}_\lambda$ . Continuity amounts to two claims. The first is that if  $E \subseteq \mathcal{D}$  is an open subspace, then there is some  $n$  so that  $m_2(J_n \otimes \mathcal{D}) \subseteq E$ . Additionally, we need to show that if  $E$  is as above and  $a \in \mathcal{K}$ , then there is some open  $V_a \subseteq \mathcal{D}$  so that  $m_2(a \otimes V_a) \subseteq E$ . By definition, we may assume that  $E$  is  $\mathcal{D}_{\text{co}(S)}$  for some finite set of basis elements in  $\mathcal{D}$ . (Recall that  $\mathcal{D}_{\text{co}(S)}$  is the span of the basis elements not in  $S$ ).

For the first claim, it suffices to show that if  $n$  is sufficiently large, then  $J_n \otimes \mathcal{D}$  is mapped into  $\mathcal{D}_{\text{co}(S)}$ . This may be proven by considering each idempotent of  $\mathcal{K}$  separately. To ensure  $(\mathbf{I}_0 \cdot J_n \cdot \mathbf{I}_0) \otimes \mathcal{D}$  is sent into  $\mathcal{D}_{\text{co}(S)}$ , it is sufficient to pick  $n$  larger than  $\max(p, q)$  ranging over all monomials  $\mathcal{U}^p \mathcal{V}^q$  appearing in  $\mathbf{I}_0 \cdot S$ . For  $(\mathbf{I}_1 \cdot J_n \cdot \mathbf{I}_1) \otimes \mathcal{D}$  to be sent into  $\mathcal{D}_{\text{co}(S)}$ , we pick  $n$  larger than  $p$  for each monomial  $\mathcal{U}^p \mathcal{V}^q$  appearing in  $\mathbf{I}_1 \cdot S$ . Finally, to ensure that  $(\mathbf{I}_1 \cdot J_n \cdot \mathbf{I}_0) \otimes \mathcal{D}$  is sent into  $\mathcal{D}_{\text{co}(S)}$ , it is sufficient to pick  $n$  larger than  $\max(p, q, 2p - q)$ , ranging over monomials  $\mathcal{U}^p \mathcal{V}^q$  appearing in a summand of  $\mathbf{I}_1 \cdot S$ . To see that this is sufficient, note that if  $\mathcal{U}^i \mathcal{V}^j \tau \otimes \mathcal{U}^s \mathcal{V}^t \in J_n \otimes \mathcal{D}$ , then  $\max(i, 2i - j) \geq n$ . We observe that  $\mathcal{U}^i \mathcal{V}^j \tau \mathcal{U}^s \mathcal{V}^t = \mathcal{U}^{i+t} \mathcal{V}^{j-s+2t} \tau$  lies in  $\mathcal{D}_{\text{co}(S)}$ , since

$$\max(i + t, 2(i + t) - (j - s + 2t)) = \max(i + t, 2i - j + s) \geq \max(i, 2i - j) \geq n.$$

The fact that  $\mathcal{U}^i \mathcal{V}^j \sigma \otimes \mathcal{U}^s \mathcal{V}^t \in J_n \otimes \mathcal{D}$  is sent into  $\mathcal{D}_{\text{co}(S)}$  is similar.

Next, we need to show that if  $a \in \mathcal{K}$  is fixed, then there is a finite subset  $T$  of generators of  $\mathcal{D}$  so that  $a \otimes \mathcal{D}_{\text{co}(T)}$  is mapped into  $\mathcal{D}_{\text{co}(S)}$ . Without loss of generality, we assume that  $a$  is a monomial. We observe the following basic fact: if  $a \in \mathbf{I}_{\varepsilon'} \cdot \mathcal{K} \cdot \mathbf{I}_\varepsilon$  and  $y \in \mathbf{I}_\varepsilon \cdot \mathcal{D}$  are non-zero monomials, then there is at most 1 (in particular finitely many)  $x \in \mathbf{I}_\varepsilon \cdot \mathcal{D}$  such that  $m_2(a, x) = y$ . In particular, there exists a finite set of generators  $T$  such that  $a \otimes \mathcal{D}_{\text{co}(T)}$  is sent into  $\mathcal{D}_{\text{co}(S)}$ , completing the proof.  $\square$

*Remark 8.2.* Note that  $m_2$  is *not* continuous as a map from  $\mathcal{K} \otimes^! \mathcal{D}$  to  $\mathcal{D}$ . Compare Remark 6.5. In fact,  $m_2$  does not induce a map from the completion of  $\mathcal{K} \otimes^! \mathcal{D}_\lambda$  to  $\mathcal{D}_\lambda$ . For example, in the completion of  $\mathcal{K} \otimes^! \mathcal{D}_\lambda$  the sum  $\sum_{i=0}^{\infty} \mathcal{V}^i \otimes \mathcal{V}^{-i} i_1$  converges since  $\mathcal{V}^{-i} i_1 \rightarrow 0$  in the topology of  $\mathcal{D}_\lambda$ , while  $m_2$  cannot be defined on such infinite sums.

The module for a solid torus extends to a type- $AA$  bimodule:

$$\kappa[\mathcal{D}_\lambda]_{\mathbb{F}[U]}.$$

Here, we have  $U$  act on the right via polynomial multiplication with  $\mathcal{U}\mathcal{V}$  (summed over both idempotents). Since  $[\mathcal{U}\mathcal{V}, \tau] = 0$  and  $[\mathcal{U}\mathcal{V}, \sigma] = 0$ , the construction above defines an  $AA$ -bimodule structure on  $\mathcal{D}_\lambda$ . Note that only  $m_{1,1,0}$  and  $m_{0,1,1}$  are non-trivial.

Additionally, we can also think of the module for a solid torus as corresponding instead to a  $DA$ -bimodule  $\kappa[\mathcal{D}_\lambda]^{\mathbb{F}[U]}$ , in such a way that

$$\kappa[\mathcal{D}_\lambda]^{\mathbb{F}[U]} \hat{\boxtimes}_{\mathbb{F}[U]} \mathbb{F}[U]_{\mathbb{F}[U]} \cong \kappa[\mathcal{D}_\lambda]_{\mathbb{F}[U]}.$$

For this description, the generators of  $\mathbf{I}_0 \cdot \kappa[\mathcal{D}_\lambda]^{\mathbb{F}[U]}$  are  $\mathcal{U}^i$  and  $\mathcal{V}^j$  for  $i, j \geq 0$ . The generators of  $\mathbf{I}_1 \cdot \kappa[\mathcal{D}_\lambda]^{\mathbb{F}[U]}$  are  $\mathcal{V}^i$  for  $i \in \mathbb{Z}$ . This module has  $\delta_j^1 = 0$  unless  $j = 2$ . We illustrate the structure map  $\delta_2^1$  of  $\kappa[\mathcal{D}_0]^{\mathbb{F}[U]}$  in Figure 8.1 and leave the structure relations to the reader for other framings.

$$\begin{array}{cccccccc}
 \dots & \mathcal{U}^2 & \xleftarrow{\mathcal{V}|U} & \mathcal{U} & \xleftarrow{\mathcal{V}|U} & 1 & \xleftarrow{\mathcal{V}|1} & \mathcal{V} & \xleftarrow{\mathcal{V}|1} & \mathcal{V}^2 & \dots \\
 & \tau|1 \downarrow & & \tau|1 \downarrow & & \tau|1 \downarrow & & \tau|U \downarrow & & \tau|U^2 \downarrow & \\
 & \sigma|U^2 & & \sigma|U & & \sigma|1 & & \sigma|1 & & \sigma|1 & \\
 \dots & \mathcal{V}^{-2} & \xleftarrow{\mathcal{V}|1} & \mathcal{V}^{-1} & \xleftarrow{\mathcal{V}|1} & 1 & \xleftarrow{\mathcal{V}|1} & \mathcal{V} & \xleftarrow{\mathcal{V}|1} & \mathcal{V}^2 & \dots \\
 & \leftarrow \mathcal{U}|U & & \leftarrow \mathcal{U}|U & & \leftarrow \mathcal{U}|U & & \leftarrow \mathcal{U}|U & & \leftarrow \mathcal{U}|U & 
 \end{array}$$

FIGURE 8.1. The  $DA$ -bimodule  $\kappa\mathcal{D}_0^{\mathbb{F}[U]}$ . An arrow decorated with  $a|b$  from  $\mathbf{x}$  to  $\mathbf{y}$  means that  $\delta_2^1(a, \mathbf{x}) = \mathbf{y} \otimes b$ .

**8.3. The merge bimodule.** In this section, we define a bimodule  $\kappa|_{\mathcal{K}} M^{\mathcal{K}}$ , which we call the *merge bimodule*.

Whenever  $R$  is a commutative algebra over  $\mathbb{F}$ , there is a morphism of algebras  $\phi: R \otimes_{\mathbb{F}} R \rightarrow R$ , given by  $\phi(a \otimes b) = ab$ . A ring homomorphism  $\psi: A \rightarrow B$  always determines a bimodule  ${}_A[\psi]^B$  whose underlying vector space is the ground field, and has structure map  $\delta_1^1 = 0$  and  $\delta_2^1(a \otimes 1) = 1 \otimes \psi(a)$ . In particular, there is a natural bimodule  ${}_{R \otimes R}[\phi]^R$  for any commutative ring  $R$ .

The algebra  $\mathcal{K}$  is not commutative, though the bimodule  $\kappa|_{\mathcal{K}} M^{\mathcal{K}}$  is somewhat analogous.

We now describe the bimodule  $M$ . To make the notation clear, in this section we will write  $|$  for  $\otimes_{\mathbb{F}}$  and  $\otimes$  for  $\otimes_{\mathbf{I}}$ .

As a vector space,  $M$  is  $\mathbf{I} = \mathbf{I}_0 \oplus \mathbf{I}_1$ . There is a left action of  $\mathbf{I}|\mathbf{I}$ , given by

$$(i_1|i_2) \cdot i = i_1 i_2 \cdot i.$$

The right  $\mathbf{I}$ -action is the standard action.



On  $M$ , only  $\delta_2^1$  and  $\delta_3^1$  are non-trivial. The map  $\delta_2^1$  is defined as follows. Suppose that  $a_1|a_2$  is an elementary tensor in either

$$(\mathbf{I}_0|\mathbf{I}_0) \cdot (\mathcal{K}|\mathcal{K}) \cdot (\mathbf{I}_0|\mathbf{I}_0) \quad \text{or} \quad (\mathbf{I}_1|\mathbf{I}_1) \cdot (\mathcal{K}|\mathcal{K}) \cdot (\mathbf{I}_1|\mathbf{I}_1).$$

In this case, we set

$$\delta_2^1(a_1|a_2 \otimes i) = i \otimes a_1 a_2.$$

On any other elementary tensor, we set  $\delta_2^1$  to vanish.

We define  $\delta_3^1$  as follows. We set

$$\delta_3^1((1|\sigma) \otimes (\sigma|1) \otimes i_0) = i_1 \otimes \sigma, \quad \text{and} \quad \delta_3^1((1|\tau) \otimes (\tau|1) \otimes i_0) = i_1 \otimes \tau.$$

More generally, if  $a, b, c, d$  are monomials concentrated in single idempotents, then we set

$$\delta_3^1((a|b\sigma) \otimes (c\sigma|d) \otimes i_0) = i_0 \otimes abc\sigma d$$

and similarly for the  $\tau$  terms. Note that we set

$$\delta_3^1((\sigma|1) \otimes (1|\sigma) \otimes i_0) = 0,$$

and similarly if  $\tau$  replaces  $\sigma$ . The  $DA$ -bimodule relations are straightforward to verify.

**Lemma 8.3.** *The merge module  ${}_{\mathcal{K}|\mathcal{K}}M^{\mathcal{K}}$  is a split Alexander module (using the discrete partition on the two incoming algebra factors).*

*Remark 8.4.* The structure maps of the merge module are *not* continuous when we view the bimodule as a non-split module over  $\mathcal{K} \otimes^! \mathcal{K}$  or  $\mathcal{K} \otimes^* \mathcal{K}$ , i.e. as  ${}_{\mathcal{K} \otimes^! \mathcal{K}}M^{\mathcal{K}}$  or  ${}_{\mathcal{K} \otimes^* \mathcal{K}}M^{\mathcal{K}}$ . To see this, observe that discontinuity with respect to the topology on  $\mathcal{K} \otimes_{\mathbb{F}}^* \mathcal{K}$  implies discontinuity with respect to  $\mathcal{K} \otimes_{\mathbb{F}}^! \mathcal{K}$  since there is a continuous map  $\mathcal{K} \otimes_{\mathbb{F}}^* \mathcal{K} \rightarrow \mathcal{K} \otimes_{\mathbb{F}}^! \mathcal{K}$ . Note that a sequence of tensors

$$\mathbf{x}_n = (x_n|y_n) \otimes (z_n|w_n) = (\mathcal{K} \otimes_{\mathbb{F}}^* \mathcal{K}) \otimes_{\mathbb{E}}^{\vec{\sigma}} (\mathcal{K} \otimes_{\mathbb{F}}^* \mathcal{K})$$

will converge to 0 if  $x_n$  is constant in  $n$  and  $y_n \rightarrow 0$ . In particular, we need not make any assumptions about  $z_n$  or  $w_n$ . Ergo,

$$(1|\mathcal{V}^i \sigma) \otimes (\mathcal{V}^{-i} \sigma|1) \rightarrow 0.$$

On the other hand,

$$\delta_3^1((1|\mathcal{V}^i \sigma) \otimes (\mathcal{V}^{-i} \sigma|1) \otimes i_0) = i_1 \otimes \sigma \not\rightarrow 0,$$

so  $\delta_3^1$  is not continuous.

*Proof of Lemma 8.3.* We consider first  $\delta_2^1$ . In this case, the only non-trivial actions on  $i_0$  or  $i_1$  are from pairs  $a|b$  where  $a$  and  $b$  are both in  $\mathbf{I}_0 \cdot \mathcal{K} \cdot \mathbf{I}_0$  or both in  $\mathbf{I}_1 \cdot \mathcal{K} \cdot \mathbf{I}_1$ . In this case, the claim is clear.

We now consider  $\delta_3^1$ . Recall that verifying the split Alexander condition amounts to showing that  $\delta_3^1$  is continuous if we use the tree topology from Section 5.6 using the following tree:

$$\begin{array}{ccc} \mathcal{K} & \longrightarrow & \mathcal{K} & \searrow & & \mathbf{I} \\ & & & & \nearrow & \\ \mathcal{K} & \longrightarrow & \mathcal{K} & \nearrow & & \end{array}$$

We define a function

$$\tilde{\mu}: \mathcal{K} \otimes_{\mathbb{F}}^* \mathcal{K} \rightarrow \mathcal{K}$$

given on elementary tensors of monomials by

$$\tilde{\mu}(a\sigma, b\sigma) = ab\sigma \quad \text{and} \quad \tilde{\mu}(a\tau, b\tau) = ab\tau,$$

with  $\tilde{\mu}$  vanishing on other elementary tensors of monomials. Additionally, we consider a map

$$\Pi: (\mathcal{K} \otimes_{\mathbb{I}} \mathcal{K}) \otimes_{\mathbb{F}} (\mathcal{K} \otimes_{\mathbb{I}} \mathcal{K}) \rightarrow (\mathcal{K} \otimes_{\mathbb{I}} \mathcal{K}) \otimes_{\mathbb{F}} (\mathcal{K} \otimes_{\mathbb{I}} \mathcal{K})$$

such that  $\Pi$  is the identity on the elementary tensors of monomials

$$(a\sigma \otimes a')|(b \otimes b'\sigma) \quad \text{and} \quad (a\tau \otimes a')|(b \otimes b'\tau),$$

and such that  $\Pi$  vanishes on other elementary tensors of monomials.

We observe that

$$\delta_3^1(\mathbf{a}, 1) = 1 \otimes (\tilde{\mu} \circ (\mu_2 | \mu_2) \circ \Pi)(\mathbf{a}).$$

The map  $\Pi$  is clearly continuous with respect to the tree topology, and furthermore,  $\mu_2 | \mu_2$  is continuous by Propositions 6.4 and 5.23. Note that if we topologize  $(\mathcal{K} | \mathcal{K}) \otimes_{\mathbb{I} | \mathbb{I}} \mathbf{I}$  with the tree topology, it is isomorphic to  $\mathcal{K} \otimes_{\mathbb{F}}^* \mathcal{K}$ . (See Remark 5.22). Hence, it suffices to show that  $\tilde{\mu}$  is continuous. This amounts to the following:

(m-1) For each  $n \in \mathbb{N}$ , there are  $k, m \in \mathbb{N}$  so that

$$\tilde{\mu}(J_k \otimes J_m) \subseteq J_n.$$

(m-2) For each  $n \in \mathbb{N}$  and  $x \in \mathcal{K}$ , there is an  $m \in \mathbb{N}$  so that

$$\tilde{\mu}(x \otimes J_m) \subseteq J_n \quad \text{and} \quad \tilde{\mu}(J_m \otimes x) \subseteq J_n.$$

Both of the arguments are elementary, and we illustrate the idea. Recall that  $\mathcal{U}^i \mathcal{V}^j \sigma \in J_n$  if and only if  $i \geq 0$  and  $\max(i, j) \geq n$ . If  $\mathcal{U}^i \mathcal{V}^j \sigma$  and  $\mathcal{U}^s \mathcal{V}^t \sigma$  are two monomials in  $J_n$ , then at least one of two situations occurs: both  $j, t \geq n$ ; or one of  $i$  and  $s$  is at least  $n$ . If  $j, t \geq n$ , then  $\mathcal{U}^{i+s} \mathcal{V}^{j+t} \sigma \in J_n$  since  $j+t \geq 2n$ . If one of  $i$  and  $s$  is at least  $n$ , then  $i+s \geq n$ . A symmetric analysis holds for the multiples of  $\tau$ , and we see that

$$\tilde{\mu}(J_n \otimes J_n) \subseteq J_n,$$

so (m-1) holds. A similar and elementary argument implies (m-2).  $\square$

There is an asymmetry in the merge module. Recall that we set

$$\delta_3^1(\sigma | 1, 1 | \sigma, i_0) = i_1 \otimes \sigma \quad \text{and} \quad \delta_3^1(1 | \sigma, \sigma | 1, i_0) = 0.$$

We define a different module  ${}_{\mathcal{K} | \mathcal{K}} N^{\mathcal{K}}$  by instead setting

$$\delta_3^1(\sigma | 1, 1 | \sigma, i_0) = 0 \quad \text{and} \quad \delta_3^1(1 | \sigma, \sigma | 1, i_0) = i_1 \otimes \sigma.$$

We make a similar change to the map  $\delta_3^1$  on  $\tau$  inputs.

This construction turns out to produce homotopy equivalent bimodules:

**Lemma 8.5.** *There is a homotopy equivalence of DA-bimodules*

$${}_{\mathcal{K} | \mathcal{K}} M^{\mathcal{K}} \simeq {}_{\mathcal{K} | \mathcal{K}} N^{\mathcal{K}}.$$

*Proof.* We construct a morphism  $f_{j+1}^1$  between the two bimodules. We set  $f_1^1(\mathbf{x}) = \mathbf{x} \otimes 1$ . The only other non-vanishing term is  $f_2^1$ . This map is determined by the relations

$$f_2^1(\sigma|\sigma, i_0) = i_1 \otimes \sigma \quad \text{and} \quad f_2^1(\tau|\tau, i_0) = i_1 \otimes \tau.$$

The  $DA$ -bimodule morphism structure relations for two algebra inputs which both change idempotent are given by the schematic

$$\begin{array}{c}
 a_2 \quad a_1 \quad \mathbf{x} \\
 \searrow \quad \searrow \quad \downarrow \\
 \quad \quad \quad f_1^1 \\
 \quad \quad \quad \downarrow \\
 \quad \quad \quad \delta_3^1 \\
 \quad \quad \quad \downarrow \\
 \quad \quad \quad \mu_2
 \end{array}
 +
 \begin{array}{c}
 a_2 \quad a_1 \quad \mathbf{x} \\
 \searrow \quad \searrow \quad \downarrow \\
 \quad \quad \quad \delta_3^1 \\
 \quad \quad \quad \downarrow \\
 \quad \quad \quad f_1^1 \\
 \quad \quad \quad \downarrow \\
 \quad \quad \quad \mu_2
 \end{array}
 +
 \begin{array}{c}
 a_2 \quad a_1 \quad \mathbf{x} \\
 \searrow \quad \downarrow \quad \downarrow \\
 \quad \quad \quad \mu_2 \quad \downarrow \\
 \quad \quad \quad \quad \quad f_2^1 \\
 \quad \quad \quad \quad \quad \downarrow \\
 \quad \quad \quad \quad \quad \mu_2
 \end{array}
 = 0$$

which is easily verified. The structure relations for  $n \neq 2$  algebra inputs are also easily verified.  $\square$

**8.4. The type- $A$  identity bimodule.** It is helpful to introduce another bimodule, which we denote by

$$\kappa|\kappa[\mathbb{I}^\ominus] := \kappa|\kappa M^\mathcal{K} \hat{\boxtimes} \kappa \mathcal{D}_0.$$

We call  $\kappa|\kappa[\mathbb{I}^\ominus]$  the *type- $A$  identity module*. We will use  $\kappa|\kappa[\mathbb{I}^\ominus]$  to transform type- $D$  actions into type- $A$  actions. The type- $A$  module  $\kappa|\kappa[\mathbb{I}^\ominus]$  appears in the pairing theorem, stated in Theorem 1.4.

There is a further refinement which takes into account the right  $\mathbb{F}[U]$ -action on  $\mathcal{D}_0$ . We define

$$\kappa|\kappa[\mathbb{I}^\ominus]_{\mathbb{F}[U]} := \kappa|\kappa M^\mathcal{K} \hat{\boxtimes} \kappa[\mathcal{D}_0]_{\mathbb{F}[U]}.$$

Verifying the pairing theorem with the bimodule  $\kappa|\kappa[\mathbb{I}^\ominus]_{\mathbb{F}[U]}$  turns out to be more subtle than for  $\kappa|\kappa[\mathbb{I}^\ominus]$ . Nonetheless we prove the pairing theorem with  $\kappa|\kappa[\mathbb{I}^\ominus]_{\mathbb{F}[U]}$  in Section 15.3 once we introduce the pair-of-pants bimodules.

**8.5. The knot surgery formula over  $\mathcal{K}$ .** We now describe how to view the mapping cone formula of Ozsváth and Szabó in terms of the algebra  $\mathcal{K}$ .

Recall that Ozsváth and Szabó's mapping cone formula [OS08b, Theorem 1.1] states that if  $\lambda$  is an integral framing on  $K \subseteq S^3$ , then

$$\mathbf{CF}(S_\lambda^3(K)) \cong \mathbb{X}_\lambda(K) = \text{Cone}(\mathbb{A}(K) \xrightarrow{v+h_\lambda} \mathbb{B}(K)).$$

Recall, as in Lemma 7.5, that  $\mathbb{A}(K)$  may be identified with a completion of  $\mathcal{CFK}(K)$  and  $\mathbb{B}(K)$  may be identified with a completion of  $\mathcal{V}^{-1}\mathcal{CFK}(K)$ .

We will describe the following algebraic perspectives of the mapping cone formula:

- (1) A chain complex  $\mathbb{X}_\lambda(K)$  over  $\mathbb{F}[[U]]$ .
- (2) A right type- $D$  module  $\mathcal{X}_\lambda(K)^\mathcal{K}$ .
- (3) A left type- $A$  module  ${}_\kappa\mathcal{X}_\lambda(K)$ .

These will satisfy the following relations:

$$\mathbb{X}_\lambda(K) \cong \mathcal{X}_\lambda(K)^\mathcal{K} \hat{\boxtimes} \kappa[\mathcal{D}_0] \simeq \mathcal{D}_0^\mathcal{K} \hat{\boxtimes} {}_\kappa\mathcal{X}_\lambda(K). \quad (8.1)$$

We begin with the description as a type- $D$  module. Let  $\mathbf{x}_1, \dots, \mathbf{x}_n$  be a free basis of  $\mathcal{CFK}(K)$  over  $\mathbb{F}[\mathcal{U}, \mathcal{V}]$ . We declare the underlying  $\mathbf{I}$ -module of  $\mathcal{X}_\lambda(K)^\mathcal{K}$  to be

$$\mathcal{X}_\lambda(K)^\mathcal{K} = \text{Span}_{\mathbb{F}}(\mathbf{x}_1, \dots, \mathbf{x}_n) \otimes_{\mathbb{F}} \mathbf{I}.$$

In particular, over  $\mathbb{F}$  each  $\mathbf{x}_i$  contributes one generator in each idempotent. We denote these generators by  $\mathbf{x}_i^0$  and  $\mathbf{x}_i^1$ .

The map  $\delta^1$  on  $\mathcal{X}_\lambda(K)^\mathcal{K}$  is as follows. Firstly, there are internal  $\delta^1$  summands from the differential of  $\mathcal{CFK}(K)$ . If  $\partial(\mathbf{x})$  contains a summand of  $\mathbf{y} \cdot \mathcal{U}^n \mathcal{V}^m$ , then  $\delta^1(\mathbf{x}^\varepsilon)$  contains a summand of  $\mathbf{y}^\varepsilon \otimes \mathcal{U}^n \mathcal{V}^m$ , for  $\varepsilon \in \{0, 1\}$ .

In Ozsváth and Szabó's mapping cone formula,  $v$  is the canonical inclusion of  $\mathcal{CFK}(K)$  into  $\mathcal{V}^{-1}\mathcal{CFK}(K)$ . Correspondingly,  $\delta^1(\mathbf{x}^0)$  contains a summand of the form  $\mathbf{x}^1 \otimes \sigma$ .

If  $\mathbf{y} \cdot \mathcal{U}^i \mathcal{V}^j$  is a summand of  $h_\lambda(\mathbf{x})$  then we define  $\delta^1(\mathbf{x}^0)$  to have a summand of the form

$$\mathbf{y}^1 \otimes \mathcal{U}^i \mathcal{V}^j \tau.$$

**Lemma 8.6.**  $\mathcal{X}_\lambda(K)^\mathcal{K}$  is a type- $D$  module.

*Proof.* The proof is a formal consequence of the fact that  $\partial^2 = 0$  on  $\mathcal{CFK}(K)$ , that  $v$  and  $h_\lambda$  are chain maps, and that  $v$  and  $h_\lambda$  satisfy the equivariance properties of Lemma 7.7.

In more detail, suppose that  $\mathbf{x}_1, \dots, \mathbf{x}_n$  is a free basis of  $\mathcal{CFK}(K)$ , and consider

$$((\text{id}_{\mathcal{X}} \otimes \mu_2) \circ (\delta^1 \otimes \text{id}_{\mathcal{K}}) \circ \delta^1)(\mathbf{x}_i^\varepsilon) \quad (8.2)$$

For concreteness, consider the case when  $\varepsilon = 0$ . There are three sources of terms in the above expression: those arising from two applications of  $\partial$ , those arising from one  $v$  and one  $\partial$ , and those arising from one  $h_\lambda$  and one  $\partial$ . Consider the terms with two  $\partial$  terms. Write  $\partial(\mathbf{x}_i) = \sum_{j=1}^n \mathbf{x}_j \cdot f_{j,i}$ . The terms with two  $\partial$  terms are simply

$$\sum_{k=1}^n \mathbf{x}_k^0 \otimes \left( \sum_{j=1}^n f_{k,j} f_{j,i} \right),$$

which is 0 since  $\partial^2 = 0$ . Similarly, the terms corresponding to one  $\partial$  and one  $v$  are given by the formula

$$\sum_{j=1}^n \mathbf{x}_j^1 \otimes (\sigma f_{j,i} + f_{j,i} \sigma)$$

which clearly vanishes.

Finally, we consider the terms corresponding to one  $\partial$  and one  $h_\lambda$ . Write  $h_\lambda(\mathbf{x}_i) = \sum_{j=1}^n \mathbf{x}_j \cdot g_{j,i}$ , where  $g_{j,i} \in \mathbb{F}[\mathcal{U}, \mathcal{V}, \mathcal{V}^{-1}]$ . The corresponding terms of Equation (8.2) are

$$\sum_{k=1}^n \mathbf{x}_k^1 \otimes \left( \sum_{j=1}^n g_{k,j} \tau f_{j,i} + f_{k,j} g_{j,i} \tau \right) = \sum_{k=1}^n \mathbf{x}_k^1 \otimes \left( \sum_{j=1}^n g_{k,j} T(f_{j,i}) + f_{k,j} g_{j,i} \right) \tau \quad (8.3)$$

However  $\sum_{j=1}^n g_{k,j} T(f_{j,i}) + f_{k,j} g_{j,i}$  is the  $\mathbf{x}_k$  coefficient of  $[\partial, h_\lambda](\mathbf{x}_i)$ , since  $h_\lambda$  satisfies  $h_\lambda(\mathbf{x} \cdot a) = h_\lambda(\mathbf{x}) \cdot T(a)$ , by Lemma 7.7. In particular, Equation (8.3) vanishes. The case when  $\varepsilon = 1$  is similar.  $\square$

Having defined the type- $D$  module  $\mathcal{X}_\lambda(K)^\mathcal{K}$ , we may now define the type- $A$  module

$${}_{\mathcal{K}}\mathcal{X}_\lambda(K) := \mathcal{X}_\lambda(K)^\mathcal{K} \hat{\boxtimes}_{\mathcal{K}|\mathcal{K}} [\mathbb{I}^{\boxplus}].$$

**8.6. The link surgery formula over  $\mathcal{L}$ .** In this section, we describe how to view Manolescu and Ozsváth's link surgery formula as a type- $D$  module.

Recall that we define

$$\mathcal{L}_\ell := \mathcal{K}_1 \otimes_{\mathbb{F}} \cdots \otimes_{\mathbb{F}} \mathcal{K}_\ell.$$

where each  $\mathcal{K}_i$  denotes a copy of  $\mathcal{K}$ .

Let  $L$  be an  $\ell$ -component link in  $S^3$  with integral framing  $\Lambda$ . The link surgery complexes require a choice of auxiliary data, which we call a *system of arcs*  $\mathcal{A}$ . We will discuss these in detail in Section 9.1 below. If  $\mathcal{A}$  is chosen, Manolescu and Ozsváth's construction produces a chain complex  $\mathcal{C}_\Lambda(L, \mathcal{A})$  over  $\mathbb{F}[U_1, \dots, U_\ell]$ . In this section, we will describe how to construct a type- $D$  module

$$\mathcal{X}_\Lambda(L, \mathcal{A})^{\mathcal{L}_\ell},$$

based on their construction of  $\mathcal{C}_\Lambda(L, \mathcal{A})$ .

There is an identification of  $\mathcal{L}_\ell$ -idempotents with points of the cube  $\mathbb{E}_\ell$ . Write  $\mathbf{E}_\ell$  for the ring of idempotents of  $\mathcal{L}_\ell$ . If  $\mathbf{x}_1, \dots, \mathbf{x}_n$  is a free basis of  $\mathcal{CFL}(L)$  over  $\mathbb{F}[\mathcal{U}_1, \dots, \mathcal{U}_\ell, \mathcal{V}_1, \dots, \mathcal{V}_\ell]$ , then we define the generators of  $\mathcal{X}_\Lambda(L, \mathcal{A})^{\mathcal{L}_\ell}$  to be

$$\text{Span}_{\mathbb{F}}(\mathbf{x}_1, \dots, \mathbf{x}_n) \otimes_{\mathbb{F}} \mathbf{E}_\ell$$

In particular, if  $\mathbf{x}$  is a basis element of  $\mathcal{CFL}(L)$ , we have a generator  $\mathbf{x}^\varepsilon$  for each  $\varepsilon \in \mathbb{E}_\ell$ .

If  $M \subseteq L$ , write  $\varepsilon(M) \in \mathbb{E}_\ell$  for the coordinate such that  $\varepsilon(M)_i = 0$  if  $L_i \notin M$  and  $\varepsilon(M)_i = 1$  if  $L_i \in M$ .

Suppose that  $\mathbf{x}$  is a basis element of  $\mathcal{CFL}(L)$  and  $M \subseteq L$ . By Lemma 7.5, we may view  $\mathbf{x}^{\varepsilon(M)}$  as an element of the group  $\mathcal{C}_\Lambda(L, \mathcal{A}) = \prod_{\mathbf{s} \in \mathbb{H}(L)} \mathfrak{A}(\mathcal{H}^{L-M}, \psi^M(\mathbf{s}))$ . Suppose also that  $\vec{N}$  is an oriented sublink of  $L - M$ , and that  $\Phi^{\vec{N}}(\mathbf{x}^{\varepsilon(M)})$  has a summand of  $\mathbf{y}^{\varepsilon(M \cup N)} \cdot f$ , where we view  $f$  as an element of the  $2\ell$ -variable polynomial ring, localized at the variables  $\mathcal{V}_i$  such that  $L_i \subseteq N$ . We may naturally view  $f$  as being an element of

$$\mathbf{E}_{\varepsilon(M \cup N)} \cdot \mathcal{L}_\ell \cdot \mathbf{E}_{\varepsilon(M \cup N)}.$$

There is an algebra element  $t_{\varepsilon(M), \varepsilon(M \cup N)}^{\vec{N}} \in \mathbf{E}_{\varepsilon(M \cup N)} \cdot \mathcal{L}_\ell \cdot \mathbf{E}_{\varepsilon(M)}$  which is the tensor of  $\sigma_i$  for  $i$  such that  $L_i \subseteq \vec{N}$  and  $L_i$  is oriented the same as  $L$ ,  $\tau_i$  for  $i$  such that  $L_i \subseteq \vec{N}$  and  $L_i$  is oriented oppositely from  $L$ , and 1 for  $i$  such that  $L_i \notin N$ . With this notation, we declare  $\delta^1(\mathbf{x}^\varepsilon)$  to have the summand

$$\mathbf{y}^{\varepsilon(M \cup N)} \otimes f \cdot t_{\varepsilon(M), \varepsilon(M \cup N)}^{\vec{N}}.$$

**Lemma 8.7.**  $\mathcal{X}_\Lambda(L, \mathcal{A})^{\mathcal{L}_\ell}$  is a type- $D$  module.

*Proof.* The proof is similar to Lemma 8.6. If  $\vec{N} \subseteq L$  is an oriented sublink, let us write  $D^{\vec{N}}$  for the sum of the maps  $\Phi^{\vec{J}}$  for all oriented sublinks  $\vec{J} \subseteq \vec{N}$ , as well as the internal differentials of  $\mathcal{CFL}(L)$ . By [MO10, Proposition 9.4], the map  $D^{\vec{N}}$  squares to 0.

Let  $\mathbf{x}$  and  $\mathbf{y}$  be basis elements of  $\mathcal{CFL}(L)$ , and suppose that  $\varepsilon \leq \varepsilon'$  are coordinates of  $\mathbb{E}_\ell$ . We consider the  $\mathbf{y}^{\varepsilon'}$  component of

$$\left( (\text{id}_{\mathcal{X}} \otimes \mu_2) \circ (\delta^1 \otimes \text{id}_{\mathcal{L}_\ell}) \circ \delta^1 \right) (\mathbf{x}^\varepsilon) \tag{8.4}$$

If  $\varepsilon = \varepsilon'$ , then the  $\mathbf{y}^{\varepsilon'}$  component of Equation (8.4) vanishes since  $\mathcal{CFL}(L)$  is a chain complex.

Suppose that  $\varepsilon < \varepsilon'$ . Let  $N$  be the sublink corresponding to  $\varepsilon' - \varepsilon$ , and let  $\vec{N}$  be a fixed orientation on  $N$ . We consider the sum of all terms of Equation (8.4) which are of the form  $\mathbf{y}^{\varepsilon'} \otimes f \cdot t_{\varepsilon, \varepsilon'}^{\vec{N}}$ , for some  $f \in \mathbf{E}_{\varepsilon'} \cdot \mathcal{L}_\ell \cdot \mathbf{E}_{\varepsilon'}$ . These are all contributed by the link surgery maps for oriented sublinks of  $\vec{N}$ . Lemma 7.7 can be used to show that this term is  $\mathbf{y}^{\varepsilon'} \otimes f \cdot t_{\varepsilon, \varepsilon'}^{\vec{N}}$ , where  $f$  is the coefficient of  $\mathbf{y}^{\varepsilon'}$  in  $(D^{\vec{N}} \circ D^{\vec{N}})(\mathbf{x}^\varepsilon)$ . In particular, Equation (8.4) vanishes by [MO10, Proposition 9.4], completing the proof.  $\square$

Given a collection of integers  $\Lambda = (\lambda_1, \dots, \lambda_\ell)$ , there is a type- $A$  module

$$\mathcal{L}_\ell \mathcal{D}_\Lambda$$

defined by taking the external tensor product of the modules  $\mathcal{K}[\mathcal{D}_{\lambda_i}]$  from Section 8.2. There is also a right action of  $\mathbb{F}[U_1, \dots, U_\ell]$ , and  $\mathcal{D}_\Lambda$  may be viewed as an  $AA$ -bimodule

$$\mathcal{L}_\ell[\mathcal{D}_\Lambda]_{\mathbb{F}[U_1, \dots, U_\ell]}.$$

The following is immediate from the definition of  $\mathcal{X}_\Lambda(L, \mathcal{A})^{\mathcal{L}_\ell}$ :

**Proposition 8.8.** *There is a chain isomorphism*

$$\mathcal{C}_\Lambda(L)_{\mathbb{F}[U_1, \dots, U_\ell]} \cong \mathcal{X}_\Lambda(L)^{\mathcal{L}_\ell} \hat{\boxtimes} \mathcal{L}_\ell[\mathcal{D}_{(0, \dots, 0)}]_{\mathbb{F}[U_1, \dots, U_\ell]}.$$

We will also need to consider type- $A$  and type- $DA$  versions of the link surgery formula. An important special case is when we have a distinguished component  $K_i \subseteq L$ . We define a bimodule  $\mathcal{K}\mathcal{X}_\Lambda(L)^{\mathcal{L}_{\ell-1}}$ , where the  $\mathcal{K}$ -input corresponds to  $K_i$  by setting

$$\mathcal{K}\mathcal{X}_\Lambda(L)^{\mathcal{L}_{\ell-1}} := \mathcal{X}_\Lambda(L)^{\mathcal{L}_\ell} \hat{\boxtimes}_{\mathcal{K}|\mathcal{K}[\mathbb{I}^\mathbb{D}]},$$

where the tensor product is taken along the algebra component corresponding to  $K_i$ . In the above equation,  $\mathcal{K}|\mathcal{K}[\mathbb{I}^\mathbb{D}]$  is the bimodule from Section 8.4. More generally, we may turn more algebra components from type- $D$  to type- $A$  by tensoring additional copies of  $\mathcal{K}|\mathcal{K}[\mathbb{I}^\mathbb{D}]$ .

## 9. $\sigma$ -BASIC SYSTEMS OF HEEGAARD DIAGRAMS

In this section, we define the notion of a  $\sigma$ -basic system of Heegaard diagrams. The notion is a very small generalization of Manolescu and Ozsváth's *basic system*. These are collections of Heegaard diagrams which can be used to compute the link surgery formula. We use the small distinction in notation to disambiguate the notions, and to highlight the algebraic significance of these systems. For these systems, the maps  $\Phi^{\vec{N}}$  vanish unless  $\vec{N} = +K$  (i.e. a single component, oriented consistently with  $L$ ), or  $\vec{N}$  contains only negatively oriented components relative to  $L$ . We also describe how to construct a  $\sigma$ -basic system for the connected sum of two links.

**9.1. Systems of arcs.** In this section, we define the notion of a *system of arcs*, which is a necessary piece of auxiliary data used to define the link surgery formula.

**Definition 9.1.** Suppose that  $(S^3, L, \mathbf{w}, \mathbf{z})$  is an oriented, multi-pointed link, which is link minimal (i.e. each component of  $L$  contains exactly one basepoint of  $\mathbf{w}$ , and one basepoint of  $\mathbf{z}$ ).

- (1) A *system of arcs* for  $L$  consists of a set  $\mathcal{A} = \{\lambda_1, \dots, \lambda_n\}$  of pairwise disjoint arcs satisfying that  $\partial\lambda_i = \lambda_i \cap L = \{w_i, z_i\}$ .

- (2) We say that an arc  $\lambda_i$  is *beta-parallel* if  $\lambda_i$  is isotopic to a push-off of the subarc of  $L_i$  which goes from  $z_i$  to  $w_i$ .
- (3) We say that  $\lambda_i$  is *alpha-parallel* if  $\lambda_i$  is isotopic to a push-off of the subarc of  $L_i$  which goes from  $w_i$  to  $z_i$ .

Note that an arc  $\lambda_i$  is beta-parallel if for any Heegaard diagram of  $(Y, L, \mathbf{w}, \mathbf{z})$ ,  $\lambda_i$  is isotopic to the subarc of  $K_i \subseteq L$  which lies in the beta handlebody  $U_\beta$ . A similar remark holds for alpha-parallel arcs.

Given a link minimal  $(L, \mathbf{w}, \mathbf{z})$  there are two distinguished systems of arcs,  $\mathcal{A}_\alpha$  and  $\mathcal{A}_\beta$ , which are the ones which have only alpha-parallel arcs, or only beta-parallel arcs, respectively.

*Remark 9.2.* Manolescu and Ozsváth's notion of *good sets of trajectories* [MO10, Definition 8.26] corresponds to our notion of a system of alpha-parallel arcs.

**9.2.  $\sigma$ -basic systems of Heegaard diagrams.** In this section, we define the notion of a  $\sigma$ -basic system of Heegaard diagrams. Our notion is a small adaptation of Manolescu and Ozsváth's construction.

**Definition 9.3.** Suppose that  $(L, \mathbf{w}, \mathbf{z})$  is a minimally pointed,  $n$ -component link in a 3-manifold  $Y$ , and suppose that  $\mathcal{A}$  is a system of arcs for  $(Y, L, \mathbf{w}, \mathbf{z})$ . A  $\sigma$ -basic system of Heegaard diagrams for  $(Y, L, \mathcal{A})$  consists of a collection of Heegaard diagrams  $\mathcal{H}(M) = (\mathcal{H}_\varepsilon)_{\varepsilon \in \mathbb{E}(\mathbf{d}_M)}$  for each oriented sublink  $M \subseteq -L$  (i.e.  $M \subseteq L$  and each component oriented oppositely to  $L$ ) which satisfy the following compatibility conditions:

- (1) The diagram  $\mathcal{H} = (\Sigma, \boldsymbol{\alpha}, \boldsymbol{\beta}, \mathbf{w}, \mathbf{z}) := \mathcal{H}(\emptyset)$  is a weakly admissible diagram, embedded in  $Y$ . Furthermore, all of the Heegaard diagrams  $\mathcal{H}_\varepsilon$  have underlying Heegaard surface  $\Sigma$ .
- (2) The arcs  $\lambda_i \in \mathcal{A}$  are embedded in  $\Sigma$ .
- (3) For each  $M$ ,  $\mathbf{d}_M = (d_1, \dots, d_m)$  is a tuple of  $m = |M|$ -positive numbers. Furthermore, we have a chosen bijection of  $\{1, \dots, m\}$  with the components of  $M$ .
- (4) If  $E_m$  is an  $m$ -dimensional unit subcube of  $\mathbb{E}(\mathbf{d})$ , then the corresponding subcube  $\mathcal{H}(M)_{E_m} := (\mathcal{H}_\varepsilon)_{\varepsilon \in E_m}$  is constructed by the following procedure:
  - (a) Each axis direction of  $E_m$  is labeled as an *alpha-direction*, a *beta-direction*, or a *surface isotopy direction*. Write  $\mathbb{A}$ ,  $\mathbb{B}$  and  $\mathbb{S}$  for the subsets of  $\{1, \dots, m\}$  corresponding to the alpha, beta and surface isotopy directions.
  - (b) We assume that there are hypercubes of handleslide equivalent alpha and beta attaching curves  $\mathcal{L}_\alpha, \mathcal{L}_\beta$  on  $(\Sigma, \mathbf{w}_M, \mathbf{z}_M, \mathbf{f})$ . Each axis direction of  $\mathcal{L}_\alpha$  is identified with a direction in  $\mathbb{A}$ , and each axis direction in  $\mathcal{L}_\beta$  is identified with a direction in  $\mathbb{B}$ . Here,  $\mathbf{w}_M$  consists of basepoints in  $\mathbf{w}$  which are not in  $M$ , and similarly for  $\mathbf{z}$ . Also,  $\mathbf{f}$  consists of  $m$  free basepoints, each identified with a component of  $M$ . (The set  $\mathbf{f}$  depends on  $M$  and  $E_m$ ).
  - (c) If  $\mathbb{S} = \{i_1, \dots, i_j\}$ , we assume there is a collection of subarcs  $l_{i_1}, \dots, l_{i_j}$  of  $\lambda_{i_1}, \dots, \lambda_{i_j} \in \mathcal{A}$ , respectively. We assume  $l_{i_s}$  is oriented compatibly with  $\lambda_{i_s}$  for each  $s$ . We assume also that each  $l_{i_s}$  has  $f_{i_s} \in \mathbf{f}$  as its initial endpoint. Here  $0 \leq j \leq m$ .
  - (d) We assume there are surface isotopies  $\phi_{i_1}, \dots, \phi_{i_j}$  of  $\Sigma$  chosen, such that  $\phi_{i_s}$  moves  $f_{i_s}$  to the other endpoint of  $l_{i_s}$  and is supported in a small neighborhood of the arc  $l_{i_s}$ .

With the above data chosen, the cube  $\mathcal{H}_{E_m}^M$  is constructed by taking the paired hypercube  $\mathbf{CF}(\mathcal{L}_\alpha, \mathcal{L}_\beta)$  and then iteratively taking the mapping cone over the tautological maps induced by  $\phi_{i_s}$ . E.g. in the case that  $j = 1$ , we obtain

$$\text{Cone} \left( \phi_{i_1} : \mathbf{CF}(\mathcal{L}_\alpha, \mathcal{L}_\beta) \rightarrow \mathbf{CF}(\phi_{i_1}(\mathcal{L}_\alpha), \phi_{i_1}(\mathcal{L}_\beta)) \right)$$

We additionally assume the following coherence condition is satisfied:

- (1) Suppose that  $M_1 \subseteq M_2 \subseteq -L$ . Write  $\{i_1, \dots, i_s\} \subseteq \{1, \dots, m\}$  for the indices of the components of  $M_2 - M_1$ . For  $\varepsilon \in \mathbb{E}_s$ , let  $\mathcal{H}(M_2)_\varepsilon$  denote the dimension  $|M_1|$  sub-hyperbox of  $\mathcal{H}(M_2)$  consisting of the points  $\nu \in \mathbb{E}(\mathbf{d}_{M_2})$  such that if  $K_{i_j} \subseteq M_2 - M_1$ , then  $\nu_{i_j} = 0$  if  $\varepsilon_j = 0$ , and  $\nu_{i_j}$  is maximal if  $\varepsilon_j = 1$ . We assume that for each  $\varepsilon \in \mathbb{E}_s$ , the hyperbox  $\mathcal{H}(M_2)_\varepsilon$  is obtained from  $\mathcal{H}(M_1)$  by deleting the  $\mathbf{w}$ -basepoint of each component  $K \subseteq M_2 - M_1$  which has  $\varepsilon$ -component 0, and by deleting the  $\mathbf{z}$ -basepoint of each component  $K \subseteq M_2 - M_1$  which has  $\varepsilon$ -component 1. We assume the remaining basepoints of  $M_2 - M_1$  are turned into free basepoints.

The following definition plays an important role in our proof of the connected sum formula for surgery hypercubes:

**Definition 9.4.** Suppose that  $\mathcal{L}_\beta = (\beta_\varepsilon, \mathbf{w}, \mathbf{z}, \mathbf{f})_{\varepsilon \in \mathbb{E}_n}$  is a weakly admissible hypercube of handleslide equivalent beta-attaching curves such that  $\mathbf{w}$  and  $\mathbf{z}$  contain no free-basepoints, and  $\mathbf{f}$  consists only of free-basepoints. We say  $\mathcal{L}_\beta$  is *algebraically rigid* if each  $\mathbb{T}_{\beta_\varepsilon} \cap \mathbb{T}_{\beta_{\varepsilon'}}$  has  $2^{g(\Sigma) + |\mathbf{w}| + |\mathbf{f}| - 1}$  intersection points (the minimal possible number). We make a parallel definition for alpha hyperboxes. We say a hyperbox of attaching curves is algebraically rigid if each sub-hypercube is algebraically rigid. We say that a  $\sigma$ -basic system of Heegaard diagrams is algebraically rigid if each hypercube of attaching curves in its construction is algebraically rigid.

**9.3. Meridional  $\sigma$ -basic systems.** In this section, we describe a particular family of  $\sigma$ -basic systems which are useful in our proof of the pairing system. Similar diagrams are ubiquitous in Heegaard Floer theory. For example they are the diagrams which Ozsváth and Szabó use to prove the mapping cone formula [OS08b].

**Definition 9.5.** We say that a  $\sigma$ -basic system of Heegaard diagrams  $\mathcal{H}$  for  $(Y, L)$ , with a system of arcs  $\mathcal{A}$ , is a *meridional  $\sigma$ -basic system* if the following hold:

- (1) Each arc of  $\mathcal{A}$  is either beta-parallel or alpha-parallel.
- (2) The diagram  $\mathcal{H}(\emptyset) = (\Sigma, \boldsymbol{\alpha}, \boldsymbol{\beta}, \mathbf{w}, \mathbf{z})$  has the following property. Suppose  $K_i \in L$  is a component with corresponding arc  $\lambda_i \in \mathcal{A}$  and basepoints  $w_i, z_i$ . Then  $\lambda_i$  is either alpha-parallel or beta-parallel. If  $\lambda_i$  is alpha-parallel, then  $\lambda_i$  is disjoint from the alpha curves, and intersects a single beta curve  $\beta_i^s$ . A similar assumption is made if  $\lambda_i$  is beta-parallel. In particular, if  $|L| = n$ , there are  $n$  special alpha and beta circles, denoted  $\alpha_i^s$  and  $\beta_j^s$ .
- (3) In each Heegaard diagram of  $\mathcal{H}$ , there are similarly  $n$  special alpha and beta curves, and the rest are designated as non-special. The non-special alpha curves of each subcube of  $\mathcal{H}$  consist of small Hamiltonian translates of the non-special curves of  $\mathcal{H}$ .
- (4) If  $K_i \subseteq L$  is a component whose arc  $\lambda_i$  is beta-parallel, then the component of  $\Sigma \setminus \boldsymbol{\beta}$  which contains the basepoints of  $K$  is a punctured disk which contains



a special beta circle  $\beta_i^s$  as two of its boundary components. Gluing the two  $\beta_i^s$  boundary components together, we obtain a punctured torus. We assume that  $K$ -axis direction of  $\mathcal{H}$  realizes the isotopy of  $\beta_i^s$  in a loop around this punctured torus (handlesliding  $\beta_i^s$  over the boundary punctures). We make an analogous assumption for components with beta-parallel decoration.

**Lemma 9.6.** *Suppose  $L$  is an  $\ell$ -component link in  $S^3$  and  $\mathcal{A}$  is a system of arcs for  $L$  such that each arc is either alpha-parallel or beta-parallel. Then there exists a link minimal, weakly admissible, algebraically rigid  $\sigma$ -basic system of Heegaard diagrams for  $(S^3, L, \mathcal{A})$ .*

*Proof.* Except for the claim about admissibility, existence of such a  $\sigma$ -basic system follows since the construction is given in Definition 9.5.

Admissibility is verified as follows. We first verify admissibility for each hypercube of alpha and beta Lagrangians appearing in the construction. For concreteness, suppose that  $\mathcal{L}_\alpha$  is a hypercube of alpha attaching curves appearing in the construction. For appropriately chosen Hamiltonian translates, admissibility of  $\mathcal{L}_\alpha$  is equivalent to admissibility of the diagram where we delete the tuples of curves which appear only as small translates of each other, and surger  $\Sigma$  along these curves as well. The resulting Heegaard diagram is a union of tori, and admissibility is straightforward to arrange. See Figure 9.1.

Admissibility of each pair  $(\mathcal{L}_\alpha, \mathcal{L}_\beta)$  may be arranged by winding one of the cubes (say  $\mathcal{L}_\alpha$ ) relative to  $\mathcal{L}_\beta$ , following the procedure described in [OS04b, Section 4.2.2] and [OS08a, Section 3.4].  $\square$

**9.4. Basic systems for general systems of arcs.** We now consider general systems of arcs. Generalizing Lemma 9.6, we prove the following:

**Lemma 9.7.** *Suppose that  $\mathcal{A}$  is a system of arcs for  $L \subseteq S^3$ . Then there is an algebraically rigid  $\sigma$ -basic system of Heegaard diagrams for  $(L, \mathcal{A})$ .*

*Proof.* The proof is similar to the proof of Lemma 9.6. We begin with a minimally pointed Heegaard diagram  $(\Sigma, \alpha, \beta, \mathbf{w}, \mathbf{z})$  for  $(Y, L)$  such that each arc  $\lambda_i$  is embedded in  $\Sigma$  and such that the arcs  $\lambda_i$  are pairwise disjoint. By performing an isotopy of  $\alpha$  and  $\beta$  supported in a neighborhood of the arcs  $\lambda_i$ , we may assume that each  $\lambda_i$  is the concatenation of two arcs  $\lambda_i^\alpha$  and  $\lambda_i^\beta$  such that  $\lambda_i^\alpha$  is disjoint from  $\beta$  and  $\lambda_i^\beta$  is disjoint from  $\alpha$ . We assume that  $\partial\lambda_i^\beta = \{z_i, x_i\}$  and  $\partial\lambda_i^\alpha = \{w_i, x_i\}$ , for some point  $x_i \in \Sigma$ .

We now stabilize the Heegaard diagram  $2|L|$  times, as shown in Figure 9.2. For each  $\lambda_i$ , we introduce two stabilizations. One of the stabilizations corresponds to attaching a 1-handle with feet near  $z_i$  and  $x_i$ . We introduce a new alpha and a new beta curve. The alpha curve runs parallel to  $\lambda_i^\beta$ . The new beta curve, denoted  $\beta_i^s$ , is the belt-sphere of the 1-handle. Similarly, the other stabilization corresponds to attaching a 1-handle with feet near  $x_i$  and  $w_i$ . Here, the new beta curve runs parallel to  $\lambda_i^\alpha$ . The new alpha curve,  $\alpha_i^s$ , is the belt sphere of the 1-handle.

We write  $(\Sigma', \alpha', \beta', \mathbf{w}, \mathbf{z})$  for the stabilized Heegaard diagram. We handleslide the arcs  $\lambda_i$  into the new stabilization tubes to obtain arcs  $\lambda'_i \subseteq \Sigma'$ . The arcs  $\lambda'_1, \dots, \lambda'_{|L|}$  are still isotopic to the arcs in  $\mathcal{A}$ .

By definition of a Heegaard link diagram, the basepoints  $w_i, z_i \in \Sigma$  are contained in a single component  $A_i \subseteq \Sigma \setminus \alpha$  and also a single component  $B_i \subseteq \Sigma \setminus \beta$ . Note that the

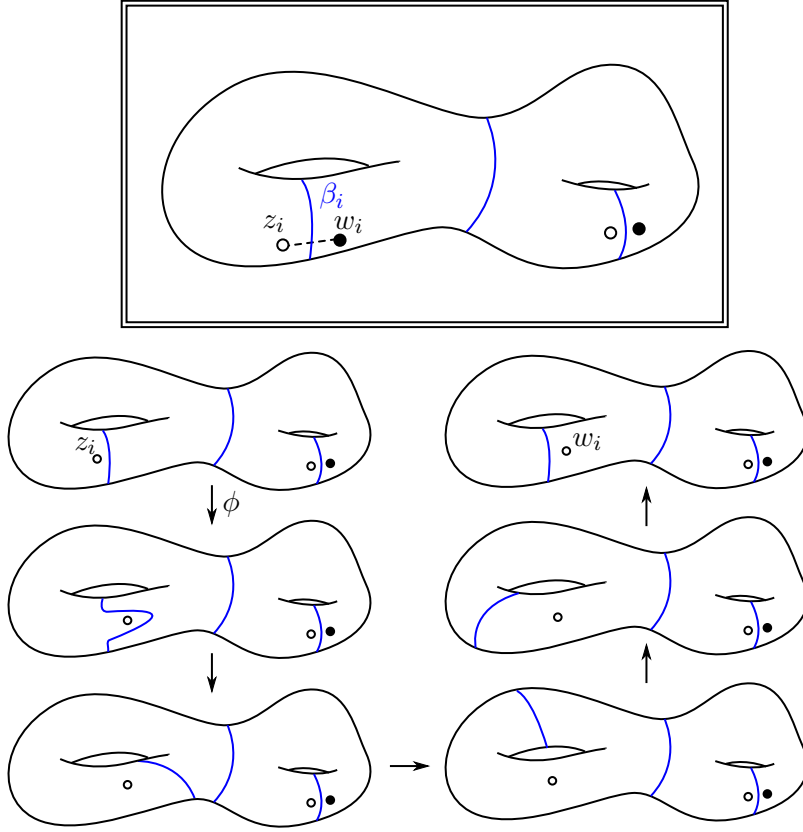

FIGURE 9.1. Some of the beta curves and a basepoint translation from Lemma 9.6. The first arrow is a basepoint translation, and the remainder are holomorphic polygon counting maps. The dashed arc on the top is  $c_i$ .

point  $x_i \in \Sigma$  is contained in  $A_i$  since there is a path  $\lambda_i^\beta$  from  $x_i$  to  $z_i$  which is disjoint from  $\alpha$ . Similarly  $x_i \in B_i$ . Write  $A'_i$  and  $B'_i$  for the analogous components of  $\Sigma' \setminus \alpha'$  and  $\Sigma' \setminus \beta'$ . Note that  $A'_i$  is obtained by removing four disks from  $A_i$ , and similarly for  $B'_i$ .

We define our  $\sigma$ -basic system of Heegaard diagrams as follows. In the  $i$ -th axis direction, we first move  $\beta_i^s$  around  $B_i$  by a sequence of handleslides across the curves of  $\beta$ . This is similar to the case of meridional  $\sigma$ -basic systems in Lemma 9.6. We perform a sequence of isotopies and handleslides to move  $\beta_i^s$  to the other side of  $z_i$ , so that  $z_i$  may be moved to  $x_i$  without crossing any attaching curves. Write  $z'_i$  for  $x_i$ , thought of as a basepoint. The next step in the  $i$ -th axis direction is to move  $\alpha_i^s$  around  $A_i$  so that it moves to the other side of  $z'_i$ , allowing  $z'_i$  to be moved to  $w_i$ .

Note that since  $\beta_i^s$  moves only around  $B'_i$ , and  $\alpha_i^s$  moves only around  $A'_i$ , the  $\beta_i^s$  may be moved around simultaneously (for different  $i$ ) and similarly different  $\alpha_i^s$  may be moved simultaneously. Additionally, the original curves  $\alpha$  and  $\beta$  are also unchanged in this process. In particular, we may build the different axis directions of the hypercube

simultaneously to build the  $\sigma$ -basic system of Heegaard diagrams. By a similar argument to Lemma 9.6, we may choose the constituent hypercubes of attaching circles to be algebraically rigid and weakly admissible.  $\square$

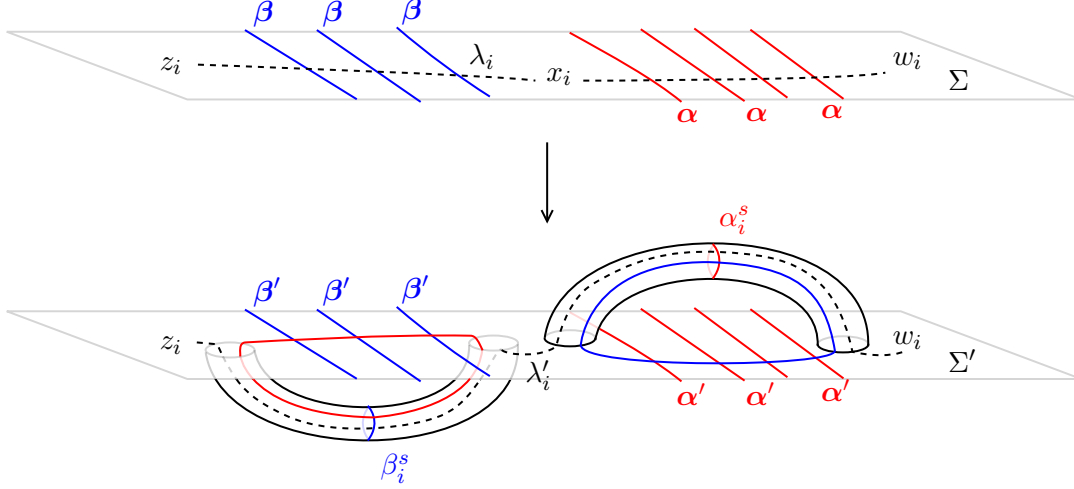

FIGURE 9.2. Top: the Heegaard surface  $(\Sigma, \alpha, \beta, \mathbf{w}, \mathbf{z})$  and the arc  $\lambda_i$  from Lemma 9.7. Bottom: the stabilized Heegaard surface  $(\Sigma', \alpha', \beta', \mathbf{w}, \mathbf{z})$  and the arc  $\lambda'_i$ . Also shown are the special curves  $\alpha_i^s$  and  $\beta_i^s$ .

**9.5. Tensor products of hypercubes of attaching curves.** If  $\mathcal{L}_\beta$  is a hypercube of attaching curves on  $(\Sigma, \mathbf{w}, \mathbf{z})$ , and  $\mathcal{L}_{\beta'}$  is a hypercube of attaching curves on  $(\Sigma', \mathbf{w}', \mathbf{z}')$ , of dimensions  $n$  and  $m$ , respectively, we now define an  $(n + m)$ -dimensional hypercube  $\mathcal{L}_\beta \otimes \mathcal{L}_{\beta'}$  on  $(\Sigma \sqcup \Sigma', \mathbf{w} \cup \mathbf{w}', \mathbf{z} \cup \mathbf{z}')$ . We note that the construction of  $\mathcal{L}_\beta \otimes \mathcal{L}_{\beta'}$  is essentially identical to Lipshitz, Ozsváth and Thurston's construction of a *connected sum of chain complexes of attaching circles* [LOT16, Definition 3.40].

We begin with the underlying attaching curves of  $\mathcal{L}_\beta \otimes \mathcal{L}_{\beta'}$ , which we denote by  $(\delta_{(\varepsilon, \nu)})_{(\varepsilon, \nu) \in \mathbb{E}_n \times \mathbb{E}_m}$ , where  $n = \dim(\mathcal{L}_\beta)$  and  $m = \dim(\mathcal{L}_{\beta'})$ . We set  $\delta_{(\varepsilon, \nu)}$  to be a small translation of  $\beta_\varepsilon \cup \beta'_\nu$ . We assume the small translations are chosen so that the copies of  $\beta_\varepsilon$  from  $\delta_{(\varepsilon, \nu)}$  and  $\delta_{(\varepsilon', \nu')}$  intersect in  $2^{g(\Sigma) + |\mathbf{w}| - 1}$  points, and similarly for the translated curves on  $\Sigma'$ .

Before defining the morphisms of  $\mathcal{L}_\beta \otimes \mathcal{L}_{\beta'}$  we begin with some helpful terminology:

**Definition 9.8.** If  $\varepsilon, \varepsilon' \in \mathbb{E}_n$ , we say that there is an *arrow* from  $\varepsilon$  to  $\varepsilon'$  if  $\varepsilon < \varepsilon'$ .

- (1) We say that an arrow from  $(\varepsilon, \nu) \in \mathbb{E}_n \times \mathbb{E}_m$  to  $(\varepsilon', \nu')$  is *mixed* if  $\varepsilon < \varepsilon'$  and  $\nu < \nu'$ .
- (2) We say that an arrow from  $(\varepsilon, \nu)$  to  $(\varepsilon', \nu')$  is *non-mixed* if  $\varepsilon = \varepsilon'$  or  $\nu = \nu'$ .

We now describe the morphisms of  $\mathcal{L}_\beta \otimes \mathcal{L}_{\beta'}$ . We define the chains in  $\mathcal{L}_\beta \otimes \mathcal{L}_{\beta'}$  for each mixed arrow to be zero. For the arrow from  $(\varepsilon, \nu)$  to  $(\varepsilon, \nu')$ , where  $\nu < \nu'$ , we use the chain

$$\Theta_{\varepsilon, \varepsilon}^+ \otimes \Theta_{\nu, \nu'},$$

where  $\Theta_{\varepsilon, \varepsilon}^+$  denotes the top degree generator (recall that we have perturbed one copy of  $\beta_\varepsilon$  slightly in the definition), and  $\Theta_{\nu, \nu'}$  denotes the chain from  $\mathcal{L}_{\beta'}$ . Similarly, for the arrow from  $(\varepsilon, \nu)$  to  $(\varepsilon', \nu)$ , where  $\varepsilon < \varepsilon'$ , we use the chain

$$\Theta_{\varepsilon, \varepsilon'} \otimes \Theta_{\nu, \nu'}^+.$$

*Remark 9.9.* We will only use the above construction in the case that  $\mathcal{L}_\beta$  and  $\mathcal{L}_{\beta'}$  are algebraically rigid. In this case,  $\mathcal{L}_\beta \otimes \mathcal{L}_{\beta'}$  is also algebraically rigid, and the hypercube relations are automatic.

**9.6. Basic systems and connected sums.** In this section, we define a connected sum operation on  $\sigma$ -basic systems of Heegaard diagrams.

We begin by defining a connected sum operation for systems of arcs. Let  $L_1$  and  $L_2$  be links in  $S^3$ , with distinguished components  $K_1$  and  $K_2$ , respectively. If  $\mathcal{A}_1$  and  $\mathcal{A}_2$  are two systems of arcs for  $L_1$  and  $L_2$ , we can form their connected sum  $\mathcal{A}_1 \# \mathcal{A}_2$  by taking the connected sum of  $L_1$  and  $L_2$  at  $w_1 \in L_1$  and  $z_2 \in L_2$ . We then concatenate the arcs for the components  $K_1$  and  $K_2$  to obtain the arc for  $K_1 \# K_2$ . *A-priori*, this operation is asymmetric between  $L_1$  and  $L_2$ .

The most important special cases of this construction are the following:

- (#-1)  *$\alpha\alpha$  connected sums:* Suppose  $\mathcal{A}_1$  and  $\mathcal{A}_2$  are systems of arcs for  $L_1$  and  $L_2$ , such that the arcs for  $K_1$  and  $K_2$  are both alpha-parallel. We form a system of arcs for  $L_1 \# L_2$  by using an alpha-parallel arc for  $K_1 \# K_2$ , and using the remaining arcs without change.
- (#-2)  *$\beta\beta$  connected sums:* These are analogous to  $\alpha\alpha$ .
- (#-3)  *$\alpha\beta$  connected sums:* Suppose that  $\mathcal{A}_1$  and  $\mathcal{A}_2$  are systems of arcs for  $L_1$  and  $L_2$ , such that the arc for  $K_1$  is alpha-parallel while the arc for  $K_2$  is beta-parallel. We form the system  $\mathcal{A}_1 \# \mathcal{A}_2$  by using the co-core of the connected sum band as the arc for  $K_1 \# K_2$ .

These special cases are illustrated in Figure 9.3.

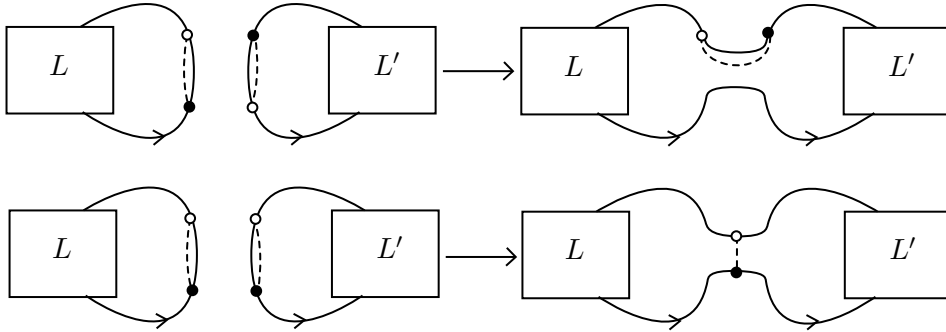

FIGURE 9.3. The connected sums of two alpha-parallel arcs (top row), and the connected sum of one alpha-parallel arc and one beta-parallel arc (bottom row).

We now describe how to realize the above connected sum operations on the level of  $\sigma$ -basic systems of Heegaard diagrams. Suppose that we have  $\sigma$ -basic systems  $\mathcal{H}_1$  and  $\mathcal{H}_2$  for  $L_1$  and  $L_2$ . We focus on the largest hyperbox of the system, since the smaller hyperboxes are determined by the compatibility condition with respect to inclusion.

We take the connected sum of the Heegaard surfaces  $\Sigma_1$  and  $\Sigma_2$  at  $w_1 \in K_1$  and  $z_2 \in K_2$ , deleting those two basepoints, and leaving  $z_1$  and  $w_2$ .

We write  $\mathcal{H}_1^{(0)}, \mathcal{H}_1^{(1)} \subseteq \mathcal{H}_1$  for the codimension 1 subboxes where the  $K_1$ -component is 0 (resp. where the  $K$ -component is maximal). Write  $\mathcal{H}_2^{(0)}$  and  $\mathcal{H}_2^{(1)}$  for the analogous subboxes of  $\mathcal{H}_2$ .

We first construct a hyperbox of Heegaard diagrams on  $\Sigma_1 \# \Sigma_2$ , which we denote  $\mathcal{H}_1 \# \mathcal{H}_2^{(0)}$ . We build this hyperbox similarly to the tensor product procedure from Section 9.5. We build an analogous hyperbox of Heegaard diagrams  $\mathcal{H}_1^{(1)} \otimes \mathcal{H}_2^{(1)}$  of dimension  $(\ell_1 + \ell_2 - 1)$ . Note that since these hypercubes take place on the connected sum  $\Sigma_1 \# \Sigma_2$ , as opposed to the disjoint union, we may not be able to build the chains in the constituent hypercubes of attaching curves using the tensor product operation. Nonetheless, we may always use the curves so-constructed, and fill in the morphisms of these hypercubes using the standard filling construction of Manolescu-Ozsváth [MO10, Lemma 8.6].

Both  $\mathcal{H}_1 \otimes \mathcal{H}_2^{(0)}$  and  $\mathcal{H}_1^{(1)} \otimes \mathcal{H}_2^{(1)}$  share  $\mathcal{H}_1^{(1)} \otimes \mathcal{H}_2^{(0)}$  as a codimension 1 subface. In particular, we may stack  $\mathcal{H}_1 \otimes \mathcal{H}_2^{(0)}$  and  $\mathcal{H}_1^{(1)} \otimes \mathcal{H}_2^{(1)}$ . Hence, for the connected sum  $L_1 \# L_2$ , we use

$$\mathcal{H}_1 \# \mathcal{H}_2 := \text{St} \left( \mathcal{H}_1 \otimes \mathcal{H}_2^{(0)}, \mathcal{H}_1^{(1)} \otimes \mathcal{H}_2^{(1)} \right), \quad (9.1)$$

where  $\text{St}$  denotes stacking hyperboxes. This construction yields a  $\sigma$ -basic system of hyperboxes for  $L_1 \# L_2$ , whose largest hyperbox is given by Equation (9.1).

*Remark 9.10.* If  $\mathcal{H}_1$  and  $\mathcal{H}_2$  are algebraically rigid, then  $\mathcal{H}_1 \# \mathcal{H}_2$  is also algebraically rigid.

## 10. HYPERCUBES AND DISJOINT UNIONS

In this section, we consider hypercubes of attaching curves on disconnected Heegaard surfaces. Recall that in Section 9.5, we defined a tensor product operation on hypercubes of attaching curves. The goal of this section is to prove the following tensor product formula for pairing such hypercubes of attaching curves:

**Proposition 10.1.** *Suppose that  $\mathcal{L}_\beta$  and  $\mathcal{L}_{\beta'}$  are admissible hypercubes of handleslide equivalent beta attaching curves on  $(\Sigma, \mathbf{w}, \mathbf{z})$  and  $(\Sigma', \mathbf{w}', \mathbf{z}')$ , respectively. Suppose additionally that  $\mathcal{L}_\alpha$  and  $\mathcal{L}_{\alpha'}$  are hypercubes of alpha attaching curves, satisfying the same assumptions. Suppose also that if  $\alpha$  and  $\beta$  are curves in  $\mathcal{L}_\alpha$  and  $\mathcal{L}_\beta$ , then  $(\Sigma, \alpha, \beta, \mathbf{w}, \mathbf{z})$  is the diagram of a link in a rational homology 3-sphere, and similarly for  $\mathcal{L}_{\alpha'}$  and  $\mathcal{L}_{\beta'}$ .*

- (1) *If the small translates in the construction of  $\mathcal{L}_\beta \otimes \mathcal{L}_{\beta'}$  are chosen suitably small, then  $\mathcal{L}_\beta \otimes \mathcal{L}_{\beta'}$  is a hypercube of attaching curves. The same holds for  $\mathcal{L}_\alpha \otimes \mathcal{L}_{\alpha'}$ .*
- (2) *If the translations used in the constructions of  $\mathcal{L}_\alpha \otimes \mathcal{L}_{\alpha'}$  and  $\mathcal{L}_\beta \otimes \mathcal{L}_{\beta'}$  are suitably small, then the canonical map of vector spaces*

$$\begin{aligned} & CF_{J \sqcup J'}(\Sigma \sqcup \Sigma', \mathcal{L}_\alpha \otimes \mathcal{L}_{\alpha'}, \mathcal{L}_\beta \otimes \mathcal{L}_{\beta'}, \mathbf{w} \cup \mathbf{w}', \mathbf{z} \cup \mathbf{z}') \\ & \cong CF_J(\Sigma, \mathcal{L}_\alpha, \mathcal{L}_\beta, \mathbf{w}, \mathbf{z}) \otimes_{\mathbb{F}} CF_{J'}(\Sigma', \mathcal{L}_{\alpha'}, \mathcal{L}_{\beta'}, \mathbf{w}', \mathbf{z}'), \end{aligned}$$

*is a chain isomorphism.*

*Remark 10.2.* In our proof, the assumption that  $(\Sigma, \alpha, \beta, \mathbf{w}, \mathbf{z})$  is a diagram for a link in a rational homology 3-sphere is only used to simplify several statements about

admissibility. For general three-manifolds, the statement above holds as long as we restrict to a finite set of  $\text{Spin}^c$  structures on the hypercubes and assume the diagrams are strongly admissible.

Our proof of Proposition 10.1 follows from the same line of reasoning as [LOT16, Section 3.5], though we present it for the benefit of the reader.

**10.1. Small translate theorems.** We now review a preliminary technical result concerning Heegaard diagrams with repeated attaching curves. These are based on the results of [LOT16, Section 3] and [HHSZ20, Section 11].

Suppose  $\mathcal{D} = (\Sigma, \alpha_j, \dots, \alpha_1, \beta_1, \dots, \beta_k, \mathbf{w}, \mathbf{z})$  is a multi-pointed Heegaard multi-diagram, the curves  $\beta_1, \dots, \beta_k$  are pairwise handleslide-equivalent, and the curves  $\alpha_1, \dots, \alpha_j$  are pairwise handleslide-equivalent. Suppose  $\mathbf{z}$  contains no free-basepoints, for notational simplicity. Let  $\mathbb{I} = (i_1, \dots, i_j)$  and  $\mathbb{I}' = (i'_1, \dots, i'_k)$  be tuples of positive integers. For  $s \in \{1, \dots, j\}$ , pick curves  $\alpha_s^1, \dots, \alpha_s^{i_s}$  which are small Hamiltonian translates of  $\alpha_s$ . Similarly, for  $t \in \{1, \dots, k\}$ , pick attaching curves  $\beta_t^1, \dots, \beta_t^{i'_t}$  which are small translates of  $\beta_t$ . We define the diagram

$$\mathbb{I}\mathcal{D}_{\mathbb{I}'} := (\Sigma, \alpha_j^{i_j}, \dots, \alpha_j^1, \dots, \alpha_1^{i_1}, \dots, \alpha_1^1, \beta_1^1, \dots, \beta_1^{i'_1}, \dots, \beta_k^1, \dots, \beta_k^{i'_k}, \mathbf{w}, \mathbf{z}).$$

We assume that each  $\mathbb{T}_{\alpha_s^n} \cap \mathbb{T}_{\alpha_s^m}$  contains exactly  $2^{g(\Sigma) + |\mathbf{w}| - 1}$  points, for each  $s, n$  and  $m$ , and similarly for the beta-translates.

**Lemma 10.3.** *Suppose  $\mathcal{D} = (\Sigma, \alpha_j, \dots, \alpha_1, \beta_1, \dots, \beta_k, \mathbf{w}, \mathbf{z})$  is a multi-diagram such that the  $\alpha_i$  are all pairwise handleslide equivalent, and the  $\beta_i$  are also all pairwise handleslide equivalent. Assume that  $\mathcal{D}$  is strongly  $\mathfrak{s}$  admissible for some  $\text{Spin}^c$ -structure on the 3-manifold determined by  $(\Sigma, \alpha_1, \beta_1)$ . Let  $\mathbb{I}\mathcal{D}_{\mathbb{I}'}$  be the diagram constructed above. Assume the translations are chosen so that  $\mathbb{I}\mathcal{D}_{\mathbb{I}'}$  is also strongly  $\mathfrak{s}$ -admissible. Suppose that  $(J_x)_{x \in K_{\ell-1}}$  is a generically chosen family of almost complex structures for counting holomorphic  $\ell$ -gons, where  $\ell$  is the total number of attaching curves on  $\mathbb{I}\mathcal{D}_{\mathbb{I}'}$ . If the translations in the construction are chosen suitably small, then the following holds: If  $\psi$  is a class of  $\ell$ -gons representing  $\mathfrak{s}$  such that the input of each  $CF(\alpha_s^{i_s+1}, \alpha_s^{i_s})$  and  $CF(\beta_t^{i'_t+1}, \beta_t^{i'_t})$  is the top degree generator and  $\psi$  has a  $J_x$ -holomorphic representative for some  $x \in K_{\ell-1}$ , then*

$$\mu(\psi) \geq \min(0, 3 - j - k).$$

*Equivalently, if  $S := \sum_{s=1}^j (i_s - 1) + \sum_{t=1}^k (i'_t - 1)$  denotes the number of special inputs from small translates, then*

$$\mu(\psi) \geq \min(0, 3 - \ell + S).$$

*Remark 10.4.* When the diagram  $(\Sigma, \alpha_1, \beta_1)$  represents  $S^3$  (this is the only case we need in this paper) weak admissibility implies strong  $\mathfrak{s}$ -admissibility for unique  $\text{Spin}^c$  structure on  $S^3$ . Cf. [OS04b, Remark 4.11].

We now briefly sketch the proof of Lemma 10.3. We assume for simplicity of notation that  $j = 1$  and  $i_1 = 1$ , so that there are only beta-translates. Consider a class of  $\ell$ -gons  $\psi$  on  $\mathbb{I}\mathcal{D}_{\mathbb{I}'}$ , such that for each  $i, t$ , the input from  $\mathbb{T}_{\beta_t^i} \cap \mathbb{T}_{\beta_t^{i+1}}$  is the top degree generator. There is a well-defined approximating class  $\psi^{\text{app}}$  on  $\mathcal{D}$ , and  $\mu(\psi) = \mu(\psi^{\text{app}})$  (at this step, one needs the special inputs to be the top degree generator; see [HHSZ20, Lemma 11.3], which generalizes easily from triangles to  $\ell$ -gons). For each  $i$  and  $j$ ,

we pick a sequence  $\{\beta_{t,n}^i\}_{n \in \mathbb{N}}$  such that as  $n \rightarrow \infty$ , the curves  $\beta_{t,n}^i$  approach  $\beta_t$ . Write  $\mathcal{D}'_n$  for the diagram obtained by replacing each  $\beta_t^i$  with  $\beta_{t,n}^i$ . Given a sequence  $u_n$  of holomorphic representatives of  $\psi$  on  $\mathcal{D}'_n$ , we may extract a subsequence which converges to representative of  $\psi^{\text{app}}$ , which is a  $(k+1)$ -gon. In particular, by applying transversality for  $(k+1)$ -gons, one obtains that

$$\mu(\psi) \geq \min(0, 3 - (k+1)).$$

We use the assumption of strong admissibility so that there are only finitely many classes of  $\ell$ -gons of index  $3 - \ell$  representing a given  $\text{Spin}^c$  structure, and we apply the above argument to each class.

We refer the reader to [LOT16, Section 3] and [HHSZ20, Section 11] for additional details.

There is an additional refinement of the above lemma for the case when  $\mathcal{D} = (\Sigma, \alpha, \beta, \mathbf{w})$  is an ordinary Heegaard diagram, and we have only one translate  $\beta'$  of the curves  $\beta$ . In this case, if  $\beta'$  are chosen to be suitably small Hamiltonian translates of  $\beta$ , then there is a canonical nearest point map

$$\Phi_{np}: \mathbb{T}_\alpha \cap \mathbb{T}_\beta \rightarrow \mathbb{T}_\alpha \cap \mathbb{T}_{\beta'}.$$

Extending this map linear over the variables, we obtain a map

$$\Phi_{np}: CF(\Sigma, \alpha, \beta, \mathbf{w}, \mathbf{z}) \rightarrow CF(\Sigma, \alpha, \beta', \mathbf{w}, \mathbf{z}).$$

**Lemma 10.5.** *If the curves  $\beta'$  are chosen to be suitably small translates of the curves  $\beta$ , then we have an equality of maps*

$$\Phi_{np}(-) = f_{\alpha, \beta, \beta'}(-, \Theta_{\beta, \beta'}^+).$$

The proof in the case of  $\widehat{CF}$  was given by Lipshitz, Ozsváth and Thurston in [LOT16, Lemma 3.38]. This was extended to  $CF = CF^-$  (mostly by adapting the notation of [LOT16]) in [HHSZ20, Proposition 11.1].

**10.2. Disconnected Heegaard surfaces.** Suppose that  $\mathcal{L}_\beta$  and  $\mathcal{L}_{\beta'}$  are hypercubes of handleslide equivalent attaching curves on  $(\Sigma, \mathbf{w}, \mathbf{z})$  and  $(\Sigma', \mathbf{w}', \mathbf{z}')$ , of dimension  $n$  and  $m$ , respectively. In this section, we prove Part (1) of Proposition 10.1, i.e. for suitable choices of translates, the diagram  $\mathcal{L}_\beta \otimes \mathcal{L}_{\beta'}$  is a hypercube of attaching curves (compare [LOT16, Proposition 3.52]).

We begin with an intermediate technical result, from which we will derive the hypercube relations:

**Lemma 10.6.** *Suppose that  $\kappa_1 < \dots < \kappa_\ell$  is an increasing sequence in  $\mathbb{E}_{n+m}$ , and let  $\Theta_{\kappa_{i-1}, \kappa_i}$  denote the chains in  $\mathcal{L}_\beta \otimes \mathcal{L}_{\beta'}$ . Suppose that  $\ell \neq 3$ , then*

$$\begin{aligned} & f_{\kappa_1, \dots, \kappa_\ell}(\Theta_{\kappa_1, \kappa_2}, \dots, \Theta_{\kappa_{\ell-1}, \kappa_\ell}) \\ &= \begin{cases} f_{\varepsilon_1, \dots, \varepsilon_\ell}(\Theta_{\varepsilon_1, \varepsilon_2}, \dots, \Theta_{\varepsilon_{\ell-1}, \varepsilon_\ell}) \otimes \Theta_{\nu_1, \nu_1}^+ & \text{if } \nu_1 = \nu_\ell, \\ \Theta_{\varepsilon_1, \varepsilon_1}^+ \otimes f_{\nu_1, \dots, \nu_\ell}(\Theta_{\nu_1, \nu_2}, \dots, \Theta_{\nu_{\ell-1}, \nu_\ell}) & \text{if } \varepsilon_1 = \varepsilon_\ell, \\ 0 & \text{otherwise.} \end{cases} \end{aligned} \quad (10.1)$$

If  $\ell = 2$ , we interpret  $f_{\kappa_1, \kappa_2}(\Theta_{\kappa_1, \kappa_2})$  to mean the ordinary Floer differential. If  $\ell = 3$ , then the above formula holds as long as  $\nu_1 = \nu_3$  or  $\varepsilon_1 = \varepsilon_3$ . If  $\ell = 3$  and instead



$\varepsilon_1 < \varepsilon_2 = \varepsilon_3$  and  $\nu_1 = \nu_2 < \nu_3$ , then

$$f_{\kappa_1, \kappa_2, \kappa_3}(\Theta_{\kappa_1, \kappa_2}, \Theta_{\kappa_2, \kappa_3}) = \Theta_{\varepsilon_1, \varepsilon_2} \otimes \Theta_{\nu_2, \nu_3},$$

where we identify complexes whose attaching curves are small approximations of each other. Similarly if  $\varepsilon_1 = \varepsilon_2 < \varepsilon_3$  and  $\nu_1 < \nu_2 = \nu_3$  we have

$$f_{\kappa_1, \kappa_2, \kappa_3}(\Theta_{\kappa_1, \kappa_2}, \Theta_{\kappa_2, \kappa_3}) = \Theta_{\varepsilon_2, \varepsilon_3} \otimes \Theta_{\nu_1, \nu_2}.$$

*Proof.* Consider first the claim when  $\ell = 2$  (i.e. for holomorphic disks). Suppose that  $(\varepsilon_1, \nu_1) < (\varepsilon_2, \nu_2)$  and consider  $\Theta_{\kappa_1, \kappa_2}$ . By assumption,  $\Theta_{\kappa_1, \kappa_2}$  is only non-trivial if  $\varepsilon_1 = \varepsilon_2$  or  $\nu_1 = \nu_2$ , so assume for concreteness that  $\varepsilon_1 < \varepsilon_2$  and  $\nu_1 = \nu_2$ . By Definition,  $\Theta_{\kappa_1, \kappa_2} = \Theta_{\varepsilon_1, \varepsilon_2} \otimes \Theta_{\nu_1, \nu_1}^+$ . The differential on the disjoint union of two diagrams is clearly tensorial, so

$$\partial(\Theta_{\varepsilon_1, \varepsilon_2} \otimes \Theta_{\nu_1, \nu_1}^+) = \partial\Theta_{\varepsilon_1, \varepsilon_2} \otimes \Theta_{\nu_1, \nu_1}^+ + \Theta_{\varepsilon_1, \varepsilon_2} \otimes \partial\Theta_{\nu_1, \nu_1}^+ = \partial\Theta_{\varepsilon_1, \varepsilon_2} \otimes \Theta_{\nu_1, \nu_1}^+,$$

proving the claim in this case. The case that  $\ell = 3$  is similarly straightforward to verify.

We assume now that  $\ell > 3$ . The map  $f_{\kappa_1, \dots, \kappa_\ell}$  counts holomorphic  $\ell$ -gons of Maslov index  $3 - \ell$ . The holomorphic curves map into  $(\Sigma \sqcup \Sigma') \times D_\ell$ . To define the polygon counting map, we pick a family of almost complex structures  $(\mathcal{J}_x)_{x \in K_{\ell-1}}$  on  $(\Sigma \sqcup \Sigma') \times D_\ell$ . Such a family of almost complex structures induces two families,  $(J_x)_{x \in K_{\ell-1}}$  and  $(J'_x)_{x \in K_{\ell-1}}$ , on  $\Sigma \times D_\ell$  and  $\Sigma' \times D_\ell$ , respectively.

The holomorphic polygon map  $f_{\kappa_1, \dots, \kappa_\ell}$  on the disjoint union may be equivalently described by counting pairs  $(u, u')$  representing pairs of classes of  $\ell$ -gons  $(\psi, \psi')$  satisfying

$$\mu(\psi) + \mu(\psi') = 3 - \ell, \quad (10.2)$$

which have the same almost complex structure parameter  $x \in K_{\ell-1}$ . In particular, we may naturally view the moduli spaces counted by  $f_{\kappa_1, \dots, \kappa_\ell}$  as fibered products over the evaluation maps to  $K_{\ell-1}$ .

Consider the last line of Equation (10.1). This equation concerns sequences  $\kappa_1 < \dots < \kappa_\ell$  which increment both the  $\mathbb{E}_n$ -coordinates and the  $\mathbb{E}_m$ -coordinates. Consider a class of  $\ell$ -gons  $(\psi, \psi')$  on  $(\Sigma \sqcup \Sigma') \times D_\ell$ , potentially counted by the  $\ell$ -gon map  $f_{\kappa_1, \dots, \kappa_\ell}$ . Let  $k$  be the number of inputs of  $\psi$  which do not increment the  $\mathbb{E}_n$ -coordinate. Let  $k'$  be the number of inputs of  $\psi'$  which do not increment the  $\mathbb{E}_m$ -coordinate.

By Lemma 10.3, if  $(\psi, \psi')$  has a holomorphic representative, we must have

$$\mu(\psi) \geq \min(3 - \ell + k, 0) \quad \text{and} \quad \mu(\psi') \geq \min(3 - \ell + k', 0), \quad (10.3)$$

because each input of  $\psi$  which does not increase the  $\mathbb{E}_n$ -coordinate contributes a top degree generator in a pair of translated curves as input. Since  $\mu(\psi) + \mu(\psi') = 3 - \ell$ , by assumption, for a holomorphic representative to exist we must have

$$\min(3 - \ell + k, 0) + \min(3 - \ell + k', 0) \leq 3 - \ell.$$

We add  $2(\ell - 3)$  to the above to obtain

$$\min(k, \ell - 3) + \min(k', \ell - 3) \leq \ell - 3. \quad (10.4)$$

On the other hand, there are  $\ell - 1$  total inputs to the map  $f_{\kappa_1, \dots, \kappa_\ell}$ , and each input increments either  $\mathbb{E}_n$  or  $\mathbb{E}_m$ , but not both (by definition of  $\mathcal{L}_\beta \otimes \mathcal{L}_{\beta'}$ ). Hence

$$k + k' = \ell - 1.$$

Combining the above equation with Equation (10.4), we deduce that it is not possible that both  $k \leq \ell - 3$  and  $k' \leq \ell - 3$ , since then the left hand side of Equation (10.4)



would be  $k + k' = \ell - 1$ , which is larger than  $\ell - 3$ . Hence, we assume without loss of generality that  $k > \ell - 3$ . Equation (10.4) implies that

$$\min(k', \ell - 3) \leq 0,$$

which implies that either  $k' = 0$  or  $\ell \in \{2, 3\}$ . Symmetrically, we could also have  $(k, k') = (0, \ell - 1)$ . This proves the last line of Equation (10.1)

We now consider the first two lines of Equation (10.1). These correspond to the cases that  $(k, k')$  is  $(\ell - 1, 0)$  or  $(0, \ell - 1)$ . Consider the case that  $k = 0$  and  $k' = \ell - 1$ . In this case, the holomorphic curve count occurs on the diagram

$$(\Sigma, \beta_{\varepsilon_1}, \dots, \beta_{\varepsilon_\ell}, \mathbf{w}, \mathbf{z}) \sqcup (\Sigma', \beta'_{\nu}, \dots, \beta'_{\nu}, \mathbf{w}', \mathbf{z}'),$$

where the  $\ell$  curves on the right-hand diagram are small translates and we write  $\nu$  for  $\nu_1$ . Equation (10.3) implies in this case that  $\mu(\psi) \geq 3 - \ell$  and  $\mu(\psi') \geq 0$ . Together with Equation (10.2) we see that  $\mu(\psi) = 3 - \ell$  and  $\mu(\psi') = 0$ .

If  $\psi' \in \pi_2(\Theta_{\nu, \nu}^+, \dots, \Theta_{\nu, \nu}^+, \mathbf{z})$ , the Maslov index formula for the grading implies that

$$\mu(\psi') = n_{\mathbf{w}'}(\psi') + \text{gr}_{\mathbf{w}'}(\Theta_{\nu, \nu}^+, \mathbf{z}).$$

Since  $\mu(\psi') = 0$ , we conclude that  $n_{\mathbf{w}'}(\psi') = 0$  and  $\mathbf{z} = \Theta_{\nu, \nu}^+$ .

The parametrized moduli space

$$\bigcup_{x \in K_{\ell-1}} \mathcal{M}_{J_x}(\psi) \times \{x\}$$

has dimension 0, while  $\bigcup_{x \in K_{\ell-1}} \mathcal{M}_{J_x}(\psi) \times \{x\}$  has the same dimension as  $K_{\ell-1}$ . As the moduli space on the disjoint union is the fibered product under the evaluation map to  $K_{\ell-1}$ , it suffices to show that the map

$$\text{ev}: \bigcup_{\substack{\psi \in \pi_2(\Theta_{\nu, \nu}^+, \dots, \Theta_{\nu, \nu}^+) \\ \mu(\psi) = 0 \\ x \in K_{\ell-1}}} \mathcal{M}_{J_x}(\psi) \rightarrow K_{\ell-1}$$

has odd degree. (Compare [LOT16, Lemma 3.50]) This is proven by considering the preimage of a path  $\gamma: [0, 1] \rightarrow K_{\ell-1}$ , such that  $\gamma(0) = x$ ,  $\gamma(t) \in \text{int } K_{\ell-1}$  for  $t \in [0, 1)$  and  $\gamma(1)$  is a point in  $\partial K_{\ell-1}$  which realizes a degeneration of a holomorphic  $\ell$ -gon into  $\ell - 2$  triangles (i.e. a point in the lowest dimensional boundary strata of  $K_{\ell-1}$ ). The codimension 1 degenerations along the image of  $(0, 1)$  under  $\gamma$  consist of index 1 holomorphic disks breaking off. The holomorphic disks which break off in the input directions cancel in pairs, since each  $\Theta_{\nu, \nu}^+$  is a cycle. There are no disks which bubble off in the output, since they would leave an index  $-1$   $\ell$ -gon in  $\pi_2(\Theta_{\nu, \nu}^+, \dots, \Theta_{\nu, \nu}^+, \mathbf{y})$ , for some  $\mathbf{y}$ , as well as an index 1 disk  $\phi \in \pi_2(\mathbf{y}, \Theta_{\nu, \nu}^+)$  with  $n_{\mathbf{w}}(\phi) = 0$ . The existence of such a degeneration would imply that  $\text{gr}(\mathbf{y}, \Theta_{\nu, \nu}^+) = 1$ , which is impossible since there are no generators with grading higher than  $\Theta_{\nu, \nu}^+$ .

The cardinality of the limit at  $t = 1$  corresponds to the component of  $\Theta_{\nu, \nu}^+$  in the  $\ell - 2$  fold composition of maps of the form  $f_{\beta'_{\nu}, \beta'_{\nu}, \beta'_{\nu}}(\Theta_{\nu, \nu}^+, -)$ , applied to the element  $\Theta_{\nu, \nu}^+$  (e.g. by the grading preserving invariance of the Heegaard Floer complex of connected sums of  $S^1 \times S^2$ ). Clearly this is 1, modulo 2. This establishes the first line of (10.1). The second line follows from the same reasoning, establishing Equation (10.1) and completing the proof.  $\square$

We now use the previous Lemma to finish our proof that  $\mathcal{L}_\beta \otimes \mathcal{L}_{\beta'}$  is a hypercube of attaching curves:

*Proof of Part (1) of Proposition 10.1.* Suppose that  $\kappa < \kappa'$  are points in  $\mathbb{E}_{n+m}$ . We wish to show the hypercube relations for  $\mathcal{L}_\beta \otimes \mathcal{L}_{\beta'}$ . Write  $\kappa = (\varepsilon, \nu)$  and  $\kappa' = (\varepsilon', \nu')$ . There are two cases to consider:

- (1)  $\varepsilon = \varepsilon'$  or  $\nu = \nu'$ . I.e. the arrow  $(\kappa, \kappa')$  is *non-mixed*.
- (2)  $\varepsilon < \varepsilon'$  and  $\nu < \nu'$ . I.e. the arrow  $(\kappa, \kappa')$  is *mixed*.

In the case of a non-mixed arrow, Lemma 10.6 shows that the hypercube relations for  $\mathcal{L}_\beta \otimes \mathcal{L}_{\beta'}$  follow immediately from the hypercube relations on  $\mathcal{L}_\beta$  and  $\mathcal{L}_{\beta'}$ .

For a mixed arrow  $(\kappa, \kappa')$ , Lemma 10.6 implies that there are exactly two terms which contribute to the hypercube relation. These correspond to the two broken arrow sequences  $(\kappa, \kappa_0, \kappa')$  where  $\kappa_0 \in \{(\varepsilon, \nu'), (\varepsilon', \nu)\}$ . By Lemma 10.6 both of these sequences contribute  $\Theta_{\varepsilon, \varepsilon'} \otimes \Theta_{\nu, \nu'}$ , which cancel, so the hypercube relations are satisfied.  $\square$

We are now able to prove the remainder of Proposition 10.1:

*Proof of Part (2) Proposition 10.1.* The proof is in the same spirit as Part (1) of the proposition. To simplify the notation, we will assume that  $\mathcal{L}_\alpha$  and  $\mathcal{L}_{\alpha'}$  are both 0-dimensional, and consist of ordinary sets of attaching circles  $\alpha$  and  $\alpha'$ . If  $(\varepsilon, \nu) < (\varepsilon', \nu')$  are points in  $\mathbb{E}_{n+m}$ , then the hypercube map from  $(\varepsilon, \nu)$  to  $(\varepsilon', \nu')$  in

$$CF(\Sigma \sqcup \Sigma', \alpha \cup \alpha', \mathcal{L}_\beta \otimes \mathcal{L}_{\beta'}, \mathbf{w} \cup \mathbf{w}') \quad (10.5)$$

is obtained by summing over all increasing sequences

$$(\varepsilon, \nu) = (\varepsilon_1, \nu_1) < \cdots < (\varepsilon_\ell, \nu_\ell) = (\varepsilon', \nu')$$

the holomorphic  $(\ell + 1)$ -gon map which has special inputs from  $\mathcal{L}_\beta \otimes \mathcal{L}_{\beta'}$ . We say such a sequence is *mixed* if  $\varepsilon < \varepsilon'$  and  $\nu < \nu'$ . We claim that in the pairing of the two hypercubes of attaching curves, mixed sequences make trivial contribution. This is an approximation argument similar to Part (1) of the Proposition, as we now describe.

We recall that  $\mathcal{L}_\beta \otimes \mathcal{L}_{\beta'}$  has no mixed arrows which are assigned non-zero chain. Hence we may consider only broken arrow paths in  $\mathbb{E}_{n+m}$  where each individual arrow increases exactly one of the  $\mathbb{E}_n$  or  $\mathbb{E}_m$  coordinates. For such a sequence of length  $\ell \geq 1$ , let  $k$  be the number of arrows which do not increase the  $\mathbb{E}_n$  coordinate, and let  $k'$  be the number of arrows which do not increase the  $\mathbb{E}_m$  coordinate. In our present situation,  $k + k' = \ell - 1$ . The contribution of this arrow path is a count of holomorphic  $(\ell + 1)$ -gons, with  $\ell - 1$  special inputs from the hypercube  $\mathcal{L}_\beta \otimes \mathcal{L}_{\beta'}$ , and one input from  $CF(\alpha \cup \alpha', \beta_\varepsilon \cup \beta'_\nu)$ . Suppose  $(\psi, \psi')$  is a homology class which could potentially contribute. By construction,  $\mu(\psi) + \mu(\psi') = 2 - \ell$ . Equation (10.3) adapts to show that

$$\mu(\psi) \geq \min(2 - \ell + k, 0) \quad \text{and} \quad \mu(\psi') \geq \min(2 - \ell + k', 0),$$

so

$$\min(2 - \ell + k, 0) + \min(2 - \ell + k', 0) \leq 2 - \ell,$$

and hence

$$\min(k, \ell - 2) + \min(k', \ell - 2) \leq \ell - 2.$$

Similar to the argument from Part (1), the only allowable configurations are  $(k, k') \in \{(\ell - 1, 0), (0, \ell - 1)\}$ . This implies that there are no mixed arrows in the hypercube of Equation (10.5).

It remains to verify that the non-mixed arrows of Equation (10.5) coincide with the tensor product differential. Arguing similarly to the proof of Part (1), it suffices to show that if  $\mathbf{x} \in \mathbb{T}_\alpha \cap \mathbb{T}_{\beta_\varepsilon}$ , then the map

$$\text{ev}: \bigcup_{\substack{\psi \in \pi_2(\mathbf{x}, \Theta_{\varepsilon, \varepsilon}^+, \dots, \Theta_{\varepsilon, \varepsilon}^+, \mathbf{y}) \\ \mu(\psi) = 0 \\ x \in K_\ell}} \mathcal{M}_{J_x}(\psi) \rightarrow K_\ell$$

is odd degree if  $\mathbf{y}$  is the canonical nearest point to  $\mathbf{x}$ ,  $\mathbf{y} = \mathbf{x}_{np}$ , and is even degree otherwise. Similarly to Part (1), we consider the preimage of a path  $\gamma: [0, 1] \rightarrow K_\ell$ , which connects a generic  $x \in \text{int } K_\ell$  to a point in  $\partial K_\ell$  of maximal codimension. The only possible generic degenerations on the interior consist of an index 1 disk breaking off. Disks breaking off at the  $\Theta_{\varepsilon, \varepsilon}^+$  inputs cancel in pairs. Index 1 disks breaking off at the  $\mathbf{x}$  input or the  $\mathbf{y}$  output are impossible, since they leave an index  $-1$   $(\ell + 1)$ -gon which has  $\ell - 1$  inputs equal to the top degree generator, whose existence would violate Lemma 10.3. Hence, we identify the preimage over  $x$  with the preimage of  $\gamma(1)$ . By the nearest point map argument of Lemma 10.5, the count is odd if and only if  $\mathbf{y} = \mathbf{x}_{np}$ , completing the proof.  $\square$

## 11. HYPERCUBES AND CONNECTED SUMS

In this section, we prove a connected sum formula for hypercubes of attaching curves. We begin with some preliminary definitions before stating our result in Proposition 11.8.

**Definition 11.1.** A *Heegaard surface with matched basepoints*  $(\Sigma, \mathbf{w}, \mathbf{z})$  consists of a surface with a finite collection of points  $\mathbf{w} \cup \mathbf{z}$ , which are partitioned into two sets  $\mathbf{l} \cup \mathbf{f}$  (*link* and *free* basepoints, respectively), and furthermore equipped with a matching function

$$m: \mathbf{l} \cap \mathbf{w} \rightarrow \mathbf{l} \cap \mathbf{z},$$

which is a bijection.

**Definition 11.2.** Suppose that  $(\Sigma, \mathbf{w}, \mathbf{z})$  and  $(\Sigma', \mathbf{w}', \mathbf{z}')$  are two doubly pointed Heegaard surfaces which are equipped with matched basepoints, as in Definition 11.1. We say that  $(\Sigma \# \Sigma', \mathbf{w}'', \mathbf{z}'')$  is formed by an *admissible connected sum* if it is formed by one of the two following procedures (possibly with the roles of  $\Sigma$  and  $\Sigma'$  reversed).

- (1) (Connected sum at a free-basepoint) The connected sum is taken at a free basepoint  $x \in \mathbf{f} \cap (\mathbf{w} \cup \mathbf{z})$ , and at some point  $p \in \Sigma' \setminus (\mathbf{w}' \cup \mathbf{z}')$ . The basepoints are  $\mathbf{w}'' = \mathbf{w} \setminus \{x\} \cup \mathbf{w}'$  and  $\mathbf{z}'' = \mathbf{z} \setminus \{x\} \cup \mathbf{z}'$ .
- (2) (Connected sum along link components) The connected sum is taken at two link basepoints  $w \in \mathbf{w}$  and  $z' \in \mathbf{z}'$ . The basepoints are  $\mathbf{w}'' = \mathbf{w} \setminus \{w\} \cup \mathbf{w}'$  and  $\mathbf{z}'' = \mathbf{z} \cup \mathbf{z}' \setminus \{z'\}$ .

Suppose that we form an admissible connected sum  $(\Sigma \# \Sigma', \mathbf{w}'', \mathbf{z}'')$  from the pointed surfaces  $(\Sigma, \mathbf{w}, \mathbf{z})$  and  $(\Sigma', \mathbf{w}', \mathbf{z}')$ . Suppose  $\mathcal{L}_\beta$  and  $\mathcal{L}_{\beta'}$  are hypercubes of handleslide equivalent attaching curves on  $\Sigma$  and  $\Sigma'$ , respectively. We may construct a hypercube-shaped diagram  $\mathcal{L}_\beta \otimes \mathcal{L}_{\beta'}$  on  $(\Sigma \# \Sigma', \mathbf{w}'', \mathbf{z}'')$  via the same procedure as on the disjoint union of the two diagrams in Section 9.5. We do not claim that the hypercube relations are satisfied, however we have the following:

*Remark 11.3.* If  $\mathcal{L}_\beta$  and  $\mathcal{L}_{\beta'}$  are algebraically rigid, then the top degree chains coincide on disjoint unions of diagrams and on admissible connected sums, justifying the use of the notation  $\mathcal{L}_\beta \otimes \mathcal{L}_{\beta'}$  for both situations. Also, if  $\mathcal{L}_\beta$  and  $\mathcal{L}_{\beta'}$  are algebraically rigid, then  $\mathcal{L}_\beta \otimes \mathcal{L}_{\beta'}$  is automatically a hypercube of attaching curves.

To state our connected sum theorem for hypercubes, we need an additional condition on our hypercubes of attaching curves:

**Definition 11.4.** Suppose that  $\mathcal{L}_\alpha$  is an algebraically rigid hypercube of handleslide equivalent attaching curves on  $(\Sigma, \mathbf{w}, \mathbf{z})$ , and  $p$  is a point in the complement of  $\Sigma \setminus \bigcup_{\alpha \in \mathcal{L}_\alpha} \alpha$ . Write  $\mathbf{f}$  for the free basepoints of  $\mathbf{z}$ . We say that  $\mathcal{L}_\alpha$  is *graded by  $p$*  if for every composable sequence  $\Theta_{\nu_j, \nu_{j-1}}, \dots, \Theta_{\nu_2, \nu_1}$  of chains in  $\mathcal{L}_\alpha$ , and every nonnegative class  $\psi \in \pi_2(\Theta_{\nu_j, \nu_{j-1}}, \dots, \Theta_{\nu_2, \nu_1}, \mathbf{x})$ , we have

$$\mu(\psi) \geq 2n_p(\psi).$$

(Note  $\mathbf{x}$  is the outgoing intersection point in the class  $\psi$ ). We make a similar definition for hypercubes of algebraically rigid beta hypercubes.

**Lemma 11.5.** *If  $\mathcal{L}_\alpha$  is an algebraically rigid hypercube of handleslide equivalent attaching curves on  $(\Sigma, \mathbf{w}, \mathbf{z})$ , and  $p$  is immediately adjacent to a point of  $\mathbf{w}$  or  $\mathbf{z}$ , then  $\mathcal{L}_\alpha$  is graded by  $p$ .*

*Proof.* Assume for concreteness that  $p$  is adjacent to a point in  $\mathbf{w}$ . Write  $\mathbf{f}$  for the free-basepoints (if any) in  $\mathbf{z}$ . If  $\psi \in \pi_2(\Theta_{\nu_j, \nu_{j-1}}, \dots, \Theta_{\nu_2, \nu_1}, \mathbf{x})$  is a class, then the absolute grading formula implies

$$\mu(\psi) = 2n_{\mathbf{w} \cup \mathbf{f}}(\psi) + \text{gr}_{\mathbf{w} \cup \mathbf{f}}(\Theta_{\nu_j, \nu_{j-1}}) + \dots + \text{gr}_{\mathbf{w} \cup \mathbf{f}}(\Theta_{\nu_2, \nu_1}) - \text{gr}_{\mathbf{w} \cup \mathbf{f}}(\mathbf{x}),$$

where  $\text{gr}_{\mathbf{w} \cup \mathbf{f}}$  is the absolute grading, normalized so that the top degree cycle of

$$HF(\Sigma, \alpha_{\nu_i}, \alpha_{\nu_{i-1}}, \mathbf{w}, \mathbf{z})$$

has grading 0. Since  $\mathcal{L}_\alpha$  is algebraically rigid, we also know that  $\text{gr}_{\mathbf{w} \cup \mathbf{f}}(\mathbf{x}) \leq 0$  and  $\text{gr}_{\mathbf{w} \cup \mathbf{f}}(\Theta_{\nu_{i+1}, \nu_i}) = 0$  for all  $i$ . In particular, if  $\psi$  is a nonnegative class, we have  $n_{\mathbf{w} \cup \mathbf{f}}(\psi) \geq n_p(\psi)$ , so we see that  $\mathcal{L}_\alpha$  is graded by  $p$ .  $\square$

*Remark 11.6.* If  $\mathcal{L}_\alpha = \text{Cone}(\alpha \longrightarrow \alpha')$  corresponds to a Hamiltonian isotopy of  $\alpha$  over  $p$  to obtain  $\alpha'$ , then  $\mathcal{L}_\alpha$  is not graded by  $p$  because there is a bigon of index 1 which covers  $p$  once.

Suppose that  $\mathcal{L}_\alpha$  is a hypercube of handleslide equivalent attaching curves on  $(\Sigma, \mathbf{w}, \mathbf{z})$  and  $p \in \Sigma$  is in the complement of each curve in  $\mathcal{L}_\alpha$ . If  $\alpha$  is in  $\mathcal{L}_\alpha$ , write  $E_p^\alpha$  for the product of the variables of the basepoints in the component of  $\Sigma \setminus \alpha$  containing  $p$ .

**Lemma 11.7.** *Let  $\mathcal{L}_\alpha$  be a hypercube of handleslide equivalent attaching curves on  $(\Sigma, \mathbf{w}, \mathbf{z})$  which is graded by  $p$ . Then  $E_p^\alpha$  is independent of  $\alpha \in \mathcal{L}_\alpha$ .*

*Proof.* Let  $\alpha_1, \alpha_2 \in \mathcal{L}_\alpha$ . Consider the endomorphism  $A_p$  of  $CF(\alpha_2, \alpha_1)$  which counts holomorphic disks of index 1, which are weighted by  $n_p(\phi)$ . It is straightforward to see that  $[\partial, A_p] = (E_p^{\alpha_1} + E_p^{\alpha_2}) \cdot \text{id}$ . On the other hand, if  $\Theta_{\alpha_2, \alpha_1}$  is a cycle generating the top degree of homology, then  $\partial(\Theta_{\alpha_2, \alpha_1}) = 0$  since  $\Theta_{\alpha_2, \alpha_1}$  is a cycle and  $A_p(\Theta_{\alpha_2, \alpha_1}) = 0$  since  $\mathcal{L}_\alpha$  is graded by  $p$  so there are no Maslov index 1 and nonnegative homology classes of disks in any  $\pi_2(\Theta_{\alpha_2, \alpha_1}, \mathbf{x})$  with multiplicity 1 on  $p$ . Since  $CF(\alpha_2, \alpha_1)$  is free and

$0 = [\partial, A_p](\Theta_{\alpha_2, \alpha_1}) = \Theta_{\alpha_2, \alpha_1} \cdot (E_p^{\alpha_1} + E_p^{\alpha_2})$ , it follows that  $E_p^{\alpha_1} + E_p^{\alpha_2} = 0$ , completing the proof.  $\square$

The main result of this section is the following:

**Proposition 11.8.** *Suppose that  $\mathcal{L}_\alpha$  and  $\mathcal{L}_\beta$  are algebraically rigid hypercubes of handleslide-equivalent attaching curves on  $(\Sigma, \mathbf{w}, \mathbf{z})$  and  $\mathcal{L}_{\alpha'}$  and  $\mathcal{L}_{\beta'}$  are algebraically rigid hypercubes of handleslide-equivalent attaching curves on  $(\Sigma', \mathbf{w}', \mathbf{z}')$ . Suppose that we form  $(\Sigma \# \Sigma', \mathbf{w}'', \mathbf{z}'')$  by an admissible connected sum of  $(\Sigma, \mathbf{w}, \mathbf{z})$  and  $(\Sigma', \mathbf{w}', \mathbf{z}')$  at points  $p \in \Sigma$  and  $p' \in \Sigma'$ . Form the hypercubes  $\mathcal{L}_\alpha \otimes \mathcal{L}_{\alpha'}$  and  $\mathcal{L}_\beta \otimes \mathcal{L}_{\beta'}$  as described above. If  $\mathcal{L}_\beta$  is graded by  $p$  and  $\mathcal{L}_{\alpha'}$  is graded by  $p'$ , then there is a natural homotopy equivalence of hypercubes*

$$\begin{aligned} & CF(\Sigma \# \Sigma', \mathcal{L}_\alpha \otimes \mathcal{L}_{\alpha'}, \mathcal{L}_\beta \otimes \mathcal{L}_{\beta'}, \mathbf{w}'', \mathbf{z}'') \\ & \simeq CF(\Sigma, \mathcal{L}_\alpha, \mathcal{L}_\beta, \mathbf{w}, \mathbf{z}) \otimes_R CF(\Sigma', \mathcal{L}_{\alpha'}, \mathcal{L}_{\beta'}, \mathbf{w}', \mathbf{z}'). \end{aligned}$$

In the above,  $CF = CF^-$ . Also,  $R$  is as follows:

- (1) If the connected sum is taken along a link component, then  $R = \mathbb{F}[\mathcal{U}, \mathcal{V}]$  is the ring for the link components along which the connected sum is taken.
- (2) If the connected sum is taken at a free basepoint  $f$  of  $\mathbf{w} \cup \mathbf{z}$ , then the tensor product is taken over  $\mathbb{F}[U]$ , where we have  $U$  act by  $U_f$  on the left factor, and  $E_p^{\alpha'}$  on the right factor. (Cf. Lemma 11.7).
- (3) If the connected sum is taken at a free basepoint  $f$  in  $\mathbf{w}' \cup \mathbf{z}'$ , the tensor product is taken over  $\mathbb{F}[U]$  where we have  $U$  act by  $U_f$  on the right factor and  $E_p^\beta$  on the left factor.

Unlike in Section 10, the homotopy equivalence of Proposition 11.8 is not given by the identity map on the level of groups. Instead it involves counting holomorphic curves.

*Remark 11.9.* Note that if instead  $\mathcal{L}_\alpha$  is graded by  $p$  and  $\mathcal{L}_{\beta'}$  is graded by  $p'$ , there is also a homotopy equivalence of hypercubes realizing a tensor product formula. Note that in the case that all of the hypercubes of Lagrangians are graded by  $p$  and  $p'$ , there are two distinct maps of hypercubes realizing the homotopy equivalence. These are referred to as  $\Phi^{\bullet < \alpha'}$  and  $\Phi^{\alpha' < \bullet}$  below.

**11.1. Cylindrical boundary degenerations.** In this section, we recall some important facts about boundary degenerations.

**Definition 11.10.** Suppose  $\beta$  is a set of attaching curves on  $(\Sigma, \mathbf{w})$ , and  $\mathbf{x} \in \mathbb{T}_\beta$ . A *cylindrical beta boundary degeneration* at  $\mathbf{x}$  consists of a tuple  $(u, S, j)$  such that  $(S, j)$  is a Riemann surface and

$$u: (S, \partial S) \rightarrow (\Sigma \times [0, \infty) \times \mathbb{R}, \beta \times \{0\} \times \mathbb{R})$$

is a map satisfying the following:

- (1)  $u$  is  $(j, J)$ -holomorphic.
- (2)  $u$  is proper.
- (3) For each  $t \in \mathbb{R}$  and  $i \in \{1, \dots, g(\Sigma) + |\mathbf{w}| - 1\}$ , the set  $u^{-1}(\beta_i \times \{0\} \times \{t\})$  consists of a single point.
- (4)  $u$  has finite energy.
- (5)  $\pi_{\mathbb{H}} \circ u$  is non-constant on each component of  $S$ , where  $\mathbb{H} = [0, \infty) \times \mathbb{R}$ .

- (6)  $S$  has a collection of  $n = g(\Sigma) + |\mathbf{w}| - 1$  boundary punctures  $p_1, \dots, p_n$ . If  $\mathbf{x} = (x_1, \dots, x_n)$ , where  $x_i \in \beta_i$ , then

$$\lim_{z \rightarrow p_i} (\pi_{\mathbb{H}} \circ u)(z) = \infty \quad \text{and} \quad \lim_{z \rightarrow p_i} (\pi_{\Sigma} \circ u)(z) = x_i.$$

Cylindrical alpha boundary degenerations are defined by analogy. Of fundamental importance is the mod 2 count of boundary degenerations.:

**Proposition 11.11.** *Suppose  $\beta$  is a set of attaching curves on  $(\Sigma, \mathbf{w})$ , and  $B$  is a Maslov index 2 class of boundary degenerations. For an appropriate choice of almost complex structures on  $\Sigma \times [0, \infty) \times \mathbb{R}$ , the moduli space of boundary degenerations  $\mathcal{N}(B, \mathbf{x})$  is transversely cut out. Furthermore, the parametrized moduli space*

$$\bigcup_{\mathbf{x} \in \mathbb{T}_{\beta}} \mathcal{N}(B, \mathbf{x}) \times \{\mathbf{x}\}$$

is also transversely cut out. Furthermore

$$\#\mathcal{N}(B, \mathbf{x}) / \text{Aut}(\mathbb{H}) \equiv 1.$$

The case when  $|\mathbf{w}| > 1$  is proven by Ozsváth and Szabó [OS08a, Theorem 5.5]. Ozsváth and Szabó also proved that if  $|\mathbf{w}| = 1$  there are generically no boundary degenerations for split almost complex structures on  $\Sigma \times [0, \infty) \times \mathbb{R}$ . However for their boundary degenerations, the parametrized moduli space  $\bigcup_{\mathbf{x} \in \mathbb{T}_{\beta}} \mathcal{N}(B, \mathbf{x}) \times \{\mathbf{x}\}$  might in general be non-empty, and there are always broken boundary degenerations at which transversality is not achieved (e.g. the union of a closed curve representing  $\Sigma$  and a constant disk at  $\mathbf{x}$ ). This is sufficient for showing that  $\partial^2 = 0$ , but is not sufficient for our purposes. The  $|\mathbf{w}| = 1$  case was revisited in [HHSZ20, Section 7.6], where it was shown that for appropriately generic choices of almost complex structure, the count of Proposition 11.11 holds.

**11.2. The 0-dimensional case.** In this section, we present the proof of Proposition 11.8 in the case that  $\mathcal{L}_{\beta}$  and  $\mathcal{L}_{\beta'}$  are both 0-dimensional (i.e. we recover the standard connected sum formula of Ozsváth and Szabó [OS04c]). The analytic details we present here will be the basis of the higher dimensional cases of Proposition 11.8, which we consider in the subsequent section. Our argument is inspired by work of Ozsváth and Szabó in the bordered setting [OS19]. See also [HHSZ20, Section 19.4].

Suppose  $\mathcal{H} = (\Sigma, \alpha, \beta, \mathbf{w}, \mathbf{z})$  and  $\mathcal{H}' = (\Sigma', \alpha', \beta', \mathbf{w}', \mathbf{z}')$  are multi-pointed diagrams, and suppose that  $J$  and  $J'$  are almost complex structures on  $\Sigma \times [0, 1] \times \mathbb{R}$  and  $\Sigma' \times [0, 1] \times \mathbb{R}$ , respectively. The notation  $J \wedge J'$  means the data of the pair  $J$  and  $J'$  together with distinguished connected sum points,  $p \in \Sigma$  and  $p' \in \Sigma'$ . We assume that the connected sum is admissible, in the sense of Definition 11.2.

*Remark 11.12.* In Proposition 11.8 we additionally had the assumption some of the hypercubes of attaching curves were graded by  $p$  and  $p'$ . In the present case,  $\mathcal{L}_{\alpha}$ ,  $\mathcal{L}_{\alpha'}$ ,  $\mathcal{L}_{\beta}$  and  $\mathcal{L}_{\beta'}$  are all 0-dimensional, and this condition is automatic.

For notational simplicity, we focus on the case where we have just one  $\mathcal{U}$  variable, and one  $\mathcal{V}$  variable and we are doing a connected sum of link components. The first step is to do a neck-stretching degeneration along the connected sum tube. The result of this degeneration is a chain complex, freely generated over the ground ring  $R = \mathbb{F}[\mathcal{U}, \mathcal{V}]$

by pairs  $\mathbf{x} \times \mathbf{x}'$ , where  $\mathbf{x} \in \mathbb{T}_\alpha \cap \mathbb{T}_\beta$  and  $\mathbf{x}' \in \mathbb{T}_{\alpha'} \cap \mathbb{T}_{\beta'}$ . The differential is given by the formula

$$\partial_{J \wedge J'}(\mathbf{x} \times \mathbf{x}') = \sum_{\substack{\mathbf{y} \times \mathbf{y}' \in (\mathbb{T}_\alpha \cap \mathbb{T}_\beta) \times (\mathbb{T}_{\alpha'} \cap \mathbb{T}_{\beta'}) \\ \phi \in \pi_2(\mathbf{x}, \mathbf{y}) \\ \phi' \in \pi_2(\mathbf{x}', \mathbf{y}') \\ n_p(\phi) = n_{p'}(\phi') \\ \mu(\phi) + \mu(\phi') - 2n_p(\phi) = 1}} \#(\mathcal{MM}(\phi, \phi')/\mathbb{R}) \cdot \mathcal{U}^{n_{\mathbf{w}''}(\phi + \phi')} \mathcal{V}^{n_{\mathbf{z}''}(\phi + \phi')} \cdot \mathbf{y} \times \mathbf{y}' \quad (11.1)$$

where  $\mathcal{MM}(\phi, \phi')$  is the *perfectly matched moduli space*, consisting of pairs  $(u, u')$  satisfying the following matching condition. In the following, we write  $(S^{\mathbf{q}}, j)$  and  $(T^{\mathbf{q}'}, j')$  for the sources curves of  $u$  and  $u'$ , where  $(S, j)$  and  $(T, j')$  are Riemann surfaces, and  $\mathbf{q}$  and  $\mathbf{q}'$  are ordered collections of  $n_p(\phi) = n_{p'}(\phi')$  marked points, for which we write  $\mathbf{q} = \{q_1, \dots, q_n\}$  and  $\mathbf{q}' = \{q'_1, \dots, q'_n\}$ . We define

$$\mathcal{MM}_{J \wedge J'}(\phi, \phi') := \left\{ (u, u') \left| \begin{array}{l} u \text{ is } J\text{-holomorphic} \\ u' \text{ is } J'\text{-holomorphic} \\ (\pi_\Sigma \circ u)(q_i) = p, (\pi_{\Sigma'} \circ u')(q'_i) = p' \\ (\pi_{\mathbb{D}} \circ u)(q_i) = (\pi_{\mathbb{D}} \circ u')(q'_i) \end{array} \right. \right\}. \quad (11.2)$$

It is not hard to see that this gives a chain complex, which we denote by  $CF_{J \wedge J'}(\mathcal{H}, \mathcal{H}')$ . (Compare [HHSZ20, Section 19.4]). The construction is inspired by the matched moduli spaces which appear in [LOT18, Section 9.1].

If  $I$  is a (non-singular) almost complex structure on  $\Sigma \# \Sigma' \times [0, 1] \times \mathbb{R}$ , then one may define a chain homotopy equivalence

$$CF_I(\mathcal{H} \# \mathcal{H}') \simeq CF_{J \wedge J'}(\mathcal{H}, \mathcal{H}')$$

by counting index 0 curves for a non-cylindrical almost complex structure on  $\Sigma \# \Sigma' \times [0, 1] \times \mathbb{R}$  which interpolates an ordinary cylindrical almost complex structure on  $\Sigma \# \Sigma' \times [0, 1] \times (-\infty, t_1]$ , and a degenerate almost complex structure (i.e. one with infinite neck length) on  $\Sigma \wedge \Sigma' \times [0, 1] \times [t_2, \infty)$ , for some  $t_1 \ll 0$  and  $t_2 \gg 0$ . See [HHSZ20, Section 19.4] for more details.

We now describe a chain homotopy equivalence

$$\Phi^{\bullet < \circ'} : CF_{J \wedge J'}(\mathcal{H}, \mathcal{H}') \rightarrow CF_J(\mathcal{H}) \otimes_R CF_{J'}(\mathcal{H}').$$

If  $t_0 \in \mathbb{R}$ , write

$$\lambda_{t_0} := [0, 1] \times \{t_0\} \subseteq [0, 1] \times \mathbb{R}.$$

Let us write

$$s : \Sigma \times [0, 1] \times \mathbb{R} \rightarrow [0, 1] \quad \text{and} \quad t : \Sigma \times [0, 1] \times \mathbb{R} \rightarrow \mathbb{R}$$

for the projection maps.

**Definition 11.13.** Suppose  $t_0 \in \mathbb{R}$ . A  $(\Phi, \bullet < \circ', t_0)$ -*matched  $J \wedge J'$ -holomorphic curve pair* consists of a pair of marked  $J \wedge J'$  holomorphic disks  $(u, u')$ , equipped with the following data:

- (1) A partition of the marked points of  $u$  (resp.  $u'$ ) into three sets,  $\mathbf{S}$ ,  $\mathbf{C}$  and  $\mathbf{N}$  (resp.  $\mathbf{S}'$ ,  $\mathbf{C}'$  and  $\mathbf{N}'$ ).
- (2) A bijection  $\phi : \mathbf{S} \rightarrow \mathbf{S}'$ .

We assume the following are satisfied:

- (1) If  $q_i$  is a marked point of  $u$ , then  $(\pi_{\mathbb{D}} \circ u)(q_i) = p$ , and similarly for all marked points of  $u'$
- (2) If  $q \in \mathbf{S}$  and  $q' \in \mathbf{S}'$  and  $\phi(q) = q'$ , then
 
$$(t \circ u)(q) = (t \circ u')(q') < 0 \quad \text{and} \quad (s \circ u)(q) = (s \circ u')(q')$$
- (3) If  $q \in \mathbf{N}$  then  $(t \circ u)(q) > t_0$ . The analogous statement holds for  $q' \in \mathbf{N}'$ .
- (4)  $|\mathbf{C}| = |\mathbf{C}'|$ . Furthermore, if  $q \in \mathbf{C}$  then  $(t \circ u)(q) = t_0$ , and similarly for the marked points of  $\mathbf{C}'$ . The marked points of  $\mathbf{C}$  and  $\mathbf{C}'$  alternate between those of  $\mathbf{C}$  and those of  $\mathbf{C}'$  along  $\lambda_{t_0}$ . Finally, the left-most marked point along this line is contained in  $\mathbf{C}$ .

See Figure 11.1 for a schematic of a  $(\Phi, \bullet < \circ', t_0)$ -matched curve pair.

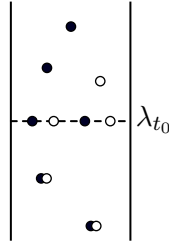

FIGURE 11.1. The projection to  $[0, 1] \times \mathbb{R}$  of marked points of a  $(\Phi, \bullet < \circ', t_0)$ -matched holomorphic curve pair. Solid dots indicate the marked points of  $u$ , while open dots are the marked points of  $u'$ . The map  $\Psi^{\bullet < \circ'}$  counts similar configurations.

If  $(\phi, \phi')$  are a pair of homology classes,  $M$  is a pair of marked source curves for  $\phi$  and  $\phi'$ , and  $t_0 \in \mathbb{R}$ , we write  $\mathcal{M}\mathcal{M}^{\Phi, \bullet < \circ'}(\phi, \phi', M, t_0)$  for the moduli space of  $(\Phi, \bullet < \circ', t_0)$ -matched disks representing  $\phi$  and  $\phi'$ . We consider the parametrized moduli space

$$\mathcal{M}\mathcal{M}^{\Phi, \bullet < \circ'}(\phi, \phi', M) = \bigcup_{t_0 \in \mathbb{R}} \mathcal{M}\mathcal{M}^{\Phi, \bullet < \circ'}(\phi, \phi', M, t_0) \times \{t_0\}.$$

If  $t_0$  is fixed, the expected dimension of  $\mathcal{M}\mathcal{M}^{\Phi, \bullet < \circ'}(\phi, \phi', M, t_0)$  is given by the formula

$$\text{ind}(\phi, \phi', M) = \mu(\phi) + \mu(\phi') - 2(|\mathbf{S}| + |\mathbf{C}|).$$

The map  $\Phi^{\bullet < \circ'}$  counts pairs of curves  $(u, u')$  in  $\mathcal{M}\mathcal{M}^{\Phi, \bullet < \circ'}(\phi, \phi', M)/\mathbb{R}$ , ranging over tuples with  $\text{ind}(\phi, \phi', M) = 0$ . Equivalently, we can think of  $\Phi^{\bullet < \circ'}$  as counting elements of the non-parametrized moduli spaces  $\mathcal{M}\mathcal{M}^{\Phi, \bullet < \circ'}(\phi, \phi', M, t_0)$  for some fixed  $t_0$ . (The parametrized perspective becomes helpful later).

Next, we explain the  $\mathcal{U}$  and  $\mathcal{V}$  weights of a curve. The basepoints not involved in the connected sum contribute powers of variables as normal. The marked points in  $\mathbf{S} \cup \mathbf{S}' \cup \mathbf{C} \cup \mathbf{C}'$  contribute algebra elements which are the same as would be counted on the connected sum of the two diagrams, where we have removed any basepoints used for the connected sum. For the marked points in  $\mathbf{N}$  and  $\mathbf{N}'$ , the algebraic contribution is the same as on the disjoint union of the two diagrams, without the basepoints removed.

Concretely, if the connected sum is formed along a link component, and  $p = w \in \mathbf{w}$  and  $p' = z' \in \mathbf{z}'$ , then the algebra element contributed by the marked points would be

$$\mathcal{U}^{|\mathbf{N}'|} \mathcal{V}^{|\mathbf{N}'|}. \tag{11.3}$$



(There would be an additional contributions from the other basepoints not involved in the connected sum). If instead the connected sum is formed at a free basepoint  $p = w \in \Sigma$  and some non-basepoint  $p' \in \Sigma'$ , then the algebra contribution from the marked points would be  $\mathcal{W}^{|\mathbf{N}|}$ .

We define a similar map

$$\Psi^{\bullet < \circ'} : CF_J(\mathcal{H}) \otimes_R CF_{J'}(\mathcal{H}') \rightarrow CF_{J \wedge J'}(\mathcal{H}, \mathcal{H}')$$

by counting holomorphic curves with similar conditions, but with the roles of the  $\mathbf{S}$  and  $\mathbf{N}$  labeled marked points switched.

*Remark 11.14.* Constant disks are counted by both  $\Phi^{\bullet < \circ'}$  and  $\Psi^{\bullet < \circ'}$ .

**Lemma 11.15.** *The maps  $\Phi^{\bullet < \circ'}$  and  $\Psi^{\bullet < \circ'}$  are chain maps.*

*Proof.* We focus on  $\Phi^{\bullet < \circ'}$  since the argument for  $\Psi^{\bullet < \circ'}$  is not substantially different. Our proof is modeled on work of Ozsváth and Szabó in the setting of bordered knot Floer homology [OS19]. The proof is to count the ends of  $(\Phi, \bullet < \circ', t_0)$ -matched moduli spaces for triples  $(\phi, \phi', M)$  with  $\text{ind}(\phi, \phi', M) = 1$ . Modulo the  $\mathbb{R}$ -action on the parametrized moduli space, such moduli spaces are 1-dimensional. In the present situation, it is sufficient to fix  $t_0 = 0$ , and consider only  $(\Phi, \bullet < \circ', 0)$ -matched holomorphic curves. The ends are constrained generically to the following configurations:

- ( $\Phi$ -1) Two paired marked points in  $\mathbf{S}$  and  $\mathbf{S}'$  may collide with the line  $\lambda_0$ , away from the marked points in  $\mathbf{C}$  and  $\mathbf{C}'$ .
- ( $\Phi$ -2) A pair of punctures in  $\mathbf{C}$  and  $\mathbf{C}'$  may collide along  $\lambda_0$ .
- ( $\Phi$ -3) A puncture of  $\mathbf{N}$  or  $\mathbf{N}'$  may collide with  $\lambda_0$  (in the complement of  $\mathbf{C}$  and  $\mathbf{C}'$ ). There are two subcases:
  - (a) After the degeneration, the marked points along  $\lambda_0$  do not alternate between those of  $u$  and  $u'$ .
  - (b) After the degeneration, the marked points along  $\lambda_0$  do alternate between those of  $u$  and  $u'$ .
- ( $\Phi$ -4) A puncture of  $\mathbf{C}$  may degenerate into an index 2 beta boundary degeneration at height  $t = 0$ .
- ( $\Phi$ -5) A puncture of  $\mathbf{C}'$  may degenerate into an index 2 alpha boundary degeneration at height  $t = 0$ .
- ( $\Phi$ -6) Strip breaking may occur, leaving a  $(\Phi, \bullet < \circ', 0)$ -matched disk of index 0 as well as a holomorphic disk of index 1 in either positive or negative direction. There are two subcases:
  - (a) The index 1 holomorphic disk degenerates towards  $-\infty$ , and is perfectly-matched.
  - (b) The index 1 holomorphic disk degenerates towards  $+\infty$ , and has trivial matching (i.e. the projections of all marked points to  $[0, 1] \times \mathbb{R}$  are distinct).

Most of these ends appear in canceling pairs, and the rest correspond to the relation  $[\partial, \Phi^{\bullet < \circ'}] = 0$ , as we describe presently.

The ends ( $\Phi$ -1) cancel with the ends ( $\Phi$ -2).

In an end of type ( $\Phi$ -3a), there are two adjacent marked points along  $\lambda_0$  which are both from  $u$  or both from  $u'$ . Such a curve appears twice in the boundary of the moduli spaces. See Figure 11.2.

The ends of type  $(\Phi\text{-3b})$  cancel with the end of type  $(\Phi\text{-4})$  and  $(\Phi\text{-5})$ . Here we are using the mod 2 count of boundary degenerations from Proposition 11.11. Note also the algebra contributions coincide for the two canceling degenerations of type  $(\Phi\text{-3b})$  and type  $(\Phi\text{-4})$  or  $(\Phi\text{-5})$  (cf. Equation (11.3)). If the connected sum is taken along a link component, each boundary degeneration which forms along  $\lambda_{t_0}$  will contain one puncture from  $\mathbf{C} \cup \mathbf{C}'$  and also one link basepoint. The degeneration which cancels this boundary degeneration formation consists of a  $\mathbf{N}$  or  $\mathbf{N}'$  puncture colliding with  $\lambda_{t_0}$ . The algebra weight from the  $\mathbf{N}$  or  $\mathbf{N}'$  puncture coincides with the weight of the basepoint which is lost in the boundary degeneration. The case of a connected sum at a free-basepoint is similar.

The remaining ends are  $(\Phi\text{-6})$ , which correspond exactly to the commutator  $[\partial, \Phi^{\bullet < o'}]$ . Summing all ends, we conclude that

$$\partial \circ \Phi^{\bullet < o'} + \Phi^{\bullet < o'} \circ \partial = 0,$$

completing the proof. □

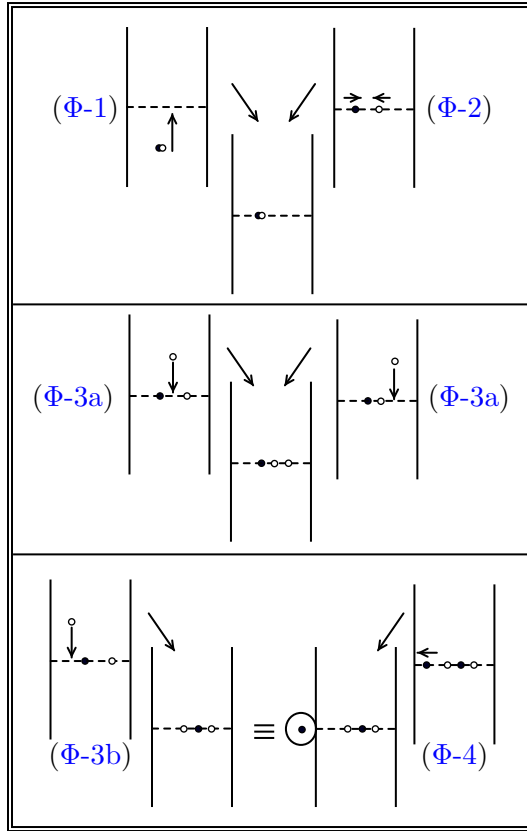

FIGURE 11.2. Some cancellations in the proof that  $\Phi^{\bullet < o'}$  and  $\Psi^{\bullet < o'}$  are chain maps

**Lemma 11.16.** *The maps  $\Phi^{\bullet < o'}$  and  $\Psi^{\bullet < o'}$  are homotopy inverses.*

*Proof.* We define two maps  $H_\wedge$  and  $H_\sqcup$ , which we prove satisfy

$$\text{id} + \Psi^{\bullet < \circ'} \circ \Phi^{\bullet < \circ'} = [\partial, H_\wedge] \quad \text{and} \quad \text{id} + \Phi^{\bullet < \circ'} \circ \Psi^{\bullet < \circ'} = [\partial, H_\sqcup]. \quad (11.4)$$

We focus on the map  $H_\wedge$ , since  $H_\sqcup$  is constructed by a straightforward modification.

The map  $H_\wedge$  counts certain curve pairs  $(u, u')$  where  $u$  has five collections of marked points, **NN**, **NC**, **M**, **SC** and **SS**, and  $u'$  has five collections of marked points **NN'**, **NC'**, **M'**, **SC'** and **SS'**.

**Definition 11.17.** Suppose that  $t_0 < t_1$  are real numbers. We say a pair of marked holomorphic strips  $(u, u')$  is  $(H_\wedge, t_0, t_1)$ -*matched* if the following are satisfied:

- (1) The marked points of **NN** and **NN'** are perfectly matched. Furthermore their projection to  $\mathbb{R}$  lies above  $t_1$ .
- (2) The marked points in **NC** and **NC'** both project to  $\lambda_{t_1}$ . Furthermore,  $|\mathbf{NC}| = |\mathbf{NC}'|$ . As one travels along  $\lambda_{t_1}$ , the marked points alternate between **NC** and **NC'**, and the left-most marked point is from **NC**, while the right most is from **NC'**.
- (3) The marked points of **M** and **M'** have no matching condition. Their projection to  $[0, 1] \times \mathbb{R}$  lies between  $\lambda_{t_0}$  and  $\lambda_{t_1}$ .
- (4) The marked points **SC** and **SC'** satisfy the same conditions as **NC** and **NC'**, except that they project to  $\lambda_{t_0}$ .

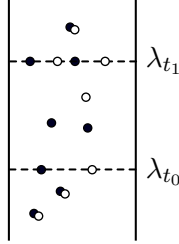

FIGURE 11.3. A  $(H_\wedge, t)$ -matched curve pair.

If  $(\phi, \phi')$  are two homology classes of disks, equipped with decorated sources and matching data  $M$ , and  $t_0 < t_1$  are fixed, then the expected dimension of the moduli space of curves which are  $(H_\wedge, t_0, t_1)$ -matched and represent  $(\phi, \phi', M)$  is given by

$$\text{ind}(\phi, \phi', M) = \mu(\phi) + \mu(\phi') - 2|\mathbf{SS}| - 2|\mathbf{NN}| - 2|\mathbf{SC}| - 2|\mathbf{NC}|.$$

Write  $\mathcal{MM}(\phi, \phi', M)$  for this moduli space. The parametrized moduli space

$$\mathcal{MM}(\phi, \phi', M) := \bigcup_{t_0 < t_1} \mathcal{MM}(\phi, \phi', M, t_0, t_1) \times \{(t_0, t_1)\}$$

has a free  $\mathbb{R}$ -action, corresponding to overall translation (acting diagonally on  $t_0$  and  $t_1$ ).

The map  $H_\wedge$  counts  $\mathcal{MM}(\phi, \phi', M)/\mathbb{R}$  for triples  $(\phi, \phi', M)$  satisfying  $\text{ind}(\phi, \phi', M) = -1$ . In this case, the expected dimension of  $\mathcal{MM}(\phi, \phi', M)$  is 1.

To verify Equation (11.4), we count the ends of the parametrized moduli spaces  $\mathcal{MM}(\phi, \phi', M)/\mathbb{R}$  where  $\text{ind}(\phi, \phi', M) = 0$  (so that  $\dim \mathcal{MM}(\phi, \phi', M)/\mathbb{R} = 1$ ).

There are ends which occur at  $0 < t_1 - t_0 < \infty$ . These are the obvious analogs of the ends in the case of one special line  $(\Phi-1), \dots, (\Phi-5)$ . They cancel by an identical proof to the case of one special line.

It remains to analyze the curves which appear as  $t_1 - t_0 \rightarrow 0$  or  $t_1 - t_0 \rightarrow \infty$ . The ends which appear as  $t_1 - t_0 \rightarrow \infty$  are easy to analyze: they correspond exactly to the composition  $\Psi^{\bullet < \circ'} \circ \Phi^{\bullet < \circ'}$ . We now focus on the ends which appear as  $t_1 - t_0 \rightarrow 0$ . These correspond to the lines  $\lambda_{t_0}$  and  $\lambda_{t_1}$  colliding to form a single line, for which we write  $\lambda_{t'}$ . The limiting curves live in a moduli space of pairs  $(u, u')$  where the points of  $\mathbf{SS}$  are perfectly matched with  $\mathbf{SS}'$  and  $\mathbf{NN}$  are perfectly matched to  $\mathbf{NN}'$ , and the rest of the marked points are matched to  $\lambda_{t'}$ . For fixed  $t'$ , this moduli space has expected dimension

$$\mu(\phi) + \mu(\phi') - 2|\mathbf{SS}| - 2|\mathbf{NN}| - 2|\mathbf{SC}| - 2|\mathbf{NC}| - |\mathbf{M}| - |\mathbf{M}'|.$$

By assumption, the above quantity is  $-|\mathbf{M}| - |\mathbf{M}'|$ . The moduli space which is parametrized over all  $t'$  has dimension  $-|\mathbf{M}| - |\mathbf{M}'| + 1$ , but since it also has a free  $\mathbb{R}$  action, we conclude that  $-|\mathbf{M}| - |\mathbf{M}'| \geq 0$ , so  $|\mathbf{M}| = |\mathbf{M}'| = 0$ .

There are two remaining cases for the curves appearing as  $t_1 - t_0 \rightarrow 0$ :

$(H_{\wedge}-1)$   $|\mathbf{SC}| = |\mathbf{NC}| = |\mathbf{SC}'| = |\mathbf{NC}'| = 0$ .

$(H_{\wedge}-2)$  At least one of  $|\mathbf{SC}|, |\mathbf{NC}|, |\mathbf{SC}'|, |\mathbf{NC}'|$  is non-empty.

For the ends  $(H_{\wedge}-1)$ , there are no marked points along the special line and the limiting curve pair  $(u, u')$  is perfectly matched, similar to the curves counted by  $\partial_{J_{\wedge} J'}$  in Equation (11.1), except  $(u, u')$  has index 0 (i.e. the expected dimension, ignoring the special line is 0). Using transversality and expected dimension counts, we see that  $u$  and  $u'$  must both represent the constant class. These ends contribute  $\text{id}_{CF_{J_{\wedge} J'}(\mathcal{H}, \mathcal{H}')}$  to the left equation of (11.4).

We now consider the ends labeled  $(H_{\wedge}-2)$ . We claim that these appear in canceling pairs. Indeed, each such end appears with even multiplicity, corresponding to switching the roles of  $\mathbf{NC}$  and  $\mathbf{SC}$ , and switching  $\mathbf{NC}'$  and  $\mathbf{SC}'$  (i.e. having the special lines pass through each other). See Figure 11.4.

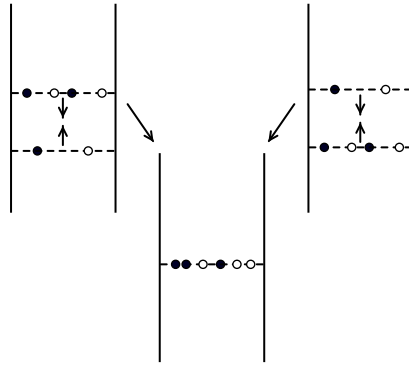

FIGURE 11.4. The cancellation of the ends labeled  $(H_{\wedge}-2)$ .

The construction of the homotopy  $H_{\cup}$  is defined via the obvious modification, and a similar analysis goes through to establish the right equation of (11.4).  $\square$

**11.3. Connected sums and hypercubes.** We now extend the work of the previous section to handle the more general case of hypercubes of dimension greater than 0. We focus on the case that  $\mathcal{L}_\alpha$  and  $\mathcal{L}_{\alpha'}$  are 0-dimensional, i.e.  $\mathcal{L}_\alpha = \alpha$  and  $\mathcal{L}_{\alpha'} = \alpha'$ , while  $\mathcal{L}_\beta$  and  $\mathcal{L}_{\beta'}$  are of arbitrary dimension.

Similar to the setting of ordinary Floer complexes in Section 11.2, it is straightforward to construct a neck-stretching homotopy equivalence

$$CF_I(\Sigma \# \Sigma', \alpha \cup \alpha', \mathcal{L}_\beta \otimes \mathcal{L}_{\beta'}) \simeq CF_{J \wedge J'}(\Sigma \wedge \Sigma', \alpha \cup \alpha', \mathcal{L}_\beta \otimes \mathcal{L}_{\beta'}).$$

The construction is essentially the same as the construction of a homotopy equivalence of hypercubes for changing the almost complex structure. Compare [HHSZ20, Section 14.2].

The goal of this section is to describe a homotopy equivalence of hypercubes

$$\Phi^{\bullet < o'} : CF_{J \wedge J'}(\Sigma \wedge \Sigma', \alpha \cup \alpha', \mathcal{L}_\beta \otimes \mathcal{L}_{\beta'}) \rightarrow CF_{J \sqcup J'}(\Sigma \sqcup \Sigma', \alpha \cup \alpha', \mathcal{L}_\beta \otimes \mathcal{L}_{\beta'}).$$

under certain restrictions on  $\mathcal{L}_\beta$  and  $\mathcal{L}_{\beta'}$ . In the domain of  $\Phi^{\bullet < o'}$ , the curves counted are perfectly-matched. In codomain, the curves have trivial matching (i.e. they are counted in the normal way for disconnected Heegaard surfaces, as in Section 10.2). The map  $\Phi^{\bullet < o'}$  is an extension of the map defined in the previous section, which we describe momentarily. Note that by Proposition 10.1, the codomain of  $\Phi^{\bullet < o'}$  is homotopy equivalent to the tensor product of  $CF_J(\Sigma, \alpha, \mathcal{L}_\beta)$  and  $CF_{J'}(\Sigma', \alpha', \mathcal{L}_{\beta'})$ , if the hypercube  $\mathcal{L}_\beta \otimes \mathcal{L}_{\beta'}$  is constructed with sufficiently small Hamiltonian translations.

Similar to the case of connected sums, we will define the map  $\Phi^{\bullet < o'}$  to count holomorphic polygons with a special line.

To simplify the exposition and notation, it is helpful to establish a few conventions. Firstly, we recall that the holomorphic  $\ell$ -gon maps require a choice of a family of almost complex structures  $(J_x)_{x \in K_{\ell-1}}$ . The space  $K_{\ell-1}$  may be identified with the moduli space of disks with  $\ell$  marked points along its boundary. For the sake of notation, it is more convenient to consider the moduli space of  $\ell - 2$  marked points along the line

$$\{0\} \times \mathbb{R} \subseteq [0, 1] \times \mathbb{R}.$$

Overall translation by the  $\mathbb{R}$ -action gives equivalent elements in the moduli space. For our purposes, it is actually more convenient to not initially quotient by this action, and consider a family of almost complex structures  $(J_{x,\tau})_{(x,\tau) \in K_{\ell-1} \times \mathbb{R}}$ . Let  $T_r$  denote translation of the  $\mathbb{R}$  component of  $\Sigma \times [0, 1] \times \mathbb{R}$  by  $r$  units. We require that

$$J_{x,\tau} = (T_r^*)(J_{x,\tau+r}),$$

for each  $x \in K_{\ell-1}$ , and  $\tau, r \in \mathbb{R}$ . Note that this does *not* imply that each  $J_{x,\tau}$  is translation invariant under the  $\mathbb{R}$ -action on  $[0, 1] \times \mathbb{R}$ .

With this convention, the normal  $\ell$ -gon counting maps can be viewed as counting the 1-dimensional parametrized moduli spaces

$$\bigcup_{(x,\tau) \in K_{\ell-1} \times \mathbb{R}} \mathcal{M}_{J_x}(\psi) \times \{(x, \tau)\},$$

modulo their free  $\mathbb{R}$ -action.

If  $t_0 \in \mathbb{R}$ , the notion of a  $(\Phi, \bullet < o', t_0)$ -matched pair of  $(\ell + 1)$ -gons is easily adapted from Definition 11.13. (Note that to define the map  $\Phi^{\bullet < o'}$ , the indexing is somewhat more natural if we count  $(\ell + 1)$ -gons than  $\ell$ -gons). Here,  $t_0$  denotes the height of

the special line, where the marked points  $\mathbf{C}$  and  $\mathbf{C}'$  are matched. If  $(\psi, \psi', M)$  is a triple consisting of two homology classes of  $(\ell + 1)$ -gons, and  $M$  is a pair of decorated source curves and matching data, and  $(x, \tau) \in K_\ell \times \mathbb{R}$  and  $t_0 \in \mathbb{R}$  is fixed, then the expected dimension of the moduli space of  $(\Phi, \bullet < \circ', t_0)$ -matched  $(\ell + 1)$ -gons, denoted  $\mathcal{MM}_{J, \tau}^{\Phi, \bullet < \circ'}(\psi, \psi', M, t_0)$ , is given by

$$\text{ind}(\psi, \psi', M) = \mu(\psi) + \mu(\psi') - 2|\mathbf{S}| - 2|\mathbf{C}|.$$

This is because the moduli space with  $J_{x, \tau}$  fixed but with no puncture constraints has expected dimension  $\mu(\psi) + \mu(\psi')$ , and the perfect matching below  $t_0$  and the matching along the special line give a codimension  $2(|\mathbf{S}| + |\mathbf{C}|)$  constraint.

If  $J = (J_{(x, \tau)})_{(x, \tau) \in K_\ell \times \mathbb{R}}$  is a family, we define the parametrized moduli space

$$\mathcal{MM}_J^{\Phi, \bullet < \circ'}(\psi, \psi', M) = \bigcup_{\substack{(x, \tau) \in K_\ell \times \mathbb{R} \\ t_0 \in \mathbb{R}}} \mathcal{MM}_{J_{(x, \tau)}}^{\Phi, \bullet < \circ'}(\psi, \psi', M, t_0) \times \{(x, \tau, t_0)\},$$

which has expected dimension

$$e \dim \mathcal{MM}_J^{\Phi, \bullet < \circ'}(\psi, \psi', M) = \text{ind}(\psi, \psi', M) + \ell, \quad (11.5)$$

and has a free  $\mathbb{R}$ -action.

We now define our hypercube morphism  $\Phi^{\bullet < \circ'}$ . If  $\kappa \leq \kappa'$  and  $\kappa, \kappa' \in \mathbb{E}_{n+m}$ , we define the component  $\Phi_{\kappa \rightarrow \kappa'}^{\bullet < \circ'}$  of  $\Phi^{\bullet < \circ'}$  as follows. If  $\kappa = \kappa' = (\varepsilon, \nu)$ , then the map

$$\Phi_{\kappa \rightarrow \kappa'}^{\bullet < \circ'} : CF_{J \wedge J'}(\Sigma \wedge \Sigma', \alpha \cup \alpha', \beta_\varepsilon \cup \beta'_\nu) \rightarrow CF_{J \sqcup J'}(\Sigma \sqcup \Sigma', \alpha \cup \alpha', \beta_\varepsilon \cup \beta'_\nu)$$

is the tensor product map defined in Section 11.2.

If  $\kappa_1 < \dots < \kappa_\ell$  is an increasing sequence of points in  $\mathbb{E}_{n+m}$ , then we write  $\kappa_j = (\varepsilon_j, \nu_j)$  and we define a map

$$\varphi_{\kappa_1 < \dots < \kappa_\ell}^{\bullet < \circ'} : CF_{J \wedge J'}(\Sigma \wedge \Sigma', \alpha \cup \alpha', \beta_{\varepsilon_1} \cup \beta'_{\nu_1}) \rightarrow CF_{J \sqcup J'}(\Sigma \wedge \Sigma', \alpha \cup \alpha', \beta_{\varepsilon_\ell} \cup \beta'_{\nu_\ell})$$

by counting  $(\Phi, \bullet < \circ', t_0)$ -matched holomorphic  $(\ell + 1)$ -gons which have  $\text{ind}(\psi, \psi', M) = 1 - \ell$ , and all of whose special inputs come from  $\mathcal{L}_\beta \otimes \mathcal{L}_{\beta'}$ . By Equation (11.5) the parametrized moduli spaces of such families have expected dimension 1, and also have a free  $\mathbb{R}$ -action.

If  $\kappa < \kappa'$ , then we define

$$\Phi_{\kappa \rightarrow \kappa'}^{\bullet < \circ'} := \sum_{\kappa = \kappa_1 < \dots < \kappa_\ell = \kappa'} \varphi_{\kappa_1 < \dots < \kappa_\ell}.$$

We may also define a map

$$\Psi^{\bullet < \circ'} : CF_{J \sqcup J'}(\Sigma \sqcup \Sigma', \alpha \cup \alpha', \mathcal{L}_\beta \otimes \mathcal{L}_{\beta'}) \rightarrow CF_{J \wedge J'}(\Sigma \wedge \Sigma', \alpha \cup \alpha', \mathcal{L}_\beta \otimes \mathcal{L}_{\beta'})$$

in the opposite direction via the obvious modification.

**Lemma 11.18.** *Suppose that  $\mathcal{L}_\beta$  and  $\mathcal{L}_{\beta'}$  are hypercubes of beta attaching curves on  $\Sigma$  and  $\Sigma'$ , respectively, and  $p \in \Sigma$  and  $p' \in \Sigma'$  are choices of connected sum points. Suppose the following are satisfied:*

- (1)  $\mathcal{L}_\beta$  and  $\mathcal{L}_{\beta'}$  are algebraically rigid.
- (2)  $\mathcal{L}_\beta$  is graded by  $p$ .

The following are the generic codimension 1 degenerations in the parametrized moduli spaces of  $(\Phi, \bullet < \circ', t_0)$ -matched  $(\ell + 1)$ -gon curve pairs on  $(\Sigma \wedge \Sigma', \alpha \cup \alpha', \mathcal{L}_\beta \otimes \mathcal{L}_{\beta'})$  representing classes with matching data satisfying  $\text{ind}(\psi, \psi', M) = 2 - \ell$  (i.e. of expected dimension 1 after quotienting by the free  $\mathbb{R}$ -action), where the special beta inputs are from the hypercube  $\mathcal{L}_\beta \otimes \mathcal{L}_{\beta'}$ :

- ( $\Phi^\ell$ -1) Two paired marked points in  $\mathbf{S}$  and  $\mathbf{S}'$  may collide with the special line (away from the marked points  $\mathbf{C}$  and  $\mathbf{C}'$ ). None of the punctures in  $\mathbf{P} \cup \mathbf{P}'$  have the same height as the special line.
- ( $\Phi^\ell$ -2) A pair of punctures of  $\mathbf{C}$  and  $\mathbf{C}'$  may collide along  $\lambda_{t_0}$  (and the  $\mathbf{P}$  and  $\mathbf{P}'$  punctures have different heights than  $\lambda_{t_0}$ ).
- ( $\Phi^\ell$ -3) A puncture of  $\mathbf{N}$  or  $\mathbf{N}'$  may collide with  $\lambda_{t_0}$  (in the complement of  $\mathbf{C}$  and  $\mathbf{C}'$ , and with different height than  $\mathbf{P}$  and  $\mathbf{P}'$ ).
- ( $\Phi^\ell$ -4) A puncture of  $\mathbf{C}$  may degenerate into an index 2 beta boundary degeneration or alpha boundary degeneration. The height  $\lambda_{t_0}$  is different than any puncture in  $\mathbf{P}$  or  $\mathbf{P}'$ .
- ( $\Phi^\ell$ -5) The holomorphic pair  $(u, u')$  may break into two  $\mathbb{R}$ -levels, exactly one of which contains the special line.
- ( $\Phi^\ell$ -6) Degenerations may occur which involve the punctures  $\mathbf{P}$  and  $\mathbf{P}'$ . These are constrained to the following:
  - (a) An index 1 disk pair may bubble at two punctures of  $\mathbf{P} \cup \mathbf{P}'$ . If it degenerates above the special line, then the matching is trivial. If it degenerates below the special line, the matching is perfect.
  - (b) Four punctures of  $\mathbf{P} \cup \mathbf{P}'$  collide and bubble off a pair of index 0 holomorphic triangles. If they form below the special line, the matching is perfect. If they occur above the special line, the matching is trivial.

See Figure 11.5 for a schematic of the above degenerations.

*Proof.* The claim that these degenerations have codimension 1 is clear. We claim that there are no further degenerations. There are two points which require explanation:

- (P-1) There are generically no degenerations involving the punctures  $\mathbf{P} \cup \mathbf{P}'$  which leave a puncture along  $\{0\} \times \mathbb{R}$  of the same height as the special line  $\lambda_{t_0}$ .
- (P-2) The generic degenerations involving the punctures  $\mathbf{P}$  or  $\mathbf{P}'$  along  $\{0\} \times \mathbb{R}$  (which necessarily occur at heights other than that of the special line by (P-1)) are constrained to those listed in ( $\Phi^\ell$ -6). In particular, they are constrained only to index 1 disk bubbling and index 0 triangle degenerations. Such curves are perfectly matched if they occur below the special line, and trivially matched if they occur above the special line. Degenerations of pairs of  $j$ -gons at these punctures are prohibited for  $j > 3$ .

See Figure 11.6 for a schematic of a degeneration which we claim is non-generic.

We now argue that degenerations (P-1) are non-generic. Consider a pair  $(u, u')$  of broken curves obtained as the limit of a 1-parameter family of  $(\Phi, \bullet < \circ', t_0)$ -matched  $(\ell + 1)$ -gons, representing a pair of classes  $(\psi, \psi')$ , all of whose special inputs are the top degree generators. Assume that each of  $u$  and  $u'$  consist of a  $j$ -gon and a  $k$ -gon for

$$j + k = \ell + 3. \quad (11.6)$$

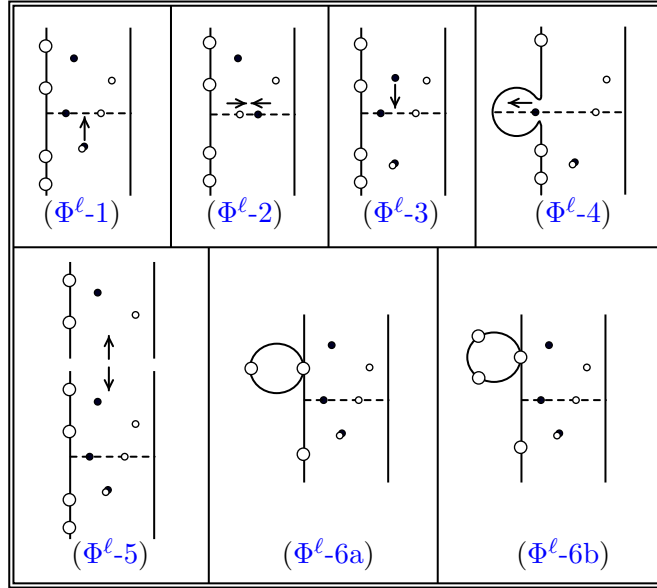

FIGURE 11.5. The generic degenerations of  $(\Phi, \bullet < \circ', t_0)$ -matched holomorphic  $\ell$ -gon pairs. The large boundary dots denote punctures of  $\mathbf{P}$  and  $\mathbf{P}'$ .

Such a degeneration corresponds to the codimension 1 strata of  $K_\ell$ . Our argument extends easily to further degenerations of into a tree of curves, corresponding to the higher codimension strata of  $K_\ell$ , though we focus on the codimension 1 strata to simplify the notation.

Suppose that  $u$  degenerates into a pair  $u_r$  and  $u_l$ , where  $u_r$  is a map into  $\Sigma \times [0, 1] \times \mathbb{R}$ , and we view  $u_l$  as a map into  $\Sigma \times \mathbb{H}$  where  $\mathbb{H} = [0, \infty) \times \mathbb{R}$ . Here,  $u_r$  and  $u_l$  have additional boundary punctures, and we think of  $u_r$  as a holomorphic  $k$ -gon, and we think of  $u_l$  as a holomorphic  $j$ -gon. We assume that  $u'$  similarly consists of a pair  $u'_l$  and  $u'_r$ , which are holomorphic  $j$ -gons and  $k$ -gons.

We assume for the sake of the argument that  $j, k \geq 2$ . Note that we automatically have  $k \geq 2$ , since there are the punctures at  $\pm\infty$ . The case that  $j = 1$  corresponds to a boundary degeneration. In this case, we may fill in the boundary puncture for the curves  $u_r$  and  $u'_r$  and obtain an  $(\ell + 1)$ -gon. We leave it to the reader to analyze the case of boundary degenerations by adapting the index arguments we present.

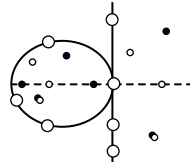

FIGURE 11.6. A putative example of a degeneration of type  $(P-1)$ . Big dots are boundary punctures. Small dots are marked points. The left disk is identified with  $\mathbb{H}$ .



In the limit, write  $\mathbf{N}_l, \mathbf{N}_r$ , (resp.  $\mathbf{C}_l, \mathbf{C}_r$ ) (resp.  $\mathbf{S}_l, \mathbf{S}_r$ ) for the marked points of  $u_l$  and  $u_r$  that lie above above, (resp. on) (resp. below) the special line. Write  $\mathbf{N}'_l$  (and so forth) for the analogous marked points of  $u'_l$  and  $u'_r$ . Here, we use the same designation of  $\mathbf{N}$ ,  $\mathbf{C}$  and  $\mathbf{S}$  as from the 1-parameter family (so in principle, it is possible for a  $\mathbf{N}$ -marked point to lie on the special line, though it will follow from our argument that these degenerations occur in too high of codimension to be generic).

By construction of the 1-parameter family relevant to the degeneration, we have

$$\mu(\psi) + \mu(\psi') + \ell - 2 - 2(|\mathbf{C}| + |\mathbf{S}|) = 0. \quad (11.7)$$

For these families, the parametrized moduli space has expected dimension 2 by Equation (11.5), and also has a free  $\mathbb{R}$ -action. We note that  $|\mathbf{N}| = |\mathbf{N}_l| + |\mathbf{N}_r|$ , and similarly for the other collections of marked points.

We may view the pair  $(u_l, u'_l)$  as determining a map to  $(\Sigma \sqcup \Sigma') \times [0, \infty) \times \mathbb{R}$ . Excluding the puncture at  $\infty$ , there are  $j - 1$  punctures along  $\{0\} \times \mathbb{R}$ . We normalize the limit so that the special line coincides with  $[0, \infty) \times \{0\}$ . There is a 1-parameter family of conformal automorphisms of the half plane which preserve this line. They are multiplication by positive real numbers.

We claim that

$$\mu(\psi_l) + \mu(\psi'_l) + j - 2 - 2|\mathbf{S}_l| - \max(|\mathbf{C}_l| + |\mathbf{C}'_l|, 1) \geq 0. \quad (11.8)$$

The reasoning for the above equation is as follows. We may view the limiting curves as being elements of a moduli space of holomorphic curves which is parametrized by the moduli space of  $j - 1$  marked points along  $\{0\} \times \mathbb{R}$ . This is a  $j - 1$  dimensional moduli space, however there is a free action by  $\mathbb{R} \times (0, \infty)$ . The  $\mathbb{R}$ -factor translates in the  $i$ -direction, and the  $(0, \infty)$ -factor scales by a real positive number. If  $|\mathbf{C}_l| + |\mathbf{C}'_l| = 0$ , then both of these actions preserve the moduli space of curves which are parametrized over the moduli space of  $j - 1$  points along  $\{0\} \times \mathbb{R}$ , and normalized so that the special line is  $\{0\} \times [0, \infty)$ . This parametrized moduli space has expected dimension  $\mu(\psi_l) + \mu(\psi'_l) + j - 1 - 2|\mathbf{S}_l|$ . Hence  $\mu(\psi_l) + \mu(\psi'_l) + j - 3 - 2|\mathbf{S}_l| \geq 0$  if this moduli space is non-empty, as claimed. If  $|\mathbf{C}_l| + |\mathbf{C}'_l| \geq 1$ , then the  $\mathbb{R}$ -action which translates in the  $i$ -direction no longer preserves the matched moduli space, but the  $(0, \infty)$ -action does preserve the matched moduli space, so instead we only obtain

$$\mu(\psi_l) + \mu(\psi'_l) + j - 2 - 2|\mathbf{S}_l| - |\mathbf{C}_l| - |\mathbf{C}'_l| \geq 0,$$

as claimed.

Similarly,  $(u_r, u'_r)$  can be viewed as living in a moduli space of  $k$ -gons where the marked points  $\mathbf{C}_r$  and  $\mathbf{C}'_r$  lie on the line  $\lambda_{t_0}$ , the marked points  $\mathbf{S}_r$  and  $\mathbf{S}'_r$  are perfectly matched, and also that there is a boundary puncture which has the same height as the special line. Since the expected dimension of this moduli space must be nonnegative if it admits a representative, we conclude that

$$\mu(\psi_r) + \mu(\psi'_r) + k - 3 - 2|\mathbf{S}_r| - |\mathbf{C}_r| - |\mathbf{C}'_r| \geq 0. \quad (11.9)$$

We may rearrange Equations (11.7) and (11.6) to obtain

$$\begin{aligned} 0 &= \mu(\psi) + \mu(\psi') + \ell - 2 - 2(|\mathbf{C}| + |\mathbf{S}|) \\ &= \mu(\psi_l) + \mu(\psi'_l) + j - 2 - |\mathbf{C}_l| - |\mathbf{C}'_l| - 2|\mathbf{S}_l| \\ &\quad + \mu(\psi_r) + \mu(\psi'_r) + k - 3 - |\mathbf{C}_r| - |\mathbf{C}'_r| - 2|\mathbf{S}_r|. \end{aligned} \quad (11.10)$$

Next, since  $\mathcal{L}_\beta$  is algebraically rigid and graded by  $p$ , we obtain

$$\mu(\psi_l) \geq 2n_p(\psi_l) = 2|\mathbf{C}_l| + 2|\mathbf{S}_l| + 2|\mathbf{N}_l|. \quad (11.11)$$

See Definition 11.4. In particular, we obtain that

$$\mu(\psi_l) + \mu(\psi'_l) + j - 2 - |\mathbf{C}_l| - |\mathbf{C}'_l| - 2|\mathbf{S}_l| \geq \mu(\psi'_l) + j - 2 + |\mathbf{C}_l| - |\mathbf{C}'_l| + 2|\mathbf{N}_l|. \quad (11.12)$$

Since we are performing the  $\bullet < o'$  degeneration, we know also that

$$|\mathbf{C}_l| \geq |\mathbf{C}'_l| \geq |\mathbf{C}_l| - 1, \quad (11.13)$$

since the left-most puncture along the special line will be in  $\mathbf{C}_l$ . By transversality for ordinary  $j$ -gons, we know that

$$\mu(\psi'_l) + j - 2 \geq 1. \quad (11.14)$$

In particular, from Equations (11.12) and (11.14) we obtain that

$$\mu(\psi_l) + \mu(\psi'_l) + j - 2 - |\mathbf{C}_l| - |\mathbf{C}'_l| - 2|\mathbf{S}_l| \geq 1. \quad (11.15)$$

Equations (11.8) and (11.15) imply that Equation (11.10) is the sum of two nonnegative integers, one of which is at least 1. Hence the equation is never satisfiable. This implies claim (P-1).

It remains to consider degenerations into polygons where the special line does not occur at the same height as one of the punctures in  $\mathbf{P} \cup \mathbf{P}'$ . In such cases,  $|\mathbf{C}_l| = |\mathbf{C}'_l| = 0$ . Furthermore, Equations (11.8) and (11.9) adapt to show that

$$\begin{aligned} \mu(\psi_l) + \mu(\psi'_l) + j - 3 - 2|\mathbf{S}_l| &\geq 0 \quad \text{and} \\ \mu(\psi_r) + \mu(\psi'_r) + k - 2 - 2|\mathbf{S}_r| - |\mathbf{C}_r| - |\mathbf{C}'_r| &\geq 0. \end{aligned} \quad (11.16)$$

Arguing similarly to Equation (11.10), we see that both of the two inequalities above are equalities.

We consider first the case that  $(u_l, u'_l)$  form below the special line. In this case, we observe that  $\psi_l \# \psi'_l$  may be viewed as a class on  $\Sigma \# \Sigma'$  since they have the same multiplicity at the connected sum point. The excision principle for the index (i.e. deleting disks at the connected sum points) implies that

$$\mu(\psi_l \# \psi'_l) = \mu(\psi_l) + \mu(\psi'_l) - 2|\mathbf{S}_l|.$$

By the absolute grading formula, if  $\mathbf{z}$  is the outgoing intersection point of  $\psi_l \# \psi'_l$ , we have

$$\mu(\psi_l \# \psi'_l) = n_{\mathbf{w}''}(\psi_l \# \psi'_l) + \text{gr}(\Theta^+, \mathbf{z}),$$

since the inputs of  $\psi_l \# \psi'_l$  consist of only the top degree intersection points. We conclude that  $\mu(\psi_l \# \psi'_l) \geq 0$ . The first line of Equation (11.16) (now known to be an equality) now implies that  $j - 3 \leq 0$ . The only possibilities are  $j = 2, 3$ , as claimed. Degenerations of  $j$ -gons above the special line are handled via an essentially identical argument.  $\square$

**Lemma 11.19.** *Under the assumptions in Lemma 11.18, the maps  $\Phi^{\bullet < o'}$  and  $\Psi^{\bullet < o'}$  are chain maps of hypercubes.*

*Proof.* We focus on the map  $\Phi^{\bullet < o'}$ , since the analysis for  $\Psi^{\bullet < o'}$  is nearly identical. Suppose  $\kappa \leq \kappa' \in \mathbb{E}_{n+m}$ , and consider the hypercube relations for  $\text{Cone}(\Phi^{\bullet < o'})$ . If  $\kappa = \kappa'$ , then the hypercube relations follow from Lemma 11.15, so assume  $\kappa < \kappa'$ .

Suppose that  $\kappa = \kappa_1 < \dots < \kappa_\ell = \kappa'$ . We count the ends of 1-dimensional families of  $(\Phi, \bullet < o', t_0)$ -matched  $\ell + 1$ -gons, which have inputs from  $\mathcal{L}_\beta \otimes \mathcal{L}_{\beta'}$ . The codimension

1 degenerations are analyzed in Lemma 11.18. Many of these ends have a similar cancellation pattern as to Lemma 11.15. For example the ends  $(\Phi^\ell-1)$  and  $(\Phi^\ell-2)$  cancel modulo 0. Similarly, each curve satisfying  $(\Phi^\ell-3)$  appears twice in the boundary of the modulo space, unless the limiting marked points alternate between  $\Sigma$  and  $\Sigma'$ , in which case the curves cancel the degenerations in  $(\Phi^\ell-4)$ . The curves appearing in  $(\Phi^\ell-6)$  cancel modulo 2 because of the hypercube relations for  $\mathcal{L}_\beta \otimes \mathcal{L}_{\beta'}$  (on both  $\Sigma \sqcup \Sigma'$  and  $\Sigma \wedge \Sigma'$ ).

The remaining curves are those which appear in the degenerations labeled  $(\Phi^\ell-5)$ . These ends correspond exactly to the hypercube relations for the mapping cone of  $\Phi^{\bullet < o'}$ . This verifies that  $\Phi^{\bullet < o'}$  is a chain map.  $\square$

*Remark 11.20.* In the above, we assumed that  $\mathcal{L}_\alpha \otimes \mathcal{L}_{\alpha'}$  was 0-dimensional. In the case that both  $\mathcal{L}_\alpha \otimes \mathcal{L}_{\alpha'}$  and  $\mathcal{L}_\beta \otimes \mathcal{L}_{\beta'}$  have positive dimension, the argument is essentially the same. The only additional subtlety concerns which hypercubes must be graded by  $p$  and  $p'$ . In the above, we used that  $\mathcal{L}_\beta$  was graded by  $p$  to give Equations (11.11) and (11.13) for degenerations along  $\{0\} \times \mathbb{R}$ . To obtain the analogous bounds for degenerations along  $\{1\} \times \mathbb{R}$  we instead would need  $\mathcal{L}_{\alpha'}$  to be graded by  $p'$ , as in the statement of Proposition 11.8.

**Lemma 11.21.** *Under the assumptions in Lemma 11.18, the maps  $\Phi^{\bullet < o'}$  and  $\Psi^{\bullet < o'}$  are homotopy inverses of each other.*

*Proof.* The proof is similar to the proof of Lemma 11.16. Indeed, one can define  $(H_\wedge, t_0)$ -matched holomorphic  $(\ell + 1)$ -gons by analogy to the case of disks. Counting such curves gives a morphism of hypercubes

$$H_\wedge: CF(\Sigma \wedge \Sigma', \alpha \cup \alpha', \mathcal{L}_\beta \otimes \mathcal{L}_{\beta'}) \rightarrow CF(\Sigma \sqcup \Sigma', \alpha \cup \alpha', \mathcal{L}_\beta \otimes \mathcal{L}_{\beta'}).$$

By a straightforward adaptation of Lemma 11.18 to the case where there are two special lines, and by adapting the argument from Lemma 11.16 to handle the limiting curves appearing as the special lines collide, we obtain exactly that the following diagram is an  $(n + m + 2)$ -dimensional hypercube of chain complexes:

$$\begin{array}{ccc} CF(\Sigma \wedge \Sigma', \alpha \cup \alpha', \mathcal{L}_\beta \otimes \mathcal{L}_{\beta'}) & \xrightarrow{\Phi^{\bullet < o'}} & CF(\Sigma \sqcup \Sigma', \alpha \cup \alpha', \mathcal{L}_\beta \otimes \mathcal{L}_{\beta'}) \\ \downarrow \text{id} & \dashrightarrow^{H_\wedge} & \downarrow \Psi^{\bullet < o'} \\ CF(\Sigma \wedge \Sigma', \alpha \cup \alpha', \mathcal{L}_\beta \otimes \mathcal{L}_{\beta'}) & \xrightarrow{\text{id}} & CF(\Sigma \wedge \Sigma', \alpha \cup \alpha', \mathcal{L}_\beta \otimes \mathcal{L}_{\beta'}) \end{array}$$

The above diagram realizes the relation

$$\Psi^{\bullet < o'} \circ \Phi^{\bullet < o'} + \text{id} = [\partial, H_\wedge],$$

completing the proof. A homotopy equivalence in the other direction is defined by the obvious adaptation.  $\square$

## 12. THE PAIRING THEOREM

In this section, we prove the pairing theorem. We prove Theorems 1.3 and 1.4 of the introduction, as well as some generalizations and refinements.

**12.1. The statement.** We now state the pairing theorem (i.e. connected sum formula). In this section, we state the pairing theorem for links in terms of a box-tensor product. In Section 12.2, we unpack the statement in terms of the link surgery complexes. In Section 12.3, we prove the statement.

**Theorem 12.1.** *Suppose that  $L_1$  and  $L_2$  are two links in  $S^3$ , which are equipped with systems of arcs  $\mathcal{A}_1$  and  $\mathcal{A}_2$ , respectively. Form their connected sum  $L_1\#L_2$  along two distinguished components  $K_1 \subseteq L_1$  and  $K_2 \subseteq L_2$ . Assume the arc for  $K_1$  is alpha-parallel and that the arc for  $K_2$  is beta-parallel. Let  $\mathcal{A}_1\#\mathcal{A}_2$  denote the connected sum, in the sense of Section 9.6 (see in particular (#-3)). Then*

$$\mathcal{X}_{\Lambda_1+\Lambda_2}(L_1\#L_2, \mathcal{A}_1\#\mathcal{A}_2)^{\mathcal{L}_{\ell_1+\ell_2-1}} \simeq (\mathcal{X}_{\Lambda_1}(L_1, \mathcal{A}_1)^{\mathcal{L}_{\ell_1}} \otimes_{\mathbb{F}} \mathcal{X}_{\Lambda_2}(L_2, \mathcal{A}_2)^{\mathcal{L}_{\ell_2}}) \hat{\boxtimes}_{\mathcal{K}|\mathcal{K}} M^{\mathcal{K}}.$$

*Remark 12.2.* In Theorem 12.1, the arc of  $\mathcal{A}_1\#\mathcal{A}_2$  for  $K_1\#K_2$  is the co-core of the band used to form the connected sum. See Figure 9.3.

**12.2. Unpacking the statement.** We now give a concrete reformulation of the pairing theorem from the previous section, in terms of the knot and link surgery complexes.

We begin by unpacking the claim for the Ozsváth–Szabó mapping cone complex  $\mathbb{X}_{\lambda}(Y_1\#Y_2, K_1\#K_2)$ . For  $i \in \{1, 2\}$ , the complex  $\mathbb{X}_{\lambda_i}(Y_i, K_i)$  is the mapping cone complex

$$\mathbb{X}_{\lambda_i}(Y_i, K_i) = \text{Cone} \left( \mathbb{A}(K_i) \xrightarrow{v^{(Y_i, K_i)} + h_{\lambda_i}^{(Y_i, K_i)}} \mathbb{B}(K_i) \right)$$

We recall from Lemma 7.5 that we may identify  $\mathbb{A}(K_i)$  with a completion of  $\mathcal{CFK}(Y_i, K_i)$ , and that we may identify  $\mathbb{B}(K_i)$  with a completion of  $\mathcal{V}^{-1}\mathcal{CFK}(Y_i, K_i)$ . From the connected sum formula for knot Floer homology, we know that

$$\mathcal{CFK}(Y_1\#Y_2, K_1\#K_2) \cong \mathcal{CFK}(Y_1, K_1) \otimes_{\mathbb{F}[\mathcal{U}, \mathcal{V}]} \mathcal{CFK}(Y_2, K_2)$$

and similarly the localized module  $\mathcal{V}^{-1}\mathcal{CFK}(Y_1\#Y_2, K_1\#K_2)$  decomposes as a tensor product over the ring  $\mathbb{F}[\mathcal{U}, \mathcal{V}, \mathcal{V}^{-1}]$ .

These tensor products of knot Floer complexes may themselves be described as box tensor products over the algebras  $\mathbb{F}[\mathcal{U}, \mathcal{V}]$  and  $\mathbb{F}[\mathcal{U}, \mathcal{V}, \mathcal{V}^{-1}]$ . Indeed, if  $\mathbf{x}_1, \dots, \mathbf{x}_n$  is a free-basis of  $\mathcal{CFK}(Y_1, K_1)$ , then we may form a type- $D$  module  $\mathcal{CFK}(Y_1, K_1)^{\mathbb{F}[\mathcal{U}, \mathcal{V}]}$ , spanned over  $\mathbb{F}$  by  $\mathbf{x}_1, \dots, \mathbf{x}_n$ , with structure map  $\delta^1$  encoding the differential on  $\mathcal{CFK}(Y_1, K_1)$ . Similarly, we may view  $\mathcal{CFK}(Y_2, K_2)$  as a type- $A$  module  ${}_{\mathbb{F}[\mathcal{U}, \mathcal{V}]} \mathcal{CFK}(Y_2, K_2)$ , freely generated over  $\mathbb{F}[\mathcal{U}, \mathcal{V}]$  by intersection points, and with only  $m_1$  and  $m_2$  non-vanishing. Clearly,

$$\mathcal{CFK}(Y_1, K_1)^{\mathbb{F}[\mathcal{U}, \mathcal{V}]} \boxtimes_{\mathbb{F}[\mathcal{U}, \mathcal{V}]} {}_{\mathbb{F}[\mathcal{U}, \mathcal{V}]} \mathcal{CFK}(Y_2, K_2) \cong \mathcal{CFK}(Y_1, K_1) \otimes_{\mathbb{F}[\mathcal{U}, \mathcal{V}]} \mathcal{CFK}(Y_2, K_2).$$

The maps  $v^{(Y_i, K_i)}$  from the knot surgery formulas of  $K_1$  and  $K_2$  are the canonical inclusion maps for localization at  $\mathcal{V}_i$ . Hence, the map  $v$  on the tensor product is just the tensor product  $v^{(Y_1, K_1)} \otimes v^{(Y_2, K_2)}$ .

On the other hand, the maps  $h_{\lambda_1}^{(Y_1, K_1)}$  and  $h_{\lambda_2}^{(Y_2, K_2)}$  are  $[T]$ -equivariant, in the sense of Lemma 7.7. However it is straightforward to see that this implies that their tensor product  $h_{\lambda_1}^{(Y_1, K_1)} \otimes h_{\lambda_2}^{(Y_2, K_2)}$  is well defined.

In the box tensor product  $\mathcal{X}_{\lambda_1}(K_1)^{\mathcal{K}} \hat{\boxtimes}_{\mathcal{K}} \mathcal{X}_{\lambda_2}(K_2)$ , there is a summand of the differential which corresponds to  $\tau$  being output by  $\mathcal{X}_{\lambda_1}(K_1)^{\mathcal{K}}$ , and then input into  $\mathcal{X}_{\lambda_2}(K_2)$ . This summand is identified with  $h_{\lambda_1}^{(Y_1, K_2)} \otimes h_{\lambda_2}^{(Y_2, K_2)}$ . Similarly, there is a summand of

the differential that corresponds to a  $\sigma$  being output by  $\mathcal{X}_{\lambda_1}(K_1)^{\mathcal{K}}$ , and then input into  $\mathcal{K}\mathcal{X}_{\lambda_2}(K_2)$ . This contributes  $v_1 \otimes v_2$  to the differential.

We summarize the above observations with the following lemma:

**Lemma 12.3.** *If  $K_1 \subseteq Y_1$  and  $K_2 \subseteq Y_2$  are two knots in integer homology 3-spheres, then Theorem 12.1 is equivalent to the statement that the map  $h_{\lambda_1+\lambda_2}^{(Y_1\#Y_2, K_1\#K_2)}$  in Ozsváth and Szabó's surgery formula  $\mathbb{X}_{\lambda_1+\lambda_2}(Y_1\#Y_2, K_1\#K_2)$  satisfies*

$$h_{\lambda_1+\lambda_2}^{(Y_1\#Y_2, K_1\#K_2)} \simeq h_{\lambda_1}^{(Y_1, K_1)} \otimes h_{\lambda_2}^{(Y_2, K_2)}.$$

The pairing theorem for the link surgery formula has a similar restatement. Let  $\mathcal{C}_{\Lambda_1}(L_1)$  and  $\mathcal{C}_{\Lambda_2}(L_2)$  be the link surgery hypercubes of Manolescu and Ozsváth. Write

$$\mathcal{C}_{\Lambda_i}(L_i) \cong \text{Cone} \left( \mathcal{C}_0(L_i) \xrightarrow{F^{-K_i} + F^{K_i}} \mathcal{C}_1(L_i) \right)$$

Here  $\mathcal{C}_\nu(L_i)$  consists of the complexes of all points of the cube  $\mathbb{E}_{\ell_i}$  such that the coordinate for  $K_i$  is  $\nu \in \{0, 1\}$ . Also, we are writing  $F^{K_i}$  (resp.  $F^{-K_i}$ ) for the sum of the hypercube maps for all sublinks  $\vec{N} \subseteq L_i$  which contain  $K_i$  (resp.  $-K_i$ ).

Note that similar to the case of ordinary link Floer complexes, the connected sum formula [OS04a, Section 7] provides an identification of vector spaces

$$\mathcal{C}_0(L_1\#L_2) \cong \mathcal{C}_0(L_1) \hat{\otimes}_{\mathbb{F}[\mathcal{W}, \mathcal{V}]} \mathcal{C}_0(L_2)$$

and

$$\mathcal{C}_1(L_1\#L_2) \cong \mathcal{C}_1(L_1) \hat{\otimes}_{\mathbb{F}[\mathcal{W}, \mathcal{V}, \mathcal{V}^{-1}]} \mathcal{C}_1(L_2).$$

Here,  $\hat{\otimes}$  denotes the completed tensor product.

The maps  $F^{K_i}$  are  $\mathbb{F}[\mathcal{W}, \mathcal{V}]$ -equivariant, while  $F^{-K_i}$  are  $[T]$ -equivariant. In particular, both tensor products  $F^{K_1} \otimes F^{K_2}$  and  $F^{-K_1} \otimes F^{-K_2}$  are well-defined. The same logic as with the case of connected sums of knots gives the following restatement of the pairing theorem for the surgery hypercubes:

**Lemma 12.4.** *Theorem 12.1 is equivalent to the statement that the surgery hypercube  $\mathcal{C}_{\Lambda_1+\Lambda_2}(L_1\#L_2, \mathcal{A}_1\#\mathcal{A}_2)$  is homotopy equivalent to the  $(\ell_1 + \ell_2 - 1)$ -dimensional hypercube*

$$\text{Cone} \left( \mathcal{C}_0(L_1, \mathcal{A}_1) \hat{\otimes} \mathcal{C}_0(L_2, \mathcal{A}_2) \xrightarrow{F^{K_1} \otimes F^{K_2} + F^{-K_1} \otimes F^{-K_2}} \mathcal{C}_1(L_1, \mathcal{A}_1) \hat{\otimes} \mathcal{C}_1(L_2, \mathcal{A}_2) \right)$$

For each  $\nu \in \{0, 1\}$ , the above complexes  $\mathcal{C}_\nu(L_1) \hat{\otimes} \mathcal{C}_\nu(L_2)$  are equipped with the tensor product differential  $D_1^\nu \otimes \text{id} + \text{id} \otimes D_2^\nu$ , where  $D_j^\nu$  is the total differential of the hypercube  $\mathcal{C}_\nu(L_j)$  (i.e. the sum of the internal differentials as well as the hypercube maps).

**12.3. Proof of the pairing theorem.** We are now prove the pairing theorem, Theorem 12.1:

*Proof of Theorem 12.1.* We will use the restatement in terms of mapping cones from Lemma 12.4. Our strategy is to pick a  $\sigma$ -basic system for which we can apply the hypercube tensor product formulas from Section 11.

We consider first the map  $F^{-K_1\#K_2}$  and the corresponding Heegaard diagrams. These maps will in general have summands of length greater than 1, but since we are using a  $\sigma$ -basic system, the only non-trivial summands correspond to sublinks

$\vec{M} \subseteq -L_1 \# L_2$ , all of whose components are oriented oppositely to  $L_1 \# L_2$ . (See the second paragraph of [MO10, Section 8.7]).

We focus on the largest hyperbox in a  $\sigma$ -basic system, i.e. the one for  $\vec{M} = -(L_1 \# L_2)$ , since all of the smaller hypercubes are determined by this one. We suppose that  $\mathcal{H}_1$  and  $\mathcal{H}_2$  are  $\sigma$ -basic systems of Heegaard diagrams for  $L_1$  and  $L_2$ , which use the systems of arcs  $\mathcal{A}_1$  and  $\mathcal{A}_2$ , respectively. We consider the  $\sigma$ -basic system  $\mathcal{H}_\#$  constructed in Section 9.6.

We obtain two important hyperboxes and hypercubes:

- (1) A hyperbox  $CF(\mathcal{H}_\#)$  over

$$R = \mathbb{F}[U_1, \dots, U_{\ell_1-1}, U_{\ell_1}, U_{\ell_1+1}, \dots, U_{\ell_1+\ell_2-1}]$$

where  $U_1, \dots, U_{\ell_1}$  are the variables for  $L_1$ , and  $U_{\ell_1}, \dots, U_{\ell_1+\ell_2-1}$  are the variables for  $L_2$ . Here,  $U_{\ell_1}$  is viewed as the variable for the special component  $K_1 \# K_2$ . This hypercube is generated over  $R$  by intersection points on each constituent Heegaard diagram. If  $\mathbf{d}$  is the size of the hypercube, then at each point  $\varepsilon \in \mathbb{E}(\mathbf{d})$ , the diagrams of  $\mathcal{H}_\#$  are equipped with a complete collection of basepoints  $\mathcal{W}_\varepsilon$ , consisting of exactly one basepoint for each link component. When  $\varepsilon = 0$ , these coincide with the  $\mathbf{z}$ -basepoints. As one increases the coordinates of the cube, the  $\mathbf{z}$ -basepoints are moved into the position of the  $\mathbf{w}$ -basepoints. A holomorphic curve representing a class  $\phi$  is weighted by the product of  $U_i^{n_{w_i, \varepsilon}(\phi)}$ , where  $w_{i, \varepsilon} \in \mathcal{W}_\varepsilon$  is the basepoint corresponding to the link component in index  $i$ .

- (2) A hypercube  $\mathcal{C}(\mathcal{H}_\#)$ , which has the same underlying groups and internal differential as the link surgery hypercube  $\mathcal{C}_{\Lambda_1 + \Lambda_2}(L_1 \# L_2)$ , but has only the differentials for negatively oriented sublinks of  $L_1 \# L_2$ .

Note that we may view the underlying vector space of  $\mathcal{C}(\mathcal{H}_\#)$  as being obtained from the compression of  $CF(\mathcal{H}_\#)$  by tensoring, for each  $i \in \{1, \dots, \ell_1 + \ell_2 - 1\}$ , over  $\mathbb{F}[U_i]$  either  $\mathbb{F}[\mathcal{U}_i, \mathcal{V}_i]$  or  $\mathbb{F}[\mathcal{U}_i, \mathcal{V}_i, \mathcal{V}_i^{-1}]$  (depending on which point of the cube one is in). Here,  $U_i$  acts by  $\mathcal{U}_i \mathcal{V}_i$ . If we tensor the hypercube structure maps on the compression of  $CF(\mathcal{H}_\#)$  with the identity on  $\mathbb{F}[\mathcal{U}_i, \mathcal{V}_i]$ , we do not obtain the correct maps on  $\mathcal{C}(\mathcal{H}_\#)$ . Rather, the correct maps on  $\mathcal{C}(\mathcal{H}_\#)$  are obtained by correcting the terms of the structure maps so that they have the correct Alexander grading. Concretely, if  $\phi_{\varepsilon, \varepsilon'}$  denotes a summand of the differential of the compression of  $CF(\mathcal{H}_\#)$  corresponding to incrementing along a sublink  $\vec{M} \subseteq -L_1 \# L_2$ , and  $\phi_{\varepsilon, \varepsilon'}(\mathbf{x})$  contains a summand of  $a \cdot \mathbf{y}$ , where  $a$  is a product of powers of  $U_1, \dots, U_{\ell_1+\ell_2-1}$ , then the structure map on  $\mathcal{C}(\mathcal{H}_\#)$  has value on  $\mathbf{x}$  which contains a summand of  $a' \cdot \mathbf{y}$ . Here,  $a'$  is obtained from  $a$  by multiplying by powers of  $\mathcal{U}_i^{\pm 1}$  (ranging over  $i$  such that  $\varepsilon'_i = 0$ ) and  $\mathcal{V}_i^{\pm 1}$  (ranging over  $i$  such that  $\varepsilon_i = 1$ ) so that  $A(a' \cdot \mathbf{y}) - A(\mathbf{x}) = \Lambda_{-L_1 \# L_2, \vec{M}} \in \mathbb{H}(L_1 \# L_2)$ .

To illustrate, if  $\mathbf{x}$  and  $\mathbf{y}$  are intersection points on a Heegaard diagram at the point  $\vec{0}$  in the cube and there is a holomorphic disk from  $\mathbf{x}$  to  $\mathbf{y}$  which has  $n_{z_i}(u) = n$ , then the differential from  $CF(\mathcal{H}_\#)$  would have a factor of  $U_i^n$  (as well as variables from other components). On  $\mathcal{C}(\mathcal{H}_\#)$ , it would have a factor of  $U_i^n \mathcal{U}_i^{-(A_i(\mathbf{y}) - A_i(\mathbf{x}))}$  to ensure that the internal differential preserves Alexander grading.

Hence, to show the main claim it suffices to show that the compression of  $CF(\mathcal{H}_\#)$  admits a tensor product decomposition analogous to the claimed one for  $\mathcal{C}(\mathcal{H}_\#)$ , and

also to show that each summand of  $F^{-K_1} \otimes F^{-K_2}$  has Alexander grading consistent with the surgery formula. The claim about Alexander gradings is obvious, so it suffices to consider the hyperbox  $CF(\mathcal{H}_\#)$ .

We now consider in more detail the  $\sigma$ -basic system of Heegaard diagrams  $\mathcal{H}_\#$  constructed in Section 9.6. The hypercubes of attaching curves which appear in this  $\sigma$ -basic system have a simple description in terms of tensor products of hypercubes of attaching curves. See Equation (9.1). Recall that this hyperbox was constructed from  $\sigma$ -basic systems of Heegaard diagrams  $\mathcal{H}_1$  and  $\mathcal{H}_2$  for  $L_1$  and  $L_2$ , respectively. We may assume that these hypercubes are algebraically rigid by Lemma 9.7 (see also Lemma 9.6). Recall that in Section 9.6 we defined

$$\mathcal{H}_\# = \text{St} \left( \mathcal{H}_1 \# \mathcal{H}_2^{(0)}, \mathcal{H}_1^{(1)} \# \mathcal{H}_2 \right).$$

Here,  $\mathcal{H}_1^{(0)}$  (resp.  $\mathcal{H}_1^{(1)}$ ) is the subbox of  $\mathcal{H}_1$  where the coordinate for  $K_1$  is 0 (resp. maximal). We define  $\mathcal{H}_2^{(0)}, \mathcal{H}_2^{(1)}$  similarly. Write  $p_1 \in \Sigma_1$  and  $p_2 \in \Sigma_2$  for the connected sum points. Since  $\mathcal{H}_1$  is alpha-parallel at  $K_1$  (i.e. we use a special beta-curve as a meridian of  $K_1$ ) it is straightforward to see that all of the constituent alpha-hypercubes of  $\mathcal{H}_1$  will be graded by  $p_1$ , in the sense of Definition 11.4. (Note that the beta-hyperboxes in the construction will not generally be graded by  $p_1$ , cf. Remark 11.6). Similarly since  $\mathcal{H}_2$  is beta-parallel at  $K_2$ , all of the constituent beta-hypercubes will be graded by  $p_2$ . See Figure 12.1. Note that furthermore, both the alpha and beta hypercubes of  $\mathcal{H}_i^{(j)}$  will be graded by the connected sum points for  $j \in \{0, 1\}$ .

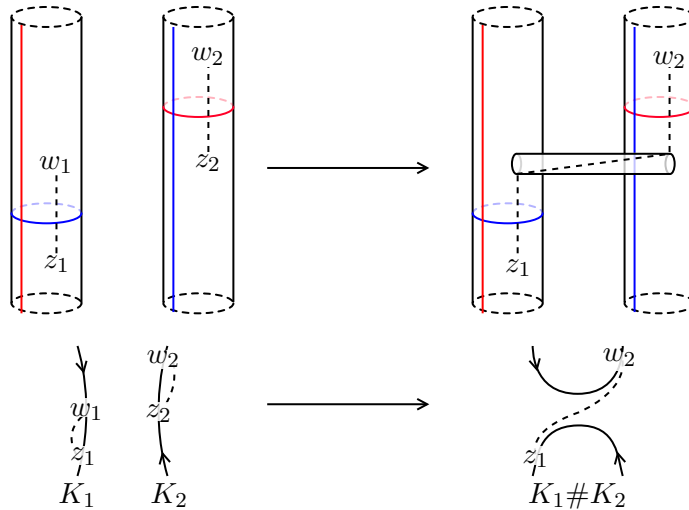

FIGURE 12.1. Forming the connected sum of two  $\sigma$ -basic systems of Heegaard diagrams. The dashed arcs denote the arcs in our  $\sigma$ -basic system. On the left, we begin with an alpha-parallel arc for  $K_1$  and a beta-parallel arc for  $K_2$ . On the right, we have the arc for the connected sum.

By Lemma 2.9, the operations of stacking and pairing hyperboxes of attaching curves commute. Using our results about connected sums of hypercubes in Propositions 10.1



and 11.8, we obtain a homotopy equivalence between  $CF(\mathcal{H}_\#)$  and the hyperbox obtained by stacking

$$CF(\mathcal{H}_1) \otimes_{\mathbb{F}[U_\ell]} CF(\mathcal{H}_2^{(0)}) \quad \text{and} \quad CF(\mathcal{H}_1^{(1)}) \otimes_{\mathbb{F}[U_\ell]} CF(\mathcal{H}_2).$$

To compress, we use the inductive construction described in Section 2.3. In doing so, we may choose to compress the axis corresponding to the special link components  $K_1$  and  $K_2$  last. We obtain that the compression of  $CF(\mathcal{H}_\#)$  is homotopy equivalent to the compression of a hyperbox

$$C_0(L_1) \otimes_{\mathbb{F}[U_\ell]} C_0(L_2) \xrightarrow{f_1 \otimes \text{id}} C_1(L_1) \otimes_{\mathbb{F}[U_\ell]} C_0(L_2) \xrightarrow{\text{id} \otimes f_2} C_1(L_1) \otimes_{\mathbb{F}[U_\ell]} C_1(L_2). \quad (12.1)$$

In the above,  $C_\nu(L_i)$  denotes the compression of  $CF(\mathcal{H}_i^{(\nu)})$ , for  $\nu \in \{0, 1\}$ , and  $f_i$  is the map so that the compression of  $CF(\mathcal{H}_i)$  is isomorphic to  $\text{Cone}(f_i)$ . This is the analog of the formula in the main statement for the compression of  $CF(\mathcal{H}_\#)$ . Upon reweighting  $f_i$  using Alexander gradings, we obtain  $F^{-K_1 \# K_2} = F^{-K_1} \otimes F^{-K_2}$ , as in the statement.

We now consider the map  $F^{K_1 \# K_2}$ . Since we are using a  $\sigma$ -basic system, the maps  $F^{K_1}$ ,  $F^{K_2}$  and  $F^{K_1 \# K_2}$  are all the canonical inclusions of localizing at the  $\mathcal{V}$  variable for  $K_1$ ,  $K_2$  and  $K_1 \# K_2$ . We claim that the homotopy equivalence described above intertwines  $F^{K_1 \# K_2}$  with  $F^{K_1} \otimes F^{K_2}$ . Concretely, this amounts to the claim that the homotopy equivalence, defined above, counts the same curves on  $C_0(L_1) \otimes_{\mathbb{F}[U_\ell]} C_0(L_2)$  as it does on  $C_1(L_1) \otimes_{\mathbb{F}[U_\ell]} C_1(L_2)$ . This is immediate from the definition. The main claim follows.  $\square$

### 13. ARC SYSTEMS AND THE LINK SURGERY FORMULA

For any system of arcs  $\mathcal{A}$  for a link  $L$ , the construction of Manolescu and Ozsváth gives a hypercube of chain complex  $\mathcal{C}_\Lambda(L, \mathcal{A})$ , which is a module over  $\mathbb{F}[[U_1, \dots, U_\ell]]$ . When  $\mathcal{A}$  consists only of beta parallel arcs, their link surgery formula states that

$$H_*(\mathcal{C}_\Lambda(L, \mathcal{A})) \cong \mathbf{HF}^-(Y_\Lambda(L)).$$

When  $\mathcal{A}$  consists only of arcs which are alpha-parallel or beta-parallel, their proof also adapts without substantial change to show the above isomorphism. However, for a general set of arcs, their work does not prove the isomorphism. In this section, we prove the following:

**Theorem 13.1.** *Suppose that  $\mathcal{A}$  and  $\mathcal{A}'$  are two systems of arcs for a framed link  $L \subseteq S^3$ . Suppose that  $\mathcal{A}$  differs from  $\mathcal{A}'$  by changing only the arc for the component  $K_1 \subseteq L$ . There is a homotopy equivalence of hypercubes*

$$\mathcal{C}_\Lambda(L, \mathcal{A}) \simeq \mathcal{C}_\Lambda(L, \mathcal{A}')$$

which is equivariant over  $\mathbb{F}[[U_2, \dots, U_\ell]]$ .

We note that our argument does not imply that the type- $D$  modules  $\mathcal{X}_\Lambda(L, \mathcal{A})^{\mathcal{L}}$  are homotopy equivalent for all choices of  $\mathcal{A}$ . Instead, our proof gives the following statement about the bordered link modules:



**Proposition 13.2.** *Let  $\mathcal{A}$  and  $\mathcal{A}'$  be two systems of arcs for  $L \subseteq S^3$ , and suppose that  $\mathcal{A}$  differs from  $\mathcal{A}'$  by changing only the arc for  $K_1 \subseteq L$ . Then there is a homotopy equivalence of type- $D$  modules over  $\mathcal{L}_{\ell-1}$ :*

$$\mathcal{X}_\Lambda(L, \mathcal{A})^{\mathcal{L}_\ell} \hat{\boxtimes}_{\mathcal{K}_1} \mathcal{D}_0 \simeq \mathcal{X}_\Lambda(L, \mathcal{A}')^{\mathcal{L}_\ell} \hat{\boxtimes}_{\mathcal{K}_1} \mathcal{D}_0.$$

In the above,  $\mathcal{K}_1$  denotes the algebra factor corresponding to the component  $K_1 \subseteq L$ .

**13.1. Basepoint moving maps on hypercubes.** Suppose that  $\mathcal{L}_\alpha$  and  $\mathcal{L}_\beta$  are two hypercubes of handleslide equivalent attaching curves on  $(\Sigma, \mathbf{w}, \mathbf{z})$ . We suppose that  $\gamma \subseteq \Sigma$  is an immersed loop, starting and ending at a free basepoint  $w$ . We now describe an endomorphism  $\gamma_*$  of  $CF(\mathcal{L}_\alpha, \mathcal{L}_\beta)$ .

We begin by picking a diffeomorphism of  $\Sigma$ , which corresponds to an isotopy which moves  $w$  in a loop along  $\gamma$ , and is the identity outside of a small neighborhood of  $\gamma$ .

There is a canonical map

$$\phi_* : CF(\mathcal{L}_\alpha, \mathcal{L}_\beta) \rightarrow CF(\phi\mathcal{L}_\alpha, \phi\mathcal{L}_\beta)$$

obtained by pushing forward an intersection point tautologically under the diffeomorphism  $\phi$ , and extending equivariantly over  $\mathcal{U}_i$  and  $\mathcal{V}_i$ . We now build a hyperbox of handleslide equivalent attaching curves

$$\phi\mathcal{L}_\alpha \longrightarrow \mathcal{L}'_\alpha \longrightarrow \mathcal{L}_\alpha. \quad (13.1)$$

We pick  $\mathcal{L}'_\alpha$  by winding the curves of  $\mathcal{L}_\alpha$  sufficiently so that  $(\phi\mathcal{L}_\alpha, \mathcal{L}'_\alpha)$  and  $(\mathcal{L}'_\alpha, \mathcal{L}_\alpha)$  are both weakly admissible. We use the standard filling procedure of Manolescu and Ozsváth [MO10, Lemma 8.6] to fill in the remaining chains of the above hyperbox.

By pairing the hyperbox in Equation (13.1) with  $\phi_*\mathcal{L}_\beta$  and compressing, we obtain a map

$$\Psi_{\phi\mathcal{L}_\alpha \rightarrow \mathcal{L}_\alpha}^{\phi\mathcal{L}_\beta} : CF(\phi\mathcal{L}_\alpha, \phi\mathcal{L}_\beta) \rightarrow CF(\mathcal{L}_\alpha, \phi\mathcal{L}_\beta).$$

A map  $\Psi_{\mathcal{L}_\alpha}^{\phi\mathcal{L}_\beta \rightarrow \mathcal{L}_\beta} : CF(\mathcal{L}_\alpha, \phi\mathcal{L}_\beta) \rightarrow CF(\mathcal{L}_\alpha, \mathcal{L}_\beta)$  is defined similarly. We define the map  $\gamma_*$  as a composition

$$\gamma_* := \Psi_{\mathcal{L}_\alpha}^{\phi\mathcal{L}_\beta \rightarrow \mathcal{L}_\beta} \circ \Psi_{\phi\mathcal{L}_\alpha \rightarrow \mathcal{L}_\alpha}^{\phi\mathcal{L}_\beta} \circ \phi_*.$$

It is not hard to see that the map  $\gamma_*$  is well defined up to chain homotopies of hypercube morphisms by repeating the same procedure to build hypercubes of higher dimension.

*Remark 13.3.* The above construction may be packaged into a form of naturality for hypercubes. If  $\mathcal{H} = (\mathcal{L}_\alpha, \mathcal{L}_\beta)$  and  $\mathcal{H}' = (\mathcal{L}_{\alpha'}, \mathcal{L}_{\beta'})$  are two hypercubes of handleslide equivalent attaching curves, such that each set of curves in  $\mathcal{L}_\alpha$  is handleslide equivalent to each set of curves in  $\mathcal{L}_{\alpha'}$  and  $\dim(\mathcal{L}_\alpha) = \dim(\mathcal{L}_{\alpha'})$ , and similarly for  $\mathcal{L}_\beta$  and  $\mathcal{L}_{\beta'}$ , then the above construction produces a map  $\Psi_{\mathcal{H} \rightarrow \mathcal{H}'} : CF(\mathcal{H}) \rightarrow CF(\mathcal{H}')$ . Furthermore,

$$\Psi_{\mathcal{H}' \rightarrow \mathcal{H}} \circ \Psi_{\mathcal{H} \rightarrow \mathcal{H}'} \simeq \text{id}_{CF(\mathcal{H})}. \quad (13.2)$$

Equation (13.2) is proven by using associativity to reduce to the case that  $\mathcal{H}'$  consist of small translates of  $\mathcal{L}_\alpha$  and  $\mathcal{L}_\beta$ , and then by either adapting Lipshitz's proof in the case of triangles [Lip06] or by using the small translate theorems for holomorphic polygons in Lemma 10.3.

We now state our formula for the map  $\gamma_*$ . The statement is formally similar to the case of the ordinary Floer complexes [Zem15, Theorem D]. Our formula involves two endomorphisms  $\Phi_w$  and  $\mathcal{A}_\gamma$  which are defined in Sections 13.3 and 13.2.

**Theorem 13.4.** *Suppose that  $\mathcal{L}_\alpha$  and  $\mathcal{L}_\beta$  are hypercubes of handleslide equivalent attaching curves on  $(\Sigma, \mathbf{w}, \mathbf{z})$ . Let  $w \in \mathbf{w}$  be a free basepoint and let  $\gamma$  be a closed path on  $\Sigma$ , which is based at  $w$ . If  $\gamma_*$  is the associated basepoint moving hypercube morphism, then*

$$\gamma_* \simeq \text{id} + \Phi_w \circ \mathcal{A}_\gamma$$

as morphisms of hypercubes.

As a first application, we can compute the effect of changing one arc in a system of arcs for a link  $L \subseteq S^3$ :

**Corollary 13.5.** *Suppose that  $L \subseteq S^3$  is a framed link and that  $\mathcal{A}$  is a system of arcs for  $L$ . Let  $\mathcal{H}$  be a  $\sigma$ -basic system of Heegaard diagrams for  $(L, \mathcal{A})$ . Let  $\gamma$  be an embedded closed loop in  $S^3$  which is based at some  $z_i \in K_i \subseteq L$  but is otherwise disjoint from  $L$  and  $\mathcal{A}$ . Assume  $\gamma$  is contained in the Heegaard surface for  $\Sigma$ . Let  $\mathcal{A}'$  be the system of arcs obtained by concatenating the arc for  $K_i$  with  $\gamma$ . Let us view  $\mathcal{C}_\Lambda(\mathcal{H})$  as*

$$\mathcal{C}_\Lambda(\mathcal{H}) \cong \text{Cone}(\mathcal{C}_0(\mathcal{H}) \xrightarrow{F^{K_i} + F^{-K_i}} \mathcal{C}_1(\mathcal{H})), \quad (13.3)$$

where  $\mathcal{C}_i$  is a  $|L| - 1$  dimensional hypercube and  $F^{-K_i}$  denotes the sum of all hypercube maps for oriented sublinks of  $L$  which contain  $-K_i$ , and similarly for  $F^{K_i}$ . Then there is a  $\sigma$ -basic system of Heegaard diagrams  $\mathcal{H}'$  for  $(L, \mathcal{A}')$  such that

$$\mathcal{C}_\Lambda(\mathcal{H}') \simeq \text{Cone}(\mathcal{C}_0(\mathcal{H}) \xrightarrow{F^{K_i} + (\text{id} + \gamma_i^{-1} \mathcal{A}_\gamma \circ \Phi_{w_i}) F^{-K_i}} \mathcal{C}_1(\mathcal{H})) \quad (13.4)$$

where  $\mathcal{A}_\gamma$  and  $\Phi_{w_i}$  are viewed as endomorphisms of  $\mathcal{C}_1(\mathcal{H})$ .

We now sketch the proof of Theorem 13.1 using Corollary 13.5 and a few other basic results from later in this section:

*Proof of Theorem 13.1.* The map  $\Phi_{w_i}$  will be introduced in more detail in Section 13.3. According to Remark 13.11, below, the map  $\Phi_{w_i}$  is null-homotopic as a hypercube endomorphism via the homotopy

$$\Phi_{w_i} = [\partial, \partial_{\mathcal{U}_i}]$$

where  $\partial_{\mathcal{U}_i}$  is an endomorphism of  $\mathcal{C}_1(\mathcal{H})$  which differentiates a monomial with respect to  $\mathcal{U}_i$ .

The null-homotopy  $\partial_{\mathcal{U}_i}$  of  $\Phi_{w_i}$  gives a chain homotopy equivalence between the hypercubes in Equations (13.3) and (13.4). The map  $\partial_{\mathcal{U}_i}$  does not commute with  $\mathcal{U}_i$  or  $U_i = \mathcal{U}_i \mathcal{V}_i$ , however it will commute with  $\mathcal{U}_j$  and  $\mathcal{V}_j$  for  $j \neq i$ . In particular, the null-homotopy  $\partial_{\mathcal{U}_i}$  cannot be used to induce a morphism between  $\mathcal{X}_\Lambda(L, \mathcal{A})^\mathcal{L}$  and  $\mathcal{X}_\Lambda(L, \mathcal{A}')^\mathcal{L}$ . However, after tensoring with  $\mathcal{D}_0$  the endomorphism  $\text{id} \otimes \partial_{\mathcal{U}_i}$  is defined, so we may package the null-homotopy of  $\Phi_{w_i}$  as a homotopy equivalence of type- $D$  modules

$$\mathcal{X}_\Lambda(L, \mathcal{A})^\mathcal{L} \hat{\boxtimes} \kappa \mathcal{D}_0 \simeq \mathcal{X}_\Lambda(L, \mathcal{A}')^\mathcal{L} \hat{\boxtimes} \kappa \mathcal{D}_0$$

as in the statement of Proposition 13.2.  $\square$

We now describe the proof of Corollary 13.5.

*Proof of Corollary 13.5.* One first builds the surgery hyperbox for sublinks of  $-L$ . We compress the direction for  $K_i$ . The resulting hyperbox takes the form

$$\text{Cone}(\tilde{\mathcal{C}}_0(\mathcal{H}) \xrightarrow{F^{-K_i}} \tilde{\mathcal{C}}_1(\mathcal{H})),$$

where  $\tilde{\mathcal{C}}_j(\mathcal{H})$  compresses to  $\mathcal{C}_j(\mathcal{H})$ . To build the hyperbox for  $\mathcal{H}'$ , we stack the above hyperbox with the basepoint moving map hyperbox for  $\gamma_*$  to form the following hyperbox:

$$(\tilde{\mathcal{C}}_0(\mathcal{H}) \xrightarrow{F^{-K_i}} \mathcal{C}_1(\mathcal{H}) \xrightarrow{\gamma_*} \tilde{\mathcal{C}}_1(\mathcal{H})).$$

If  $\tilde{\mathcal{C}}_1(\mathcal{H})$  has dimension  $n - 1$  and size  $\mathbf{d}$ , the hyperbox for  $\gamma_*$  has dimension  $n$  and size  $\mathbf{d} \times \{1\}$ .

Theorem 13.4 implies that the above hyperbox has homotopy equivalent compression to the compression of

$$(\tilde{\mathcal{C}}_0(\mathcal{H}) \xrightarrow{F^{-K_i}} \tilde{\mathcal{C}}_1(\mathcal{H}) \xrightarrow{\mathcal{V}_i^{-1}\Phi_{w_i}} \tilde{\mathcal{C}}_1(\mathcal{H}) \xrightarrow{\mathcal{A}_\gamma} \tilde{\mathcal{C}}_1(\mathcal{H})).$$

The factor of  $\mathcal{V}_i^{-1}$  in front of  $\Phi_{w_i}$  is to make the map for sublinks of  $L$  which contain  $-K_i$  have the correct Alexander grading, since  $\mathcal{A}_\gamma$  has  $A_i$ -Alexander grading 0 while  $\Phi_{w_i}$  has  $A_i$ -Alexander grading 1. (Note that  $\mathcal{A}_\gamma$  and  $\Phi_{w_i}$  will not necessarily be homogeneous in the other Alexander gradings, since they are hypercube morphisms, and hence may increment the cube directions for other link components). We recall that for these maps, the powers of  $\mathcal{V}_i$  are determined by the overall Alexander grading change of the map. Compressing the above hyperbox gives the statement.  $\square$

*Remark 13.6.* We observe that in the above corollary, there is some ambiguity in the definition of  $\Phi_{w_i}$ . In practice, we would like to compute  $\Phi_{w_i}$  on the link surgery hypercube, as opposed computing  $\Phi_{w_i}$  using a large hyperbox whose compression is the link surgery hypercube. It is an easy consequence of the Leibniz rule that  $\Phi_{w_i}$  commutes with the compression operation, so either choice gives the same answer.

The following remark indicates some subtleties of the hypercube homology actions  $\mathcal{A}_\gamma$  and the basepoint moving map formulas:

*Remark 13.7.* The statement of Corollary 13.5 is false if  $\gamma$  is not disjoint from the curves  $\mathcal{A}$  on the Heegaard diagram. An example is the genus 0 diagram for the Hopf link in Figure 16.1. In this case, composing with the basepoint moving map for moving one  $w_i$  around one of the components will switch between two models of the Hopf link complex (for different arc systems) which we show are non-isomorphic type- $D$  modules in Section 16. On the other hand, any loop on this Heegaard diagram bounds a disk since the surface is  $S^3$ , so Lemma 13.16 can be used to show that the homology action is null-homotopic. In this case, the hypotheses are not satisfied, since the curve  $\gamma = K_2$  is not disjoint from the arc  $\lambda_1$  for  $K_1$ .

**13.2. Basepoint actions on hypercubes.** In this section, we define the basepoint action on hypercubes. Suppose that  $\mathcal{L}_\alpha$  and  $\mathcal{L}_\beta$  are hypercubes of attaching curves

on  $(\Sigma, \mathbf{w}, \mathbf{z})$  and suppose that  $w \in \mathbf{w}$  is a basepoint. In this case, we may define a basepoint action

$$\Phi_w: CF(\mathcal{L}_\alpha, \mathcal{L}_\beta) \rightarrow CF(\mathcal{L}_\alpha, \mathcal{L}_\beta).$$

The basepoint action is a morphism of hypercubes, and is analogous to similar constructions on the ordinary 3-manifold Heegaard Floer groups.

We define the map  $\Phi_w$  to be the formal derivative the hypercube differential  $\partial$ . More precisely, if  $\mathbf{x}$  and  $\mathbf{y}$  are free generators of  $CF(\mathcal{L}_\alpha, \mathcal{L}_\beta)$  and  $\partial(\mathbf{x})$  has a summand of  $\mathbf{a} \cdot \mathbf{y}$  for some polynomial  $\mathbf{a}$ , we define  $\Phi_w(\mathbf{x})$  to have a summand of  $\partial_{\mathcal{U}}(\mathbf{a}) \cdot \mathbf{y}$ .

**Lemma 13.8.** *The map  $\Phi_w$  is a cycle:  $\partial_{\text{Mor}}(\Phi_w) = 0$ .*

*Proof.* This is obtained by taking the equation  $\partial^2 = 0$ , and differentiating with respect to  $\mathcal{U}_w$ . The Leibniz rule yields  $[\Phi_w, \partial] = 0$ .  $\square$

*Remark 13.9.* In the above lemma, we are fundamentally using the fact that the differential commutes with the action of  $\mathcal{U}_w$ . We note that in the link surgery formula  $\mathcal{C}_\Lambda(L)$ , although the group is naturally a completion of a free-module over  $\mathbb{F}[\mathcal{U}_w]$ , the differential does not commute with  $\mathcal{U}_w$  (cf. Lemma 7.7). However, if  $w \in K$  and we restrict to a subcube of  $\mathcal{C}_\Lambda(L)$  where the coordinate for  $K$  is constant, then the differential does commute with  $\mathcal{U}_w$  and the map  $\Phi_w$  can be defined. This is the only case that we consider in the present paper.

When  $\mathcal{L}_\alpha$  and  $\mathcal{L}_\beta$  are algebraically rigid, there is an alternate definition of  $\Phi_w$ , for which we write  $\Phi_w^0$ . The map  $\Phi_w^0$  is defined as follows. Suppose that  $\mathcal{L}_\alpha$  is  $m$ -dimensional and  $\mathcal{L}_\beta$  is  $n$ -dimensional. Given  $\varepsilon_1 < \dots < \varepsilon_j$  in  $\mathbb{E}_m$  and  $\nu_1 < \dots < \nu_k$  in  $\mathbb{E}_n$ , we define a  $n_w$ -weighted polygon counting map  $f_{\alpha_{\varepsilon_j}, \dots, \alpha_{\varepsilon_1}, \beta_{\nu_1}, \dots, \beta_{\nu_k}}^{n_w}$  to count holomorphic polygons of index  $3 - j - i$  with a multiplicative weight of  $n_w(\psi)$ , but the  $\mathcal{U}_{w_s}$  and  $\mathcal{V}_{w_s}$  weights as in the normal holomorphic polygon maps. We define

$$(\phi_w)_{\varepsilon_1 < \dots < \varepsilon_j}^{\nu_1 < \dots < \nu_k}: CF(\boldsymbol{\alpha}_{\varepsilon_1}, \boldsymbol{\beta}_{\nu_1}) \rightarrow CF(\boldsymbol{\alpha}_{\varepsilon_j}, \boldsymbol{\beta}_{\nu_k}) \quad (13.5)$$

via the formula

$$\begin{aligned} & (\phi_w)_{\varepsilon_1 < \dots < \varepsilon_j}^{\nu_1 < \dots < \nu_k}(\mathbf{x}) \\ & := \mathcal{U}_w^{-1} f_{\alpha_{\varepsilon_k}, \dots, \alpha_{\varepsilon_1}, \beta_{\nu_1}, \dots, \beta_{\nu_j}}^{n_w}(\Theta_{\alpha_{\varepsilon_k}, \alpha_{\varepsilon_{k-1}}, \dots, \alpha_{\varepsilon_2}, \alpha_{\varepsilon_1}}, \mathbf{x}, \Theta_{\beta_{\nu_1}, \nu_2}, \dots, \Theta_{\beta_{\nu_{j-1}}, \beta_{\nu_j}}) \end{aligned}$$

We define  $\Phi_w^0: CF(\mathcal{L}_\alpha, \mathcal{L}_\beta) \rightarrow CF(\mathcal{L}_\alpha, \mathcal{L}_\beta)$  via the formula

$$\Phi_w^0 := \sum_{\substack{\nu_1 < \dots < \nu_k \\ \varepsilon_1 < \dots < \varepsilon_j}} (\phi_w)_{\varepsilon_1 < \dots < \varepsilon_j}^{\nu_1 < \dots < \nu_k}. \quad (13.6)$$

**Lemma 13.10.** *If  $\mathcal{L}_\alpha$  and  $\mathcal{L}_\beta$  are algebraically rigid hypercubes of handleslide equivalent attaching curves, then  $\Phi_w = \Phi_w^0$ .*

*Proof.* For algebraically rigid hypercubes of attaching curves, the only special inputs for the hypercube differential are top degree intersection points, which are uniquely determined and have no  $\mathcal{U}_w$ -powers. In particular, the  $\mathcal{U}_w$ -power of an arrow in the differential of  $CF(\mathcal{L}_\alpha, \mathcal{L}_\beta)$  is determined entirely by the multiplicity of the corresponding holomorphic  $\ell$ -gon, which is exactly what the map  $\Phi_w^0$  records.  $\square$

*Remark 13.11.* Similar to the setting of the 3-manifold invariants, the map  $\Phi_w$  is a null-homotopic hypercube endomorphism, though the natural homotopy does not commute with the action of  $\mathcal{U}_w$ . Compare [Zem15, Equation 14.34]. It is easy to verify that

$$\Phi_w = [\partial_{\mathcal{U}_w}, \partial],$$

where  $\partial$  denotes the hypercube differential and  $\partial_{\mathcal{U}_w}$  is the map

$$\partial_{\mathcal{U}_w}(\mathcal{U}_w^i \mathbf{x}) = i\mathcal{U}_w^{i-1} \mathbf{x}$$

extended equivariantly over the actions of the other variables.

**13.3. Homology actions on hypercubes.** We now recall the construction of various homological actions on hypercubes from [HHSZ21, Section 6.2]. We will describe an action for both closed curves on  $\Sigma$  and also arcs which have boundary on two basepoints  $\{w_1, w_2\} \subseteq \mathbf{w}$ .

In the case of closed curves, the construction is an adaptation of the original case [OS04b, Section 4.2.5]. For arcs with boundary, the construction extends [Ni14] and [Zem15, Section 5].

We consider first the case of a closed curve  $\gamma \subseteq \Sigma$ . Suppose that  $\mathcal{L}_\alpha$  and  $\mathcal{L}_\beta$  are hypercubes of attaching curves on  $(\Sigma, \mathbf{w}, \mathbf{z})$ . We now describe an endomorphism

$$\mathcal{A}_\gamma: CF(\mathcal{L}_\alpha, \mathcal{L}_\beta) \rightarrow CF(\mathcal{L}_\alpha, \mathcal{L}_\beta)$$

as follows. Suppose

$$\psi \in \pi_2(\mathbf{x}_{\alpha_{\varepsilon_j}, \alpha_{\varepsilon_{j-1}}}, \dots, \mathbf{x}_{\alpha_{\varepsilon_2}, \alpha_{\varepsilon_1}}, \mathbf{x}, \mathbf{x}_{\beta_{\nu_1}, \beta_{\nu_2}}, \dots, \mathbf{x}_{\beta_{\nu_{k-1}}, \beta_{\nu_k}}, \mathbf{y}) \quad (13.7)$$

where each  $\alpha_{\varepsilon_i}$  and  $\beta_{\varepsilon_i}$  are curves in  $\mathcal{L}_\alpha$  or  $\mathcal{L}_\beta$ , respectively, and each intersection point labeled  $\mathbf{x}_{\gamma, \gamma'}$  is in  $\mathbb{T}_\gamma \cap \mathbb{T}_{\gamma'}$ . We define the 1-chain  $\partial_\alpha(\psi) \subseteq \Sigma$  to be the boundary of  $\psi$  which lies in  $\alpha_{\varepsilon_1} \cup \dots \cup \alpha_{\varepsilon_j}$ . We define a quantity  $a(\psi, \gamma) \in \mathbb{F}$  via the formula

$$a(\psi, \gamma) = \#(\partial_\alpha(\psi) \cap \gamma).$$

We now define an endomorphism

$$\mathcal{A}_\gamma: CF(\mathcal{L}_\alpha, \mathcal{L}_\beta) \rightarrow CF(\mathcal{L}_\alpha, \mathcal{L}_\beta).$$

The map counts holomorphic polygons (as would be counted in the hypercube differential for  $CF(\mathcal{L}_\alpha, \mathcal{L}_\beta)$ ) except with an extra multiplicative weight of  $a(\psi, \gamma)$ .

**Lemma 13.12.** *Suppose that  $\mathcal{L}_\alpha$  and  $\mathcal{L}_\beta$  are hypercubes of attaching curves on  $(\Sigma, \mathbf{w}, \mathbf{z})$  and  $\gamma$  is a closed curve on  $\Sigma$ . Then  $\partial_{\text{Mor}}(\mathcal{A}_\gamma) = 0$ .*

*Proof.* The proof follows from a Gromov compactness argument, similar to the proof of the hypercube relations for  $CF(\mathcal{L}_\alpha, \mathcal{L}_\beta)$ . We observe first that if  $\psi$  is a class of  $\ell$ -gons on a subdiagram of  $(\Sigma, \mathcal{L}_\alpha, \mathcal{L}_\beta)$ , which decomposes as  $\psi = \psi_1 * \psi_2$ , then

$$a(\psi, \gamma) = a(\psi_1, \gamma) + a(\psi_2, \gamma). \quad (13.8)$$

Next, we observe that if  $\psi$  is a class of  $\ell$ -gons on a subdiagram of  $(\Sigma, \mathcal{L}_\alpha)$  or  $(\Sigma, \mathcal{L}_\beta)$ , then

$$a(\psi, \gamma) = 0. \quad (13.9)$$

If  $\psi$  is a class of  $\ell$ -gons on  $(\Sigma, \mathcal{L}_\beta)$  this claim is trivial. If  $\psi$  is instead a class on a subdiagram of  $(\Sigma, \mathcal{L}_\alpha)$ , this follows from the fact that  $\partial_\alpha(\psi) = \partial(D(\psi))$ , so

$$a(\psi, \gamma) = \#\partial_\alpha(\psi) \cap \gamma = \#\partial(D(\psi)) \cap \gamma \equiv \#D(\psi) \cap \partial\gamma = 0,$$

since  $\partial\gamma = \emptyset$ .

To prove  $\partial_{\text{Mor}}(\mathcal{A}_\gamma) = 0$ , one sums over the ends of 1-dimensional families of holomorphic  $\ell$ -gons representing classes as in Equation 13.7, weighted by  $a(\psi, \gamma)$ . If  $\ell > 2$ , then the degenerations consist of pairs consisting of a holomorphic  $j$ -gon and a holomorphic  $k$ -gon with  $j + k = \ell + 2$  and  $j, k \geq 2$ . Using the hypercube relations for  $\mathcal{L}_\alpha$  and  $\mathcal{L}_\beta$ , as well as Equations (13.8) and (13.9), we may view the sum over these such ends as corresponding to the composition  $\partial_{\text{Mor}}(\mathcal{A}_\gamma)$ . The remaining type of ends occur when  $\ell = 2$  and correspond to an index 2 class of disks breaking into a constant disk and a boundary degeneration. In this case, we observe that  $a(\phi, \gamma) = 0$  for any boundary degenerations, so these ends make trivial contribution to the sum. We conclude  $\partial_{\text{Mor}}(\mathcal{A}_\gamma) = 0$ .  $\square$

We now consider the case of defining an action  $\mathcal{A}_\lambda$  for arcs  $\lambda$  on  $\Sigma$  which have boundary on two basepoints  $w_1, w_2 \in \mathbf{w}$ . We focus on the case that  $w_1, w_2$  are free basepoints, to simplify the exposition.

We write  $\mathcal{A}_\lambda^0$  for the endomorphism constructed by using the same formula as above in the case of closed curves. The proof of Lemma 13.12 no longer holds. The first, less serious, issue is that if  $\psi$  is an index 2 boundary degeneration which covers one of  $w_1$  and  $w_2$ , then  $a(\psi, \lambda) \neq 0$ . More seriously, if  $\psi$  is a class of  $\ell$ -gons on a subdiagram of  $(\Sigma, \mathcal{L}_\alpha, \mathbf{w}, \mathbf{z})$ , then  $a(\psi, \lambda)$  may be non-zero. In contrast to Equation (13.9), we have

$$a(\psi, \lambda) = n_{w_1}(\psi) - n_{w_2}(\psi),$$

which may be non-zero.

If one restricts to the case that  $\mathcal{L}_\alpha$  is algebraically rigid, then it is straightforward to show that any class  $\psi$  on  $\mathcal{L}_\alpha$  appearing in a degeneration has  $n_{w_1}(\psi) = n_{w_2}(\psi) = 0$  by grading considerations, and hence

$$\partial_{\text{Mor}}(\mathcal{A}_\lambda^0) = (\mathcal{U}_{w_1} + \mathcal{U}_{w_2}) \cdot \text{id}.$$

(The right hand side is contributed by boundary degenerations). Our strategy for defining  $\mathcal{A}_\lambda$  in general is to construct a generalized hypercube of attaching curves

$$\mathcal{L}_\alpha^\lambda = \text{Cone}(\lambda: \mathcal{L}_\alpha \rightarrow \mathcal{L}_\alpha)$$

of dimension  $\dim(\mathcal{L}_\alpha) + 1$ . The length 1 inputs of  $\mathcal{L}_\alpha^\lambda$  which are in the  $\lambda$ -direction will be arrows which are labeled  $\lambda$ . The higher length chains in the  $\lambda$ -direction will be ordinary Floer chains.

We will describe how to formally pair  $\mathcal{L}_\alpha^\lambda$  with  $\mathcal{L}_\beta$  to obtain a diagram which we define to be

$$\text{Cone}(\mathcal{A}_\lambda: CF(\mathcal{L}_\alpha, \mathcal{L}_\beta) \rightarrow CF(\mathcal{L}_\alpha, \mathcal{L}_\beta)).$$

Before describing the construction of  $\mathcal{L}_\alpha^\lambda$  we describe how to interpret the associativity relations for  $\mathcal{L}_\alpha^\lambda$ . We generalize the holomorphic polygon maps to formally allow  $\lambda$  as an input, as follows. If  $\gamma_1, \dots, \gamma_n$  are attaching curves on  $\Sigma$ , and  $\Theta_{i,i+1} \in \mathbb{T}_{\gamma_i} \cap \mathbb{T}_{\gamma_{i+1}}$ , we define

$$f_{\gamma_1, \dots, \gamma_k, \gamma_k, \dots, \gamma_n}(\Theta_{1,2}, \dots, \Theta_{k-1,k}, \lambda, \Theta_{k,k+1}, \dots, \Theta_{n-1,n})$$

to be the map which counts ordinary holomorphic polygons with inputs  $\Theta_{1,2}, \dots, \Theta_{n-1,n}$ , but with a weight of  $\#(\partial_{\gamma_k}(\psi) \cap \lambda)$ . These holomorphic polygon counting maps satisfy the usual associativity rules with the following convention. We formally define

$\partial\lambda = \mathcal{U}_{w_1} + \mathcal{U}_{w_2}$  and we think of these generalized holomorphic polygon counting maps as being strictly unital and  $\mathcal{U}_w$  and  $\mathcal{V}_z$ -equivariant. In particular,

$$f_{\gamma_1, \dots, \gamma_k, \gamma_k, \dots, \gamma_n}(\Theta_{1,2}, \dots, \partial\lambda, \dots, \Theta_{n-1,n}) = 0$$

unless  $n = 2$ , in which case

$$f_{\gamma_1, \gamma_1, \gamma_2}(\partial\lambda, \mathbf{x}) = \mathbf{x} \cdot (\mathcal{U}_{w_1} + \mathcal{U}_{w_2}).$$

and similarly for  $f_{\gamma_1, \gamma_2, \gamma_2}$ .

The construction of  $\mathcal{L}_\alpha^\lambda$  is as follows. We start with two copies of  $\mathcal{L}_\alpha$ , which we view as opposite faces of  $\mathcal{L}_\alpha^\lambda$ . We add formal length 1 morphisms labeled  $\lambda$ . In the following lemma, we prove that this is always possible to construct the higher length chains when  $\mathcal{L}_\alpha$  is a hypercube of handleslide equivalent curves:

**Lemma 13.13.** *Suppose that  $\mathcal{L}_\alpha$  and  $\mathcal{L}_\beta$  are hypercubes of handleslide equivalent attaching curves on  $(\Sigma, \mathbf{w}, \mathbf{z})$ . Higher length chains may always be added to  $\mathcal{L}_\alpha^\lambda$  so that it satisfies all but the length 1 hypercube relations. Furthermore:*

- (1) *If  $w_1$  and  $w_2$  are free-basepoints, then  $\partial_{\text{Mor}}(\mathcal{A}_\lambda) = (\mathcal{U}_{w_1} + \mathcal{U}_{w_2}) \cdot \text{id}$ .*
- (2) *More generally*

$$\partial_{\text{Mor}}(\mathcal{A}_\lambda) = E_{w_1}^\alpha + E_{w_2}^\alpha,$$

where  $E_{w_i}^\alpha$  denotes the product of all variables for basepoints in the component of  $\Sigma \setminus \alpha$  which contains  $w_i$  (note that this is independent of  $\alpha \in \mathcal{L}_\alpha$ , since  $\mathcal{L}_\alpha$  consists of handleslide equivalent attaching curves).

*Remark 13.14.* As an example, if  $(\Sigma, \alpha, \beta, \mathbf{w}, \mathbf{z})$  represents a link  $L \subseteq Y$  for some  $\alpha \in \mathcal{L}_\alpha$  and  $\beta \in \mathcal{L}_\beta$ , and  $w_1$  and  $w_2$  are two link basepoints on components  $K_1$  and  $K_2$ , and  $z_1$  and  $z_2$  are the only other basepoints on  $K_1$  and  $K_2$ , respectively, then

$$\partial_{\text{Mor}}(\mathcal{A}_\lambda) = (\mathcal{U}_{w_1} \mathcal{V}_{z_1} + \mathcal{U}_{w_2} \mathcal{V}_{z_2}) \cdot \text{id}.$$

*Proof.* The proof is described in [HHSZ21, Section 6.2] when we set  $\mathcal{U}_{w_1} = \mathcal{U}_{w_2}$ , though we review it in detail since we need to prove additional properties of the maps  $\mathcal{A}_\lambda$ .

We begin by considering the length 2 arrows which increment the  $\lambda$  direction. If  $\alpha_1$  is an immediate successor of  $\alpha_0$  in  $\mathcal{L}_\alpha$ , then we wish to construct a chain  $\eta_{\alpha_1, \alpha_0}$  so that the diagram below is a hypercube (except for the length 1 relations along  $\lambda$ ):

$$\begin{array}{ccc} \alpha_0 & \xrightarrow{\lambda} & \alpha_0 \\ \downarrow \Theta_{\alpha_1, \alpha_0} & \dashrightarrow \eta_{\alpha_1, \alpha_0} & \downarrow \Theta_{\alpha_1, \alpha_0} \\ \alpha_1 & \xrightarrow{\lambda} & \alpha_1 \end{array}$$

Concretely, this amounts to finding  $\eta_{\alpha_1, \alpha_0} \in CF(\Sigma, \alpha_1, \alpha_0)$  such that

$$\partial\eta_{\alpha_1, \alpha_0} = A_\lambda^{\alpha_0}(\Theta_{\alpha_1, \alpha_0}) + A_\lambda^{\alpha_1}(\Theta_{\alpha_1, \alpha_0}).$$

Above, the map  $A_\lambda^{\alpha_0}$  weights curves by  $\#(\partial_{\alpha_0}(\phi) \cap \lambda)$  while  $A_\lambda^{\alpha_1}$  weights curves by  $\#(\partial_{\alpha_1}(\phi) \cap \lambda)$ .

We recall that for the ordinary Floer complexes,

$$A_\lambda^{\alpha_0}(\Theta_{\alpha_1, \alpha_0}) + A_\lambda^{\alpha_1}(\Theta_{\alpha_1, \alpha_0}) = \mathcal{U}_{w_1} \Phi_{w_1}(\Theta_{\alpha_1, \alpha_0}) + \mathcal{U}_{w_2} \Phi_{w_2}(\Theta_{\alpha_1, \alpha_0}).$$

See [Zem15, Lemma 5.7]. However  $\Phi_{w_1}(\Theta_{\alpha_1, \alpha_0})$  and  $\Phi_{w_2}(\Theta_{\alpha_1, \alpha_0})$  are cycles of Maslov  $(\text{gr}_w, \text{gr}_z)$ -bigrading  $(1, 1)$  larger than the canonical generator of  $HF^-(\Sigma, \alpha_1, \alpha_0)$ , and hence are each boundaries. We note that  $\eta_{\alpha_1, \alpha_0}$  may be chosen to be in the submodule of  $CF(\Sigma, \alpha_1, \alpha_0)$  generated by the ideal  $(\mathcal{U}_{w_1}, \mathcal{U}_{w_2})$ .

We now define the length 3 morphisms of  $\mathcal{L}_\alpha^\lambda$  which increase the  $\lambda$ -direction. Suppose that  $\alpha_{00}$  and  $\alpha_{11}$  differ by two coordinates of  $\mathcal{L}_\alpha$ . We consider the 3-dimensional cube spanned by  $\alpha_{00}, \alpha_{10}, \alpha_{01}, \alpha_{11}$ , extended into the  $\lambda$  direction. All length 2 hypercube relations are satisfied. We sum the terms which would appear in the length 3 relation of this hypercube except for contribution of the length 3 arrow. Write

$$C_{\alpha_{11}, \alpha_{00}} \in CF(\alpha_{11}, \alpha_{00})$$

for this element. We observe three facts:

- (1)  $C_{\alpha_{11}, \alpha_{00}}$  is a cycle.
- (2)  $C_{\alpha_{11}, \alpha_{00}}$  has Maslov bigrading equal to that of the canonical top degree generator of  $HF^-(\alpha_{11}, \alpha_{00})$ .
- (3)  $C_{\alpha_{11}, \alpha_{00}}$  is in the submodule generated by the ideal  $(\mathcal{U}_{w_1}, \mathcal{U}_{w_2})$ .

The first two equations are easily verified. To see the third, we observe that the length 3 relation is obtained by summing over all ways of taking a consecutive sequence of morphisms in the cube, and then inserting  $\lambda$  between 2 terms or at the start or beginning and then applying the holomorphic polygon maps interpreted as above. As an example, the expression  $C_{\alpha_{11}, \alpha_{00}}$  contains the term

$$\begin{aligned} & f_{\alpha_{00}, \alpha_{00}, \alpha_{01}, \alpha_{11}}(\lambda, \Theta_{\alpha_{00}, \alpha_{01}}, \Theta_{\alpha_{01}, \alpha_{11}}) \\ & + f_{\alpha_{00}, \alpha_{01}, \alpha_{01}, \alpha_{11}}(\Theta_{\alpha_{00}, \alpha_{01}}, \lambda, \Theta_{\alpha_{01}, \alpha_{11}}) \\ & + f_{\alpha_{00}, \alpha_{01}, \alpha_{11}, \alpha_{11}}(\Theta_{\alpha_{00}, \alpha_{01}}, \Theta_{\alpha_{01}, \alpha_{11}}, \lambda). \end{aligned}$$

The above expression may be collapsed into a count of holomorphic triangles which are weighted by  $(n_{w_1}(\psi) + n_{w_2}(\psi))$ . In particular, the output lies in the submodule generated by  $\mathcal{U}_{w_1}$  and  $\mathcal{U}_{w_2}$ . The same reasoning holds for the other terms in  $C_{\alpha_{11}, \alpha_{00}}$ .

Since  $\alpha_{11}$  and  $\alpha_{00}$  are handleslide equivalent, the canonical generator of  $HF^-(\alpha_{11}, \alpha_{00})$  has both the maximal  $\text{gr}_w$  and maximal  $\text{gr}_z$ -grading of any non-zero element, and furthermore, the canonical element is the unique non-zero element of homology in this grading. Furthermore, it is straightforward to verify (e.g. by a model computation on a simple diagram) that the quotient map

$$\pi: HF^-(\alpha_{11}, \alpha_{00}) \rightarrow H_*(CF(\alpha_{11}, \alpha_{00})/(\mathcal{U}_{w_1}, \mathcal{U}_{w_2})) \quad (13.10)$$

is non-vanishing on the canonical generator of top degree. This map  $\pi$  clearly vanishes on  $C_{\alpha_{11}, \alpha_{00}}$ , and hence  $C_{\alpha_{11}, \alpha_{00}}$  is a boundary in  $CF(\alpha_{11}, \alpha_{00})$ . We pick any homogeneously graded chain  $\omega_{\alpha_{11}, \alpha_{00}}$  such that  $\partial\omega_{\alpha_{11}, \alpha_{00}} = C_{\alpha_{11}, \alpha_{00}}$  to be the length 3 map in our cube.

Filling in the higher dimensional cubes proceeds in a similar, though slightly simpler manner. In this case, when we want to fill over an  $n$ -dimensional subcube for  $n > 3$ , all of whose morphisms except for the longest morphism are defined, the corresponding element  $C$  is a cycle of bidegree  $(n-3, n-3)$  greater than the canonical generator, and hence will automatically be a cycle.  $\square$

The following is a technical result which is useful when we prove properties about  $\mathcal{A}_\lambda$  (cf. [HHSZ21, Lemma 6.2]).



**Lemma 13.15.** *All of the higher length morphisms of  $\mathcal{L}_\alpha^\lambda$  may be chosen to be in the submodule spanned by  $(\mathcal{U}_{w_1}, \mathcal{U}_{w_2})$ .*

*Proof.* In the proof of Lemma 13.13 we observed that the length 2 morphisms of  $\mathcal{L}_\alpha^\lambda$  could be chosen to be in submodule generated by the ideal  $(\mathcal{U}_{w_1}, \mathcal{U}_{w_2})$ . Consider the length 3 arrows of  $\mathcal{L}_\alpha^\lambda$  (the argument for higher length chains is essentially the same). Following the proof of Lemma 13.13, let  $C_{\alpha_{11}, \alpha_{00}}$  be the sum of the terms in the length 3 relation, excluding the term  $\partial\omega_{\alpha_{11}, \alpha_{00}}$ , which has yet to be defined. Since  $C_{\alpha_{11}, \alpha_{00}}$  is in the submodule generated by  $(\mathcal{U}_{w_1}, \mathcal{U}_{w_2})$ , write

$$C_{\alpha_{11}, \alpha_{00}} = \mathcal{U}_{w_1} C_1 + \mathcal{U}_{w_2} C_2.$$

We observed that  $C_{\alpha_{11}, \alpha_{00}}$  was a boundary, and we picked some  $\omega_{\alpha_{11}, \alpha_{00}}$  in bigrading  $(1, 1)$  higher than the canonical generator such that  $\partial\omega_{\alpha_{11}, \alpha_{00}} = C_{\alpha_{11}, \alpha_{00}}$ . Write  $\omega_{\alpha_{11}, \alpha_{00}} = \mathcal{U}_{w_1}\omega_1 + \mathcal{U}_{w_2}\omega_2 + \omega_0$ , where  $\omega_0$  has no powers of  $\mathcal{U}_{w_1}$  or  $\mathcal{U}_{w_2}$ . Note that the image of  $\omega_0$  under the map  $\pi$  in  $H_*(CF(\alpha_{11}, \alpha_{00})/(\mathcal{U}_{w_1}, \mathcal{U}_{w_2}))$  is a cycle and of bigrading  $(1, 1)$  higher than the top degree. Hence  $\pi(\omega_0)$  is a boundary modulo  $(\mathcal{U}_{w_1}, \mathcal{U}_{w_2})$ . This implies there is some  $\mathbf{x} \in CF(\alpha_{11}, \alpha_{00})$  of homogeneous bigrading  $(1, 1)$  higher than  $\omega_0$ , so that

$$\partial\mathbf{x} = \omega_0 + \mathcal{U}_{w_1}\mathbf{y}_1 + \mathcal{U}_{w_2}\mathbf{y}_2,$$

for some  $\mathbf{y}_1, \mathbf{y}_2$ . Note that

$$\partial(\omega_{\alpha_{11}, \alpha_{00}} + \partial\mathbf{x}) = C_{\alpha_{11}, \alpha_{00}}$$

and  $\omega_{\alpha_{11}, \alpha_{00}} + \partial\mathbf{x}$  is in the submodule spanned by  $(\mathcal{U}_{w_1}, \mathcal{U}_{w_2})$ , so we use  $\omega_{\alpha_{11}, \alpha_{00}} + \partial\mathbf{x}$  in place of  $\omega_{\alpha_{11}, \alpha_{00}}$ . The proof for chains of length  $n > 3$  follows from essentially the same logic.  $\square$

Another important property of the homology action is the following:

**Lemma 13.16.** *Suppose that  $\mathcal{L}_\alpha$  and  $\mathcal{L}_\beta$  are hypercubes of attaching curves on  $(\Sigma, \mathbf{w}, \mathbf{z})$  and that  $\gamma$  is a closed 1-chain on  $\Sigma$ . Suppose that  $C \subseteq \Sigma$  is an integral 2-chain such that  $\partial C = \gamma + S_\alpha + S_\beta$  where  $S_\alpha$  are closed 1-chains which are disjoint from all curves in  $\mathcal{L}_\alpha$  and  $S_\beta$  are closed 1-chains which are disjoint from all curves in  $\mathcal{L}_\beta$ . Then*

$$\mathcal{A}_\gamma \simeq 0$$

*as morphisms of hypercubes.*

*Proof.* We construct the following diagram to realize the chain homotopy:

$$\begin{array}{ccc} CF(\mathcal{L}_\alpha, \mathcal{L}_\beta) & \xrightarrow{\mathcal{A}_\gamma} & CF(\mathcal{L}_\alpha, \mathcal{L}_\beta) \\ \downarrow \text{id} & \dashrightarrow^{H_C} & \downarrow \text{id} \\ CF(\mathcal{L}_\alpha, \mathcal{L}_\beta) & \xrightarrow{0} & CF(\mathcal{L}_\alpha, \mathcal{L}_\beta) \end{array}$$

We define the map  $H_C$  to have only length 2 chains in the above diagram (i.e. to increment the  $\gamma$  and  $\text{id}$  directions, but no other directions), and to send  $\mathbf{x} \in CF(\alpha_\varepsilon, \beta_\nu)$  to  $n_{\mathbf{x}}(C) \cdot \mathbf{x} \in CF(\alpha_\varepsilon, \beta_\nu)$ , and to be equivariant in actions of the variables.

We claim that the hypercube relations are satisfied. To see this, it is sufficient to show that if

$$\varepsilon_1 < \cdots < \varepsilon_n \quad \text{and} \quad \nu_1 < \cdots < \nu_m$$

are increasing sequences in the cubes for  $\mathcal{L}_\alpha$  and  $\mathcal{L}_\beta$ , respectively, then

$$H_C \circ D_{\varepsilon_1 < \dots < \varepsilon_n}^{\nu_1 < \dots < \nu_m} + D_{\varepsilon_1 < \dots < \varepsilon_n}^{\nu_1 < \dots < \nu_m} \circ H_C = (\mathcal{A}_\gamma)_{\varepsilon_1 < \dots < \varepsilon_n}^{\nu_1 < \dots < \nu_m} \quad (13.11)$$

In the above,  $D_{\varepsilon_1 < \dots < \varepsilon_n}^{\nu_1 < \dots < \nu_m}$  denotes the summands of the hypercube differential of  $CF(\mathcal{L}_\alpha, \mathcal{L}_\beta)$  which counts curves on  $(\Sigma, \boldsymbol{\alpha}_{\varepsilon_n}, \dots, \boldsymbol{\alpha}_{\varepsilon_1}, \boldsymbol{\beta}_{\nu_1}, \dots, \boldsymbol{\beta}_{\nu_m})$ . To prove Equation (13.11), we observe that if

$$\psi \in \pi_2(\Theta_{\nu_n, \nu_{n-1}}, \dots, \Theta_{\nu_2, \nu_1}, \mathbf{x}, \Theta_{\varepsilon_1, \varepsilon_2}, \dots, \Theta_{\varepsilon_{m-1}, \varepsilon_m}, \mathbf{y})$$

is a class of  $n + m$ -gons, then

$$\partial(\partial_\alpha(\psi) \cap C) \equiv (n_{\mathbf{x}}(C) + n_{\mathbf{y}}(C)) + \partial_\alpha(\psi) \cap (\gamma + S_\alpha + S_\beta).$$

We first note that  $\partial_\alpha(\psi) \cap S_\alpha = \partial_\beta(\psi) \cap S_\beta = \emptyset$ . Furthermore  $\partial_\alpha(\psi)$  and  $\partial_\beta(\psi)$  are homologous via the 2-chain  $D(\psi)$ , so we also have  $\#\partial_\alpha(\psi) \cap S_\beta \equiv 0$ . Hence

$$n_{\mathbf{x}}(C) + n_{\mathbf{y}}(C) \equiv \#\partial_\alpha(\psi) \cap \gamma \pmod{2}.$$

This implies Equation (13.11), completing the proof.  $\square$

**13.4. Free stabilization.** In [Zem15, Section 6], the author describes maps for adding and removing basepoints to the Heegaard Floer complexes. These are referred to as *free-stabilization* maps. One can also define a free stabilization map on the level of hypercubes. These are described in [HHSZ21, Section 7.1], and we recall the construction presently.

Suppose that  $\mathcal{L}_\alpha$  and  $\mathcal{L}_\beta$  are hypercubes of attaching curves on a surface  $(\Sigma, \mathbf{w}, \mathbf{z})$ , and that  $w$  is a point on  $\Sigma \setminus (\mathbf{w} \cup \mathbf{z})$ , which is not contained in any curves of  $\mathcal{L}_\alpha$  or  $\mathcal{L}_\beta$ . We define stabilized hypercubes  $\mathcal{L}_\alpha^+$  and  $\mathcal{L}_\beta^+$ . We construct the attaching curves of  $\mathcal{L}_\alpha^+$  and  $\mathcal{L}_\beta^+$  by adding a small curve by adjoining small circles around  $w$  (translated suitably to achieve admissibility). If  $\varepsilon < \varepsilon'$  are points in the cube for  $\mathcal{L}_\alpha$ , and  $\Theta_{\alpha_{\varepsilon'}, \alpha_\varepsilon}$  is the corresponding chain of  $\mathcal{L}_\alpha$ , then we define corresponding chain in  $\mathcal{L}_\alpha^+$  to be  $\Theta_{\alpha_{\varepsilon'}, \alpha_\varepsilon} \otimes \theta^+$ , where  $\theta^+$  is the top graded generator of the new attaching curves centered at  $w$ . We make a similar definition for the chains of  $\mathcal{L}_\beta^+$ .

We define a map

$$\mathcal{S}_w^+ : CF(\mathcal{L}_\alpha, \mathcal{L}_\beta) \rightarrow CF(\mathcal{L}_\alpha^+, \mathcal{L}_\beta^+)$$

via the formula  $\mathbf{x} \mapsto \mathbf{x} \otimes \theta^+$ , extended equivariantly over the variables  $\mathcal{U}_{w_i}$  and  $\mathcal{V}_{z_i}$ .

There is also a map  $\mathcal{S}_w^-$  in the opposite direction, defined dually by the formula  $\mathbf{x} \otimes \theta^+ \mapsto 0$  and  $\mathbf{x} \otimes \theta^- \mapsto \mathbf{x}$ , extended equivariantly over the variables  $\mathcal{U}_w$  and  $\mathcal{V}_z$ .

**Lemma 13.17.** *The maps  $\mathcal{S}_w^+$  and  $\mathcal{S}_w^-$  are chain maps.*

The proof follows from a standard index computation and gluing argument. See [HHSZ21, Proposition 5.5] for a proof in the general case, and [Zem15, Propositions 6.5 and Theorem 6.7] for the case of holomorphic disks and triangles.

The fact that  $\mathcal{S}_w^+$  and  $\mathcal{S}_w^-$  are chain maps of hypercubes may be interpreted as implying a form of naturality, as in Remark 13.3. Suppose  $\mathcal{H} = (\Sigma, \mathcal{L}_\alpha, \mathcal{L}_\beta)$  and  $\mathcal{H}' = (\Sigma, \mathcal{L}_{\alpha'}, \mathcal{L}_{\beta'})$  are hypercubes of attaching curves such that the curves of  $\mathcal{L}_\alpha$  and  $\mathcal{L}_{\alpha'}$  are pairwise handleslide equivalent, and similarly for  $\mathcal{L}_\beta$  and  $\mathcal{L}_{\beta'}$ . Write  $\mathcal{H}_w^+$

and  $\mathcal{H}'_w$  for their stabilizations. Using the notation of Remark 13.3, we see that Lemma 13.17 implies the (strict) commutation of the diagram

$$\begin{array}{ccc} CF(\mathcal{H}) & \xrightarrow{\Psi_{\mathcal{H} \rightarrow \mathcal{H}'}} & CF(\mathcal{H}') \\ \downarrow \mathcal{S}_w^+ & & \downarrow \mathcal{S}_w^+ \\ CF(\mathcal{H}_w^+) & \xrightarrow{\Psi_{\mathcal{H}_w^+ \rightarrow \mathcal{H}'_w^+}} & CF(\mathcal{H}'_w^+) \end{array}$$

Similar to the setting of the graph TQFT, we have the following relation between the free-stabilization maps and the basepoint actions from Section 13.2.

**Lemma 13.18.** *For appropriately degenerated almost complex structures, we have  $\mathcal{S}_w^+ \mathcal{S}_w^- = \Phi_w$ .*

*Proof.* The argument is essentially the same as [HHSZ21, Proposition 5.5], though we repeat the argument here for concreteness. We consider a class of  $\ell$ -gons

$$\psi \# \psi' \in \pi_2(\Theta_{\alpha_n, \alpha_{n-1}} \times \theta^+, \dots, \Theta_{\alpha_2, \alpha_1} \times \theta^+, \mathbf{x} \times \theta, \Theta_{\beta_1, \beta_2} \times \theta^+, \dots, \Theta_{\beta_{m-1}, \beta_m} \times \theta^+, \mathbf{y} \times \theta')$$

which potentially contributes to the differential on the hypercube  $CF(\mathcal{L}_\alpha, \mathcal{L}_\beta)$ . Here,  $\theta, \theta' \in \{\theta^+, \theta^-\}$ . Here,  $\psi'$  has is a class in the stabilization region, and  $\psi$  is a class on the unstabilized diagram. Also,  $\ell = n + m$ . By a standard computation

$$\mu(\psi \# \psi') = \mu(\psi) + 2n_w(\psi'). \quad (13.12)$$

The hypercube differential counts solutions with  $\mu(\psi \# \psi') = 3 - \ell$ . On the other hand, for sufficiently stretched almost complex structure, we know that  $\mu(\psi) \geq 3 - \ell$  if  $\ell \geq 3$ , by transversality. From Equation (13.12), we conclude that  $\mu(\psi \# \psi') = \mu(\psi) = 3 - \ell$  and  $n_w(\psi') = 0$  if  $\ell \geq 3$  and  $\psi \# \psi'$  contributes to the hypercube differential. In particular, if  $\ell \geq 3$ , no curves contribute to the map  $\Phi_w$ . If  $\ell = 2$ , then the hypercube differential counts solutions with  $\mu(\psi \# \psi') = 1$ , and transversality only implies that  $\mu(\psi) \geq 0$ . Clearly if a curve contributes to  $\Phi_w$ , we must have  $\mu(\psi) = 0$  and  $n_w(\psi') = 1$ . Such a curve has domain equal to the small bigon which covers  $w$  in the stabilization region. The main claim follows easily.  $\square$

The same neck-stretching argument as in Lemma 13.17 can be used to prove the following (cf. [Zem15, Corollary 6.6]):

**Lemma 13.19.** *Suppose that  $\lambda$  is an arc or path which is disjoint from  $w$ . For an appropriately degenerated almost complex structure, we have*

$$[\mathcal{A}_\lambda, \mathcal{S}_w^\pm] = 0.$$

We leave the proof of the above result to the reader, as it is very similar to Lemmas 13.17 and 13.18.

Similarly, we have the following analog of [Zem15, Proposition 6.14], whose proof we also leave to the reader:

**Lemma 13.20.** *If  $w$  and  $w'$  are distinct free basepoints, then  $[\mathcal{S}_w^{\pm 1}, \mathcal{S}_{w'}^{\pm 2}] \simeq 0$ .*

**13.5. Algebraic relations and the diffeomorphism action.** In this section, we prove some important algebraic relations involving the maps  $\mathcal{A}_\lambda$  and  $\mathcal{S}_w^\pm$ . The relations we prove are analogs of the relations from the graph TQFT [Zem15].

In the following lemma, we collect several first relations about the maps  $\mathcal{A}_\lambda$  and  $\mathcal{S}_w^\pm$ :

**Lemma 13.21.** *Suppose that  $\mathcal{L}_\alpha$  and  $\mathcal{L}_\beta$  are hypercubes of handleslide equivalent attaching curves on  $(\Sigma, \mathbf{w}, \mathbf{z})$ .*

- (1) *Suppose that  $w, w'$  are distinct free basepoints, and that  $\lambda$  is an arc on  $(\Sigma, \mathbf{w}, \mathbf{z})$  such that  $\partial\lambda = \{w, w'\}$ . Then*

$$[\mathcal{A}_\lambda, \Phi_w] \simeq \text{id}.$$

- (2) *If  $w \in \mathbf{w}$ , then  $\Phi_w^2 \simeq 0$ .*

- (3) *Suppose that  $w' \in \mathbf{w}$  is a free basepoint, and  $w \in \Sigma \setminus (\mathbf{w} \cup \mathbf{z})$  is a point which is not contained in  $\mathcal{L}_\alpha$  or  $\mathcal{L}_\beta$ . If  $\lambda$  is an arc with  $\partial\lambda = \{w, w'\}$ , then*

$$\mathcal{S}_w^- \mathcal{A}_\lambda \mathcal{S}_w^+ \simeq \text{id}.$$

*In the above, we quotient by  $\mathcal{U}_w - \mathcal{U}_{w'}$  on the complex which has both  $w$  and  $w'$ .*

*Proof.* The proof of the first claim is essentially the same as in the case of the ordinary 3-manifold invariants [Zem15, Lemma 14.6]. The relation  $[\partial_{\text{Mor}}, \mathcal{A}_\lambda] = (\mathcal{U}_w + \mathcal{U}_{w'}) \cdot \text{id}$  from Lemma 13.13 may be differentiated to obtain the relation  $[\Phi_w, \mathcal{A}_\lambda] \simeq \text{id}$ .

The claim that  $\Phi_w^2 \simeq 0$  follows from the argument in [Sar15, Lemma 4.4]. Cf. [Zem15, Lemma 14.8].

The final claim that  $\mathcal{S}_w^- \mathcal{A}_\lambda \mathcal{S}_w^+ \simeq \text{id}$  is proven in [HHSZ21, Proposition 7.2]. Compare [Zem15, Lemma 7.10] for the case of the ordinary Heegaard Floer complexes.  $\square$

The following is a hypercube analog of [OS04b, Proposition 4.17] and [Zem15, Lemma 5.5].

**Lemma 13.22.** *Let  $\mathcal{L}_\alpha$  and  $\mathcal{L}_\beta$  be hypercubes of handleslide equivalent attaching curves on  $(\Sigma, \mathbf{w}, \mathbf{z})$ . If  $\gamma$  is a closed curve on  $\Sigma$  then  $\mathcal{A}_\gamma^2 \simeq 0$ . If  $\lambda$  is an arc which connects two distinct free basepoints  $w, w' \in \mathbf{w}$ , then*

$$\mathcal{A}_\lambda^2 \simeq \mathcal{U}_w \cdot \text{id} \simeq \mathcal{U}_{w'} \cdot \text{id}.$$

*Remark 13.23.* We note that the map  $\mathcal{A}_\lambda$  is in general only defined up to chain homotopy, and is not generally a cycle. Some care is required in composing maps which are not cycles in the homotopy category. For example, if  $f, f', g, g'$  are in  $\text{End}(C)$ , (but not necessarily cycles) and  $f \simeq f'$  and  $g \simeq g'$ , it is not necessarily the case that  $f \circ g \simeq f' \circ g'$ . However, if  $[\partial(f), f] = 0$ , then  $f^2 \simeq (f')^2$ . Similarly if  $\partial(f)$  and  $\partial(g)$  are central in  $\text{End}(C)$ , then  $[f, g] \simeq [f', g']$ .

*Proof.* We focus on the case that  $\lambda$  is an arc, as the case of a closed curve is an easy modification. Our proof will be to build a diagram

$$\mathcal{L}_\alpha^{\lambda \cdot \lambda} = \begin{array}{ccc} \mathcal{L}_\alpha & \xrightarrow{\lambda} & \mathcal{L}_\alpha \\ & \searrow & \downarrow \lambda \\ & & \mathcal{L}_\alpha \end{array}$$

which satisfies a suitable version of the hypercube relations. We will pair  $\mathcal{L}_\alpha^{\lambda,\lambda}$  with  $\mathcal{L}_\beta$  to obtain the relation. The construction of  $\mathcal{L}_\alpha^{\lambda,\lambda}$  will be by a filling construction similar to our definition of  $\mathcal{L}_\alpha^\lambda$  in the construction of  $\mathcal{A}_\lambda$ .

Before constructing  $\mathcal{L}_\alpha^\lambda$ , we need to understand how to interpret the hypercube relations on such a diagram. We recall that in our construction of the map  $\mathcal{A}_\lambda$  from Section 13.3, we interpreted the expression

$$f_{\gamma_1, \dots, \gamma_j, \gamma_j, \dots, \gamma_n}(\Theta_{1,2}, \dots, \Theta_{j-1,j}, \lambda, \Theta_{j,j+1}, \dots, \Theta_{n-1,n})$$

as counting holomorphic  $n$ -gons with a factor of  $\#(\partial_{\gamma_j}(\psi) \cap \lambda)$ . We observed that this map satisfies the  $A_\infty$ -relations as long as we use a strict-unality convention and formally define  $\partial\lambda = \mathcal{U}_w + \mathcal{U}_{w'}$ . In our present setting, we instead interpret  $\partial\lambda = 0$ , and we extend this notation to the case where  $\lambda$  is an input multiple times.

To simplify some notation in this proof, we introduce the notation  $a_j^\psi$  for  $\#(\partial_{\gamma_j}(\psi) \cap \lambda)$ . We interpret  $a_j^\psi$  as 0 if  $\phi$  has no boundary components in  $\gamma_j$ . We write  $a_{j,j}^\psi$  for  $a_j^\psi(a_j^\psi + 1)/2$ . Note that this requires a choice of orientation on the curve  $\lambda$ . We orient  $\lambda$  so that if  $\phi_w, \phi_{w'}$  denote nonnegative classes of index 2  $\mathbb{T}_{\gamma_j}$ -boundary degenerations which cover  $w$  and  $w'$ , respectively, then

$$a_{j,j}^{\phi_w} \equiv 1 \quad \text{and} \quad a_{j,j}^{\phi_{w'}} \equiv 0, \quad (13.13)$$

We define

$$f_{\gamma_1, \dots, \gamma_j, \gamma_j, \gamma_j, \dots, \gamma_n}(\Theta_{1,2}, \dots, \Theta_{j-1,j}, \lambda, \lambda, \Theta_{j,j+1}, \dots, \Theta_{n-1,n})$$

to count holomorphic  $n$  gons with a weight of  $a_{j,j}^\psi$ .

If  $j < k$  we define

$$f_{\gamma_1, \dots, \gamma_j, \gamma_j, \dots, \gamma_k, \gamma_k, \dots, \gamma_n}(\Theta_{1,2}, \dots, \Theta_{j-1,j}, \lambda, \Theta_{j,j+1}, \dots, \Theta_{k-1,k}, \lambda, \Theta_{k,k+1}, \dots, \Theta_{n-1,n})$$

to count holomorphic  $n$  gons with a weight of  $a_j^\psi a_k^\psi$ .

These numerical choices can be motivated by thinking of the homology action as counting curves with marked points along their alpha boundaries. See [LS19, Section 3].

We claim that the  $A_\infty$ -relations are satisfied even when we have multiple  $\lambda$ 's as an input, as long as we follow the strict unality convention and also formally set  $\partial\lambda = \mathcal{U}_w - \mathcal{U}_{w'}$  and  $\mu_2(\lambda, \lambda) = \mathcal{U}_w$ .

To see that the associativity relations are satisfied, as stated above, we argue as follows. Suppose that  $(\Sigma, \gamma_1, \dots, \gamma_n, \mathbf{w}, \mathbf{z})$  is a diagram and consider the desired associativity relations applied to the tuple  $(\Theta_{1,2}, \dots, \Theta_{i-1,i}, \lambda, \dots, \lambda, \Theta_{j,j+1}, \dots, \Theta_{n-1,n})$ . There are two cases to consider:  $i < j$  and  $i = j$ . Suppose that  $\phi * \psi$  is a class of  $n$ -gons on  $(\Sigma, \gamma_1, \dots, \gamma_n, \mathbf{w}, \mathbf{z})$ . If  $i < j$ , the associativity relations follow from the fact that

$$a_i^{\phi_1} a_j^{\phi_1} + a_i^{\phi_1} a_j^{\phi_2} + a_i^{\phi_2} a_j^{\phi_1} + a_i^{\phi_2} a_j^{\phi_2} \equiv a_i^{\phi_1 * \phi_2} a_j^{\phi_1 * \phi_2} \pmod{2}.$$

Since the right-hand side is independent of the decomposition of  $\psi = \phi_1 * \phi_2$ , we may obtain the associativity relations in this case summing over  $a_i^\psi a_j^\psi \# \partial\mathcal{M}(\psi)$  for  $n$ -gons  $\psi$  of index  $4 - n$ . If  $n = 2$ , there are additional ends corresponding to alpha boundary degenerations. Since we are considering only the case that  $i < j$ , this corresponds to considering the associativity relations for  $(\lambda, \Theta_{1,2}, \lambda)$ . In this case, boundary degenerations make trivial contribution to the associativity relations since  $a_1^\phi \cdot a_2^\phi = 0$  for any nonnegative, index 2 class of boundary degenerations  $\phi$ .

We now consider the associativity relation in the case that  $i = j$ . We observe the relation:

$$a_{i,i}^\phi + a_{i,i}^\psi + a_i^\phi a_i^\psi \equiv a_{i,i}^{\phi*\psi} \pmod{2}.$$

When  $n > 2$ , the associativity relations follow by summing over the ends of moduli spaces of  $n$ -gons with Maslov index  $4 - n$ , with a weight of  $a_{i,i}^\phi$ . When  $n = 2$ , there are additional ends corresponding to boundary degenerations. Boundary degenerations are encoded via Equation (13.13) into the relation  $\lambda \cdot \lambda = \mathcal{U}_w$ . This completes the proof of the associativity relations.

To construct  $\mathcal{L}_\alpha^{\lambda,\lambda}$ , we follow the standard filling procedure. We assume that we have already filled all arrows which increment only one  $\lambda$ -component (such arrows are used to construct  $\mathcal{A}_\lambda$ ).

We consider the problem of filling arrows of length  $n > 2$  which increment both  $\lambda$  directions. We illustrate the smallest case,  $n = 3$ , below:

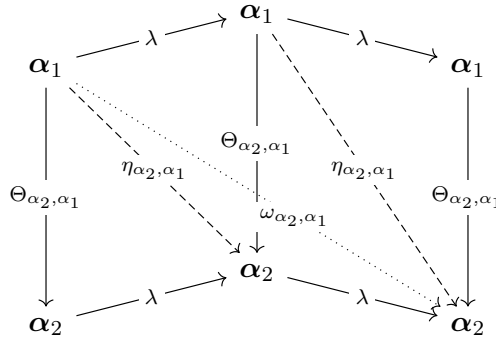

We let  $C_{\alpha_2, \alpha_1}$  denote the terms appearing in the length 3 relation, except for  $\partial\omega_{\alpha_2, \alpha_1}$ . We make two claims:

- (1)  $C_{\alpha_2, \alpha_1}$  is a cycle of bidegree  $(1, 1)$  less than the top degree of homology.
- (2) For appropriate choices of the arrows which increase exactly one  $\lambda$ -direction,  $C_{\alpha_2, \alpha_1}$  is in the submodule generated by the ideal  $(\mathcal{U}_w, \mathcal{U}_{w'})$ .

The claim that  $C_{\alpha_2, \alpha_1}$  is a cycle is an easy consequence of the associativity relations, interpreted above, which we leave to the reader.

The fact that  $C_{\alpha_2, \alpha_1}$  may be assumed to be in the submodule spanned by  $(\mathcal{U}_w, \mathcal{U}_{w'})$  may be seen as follows. In Lemma 13.15, we proved that all chains in  $\mathcal{L}_\alpha^\lambda$  of length 2 or greater which increase the  $\lambda$  direction may be taken to be in the submodule spanned by  $(\mathcal{U}_w, \mathcal{U}_{w'})$ . Hence, each summand of  $C_{\alpha_2, \alpha_1}$  which involves  $\eta_{\alpha_2, \alpha_1}$  be in this submodule. The remaining terms involve counts of holomorphic disks of index 1 which have  $\Theta_{\alpha_2, \alpha_1}$  as an input. There are multiple ways for such a holomorphic disk to contribute to  $C_{\alpha_2, \alpha_1}$ , depending on the locations of the two  $\lambda$ -inputs. We observe that the total count of a class  $\phi \in \pi_2(\Theta_{\alpha_2, \alpha_1}, \mathbf{y})$  to  $C_{\alpha_2, \alpha_1}$  is weighted by

$$a_1^\phi a_2^\phi + a_{1,1}^\phi + a_{2,2}^\phi.$$

It is straightforward to see that the above quantity is congruent modulo 2 to

$$\frac{(a_1^\phi + a_2^\phi)(a_1^\phi + a_2^\phi + 1)}{2}.$$

We observe that  $a_1^\phi + a_2^\phi = n_w(\phi) + n_{w'}(\phi)$ , since  $\partial D(\phi) = \partial_{\alpha_1}(\phi) + \partial_{\alpha_2}(\phi)$ . In particular, if a disk  $\phi$  has  $n_w(\phi) = n_{w'}(\phi) = 0$ , then it is weighted by 0 in  $C_{\alpha_2, \alpha_1}$ . Hence  $C_{\alpha_2, \alpha_1}$  is in the submodule spanned by  $(\mathcal{U}_w, \mathcal{U}_{w'})$ .

We have established that  $C_{\alpha_2, \alpha_1}$  is a cycle in bigrading  $(1, 1)$  less than the canonical top degree generator, and furthermore is in the span of  $\mathcal{U}_w$  and  $\mathcal{U}_{w'}$ . We observe that the map  $\pi$  in Equation (13.10) for quotienting by  $\mathcal{U}_w$  and  $\mathcal{U}_{w'}$  is a chain map which is injective on the space in the grading of the canonical generator and also in the space of grading  $(1, 1)$  less than the top degree of  $HF^-(\alpha_2, \alpha_1)$ . Hence,  $C_{\alpha_2, \alpha_1} = \partial\omega_{\alpha_2, \alpha_1}$  for some  $\omega_{\alpha_2, \alpha_1}$  in the top degree.

We now argue that  $\omega_{\alpha_2, \alpha_1}$  may be taken to be in the submodule  $(\mathcal{U}_w, \mathcal{U}_{w'})$ . The proof is essentially the same as Lemma 13.15. The image  $\pi(\omega_{\alpha_2, \alpha_1})$  is a cycle, and by possibly adding a top degree generator of  $HF^-(\alpha_2, \alpha_1)$ , we may assume that  $[\pi(\omega_{\alpha_2, \alpha_1})] = 0$ . From here, the argument of Lemma 13.15 may be applied verbatim.

From here, we continue filling the higher length chains of  $\mathcal{L}_\alpha^{\lambda, \lambda}$ . The argument for the higher length chains is essentially identical to the argument for the length 3 chains, so we leave it to the reader.

With the diagram  $\mathcal{L}_\alpha^{\lambda, \lambda}$  in hand, the relation  $\mathcal{A}_\lambda^2 \simeq \mathcal{U}_w$  is obtained by formally pairing  $\mathcal{L}_\alpha^{\lambda, \lambda}$  with  $\mathcal{L}_\beta$  and using the associativity relations as described earlier.  $\square$

**Lemma 13.24.** *Suppose that  $\mathcal{L}_\alpha$  and  $\mathcal{L}_\beta$  are hypercubes of handleslide equivalent attaching curves on  $(\Sigma, \mathbf{w}, \mathbf{z})$ . Suppose that  $\lambda_1$  and  $\lambda_2$  are closed curves or arcs on  $\Sigma$  with boundary in  $\mathbf{w}$ , such that furthermore  $\partial\lambda_1$  and  $\partial\lambda_2$  only contain free-basepoints. Then*

$$[\mathcal{A}_{\lambda_1}, \mathcal{A}_{\lambda_2}] \simeq \sum_{w \in \partial\lambda_1 \cap \partial\lambda_2} \mathcal{U}_w.$$

*Proof.* The proof is similar to the proof of Lemma 13.22. We will build a diagram of the following form

$$\mathcal{L}_\alpha^{[\lambda_1, \lambda_2]} = \begin{array}{ccc} \mathcal{L}_\alpha & -\lambda_1 \rightarrow & \mathcal{L}_\alpha \\ \downarrow \lambda_2 & \searrow & \downarrow \lambda_2 \\ \mathcal{L}_\alpha & -\lambda_1 \rightarrow & \mathcal{L}_\alpha \end{array} \quad (13.14)$$

which we pair with  $\mathcal{L}_\beta$  to obtain the relation in the statement. Similar to Lemma 13.22, we need to describe how to interpret the holomorphic polygon counts where we formally have  $\lambda_1$  and  $\lambda_2$  as an input.

We have already defined the holomorphic polygon maps when there is a single input of  $\lambda_1$  or  $\lambda_2$ . When there are two inputs, we make the following definitions. Suppose  $(\Sigma, \gamma_1, \dots, \gamma_n, \mathbf{w}, \mathbf{z})$  is a Heegaard diagram. If  $j < k$ ,  $s, t \in \{1, 2\}$ , and  $s \neq t$ , we define

$$f_{\gamma_1, \dots, \gamma_j, \gamma_j, \dots, \gamma_k, \gamma_k, \dots, \gamma_n}(\Theta_{1,2}, \dots, \lambda_s, \dots, \lambda_t, \dots, \Theta_{n-1,n})$$

to count polygons weighted by  $\#(\partial_{\gamma_j}(\psi) \cap \lambda_s) \#(\partial_{\gamma_k}(\psi) \cap \lambda_t)$ . Next, we define

$$f_{\gamma_1, \dots, \gamma_j, \gamma_j, \gamma_j, \dots, \gamma_n}(\Theta_{1,2}, \dots, \lambda_2, \lambda_1, \dots, \Theta_{n-1,n})$$

to also count curves weighted by  $\#(\partial_{\gamma_j}(\psi) \cap \lambda_2) \#(\partial_{\gamma_j}(\psi) \cap \lambda_1)$ . Finally, we define

$$f_{\gamma_1, \dots, \gamma_j, \gamma_j, \gamma_j, \dots, \gamma_n}(\Theta_{1,2}, \dots, \lambda_1, \lambda_2, \dots, \Theta_{n-1,n}) = 0$$

We claim that these satisfy a certain associativity relation. Instead of showing an  $A_\infty$ -associativity relation on all tuples, we will show that associativity is satisfied on



only some generators. We will show that associativity holds on tuples of the form

$$(\Theta_{1,2}, \dots, \Theta_{j-1,j}, \lambda_t, \dots, \lambda_s, \Theta_{k,k+1}, \dots, \Theta_{n-1,n}) \quad (13.15)$$

whenever  $j < k$  and  $t \neq s$ . Additionally, we will show that the associativity relations also hold on

$$\begin{aligned} &(\Theta_{1,2}, \dots, \Theta_{j-1,j}, \lambda_1, \lambda_2, \Theta_{j,j+1}, \dots, \Theta_{n-1,n}) \\ &+ (\Theta_{1,2}, \dots, \Theta_{j-1,j}, \lambda_2, \lambda_1, \Theta_{j,j+1}, \dots, \Theta_{n-1,n}) \end{aligned} \quad (13.16)$$

as long as we make the following conventions: strict unality with the  $\lambda$ -inputs;  $\partial\lambda_i = 0$ ; and  $[\lambda_1, \lambda_2] = \sum_{w \in \partial\lambda_1 \cap \partial\lambda_2} \mathcal{U}_w$ . This weaker notion of associativity is sufficient for the purposes of constructing  $\mathcal{L}_\alpha^{[\lambda_1, \lambda_2]}$  and understanding the hypercube relations. (Note that instead of the above approach, we could have instead attempt to prove associativity for general tuples, but this would require defining the polygon maps when there are inputs such as  $\lambda_1 \cdot \lambda_2$ , which is an unnecessary detour).

The proof of associativity, as described above, is broken into several cases. The first case is when  $n > 2$  and  $j < k$ . In this case, the generic degenerations of a 1-dimensional family of holomorphic  $n$ -gons will consist of pairs of an  $p$ -gon and a  $q$ -gon for  $p + q = n + 2$ . Write  $\phi$  and  $\psi$  for the classes of the  $p$  and  $q$ -gons respectively. If  $s \in \{1, 2\}$ , write  $a_j^\phi$  for  $\#(\partial_{\gamma_j}(\phi) \cap \lambda_1)$  and  $b_j^\phi$  for  $\#(\partial_{\gamma_j}(\phi) \cap \lambda_2)$ . In this case, the associativity relation applied to tuples as in Equation (13.15) follows from the additive relation

$$a_j^\phi b_k^\psi + a_j^\psi b_k^\phi + a_j^\phi b_k^\phi + a_j^\psi b_k^\psi = a_j^{\phi*\psi} b_k^{\phi*\psi}$$

Associativity for tuples as in Equation (13.16), when  $j = k$  and  $n > 2$ , follows from the similar additive relation

$$a_j^\phi b_j^\psi + a_j^\psi b_j^\phi + a_j^\phi b_j^\phi + a_j^\psi b_j^\psi = a_j^{\phi*\psi} b_j^{\phi*\psi}.$$

Finally, in the case that  $n = 2$ , there are additional ends corresponding to boundary degenerations. These ends contribute in the associativity relations for  $(\Theta_{1,2}, \lambda_1, \lambda_2)$  on a diagram  $(\Sigma, \gamma_1, \gamma_2, \mathbf{w}, \mathbf{z})$ . The relation  $[\lambda_1, \lambda_2] = \sum_{w \in \partial\lambda_1 \cap \partial\lambda_2} \mathcal{U}_w$  correspond to the fact that  $a_2^\phi b_2^\phi \equiv 1$  if  $\phi$  is a nonnegative, index 2 class of boundary degenerations which covers a point of  $\partial\lambda_1 \cap \partial\lambda_2$ . Furthermore this boundary degeneration does not contribute to the associativity relations for  $(\lambda_1, \Theta_{1,2}, \lambda_2)$  since  $a_1^\phi b_2^\phi \equiv 0$  for any boundary degeneration (since a boundary degeneration has boundary on only one set of attaching curves).

Having described the necessary associativity relations, filling the higher length chains of the diagram in Equation (13.14) and verifying the hypercube relations on the pairing of  $\mathcal{L}_\alpha^{[\lambda_1, \lambda_2]}$  and  $\mathcal{L}_\beta$  is performed similarly to the proof of Lemma 13.22. We leave the remaining details of the construction to the reader.  $\square$

We prove a final lemma:

**Lemma 13.25.** *Suppose that  $\lambda_1$  and  $\lambda_2$  are two 2-chains on  $(\Sigma, \mathbf{w}, \mathbf{z})$ , such that  $\partial\lambda_i \subseteq \mathbf{w}$ . If  $\partial\lambda_i \neq \emptyset$ , assume that  $\partial\lambda_i$  consists of only free-basepoints. Then*

$$\mathcal{A}_{\lambda_1} + \mathcal{A}_{\lambda_2} \simeq \mathcal{A}_{\lambda_1 + \lambda_2}.$$



*Proof.* We observe first that for any class of curves  $\phi$  which has boundary on  $\alpha_i$ , we have

$$\#(\partial_{\alpha_i}(\phi) \cap (\lambda_1 + \lambda_2)) = \#(\partial_{\alpha_i}(\phi) \cap \lambda_1) + \#(\partial_{\alpha_i}(\phi) \cap \lambda_2).$$

In particular, we may construct  $\mathcal{L}_\alpha^{\lambda_1 + \lambda_2}$  by summing the morphisms in the  $\lambda$ -direction of  $\mathcal{L}_\alpha^{\lambda_1}$  and  $\mathcal{L}_\alpha^{\lambda_2}$ . With this definition,  $\mathcal{A}_{\lambda_1 + \lambda_2} = \mathcal{A}_{\lambda_1} + \mathcal{A}_{\lambda_2}$ . Since the map  $\mathcal{A}_{\lambda_1 + \lambda_2}$  is well-defined up to chain homotopy, the claim in the statement follows for an arbitrary construction of  $\mathcal{L}_\alpha^{\lambda_1 + \lambda_2}$ .  $\square$

We now prove a helpful formula for understanding basepoint moving maps on the link surgery hypercubes. See [Zem15, Theorem 14.11] for an analogous result in the setting of the ordinary Heegaard Floer complexes.

**Lemma 13.26.** *Let  $\mathcal{H} = (\Sigma, \mathcal{L}_\alpha, \mathcal{L}_\beta, \mathbf{w}, \mathbf{z})$ , where  $\mathcal{L}_\alpha$  and  $\mathcal{L}_\beta$  are hypercubes of handleslide equivalent attaching curves. Suppose that  $w_1 \in \mathbf{w}$ , and that  $w_2 \in \Sigma \setminus \mathbf{w}$  is in the complement of the curves in  $\mathcal{L}_\alpha$  and  $\mathcal{L}_\beta$ . Suppose also that  $(\Sigma, \mathcal{L}_\alpha, \mathcal{L}_\beta, \mathbf{w})$  and  $(\Sigma, \mathcal{L}_\alpha, \mathcal{L}_\beta, \{w_2\} \cup \mathbf{w} \setminus \{w_1\})$  are both weakly admissible. Let  $\mathcal{H}_{w_i}^+$  denote the diagram obtained by free-stabilizing  $\mathcal{H}$  at  $w_i$ . If  $\lambda$  is a path from  $w$  to  $w'$ , then*

$$\mathcal{S}_{w_1}^- \Psi_{\mathcal{H}_{w_2}^+ \rightarrow \mathcal{H}_{w_1}^+} \mathcal{A}_\lambda \mathcal{S}_{w_2}^+$$

is chain homotopic to the diffeomorphism map which moves  $w_1$  to  $w_2$  along  $\lambda$ . In the above, we work on the complexes where we have identified  $\mathcal{U}_{w_1}$  and  $\mathcal{U}_{w_2}$  so that  $\mathcal{A}_\lambda$  is a chain map. Also  $\Psi_{\mathcal{H}_{w_2}^+ \rightarrow \mathcal{H}_{w_1}^+}$  denotes the map defined in Section 13.1.

*Proof.* We give a simpler proof than appeared in the setting of 3-manifold invariants in [Zem15, Theorem 14.11], as follows. Let  $z$  be a point very near to  $w_2$ . We will view  $\lambda$  as the concatenation of a path  $\lambda_1$  from  $w_1$  to  $z$ , and a path  $\lambda_2$  from  $z$  to  $w_2$ . In the following, we drop the transition maps  $\Psi_{\mathcal{H}_{w_2}^+ \rightarrow \mathcal{H}_{w_1}^+}$  from the notation.

Let  $\phi_*$  denote the point pushing diffeomorphism map which moves  $w_2$  to  $w_1$  along  $\lambda$ , composed with the naturality map. It is sufficient to show that

$$\text{id} \simeq \phi_* \mathcal{S}_{w_1}^- \mathcal{A}_\lambda \mathcal{S}_{w_2}^+. \quad (13.17)$$

As a first step, we claim that map  $\mathcal{S}_{w_1}^- \mathcal{A}_\lambda \mathcal{S}_{w_2}^+$  is functorial under concatenation of arcs, i.e. that

$$\mathcal{S}_{w_1}^- \mathcal{A}_\lambda \mathcal{S}_{w_2}^+ \simeq \mathcal{S}_z^- \mathcal{A}_{\lambda_2} \mathcal{S}_{w_2}^+ \mathcal{S}_{w_1}^- \mathcal{A}_{\lambda_1} \mathcal{S}_z^+. \quad (13.18)$$

To establish Equation (13.18), first note that we may commute free-stabilization maps with other terms by Lemmas 13.19 and 13.20 to obtain

$$\begin{aligned} & \mathcal{S}_z^- \mathcal{A}_{\lambda_2} \mathcal{S}_{w_2}^+ \mathcal{S}_{w_1}^- \mathcal{A}_{\lambda_1} \mathcal{S}_{w_2}^+ \\ & \simeq \mathcal{S}_{w_1}^- \mathcal{S}_z^- \mathcal{A}_{\lambda_2} \mathcal{A}_{\lambda_1} \mathcal{S}_z^+ \mathcal{S}_{w_2}^+ \end{aligned}$$

Next, we use the relations  $\mathcal{A}_{\lambda_i}^2 \simeq \mathcal{U}$  and  $\mathcal{A}_{\lambda_1 + \lambda_2} = \mathcal{A}_{\lambda_1} + \mathcal{A}_{\lambda_2}$  from Lemmas 13.22 and 13.25 to see that

$$\mathcal{S}_{w_1}^- \mathcal{S}_z^- \mathcal{A}_{\lambda_2} \mathcal{A}_{\lambda_1} \mathcal{S}_z^+ \mathcal{S}_{w_2}^+ \simeq \mathcal{S}_{w_1}^- \mathcal{S}_z^- (\mathcal{A}_{\lambda_2 + \lambda_1} \mathcal{A}_{\lambda_1} + \mathcal{U}) \mathcal{S}_z^+ \mathcal{S}_{w_2}^+.$$

We use the relation  $\mathcal{S}_z^- \mathcal{S}_z^+ = 0$  (which is immediate from the formula) and the fact that  $\lambda_2 + \lambda_1 = \lambda$  to see that the above is homotopic to

$$\mathcal{S}_{w_1}^- \mathcal{S}_z^- \mathcal{A}_\lambda \mathcal{A}_{\lambda_1} \mathcal{S}_z^+ \mathcal{S}_{w_2}^+.$$

Next, we use the fact that  $\lambda$  is disjoint from  $z$  to commute  $\mathcal{S}_z^-$  with  $\mathcal{A}_\lambda$  using Lemma 13.19, and then we use the relation  $\mathcal{S}_z^- \mathcal{A}_{\lambda_1} \mathcal{S}_z^+ \simeq \text{id}$  to see that the above equation is homotopic to

$$\mathcal{S}_{w_1}^- \mathcal{A}_\lambda \mathcal{S}_{w_2}^+.$$

This establishes Equation (13.18).

To obtain the main statement in Equation (13.17), we combine Equation (13.18) with the naturality of all of the other maps with respect to diffeomorphisms, via the following manipulation:

$$\begin{aligned} \phi_* \mathcal{S}_{w_1}^- \mathcal{A}_\lambda \mathcal{S}_{w_2}^+ &\simeq \phi_* \mathcal{S}_z^- \mathcal{A}_{\lambda_2} \mathcal{S}_{w_2}^+ \mathcal{S}_{w_1}^- \mathcal{A}_{\lambda_1} \mathcal{S}_z^+ \\ &\simeq \mathcal{S}_z^- \mathcal{A}_{\phi(\lambda_2)} \phi_* \mathcal{S}_{w_2}^+ \mathcal{S}_{w_1}^- \mathcal{A}_{\lambda_1} \mathcal{S}_z^+ \\ &\simeq \mathcal{S}_z^- \mathcal{A}_{\phi(\lambda_2)} \mathcal{S}_{w_1}^+ \mathcal{S}_{w_1}^- \mathcal{A}_{\lambda_1} \mathcal{S}_z^+. \end{aligned}$$

We may easily arrange that  $\phi(\lambda_2)$  and  $\lambda_1$  are isotopic on  $\Sigma$  (rel. boundary). Hence  $\mathcal{A}_{\phi(\lambda_2)} \simeq \mathcal{A}_{\lambda_1}$  by Lemma 13.16. The expression is easily shown to be homotopic to the identity using the graph TQFT relations, as we briefly recall. We obtain from Lemma 13.18 that

$$\mathcal{S}_z^- \mathcal{A}_{\lambda_1} \mathcal{S}_{w_1}^+ \mathcal{S}_{w_1}^- \mathcal{A}_{\lambda_1} \mathcal{S}_z^+ \simeq \mathcal{S}_z^- \mathcal{A}_{\lambda_1} \Phi_{w_1} \mathcal{A}_{\lambda_1} \mathcal{S}_z^+.$$

The above expression is homotopic to  $\mathcal{S}_z^- \mathcal{A}_{\lambda_1} \mathcal{A}_{\lambda_1} \Phi_{w_1} \mathcal{S}_z^+ + \mathcal{S}_z^- \mathcal{A}_{\lambda_1} \mathcal{S}_z^+$  by Lemma 13.21. By Lemma 13.22 we see that  $\mathcal{S}_z^- \mathcal{A}_{\lambda_1}^2 \Phi_{w_1} \mathcal{S}_z^+ \simeq U \mathcal{S}_z^- \mathcal{S}_z^+ \Phi_{w_1} = 0$  and by Lemma 13.21 we have that  $\mathcal{S}_z^- \mathcal{A}_{\lambda_1} \mathcal{S}_z^+ \simeq \text{id}$ . This completes the proof.  $\square$

*Remark 13.27.* The above argument also applies to the setting of ordinary Heegaard Floer complexes to give a shorter proof of the normalization axiom of the graph TQFT [Zem15, Theorem 14.11].

We now prove the main basepoint moving map result:

*Proof of Theorem 13.4.* The proof follows from the same manipulation as in the setting of the graph TQFT, see [Zem15, Section 14.4]. We produce the argument for the reader. We decompose  $\gamma$  into the concatenation of two arcs  $\lambda_1, \lambda_2$ , and view  $\lambda_1$  as a path from  $w$  to a new basepoint  $z$ , and  $\lambda_2$  as a path from  $z$  to  $w$ . In all of the Floer complexes we consider, we identify the variables for  $z$  and  $w$  with a single variable  $\mathcal{U}$ . We compute

$$\begin{aligned} \gamma_* &\simeq \mathcal{S}_z^- \mathcal{A}_{\lambda_2} \mathcal{S}_w^+ \mathcal{S}_w^- \mathcal{A}_{\lambda_1} \mathcal{S}_z^+ \\ &\simeq \mathcal{S}_z^- \mathcal{A}_{\lambda_2} \Phi_w \mathcal{A}_{\lambda_1} \mathcal{S}_z^+ \\ &\simeq \mathcal{S}_z^- \mathcal{A}_{\lambda_1} \mathcal{S}_z^+ + \mathcal{S}_z^- \Phi_w \mathcal{A}_{\lambda_2} \mathcal{A}_{\lambda_1} \mathcal{S}_z^+ \\ &\simeq \text{id} + \Phi_w \mathcal{S}_z^- (\mathcal{A}_{\lambda_1} + \mathcal{A}_\gamma) \mathcal{A}_{\lambda_1} \mathcal{S}_z^+ \\ &\simeq \text{id} + \Phi_w \mathcal{S}_z^- \mathcal{U} \mathcal{S}_z^+ + \Phi_w \mathcal{A}_\gamma \mathcal{S}_z^- \mathcal{A}_{\lambda_1} \mathcal{S}_z^+ \\ &\simeq \text{id} + \Phi_w \mathcal{A}_\gamma, \end{aligned}$$

completing the proof.  $\square$

**13.6. Relating homology actions and basepoint actions.** Suppose that  $(\Sigma, \alpha, \beta, \mathbf{w}, \mathbf{z})$  is a Heegaard link diagram for  $(Y, L)$  and that  $K \subseteq L$  is a knot component which has basepoints  $w \in \mathbf{w}$  and  $z \in \mathbf{z}$ . We may represent  $K$  on  $\Sigma$  as a concatenation of two arcs  $\lambda_\alpha$  and  $\lambda_\beta$  which both have boundary  $\{w, z\}$ . The arc  $\lambda_\alpha$  intersects only alpha curves

while  $\lambda_\beta$  intersects only beta curves. If  $\phi$  is a class of disks, then  $a(\phi, \gamma) = n_w(\phi) - n_z(\phi) \pmod{2}$ , which leads to the equality

$$A_{[K]} = \mathcal{U}_w \Phi_w + \mathcal{V}_z \Psi_z$$

as endomorphisms of  $\mathcal{CFL}(Y, L)$ . In this section, we prove a hypercube version of the above statement.

We consider hypercubes of handleslide equivalent attaching curves  $\mathcal{L}_\alpha$  and  $\mathcal{L}_\beta$  on  $(\Sigma, \mathbf{w}, \mathbf{z})$ . We suppose that there is a pair of arcs  $\lambda_\alpha, \lambda_\beta \subseteq \Sigma$  such that

$$\partial\lambda_\alpha = \partial\lambda_\beta = \{w, z\} \quad K = \lambda_\alpha * \lambda_\beta,$$

and such that  $\lambda_\alpha$  intersects only curves from  $\mathcal{L}_\alpha$  while  $\lambda_\beta$  intersects only curves from  $\mathcal{L}_\beta$ . Write  $K$  for the concatenation of  $\lambda_\alpha$  and  $\lambda_\beta$ . We recall from Section 13.3 that there is an endomorphism

$$\mathcal{A}_{[K]}: CF(\mathcal{L}_\alpha, \mathcal{L}_\beta) \rightarrow CF(\mathcal{L}_\alpha, \mathcal{L}_\beta).$$

Since  $K$  is a closed curve on  $\Sigma$ , the map  $\mathcal{A}_{[K]}$  counts holomorphic polygons (as would be counted by the ordinary hypercube differential) with a weight of  $a(\phi, K)$ , where  $a(\phi, K)$  is the sum over  $\#(\partial_\alpha \phi \cap K)$  ranging over all  $\alpha$  in  $\mathcal{L}_\alpha$ .

In Section 13.3 we constructed basepoint actions  $\Phi_w$  and  $\Psi_z$  on the hypercube  $CF(\mathcal{L}_\alpha, \mathcal{L}_\beta)$ . The definition of these maps was as the formal differential of the hypercube differential with respect to  $\mathcal{U}_w$ . We note that in general powers of  $\mathcal{U}_w$  are contributed by both the holomorphic curves in the hypercube differential, and also the powers of  $\mathcal{U}_w$  present in the input chains of the polygon maps used to construct the hypercube. We defined a map  $\Phi_w^0$  only took into account the multiplicities of holomorphic curves on the basepoint  $w$ . When  $\mathcal{L}_\alpha$  and  $\mathcal{L}_\beta$  were algebraically rigid, we had the inequality  $\Phi_w^0 = \Phi_w$  and  $\Psi_z^0 = \Psi_z$ . In general, this is not the case. Nonetheless, we do have the following:

**Lemma 13.28.** *Suppose that  $\mathcal{L}_\alpha$  and  $\mathcal{L}_\beta$  are hypercubes of handleslide equivalent attaching curves on  $(\Sigma, \mathbf{w}, \mathbf{z})$ , and  $K \subseteq \Sigma$  is a concatenation of two arcs  $\lambda_\alpha$  and  $\lambda_\beta$ , as above. Then  $\mathcal{U}_w \Phi_w^0 + \mathcal{V}_z \Psi_z^0$  is a chain map (regardless of whether  $\mathcal{L}_\alpha$  and  $\mathcal{L}_\beta$  are algebraically rigid) and*

$$\mathcal{A}_{[K]} = \mathcal{U}_w \Phi_w^0 + \mathcal{V}_z \Psi_z^0 = \mathcal{U}_w \Phi_w + \mathcal{V}_z \Psi_z,$$

as hypercube morphisms.

*Proof.* Since  $a(\phi, K) \equiv n_w(\phi) - n_z(\phi) \pmod{2}$  for any holomorphic polygon counted by the hypercube differential of  $CF(\mathcal{L}_\alpha, \mathcal{L}_\beta)$  we conclude that

$$\mathcal{A}_{[K]} = \mathcal{U}_w \Phi_w^0 + \mathcal{V}_z \Psi_z^0,$$

since the two sides count the same holomorphic curves, with the same weights. Since the left-hand side is a chain map by Lemma 13.12, the right hand side must also be a chain map.

It remains to show that

$$\mathcal{U}_w \Phi_w^0 + \mathcal{V}_z \Psi_z^0 = \mathcal{U}_w \Phi_w + \mathcal{V}_z \Psi_z.$$

To see this, we observe that  $\mathcal{U}_w \Phi_w + \mathcal{V}_z \Psi_z$  may be described as summing over sequences  $\varepsilon_1 < \dots < \varepsilon_n$  and  $\nu_1 < \dots < \nu_m$  the maps

$$\mathcal{U}_w \cdot (\phi_w)_{\nu_1 < \dots < \nu_m}^{\varepsilon_1 < \dots < \varepsilon_n} + \mathcal{V}_z \cdot (\psi_z)_{\nu_1 < \dots < \nu_m}^{\varepsilon_1 < \dots < \varepsilon_n} \quad (13.19)$$

(which count holomorphic curves weighted by their multiplicities over  $w$  and  $z$ , respectively, as in Equation (13.5)) and also summing expressions of the form

$$\mathbf{x} \mapsto f_{\alpha_{\nu_m}, \dots, \alpha_{\nu_1}, \beta_{\varepsilon_1}, \dots, \beta_{\varepsilon_n}} (\Theta_{m, m-1}^\alpha, \dots, (\Theta_{i+1, i}^\alpha)', \dots, \Theta_{2, 1}^\alpha, \mathbf{x}, \Theta_{1, 2}^\beta, \dots, \Theta_{n-1, n}^\beta), \quad (13.20)$$

as well as terms where the primed term is a beta-chain. In the above, we write  $\Theta_{j+1, j}^\alpha$  for  $\Theta_{\alpha_{\nu_{j+1}}, \alpha_{\nu_j}}$  and  $(\Theta_{i+1, i}^\alpha)'$  denotes  $(\mathcal{U}_w \partial_{\mathcal{U}_w} + \mathcal{V}_z \partial_{\mathcal{V}_z})(\Theta_{i+1, i}^\alpha)$ , and similarly for the beta-terms. That is, we sum over the holomorphic polygon maps where we apply  $(\mathcal{U}_w \partial_{\mathcal{U}_w} + \mathcal{V}_z \partial_{\mathcal{V}_z})$  to exactly one of the inputs from  $\mathcal{L}_\alpha$  or  $\mathcal{L}_\beta$ . The sum of maps in Equation (13.19) is exactly the map  $\mathcal{U}_w \Phi_w^0 + \mathcal{V}_z \Psi_z^0$ , so it suffices to show that the terms in Equation (13.20) vanish. To see this, we will show that if  $\Theta$  is any chain in  $\mathcal{L}_\alpha$  or  $\mathcal{L}_\beta$ , then  $(\mathcal{U}_w \partial_{\mathcal{U}_w} + \mathcal{V}_z \partial_{\mathcal{V}_z})(\Theta) = 0$ . We argue as follows, focusing on  $\mathcal{L}_\alpha$ . We observe that on the diagram  $(\Sigma, \mathcal{L}_\alpha, \mathbf{w}, \mathbf{z})$ , the basepoints  $w$  and  $z$  are immediately adjacent (by virtue of the existence of  $\lambda_\beta$ ). We note that each subdiagram  $(\Sigma, \alpha', \alpha, \mathbf{w}, \mathbf{z})$  represents an unlink  $\mathbb{U}$  in a connected sum of several copies of  $S^1 \times S^2$ . There is a  $|\mathbb{U}|$ -component Alexander grading on  $\mathcal{CFL}(\mathbb{U})$ , and the top Maslov bi-degree generators lie in Alexander grading  $(0, \dots, 0)$ . By construction, all of the chains of  $\mathcal{L}_\alpha$  also lie in Alexander grading  $(0, \dots, 0)$ . Write  $A_1$  for the component of the Alexander grading corresponding to  $K$ . Since  $\lambda_\beta$  connects  $w$  to  $z$  and is disjoint from all curves of  $\mathcal{L}_\alpha$ , if  $\mathbf{x} \in \mathbb{T}_{\alpha'} \cap \mathbb{T}_\alpha$ , we have  $A_1(\mathbf{x}) = 0$ . In particular, any chain in  $\mathcal{L}_\alpha$  must have equal powers of  $\mathcal{U}_w$  and  $\mathcal{V}_z$ , i.e., it must be of the form  $\mathcal{U}_w^n \mathcal{V}_z^n \cdot \mathbf{y}$ , where  $\mathbf{y}$  has no powers of  $\mathcal{U}_w$  or  $\mathcal{V}_z$ . Clearly

$$(\mathcal{U}_w \partial_{\mathcal{U}_w} + \mathcal{V}_z \partial_{\mathcal{V}_z})(\mathcal{U}_w^n \mathcal{V}_z^n \cdot \mathbf{y}) = 0,$$

as claimed. The same argument works for  $\mathcal{L}_\beta$ , so the proof is complete.  $\square$

**13.7. Properties of the  $U$ -action on link surgery complexes.** We now explore some of the complexities of the surgery theorem when we allow arbitrary arcs for our  $\sigma$ -basic systems.

**Lemma 13.29.** *Suppose that  $\mathcal{A}$  is a system of arcs for  $L \subseteq S^3$ , and suppose that the arcs for the knot components  $K_i, K_j \subseteq L$  are alpha-parallel or beta-parallel (the case that one is alpha-parallel and the other is beta-parallel is allowed). Then the actions of  $U_1$  and  $U_2$  are homotopic on  $\mathcal{X}_\Lambda(L, \mathcal{A})^\mathcal{L}$  in the sense that there is a type- $D$  module morphism  $H^1: \mathcal{X}_\Lambda(L, \mathcal{A})^\mathcal{L} \rightarrow \mathcal{X}_\Lambda(L, \mathcal{A})^\mathcal{L}$  such that*

$$\partial_{\text{Mor}}(H^1) = \text{id} \otimes (U_1 + U_2).$$

*In the above,  $U_i$  denotes  $\mathcal{U}_i \mathcal{V}_i$  and  $\text{id} \otimes (U_1 + U_2)$  means the map which sends  $\mathbf{x}$  to  $\mathbf{x} \otimes (U_1 + U_2)$  in all idempotents.*

*Proof.* Let  $\mathcal{H}$  be a  $\sigma$ -basic system of Heegaard diagrams for  $(L, \mathcal{A})$ . We may assume that  $\mathcal{H}$  is meridional for  $K_1$  and  $K_2$ , in the sense of Section 9.4. We begin with the case that  $K_1$  and  $K_2$  are both alpha-parallel or both beta-parallel. For concreteness, assume that  $K_1$  and  $K_2$  are both alpha-parallel, so that the arcs of  $\mathcal{A}$  are both disjoint from the beta curves. We let  $\lambda: [0, 1] \rightarrow \Sigma$  denote a path from  $z_1$  to  $z_2$  which is disjoint from all of the arcs of  $\mathcal{A}$ .

Given hypercubes of alpha and beta Lagrangians  $\mathcal{L}_\alpha$  and  $\mathcal{L}_\beta$  on a pointed surface  $(\Sigma, \mathbf{w}, \mathbf{z})$ , as well as an arc  $\lambda$  connecting two points  $x_1, x_2 \in \Sigma$ , we obtain a map

$$\mathcal{A}_\lambda: CF(\mathcal{L}_\alpha, \mathcal{L}_\beta) \rightarrow CF(\mathcal{L}_\alpha, \mathcal{L}_\beta)$$

as in Section 13.3, satisfying

$$\partial_{\text{Mor}}(\mathcal{A}_\lambda) = E_1^\alpha + E_2^\alpha,$$

where  $E_i^\alpha$  denotes the product of the variables for the basepoints in the unique alpha degeneration containing  $x_i$ . Compare Lemma 13.13. We view the link surgery hypercube as a 2-dimensional hypercube by internalizing all axis directions except those of  $K_1$  and  $K_2$ . With this perspective, write

$$\mathcal{C}_\Lambda(L) = \begin{array}{ccc} \mathcal{C}_{(0,0)} & \xrightarrow{F^{K_1+F^{-K_1}}} & \mathcal{C}_{(1,0)} \\ \downarrow F^{K_2+F^{-K_2}} & \searrow F^{-K_1,-K_2} & \downarrow F^{K_2+F^{-K_2}} \\ \mathcal{C}_{(0,1)} & \xrightarrow{F^{K_1+F^{-K_1}}} & \mathcal{C}_{(1,1)} \end{array}$$

Write  $\phi_1$  for the point-pushing diffeomorphism which moves  $z_1$  to  $w_1$ , and write  $\phi_2$  for the map which moves  $z_2$  to  $w_2$ . Write

$$\lambda_{0,0} = \lambda, \quad \lambda_{(1,0)} = \phi_1(\lambda), \quad \lambda_{(0,1)} = \phi_2(\lambda), \quad \lambda_{(1,1)} = \phi_1(\phi_2(\lambda)).$$

We may adapt the above construction of a hypercube  $\mathcal{A}_\lambda$  in the setting of a fixed set of basepoints to the setting of the surgery hypercube, which has maps corresponding to basepoint moving maps. We obtain a diagram of the following form, which is a hypercube except for the length 1 relations along arrows labeled  $A_{\lambda_\varepsilon}$  (which instead satisfy  $[\partial, A_{\lambda_\varepsilon}] = U_1 + U_2$ ).

$$\begin{array}{ccccc} \mathcal{C}_{(0,0)} & \xrightarrow{F^{-K_1}} & \mathcal{C}_{(1,0)} & & \\ \downarrow F^{-K_2} & \searrow A_{\lambda_{0,0}} & \downarrow F^{-K_1} & \searrow A_{\lambda_{1,0}} & \\ \mathcal{C}_{(0,0)} & \xrightarrow{F^{-K_1}} & \mathcal{C}_{(1,0)} & & \\ \downarrow F^{-K_2} & \searrow h^{-K_1} & \downarrow F^{-K_2} & \searrow j^{-K_2} & \\ \mathcal{C}_{(0,1)} & \xrightarrow{F^{K_1}} & \mathcal{C}_{(1,1)} & & \\ \downarrow F^{-K_2} & \searrow A_{\lambda_{0,1}} & \downarrow F^{-K_1,-K_2} & \searrow A_{\lambda_{1,1}} & \\ \mathcal{C}_{(0,1)} & \xrightarrow{F^{-K_1}} & \mathcal{C}_{(1,1)} & & \end{array} \quad (13.21)$$

As a first step, we claim that all of the maps  $A_{\lambda_\varepsilon}$  are equal. To see this, note that  $A_{\lambda_{1,0}}$  is obtained by concatenating  $\lambda$  with the arc from  $z_1$  to  $w_1$  which goes through only beta curves. Similar arguments apply to the other length 1 maps  $A_{\lambda_\varepsilon}$  so we conclude that the length 1 maps satisfy

$$A_{\lambda_\varepsilon} = A_\lambda$$

for all  $\varepsilon \in \mathbb{E}_2$ .

We now consider the length 2 maps, we claim that  $h^{-K_i} = j^{-K_i}$  for  $i = \{1, 2\}$ . The argument is similar to the argument for the length 1 maps. Namely the maps  $h^{-K_2}$  and  $j^{-K_2}$  count the same holomorphic curves. Some of the curves contributing to  $h^{-K_2}$  are counted with a weight of  $a(\psi, \lambda)$  whereas the same curves are counted by  $a(\psi, \phi_1(\lambda))$  for  $j^{-K_2}$ . Since  $\phi_1(\lambda)$  is obtained by concatenating  $\lambda$  with an arc which passes through only beta curves, we see that  $a(\psi, \lambda) = a(\psi, \phi_1(\lambda))$ , so these expressions are equal. We conclude that  $h^{-K_i} = j^{-K_i}$ .

In particular, the diagram in Equation (13.21) induces a map  $H^1: \mathcal{X}_\Lambda(L, \mathcal{A})^\mathcal{L} \rightarrow \mathcal{X}_\Lambda(L, \mathcal{A})^\mathcal{L}$  by adapting the construction of Section 8.6. This map satisfies

$$\partial_{\text{Mor}}(H^1) = \text{id} \otimes (U_1 + U_2),$$

completing the proof when both components are alpha-parallel.

We now consider the case that  $K_1$  is alpha-parallel and  $K_2$  is beta-parallel. In this case, we must modify the map  $H^1$ . Recall that  $H^1$  was built from the map  $\mathcal{A}_\lambda$ . We instead replace this by a map  $H^1$  built from  $\mathcal{A}_\lambda + \mathcal{V}_2\Psi_{z_2}$ . In the present case, since  $K_1$  is alpha-parallel, we see that

$$A_{\lambda_{0,0}} = A_{\lambda_{1,0}} = A_\lambda,$$

by the same reasoning as in the previous case. In particular, if we view the complex as a 1-dimensional cone in the  $K_2$ -direction

$$\mathcal{C}_\Lambda(L, \mathcal{A}) = \text{Cone} \left( \mathcal{C}_0 \xrightarrow{F^{K_2} + F^{-K_2}} \mathcal{C}_1, \right)$$

then the internal differentials of  $\mathcal{C}_0$  and  $\mathcal{C}_1$  commute with  $\mathcal{A}_\lambda + \mathcal{V}_2\Psi_{z_2}: \mathcal{C}_i \rightarrow \mathcal{C}_i$ .

On the other hand, the point pushing map for  $K_2$  moves  $z_2$  to  $w_2$  through exactly the alpha circles which intersect the trace of  $K_2$  on the knot diagram. Hence

$$A_{\lambda_{0,1}} = A_{\lambda_{1,1}} = A_\lambda + A_{[K_2]}.$$

We conclude that

$$F^{-K_2} A_\lambda \simeq (A_\lambda + A_{[K_2]}) F^{-K_2}, \quad (13.22)$$

as maps from  $\mathcal{C}_0$  to  $\mathcal{C}_1$ . On the other hand, since  $F^{-K_2}$  moves  $z_2$  to  $w_2$ , we have

$$F^{-K_2} \mathcal{V}_2\Psi_{z_2} \simeq \mathcal{U}_2\Phi_{w_2} F^{-K_2}. \quad (13.23)$$

We recall from Lemma 13.28 that  $\mathcal{A}_{[K_2]} \simeq \mathcal{U}_2\Phi_{w_2} + \mathcal{V}_2\Psi_{z_2}$ , as endomorphisms of  $\mathcal{C}_0$ . Combining the relations in Equations 13.22, 13.23 with the equation for  $\mathcal{A}_{[K_2]}$ , we obtain

$$F^{-K_2} (\mathcal{A}_\lambda + \mathcal{V}_2\Psi_{z_2}) \simeq (\mathcal{A}_\lambda + \mathcal{V}_2\Psi_{z_2}) F^{-K_2},$$

as maps from  $\mathcal{C}_0$  to  $\mathcal{C}_1$ . Arranging these maps and homotopies into an endomorphism  $H^1$  of  $\mathcal{X}_\Lambda(L, \mathcal{A})^\mathcal{L}$ , we obtain that  $\partial_{\text{Mor}}(H^1) = \text{id} \otimes (U_1 + U_2)$ , completing the proof.  $\square$

#### 14. THE ALPHA-BETA TRANSFORMER

In this section, we describe a bimodule  $\kappa\mathcal{T}^\mathcal{K}$ , which we call the *alpha-beta transformer bimodule*. We will prove the following:

**Theorem 14.1.** *Suppose that  $L \subseteq S^3$  is a framed link with a distinguished component  $K$ . Let  $\mathcal{A}$  be a system of arcs for  $L$  such that the arc for  $K$  is alpha-parallel. Let  $\mathcal{A}'$*

be a system of arcs where  $K$  is beta-parallel, but otherwise the arcs are the same as  $\mathcal{A}$ . Then

$$\mathcal{X}_\Lambda(L, \mathcal{A})^\mathcal{L} \simeq \mathcal{X}_\Lambda(L, \mathcal{A}')^\mathcal{L} \hat{\boxtimes}_{\mathcal{K}} \mathcal{T}^\mathcal{K}.$$

The same formula holds if we switch the roles of  $\mathcal{A}$  and  $\mathcal{A}'$ .

**14.1. The bimodule.** The bimodule  $\mathcal{T}$  has rank 1 over  $\mathbf{I}$ , and has  $\delta_1^1 = 0$ . The map  $\delta_2^1$  is the unique  $\mathbf{I}$ -linear map which satisfies

$$\delta_2^1(a, (i_0 + i_1)) = (i_0 + i_1) \otimes a,$$

for  $a \in \mathcal{K}$ . (This coincides with the identity bimodule).

Additionally, there is a  $\delta_4^1$  term, which is non-vanishing on terms of the form  $a|b|f\tau g|i_0$ , where  $f, g, a$  and  $b$  are concentrated in a single idempotent, and which vanishes on other elementary tensors. On such elements, we have the formula

$$\delta_4^1(a, b, f\tau g, i_0) = i_1 \otimes (\partial_{\mathcal{W}}(a) \cdot \partial_{\mathcal{V}}(b) \cdot f\tau g).$$

**Lemma 14.2.**  $\mathcal{K}\mathcal{T}^\mathcal{K}$  satisfies the  $DA$ -bimodule relations.

*Proof.* The only interesting structure relations to be verified are the ones with 5 inputs. There are only two non-vacuous relations to be verified, which are those for sequences of the form  $(a, b, c, \tau, i_0)$  and those of the form  $(a, b, \tau, c, i_0)$ .

The structure relations for sequences of the form  $(a, b, \tau, c, i_0)$  are straightforward, so we consider the tuple  $(a, b, c, \tau, i_0)$ . The structure diagrams with non-trivial contribution are the following:

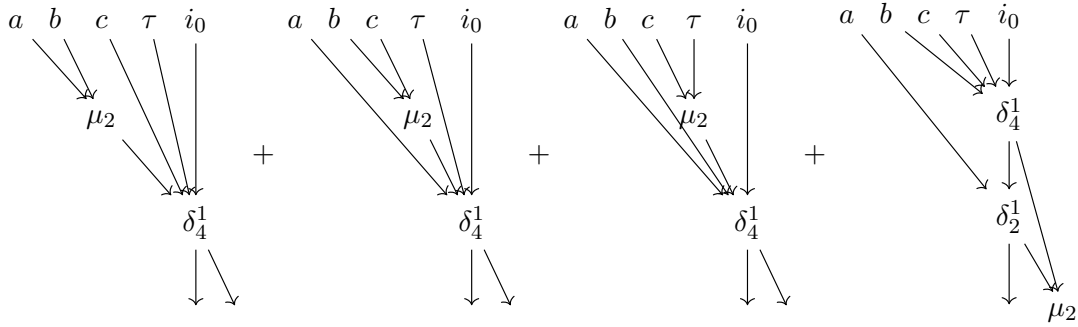

The vanishing of the above equation follows from the algebraic relation

$$\partial_{\mathcal{W}}(ab)\partial_{\mathcal{V}}(c) + \partial_{\mathcal{W}}(a)\partial_{\mathcal{V}}(bc) + \partial_{\mathcal{W}}(a)\partial_{\mathcal{V}}(b)c + a\partial_{\mathcal{W}}(b)\partial_{\mathcal{V}}(c) = 0,$$

which is straightforward to verify. □

*Remark 14.3.* There is another perspective which makes the  $DA$ -bimodule relations more straightforward to verify.

**14.2. Basepoint actions as  $A_\infty$ -morphisms.** We now give a helpful reformulation of algebraic basepoint actions in terms of  $A_\infty$ -morphisms. This framework helps us understand the structure maps appearing in the alpha-to-beta transformer bimodule.

If  $C$  is a free  $\mathbb{F}[U]$ -module, then there is natural basepoint action  $\Phi_U: C \rightarrow C$ , defined as follows. We pick a free  $\mathbb{F}[U]$  basis  $B$  of  $C$ . If  $\mathbf{x} \in B$ , then we write

$\partial(\mathbf{x}) = \sum_{\mathbf{y} \in B} c_{\mathbf{y}, \mathbf{x}} U^{n_{\mathbf{y}, \mathbf{x}}} \cdot \mathbf{y}$  where  $c_{\mathbf{y}, \mathbf{x}} \in \mathbb{F}$  and  $n_{\mathbf{y}, \mathbf{x}} \in \mathbb{N}$ . The map  $\Phi_U$  is defined via the formula

$$\Phi_U(\mathbf{x}) = \sum_{\mathbf{y} \in B} n_{\mathbf{y}, \mathbf{x}} c_{\mathbf{y}, \mathbf{x}} U^{n_{\mathbf{y}, \mathbf{x}}-1} \cdot \mathbf{y}. \quad (14.1)$$

The induced map  $(\Phi_U)_*$  on  $H_*(C)$  is trivial (cf. Lemma 13.11), though the map  $\Phi_U$  is often not null-homotopic through an  $\mathbb{F}[U]$ -equivariant homotopy.

Since  $C$  is free and the differential is  $\mathbb{F}[U]$ -equivariant, we may view  $C$  as corresponding to a type- $D$  module  $C^{\mathbb{F}[U]}$ . Of course,

$$C^{\mathbb{F}[U]} \cong C^{\mathbb{F}[U]} \boxtimes_{\mathbb{F}[U]} [\mathbb{I}]^{\mathbb{F}[U]}.$$

There is a  $DA$ -bimodule endomorphism  $\phi_*^1$  of  ${}_{\mathbb{F}[U]}[\mathbb{I}]^{\mathbb{F}[U]}$  defined as follows. We set  $\phi_1^1 = 0$ , and we set

$$\phi_2^1(\alpha, 1) = 1 \otimes \partial_U(\alpha).$$

We set  $\phi_j^1 = 0$  if  $j > 2$ . The  $DA$ -bimodule relations are straightforward to verify, and easily translated into the Leibniz rule for derivatives.

**Lemma 14.4.** *The map  $\Phi_U$  in Equation (14.1), viewed as a type- $D$  morphism*

$$\Phi_U: C^{\mathbb{F}[U]} \rightarrow C^{\mathbb{F}[U]}$$

*satisfies*

$$\Phi_U := \mathbb{I}_C \boxtimes \phi_*^1.$$

The proof is immediate.

We recall that the map  $\Phi_U$  satisfies  $\Phi_U^2 \simeq 0$ . See [Sar15, Lemma 3.4]. It is helpful to note that this relation may be translated into a fact about the  $DA$ -bimodule endomorphism  $\phi_*^1$ :

**Lemma 14.5.** *The  $DA$ -bimodule morphism  $\phi_*^1$  satisfies*

$$\phi_*^1 \circ \phi_*^1 \simeq 0.$$

*Proof.* We define a  $DA$ -bimodule endomorphism

$$H_*^1: {}_{\mathbb{F}[U]}[\mathbb{I}]^{\mathbb{F}[U]} \rightarrow {}_{\mathbb{F}[U]}[\mathbb{I}]^{\mathbb{F}[U]}$$

via the formula  $H_1^1 = 0$  and

$$H_2^1(U^n, 1) = 1 \otimes \frac{n(n-1)}{2} U^{n-2}.$$

The map  $\partial_{\text{Mor}}(H_*^1)$  has three summands, shown as graphs below.

$$\partial_{\text{Mor}}(H_*^1) = \begin{array}{c} \begin{array}{c} \downarrow \downarrow \\ \mu_2 \\ \downarrow \\ H_2^1 \\ \downarrow \quad \searrow \\ \mu_2 \end{array} + \begin{array}{c} \downarrow \downarrow \\ H_2^1 \\ \downarrow \quad \searrow \\ \delta_2^1 \\ \downarrow \quad \searrow \\ \mu_2 \end{array} + \begin{array}{c} \downarrow \downarrow \\ \delta_2^1 \\ \downarrow \quad \searrow \\ H_2^1 \\ \downarrow \quad \searrow \\ \mu_2 \end{array} \end{array}$$



Hence

$$\begin{aligned}
& \partial_{\text{Mor}}(H_*^1)(U^n, U^m, 1) \\
&= 1 \otimes \frac{n(n-1) + m(m-1) + (n+m)(n+m-1)}{2} U^{n+m-2} \\
&\equiv 1 \otimes nm U^{n+m-2} \pmod{2} \\
&= (\phi_* \circ \phi_*)_2^1(U^n, U^m, 1)
\end{aligned}$$

completing the proof.  $\square$

We will also need to consider analogous basepoint actions on complexes over the 2-variable polynomial ring  $\mathbb{F}[\mathcal{U}, \mathcal{V}]$ . In this case, we may define two  $DA$ -bimodule endomorphisms of  $\mathbb{F}[\mathcal{U}, \mathcal{V}][\mathbb{I}]^{\mathbb{F}[\mathcal{U}, \mathcal{V}]}$ , denoted  $\phi_*^1$  and  $\psi_*^1$ , which differentiate with respect to  $\mathcal{U}$  and  $\mathcal{V}$ , respectively. Lemma 14.5 adapts to show that  $\phi_*^1 \circ \phi_*^1 \simeq 0$  and  $\psi_*^1 \circ \psi_*^1 \simeq 0$ . Additionally, we have the following:

**Lemma 14.6.** *As endomorphisms of  $\mathbb{F}[\mathcal{U}, \mathcal{V}][\mathbb{I}]^{\mathbb{F}[\mathcal{U}, \mathcal{V}]}$ , we have*

$$\phi_*^1 \circ \psi_*^1 \simeq \psi_*^1 \circ \phi_*^1.$$

*Proof.* We define a  $DA$ -bimodule endomorphism  $H_*^1$  of  $\mathbb{F}[\mathcal{U}, \mathcal{V}][\mathbb{I}]^{\mathbb{F}[\mathcal{U}, \mathcal{V}]}$  whose only non-vanishing action is given by the formula

$$H_2(\alpha, 1) = 1 \otimes \partial_{\mathcal{U}, \mathcal{V}}^2(\alpha),$$

where  $\partial_{\mathcal{U}, \mathcal{V}}^2 = \partial_{\mathcal{U}}(\partial_{\mathcal{V}}(a))$ . We observe the equality

$$\partial_{\text{Mor}}(H_*^1) = \phi_*^1 \circ \psi_*^1 + \psi_*^1 \circ \phi_*^1$$

which follows from the easily verified relation

$$\partial_{\mathcal{U}, \mathcal{V}}^2(a \cdot b) + a \cdot \partial_{\mathcal{U}, \mathcal{V}}^2(b) + \partial_{\mathcal{U}, \mathcal{V}}^2(a) \cdot b = \partial_{\mathcal{U}}(a) \cdot \partial_{\mathcal{V}}(b) + \partial_{\mathcal{V}}(a) \cdot \partial_{\mathcal{U}}(b).$$

$\square$

**14.3. The transformer as a mapping cone bimodule.** In order to efficiently prove statements about the transformer bimodule, it is helpful to discuss some generalities about constructing bimodules. If  $f_*^1: \mathcal{A}M^{\mathcal{B}} \rightarrow \mathcal{A}N^{\mathcal{B}}$  is a morphism of  $DA$ -bimodules such that  $\partial_{\text{Mor}}(f_*^1) = 0$ , then we may construct another bimodule  $\text{Cone}(f_*^1)$  which is also a  $DA$ -bimodule. If  $f_*^1$  and  $g_*^1$  are two homotopic bimodule morphisms, then  $\text{Cone}(f_*^1)$  and  $\text{Cone}(g_*^1)$  are homotopy equivalent.

It is helpful to understand that the transformer bimodule is a mapping cone bimodule. For  $\varepsilon \in \{0, 1\}$ , write  $\kappa[\mathbf{i}_\varepsilon]^{\mathcal{K}}$  denote  $\mathbf{I}_\varepsilon \cdot \kappa[\mathbb{I}]^{\mathcal{K}} \cdot \mathbf{I}_\varepsilon$ , with the restriction of the structure map from the identity bimodule  $\kappa[\mathbb{I}]^{\mathcal{K}}$ . There are two morphisms

$$s_*^1, t_*^1: \kappa[\mathbf{i}_0]^{\mathcal{K}} \rightarrow \kappa[\mathbf{i}_1]^{\mathcal{K}}$$

as follows. The map  $t_j^1 = 0$  for  $j \neq 2$ , and  $t_2^1(f\tau, i_0) = i_1 \otimes f\tau$  and  $t_2^1(f\sigma, i_0) = 0$ . The map  $s_*^1$  is similar, but with the roles of  $\sigma$  and  $\tau$  reversed. It is not hard to see that the  $DA$ -bimodule morphisms  $s_*^1$  and  $t_*^1$  are cycles. Furthermore

$$\kappa[\mathbb{I}]^{\mathcal{K}} = \text{Cone}(s_*^1 + t_*^1: \kappa[\mathbf{i}_0]^{\mathcal{K}} \rightarrow \kappa[\mathbf{i}_1]^{\mathcal{K}}).$$

The  $A_\infty$  basepoint actions  $\phi_*^1$  and  $\psi_*^1$  from Section 14.2 also induce endomorphisms of  $\kappa[\mathbf{i}_\varepsilon]^\mathcal{K}$  for  $\varepsilon \in \{0, 1\}$ . In particular, we observe that the transformer bimodule may be described as

$$\kappa\mathcal{T}^\mathcal{K} = \text{Cone}(s_*^1 + (\text{id} + \phi_*^1 \circ \psi_*^1) \circ t_*^1: \kappa[\mathbf{i}_0]^\mathcal{K} \rightarrow \kappa[\mathbf{i}_1]^\mathcal{K}).$$

*Remark 14.7.* The above perspective gives a more streamlined proof that  $\kappa\mathcal{T}^\mathcal{K}$  satisfies the  $DA$ -bimodule structure relations. Indeed, it is sufficient to verify that  $\phi_*^1$ ,  $\psi_*^1$ ,  $s_*^1$  and  $t_*^1$  are cycles, which is easy to verify.

**14.4. Properties of the transformer bimodule.** In this section, we prove some important properties of the transformer bimodule.

We begin by showing that in analogy to Sarkar's map for a Dehn twist [Sar15], the transformer bimodule is involutive:

**Lemma 14.8.** *The transformer bimodule satisfies*

$$\kappa\mathcal{T}^\mathcal{K} \hat{\boxtimes} \kappa\mathcal{T}^\mathcal{K} \simeq \kappa[\mathbb{I}]^\mathcal{K}.$$

*Proof.* We compute that  $\kappa\mathcal{T}^\mathcal{K} \hat{\boxtimes} \kappa\mathcal{T}^\mathcal{K}$  is equal to the mapping cone bimodule

$$\text{Cone}(s_*^1 + (\text{id} + \phi_*^1 \circ \psi_*^1 \circ \phi_*^1 \circ \psi_*^1) \circ t_*^1: \kappa[\mathbf{i}_0]^\mathcal{K} \rightarrow \kappa[\mathbf{i}_1]^\mathcal{K}).$$

On the other hand,  $\phi_*^1 \circ \psi_*^1 \circ \phi_*^1 \circ \psi_*^1 \simeq 0$  by Lemmas 14.5 and 14.6. Hence,  $\kappa\mathcal{T}^\mathcal{K} \hat{\boxtimes} \kappa\mathcal{T}^\mathcal{K}$  is homotopy equivalent to  $\text{Cone}(s_*^1 + t_*^1)$ , which is  $\kappa[\mathbb{I}]^\mathcal{K}$ .  $\square$

Next, we consider the tensor product of the transformer with the modules for a solid torus:

**Lemma 14.9.** *The transformer bimodule satisfies*

$$\mathcal{D}_\lambda^\mathcal{K} \hat{\boxtimes} \kappa\mathcal{T}^\mathcal{K} \simeq \mathcal{D}_\lambda^\mathcal{K} \quad \text{and} \quad \kappa\mathcal{T}^\mathcal{K} \hat{\boxtimes} \kappa\mathcal{D}_\lambda^{\mathbb{F}[U]} \simeq \kappa\mathcal{D}_\lambda^{\mathbb{F}[U]}.$$

*Proof.* The relation  $\mathcal{D}_\lambda^\mathcal{K} \hat{\boxtimes} \kappa\mathcal{T}^\mathcal{K} \simeq \mathcal{D}_\lambda^\mathcal{K}$  is trivial, so we focus on the relation  $\kappa\mathcal{T}^\mathcal{K} \hat{\boxtimes} \kappa\mathcal{D}_\lambda^{\mathbb{F}[U]} \simeq \kappa\mathcal{D}_\lambda^{\mathbb{F}[U]}$ . To simplify the notation, it is easier to construct a homotopy equivalence

$$\kappa\mathcal{T}^\mathcal{K} \hat{\boxtimes} \kappa[\mathcal{D}_\lambda]_{\mathbb{F}[U]} \simeq \kappa[\mathcal{D}_\lambda]_{\mathbb{F}[U]},$$

though the maps we write down can be easily adapted to give the statement about  $DA$ -bimodules, since they are strictly  $\mathbb{F}[U]$ -equivariant.

We will view both bimodules as mapping cone bimodules, in the sense of Section 14.3. Define

$$\kappa[\mathbf{d}_\varepsilon]_{\mathbb{F}[U]} := \mathbf{I}_\varepsilon \cdot \kappa[\mathcal{D}_\lambda]_{\mathbb{F}[U]},$$

for  $\varepsilon \in \{0, 1\}$ . We observe that both  $\kappa\mathcal{T}^\mathcal{K} \hat{\boxtimes} \kappa[\mathcal{D}_\lambda]_{\mathbb{F}[U]}$  and  $\kappa[\mathcal{D}_\lambda]_{\mathbb{F}[U]}$  are the mapping cones of type- $AS$  maps from  $\mathbf{d}_0$  to  $\mathbf{d}_1$ . Indeed, there are type- $AA$  maps

$$\Sigma_*, T_*: \kappa[\mathbf{d}_0]_{\mathbb{F}[U]} \rightarrow \kappa[\mathbf{d}_1]_{\mathbb{F}[U]},$$

where  $\Sigma_{1,1,0}(f\sigma, \mathbf{x}) = m_2(f\sigma, \mathbf{x})$  (where  $m_2$  is the action from  $\mathcal{D}_\lambda$ ) and  $T_{1,1,0}(f\tau, \mathbf{x}) = m_2(f\tau, \mathbf{x})$ . Furthermore,  $\Sigma_{1,1,0}(f\tau, \mathbf{x}) = 0$  and  $T_{1,1,0}(f\sigma, \mathbf{x}) = 0$ . Also  $\Sigma_*$  and  $T_*$  vanish on other configurations of inputs. It is straightforward to verify that  $\Sigma_*$  and  $T_*$  are cycles. Additionally,

$$\kappa[\mathcal{D}_\lambda]_{\mathbb{F}[U]} = \text{Cone}(\Sigma_* + T_*: \kappa[\mathbf{d}_0]_{\mathbb{F}[U]} \rightarrow \kappa[\mathbf{d}_1]_{\mathbb{F}[U]}) \quad (14.2)$$

and

$$\kappa \mathcal{T}^{\mathcal{K}} \hat{\boxtimes} \kappa[\mathcal{D}\lambda]_{\mathbb{F}[U]} = \text{Cone}(\Sigma_* + (\text{id} + \phi_* \circ \psi_*) \circ T_* : \kappa[\mathbf{d}_0]_{\mathbb{F}[U]} \rightarrow \kappa[\mathbf{d}_1]_{\mathbb{F}[U]}). \quad (14.3)$$

We observe that

$$\phi_* \circ \psi_* \simeq \mathcal{V}^{-1} \phi_* \circ (\mathcal{U} \phi_* + \mathcal{V} \psi_*),$$

as endomorphisms of  $[\mathbf{d}_1]$ , by Lemma 14.5.

We write  $\partial_{\mathcal{W}} = \mathcal{U} \partial_{\mathcal{U}} + \mathcal{V} \partial_{\mathcal{V}}$ . We define an endomorphism  $J_*$  of  $\kappa[\mathbf{d}_1]_{\mathbb{F}[U]}$  via the formula

$$J_{0,1,0}(\mathbf{x}) = \partial_{\mathcal{W}}(\mathbf{x}).$$

Observe that  $J_{0,1,0}$  commutes with the right action of  $U$ . Furthermore, the Leibniz rule implies that

$$\partial_{\text{Mor}}(J_*) = \mathcal{U} \phi_* + \mathcal{V} \psi_*,$$

as endomorphisms of  $[\mathbf{d}_1]$ . We conclude that  $\phi_* \circ \psi_* \simeq 0$  as endomorphisms of  $[\mathbf{d}_1]$ , and hence the two mapping cones in Equations (14.2) and (14.3) are homotopy equivalent. The proof is complete.  $\square$

**14.5. Proof of Theorem 14.1.** We now prove Theorem 14.1, which states that changing from an alpha-parallel arc to a beta-parallel arc may be achieved by tensoring with the transformer bimodule  $\kappa \mathcal{T}^{\mathcal{K}}$ .

*Proof of Theorem 14.1.* We use our basepoint moving map formula from Corollary 13.5.

Let  $\mathcal{A}$  be an arc system for  $L \subseteq S^3$ , and assume that  $K \subseteq L$  is a component whose arc  $\lambda$  is beta-parallel. Let  $\lambda'$  denote an arc for  $K$  which is alpha-parallel, and let  $\mathcal{A}'$  denote the arc-system which has  $\lambda'$  in place of  $\lambda$ .

We pick a Heegaard diagram  $\mathcal{H} = (\Sigma, \boldsymbol{\alpha}, \boldsymbol{\beta}, \mathbf{w}, \mathbf{z})$  so that all of the arcs of  $\mathcal{A}$  are embedded in  $\Sigma$  and pairwise disjoint. We assume the arc  $\lambda$  is disjoint from  $\boldsymbol{\beta}$ . The arc  $\lambda'$  may also be viewed as being embedded on  $\Sigma$ . With respect to this embedding,  $\lambda'$  is disjoint from  $\boldsymbol{\alpha}$ . In principle  $\lambda'$  might intersect some of the other arcs of  $\mathcal{A}$ . However, by stabilizing the Heegaard diagram  $(\Sigma, \boldsymbol{\alpha}, \boldsymbol{\beta}, \mathbf{w}, \mathbf{z})$ , we may assume that  $\lambda'$  is disjoint from all of the other arcs of  $\mathcal{A}$ .

We build a hyperbox of Heegaard diagrams using the diagram  $\mathcal{H}$  as the initial diagram. If  $K_i \subseteq L$ , then the  $K_i$  direction of this hypercube involves the composition of a tautological diffeomorphism map to move  $z_i$  along  $\lambda_i$ , followed by a holomorphic polygon counting maps which change the alpha and beta curves back to their original position. We do this in each axis direction to build a  $\sigma$ -basic system used for the link surgery formula.

For this  $\sigma$ -basic system, we may change  $\lambda$  to  $\lambda'$  by composing the  $K$  direction with a final basepoint moving hypercube which moves  $w$  in a loop along the curve  $K = \lambda' * \lambda^{-1}$ . Corollary 13.5 implies that the effect on the link surgery hypercube is to replace  $F^{-K}$  (the sum of the hypercube maps ranging over all sublinks of  $L$  containing  $-K$ ) with the map  $(\text{id} + \mathcal{V}^{-1} \mathcal{A}_{[K]} \circ \Phi_w) \circ F^{-K}$ .

The map  $(\text{id} + \mathcal{V}^{-1} \mathcal{A}_{[K]} \circ \Phi_w)$  is viewed as an endomorphism of the  $(\ell-1)$ -dimensional subcube of  $\mathcal{C}_{\Lambda}^1(L, \mathcal{A}) \subseteq \mathcal{C}_{\Lambda}(L, \mathcal{A})$  which has  $K$ -component 1. On this subcube, the arc  $\lambda'$  intersects only beta curves, and  $\lambda$  intersects only alpha curves. By Lemma 13.28, we have

$$\mathcal{A}_{[K]} \simeq \mathcal{U} \Phi_w + \mathcal{V} \Psi_z,$$

as endomorphisms of  $\mathcal{C}_\Lambda^1(L, \mathcal{A})$ . Hence

$$\text{id} + \mathcal{V}^{-1} \Phi_w \mathcal{A}_{[K]} = \text{id} + \mathcal{V}^{-1} \Phi_w (\mathcal{W} \Phi_w + \mathcal{V} \Psi_z) \simeq \text{id} + \Phi_w \Psi_z,$$

since  $\Phi_w^2 \simeq 0$ . In particular, it follows that if we write

$$\mathcal{C}_\Lambda(L, \mathcal{A}) \cong \text{Cone} \left( \mathcal{C}_\Lambda^0(L, \mathcal{A}) \xrightarrow{F^K + F^{-K}} \mathcal{C}_\Lambda^1(L, \mathcal{A}) \right)$$

then  $\mathcal{C}_\Lambda(L, \mathcal{A}')$  is homotopic to

$$\text{Cone} \left( \mathcal{C}_\Lambda^0(L, \mathcal{A}) \xrightarrow{F^K + (\text{id} + \Phi_w \Psi_z) F^{-K}} \mathcal{C}_\Lambda^1(L, \mathcal{A}) \right).$$

On the level of type- $D$  structures over  $\mathcal{L}$ , the above complex is the tensor product of  $\mathcal{X}_\Lambda(L, \mathcal{A})^\mathcal{L}$  with the transformer bimodule  ${}_\kappa \mathcal{T}^\mathcal{K}$  (cf. Lemma 14.4), completing the proof.  $\square$

### 15. THE PAIR-OF-PANTS BIMODULES

In this section, we describe two bimodules  ${}_{\kappa|\kappa} W_l^\mathcal{K}$  and  ${}_{\kappa|\kappa} W_r^\mathcal{K}$ . The bimodules are related by the transformer bimodule

$${}_{\kappa|\kappa} W_l^\mathcal{K} \hat{\boxtimes} {}_\kappa \mathcal{T}^\mathcal{K} \simeq {}_{\kappa|\kappa} W_r^\mathcal{K}.$$

We call these the *pair-of-pants* bimodules.

*Remark 15.1.* In a future work [Zem] we will prove that  $W_r$  and  $W_l$  are the bordered invariants of  $S^1 \times P$ , where  $P$  denotes a 2-dimensional disk with 2 subdisks removed for various choices of arc systems. Note that a surgery description of  $S^1 \times P$  is given in Figure 15.1.

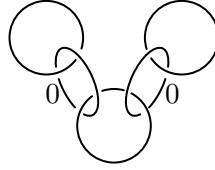

FIGURE 15.1. A Kirby diagram for  $S^1 \times P$ . The components marked 0 are surgered, while a tubular neighborhood of the unmarked components is removed.

After defining these bimodules and proving several basic properties, we will prove the following:

**Theorem 15.2.** *Suppose that  $L_1, L_2 \subseteq S^3$  are framed links with distinguished components  $K_1 \subseteq L_1$  and  $K_2 \subseteq L_2$ . Let  $\mathcal{A}_1$  and  $\mathcal{A}_2$  be systems of arcs for  $L_1$  and  $L_2$  such that  $\mathcal{X}_{\Lambda_1}(L_1, \mathcal{A}_1)^{\mathcal{K} \otimes \mathcal{L}_{n-1}}$  and  $\mathcal{X}_{\Lambda_2}(L_2, \mathcal{A}_2)^{\mathcal{K} \otimes \mathcal{L}_{m-1}}$ . Suppose that the arc for  $K_1$  is alpha parallel and the arc for  $K_2$  is beta parallel. Let  $\mathcal{A}_\alpha$  and  $\mathcal{A}_\beta$  be the system of arcs for  $L_1 \# L_2$  which use an alpha-parallel (resp. beta-parallel) arc for  $K_1$  (resp.  $K_2$ ). Then*

$$(\mathcal{X}_{\Lambda_1}(L_1, \mathcal{A}_1)^{\mathcal{K} \otimes \mathcal{L}_{n-1}}, \mathcal{X}_{\Lambda_1}(L_2, \mathcal{A}_2)^{\mathcal{K} \otimes \mathcal{L}_{m-1}}) \hat{\boxtimes} {}_{\kappa|\kappa} W_l^\mathcal{K} \simeq \mathcal{X}_{\Lambda_1 + \Lambda_2}(L_1 \# L_2, \mathcal{A}_\alpha)^{\mathcal{L}_{n+m-1}}$$

and

$$(\mathcal{X}_{\Lambda_1}(L_1, \mathcal{A}_1)^{\mathcal{K} \otimes \mathcal{L}_{n-1}}, \mathcal{X}_{\Lambda_1}(L_2, \mathcal{A}_2)^{\mathcal{K} \otimes \mathcal{L}_{m-1}}) \hat{\boxtimes} {}_{\kappa|\kappa} W_r^\mathcal{K} \simeq \mathcal{X}_{\Lambda_1 + \Lambda_2}(L_1 \# L_2, \mathcal{A}_\beta)^{\mathcal{L}_{n+m-1}}.$$

15.1. **The  $W_r$  and  $W_l$  bimodules.** We now define the  $W_l$  and  $W_r$  bimodules. We consider  $W_r$  first. This bimodule has a  $\delta_3^1$  which is identical to the merge module  $M$ . Additionally, there is a  $\delta_5^1$ , determined by the following formula:

$$\delta_5^1(a|b, a'|b', 1|\tau, \tau|1, i_0) = i_1 \otimes \mathcal{V}^{-1} \partial_{\mathcal{U}}(ab) a' (\mathcal{U} \partial_{\mathcal{U}} + \mathcal{V} \partial_{\mathcal{V}}) (b') \tau. \quad (15.1)$$

In the above,  $a, b, a', b' \in \mathbf{I}_1 \cdot \mathcal{K} \cdot \mathbf{I}_1$ .

The module  $W_l$  is similar, except has

$$\delta_5^1(a|b, a'|b', 1|\tau, \tau|1, i_0) = i_1 \otimes \mathcal{V}^{-1} \partial_{\mathcal{U}}(ab) b' (\mathcal{U} \partial_{\mathcal{U}} + \mathcal{V} \partial_{\mathcal{V}}) (a') \tau.$$

**Lemma 15.3.**  $\kappa|_{\mathcal{K}} W_l^{\mathcal{K}}$  and  $\kappa|_{\mathcal{K}} W_r^{\mathcal{K}}$  satisfy the  $DA$ -bimodule structure relations. Furthermore, both are split Alexander bimodules when we give the incoming algebra factors the discrete partition.

*Proof.* We consider the structure relations first. We take the perspective of mapping cone bimodules from Section 14.3. We begin by considering the merge module  $\kappa|_{\mathcal{K}} M^{\mathcal{K}}$ . We define bimodules  $\kappa|_{\mathcal{K}}[\mathbf{m}_\varepsilon]^{\mathcal{K}}$  for  $\varepsilon \in \{0, 1\}$  by

$$(\mathbf{I}_\varepsilon \otimes \mathbf{I}_\varepsilon) \cdot \kappa|_{\mathcal{K}} M^{\mathcal{K}} \cdot \mathbf{I}_\varepsilon.$$

The bimodule structure relations are easily seen to be satisfied. There are two  $DA$ -bimodule morphisms

$$\mathcal{S}_*^1, \mathcal{T}_*^1: \kappa|_{\mathcal{K}}[\mathbf{m}_0]^{\mathcal{K}} \rightarrow \kappa|_{\mathcal{K}}[\mathbf{m}_1]^{\mathcal{K}}$$

as follows. We set  $\mathcal{S}_j^1 = 0$  if  $j \neq 3$ . We set  $\mathcal{S}_3^1(1|\sigma, \sigma|1, i_0) = i_1 \otimes \sigma$ . The map  $\mathcal{T}_*^1$  is similar, but with  $\tau$  replacing  $\sigma$ . The  $DA$  bimodule endomorphisms  $\mathcal{S}_*^1$  and  $\mathcal{T}_*^1$  are easily seen to be cycles. Furthermore,

$$\kappa|_{\mathcal{K}} M^{\mathcal{K}} = \text{Cone}(\mathcal{S}_*^1 + \mathcal{T}_*^1: \kappa|_{\mathcal{K}}[\mathbf{m}_0]^{\mathcal{K}} \rightarrow \kappa|_{\mathcal{K}}[\mathbf{m}_1]^{\mathcal{K}}).$$

Note that we may form four  $DA$ -bimodule endomorphisms  $\phi_*^l, \phi_*^r, \psi_*^l$  and  $\psi_*^r$  of  $\kappa|_{\mathcal{K}}[\mathbf{m}_1]^{\mathcal{K}}$  by adapting the construction from Section 14.2. Here  $\phi_*^l$  differentiates with respect to  $\mathcal{U}$  on the left factor of  $\mathcal{K} \otimes \mathcal{K}$ , while  $\phi_*^r$  differentiates with respect to  $\mathcal{U}$  on the right factor. We may also view these maps as endomorphisms of  $\kappa|_{\mathcal{K}}[\mathbf{m}_1]^{\mathcal{K}}$  by boxing with the identity map on  $[\mathbf{m}_1]$ . With respect to the above notation, we observe that

$$\kappa|_{\mathcal{K}} W_l^{\mathcal{K}} = \text{Cone} \left( [\mathbf{m}_0] \xrightarrow{\mathcal{S}_*^1 + (\text{id} + \mathcal{V}^{-1}(\phi_*^l + \phi_*^r) \circ (\mathcal{U} \phi_*^l + \mathcal{V} \psi_*^l)) \circ \mathcal{T}_*^1} [\mathbf{m}_1] \right) \quad (15.2)$$

The map

$$(\text{id} + \mathcal{V}^{-1}(\phi_*^l + \phi_*^r) \circ (\mathcal{U} \phi_*^l + \mathcal{V} \psi_*^r)) \circ \mathcal{T}_*^1$$

is a cycle since it is the composition of cycles. Similarly,  $\mathcal{S}_*^1$  is a cycle by direct computation. Hence the  $DA$ -bimodule relations are satisfied for  $\kappa|_{\mathcal{K}} W_l^{\mathcal{K}}$ . The same argument works for  $\kappa|_{\mathcal{K}} W_r^{\mathcal{K}}$ .

Finally, the claim about split continuity is proven by an easy modification of the proof for the merge module, from Lemma 8.3.  $\square$

15.2. **Proof of Theorem 15.2.** We now give a proof of Theorem 15.2:

*Proof of Theorem 15.2.* The proof is based on our formula for changing the path in the link surgery formula Corollary 13.5. It is easier to analyze the surgery hypercubes, instead of their interpretation as type- $D$  modules, so we focus on the statement in terms of hypercube complexes first.

Letting  $K_1 \subseteq L_1$  and  $K_2 \subseteq L_2$  be the special components, and suppose that  $\mathcal{A}_1$  and  $\mathcal{A}_2$  are systems of arcs such that  $K_1$  has an alpha parallel arc and  $K_2$  has a beta-parallel arc. We use the meridional  $\sigma$ -basic systems considered in Section 9.3, which we assume are algebraically rigid. These were constructed in Lemma 9.7. By Theorem 12.1, we know that

$$\begin{aligned} & \mathcal{C}_{\Lambda_1 + \Lambda_2}(L_1 \# L_2, \mathcal{A}_1 \# \mathcal{A}_2) \\ & \cong \text{Cone} \left( \mathcal{C}^0(L_1) \otimes \mathcal{C}^0(L_2) \xrightarrow{F^{K_1} | F^{K_2} + F^{-K_1} | F^{-K_2}} \mathcal{C}^1(L_1) \otimes \mathcal{C}^1(L_2) \right) \end{aligned}$$

(Recall that we are writing  $F^{\pm K_i}$  for the sum of all surgery maps for oriented sublinks of  $L_i$  which contain  $\pm K_i$ ).

The above surgery hypercube is for the system of arcs  $\mathcal{A}_1 \# \mathcal{A}_2$ . The arc for  $K_1 \# K_2$  is the co-core of the connected sum band. The present statement instead involves  $\sigma$ -basic systems of Heegaard diagrams for  $L_1 \# L_2$  which use an alpha or beta parallel arc on  $K_1 \# K_2$ . If we want to change the arc to be alpha parallel, we may stack the above hypercube for  $\mathcal{C}_{\Lambda_1 + \Lambda_2}(L_1 \# L_2, \mathcal{A}_1 \# \mathcal{A}_2)$  with the hypercube for moving the basepoint in a loop following  $K_2$  in the subcube  $\mathcal{C}^1(L_1) \otimes \mathcal{C}^1(L_2)$ . We may compute this cube using Corollary 13.5. The effect on the resulting surgery hypercube is to replace  $F^{-K_1} | F^{-K_2}$  with the expression

$$(\text{id} + \mathcal{V}^{-1} \Phi_w \circ \mathcal{A}_{[K_2]})(F^{-K_1} | F^{-K_2}) : \mathcal{C}^1(L_1 \# L_2) \rightarrow \mathcal{C}^1(L_1 \# L_2).$$

We are using Proposition 11.8 to identify  $\mathcal{C}^\varepsilon(L_1 \# L_2) \cong \mathcal{C}^\varepsilon(L_1) \otimes \mathcal{C}^\varepsilon(L_2)$ , for  $\varepsilon \in \{0, 1\}$ . The differential on each  $\mathcal{C}^\varepsilon(L_1 \# L_2)$  is the tensor product differential, i.e.  $\partial_1 \otimes \text{id} + \text{id} \otimes \partial_2$ . In particular, the map  $\Phi_w$  on  $\mathcal{C}^\varepsilon(L_1 \# L_2)$  is intertwined with the map

$$\Phi_{w_1} \otimes \text{id} + \text{id} \otimes \Phi_{w_2}$$

under the connected sum isomorphism  $\mathcal{C}^1(L_1 \# L_2) \cong \mathcal{C}^1(L_1) \otimes \mathcal{C}^1(L_2)$ . Similarly, using the connected sum formulas for hypercubes in Propositions 10.1 and 11.8, it is a straightforward exercise to see that with respect to the isomorphism  $\mathcal{C}^1(L_1 \# L_2) \cong \mathcal{C}^1(L_1) \otimes \mathcal{C}^1(L_2)$  the map  $\mathcal{A}_{[K_2]}$  is intertwined with  $\text{id} \otimes \mathcal{A}_{[K_2]}$ . By Lemma 13.28 we see that

$$\text{id} \otimes \mathcal{A}_{[K_2]} = \text{id} \otimes (\mathcal{W} \Phi_{w_2} + \mathcal{V} \Psi_{z_2}),$$

as endomorphisms of  $\mathcal{C}^\varepsilon(L_1) \otimes \mathcal{C}^\varepsilon(L_2)$ . We conclude that

$$\Phi_w \circ \mathcal{A}_{[K_2]} = (\Phi_{w_1} \otimes \text{id} + \text{id} \otimes \Phi_{w_2}) \circ (\text{id} \otimes (\mathcal{W} \Phi_{w_2} + \mathcal{V} \Psi_{z_2})).$$

The addition of this term is encoded exactly by the extra  $\delta_5^1$  term in Equation (15.1) (cf. Lemma 14.4), so the proof is complete.  $\square$

**15.3. Relation to the AA-identity bimodule.** We recall that the AA-identity bimodule  $\kappa|\kappa[\mathbb{I}^\ominus]$  from Section 8.4 admits an extension to a bimodule

$$\kappa|\kappa[\mathbb{I}^\ominus]_{\mathbb{F}[U]}.$$

It follows from Theorem 12.1 and Proposition 13.2 that we may use  $\kappa|\kappa[\mathbb{I}^\ominus]$  to obtain a valid model of the link surgery formula when taking the connected sum of two links (i.e. the resulting hypercube has the correct module actions on the remaining knot components). It is not clear from this argument whether tensoring with  $\kappa|\kappa[\mathbb{I}^\ominus]_{\mathbb{F}[U]}$  gives a valid model. In this section, we show that indeed tensoring with  $\kappa|\kappa[\mathbb{I}^\ominus]_{\mathbb{F}[U]}$  produces a valid model, via the following algebraic result:

**Proposition 15.4.** *There is a homotopy equivalence*

$$\kappa|\kappa W_l^K \hat{\otimes} \kappa[\mathcal{D}_0]_{\mathbb{F}[U]} \simeq \kappa|\kappa[\mathbb{I}^\ominus]_{\mathbb{F}[U]}.$$

The same holds if we replace  $W_l$  with  $W_r$ .

The above proposition will be verified in several steps.

**Lemma 15.5.** (1) *As morphisms from  $\kappa[\mathbf{i}_0]^K$  to  $\kappa[\mathbf{i}_1]^K$ , we have*

$$\phi_* \circ s_*^1 \simeq s_*^1 \circ \phi_* \quad \text{and} \quad \psi_* \circ s_*^1 \simeq s_*^1 \circ \psi_*.$$

Similarly

$$t_*^1 \circ \phi_* \simeq \mathcal{V}^2 \psi_* \circ t_*^1 \quad \text{and} \quad t_*^1 \circ \psi_* \simeq \mathcal{V}^{-2} \phi_* \circ t_*^1.$$

(2) *As morphisms from  $\kappa|\kappa[\mathbf{m}_0]^K$  to  $\kappa|\kappa[\mathbf{m}_1]^K$  we have*

$$\phi_*^l \circ \mathcal{S}_*^1 \simeq \mathcal{S}_*^1 \circ \phi_*^l \quad \text{and} \quad \psi_*^l \circ \mathcal{S}_*^1 \simeq \mathcal{S}_*^1 \circ \psi_*^l$$

and

$$\mathcal{T}_*^1 \circ \phi_*^l \simeq \mathcal{V}^2 \psi_*^l \circ \mathcal{T}_*^1 \quad \text{and} \quad \mathcal{T}_*^1 \circ \psi_*^l \simeq \mathcal{V}^{-2} \phi_*^l \circ \mathcal{T}_*^1.$$

The same relations hold with  $\phi_*^r$  and  $\psi_*^r$  in place of  $\phi_*^l$  and  $\psi_*^l$ .

*Proof.* We begin with two algebraic relations on  $\mathcal{K}$ . If  $f \in \mathbf{I}_1 \cdot \mathcal{K} \cdot \mathbf{I}_1$  and  $g \in \mathbf{I}_0 \cdot \mathcal{K} \cdot \mathbf{I}_0$  are such that  $f \cdot \tau = \tau \cdot g$  then

$$\tau \partial_{\mathcal{U}}(g) = \mathcal{V}^2 \partial_{\mathcal{V}}(f) \tau \quad \text{and} \quad \tau \partial_{\mathcal{V}}(g) = \mathcal{V}^{-2} \partial_{\mathcal{U}}(f) \tau. \quad (15.3)$$

The above equation is very easy to verify.

We now consider the equation  $\phi_* \circ s_*^1 \simeq s_*^1 \circ \phi_*$ . We define a morphism  $h_*^1: \kappa[\mathbf{i}_0]^K \rightarrow \kappa[\mathbf{i}_1]^K$  via the formula

$$h_*^1(f\sigma, 1) = 1 \otimes \partial_{\mathcal{U}}(f)\sigma.$$

One checks easily that  $\partial_{\text{Mor}}(h_*^1) = \phi_* \circ s_*^1 + s_*^1 \circ \phi_*$ . The other relations with  $t_*^1$  and  $\phi_*$  and  $\psi_*$  are proven similarly.

We now consider the relations for  $\mathcal{S}_*^1 \circ \phi_*^l \simeq \phi_*^l \circ \mathcal{S}_*^1$ . Define  $f_*^1 := \mathcal{S}_*^1 \circ \phi_*^l$  and note that  $f_*^1$  has  $f_4^1$  non-trivial, and this map satisfies

$$f_4^1(\sigma|1, 1|\sigma, a|a', i_0) = i_1 \otimes \sigma \partial_{\mathcal{U}}(a)a'.$$

Note that more generally,  $f_4^1(a\sigma|a', b|b'\sigma, c|c', i_0) = i_1 \otimes aa'bb'\sigma \partial_{\mathcal{U}}(c)c'$ , though we omit the extra possible coefficients on the  $\sigma$  terms to simplify the notation. Define  $g_*^1 := \phi_*^l \circ \mathcal{S}_*^1$  and note that  $g_*^1$  has only  $g_4^1$  non-trivial, and

$$g_4^1(a|a', \sigma|1, 1|\sigma, i_0) = i_1 \otimes \partial_{\mathcal{U}}(a)a'\sigma.$$

There is a third map of interest,  $k_*^1$ , which has

$$k_4^1(\sigma|1, a|a', 1|\sigma, i_0) = i_1 \otimes a'\sigma\partial_{\mathcal{U}}(a).$$

A homotopy  $h_*^1$  between  $f_*^1$  and  $k_*^1$  is given by

$$h_3^1(a\sigma|a', b|b'\sigma, i_0) = i_1 \otimes aa'b'\sigma\partial_{\mathcal{U}}(b).$$

A homotopy between  $k_*^1$  and  $g_*^1$  is constructed similarly. The other relations in the lemma statement are proven by minor modifications of the above argument.  $\square$

**Lemma 15.6.** *There is a homotopy equivalence*

$$\kappa|_{\mathcal{K}}W_l^{\mathcal{K}} \hat{\boxtimes} \kappa[\mathcal{D}_0]_{\mathbb{F}[U]} \simeq (\kappa\mathcal{T}^{\mathcal{K}}, \kappa\mathcal{T}^{\mathcal{K}}) \hat{\boxtimes} \kappa|_{\mathcal{K}}[\mathbb{I}^{\boxplus}]_{\mathbb{F}[U]}.$$

*The same holds if we replace  $W_l$  with  $W_r$ .*

*Proof.* The argument is similar to the proof of Lemma 14.9. The key is to observe that we may define a homotopy  $\partial_{\mathcal{W}} = \mathcal{U}\partial_{\mathcal{U}} + \mathcal{V}\partial_{\mathcal{V}}$ , and that  $\partial_{\mathcal{W}}$  commutes with the action of  $U = \mathcal{U}\mathcal{V}$ .

In our present context, we want to view both modules in the statement as  $DA$ -bimodule mapping cones. For  $\varepsilon \in \{0, 1\}$ , write

$$\kappa|_{\mathcal{K}}[\mathbf{md}_{\varepsilon}]_{\mathbb{F}[U]} := (\mathbf{I}_{\varepsilon} \otimes \mathbf{I}_{\varepsilon}) \cdot \kappa|_{\mathcal{K}}[\mathbb{I}^{\boxplus}]_{\mathbb{F}[U]}.$$

Both of the bimodules in the statement may be viewed as a mapping cone of an  $AA$ -bimodule morphism from  $[\mathbf{md}_0]$  to  $[\mathbf{md}_1]$ .

Similar to Equation (15.2), we may view  $W_l \hat{\boxtimes} \mathcal{D}_0$  as the mapping cone of

$$\mathcal{S}_*^1 + (\text{id} + \mathcal{V}^{-1}(\phi_*^l + \phi_*^r)(\mathcal{U}\phi_*^l + \mathcal{V}\psi_*^l)) \circ \mathcal{T}_*^1. \quad (15.4)$$

We observe that the morphism  $H_{0,1,0}: [\mathbf{md}_1] \rightarrow [\mathbf{md}_1]$  given by  $H_{0,1,0}(\mathbf{x}) = \partial_{\mathcal{W}}(\mathbf{x})$  satisfies

$$\partial_{\text{Mor}}(H_{0,1,0}) = \mathcal{U}\phi_*^l + \mathcal{U}\phi_*^r + \mathcal{V}\psi_*^l + \mathcal{V}\psi_*^r.$$

In particular, we obtain that

$$\begin{aligned} & \text{id} + \mathcal{V}^{-1}(\phi_*^l + \phi_*^r)(\mathcal{U}\phi_*^l + \mathcal{V}\psi_*^l) \\ &= \text{id} + \mathcal{V}^{-1}\phi_*^l(\mathcal{U}\phi_*^l + \mathcal{V}\psi_*^l) + \mathcal{V}^{-1}\phi_*^r(\mathcal{U}\phi_*^l + \mathcal{V}\psi_*^l) \\ &\simeq \text{id} + \mathcal{V}^{-1}\phi_*^l(\mathcal{U}\phi_*^l + \mathcal{V}\psi_*^l) + \mathcal{V}^{-1}\phi_*^r(\mathcal{U}\phi_*^r + \mathcal{V}\psi_*^r) \\ &\simeq \text{id} + \phi_*^l\psi_*^l + \phi_*^r\psi_*^r \\ &\simeq (\text{id} + \phi_*^l\psi_*^l)(\text{id} + \phi_*^r\psi_*^r). \end{aligned}$$

In the last equivalence, we are using the fact that

$$\phi_*^l\psi_*^l\phi_*^r\psi_*^r \simeq 0$$

since  $\phi_*^l\psi_*^l \simeq \mathcal{V}^{-1}\phi_*^l(\mathcal{U}\phi_*^l + \mathcal{V}\psi_*^l)$  (and similarly for  $\phi_*^r\psi_*^r$ ) so

$$\phi_*^l\psi_*^l\phi_*^r\psi_*^r \simeq \mathcal{V}^{-2}\phi_*^l\phi_*^r(\mathcal{U}\phi_*^l + \mathcal{V}\psi_*^l)(\mathcal{U}\phi_*^r + \mathcal{V}\psi_*^r) \simeq \mathcal{V}^{-2}\phi_*^l\phi_*^r(\mathcal{U}\phi_*^l + \mathcal{V}\psi_*^l)^2 \simeq 0.$$

Hence, the map in Equation (15.4) is homotopy equivalent to

$$\mathcal{S}_*^1 + (\text{id} + \phi_*^l\psi_*^l)(\text{id} + \phi_*^r\psi_*^r)\mathcal{T}_*^1.$$

Arguing similarly to the proof of Lemma 15.5, one sees that the above map is homotopic to the map whose cone is

$$(\kappa\mathcal{T}^{\mathcal{K}}, \kappa\mathcal{T}^{\mathcal{K}}) \hat{\boxtimes} \kappa|_{\mathcal{K}}[\mathbb{I}^{\boxplus}]_{\mathbb{F}[U]},$$



completing the proof.  $\square$

**Lemma 15.7.** *There is a homotopy equivalence*

$$(\kappa\mathcal{T}^{\mathcal{K}}, \kappa\mathcal{T}^{\mathcal{K}}) \hat{\boxtimes} \kappa|_{\mathcal{K}}M^{\mathcal{K}} \hat{\boxtimes} \kappa\mathcal{T}^{\mathcal{K}} \simeq \kappa|_{\mathcal{K}}M^{\mathcal{K}}.$$

*Proof.* The proof is similar to the proof of Lemma 15.6. We observe first by computing algebraically using the techniques of Lemma 15.5 that  $(\kappa\mathcal{T}^{\mathcal{K}}, \kappa\mathcal{T}^{\mathcal{K}}) \hat{\boxtimes} \kappa|_{\mathcal{K}}M^{\mathcal{K}} \hat{\boxtimes} \kappa\mathcal{T}^{\mathcal{K}}$  is homotopy equivalent to the mapping cone

$$[\mathbf{m}_0] \xrightarrow{\mathcal{S}_*^1 + (\text{id} + (\phi_*^l + \phi_*^r)(\psi_*^l + \psi_*^r))(\text{id} + \phi_*^l \psi_*^l)(\text{id} + \phi_*^r \psi_*^r) \mathcal{T}_*^1} [\mathbf{m}_1]. \quad (15.5)$$

One observes by direct computation that

$$(\text{id} + (\phi_*^l + \phi_*^r)(\psi_*^l + \psi_*^r))(\text{id} + \phi_*^l \psi_*^l)(\text{id} + \phi_*^r \psi_*^r) \simeq (\text{id} + \phi_*^l \psi_*^r)(\text{id} + \psi_*^l \phi_*^r).$$

Next, we claim that the mapping cone

$$[\mathbf{m}_0] \xrightarrow{\mathcal{S}_*^1 + (\text{id} + \phi_*^l \psi_*^r)(\text{id} + \psi_*^l \phi_*^r) \mathcal{T}_*^1} [\mathbf{m}_1],$$

is homotopy equivalent to

$$[\mathbf{m}_0] \xrightarrow{\mathcal{S}_*^1 + (\text{id} + \psi_*^l \phi_*^r) \mathcal{T}_*^1 (\text{id} + \phi_*^l \psi_*^r)} [\mathbf{m}_1].$$

This homotopy equivalence is realized by a diagram

$$\begin{array}{ccc} [\mathbf{m}_0] & \xrightarrow{\mathcal{S}_*^1 + (\text{id} + \phi_*^l \psi_*^r)(\text{id} + \psi_*^l \phi_*^r) \mathcal{T}_*^1} & [\mathbf{m}_1] \\ \downarrow \text{id} + \phi_*^l \psi_*^r & \dashrightarrow & \downarrow \text{id} + \phi_*^l \psi_*^r \\ [\mathbf{m}_0] & \xrightarrow{\mathcal{S}_*^1 + (\text{id} + \psi_*^l \phi_*^r) \mathcal{T}_*^1 (\text{id} + \phi_*^l \psi_*^r)} & [\mathbf{m}_1] \end{array} \quad (15.6)$$

The length 2 map above is a morphism which realizes the chain homotopies

$$\begin{aligned} (\text{id} + \phi_*^l \psi_*^r)^2 (\text{id} + \psi_*^l \phi_*^r) \mathcal{T}_*^1 &\simeq (\text{id} + \psi_*^l \phi_*^r) \mathcal{T}_*^1 (\text{id} + \phi_*^l \psi_*^r)^2, \quad \text{and} \\ [\text{id} + \phi_*^l \psi_*^r, \mathcal{S}_*^1] &\simeq 0. \end{aligned}$$

To see that Equation (15.6) is a homotopy equivalence, observe that the length 1 maps from the top to bottom, denoted  $\text{id} + \phi_*^l \psi_*^r$ , are homotopy involutions. It follows that if we write  $F$  for the map in Equation (15.6), there is a map  $G$  in the opposite direction so that  $G \circ F \simeq K$ , where  $K$  has length 1 maps which are the identity. The map  $K$  is its own inverse, so  $K \circ G \circ F \simeq \text{id}$  (i.e.  $F$  has a left inverse). Constructing a right inverse to  $F$  is similar. By basic algebra, the left and right inverses of  $F$  must be homotopic. Hence  $F$  is a homotopy equivalence.

Finally, we use Lemma 15.5 to see that

$$(\text{id} + \psi_*^l \phi_*^r) \mathcal{T}_*^1 (\text{id} + \phi_*^l \psi_*^r) \simeq (\text{id} + \psi_*^l \phi_*^r)^2 \mathcal{T}_*^1 \simeq \mathcal{T}_*^1.$$

It follows that Equation (15.5) is homotopy equivalent to the mapping cone

$$\text{Cone}(\mathcal{S}_*^1 + \mathcal{T}_*^1: \kappa|_{\mathcal{K}}[\mathbf{m}_0]^{\mathcal{K}} \rightarrow \kappa|_{\mathcal{K}}[\mathbf{m}_1]^{\mathcal{K}})$$

which is the definition of  $\kappa|_{\mathcal{K}}M^{\mathcal{K}}$ .  $\square$

Proposition 15.4 now follows from Lemmas 15.6 and 15.7.

## 16. THE LINK SURGERY COMPLEX OF HOPF LINKS

In this section, we prove several helpful results centered on the link Floer homology of the Hopf link. In Section 16.1, we compute the link surgery complex for the negative Hopf link. In Section 17.1, we give several  $A_\infty$  perspectives on the Hopf link complex, and we apply the homological perturbation lemma to arrive at small models.

**16.1. Computation of the surgery complex.** In this section, we compute the surgery hypercube for the Hopf link. We use the following model of the Hopf link:

$$\mathcal{CFL}(H) \cong \begin{array}{ccc} \mathbf{a} \leftarrow \mathcal{U}_2 - \mathbf{b} & & \\ \uparrow \gamma_1 & & \downarrow \mathcal{U}_1 \\ \mathbf{c} - \gamma_2 \rightarrow \mathbf{d}. & & \end{array} \quad (16.1)$$

This complex is realized by the diagram in Figure 16.1. This complex is for the *negative* Hopf link, i.e., the two components have linking number  $-1$ . The complex of the positive Hopf link has a similar model. The techniques of this section may also be applied, essentially verbatim, to the positive Hopf link, though we focus on the negative one for concreteness.

The Alexander gradings  $A = (A_1, A_2)$  and Maslov gradings  $\text{gr} = (\text{gr}_{\mathbf{w}}, \text{gr}_{\mathbf{z}})$  of the generators are

$$\begin{aligned} A(\mathbf{a}) &= \left(-\frac{1}{2}, \frac{1}{2}\right), & \text{gr}(\mathbf{a}) &= (0, 0), \\ A(\mathbf{b}) &= \left(-\frac{1}{2}, -\frac{1}{2}\right), & \text{gr}(\mathbf{b}) &= (-1, 1), \\ A(\mathbf{c}) &= \left(\frac{1}{2}, \frac{1}{2}\right), & \text{gr}(\mathbf{c}) &= (1, -1), \\ A(\mathbf{d}) &= \left(\frac{1}{2}, -\frac{1}{2}\right), & \text{gr}(\mathbf{d}) &= (0, 0). \end{aligned} \quad (16.2)$$

Note that we are using the conventions where the top degree generator of  $HF^-(S^3, \mathbf{w})$  is in Maslov grading 0. See Remark 7.3.

The main result of this section is the following result:

**Proposition 16.1.** *Suppose that  $\Lambda = (\lambda_1, \lambda_2)$  is an integral framing on the negative Hopf link  $H$ . Let  $\mathcal{A}_{\alpha\alpha}$  be a system of arcs for the Hopf link where both arcs are alpha-parallel. The link surgery hypercube  $\mathcal{C}_\Lambda(H, \mathcal{A}_{\alpha\alpha})$  has the following maps (up to overall homotopy equivalence).*

- (1) *The maps  $\Phi_{H, L_2}^{L_1}$  and  $\Phi_{L_1, \emptyset}^{L_1}$  are the canonical inclusions of localization. The maps  $\Phi_{H, L_2}^{-L_1}$  and  $\Phi_{L_1, \emptyset}^{-L_1}$  are both given by the following formula:*

$$\Phi^{-L_1} = \begin{array}{l} \mathbf{a} \longmapsto \gamma_1^{\lambda_1-1} \mathbf{d} \\ \mathbf{b} \longmapsto 0 \\ \mathbf{c} \longmapsto \gamma_1^{\lambda_1+1} \mathbf{b} + \gamma_1^{\lambda_1} \mathcal{U}_2 \mathbf{c} \\ \mathbf{d} \longmapsto \gamma_1^{\lambda_1} \mathcal{U}_2 \mathbf{d}. \end{array}$$

(2) The maps  $\Phi_{H,L_1}^{L_2}$  and  $\Phi_{L_2,\emptyset}^{L_2}$  are the canonical inclusions of localization. The maps  $\Phi_{H,L_1}^{-L_2}$  and  $\Phi_{L_2,\emptyset}^{-L_2}$  are both given by the following formula:

$$\Phi^{-L_2} = \begin{array}{l} \mathbf{a} \longmapsto \mathcal{U}_1 \mathcal{V}_2^{\lambda_2} \mathbf{a} \\ \mathbf{b} \longmapsto 0 \\ \mathbf{c} \longmapsto \mathcal{V}_2^{\lambda_2+1} \mathbf{b} + \mathcal{U}_1 \mathcal{V}_2^{\lambda_2} \mathbf{c} \\ \mathbf{d} \longmapsto \mathcal{V}_2^{\lambda_2-1} \mathbf{a}. \end{array}$$

(3) The length 2 map  $\Phi_{H,\emptyset}^{-H}$  is given by the following formula:

$$\Phi_{H,\emptyset}^{-H} = \begin{array}{l} \mathbf{a} \longmapsto \mathcal{V}_1^{\lambda_1-2} \mathcal{V}_2^{\lambda_2-1} \mathbf{c} \\ \mathbf{b} \longmapsto 0 \\ \mathbf{c} \longmapsto \mathcal{V}_1^{\lambda_1-1} \mathcal{V}_2^{\lambda_2} \mathbf{d} \\ \mathbf{d} \longmapsto \mathcal{V}_1^{\lambda_1-1} \mathcal{V}_2^{\lambda_2-2} \mathbf{c}. \end{array}$$

The length 2 maps for other orientations of the Hopf link vanish.

We now compute the link surgery hypercube maps for the Hopf link. For the purposes of computation, it is easier to compute the induced maps after quotienting variables, instead of after localizing. Since the link surgery hypercube maps are defined by computing holomorphic polygons on diagrams where we have deleted certain basepoints, this is easily seen to contain equivalent information as the ordinary surgery hypercube. Compare Lemma 7.5.

As an example, if  $L_1 \subseteq H$ , then the descent map from surgery hypercube takes the form

$$\Phi_{H,H-L_1}^{-L_1} : \mathcal{CFL}(H) \rightarrow \mathcal{V}_1^{-1} \cdot \mathcal{CFL}(H).$$

The map  $\Phi_{H,H-L_1}^{-L_1}$  is completely determined by the choice of framing on  $H$ , and the induced homotopy equivalence on the level of quotients

$$\tilde{\Phi}_{H,H-L_1}^{-L_1} : \mathcal{CFL}(H)/(\mathcal{U}_1 - 1) \rightarrow \mathcal{CFL}(H)/(\mathcal{V}_1 - 1).$$

In this section, we write  $\tilde{\Phi}^{\vec{N}}$  for the descent map on the level of quotients of  $\mathcal{CFL}(H)$ .

**Lemma 16.2.** *Write  $L_1$  and  $L_2$  for the two components of the negative Hopf link. Up to overall equivalence, the maps for the Hopf link are as follows:*

(1) The map

$$\tilde{\Phi}_{H,L_2}^{-L_1} : \mathcal{CFL}(H)/(\mathcal{U}_1 - 1) \rightarrow \mathcal{CFL}(H)/(\mathcal{V}_1 - 1)$$

is given by the formula

$$\tilde{\Phi}_{H,L_2}^{-L_1} = \begin{array}{l} \mathbf{a} \longmapsto \mathbf{d} \\ \mathbf{b} \longmapsto 0 \\ \mathbf{c} \longmapsto \mathbf{b} + \mathcal{U}_2 \mathbf{c} \\ \mathbf{d} \longmapsto \mathcal{U}_2 \mathbf{d}. \end{array}$$

extended  $\mathbb{F}[\mathcal{U}_2, \mathcal{V}_2]$ -equivariantly, and sending  $\mathcal{V}_1$  to  $\mathcal{U}_1$ .

(2) The map

$$\tilde{\Phi}_{L_1, \emptyset}^{-L_1}: \mathcal{CFL}(H)/(\mathcal{U}_1 - 1, \mathcal{V}_2 - 1) \rightarrow \mathcal{CFL}(H)/(\mathcal{V}_1 - 1, \mathcal{V}_2 - 1)$$

is given by the same formula as  $\tilde{\Phi}_{H, L_2}^{-L_1}$ , except with  $\mathcal{V}_2$  set to 1.

(3) The map

$$\tilde{\Phi}_{H, L_1}^{-L_2}: \mathcal{CFL}(H)/(\mathcal{U}_2 - 1) \rightarrow \mathcal{CFL}(H)/(\mathcal{V}_2 - 1)$$

is given by the formula

$$\tilde{\Phi}_{H, L_1}^{-L_2} = \begin{array}{l} \mathbf{a} \longmapsto \mathcal{U}_1 \mathbf{a} \\ \mathbf{b} \longmapsto 0 \\ \mathbf{c} \longmapsto \mathbf{b} + \mathcal{U}_1 \mathbf{c} \\ \mathbf{d} \longmapsto \mathbf{a} \end{array},$$

extended equivariantly over  $\mathbb{F}[\mathcal{U}_1, \mathcal{V}_1]$ , and sending  $\mathcal{V}_2$  to  $\mathcal{U}_2$ .

(4) The map

$$\tilde{\Phi}_{L_2, \emptyset}^{-L_2}: \mathcal{CFL}(H)/(\mathcal{V}_1 - 1, \mathcal{U}_2 - 1) \rightarrow \mathcal{CFL}(H)/(\mathcal{V}_1 - 1, \mathcal{V}_2 - 1)$$

is given by the same formula as  $\tilde{\Phi}_{H, L_1}^{-L_2}$ , except with  $\mathcal{V}_1$  set to 1.

(5) The length 2 map

$$\tilde{\Phi}_{H, \emptyset}^{-H}: \mathcal{CFL}(H)/(\mathcal{U}_1 - 1, \mathcal{U}_2 - 1) \rightarrow \mathcal{CFL}(H)/(\mathcal{V}_1 - 1, \mathcal{V}_2 - 1)$$

is given by the formula

$$\tilde{\Phi}_{H, \emptyset}^{-H} = \begin{array}{l} \mathbf{a} \longmapsto \mathbf{c} \\ \mathbf{b} \longmapsto 0 \\ \mathbf{c} \longmapsto \mathbf{d} \\ \mathbf{d} \longmapsto \mathbf{c} \end{array},$$

extended to send  $\mathcal{V}_1$  to  $\mathcal{U}_1$  and  $\mathcal{V}_2$  to  $\mathcal{U}_2$ .

(6) The length 1 maps with positively oriented components, e.g.  $\tilde{\Phi}_{H, L_2}^{L_1}$ , are the canonical quotient maps. The length 2 maps vanish for any orientation other than  $-H$ .

*Remark 16.3.* As we will see in the proof of the above lemma, all of the maps in the surgery hypercube for  $H$  are uniquely determined by the chain complex  $\mathcal{CFL}(H)$ , except for the length 2 map  $\tilde{\Phi}_{H, L_2}^{L_1}$ , and up to homotopy there are two possible choices. We will use additional algebraic restrictions on the link surgery hypercube to determine which choice of length 2 map is correct.

*Proof of Lemma 16.2.* We focus first on the length 1 maps. Consider the complexes

$$\mathcal{C}/(\mathcal{U}_1 - 1) = \begin{array}{ccc} \mathbf{a} \leftarrow \mathcal{U}_2 - \mathbf{b} & & \\ \uparrow & | & \\ \mathcal{V}_1 & 1 & \\ | & \downarrow & \\ \mathbf{c} - \mathcal{V}_2 \rightarrow \mathbf{d}. & & \end{array} \quad \text{and} \quad \mathcal{C}/(\mathcal{V}_1 - 1) = \begin{array}{ccc} \mathbf{a} \leftarrow \mathcal{U}_2 - \mathbf{b} & & \\ \uparrow & | & \\ 1 & \mathcal{U}_1 & \\ | & \downarrow & \\ \mathbf{c} - \mathcal{V}_2 \rightarrow \mathbf{d}. & & \end{array}$$

The map  $\tilde{\Phi}_{H,L_2}^{-L_1}$  is a homotopy equivalence between these two complexes, which is  $\mathbb{F}[\mathcal{U}_2, \mathcal{V}_2]$ -equivariant, and sends  $\mathcal{V}_1$  to  $\mathcal{U}_1$ . We perform the following changes of basis:

$$\begin{array}{ccc}
 \mathbf{a} & \mathbf{b} & \mathbf{a} + \mathcal{V}_2 \mathbf{d} \quad \mathbf{b} + \mathcal{U}_2 \mathbf{c} \\
 \uparrow & | & \uparrow & | \\
 \mathcal{C}/(\mathcal{U}_1 - 1) \cong & \mathcal{V}_1 + \mathcal{U}_2 \mathcal{V}_2 & \mathcal{C}/(\mathcal{V}_1 - 1) \cong & \mathcal{U}_1 + \mathcal{U}_2 \mathcal{V}_2 \\
 & | & & | \\
 \mathbf{c} + \mathcal{V}_2 \mathbf{b} & \mathbf{d} + \mathcal{U}_2 \mathbf{a} & \mathbf{c} & \mathbf{d}
 \end{array} \quad (16.3)$$

We may view each of the above complexes as the knot Floer complex for an unknot, with an extra free-basepoint. In the following we write  $\text{gr}_{\mathbf{w}}$  for the grading induced by the complete collection of basepoints consisting of the  $\mathbf{w}$ -type link basepoints (i.e. the ones where the unknot intersects the Heegaard surface negatively), and all the free-basepoints. We write  $\text{gr}_{\mathbf{z}}$  for the grading induced by the complete collection consisting of the  $\mathbf{z}$ -type basepoints and the free-basepoints. We may easily compute the  $(\text{gr}_{\mathbf{w}}, \text{gr}_{\mathbf{z}})$ -gradings of the all of the quotiented complexes, viewed in this manner:

$$\begin{array}{ccc}
 \mathbf{a} \xrightarrow{(\text{gr}_{\mathbf{w}}, \text{gr}_{\mathbf{z}})} (0, 0) & & \mathbf{a} \longrightarrow (0, -2) \\
 \mathcal{C}/(\mathcal{U}_1 - 1) : \mathbf{b} \longrightarrow (-1, 1) & \mathcal{C}/(\mathcal{V}_1 - 1) : \mathbf{b} \longrightarrow (-1, -1) & \\
 \mathbf{c} \longrightarrow (-1, -1) & \mathbf{c} \longrightarrow (1, -1) & \\
 \mathbf{d} \longrightarrow (-2, 0) & \mathbf{d} \longrightarrow (0, 0) & \\
 \\ 
 \mathbf{a} \longrightarrow (-2, 0) & & \mathbf{a} \longrightarrow (0, 0) \\
 \mathcal{C}/(\mathcal{U}_2 - 1) : \mathbf{b} \longrightarrow (-1, 1) & \mathcal{C}/(\mathcal{V}_2 - 1) : \mathbf{b} \longrightarrow (-1, -1) & \\
 \mathbf{c} \longrightarrow (-1, -1) & \mathbf{c} \longrightarrow (1, -1) & \\
 \mathbf{d} \longrightarrow (0, 0) & \mathbf{d} \longrightarrow (0, -2) & 
 \end{array}$$

The homotopy equivalence  $\tilde{\Phi}_{H,L_2}^{-L_1}$  is grading preserving with respect to the above gradings, since it is the map for changing Heegaard diagrams. It is straightforward to see from Equation (16.3) that there is a unique choice of non-zero chain map from  $\mathcal{C}/(\mathcal{U}_1 - 1)$  to  $\mathcal{C}/(\mathcal{V}_1 - 1)$  which is  $(\text{gr}_{\mathbf{w}}, \text{gr}_{\mathbf{z}})$ -grading preserving, is  $\mathbb{F}[\mathcal{U}_2, \mathcal{V}_2]$ -equivariant, and sends  $\mathcal{V}_1$  to  $\mathcal{U}_1$ . (Note here we are using the  $(\text{gr}_{\mathbf{w}}, \text{gr}_{\mathbf{z}})$ -bigrading obtained by viewing  $\mathcal{C}/(\mathcal{U}_1 - 1)$  and  $\mathcal{C}/(\mathcal{V}_1 - 1)$  as the complex of an unknot, shown above; we are not using the gradings naively inherited from the Hopf link). This map is the homotopy equivalence  $\tilde{\Phi}_{H,L_2}^{-L_1}$  in the map in the statement. By a symmetric argument, one obtains the formula for  $\tilde{\Phi}_{H,L_1}^{-L_2}$  in the statement.

Next, by the definition of a  $\sigma$ -basic system, the map  $\tilde{\Phi}_{L_1, \emptyset}^{-L_1}$  is obtained by quotienting the domain and range of  $\tilde{\Phi}_{H,L_2}^{-L_1}$  by  $\mathcal{V}_2 - 1$ . The maps  $\tilde{\Phi}_{H,L_1}^{-L_2}$  and  $\tilde{\Phi}_{L_2, \emptyset}^{-L_2}$  are related by a similar relation.

We now consider the diagonal map of the cube. Firstly, since we are working with a basis system, the length 2 map vanishes except for the orientation  $-H$  (i.e. all components oriented negatively). In our present notation, this is the map

$$\tilde{\Phi}_{H, \emptyset}^{-H} : \mathcal{C}/(\mathcal{U}_1 - 1, \mathcal{U}_2 - 1) \rightarrow \mathcal{C}/(\mathcal{V}_1 - 1, \mathcal{V}_2 - 1).$$

We define the map

$$E := \tilde{\Phi}_{L_1, \emptyset}^{-L_1} \circ \tilde{\Phi}_{H, L_1}^{-L_2} + \tilde{\Phi}_{L_2, \emptyset}^{-L_2} \circ \tilde{\Phi}_{H, L_2}^{-L_1}. \quad (16.4)$$

Using our computations of the length 1 maps of the cube, we compute  $E$  to be

$$E = \begin{array}{l} \mathbf{a} \longmapsto \mathbf{a} + \mathbf{d} \\ \mathbf{b} \longmapsto 0 \\ \mathbf{c} \longmapsto (\mathcal{U}_1 + \mathcal{U}_2)\mathbf{c} \\ \mathbf{d} \longmapsto \mathbf{a} + \mathbf{d}, \end{array}$$

extended linearly by sending  $\mathcal{V}_1$  to  $\mathcal{U}_1$  and  $\mathcal{V}_2$  to  $\mathcal{U}_2$ .

Up to an overall chain homotopy intertwining  $\mathbb{F}[\mathcal{V}_1, \mathcal{V}_2]$  and  $\mathbb{F}[\mathcal{U}_1, \mathcal{U}_2]$ , there are two choices for a graded null-homotopy of the map  $E$ . These are the maps:

$$H_1 := \begin{array}{l} \mathbf{a} \longmapsto \mathbf{c} \\ \mathbf{b} \longmapsto 0 \\ \mathbf{c} \longmapsto 0 \\ \mathbf{d} \longmapsto \mathbf{c}, \end{array} \quad \text{and} \quad H_2 := \begin{array}{l} \mathbf{a} \longmapsto \mathbf{c} \\ \mathbf{b} \longmapsto 0 \\ \mathbf{c} \longmapsto \mathbf{d} \\ \mathbf{d} \longmapsto \mathbf{c}, \end{array} \quad (16.5)$$

This is observed since  $H_1$  and  $H_2$  are easily checked to be valid homotopies, and up to chain homotopy, there is exactly one non-trivial  $+1$  graded map from  $\mathcal{C}/(\mathcal{U}_1 - 1, \mathcal{U}_2 - 1)$  to  $\mathcal{C}/(\mathcal{V}_1 - 1, \mathcal{V}_2 - 1)$ . This is the map which sends  $\mathbf{c}$  to  $\mathbf{d}$ , sends  $\mathcal{V}_i$  to  $\mathcal{U}_i$ , and vanishes on other generators. Hence,  $H_1$  and  $H_2$  are the only possible choices, up to further homotopy. We prove in the subsequent Lemma 16.4 that  $H_1$  is not a valid choice, due to other formal properties of the hypercube, and hence the length 2 map of the surgery hypercube is  $H_2$ .  $\square$

We consider a point  $p \in \alpha$ , which we use to define a map  $A_p$ , counting disks weighted by the difference in multiplicities on the two sides of the point  $p$ . Note that the map  $A_p$  may be identified with the relative homology map of [Zem15, Section 5] if we pick a path  $\lambda$  which connects a basepoint on  $L_1$  to a basepoint on  $L_2$  and satisfies  $\lambda \cap \alpha = \{p\}$ .

The map  $A_p$  is defined on  $\mathcal{CFL}(H)$ , and is easily computed by counting holomorphic bigons to be given by the formula

$$A_p = \begin{array}{ccc} \mathbf{a} & \xrightarrow{\mathcal{V}_2} & \mathbf{b} \\ \downarrow \mathcal{U}_1 & & \uparrow \mathcal{V}_1 \\ \mathbf{c} & \xleftarrow{\mathcal{U}_2} & \mathbf{d} \end{array} = \begin{array}{l} \mathbf{a} \longmapsto \mathcal{V}_2\mathbf{b} + \mathcal{U}_1\mathbf{c} \\ \mathbf{b} \longmapsto 0 \\ \mathbf{c} \longmapsto \mathcal{V}_2\mathbf{d} \\ \mathbf{d} \longmapsto \mathcal{U}_2\mathbf{c} + \mathcal{V}_1\mathbf{b} \end{array}$$

There is an extension of the map  $A_p$  for hypercubes, which is similar to the relative homology action on hypercubes that we described in Section 13.3 and in [HHSZ21, Section 6.2]. We recall the construction presently. Suppose that  $\alpha$  is a set of alpha attaching curves, and  $\mathcal{L}_\beta$  is a hypercube of beta attaching curves, both on a pointed surface  $(\Sigma, \mathbf{w})$ . Suppose that  $p$  is a point on an alpha circle  $\alpha$ , and that the two components of  $\Sigma \setminus \alpha$  which have  $\alpha$  along their boundary contain the basepoints  $w$  and  $w'$ . We formally define the 1-dimensional hypercube

$$\mathcal{L}_\alpha^p = \alpha \xrightarrow{p} \alpha.$$

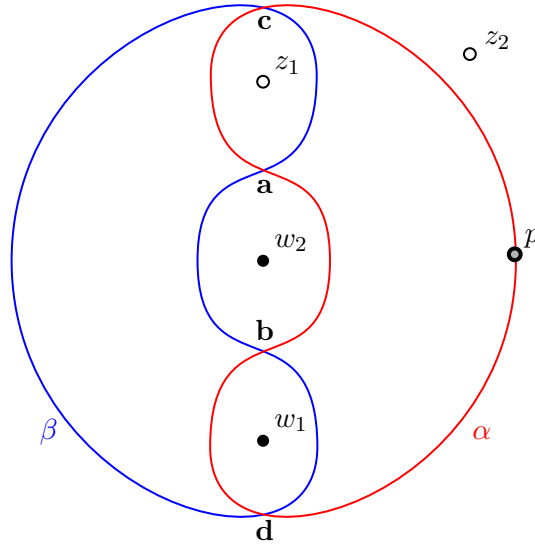

FIGURE 16.1. A diagram for the Hopf link with a special point  $p \in \alpha$ .

We may pair  $\mathcal{L}_\alpha^p$  and  $\mathcal{L}_\beta$  to obtain a morphism of hypercubes, which we write as

$$CF(\mathcal{L}_\alpha^p, \mathcal{L}_\beta, \mathbf{w}) = \left( CF(\alpha, \mathcal{L}_\beta, \mathbf{w}) \xrightarrow{\mathcal{A}_p} CF(\alpha, \mathcal{L}_\beta, \mathbf{w}) \right).$$

To define the map  $\mathcal{A}_p$ , we formally view  $p$  as an input to the holomorphic polygon counting maps by defining  $f_{\alpha, \alpha, \beta_1, \dots, \beta_{n-1}}(p, \mathbf{x}_1, \dots, \mathbf{x}_{n-1})$  to count holomorphic  $n$ -gons on the diagram  $(\Sigma, \alpha, \beta_1, \dots, \beta_{n-1}, \mathbf{w})$  representing classes  $\psi$  of Maslov index  $3 - n$ , weighted by the quantity  $\#(\partial_\alpha \psi) \cap \{p\}$ . Using Gromov compactness, the standard proof that pairing hypercubes of attaching curves gives a hypercube of chain complexes instead adapts to give the relation

$$[\partial, \mathcal{A}_p] = (U_w + U_{w'}) \cdot \text{id}.$$

If  $w \neq w'$ , then the terms on the right hand side are contributed by the two index 2 alpha boundary degenerations which have  $p$  along their boundary. One of these degenerations covers  $w$  and the other covers  $w'$ . If  $w = w'$ , then the right hand side is 0. See Lemma 13.29 for more details.

The above construction of  $CF(\mathcal{L}_\alpha^p, \mathcal{L}_\beta, \mathbf{w})$  also works if  $\mathcal{L}_\beta$  is instead a  $\sigma$ -basic system of Heegaard diagrams for  $H$ , since the point-pushing diffeomorphisms never change  $\alpha$ .

With these considerations in mind, we obtain a diagram of the following form:

$$\begin{array}{ccccc}
\mathcal{C}/(\mathcal{U}_1 - 1, \mathcal{U}_2 - 1) & \xrightarrow{\tilde{\Phi}^{-L_1}} & \mathcal{C}/(\mathcal{V}_1 - 1, \mathcal{U}_2 - 1) & & \\
\downarrow \tilde{\Phi}^{-L_2} & \searrow A_p & \downarrow h_p^{-L_1} & \searrow A_p & \\
& \mathcal{C}/(\mathcal{U}_1 - 1, \mathcal{U}_2 - 1) & \xrightarrow{\tilde{\Phi}^{-L_1}} & \mathcal{C}/(\mathcal{V}_1 - 1, \mathcal{U}_2 - 1) & \\
& \downarrow H & \downarrow \tilde{\Phi}^{-L_2} & \downarrow h_p^{-L_2} & \\
& \mathcal{C}/(\mathcal{U}_1 - 1, \mathcal{V}_2 - 1) & \xrightarrow{\tilde{\Phi}^{-L_1}} & \mathcal{C}/(\mathcal{V}_1 - 1, \mathcal{V}_2 - 1) & \\
& \downarrow A_p & \downarrow h_p^{-L_1} & \downarrow A_p & \\
& \mathcal{C}/(\mathcal{U}_1 - 1, \mathcal{V}_2 - 1) & \xrightarrow{\tilde{\Phi}^{-L_1}} & \mathcal{C}/(\mathcal{V}_1 - 1, \mathcal{V}_2 - 1) & \\
& & & & \text{(16.6)}
\end{array}$$

In the above diagram, both maps labeled  $h_p^{-L_2}$  are induced by a single map from  $\mathcal{C}/(\mathcal{V}_2 - 1)$  to  $\mathcal{C}/(\mathcal{U}_2 - 1)$ . The map labeled  $h_p^{-L_1}$  is similar.

The diagram in Equation (16.6) does not satisfy the hypercube relations. Instead, if we view it as  $\text{Cone}(\mathcal{A}_p)$ , where  $\mathcal{A}_p$  is a morphism from the back face to the front face, then

$$[\partial, \mathcal{A}_p] = (\mathcal{U}_1 \mathcal{V}_1 + \mathcal{U}_2 \mathcal{V}_2) \cdot \text{id}.$$

We now analyze the maps labeled  $h_p^{-L_i}$ . Consider first  $h_p^{-L_2}$ . Both instances of this map is induced by a single map from  $\mathcal{C}/(\mathcal{U}_2 - 1)$  to  $\mathcal{C}/(\mathcal{V}_2 - 1)$ , for which we also write  $h_p^{-L_2}$ . This maps preserves the Maslov bigradings, if we view  $\mathcal{C}/(\mathcal{U}_2 - 1)$  and  $\mathcal{C}/(\mathcal{V}_2 - 1)$  as the link Floer complexes for an unknot with an extra free basepoint. Extending the observation from the proof of Lemma 16.2 that we used to compute the length 1 maps, there were exactly two grading preserving chain maps from  $\mathcal{C}/(\mathcal{U}_2 - 1)$  to  $\mathcal{C}/(\mathcal{V}_2 - 1)$  which are  $\mathbb{F}[\mathcal{U}_1, \mathcal{V}_1]$ -equivariant, and send  $\mathcal{V}_2$  to  $\mathcal{U}_2$ : the zero map, and the map labeled  $\tilde{\Phi}^{-L_2}$ . This observation constrains  $h_p^{-L_2}$  to be one of two maps, which differ by the map  $\tilde{\Phi}^{-L_2}$ . The same comment applies for  $h_p^{-L_1}$ .

We compute that directly

$$[\tilde{\Phi}^{-L_1}, \mathcal{A}_p] = 0.$$

Hence, by the above observation, we conclude that

$$h_p^{-L_1} = s \cdot \tilde{\Phi}^{-L_1} \tag{16.7}$$

for some  $s \in \mathbb{F}$ .

Similarly, we compute that

$$\begin{array}{l}
\mathbf{a} \longmapsto 0 \\
[\tilde{\Phi}^{-L_2}, \mathcal{A}_p] = \mathbf{b} \longmapsto 0 \\
\mathbf{c} \longmapsto \mathcal{U}_2 \mathbf{a} + \mathcal{U}_1 \mathbf{d} \\
\mathbf{d} \longmapsto 0.
\end{array}$$



Hence,

$$h_p^{-L_2} = (\mathbf{c} \mapsto \mathbf{b}) + t \cdot \tilde{\Phi}^{-L_2}, \quad (16.8)$$

for some  $t \in \mathbb{F}$ .

Using the above observations, we are now able to compute the length 2 map of the link surgery hypercube of the Hopf link:

**Lemma 16.4.** *The length 3 hypercube relation in Equation (16.6) is satisfiable with  $H_2$ , but not with  $H_1$ . Hence  $H_2$  is the length 2 map of the Hopf link surgery hypercube.*

*Proof.* For  $i \in \{1, 2\}$ , let  $C_i$  denote the sum of compositions of maps in (16.6) which would appear in the length 3 relation, except for  $[\partial, \omega_p]$ . Here,  $C_i$  is computed with the map  $H = H_i$ . The hypercube relations are satisfiable with  $H_i$  if and only if  $C_i \simeq 0$ .

We have determined the maps  $h_p^{-L_2}$  and  $h_p^{-L_1}$  up to a minor ambiguity, as shown in equations (16.7) and (16.8). Note that changing the value of  $s$  in  $h_p^{-L_1}$  changes  $C_i$  by addition of the map  $E$  from (16.4), which we already know to be null-homotopic. Hence, it is sufficient to consider the case where  $s = t = 0$ .

One easily computes

$$C_1 = [h_p^{-L_2}, \tilde{\Phi}^{-L_1}] + [H_1, A_p] = \begin{array}{l} \mathbf{a} \longmapsto \mathbf{d} \\ \mathbf{b} \longmapsto 0 \\ \mathbf{c} \longmapsto \mathbf{b} + \mathcal{U}_2 \mathbf{c} \\ \mathbf{d} \longmapsto \mathbf{d}, \end{array}$$

which is not null-homotopic. Hence,  $H_1$  is not a valid choice. It is easily checked that in fact

$$[h_p^{-L_2}, \tilde{\Phi}^{-L_1}] + [H_2, A_p] = 0.$$

Hence, the diagonal map must be  $H_2$ .  $\square$

*Remark 16.5.* View the maps  $H_1$  and  $H_2$  as being  $\mathbb{F}[U_1, U_2]$ -equivariant, where  $U_i$  acts by  $\mathcal{V}_i$  on the domain, and  $\mathcal{U}_i$  on the codomain. The maps  $H_1$  and  $H_2$  are homotopic over  $\mathbb{F}[U_1]$  or  $\mathbb{F}[U_2]$ , but not over  $\mathbb{F}[U_1, U_2]$ . If we wanted to compute the Heegaard Floer homology of surgeries on the Hopf link, either  $H_1$  or  $H_2$  would give the same answer. Compare [Liu14, Section 5.2]. We will see in Section 16.3 that using  $H_1$  to build the link surgery hypercube gives  $\mathcal{C}_\Lambda(H, \mathcal{A}_{\alpha\beta})$  where  $\mathcal{A}_{\alpha\beta}$  is a system of arcs where one arc is alpha-parallel and the other is beta-parallel.

Since we will be taking tensor products, we need to know the length 2 map over the ring  $\mathbb{F}[U_1, U_2]$ , and there are algebraically two distinct models.

It remains to describe the proof of Proposition 16.1:

*Proof of Proposition 16.1.* The proof is obtained by filling in powers of  $\mathcal{V}_i$  in the maps from Lemma 16.2 according to Alexander grading changes. We leave this mostly to the reader, but we verify the claim for the map  $\Phi_{H, L_2}^{-L_1}$ . This map sends Alexander grading  $\mathbf{s}$  to  $\mathbf{s} + (\lambda_1, -1)$ . Furthermore, it is  $\mathbb{F}[\mathcal{U}_2, \mathcal{V}_2]$  equivariant, and is  $T$ -equivariant with respect to  $\mathbb{F}[\mathcal{U}_1, \mathcal{V}_1]$ . As an example, the equivariance properties and the computation of the quotient map in Lemma 16.2 constrain  $\Psi_{H, L_2}^{-L_1}(\mathbf{a}) = \mathcal{V}_1^N \mathbf{d}$  for some  $N$ . Since  $A(\mathbf{a}) = (-\frac{1}{2}, \frac{1}{2})$  and  $A(\mathbf{d}) = (\frac{1}{2}, -\frac{1}{2})$ , we conclude that  $N = \lambda_1 - 1$ . Similar arguments hold for all of the other components.  $\square$

**16.2. The Hopf link complex as a type- $D$  module.** We now describe the type- $D$  module over  $\mathcal{L}_2 = \mathcal{K} \otimes \mathcal{K}$  for the Hopf link complex. We write  $\mathcal{H}_\Lambda^{\mathcal{K} \otimes \mathcal{K}}$  for the type- $D$  module for the negative Hopf link with an alpha-parallel system of arcs. We recall that by definition, for each  $\varepsilon \in \mathbb{E}_2$ , we define  $\mathcal{H} \cdot \mathbf{I}_\varepsilon$  to have the same generators over  $\mathbb{F}$  as a free  $\mathbb{F}[\mathcal{W}_1, \mathcal{V}_1, \mathcal{W}_2, \mathcal{V}_2]$ -basis of  $\mathcal{CFL}(H)$ . Hence, we write

$$\mathcal{H}_\Lambda^{\mathcal{K} \otimes \mathcal{K}} \cdot \mathbf{I}_\varepsilon = \text{Span}_{\mathbb{F}}(\mathbf{a}_\varepsilon, \mathbf{b}_\varepsilon, \mathbf{c}_\varepsilon, \mathbf{d}_\varepsilon).$$

It is helpful to write  $\mathcal{H}_\varepsilon$  for  $\mathcal{H}_\Lambda \cdot \mathbf{I}_\varepsilon$ . With this notation, we may decompose  $\mathcal{H}_\Lambda$  as

$$\mathcal{H}_\Lambda = \begin{array}{cc} \mathcal{H}_{0,0} & \mathcal{H}_{1,0} \\ \mathcal{H}_{0,1} & \mathcal{H}_{1,1} \end{array}$$

We now describe the structure maps:

**Lemma 16.6.** *Let  $\mathcal{H}_\Lambda^{\mathcal{K} \otimes \mathcal{K}}$  be the type- $D$  module associated to the negative Hopf link with an alpha-parallel system of arcs. The type- $D$  module  $\mathcal{H}_\Lambda^{\mathcal{K} \otimes \mathcal{K}}$  is as follows:*

$$\begin{array}{ccccc} \partial^1 \rightrightarrows & \mathcal{H}_{0,0} & \xrightarrow{L_1P^1 +^{-L_1P^1}} & \mathcal{H}_{1,0} & \leftarrow \partial^1 \\ & \downarrow & \searrow \text{---} & \downarrow & \\ & L_2F^1 +^{-L_2F^1} & \text{---} & -H \Omega^1 & \text{---} & L_2G^1 +^{-L_2G^1} \\ & \downarrow & & \downarrow & \\ \partial^1 \rightrightarrows & \mathcal{H}_{0,1} & \xrightarrow{L_1Q^1 +^{-L_1Q^1}} & \mathcal{H}_{1,1} & \leftarrow \partial^1 \end{array}$$

where the maps are as follows:

- (1) The map  $\partial^1$  is the ordinary differential of the Hopf link complex. See Equation (16.1).
- (2) The maps denoted  $L_1P^1$ ,  $-L_1P^1$ ,  $L_1Q^1$  and  $-L_1Q^1$  correspond to the length 1 surgery maps for  $\pm L_1$ . The maps  $L_1P^1$  and  $L_1Q^1$  share the same formula as each other, and the maps  $-L_1P^1$  and  $-L_1Q^1$  share the same formula as each other. They are given by the following formulas

(a)

$$\begin{aligned} \mathbf{a} &\longmapsto \mathbf{a} \otimes \sigma_1 \\ L_1P^1 = \mathbf{b} &\longmapsto \mathbf{b} \otimes \sigma_1 \\ \mathbf{c} &\longmapsto \mathbf{c} \otimes \sigma_1 \\ \mathbf{d} &\longmapsto \mathbf{d} \otimes \sigma_1. \end{aligned}$$

(b)

$$\begin{aligned} \mathbf{a} &\longmapsto \mathbf{d} \otimes \mathcal{V}_1^{\lambda_1 - 1} \tau_1 \\ -L_1P^1 = \mathbf{b} &\longmapsto 0 \\ \mathbf{c} &\longmapsto \mathbf{b} \otimes \mathcal{V}_1^{\lambda_1 + 1} \tau_1 + \mathbf{c} \otimes \mathcal{W}_2 \mathcal{V}_1^{\lambda_1} \tau_1 \\ \mathbf{d} &\longmapsto \mathbf{d} \otimes \mathcal{W}_2 \mathcal{V}_1^{\lambda_1} \tau_1. \end{aligned}$$

- (3) The maps  $L_2F^1$  and  $-L_2F^1$  are the surgery maps for the component  $L_2$ , with  $L_1$  unreduced. They are given by the following formulas:

(a)

$$\begin{aligned}
L_2 F^1 = \begin{aligned} & \mathbf{a} \longmapsto \mathbf{a} \otimes \sigma_2 \\ & \mathbf{b} \longmapsto \mathbf{b} \otimes \sigma_2 \\ & \mathbf{c} \longmapsto \mathbf{c} \otimes \sigma_2 \\ & \mathbf{d} \longmapsto \mathbf{d} \otimes \sigma_2. \end{aligned}
\end{aligned}$$

(b)

$$\begin{aligned}
-L_2 F^1 = \begin{aligned} & \mathbf{a} \longmapsto \mathbf{a} \otimes \mathcal{U}_1 \mathcal{V}_2^{\lambda_2} \tau_2 \\ & \mathbf{b} \longmapsto 0 \\ & \mathbf{c} \longmapsto \mathbf{b} \otimes \mathcal{V}_2^{\lambda_2+1} \tau_2 + \mathbf{c} \otimes \mathcal{U}_1 \mathcal{V}_2^{\lambda_2} \tau_2 \\ & \mathbf{d} \longmapsto \mathbf{a} \otimes \mathcal{V}_2^{\lambda_2-1} \tau_2 \end{aligned}
\end{aligned}$$

The maps  $L_2 G^1$  and  $-L_2 G^1$  are the surgery maps  $L_2$ , with  $L_1$  already reduced. They are given by the same formulas.

(4) The map  $-H\Omega^1$  is the length 2 surgery map for  $-H = -L_1 \cup -L_2$ . This map takes the following form

$$\begin{aligned}
-H\Omega^1 = \begin{aligned} & \mathbf{a} \longmapsto \mathbf{c} \otimes \mathcal{V}_1^{\lambda_1-2} \mathcal{V}_2^{\lambda_2-1} \tau_1 \tau_2 \\ & \mathbf{b} \longmapsto 0 \\ & \mathbf{c} \longmapsto \mathbf{d} \otimes \mathcal{V}_1^{\lambda_1-1} \mathcal{V}_2^{\lambda_2} \tau_1 \tau_2 \\ & \mathbf{d} \longmapsto \mathbf{c} \otimes \mathcal{V}_1^{\lambda_1-1} \mathcal{V}_2^{\lambda_2-2} \tau_1 \tau_2. \end{aligned}
\end{aligned}$$

We leave the verification of the above lemma to the reader as it is mostly a restatement of Lemma 16.1 using the notation from Section 8.6.

**16.3. The  $\alpha\beta$ -model of the Hopf link complex.** In this section, we compute the type- $D$  module of the Hopf link complex when we use an arc system such that one arc is alpha-parallel and the other is beta-parallel. We write  $\overline{\mathcal{H}}_\Lambda^{\mathcal{K} \otimes \mathcal{K}}$  for the associated type- $D$  module.

**Proposition 16.7.** *The type- $D$  module  $\overline{\mathcal{H}}_\Lambda^{\mathcal{K} \otimes \mathcal{K}}$  is identical to the module  $\mathcal{H}_\Lambda^{\mathcal{K} \otimes \mathcal{K}}$ , except that we delete the term  $\mathbf{c} \mapsto \mathbf{d} \otimes \mathcal{V}_1^{\lambda_1-1} \mathcal{V}_2^{\lambda_2} \tau_1 \tau_2$  from  $\delta^1$ .*

*Proof.* We may use Theorem 14.1 and the transformer bimodule to change one of the arcs from alpha-parallel to beta-parallel. Accordingly, we have that

$$\overline{\mathcal{H}}_\Lambda^{\mathcal{K}_1 \otimes \mathcal{K}_2} = \mathcal{H}_\Lambda^{\mathcal{K}_1 \otimes \mathcal{K}_2}.$$

We claim that the above tensor product description of  $\overline{\mathcal{H}}_\Lambda^{\mathcal{K}_1 \otimes \mathcal{K}_2}$  coincides exactly with the module described in the statement. This is verified by a direct computation. We compute  $\mathcal{H}_\Lambda^{\mathcal{K}_1 \otimes \mathcal{K}_2} \hat{\boxtimes}_{\mathcal{K}_1} \mathcal{T}^{\mathcal{K}_1}$ . The diagram which adds the extra length 2 differential is

the following:

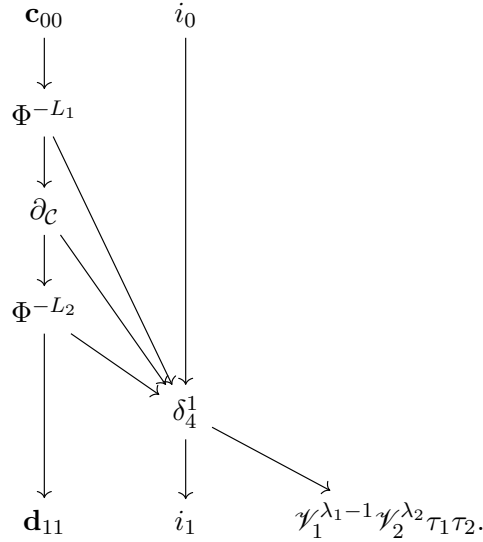

□

*Remark 16.8.* In our proof of Proposition 16.1, we observed that all of the maps in the Hopf link complex were uniquely determined except for the length 2 map, and there were two choices, up to overall homotopy. We wrote  $H_1$  and  $H_2$  for these maps. We proved that  $H_2$  was the correct choice when the system of arcs was alpha-parallel. We observe that the above model of  $\overline{\mathcal{H}}_\Lambda^{\mathcal{L}^2}$  corresponds exactly to the other choice of homotopy.

### 17. MINIMAL MODELS FOR THE HOPF LINK SURGERY COMPLEX

In this section, we consider the link surgery complex for the Hopf link as a  $DA$ -bimodule. We do this via a tensor product

$$\kappa \mathcal{H}_\Lambda^\kappa := \mathcal{H}_\Lambda^{\kappa \otimes \kappa} \hat{\boxtimes} \kappa | \kappa [\mathbb{I}^\boxplus].$$

In the above, just one algebra output of  $\mathcal{H}_\Lambda^{\kappa \otimes \kappa}$  is input into  $\kappa | \kappa [\mathbb{I}^\boxplus]$ . In this section, we will explore a minimal model of the Hopf link complex  $\kappa \mathcal{H}_\Lambda^\kappa$ , for which we will write  $\kappa \mathcal{Z}^\kappa$ . We will also compute a minimal model of the complex  $\kappa \overline{\mathcal{H}}_\Lambda^\kappa$  obtained by using both alpha and beta parallel arcs on the Hopf link.

**17.1.  $DA$ -perspectives on the Hopf link complex.** In this section, we describe several  $A_\infty$  interpretations of the Hopf link complex. We will describe how to think of the Hopf link as a type- $D$  module or a type- $DA$  module. This perspective was first explored in [HHSZ22].

Write  $H = L_1 \cup L_2$  for the Hopf link. Write  $P_1 = \mathbb{F}[\mathcal{U}_1, \mathcal{V}_1]$  and  $P_2 = \mathbb{F}[\mathcal{U}_2, \mathcal{V}_2]$ , where  $P_i$  contains the variables for  $L_i$ . Let us write  $\mathcal{C}$  for  $\mathcal{CFL}(H)$ .

We may view  $\mathcal{C}$  as a type- $D$  module over  $P_2$ . We do this by viewing  $\mathcal{C}^{P_2}$  as freely generated by  $\mathbf{a}$ ,  $\mathbf{b}$ ,  $\mathbf{c}$  and  $\mathbf{d}$  over  $P_1$ . The structure map  $\delta^1$  is shown below:

$$\mathcal{C}^{P_2} \cong \begin{array}{ccc} \mathbf{a} \xleftarrow{-1|\mathcal{U}_2} & \mathbf{b} & \\ \uparrow \mathcal{V}_1|1 & & \downarrow \mathcal{U}_1|1 \\ \mathbf{c} \xrightarrow{-1|\mathcal{V}_2} & \mathbf{d} & \end{array} \quad (17.1)$$

An arrow from  $\mathbf{x}$  to  $\mathbf{y}$  labeled by  $a|b$  indicates that  $\delta^1(\mathbf{x})$  has a summand of  $(a \cdot \mathbf{y}) \otimes b$ .

It is helpful to realize that the above description of  $\mathcal{C}^{P_2}$  may be further decomposed as a box tensor product, as follows. Let  $\Lambda_2$  denote the exterior algebra on two generators

$$\Lambda_2 := \Lambda^*(\phi_2, \psi_2).$$

We consider the following type- $DD$  bimodule  ${}^{\Lambda_2}\mathcal{K}^{P_2}$ . As a vector space,  $\mathcal{K} \cong \mathbb{F}$ . The type- $DD$  structure map is given by the formula

$$\delta^{1,1}(1) = \phi_2|1|\mathcal{U}_2 + \psi_2|1|\mathcal{V}_2.$$

We may define a type- $A$  module  $\mathcal{C}_{\Lambda_2}$ , generated freely over  $P_1$  by  $\mathbf{a}$ ,  $\mathbf{b}$ ,  $\mathbf{c}$  and  $\mathbf{d}$ , with module structure given by the following diagram

$$\mathcal{C}_{\Lambda_2} = \begin{array}{ccc} \mathbf{a} \xleftarrow{\phi_2} & \mathbf{b} & \\ \uparrow \mathcal{V}_1 & & \downarrow \mathcal{U}_1 \\ \mathbf{c} \xrightarrow{\psi_2} & \mathbf{d} & \end{array}$$

In the above, solid arrows denote the  $m_2$  actions of  $\Lambda_2$ , while the dashed arrows denote the  $m_1$  actions (i.e. internal differentials). To illustrate the notation, if  $f \in \mathbb{F}[\mathcal{U}_1, \mathcal{V}_1]$ , then

$$m_2(f \cdot \mathbf{b}, \phi_2) = f \cdot \mathbf{a} \quad \text{and} \quad m_1(f \cdot \mathbf{b}) = \mathcal{U}_1 \cdot f \cdot \mathbf{d}.$$

The action of  $\psi_2$  is similar.

Clearly, there is an isomorphism of type- $D$  modules

$$\mathcal{C}^{P_2} \cong \mathcal{C}_{\Lambda_2} \boxtimes {}^{\Lambda_2}\mathcal{K}^{P_2}.$$

In the above, we have forgotten about the natural action of  $P_1$ , given by ordinary multiplication. In fact, we may incorporate additionally this action to obtain bimodules  ${}_{P_1}\mathcal{C}^{P_2}$  and  ${}_{P_1}\mathcal{C}_{\Lambda_2}$ , such that

$${}_{P_1}\mathcal{C}^{P_2} \cong {}_{P_1}\mathcal{C}_{\Lambda_2} \boxtimes {}^{\Lambda_2}\mathcal{K}^{P_2}.$$

The module  ${}_{P_1}\mathcal{C}^{P_2}$  has only  $\delta_1^1$  and  $\delta_2^1$  non-trivial, and  ${}_{P_1}\mathcal{C}_{\Lambda_2}$  has only  $m_{0,1,0}$ ,  $m_{1,1,0}$  and  $m_{0,1,1}$  non-trivial. In the next section, we explore minimal models.

**17.2. Minimal models for the Hopf link Floer complex.** We apply the homological perturbation lemma to obtain minimal models of the Hopf link bimodules from the previous section. We will define a  $DA$ -bimodule  ${}_{P_1}Z^{P_2}$  which is homotopy equivalent to  ${}_{P_1}\mathcal{C}^{P_2}$  and which has  $\delta_1^1 = 0$ . The techniques of this section formalize the construction in [HHSZ22].

First define the chain complex  $\mathcal{C}_0$  by forgetting about the  $\Lambda_2$ -action on  $\mathcal{C}_{\Lambda_2}$ . Over  $\mathbb{F}_2$ ,  $\mathcal{C}_0$  is homotopy equivalent to its homology, which we view as the vector space

$$Z := \langle \mathbf{a} \rangle[\mathcal{U}_1] \oplus \langle \mathbf{d} \rangle[\mathcal{V}_1].$$

Here,  $\langle \mathbf{a} \rangle[\mathcal{U}_1]$  denotes a copy of  $\mathbb{F}[\mathcal{U}_1]$ , generated by  $\mathbf{a}$ , and similarly for  $\langle \mathbf{d} \rangle[\mathcal{V}_1]$ . There are natural maps

$$i: Z \rightarrow \mathcal{C}_0 \quad \pi: \mathcal{C}_0 \rightarrow Z, \quad \text{and} \quad h: \mathcal{C}_0 \rightarrow \mathcal{C}_0$$

such that  $i$  and  $\pi$  are chain maps,  $i \circ \pi = \text{id} + [m_1, h]$ ,  $\pi \circ i = \text{id}$ ,  $h \circ i = 0$ ,  $\pi \circ h = 0$  and  $h \circ h = 0$ . The map  $i$  is given by

$$i(\mathcal{U}_1^n \mathbf{a}) = \mathcal{U}_1^n \mathbf{a} \quad \text{and} \quad i(\mathcal{V}_1^n \mathbf{d}) = \mathcal{V}_1^n \mathbf{d}.$$

The map  $\pi$  is given by

$$\pi(\mathcal{U}_1^n \mathcal{V}_1^m \mathbf{a}) = \begin{cases} \mathcal{U}_1^n \mathbf{a} & \text{if } m = 0 \\ 0 & \text{otherwise,} \end{cases} \quad \text{and} \quad \pi(\mathcal{U}_1^n \mathcal{V}_1^m \mathbf{d}) = \begin{cases} \mathcal{V}_1^m \mathbf{d} & \text{if } n = 0 \\ 0 & \text{otherwise.} \end{cases}$$

The map  $h$  is given by

$$h(\mathcal{U}_1^n \mathcal{V}_1^m \mathbf{a}) = \begin{cases} \mathcal{U}_1^n \mathcal{V}_1^{m-1} \mathbf{c} & \text{if } m \geq 1 \\ 0 & \text{otherwise,} \end{cases} \quad \text{and} \quad h(\mathcal{U}_1^n \mathcal{V}_1^m \mathbf{d}) = \begin{cases} \mathcal{U}_1^{n-1} \mathcal{V}_1^m \mathbf{b} & \text{if } n \geq 1 \\ 0 & \text{otherwise.} \end{cases}$$

The homological perturbation lemma for  $A_\infty$ -modules, Lemma 4.1, endows  $Z$  with a right action of  $\Lambda_2$ , for which we write  $Z_{\Lambda_2}$ , which is  $A_\infty$ -homotopy equivalent to  $\mathcal{C}_{\Lambda_2}$ . In fact, the homotopy equivalence is given explicitly by the homological perturbation lemma. The maps  $i$ ,  $\pi$  and  $h$  extend to  $A_\infty$ -module morphisms  $i_*$ ,  $\pi_*$  and  $h_*$ . We box these morphisms with the identity map on  ${}^{\Lambda_2} \mathcal{X}^{P_2}$  to obtain maps of type- $D$  modules

$$\Pi^1: \mathcal{C}^{P_2} \rightarrow Z^{P_2}, \quad I^1: Z^{P_2} \rightarrow \mathcal{C}^{P_2} \quad \text{and} \quad H^1: \mathcal{C}^{P_2} \rightarrow \mathcal{C}^{P_2}.$$

**Lemma 17.1.** *The morphisms  $I^1$  and  $\Pi^1$  are type- $D$  homomorphisms (i.e.  $\partial_{\text{Mor}}(I^1) = 0$  and  $\partial_{\text{Mor}}(\Pi^1) = 0$ ). Furthermore*

- (1)  $\Pi^1 \circ I^1 = \text{id}$
- (2)  $H^1 \circ H^1 = 0$ .
- (3)  $H^1 \circ I^1 = 0$ .
- (4)  $\Pi^1 \circ H^1 = 0$ .
- (5)  $I^1 \circ \Pi^1 = \text{id} + \partial_{\text{Mor}}(H^1)$ .

*Proof.* Lemma 4.1 (the homological perturbation lemma) implies that the stated formulas hold for  $i_*$ ,  $h_*$  and  $\pi_*$ . Boxing with the identity map preserves these relations since the algebra is  $\Lambda_2$  (which is an associative algebra), so

$$(f_* \boxtimes \mathbb{I}_{\mathcal{X}}) \circ (g_* \boxtimes \mathbb{I}_{\mathcal{X}}) = ((f_* \circ g_*) \boxtimes \mathbb{I}_{\mathcal{X}}),$$

by [LOT15, Remark 2.2.28]. Furthermore boxing with the identity is a chain map:

$$\partial_{\text{Mor}}(f_* \boxtimes \mathbb{I}_{\mathcal{X}}) = (\partial_{\text{Mor}}(f_*) \boxtimes \mathbb{I}_{\mathcal{X}}).$$

See [LOT15, Lemma 2.3.3 (1)]. □

It is enlightening to compute concrete formulas for the morphisms  $\Pi^1$ ,  $H^1$  and  $I^1$ :

**Lemma 17.2.**

- (1)  $I^1$  is given by  $I^1(\mathbf{x}) = \mathbf{x} \otimes 1$ , for  $\mathbf{x} \in Z$ .

(2)  $\Pi^1$  vanishes on  $\text{Span}(\mathbf{c}, \mathbf{d})$ , and satisfies:

$$\begin{aligned}\Pi^1(\mathcal{U}_1^i \mathcal{V}_1^j \mathbf{a}) &= \begin{cases} \mathcal{U}_1^{i-j} \mathbf{a} \otimes \mathcal{U}_2^j \mathcal{V}_2^j & \text{if } i \geq j \\ \mathcal{V}_1^{j-i-1} \mathbf{d} \otimes \mathcal{U}_2^i \mathcal{V}_2^{i+1} & \text{if } i < j \end{cases} \\ \Pi^1(\mathcal{U}_1^i \mathcal{V}_1^j \mathbf{d}) &= \begin{cases} \mathcal{U}_1^{i-j-1} \mathbf{a} \otimes \mathcal{U}_2^{j+1} \mathcal{V}_2^j & \text{if } i > j \\ \mathcal{V}_1^{j-i} \mathbf{d} \otimes \mathcal{U}_2^i \mathcal{V}_2^i & \text{if } i \leq j. \end{cases}\end{aligned}$$

(3)  $H^1$  vanishes on  $\text{Span}(\mathbf{b}, \mathbf{c})$ , and maps  $\text{Span}(\mathbf{a}, \mathbf{d})$  to  $\text{Span}(\mathbf{c}, \mathbf{b}) \otimes P_2$ . It is given by the formula

$$H^1(\mathcal{U}_1^i \mathcal{V}_1^j \mathbf{a}) = \begin{cases} \mathcal{U}_1^i \mathcal{V}_1^{j-1} \mathbf{c} \otimes 1 + \mathcal{U}_1^{i-1} \mathcal{V}_1^{j-1} \mathbf{b} \otimes \mathcal{V}_2 + \dots + \mathcal{U}_1^{i-j} \mathbf{b} \otimes \mathcal{U}_2^{j-1} \mathcal{V}_2^j & \text{if } j \leq i \\ \mathcal{U}_1^i \mathcal{V}_1^{j-1} \mathbf{c} \otimes 1 + \mathcal{U}_1^{i-1} \mathcal{V}_1^{j-1} \mathbf{b} \otimes \mathcal{V}_2 + \dots + \mathcal{V}_1^{j-i-1} \mathbf{c} \otimes \mathcal{U}_2^i \mathcal{V}_2^i & \text{if } j > i. \end{cases}$$

and

$$H^1(\mathcal{U}_1^i \mathcal{V}_1^j \mathbf{d}) = \begin{cases} \mathcal{U}_1^{i-1} \mathcal{V}_1^j \mathbf{b} \otimes 1 + \mathcal{U}_1^{i-1} \mathcal{V}_1^{j-1} \mathbf{c} \otimes \mathcal{U}_2 + \dots + \mathcal{U}_1^{i-j-1} \mathbf{b} \otimes \mathcal{U}_2^j \mathcal{V}_2^j & \text{if } i > j \\ \mathcal{U}_1^{i-1} \mathcal{V}_1^j \mathbf{b} \otimes 1 + \mathcal{U}_1^{i-1} \mathcal{V}_1^{j-1} \mathbf{c} \otimes \mathcal{U}_2 + \dots + \mathcal{V}_1^{j-i} \mathbf{c} \otimes \mathcal{U}_2^j \mathcal{V}_2^{j-1} & \text{if } i \leq j. \end{cases}$$

*Proof.* Lemma 4.1 gives a concrete formula for the  $A_\infty$ -action on  $Z_{\Lambda_2}$ . We will prove the first statement, and also compute  $\Pi^1(\mathcal{U}_1^i \mathcal{V}_1^j \mathbf{a})$  when  $i \geq j$  in order to illustrate the technique. We will leave the remaining cases to the reader.

Firstly, we begin with  $I^1$ . We are boxing with  $\mathbb{I}_{\mathcal{X}}$ , so suppose that  $a_1 | \dots | a_n | 1 | b_n | \dots | b_1$  is the output of repeated applications of  $\delta^{1,1}$  on  $\Lambda_2 \mathcal{X} P_2$ . The homological perturbation lemma gives a recipe for  $m_{n+1}^Z(\mathbf{x}, a_1, \dots, a_n)$ . See Figure 4.1. The recipe is to include  $\mathbf{x}$  into  $\mathcal{C}$  via  $i$ . We then apply  $m_2(-, a_1)$ , then  $h$ , then  $m_2(-, a_2)$ , then  $h$ , and so forth, until one applies  $m(-, a_n)$ . Then we apply  $\pi$ . The algebra output is the product  $b_n \dots b_1$ . The  $m_2$  action of  $\Lambda_2$  on  $\mathcal{C}$  vanishes on the image of  $i$ , so there are no contributions unless  $n = 0$ . The formula follows.

We now compute  $\Pi^1(\mathcal{U}_1^i \mathcal{V}_1^j \mathbf{a})$  for  $i \geq j$ . We begin at  $\mathcal{U}_1^i \mathcal{V}_1^j \mathbf{a} \in \mathcal{C}$ . If  $j = 0$ , then  $h(\mathcal{U}_1^i \mathcal{V}_1^j \mathbf{a}) = 0$ , so our only option is to apply  $\pi$ , which gives  $\mathcal{U}_1^i \mathbf{a}$  as claimed. If  $j > 0$ , the only option is to apply  $h$  to get  $\mathcal{U}_1^i \mathcal{V}_1^{j-1} \mathbf{c}$ . Then we apply  $m_2(-, \psi_2)$  which gives  $\mathcal{U}_1^i \mathcal{V}_1^{j-1} \mathbf{d} \otimes \mathcal{V}_2$ . We then apply  $h$  and  $m_2(-, \phi_2)$  and we get  $\mathcal{U}_1^{i-1} \mathcal{V}_1^{j-1} \mathbf{a} \otimes \mathcal{U}_2 \mathcal{V}_2$ . We repeat this procedure until we cannot apply  $h$  or  $m_2$  any more. In the case that  $i \geq j$ , the final term in this sequence will be  $\mathcal{U}_1^{i-j} \mathbf{a} \otimes \mathcal{U}_2^j \mathcal{V}_2^j$ . All of the remaining claims follow a similar analysis.  $\square$

Lemma 17.1 allows us to apply the homological perturbation lemma of  $DA$ -bimodules, Lemma 4.2, which equips  $Z$  with a  $DA$ -bimodule structure  $P_1 Z^{P_2}$ , and supplies morphisms of  $DA$ -bimodules

$$\Pi_*^1: P_1 \mathcal{C}^{P_2} \rightarrow P_1 Z^{P_2}, \quad I_*^1: P_1 Z^{P_2} \rightarrow P_1 \mathcal{C}^{P_2} \quad \text{and} \quad H_*^1: P_1 \mathcal{C}^{P_2} \rightarrow P_1 \mathcal{C}^{P_2}$$

which satisfy relations identical to Lemma 17.1.

**Lemma 17.3.**

- (1) The structure maps  $\delta_j^1$  on  $P_1 Z^{P_2}$  vanish if  $j \neq 2$ .
- (2) The maps  $\Pi_j^1$  and  $H_j^1$  vanish unless  $j = 1$ .
- (3) The map  $I_j^1$  vanishes if  $j > 2$ .

- (4) The maps  $\delta_*^1$  and  $I_*^1$  are strictly unital i.e. they vanish if 1 is an input, except for  $\delta_2^1$ , which satisfies  $\delta_2^1(1 \otimes x) = x \otimes 1$ . (Note that  $H_j^1$  and  $\Pi_j^1$  are trivially unital, since they are only non-trivial if  $j = 1$ ).

*Proof.* The proofs of all statements are by explicit examination of the maps from the homological perturbation lemma.

We begin with the statements about  $\delta_j^1$ . Consider first a sequence of algebra elements  $(a_n, \dots, a_1)$  in  $P_1$ . The rule for computing  $\delta_j^1$  is to input via  $I^1$ , then apply  $m_2$ , then we apply pairs of  $H^1$  followed by  $m_2$  until we exhaust  $(a_n, \dots, a_1)$ , and then finally we apply  $\Pi_1$ . The algebra elements output are multiplied together by applying  $\mu_2$  repeatedly. However applying  $m_2$  does not move an elements position in  $\mathcal{C}$  (i.e.  $\mathbf{a}$ ,  $\mathbf{b}$ ,  $\mathbf{c}$  or  $\mathbf{d}$ ). The map  $H^1$  does change the generator, and it maps  $\text{Span}(\mathbf{a}, \mathbf{d})$  to  $\text{Span}(\mathbf{c}, \mathbf{b}) \otimes P_2$ , and vanishes on  $\text{Span}(\mathbf{c}, \mathbf{b})$ . If we apply another  $m_2$ , we remain in  $\text{Span}(\mathbf{c}, \mathbf{b})$ . We note that  $\Pi^1$  and  $H^1$  both vanish on  $\text{Span}(\mathbf{c}, \mathbf{b})$ . In particular, the only terms making non-trivial contribution are those with one  $\delta_2^1$ , and no  $H^1$  term. The same argument shows that  $\Pi_k^1$  and  $H_k^1$  vanish if  $k > 1$ .

To compute the map  $I_{j+1}^1(a_j, \dots, a_1, \mathbf{x})$ , the recipe is to first include  $\mathbf{x}$  into  $\mathcal{C} \otimes P_2$  via  $I^1$ . This includes  $\mathbf{x}$  into  $\text{Span}(\mathbf{a}, \mathbf{d}) \otimes P_2$ . We then apply  $\delta_2^1(a_1, -)$ . This preserves  $\text{Span}(\mathbf{a}, \mathbf{d}) \otimes P_2$ . Next we apply  $H^1$ , which maps  $\text{Span}(\mathbf{a}, \mathbf{d}) \otimes P_2$  to  $\text{Span}(\mathbf{b}, \mathbf{c}) \otimes P_2$ . Any further applications of  $\delta_2^1(a_n, -)$  followed by  $H^1$  would map to zero. Hence we may have  $I_2^1$ , but not  $I_j^1$  for  $j > 2$ .

The final statement about strict unality follows from the homological perturbation lemma.  $\square$

It is helpful to explicitly compute  $\delta_2^1$  on  ${}_{P_1}Z^{P_2}$ . Since there is no  $\delta_j^1$  for  $j > 2$  by Lemma 17.3, we compute only  $\delta_2^1(\mathcal{U}_1, -)$  and  $\delta_2^1(\mathcal{V}_1, -)$ .

**Lemma 17.4.** *The map  $\delta_2^1$  on  ${}_{P_1}Z^{P_2}$  satisfies the following.*

- (1)  $\delta_2^1(\mathcal{U}_1, \mathcal{U}_1^n \mathbf{a}) = \mathcal{U}_1^{n+1} \mathbf{a} \otimes 1$ .
- (2)  $\delta_2^1(\mathcal{V}_1, \mathcal{U}_1^n \mathbf{a}) = \begin{cases} \mathcal{U}_1^{n-1} \mathbf{a} \otimes \mathcal{U}_2 \mathcal{V}_2 & \text{if } n > 0 \\ \mathbf{d} \otimes \mathcal{V}_2 & \text{if } n = 0. \end{cases}$
- (3)  $\delta_2^1(\mathcal{V}_1, \mathcal{V}_1^m \mathbf{d}) = \mathcal{V}_1^{m+1} \mathbf{d} \otimes 1$ .
- (4)  $\delta_2^1(\mathcal{U}_1, \mathcal{V}_1^m \mathbf{d}) = \begin{cases} \mathcal{V}_1^{m-1} \mathbf{d} \otimes \mathcal{U}_2 \mathcal{V}_2 & \text{if } m > 0 \\ \mathbf{a} \otimes \mathcal{U}_2 & \text{if } m = 0. \end{cases}$

Finally, the complex  $\mathcal{V}_1^{-1} \mathcal{C}$  will also be important to understand. Similarly to  $\mathcal{C}$ , this complex also has a simple minimal model, for which we write  ${}_{\mathcal{V}_1^{-1} P_1} W^{P_2}$ . As a vector space  $W \cong \mathbb{F}[\mathcal{V}_1, \mathcal{V}_1^{-1}]$ . We view  $W$  as being generated by  $\mathcal{V}_1^i \mathbf{d}$  for  $i \in \mathbb{Z}$ . The same homological perturbation argument as before equips  $W$  with bimodule structure  ${}_{\mathcal{V}_1^{-1} P_1} W^{P_2}$  which has  $\delta_j^1 = 0$  unless  $j = 2$ . For completeness we record the actions:

**Lemma 17.5.** *The bimodule  ${}_{\mathcal{V}_1^{-1} P_1} W^{P_2}$  has the following action:*

$$\delta_2^1(\mathcal{U}_1^i \mathcal{V}_1^j, \mathcal{V}_1^n \mathbf{d}) = \mathcal{V}_1^{j+n-i} \mathbf{d} \otimes \mathcal{U}_2^i \mathcal{V}_2^i.$$

We leave the proofs of Lemma 17.4 and 17.5 to the reader.



**17.3. Minimal models over  $\mathcal{K}$ .** In this section, we describe a minimal model of the  $DA$ -bimodule  $\kappa_1 \mathcal{H}_{(\lambda_1, 0)}^{\mathcal{K}_2}$ . We will denote the minimal model by

$$\kappa_1 \mathcal{Z}_{(\lambda_1, 0)}^{\mathcal{K}_2}.$$

The existence of the minimal model follows from the homological perturbation lemma for hypercubes of  $DA$ -bimodules. From the description of  $\kappa_1 \mathcal{H}_{(\lambda_1, 0)}^{\mathcal{K}_2}$  it is clear that there is a filtration by the cube  $\mathbb{E}_2$ . In Section 17.2, we described minimal models of  $\mathcal{CFL}(H)^{\mathbb{F}[\mathcal{U}_2, \mathcal{V}_2]}$  and  $\mathcal{V}_1^{-1} \mathcal{CFL}(H)^{\mathbb{F}[\mathcal{U}_2, \mathcal{V}_2]}$ . Note that we may identify the underlying type- $D$  module  $\mathcal{H}_\varepsilon^{\mathcal{K}_2}$  with one of these type- $D$  modules, for  $\varepsilon \in \mathbb{E}_2$ . Hence, the construction from Section 17.2 may be viewed as giving morphisms of type- $D$  structures

$$\Pi_\varepsilon^1: \mathcal{H}_\varepsilon^{\mathcal{K}_2} \rightarrow \mathcal{Z}_\varepsilon^{\mathcal{K}_2}, \quad I_\varepsilon^1: \mathcal{Z}_\varepsilon^{\mathcal{K}_2} \rightarrow \mathcal{H}_\varepsilon^{\mathcal{K}_2} \quad \text{and} \quad H_\varepsilon^1: \mathcal{H}_\varepsilon^{\mathcal{K}_2} \rightarrow \mathcal{H}_\varepsilon^{\mathcal{K}_2}$$

which induce a homotopy equivalence of type- $D$  structures, such that furthermore the algebraic assumptions of the homological perturbation lemma are satisfied. We obtain a homotopy equivalent hypercube of  $DA$ -bimodules  $\kappa_1 \mathcal{Z}_{(\lambda_1, 0)}^{\mathcal{K}_2}$  by applying the homological perturbation lemma for hypercubes of  $DA$ -bimodules, Lemma 4.5. We now schematically sketch the induced type- $D$  structure map:

$$\begin{array}{ccc} \mathcal{Z}_{0,0} & \mathcal{Z}_{1,0} & m_2^1 \xrightarrow{\quad} \mathcal{Z}_{0,0} \xrightarrow{-L_1 p_2^1 + -L_1 p_2^1} \mathcal{Z}_{1,0} \xleftarrow{\quad} m_2^1 \\ \delta_1^1 = \begin{array}{c} \downarrow \\ L_2 f_1^1 + -L_2 f_1^1 \\ \downarrow \\ \mathcal{Z}_{0,1} \end{array} & \begin{array}{c} \downarrow \\ L_2 g_1^1 + -L_2 g_1^1 \\ \downarrow \\ \mathcal{Z}_{1,1} \end{array} & \delta_2^1 = \begin{array}{c} \downarrow \\ m_2^1 \xrightarrow{\quad} \mathcal{Z}_{0,1} \xrightarrow{-L_1 q_2^1 + -L_1 q_2^1} \mathcal{Z}_{1,1} \xleftarrow{\quad} m_2^1 \end{array} \\ & & \delta_3^1 = \begin{array}{ccc} & \mathcal{Z}_{0,0} & \mathcal{Z}_{1,0} \\ & \searrow^{-H_\omega_3^1} & \downarrow \\ & \mathcal{Z}_{0,1} & \mathcal{Z}_{1,1} \end{array} \end{array}$$

**Proposition 17.6.** *Give the negative Hopf link framing  $(\lambda_1, 0)$ . The structure maps of the minimal model  $\kappa_1 \mathcal{Z}_{(\lambda_1, 0)}^{\mathcal{K}_2}$  are as follows:*

- (1) The maps  $m_2^1$  are the same as the  $\delta_2^1$  maps in Lemmas 17.4 and 17.5.
- (2) The maps  $L_1 p_2^1$  and  $L_1 q_2^1$  are given by the same formulas as each other, as are  $-L_1 p_2^1$  and  $-L_1 q_2^1$ . They are determined by the following formulas:
  - (a)  $L_1 p_2^1(\sigma_1, \mathcal{U}_1^i \mathbf{a}) = \mathcal{V}_1^{-i-1} \mathbf{d} \otimes \mathcal{U}_2^i \mathcal{V}_2^{i+1}$  and  $L_1 p_2^1(\sigma_1, \mathcal{V}_1^j \mathbf{d}) = \mathcal{V}_1^j \mathbf{d} \otimes 1$ .
  - (b)  $-L_1 p_2^1(\tau_1, \mathcal{U}_1^i \mathbf{a}) = \mathcal{V}_1^{-i-1+\lambda_1} \mathbf{d} \otimes 1$  and  $-L_1 p_2^1(\tau_1, \mathcal{V}_1^j \mathbf{d}) = \mathcal{V}_1^{j+\lambda_1} \mathbf{d} \otimes \mathcal{U}_2^{j+1} \mathcal{V}_2^j$ .
  - (c)  $L_1 p_2^1(\tau_1, -) = 0$  and  $-L_1 p_2^1(\sigma_1, -) = 0$ .
- (3) The maps for  $\pm L_2$  are as follows:
  - (a)  $L_2 f_1^1(\mathcal{U}_1^i \mathbf{a}) = \mathcal{U}_1^i \mathbf{a} \otimes \sigma_2$  and  $L_2 f_1^1(\mathcal{V}_1^j \mathbf{d}) = \mathcal{V}_1^j \mathbf{d} \otimes \sigma_2$ .
  - (b)  $-L_2 f_1^1(\mathcal{U}_1^i \mathbf{a}) = \mathcal{U}_1^{i+1} \mathbf{a} \otimes \tau_2$  and
$$-L_2 f_1^1(\mathcal{V}_1^j \mathbf{d}) = \begin{cases} \mathbf{a} \otimes \mathcal{V}_2^{-1} \tau_2 & \text{if } j = 0 \\ \mathcal{V}_1^{j-1} \mathbf{d} \otimes \tau_2 & \text{if } j > 0. \end{cases}$$
  - (c)  $L_2 g_1^1(\mathcal{V}_1^i \mathbf{d}) = \mathcal{V}_1^i \mathbf{d} \otimes \sigma_2$ .
  - (d)  $-L_2 g_1^1(\mathcal{V}_1^i \mathbf{d}) = \mathcal{V}_1^{i-1} \mathbf{d} \otimes \tau_2$ .

(4) The map  $^{-H}\omega_3^1$  is determined by the relations

$$\begin{aligned}^{-H}\omega_3^1(\tau_1, \mathcal{V}_1^m, \mathcal{U}_1^i \mathbf{a}) &= \min(i+1, m) \mathcal{V}_1^{\lambda_1+m-i-2} \mathbf{d} \otimes \mathcal{U}_1^{m-1} \mathcal{V}_1^{m-1} \tau_2 \\^{-H}\omega_3^1(\tau_1, \mathcal{U}_1^n, \mathcal{U}_1^i \mathbf{a}) &= 0 \\^{-H}\omega_3^1(\tau_1, \mathcal{U}_1^n, \mathcal{V}_1^j \mathbf{d}) &= \min(n, j) \mathcal{V}_1^{j-n+\lambda_1-1} \mathbf{d} \otimes \mathcal{U}_1^{j-1} \mathcal{V}_2^{j-2} \tau_2 \\^{-H}\omega_3^1(\tau_1, \mathcal{V}_1^m, \mathcal{V}_1^j \mathbf{d}) &= 0,\end{aligned}$$

and that  $^{-H}\omega_3^1$  vanishes if an algebra input is a multiple of  $\sigma_1$ . The map  $^{-H}\omega_3^1$  also vanishes on pairs of algebra elements with other configurations of idempotents.

The complex  $\kappa_1 \mathcal{Z}_{(0,0)}^{\mathcal{K}^2} \cdot \mathbf{I}_0$  is illustrated in Figure 17.1.

*Remark 17.7.* We have not enumerated a complete list of the structure maps. Additional powers of  $\mathcal{U}_1$  and  $\mathcal{V}_1$  may be added to arguments in the above maps. There are no terms of  $\delta_{j+1}^1$  for  $j > 2$  however. A more minimal list could also have been made by specifying the length 1 maps on only  $\mathbf{a}$  and  $\mathbf{d}$ . As an example of several relations which are forced by the  $DA$  bimodule relations, we have

$$\begin{aligned}^{-H}\omega_3^1(\tau_1, \mathcal{U}_1^i \mathcal{V}_1^j, \mathcal{U}_1^n \mathbf{a}) &= ^{-H}\omega_3^1(\tau, \mathcal{V}_1^j, \mathcal{U}_1^{i+n} \mathbf{a}) \quad \text{and} \\^{-H}\omega_3^1(\tau_1, \mathcal{U}_1^i \mathcal{V}_1^j, \mathcal{V}_1^n \mathbf{d}) &= ^{-H}\omega_3^1(\tau, \mathcal{U}_1^i, \mathcal{V}_1^{j+n} \mathbf{d})\end{aligned}$$

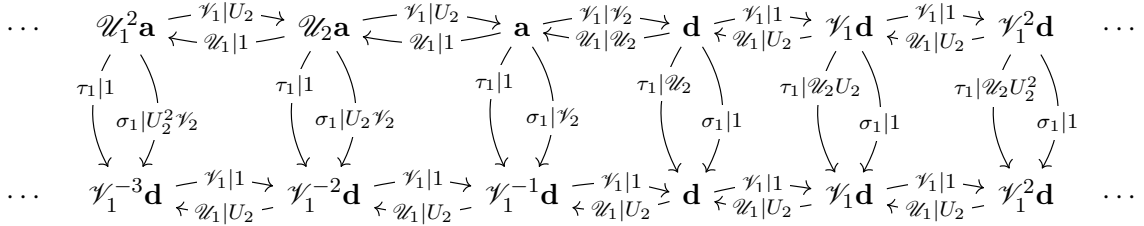
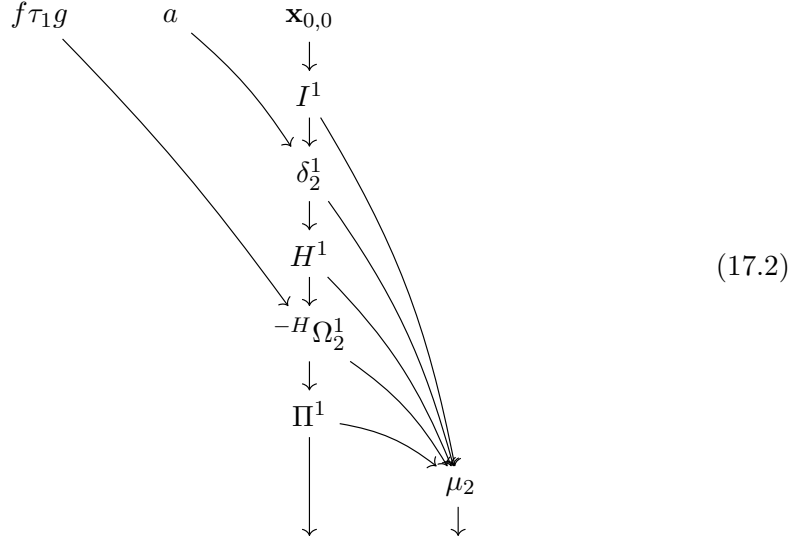

FIGURE 17.1. A portion of the Hopf link complex  $\kappa \mathcal{Z}_{(0,0)}^{\mathcal{K}} \cdot \mathbf{I}_0$ . An arrow decorated with  $a|b$  from  $\mathbf{x}$  to  $\mathbf{y}$  means that  $\delta_2^1(a, \mathbf{x}) = \mathbf{y} \otimes b$ . In the above,  $U_2 = \mathcal{U}_2 \mathcal{V}_2$ .

*Proof.* All of these computations are performed algorithmically using the homological perturbation lemma for hypercubes of  $DA$ -bimodules, Lemma 4.5. For the first two sets of equations the computation is essentially straightforward. We first apply the map  $I_\varepsilon^1$ , then we apply a length 1 map of the cube (either with no algebra input, as for the maps labeled  $f_1^1$  and  $g_1^1$ , or with an algebra input of  $\sigma_1$  or  $\tau_1$ , as for the maps  $p_2^1$  and  $q_2^1$ ). We leave these computations to the reader, as they are straightforward.

The map  $^{-H}\omega_3^1$  is more interesting. There is exactly one configuration of morphism graph which gives a non-trivial evaluation. This occur for elements  $\mathbf{x}_{0,0}$  in idempotent

$\varepsilon = (0, 0)$ . The structure graph is shown below:



We focus on the case that  $f = i_1$  and  $g = i_0$ . Consider first the case that  $\mathbf{x} = \mathcal{U}_1^i \mathbf{a}$ . If  $a_1 = \mathcal{U}_1^n$ , then  $\delta_2^1(\mathcal{U}_1^n, \mathcal{U}_1^i \mathbf{a}) = \mathcal{U}_1^{i+n} \mathbf{a} \otimes 1$ , however  $H^1$  vanishes on this element, so we conclude that

$$-^H\omega_3^1(\tau_1, \mathcal{U}_1^n, \mathcal{U}_1^i \mathbf{a}) = 0.$$

The same argument implies that  $-^H\omega_3^1(\tau_1, \mathcal{V}_1^m, \mathcal{V}_1^j \mathbf{d}) = 0$ .

We now consider the case that  $\mathbf{x} = \mathcal{U}_1^i \mathbf{a}$  and  $a_1 = \mathcal{V}_1^m$ . In this case  $H^1(\mathcal{U}_1^i \mathcal{V}_1^m \mathbf{a})$  is a sum involving both  $\mathbf{c}$  and  $\mathbf{b}$ . The next term in Equation (17.2) is an application of  $-^H\Omega_2^1$ , which vanishes on multiples of  $\mathbf{b}$ . In particular, we need only consider the terms of  $H^1(\mathcal{U}_1^i \mathcal{V}_1^m \mathbf{a})$  involving  $\mathbf{c}$ . There are  $\min(i+1, m)$  such terms. They are

$$\mathcal{U}_1^i \mathcal{V}_1^{m-1} \mathbf{c} \otimes 1 + \mathcal{U}_1^{i-1} \mathcal{V}_1^{m-2} \mathbf{c} \otimes \mathcal{U}_2 \mathcal{V}_2 + \mathcal{U}_1^{i-2} \mathcal{V}_1^{m-3} \mathbf{c} \otimes \mathcal{U}_2^2 \mathcal{V}_2^2 + \dots$$

(The sum is over all terms in the sequence above where  $\mathcal{U}_1$  and  $\mathcal{V}_1$  both have nonnegative exponent). We then apply  $-^H\Omega_2^1$ ,  $\Pi^1$ , and then multiply the outgoing algebra elements by repeatedly applying  $\mu_2$ . It is easy to check that the application of  $-^H\Omega_2^1$ ,  $\Pi^1$ , and  $\mu_2$  on each of the above summands coincide, so we will only consider their evaluation on  $\mathcal{U}_1^i \mathcal{V}_1^{m-1} \mathbf{c} \otimes 1$ . Applying  $-^H\Omega_2^1$  gives

$$T(\mathcal{U}_1^i \mathcal{V}_1^{m-1}) \mathcal{V}_1^{\lambda_1-1} \mathbf{d} \otimes \tau_2 = \mathcal{U}_1^{m-1} \mathcal{V}_1^{2m-3-i} \mathbf{d} \otimes \tau_2.$$

Applying  $\Pi^1$  to the above generator, and then multiplying the algebra elements gives

$$\mathcal{V}_1^{m-i-2} \mathbf{d} \otimes \mathcal{U}_1^{m-1} \mathcal{V}_1^{m-1} \tau_2.$$

There are  $\min(i+1, m)$  such terms, giving the stated formula.

We now consider  $-^H\omega_3^1(\tau_1, \mathcal{U}_1^n, \mathcal{V}_1^j \mathbf{d})$ . The terms of  $H^1(\mathcal{U}_1^n \mathcal{V}_1^j \mathbf{d})$  which involve  $\mathbf{c}$  are

$$\mathcal{U}_1^{n-1} \mathcal{V}_1^{j-1} \mathbf{c} \otimes \mathcal{U}_2 + \mathcal{U}_1^{n-2} \mathcal{V}_1^{j-2} \mathbf{c} \otimes \mathcal{U}_2^2 \mathcal{V}_2 + \dots$$

(As before, the sum contains all such elements in the sequence which have nonnegative powers of both  $\mathcal{U}_1$  and  $\mathcal{V}_1$ ). There are  $\min(n, j)$  terms in this sum. As before, it is

sufficient to evaluate  ${}^{-H}\Omega_2^1$  and  $\Pi^1$  only on the first term, and then multiply the result by  $\min(n, j)$ . Applying  ${}^{-H}\Omega_2^1$ , we obtain

$$T(\mathcal{U}_1^{n-1}\mathcal{V}_1^{j-1})\mathcal{V}_1^{\lambda_1-1}\mathbf{d} \otimes \tau_2\mathcal{U}_2 = \mathcal{U}_1^{j-1}\mathcal{V}_1^{2j-2+\lambda_1-n}\mathbf{d} \otimes \mathcal{V}_2^{-1}\tau_2.$$

Applying  $\Pi^1$  and  $\text{id} \otimes \mu_2$  gives

$$\mathcal{V}_1^{j-n+\lambda_1-1}\mathbf{d} \otimes \mathcal{U}_1^{j-1}\mathcal{V}_2^{j-2}\tau_2,$$

which proves the statement.  $\square$

*Remark 17.8.* Recall that we write  $\kappa_1\overline{\mathcal{H}}_\Lambda^{\mathcal{K}_2}$  for the Hopf link complex obtained by using one alpha-parallel arc and one beta-parallel arc. The associated type- $D$  module over  $\mathcal{K} \otimes \mathcal{K}$  is computed in Proposition 16.7. Write  $\kappa_1\overline{\mathcal{Z}}_\Lambda^{\mathcal{K}_2}$  for the minimal model of the associated type- $DA$  bimodule. We leave it to the reader to verify that  $\kappa_1\overline{\mathcal{Z}}_{(\lambda_1,0)}^{\mathcal{K}_2}$  has an identical description to  $\kappa_1\mathcal{Z}_{(\lambda_1,0)}^{\mathcal{K}_2}$  except that we omit the  $\delta_3^1$  term.

We now prove that  $\kappa_1\mathcal{H}_{(\lambda_1,0)}^{\mathcal{K}_2}$  and  $\kappa_1\mathcal{Z}_{(\lambda_1,0)}^{\mathcal{K}_2}$  are both Alexander modules, and are furthermore homotopy equivalent.

**Lemma 17.9.**

- (1) The  $DA$ -bimodule structure maps on  $\kappa_1\mathcal{H}_{(\lambda_1,0)}^{\mathcal{K}_2}$  and  $\kappa_1\mathcal{Z}_{(\lambda_1,0)}^{\mathcal{K}_2}$  are continuous.
- (2) All of the maps involved in the homotopy equivalences described in Proposition 17.6 are continuous.

*Proof.* The  $DA$ -bimodule structure maps on  $\kappa_1\mathcal{H}_{(\lambda_1,0)}^{\mathcal{K}_2}$  are continuous by virtue of the facts that the map  $\delta^1$  on  $\mathcal{H}_{(\lambda_1,0)}^{\mathcal{K}_1 \otimes \mathcal{K}_2}$  being continuous, since  $\mathcal{H}_{(\lambda_1,0)}$  is a finitely generated vector space, and that  $\kappa_1\mathcal{H}_{(\lambda_1,0)}^{\mathcal{K}_2}$  is obtained by a tensor product of  $\mathcal{H}_{(\lambda_1,0)}^{\mathcal{K}_1 \otimes \mathcal{K}_2}$  with  $\kappa_1|_{\mathcal{K}_1}[\mathbb{I}^\mathbb{Q}]$ .

The structure maps on  $\kappa_1\mathcal{Z}_{(\lambda_1,0)}^{\mathcal{K}_2}$  and also the equivalence with  $\kappa_1\mathcal{H}_{(\lambda_1,0)}^{\mathcal{K}_2}$  are given by the homological perturbation lemma. These maps are finite compositions of the maps  $\Pi^1$ ,  $H^1$ ,  $I^1$ , as well as the map  $\delta_2^1$  of  $\kappa_1\mathcal{H}_{(\lambda_1,0)}^{\mathcal{K}_2}$ . Hence, it is sufficient to show that each of these maps is continuous with respect to the appropriate topology. The map  $I^1$  is obviously continuous, since it is given by  $\mathbf{x} \mapsto \mathbf{x} \otimes 1$ .

Consider the map  $\Pi^1$  applied to elements in  $\mathbf{I}_0 \cdot \mathcal{H}_{(\lambda_1,0)} \cdot \mathbf{I}_0$ . This map is computed in Lemma 17.2. As an example, consider  $\Pi^1(x)$  when  $x = \mathcal{U}_1^i\mathcal{V}_1^j\mathbf{a}$  for  $i \geq j \geq 0$ . In this case,

$$\Pi^1(\mathcal{U}_1^i\mathcal{V}_1^j\mathbf{a}) = \mathcal{U}_1^{i-j}\mathbf{a} \otimes \mathcal{U}_2^j\mathcal{V}_2^j.$$

Given a finite set of  $S \subseteq \mathbb{N}$  and some  $n \in \mathbb{N}$ , we wish to show that all but finitely many  $\mathcal{U}_1^i\mathcal{V}_1^j\mathbf{a}$  are mapped into  $\text{Span}(\mathcal{U}_1^s\mathbf{a} \otimes \mathcal{U}_2^j\mathcal{V}_2^j : s \in \mathbb{N} \setminus S \text{ or } j \geq n)$ . This is the case, since of course there are only finitely many  $i, j \geq 0$  such that  $0 \leq j \leq n$  and  $i - j \in S$ . A similar computation holds for the rest of  $\mathbf{I}_0 \cdot \mathcal{H}_{(\lambda_1,0)} \cdot \mathbf{I}_0$ , so  $\Pi^1$  is continuous in these idempotents. Essentially the same argument applies for the other idempotents of  $\mathcal{H}$ .

The map  $H^1$  is verified to be continuous by a very similar argument.  $\square$

## 18. EXAMPLES AND BASIC PROPERTIES

In this section, we compute some examples. In Section 18.1 we compute the effect of adding a  $\pm 1$  framed meridian to a link component. We show that it corresponds to a simple bimodule. In Section 18.2, we compute the type- $D$  module for a  $p/q$ -framed solid torus. We show that the type- $D$  module for a  $p/q$ -framed solid torus recovers the rational surgeries formula of Ozsváth and Szabó [OS11]. Additionally, we show that the type- $D$  modules for solid tori recovers the surgery exact triangle by exhibiting a homotopy equivalence

$$\mathcal{D}_\infty^\mathcal{K} \simeq \text{Cone}(f^1: \mathcal{D}_n^\mathcal{K} \rightarrow \mathcal{D}_{n+1}^\mathcal{K})$$

for all  $n \in \mathbb{Z}$ .

**18.1. Meridional Dehn twists.** In this section, we consider the effect of adding a  $\pm 1$  framed meridian to a link component. Adding a meridian may be encoded by taking the connected sum with a Hopf link, which has a predictable algebraic effect.

We first define our algebraic candidate, denoted  ${}_{\mathcal{K}}\mathcal{B}_{\pm 1}^\mathcal{K}$ . These are the bimodules for two very simply algebra endomorphisms of  $\mathcal{K}$ . As an  $(\mathbf{I}, \mathbf{I})$ -module,  $\mathcal{B}_{\pm 1} \cong \mathbf{I}$  with the natural  $\mathbf{I}$ -action. The structure map  $\delta_1^1$  vanishes. If  $a \in \mathbf{I}_j \cdot \mathcal{K} \cdot \mathbf{I}_j$  for either  $j = 0$  or  $j = 1$ , then we set  $\delta_2^1(a, i) = i \otimes a$  for  $i \in \mathbf{I}$ . Additionally, we set

$$\delta_2^1(\sigma, i_0) = i_1 \otimes \sigma \quad \text{and} \quad \delta_2^1(\tau, i_0) = i_1 \otimes \mathcal{V}^{\pm 1} \tau.$$

We write  ${}_{\mathcal{K}}\mathcal{M}_{\pm 1}^\mathcal{K}$  for the type- $D$  module

$${}_{\mathcal{K}}\mathcal{M}_{\pm 1}^\mathcal{K} = \mathcal{H}_{(\pm 1, 0)}^{\mathcal{K}_0 \otimes \mathcal{K}_1} \hat{\boxtimes} {}_{\mathcal{K}_0} \mathcal{D}_0 \hat{\boxtimes} {}_{\mathcal{K}_1 | \mathcal{K}} W_l^\mathcal{K}, \quad (18.1)$$

where  $W_l$  is the pair-of-pants module from Section 15. In the above,  $\mathcal{K}$  and  $\mathcal{K}_0$  denote the algebras associated to different components of the Hopf link. We write  $\mathcal{K}_0$  for the algebra associated to the component of the Hopf link which becomes the new meridian (and is framed by  $\pm 1$ ).

By the pairing theorem and Theorem 15.2, adding a  $\pm 1$  framed meridian to a component  $K \subseteq L$  and tensoring  ${}_{\mathcal{K}}\mathcal{D}_0$  into the factor of the meridian has the effect of tensoring with the bimodule  ${}_{\mathcal{K}}\mathcal{M}_{\pm 1}^\mathcal{K}$ .

**Proposition 18.1.** *Let  ${}_{\mathcal{K}}\mathcal{M}_{\pm 1}^\mathcal{K}$  denote the DA-bimodule in Equation (18.1) for adding a  $\pm 1$  framed meridian. Then*

$${}_{\mathcal{K}}\mathcal{M}_{\pm 1}^\mathcal{K} \simeq {}_{\mathcal{K}}\mathcal{B}_{\mp 1}^\mathcal{K}.$$

The proof is a direct computation, which we do in several steps. Firstly, we observe the very basic isomorphism

$${}_{\mathcal{K}_0} \mathcal{D}_0 \cong \mathcal{D}_0^{\mathcal{K}_2} \hat{\boxtimes} {}_{\mathcal{K}_0 | \mathcal{K}_2} M^{\mathcal{K}_3} \hat{\boxtimes} {}_{\mathcal{K}_3} \mathcal{D}_0.$$

(The subscripts on different copies of  $\mathcal{K}$  are meant to indicate only how the tensor product is formed). Hence, we may manipulate several terms in Equation (18.1) as follows:

$$\begin{aligned} \mathcal{H}_{(\pm 1, 0)}^{\mathcal{K}_0 \otimes \mathcal{K}_1} \hat{\boxtimes} {}_{\mathcal{K}_0} \mathcal{D}_0 &\simeq \mathcal{D}_0^{\mathcal{K}_2} \hat{\boxtimes} (\mathcal{H}_{(\pm 1, 0)}^{\mathcal{K}_0 \otimes \mathcal{K}} \hat{\boxtimes} {}_{\mathcal{K}_0 | \mathcal{K}_2} M^{\mathcal{K}_3} \hat{\boxtimes} {}_{\mathcal{K}_3} \mathcal{D}_0) \\ &:= \mathcal{D}_0^{\mathcal{K}_2} \hat{\boxtimes} {}_{\mathcal{K}_2} \mathcal{H}_{(\pm 1, 0)}^{\mathcal{K}_1} \\ &\simeq \mathcal{D}_0^{\mathcal{K}_2} \hat{\boxtimes} {}_{\mathcal{K}_2} \mathcal{Z}_{(\pm 1, 0)}^{\mathcal{K}_1}. \end{aligned} \quad (18.2)$$

On the other hand, we observe by direct computation that

$$\kappa \mathcal{B}_{\pm 1}^{\mathcal{K}} \simeq \mathcal{D}_{\pm 1}^{\mathcal{K}_0} \hat{\boxtimes} \kappa_{0|\mathcal{K}} W_l^{\mathcal{K}}. \quad (18.3)$$

By considering Equations (18.1), (18.2) and (18.3), we observe that to prove Proposition 18.1, it is sufficient to show that

$$\mathcal{D}_0^{\mathcal{K}_1} \hat{\boxtimes} \kappa_1 \mathcal{Z}_{(\pm 1, 0)}^{\mathcal{K}} \simeq \mathcal{D}_{\mp 1}^{\mathcal{K}}. \quad (18.4)$$

Let us write

$$\mathcal{Z}_{(\pm 1, 0)}^{\mathcal{K}} := \mathcal{D}^{\mathcal{K}_1} \hat{\boxtimes} \kappa_1 \mathcal{Z}_{(\pm 1, 0)}^{\mathcal{K}}.$$

We note that the type- $D$  module  $\mathcal{Z}_{(\pm 1, 0)}^{\mathcal{K}}$  is not reduced. Using the notation of Proposition 17.6, the complex  $\mathcal{Z}_{(\pm 1, 0)}^{\mathcal{K}}$  may be written as

$$\mathcal{Z}_{(\pm 1, 0)}^{\mathcal{K}} = \begin{array}{ccc} \mathcal{Z}_{0, 0}^{\mathcal{K}} & \xrightarrow{p_2^1(\sigma_1 + \tau_1, -)} & \mathcal{Z}_{1, 0}^{\mathcal{K}} \\ \downarrow f_1^1 & & \downarrow g_1^1 \\ \mathcal{Z}_{0, 1}^{\mathcal{K}} & \xrightarrow{q_2^1(\sigma_1 + \tau_1, -)} & \mathcal{Z}_{1, 1}^{\mathcal{K}} \end{array}$$

In the above, we are writing  $f_1^1$  for the map  $L_2 f_1^1 + {}^{-L_2} f_1^1$ , and similarly for all of the other maps. Note that  ${}^{-H} \omega_3^1$  does not make any contribution.

Our argument will go by way of viewing the above diagram as a mapping cone from the top line to the bottom line, and then applying the homological perturbation lemma. Let us write

$$\mathcal{Q}_{\pm 1, \varepsilon}^{\mathcal{K}} = \text{Cone} \left( \mathcal{Z}_{0, \varepsilon}^{\mathcal{K}} \xrightarrow{p_2^1(\sigma_1 + \tau_1, -)} \mathcal{Z}_{1, \varepsilon}^{\mathcal{K}} \right).$$

We will write

$$J_{\pm 1}^1: \mathcal{Q}_{\pm 1, 0}^{\mathcal{K}} \rightarrow \mathcal{Q}_{\pm 1, 1}^{\mathcal{K}}$$

for the total morphism from the top line to the bottom line (i.e.  $f_1^1 \oplus g_1^1$ ), so that  $\mathcal{Z}_{(\pm 1, 0)}^{\mathcal{K}}$  is  $\text{Cone}(J_{\pm 1}^1)$ .

Write  $\mathcal{W}_{\varepsilon}^{\mathcal{K}}$  for the module which is concentrated in idempotent  $\mathbf{I}_{\varepsilon}$ , has a single generator, and has vanishing  $\delta^1$ . Equation (18.4), and consequently Proposition 18.1, follows from the subsequent two lemmas:

**Lemma 18.2.** *There are maps*

$$I_{\varepsilon}^1: \mathcal{W}_{\varepsilon}^{\mathcal{K}} \rightarrow \mathcal{Q}_{-1, \varepsilon}^{\mathcal{K}}, \quad \Pi_{\varepsilon}^1: \mathcal{Q}_{-1, \varepsilon}^{\mathcal{K}} \rightarrow \mathcal{W}_{\varepsilon}^{\mathcal{K}}, \quad \text{and} \quad H_{\varepsilon}^1: \mathcal{Q}_{-1, \varepsilon}^{\mathcal{K}} \rightarrow \mathcal{Q}_{-1, \varepsilon}^{\mathcal{K}}$$

such that  $I_{\varepsilon}^1$  and  $\Pi_{\varepsilon}^1$  are cycles, and  $I_{\varepsilon}^1 \circ \Pi_{\varepsilon}^1 = \text{id} + \partial_{\text{Mor}}(H_{\varepsilon}^1)$  and  $\Pi_{\varepsilon}^1 \circ I_{\varepsilon}^1 = \text{id}$ . Furthermore,

$$\Pi^1 \circ J_{-1}^1 \circ I^1 = (i_0 \mapsto i_1 \otimes (\sigma + \mathcal{V}\tau)).$$

Here  $i_{\varepsilon}$  denotes the generator of  $\mathcal{Q}_{-1, \varepsilon}^{\mathcal{K}}$ . Also  $\varepsilon_0 = 0$  and  $\varepsilon_1 = 1$ . In other words,  $\mathcal{Z}_{(-1, 0)}^{\mathcal{K}} \simeq \mathcal{D}_{+1}^{\mathcal{K}}$ .

*Proof.* As a first step we record the mapping cone of  $\mathcal{Q}_{-1,\varepsilon}^{\mathcal{K}}$ . This is the type- $D$  module

$$\begin{array}{ccccccccccccc}
 \cdots & & \mathcal{U}_1^3 \mathbf{a} & & \mathcal{U}_1^2 \mathbf{a} & & \mathcal{U}_1^1 \mathbf{a} & & \mathbf{a} & & \mathbf{d} & & \mathcal{V}_1 \mathbf{d} & & \mathcal{V}_1^2 \mathbf{d} & & \mathcal{V}_1^3 \mathbf{d} & & \cdots \\
 & \swarrow & \downarrow \mathcal{U}_2^3 \mathcal{V}_2^4 & \searrow 1 & \downarrow \mathcal{U}_2^2 \mathcal{V}_2^3 & \searrow 1 & \downarrow \mathcal{U}_2^1 \mathcal{V}_2^2 & \searrow 1 & \downarrow \mathcal{V}_2 & \searrow \mathcal{U}_2 & \downarrow 1 & \searrow \mathcal{U}_2^2 \mathcal{V}_2 & \downarrow 1 & \searrow \mathcal{U}_2^3 \mathcal{V}_2^2 & \downarrow 1 & \searrow \mathcal{U}_2^4 \mathcal{V}_2^3 & \downarrow 1 & \searrow & \\
 \cdots & & \mathcal{V}_1^{-4} \mathbf{d} & & \mathcal{V}_1^{-3} \mathbf{d} & & \mathcal{V}_1^{-2} \mathbf{d} & & \mathcal{V}_1^{-1} \mathbf{d} & & \mathbf{d} & & \mathcal{V}_1 \mathbf{d} & & \mathcal{V}_1^2 \mathbf{d} & & \mathcal{V}_1^3 \mathbf{d} & & \cdots
 \end{array}$$

We define the type- $D$  module  $\mathcal{E}^\Lambda$ , where  $\Lambda$  is the exterior algebra on one generator. The module  $\mathcal{E}$  has a single generator, and differential  $\delta^1(1) = 1 \otimes \theta$ . Then  $\mathcal{Q}_{-1,\varepsilon}^{\mathcal{K}}$  is obtained by boxing  $\mathcal{E}^\Lambda$  with the  $DA$  bimodule over  $(\Lambda, \mathcal{K})$  shown below:

$$\begin{array}{ccccccccccccc}
 \cdots & & \mathcal{U}_1^3 \mathbf{a} & & \mathcal{U}_1^2 \mathbf{a} & & \mathcal{U}_1^1 \mathbf{a} & & \mathbf{a} & & \mathbf{d} & & \mathcal{V}_1 \mathbf{d} & & \mathcal{V}_1^2 \mathbf{d} & & \mathcal{V}_1^3 \mathbf{d} & & \cdots \\
 & \swarrow & \downarrow \theta \mathcal{U}_2^3 \mathcal{V}_2^4 & \searrow 1 & \downarrow \theta \mathcal{U}_2^2 \mathcal{V}_2^3 & \searrow 1 & \downarrow \theta \mathcal{U}_2^1 \mathcal{V}_2^2 & \searrow 1 & \downarrow \theta \mathcal{V}_2 & \searrow \theta \mathcal{U}_2 & \downarrow 1 & \searrow \theta \mathcal{U}_2^2 \mathcal{V}_2 & \downarrow 1 & \searrow \theta \mathcal{U}_2^3 \mathcal{V}_2^2 & \downarrow 1 & \searrow \theta \mathcal{U}_2^4 \mathcal{V}_2^3 & \downarrow 1 & \searrow & \\
 \cdots & & \mathcal{V}_1^{-4} \mathbf{d} & & \mathcal{V}_1^{-3} \mathbf{d} & & \mathcal{V}_1^{-2} \mathbf{d} & & \mathcal{V}_1^{-1} \mathbf{d} & & \mathbf{d} & & \mathcal{V}_1 \mathbf{d} & & \mathcal{V}_1^2 \mathbf{d} & & \mathcal{V}_1^3 \mathbf{d} & & \cdots
 \end{array}$$

In the above diagram, the solid lines denote the  $\delta^1$  action, while the dashed lines denote  $\delta_2^1(\theta, -)$ . A solid arrow from  $\mathbf{x}$  to  $\mathbf{y}$  with a 1 means that  $\delta^1(\mathbf{x})$  has a summand of  $\mathbf{y} \otimes 1$ . If we ignore the type- $A$  action, then the type- $D$  module is equivalent to the one spanned by  $\mathcal{V}_1^{-1} \mathbf{d}$  with vanishing  $\delta^1$ . There is a canonical inclusion map  $i^1$  and projection map  $\pi^1$ . A homotopy  $h^1$  is defined by moving backwards along the solid arrows. Clearly  $i^1$  and  $\pi^1$  are type- $D$  homomorphisms, and

$$i^1 \circ \pi^1 = \text{id} + \partial_{\text{Mor}}(h^1), \quad \pi^1 \circ i^1 = \text{id}.$$

Similarly,  $\pi^1 \circ h^1 = 0$ ,  $h^1 \circ h^1 = 0$ , and  $h^1 \circ i^1 = 0$ . By the homological perturbation lemma, Lemma 4.2,  $i^1$ ,  $\pi^1$  and  $h^1$  extend to a homotopy equivalence of  $DA$  bimodules, which we denote by  $i_*^1$ ,  $\pi_*^1$  and  $h_*^1$ . We define the type- $D$  module morphisms in the statement by

$$I^1 = \mathbb{I}_{\mathcal{E}} \boxtimes i_*^1, \quad \Pi^1 = \mathbb{I}_{\mathcal{E}} \boxtimes \pi_*^1, \quad \text{and} \quad H^1 = \mathbb{I}_{\mathcal{E}} \boxtimes h_*^1.$$

We leave it to the reader to check that the above expressions (which involve infinite sums on the completion) determine continuous morphisms.

All of the remaining claims in the statement are clear, except the ones involving the interaction with the map  $J_{-1}^1$ . We compute that  $I^1$  maps  $i_0$  to  $\mathcal{V}_1^{-1} \mathbf{d} \otimes 1$ . By the computation of Proposition 17.6, the map  $J_{-1}^1$  sends this to

$$\mathcal{V}_1^{-2} \mathbf{d} \otimes \tau_2 + \mathcal{V}_1^{-1} \mathbf{d} \otimes \sigma_2.$$

Then  $\Pi^1$  maps this to

$$i_1 \otimes \mathcal{V}_2 \tau_2 + i_1 \otimes \sigma_2.$$

Note that the application of  $\Pi^1$  to  $\mathcal{V}_1^{-2} \mathbf{d} \otimes \tau_2$  is slightly subtle. Indeed the recipe from the homological perturbation lemma is to move backwards along the arrow from  $\mathbf{a}$  to  $\mathcal{V}_1^{-2} \mathbf{d}$  and move forward along the arrow from  $\mathbf{a}$  to  $\mathcal{V}_1^{-1} \mathbf{d}$ , while picking up a factor of  $\mathcal{V}_2$ . The proof is complete.  $\square$

We now consider the case of  $\mathcal{Q}_{+1,\varepsilon}^{\mathcal{K}}$ :

**Lemma 18.3.** *There are maps*

$$I_\varepsilon^1: \mathcal{W}_\varepsilon^\mathcal{K} \rightarrow \mathcal{Q}_{+1,\varepsilon}^\mathcal{K}, \quad \Pi_\varepsilon^1: \mathcal{Q}_{+1,\varepsilon}^\mathcal{K} \rightarrow \mathcal{W}_\varepsilon^\mathcal{K}, \quad \text{and} \quad H_\varepsilon^1: \mathcal{Q}_{+1,\varepsilon}^\mathcal{K} \rightarrow \mathcal{Q}_{+1,\varepsilon}^\mathcal{K}$$

such that  $I_\varepsilon^1$  and  $\Pi_\varepsilon^1$  are type- $D$  homomorphisms, and  $I_\varepsilon^1 \circ \Pi_\varepsilon^1 = \text{id} + \partial_{\text{Mor}}(H_\varepsilon^1)$  and  $\Pi_\varepsilon^1 \circ I_\varepsilon^1 = \text{id}$ . Furthermore,

$$\Pi^1 \circ J_{+1}^1 \circ I^1 = (i_0 \mapsto i_1 \otimes (\sigma + \mathcal{V}^{-1}\tau)).$$

Here  $i_\varepsilon$  denotes the generator of  $\mathcal{Q}_{+1,\varepsilon}^\mathcal{K}$ . In other words,  $\mathcal{Z}_{+1}^\mathcal{K} \simeq \mathcal{D}_{-1}^\mathcal{K}$ .

*Proof.* The proof is very much the same as the proof with framing  $-1$ . We write down the complex  $\mathcal{Q}_{+1,\varepsilon}^\mathcal{K}$  below:

$$\begin{array}{cccccccccccc} \cdots & & \mathcal{U}_1^3 \mathbf{a} & & \mathcal{U}_1^2 \mathbf{a} & & \mathcal{U}_1^1 \mathbf{a} & & \mathbf{a} & & \mathbf{d} & & \mathcal{V}_1 \mathbf{d} & & \mathcal{V}_1^2 \mathbf{d} & & \mathcal{V}_1^3 \mathbf{d} & & \cdots \\ & \searrow & \downarrow \mathcal{U}_2^3 \mathcal{V}_2^4 & \downarrow 1 & \downarrow \mathcal{U}_2^2 \mathcal{V}_2^3 & \downarrow 1 & \downarrow \mathcal{U}_2^1 \mathcal{V}_2^2 & \downarrow 1 & \downarrow \mathcal{V}_2 & \downarrow 1 & \downarrow 1 & \downarrow \mathcal{U}_2 & \downarrow 1 & \downarrow \mathcal{U}_2^2 \mathcal{V}_2 & \downarrow 1 & \downarrow \mathcal{U}_2^3 \mathcal{V}_2^2 & \downarrow 1 & \downarrow \mathcal{U}_2^4 \mathcal{V}_2^3 & \downarrow \cdots \\ \cdots & & \mathcal{V}_1^{-4} \mathbf{d} & & \mathcal{V}_1^{-3} \mathbf{d} & & \mathcal{V}_1^{-2} \mathbf{d} & & \mathcal{V}_1^{-1} \mathbf{d} & & \mathbf{d} & & \mathcal{V}_1 \mathbf{d} & & \mathcal{V}_1^2 \mathbf{d} & & \mathcal{V}_1^3 \mathbf{d} & & \cdots \end{array}$$

Similar to the framing  $-1$  case, we realize the above diagram as the box tensor product of  $\mathcal{E}^\Lambda$  with the following  $DA$ -bimodule over  $(\Lambda, \mathcal{K})$ :

$$\begin{array}{cccccccccccc} \cdots & & \mathcal{U}_1^3 \mathbf{a} & & \mathcal{U}_1^2 \mathbf{a} & & \mathcal{U}_1^1 \mathbf{a} & & \mathbf{a} & & \mathbf{d} & & \mathcal{V}_1 \mathbf{d} & & \mathcal{V}_1^2 \mathbf{d} & & \mathcal{V}_1^3 \mathbf{d} & & \cdots \\ & \searrow & \downarrow \theta | \mathcal{U}_2^3 \mathcal{V}_2^4 & \downarrow 1 & \downarrow \theta | \mathcal{U}_2^2 \mathcal{V}_2^3 & \downarrow 1 & \downarrow \theta | \mathcal{U}_2^1 \mathcal{V}_2^2 & \downarrow 1 & \downarrow \theta | \mathcal{V}_2 & \downarrow 1 & \downarrow 1 & \downarrow \theta | \mathcal{U}_2 & \downarrow 1 & \downarrow \theta | \mathcal{U}_2^2 \mathcal{V}_2 & \downarrow 1 & \downarrow \theta | \mathcal{U}_2^3 \mathcal{V}_2^2 & \downarrow 1 & \downarrow \theta | \mathcal{U}_2^4 \mathcal{V}_2^3 & \downarrow \cdots \\ \cdots & & \mathcal{V}_1^{-4} \mathbf{d} & & \mathcal{V}_1^{-3} \mathbf{d} & & \mathcal{V}_1^{-2} \mathbf{d} & & \mathcal{V}_1^{-1} \mathbf{d} & & \mathbf{d} & & \mathcal{V}_1 \mathbf{d} & & \mathcal{V}_1^2 \mathbf{d} & & \mathcal{V}_1^3 \mathbf{d} & & \cdots \end{array}$$

We forget about the left  $\Lambda$  action and simplify the type- $D$  structure. We build a homotopy equivalence with the module  $\mathcal{W}_\varepsilon^\mathcal{K}$ , by picking type- $D$  module maps  $i^1$ ,  $\pi^1$  and  $h^1$ . The map  $i^1$  sends  $i_\varepsilon$  to  $(\mathbf{a} + \mathbf{d}) \otimes 1$ . The map  $\pi^1$  requires a choice. It is either  $(\mathbf{a} \mapsto i_\varepsilon \otimes 1, \mathbf{d} \mapsto 0)$ , or  $(\mathbf{a} \mapsto 0, \mathbf{d} \mapsto i_\varepsilon \otimes 1)$ . The choice of  $h^1$  depends on our choice of  $\pi^1$ . If  $\pi^1$  sends  $\mathbf{a}$  to  $i_\varepsilon$ , then  $h^1$  maps  $\mathbf{d}$  (on the bottom row) to  $\mathbf{d} \otimes 1$  (on the top row). If  $\pi^1$  maps  $\mathbf{d}$  to  $i_\varepsilon \otimes 1$ , then  $h^1$  maps  $\mathbf{d}$  (bottom row) to  $\mathbf{a} \otimes 1$  (top row). Arbitrarily, pick  $\pi^1$  to map  $\mathbf{d}$  to  $i_\varepsilon \otimes 1$ . Away from the central region, the map  $h^1$  just maps backwards along the arrows marked with a 1. One easily verifies that  $\pi^1$ ,  $i^1$  and  $h^1$  satisfy the assumptions of the homological perturbation lemma.

The homological perturbation lemma now gives us extensions  $\pi_*^1$ ,  $i_*^1$  and  $h_*^1$ . Boxing these with  $\mathbb{I}_\mathcal{E}$  gives homotopy equivalences between  $\mathcal{Q}_\varepsilon^\mathcal{K}$  and  $\mathcal{W}_\varepsilon^\mathcal{K}$  described in the statement. Note that the maps  $I^1$ ,  $\Pi^1$  and  $H^1$  sometimes involve infinite sums, however it is straightforward to verify that the induced maps are continuous.

It remains to perform the computation involving  $J_{+1}^1$ . We easily compute

$$I^1(i_0) = \cdots + \mathcal{U}_1 \mathbf{a} \otimes \mathcal{V}_2 + \mathbf{a} \otimes 1 + \mathbf{d} \otimes 1 + \mathcal{V}_1 \mathbf{d} \otimes \mathcal{U}_2 + \cdots$$

The map  $J_{+1}^1$  sends the above to

$$\begin{aligned} & \cdots + \mathcal{U}_1 \mathbf{a} \otimes \sigma_2 \mathcal{V}_2 + \mathbf{a} \otimes \sigma_2 + \mathbf{d} \otimes \sigma_2 + \mathcal{V}_1 \mathbf{d} \otimes \sigma_2 \mathcal{U}_2 + \cdots \\ & \cdots + \mathcal{U}_1^2 \mathbf{a} \otimes \tau_2 \mathcal{V}_2 + \mathcal{U}_1 \mathbf{a} \otimes \tau_2 + \mathbf{a} \otimes \mathcal{V}_2^{-1} \tau_2 + \mathbf{d} \otimes \tau_2 \mathcal{U}_2 + \cdots \end{aligned}$$



The map  $\Pi^1$  evaluates the above  $i_1 \otimes (\sigma_2 + \mathcal{V}_2^{-1} \tau_2)$  (regardless of which choice we made in the construction of  $\pi^1$ ). Note, we are using here that  $\tau_2 \mathcal{U}_2 = \mathcal{V}_2^{-1} \tau_2$ . The proof is complete  $\square$

**18.2. The type- $D$  invariants of solid tori.** We now describe the type- $D$  module for a solid torus with  $p/q \in \mathbb{Q} \cup \{\infty\}$  framing. By performing a slam dunk, the most convenient description is to take a standard unknot complement (with standard meridian and 0-framed longitude) and perform  $-q/p$  surgery to a meridian of  $U$ . See Figure 18.1. Additionally, we will consider the  $\infty$ -framed solid torus, which we view as being obtained by performing 0-surgery to a meridian of  $U$ .

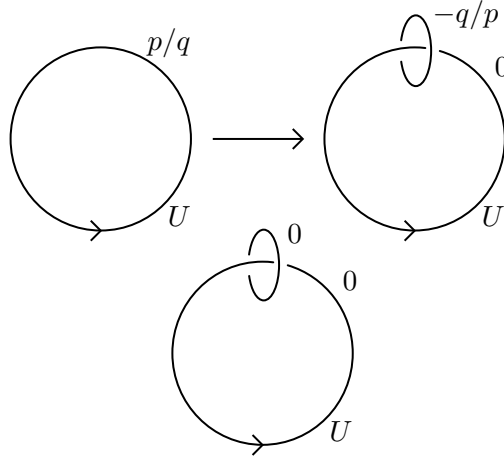

FIGURE 18.1. A slam dunk on a  $p/q$ -framed solid torus (top row), and an  $\infty$ -framed solid torus (bottom). The component  $U$  with an arrow on it denotes the component which we associate to  $\mathcal{K}$ .

We now define our candidate type- $D$  modules. We begin by recalling that by definition the type- $D$  module for an  $n$ -framed solid torus  $\mathcal{D}_n^{\mathcal{K}}$  is the same as the surgery complex for an  $n$ -framed unknot, and hence has two generators  $\mathbf{x}^0$  and  $\mathbf{x}^1$ , which live in idempotent 0 and 1, respectively. The structure map is given by

$$\delta^1(\mathbf{x}^0) = \mathbf{x}^1 \otimes (\sigma + \mathcal{V}^n \tau).$$

Generalizing this, we now define the candidate  $p/q$ -framed solid torus module  $\mathcal{D}_{p/q}^{\mathcal{K}}$ , where  $p, q$  are coprime and  $q > 0$ . We define  $\mathcal{D}_{p/q}^{\mathcal{K}} \cdot \mathbf{I}_\varepsilon$  to be spanned by generators  $\mathbf{x}_0^\varepsilon, \dots, \mathbf{x}_{q-1}^\varepsilon$ , for  $\varepsilon \in \{0, 1\}$ . The structure map is given by the following formula

$$\delta^1(\mathbf{x}_i^0) = \mathbf{x}_{(i+p) \bmod q}^1 \otimes \mathcal{V}^{\lfloor (i+p)/q \rfloor} \tau + \mathbf{x}_i^1 \otimes \sigma.$$

The examples  $\mathcal{D}_{\pm 1/3}^{\mathcal{K}}$  are shown in Figure 18.2.

*Remark 18.4.* The bimodule  $\mathcal{D}_{p/q}^{\mathcal{K}}$  recovers the rational surgery mapping cone complex  $\mathbb{X}_{p/q}(K)$  of Ozsváth and Szabó [OS11] in the sense that if  $K \subseteq S^3$  is a knot, then

$$\mathcal{D}_{p/q}^{\mathcal{K}} \hat{\boxtimes} \mathcal{K} \mathcal{X}_0(K) \cong \mathbb{X}_{p/q}(K).$$

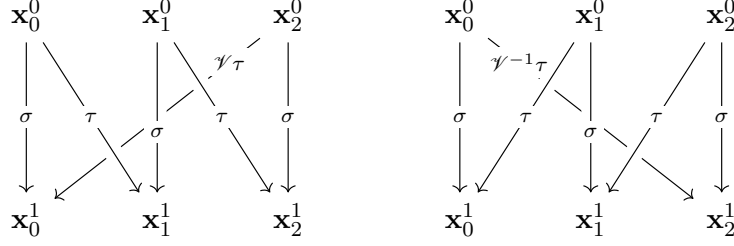

FIGURE 18.2. The modules  $\mathcal{D}_{1/3}^{\mathcal{K}}$  (left) and  $\mathcal{D}_{-1/3}^{\mathcal{K}}$  (right).

Finally, we define the type- $D$  module  $\mathcal{D}_{\infty}^{\mathcal{K}}$  for the  $\infty$ -framed solid torus. This module  $\mathcal{D}_{\infty}^{\mathcal{K}} \cdot \mathbf{I}_0 = \{0\}$  and  $\mathcal{D}_{\infty}^{\mathcal{K}} \cdot \mathbf{I}_1 = \text{Span}_{\mathbb{F}}(\mathbf{x}, \mathbf{y})$ . The structure map is given by

$$\delta^1(\mathbf{x}) = \mathbf{y} \otimes (1 + \mathcal{V}).$$

The link surgery formula naturally produces a type- $D$  module  $\mathcal{X}_{p/q}^{\mathcal{K}}$  for the  $p/q$ -framed solid torus, as follows. We may write  $p/q$  as a continued fraction expansion

$$p/q = [a_n, \dots, a_1]^- = a_n - \frac{1}{a_{n-1} - \frac{1}{a_{n-2} - \dots}}.$$

We may define  $\mathcal{X}_{p/q}^{\mathcal{K}}$  as the link surgery complex of a linear plumbing with weights  $a_n, \dots, a_1$ . This produces a type- $D$  module over  $\mathcal{L}_n$ . We tensor 0-framed solid tori to the components labeled  $a_{n-1}, \dots, a_1$ . The remaining component, weighted  $a_n$ , corresponds to the type- $D$  algebra action of  $\mathcal{X}_{p/q}^{\mathcal{K}}$ .

**Proposition 18.5.** *The type- $D$  module for a  $p/q$ -framed solid torus  $\mathcal{X}_{p/q}^{\mathcal{K}}$  is homotopy equivalent to  $\mathcal{D}_{p/q}^{\mathcal{K}}$ .*

*Proof.* The proof is by induction. By considering the continued fraction decomposition above, we will assume that the formula holds for  $p/q$ , and use this to show that it also holds for

$$m - \frac{1}{p/q} = m - \frac{q}{p},$$

when  $m \in \mathbb{Z}$ .

Note that increasing the framing by  $m$  may be performed by tensoring with  $m$  meridional Dehn twist bimodules  ${}_{\mathcal{K}}\mathcal{B}_{\pm 1}^{\mathcal{K}}$  from Section 18.1. This tensor product is easy to understand, and indeed it is easy to check that

$$\mathcal{D}_{p/q}^{\mathcal{K}} \hat{\boxtimes} {}_{\mathcal{K}}\mathcal{B}_{+1}^{\mathcal{K}} \cong \mathcal{D}_{p/q+1}^{\mathcal{K}}$$

In particular, it suffices to show that if the claim is true for some  $p/q$ , then it is true for  $-q/p$ .

On the algebraic level, it is sufficient to show that

$$\mathcal{D}_{-q/p}^{\mathcal{K}} \simeq \mathcal{D}_{p/q}^{\mathcal{K}} \hat{\boxtimes} {}_{\mathcal{K}}\mathcal{Z}_{(0,0)}^{\mathcal{K}},$$

where  ${}_{\mathcal{K}}\mathcal{Z}_{(0,0)}^{\mathcal{K}}$  is the Hopf link bimodule.

In this case, we compute the type- $D$  module in a similar manner to our computation of the meridional Dehn twist module from Section 18.1. We mainly focus on the case that  $p < 0$  and  $q > 0$ .

We compute  $\mathcal{D}_{p/q}^{\mathcal{K}} \hat{\boxtimes} \mathcal{K}\mathcal{Z}_{(0,0)}^{\mathcal{K}} \cdot \mathbf{I}_0$  first. The tensor product has generators

$$x_j^i := \mathbf{x}_j^0 \mathcal{U}_1^i \mathbf{a} \quad \text{and} \quad y_j^i := \mathbf{x}_j^0 \mathcal{V}_1^i \mathbf{d},$$

ranging over  $i \in \mathbb{N}$  and  $j \in \mathbb{Z}/q$ , and generators

$$z_j^i := \mathbf{x}_j^1 \mathcal{V}_1^i \mathbf{d}$$

ranging over  $i \in \mathbb{Z}$  and  $j \in \mathbb{Z}/q$ . We display the complex in Figure 18.3.

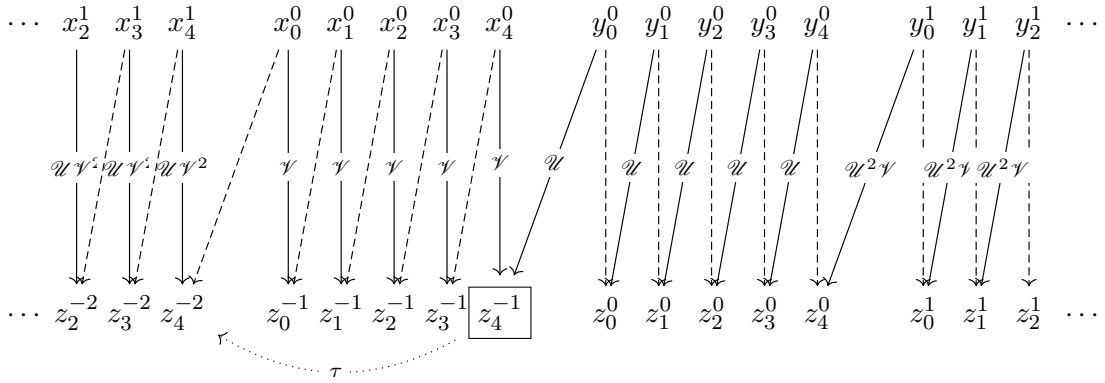

FIGURE 18.3. The tensor product  $\mathcal{D}_{p/q}^{\mathcal{K}} \hat{\boxtimes} \mathcal{K}\mathcal{Z}_{(0,0)}^{\mathcal{K}} \cdot \mathbf{I}_\varepsilon$ , for either  $\varepsilon \in \{0, 1\}$ . Here we illustrate the case that  $p = -1$  and  $q = 5$ . The boxed generators are the generators of the minimal model of  $\mathcal{D}_{p/q}^{\mathcal{K}} \hat{\boxtimes} \mathcal{K}\mathcal{Z}_{(0,0)}^{\mathcal{K}} \cdot \mathbf{I}_\varepsilon$ . The dashed arrows are weighted by 1. The dotted arrow indicates a term of  $\delta^1$  which maps from idempotent 0 to idempotent 1. (Note that technically this arrow goes from the copy of this complex in idempotent 0 to the copy in idempotent 1).

Let us write  $|p| = a \cdot q + r$ , where  $a \geq 0$  and  $0 \leq r \leq q - 1$ . The minimal model of the module in this idempotent is generated by the  $p$  generators

$$\mathbf{w}_0^0 = z_{q-1}^{-1}, \mathbf{w}_1^0 = z_{q-2}^{-1} \cdots, \mathbf{w}_{p-1}^0 = z_{q-1-r}^{-a-1}.$$

The same argument works for  $\mathcal{D}_{p/q}^{\mathcal{K}} \hat{\boxtimes} \mathcal{K}\mathcal{Z}_{(0,0)}^{\mathcal{K}} \cdot \mathbf{I}_1$ , and we write  $\mathbf{w}_0^1, \dots, \mathbf{w}_{p-1}^1$  for these generators.

This gives the stated identification of the generators of the module. It remains now to understand  $\delta^1$ . This is obtained via homological perturbation (cf. Lemma 4.5) by first applying the inclusion map from  $\mathcal{D}_{-q/p}^{\mathcal{K}} \cdot \mathbf{I}_0$  into  $\mathcal{D}_{p/q}^{\mathcal{K}} \hat{\boxtimes} \mathcal{K}\mathcal{Z}_{(0,0)}^{\mathcal{K}} \cdot \mathbf{I}_0$ , applying  $\delta^1$  of  $\mathcal{D}_{p/q}^{\mathcal{K}} \hat{\boxtimes} \mathcal{K}\mathcal{Z}_{(0,0)}^{\mathcal{K}}$  and then projecting to  $\mathcal{D}_{p/q}^{\mathcal{K}} \hat{\boxtimes} \mathcal{K}\mathcal{Z}_{(0,0)}^{\mathcal{K}} \cdot \mathbf{I}_1$  to  $\mathcal{D}_{-q/p}^{\mathcal{K}} \cdot \mathbf{I}_1$ .

There is clearly a summand of  $\delta^1$  which sends  $\mathbf{w}_i^0$  to  $\mathbf{w}_i^1 \otimes \sigma$ , for each  $i \in \mathbb{Z}/q$ . There is a remaining term of  $\delta^1$  terms which contributes  $\tau$ . We call that via homological perturbation theory, these terms are obtained by first including, applying  $\delta^1$ , and then projecting. After including, the map  $\delta^1$  moves a generator of  $\mathcal{D}_{p/q}^{\mathcal{K}} \hat{\boxtimes} \mathcal{K}\mathcal{Z}_{(0,0)}^{\mathcal{K}}$  to the left

by  $q$  places. The outgoing algebra element is 1. We then apply the projection map. If the application of  $\delta^1$  sent  $\mathbf{w}_i^0$  to  $\mathbf{w}_j^1 \otimes \tau$  for  $\mathbf{w}_j^1 \in \{\mathbf{w}_0^1, \dots, \mathbf{w}_{p-1}^1\}$ , then the projection map sends  $\mathbf{w}_j^1$  to  $\mathbf{w}_j^1 \otimes 1$ . In general, the projection map will involve traveling to the generators  $\mathbf{w}_0^1, \dots, \mathbf{w}_{p-1}^1$  via a zig-zag of arrows in the larger complex  $\mathcal{D}_{p/q}^{\mathcal{K}} \hat{\boxtimes}_{\mathcal{K}} \mathcal{Z}_{(0,0)}^{\mathcal{K}}$  (more precisely, such a zig-zag may be encoded by the homological perturbation lemma, similar to our argument from Section 18.1). We pick up one power of  $\mathcal{V}$  for each zig-zag we have to do to get back to  $\mathbf{w}_{(i+q) \bmod p}^1$ . The number of zig-zags that we have to do to map  $\delta^1(\mathbf{w}_i^1)$  to  $\mathbf{w}_{(i+q) \bmod p}^1$  is exactly  $\lfloor (i+q)/(-p) \rfloor$ . This coincides with  $\mathcal{D}_{q/(-p)}^{\mathcal{K}}$ , completing the proof.  $\square$

**Proposition 18.6.** *The type- $D$  module for an  $\infty$ -framed solid torus is  $\mathcal{D}_{\infty}^{\mathcal{K}}$ .*

*Proof.* We compute the tensor product

$$\mathcal{D}_{\infty}^{\mathcal{K}} := \mathcal{D}_0^{\mathcal{K}} \hat{\boxtimes}_{\mathcal{K}} \mathcal{Z}_{(0,0)}^{\mathcal{K}}.$$

We note that for both  $\varepsilon = 0, 1$ , we that  $\mathcal{D}_0 \hat{\boxtimes}_{\mathcal{K}} \mathcal{Z}_{(0,0)}^{\mathcal{K}} \cdot \mathbf{I}_{\varepsilon}$  is isomorphic to the complex

$$\begin{array}{cccccc} \cdots & \mathcal{U}_1 \mathbf{a} & \mathbf{a} & \mathbf{d} & \mathcal{V}_1 \mathbf{d} & \cdots \\ & \downarrow 1 + \mathcal{U} \mathcal{V}^2 & \downarrow 1 + \mathcal{V} & \downarrow 1 + \mathcal{U} & \downarrow 1 + \mathcal{U}^2 \mathcal{V} & \\ \cdots & \mathcal{V}_1^{-2} \mathbf{d} & \mathcal{V}_1^{-1} \mathbf{d} & \mathbf{d} & \mathcal{V}_1 \mathbf{d} & \cdots \end{array}$$

In idempotent  $\mathbf{I}_0$ , this complex is acyclic. For example  $\text{Cone}(1 + \mathcal{U} : \mathbf{d} \rightarrow \mathbf{d})$  is acyclic because  $1 + \mathcal{U}$  is a unit in the completion of  $\mathbf{I}_0 \cdot \mathcal{K} \cdot \mathbf{I}_0$ . Its inverse is given by  $\sum_{i=0}^{\infty} \mathcal{U}^i$ . In idempotent  $\mathbf{I}_1$ , each summand is acyclic except for  $\text{Cone}(1 + \mathcal{V} : \mathbf{a} \rightarrow \mathcal{V}_1^{-1} \mathbf{d})$ . Deleting each acyclic subcomplex yields  $\mathcal{D}_{\infty}^{\mathcal{K}}$ , completing the proof.  $\square$

There is a related bimodule which is useful for applications, defined by

$$\mathcal{K} \mathcal{D}_{\infty}^{\mathbb{F}[U]} := \mathcal{D}_{\infty}^{\mathcal{K}} \hat{\boxtimes}_{\mathcal{K}|\mathcal{K}} [\mathbb{F}^{\boxplus}]^{\mathbb{F}[U]}.$$

The following lemma is helpful:

**Lemma 18.7.** *The DA-bimodule  $\mathcal{K} \mathcal{D}_{\infty}^{\mathbb{F}[U]}$  is homotopy equivalent to the DA-bimodule with a single generator  $\mathbf{z}^1$ , concentrated in idempotent  $\mathbf{I}_0$ , such that  $\delta_2^1(\mathcal{U}^i \mathcal{V}^j, \mathbf{z}^1) = \mathbf{z}^1 \otimes U^i$ .*

*Proof.* Write  $\mathcal{K} \mathcal{Z}_{\infty}^{\mathbb{F}[U]}$  for the small model in the statement. We view the completion of  $\mathcal{K} \mathcal{D}_{\infty}^{\mathbb{F}[U]}$  as being the vector space

$$\mathbb{F}[[\mathcal{V}, \mathcal{V}^{-1}]] \langle \mathbf{x}^1 \rangle \oplus \mathbb{F}[[\mathcal{V}, \mathcal{V}^{-1}]] \langle \mathbf{y}^1 \rangle.$$

We have

$$\delta_1^1(\mathcal{V}^t \mathbf{x}^1) = (1 + \mathcal{V}) \mathcal{V}^t \mathbf{y}^1 \otimes 1.$$

Furthermore

$$\delta_2^1(i_1 \mathcal{V}^n U^m i_1, \mathcal{V}^t \mathbf{x}^1) = \mathcal{V}^{n+t} \mathbf{x}^1 \otimes U^m,$$

and similarly for  $\mathbf{y}^1$ . Apply the forgetful functor to the type- $A$  actions on  $\mathcal{K} \mathcal{D}_{\infty}^{\mathbb{F}[U]}$  and  $\mathcal{K} \mathcal{Z}_{\infty}^{\mathbb{F}[U]}$ . Define type- $D$  morphisms

$$i^1 : \mathcal{Z}_{\infty}^{\mathbb{F}[U]} \rightarrow \mathcal{D}_{\infty}^{\mathbb{F}[U]}, \quad \pi^1 : \mathcal{D}_{\infty}^{\mathbb{F}[U]} \rightarrow \mathcal{Z}_{\infty}^{\mathbb{F}[U]} \quad \text{and} \quad h^1 : \mathcal{D}_{\infty}^{\mathbb{F}[U]} \rightarrow \mathcal{D}_{\infty}^{\mathbb{F}[U]}$$

via the following formulas. We set

$$i^1(\mathbf{z}^1) = \left( \sum_{i \in \mathbb{Z}} \mathcal{V}^i \right) \mathbf{x}^1 \otimes 1, \quad \pi^1(\mathcal{V}^i \mathbf{x}^1) = \begin{cases} \mathbf{z}^1 \otimes 1 & \text{if } i = 0 \\ 0 & \text{otherwise.} \end{cases}$$

Additionally, we set

$$\pi^1(\mathcal{V}^i \mathbf{y}^1) = 0 \quad \text{and} \quad h^1(\mathcal{V}^i \mathbf{y}^1) = \begin{cases} \sum_{j < i} \mathcal{V}^j \mathbf{x}^1 \otimes 1 & \text{if } i \leq 0 \\ \sum_{j \geq i} \mathcal{V}^j \mathbf{x}^1 \otimes 1 & \text{if } i > 0. \end{cases}$$

We leave it to the reader to check that the above maps are continuous, and furthermore

$$\pi^1 \circ i^1 = \text{id}, \quad i^1 \circ \pi^1 = \partial_{\text{Mor}}(h^1), \quad h^1 \circ h^1 = 0, \quad \pi^1 \circ h^1 = 0, \quad \text{and} \quad h^1 \circ i^1 = 0.$$

Applying the homological perturbation lemma from Lemma 4.2 induces a type- $DA$  Alexander bimodule structure on  $\mathcal{Z}_\infty^{\mathbb{F}[U]}$  which is homotopy equivalent to  ${}_{\mathcal{K}}\mathcal{D}_\infty^{\mathbb{F}[U]}$ . This bimodule structure is easily checked to coincide with our definition of  ${}_{\mathcal{K}}\mathcal{Z}_\infty^{\mathbb{F}[U]}$ , completing the proof.  $\square$

**18.3. The surgery exact triangle.** We now show that our bordered invariants recover the surgery exact triangle, in the following sense:

**Proposition 18.8.** *There is a type- $D$  morphism  $f^1: \mathcal{D}_n^{\mathcal{K}} \rightarrow \mathcal{D}_{n+1}^{\mathcal{K}}$  such that*

$$\text{Cone}(f^1: \mathcal{D}_n^{\mathcal{K}} \rightarrow \mathcal{D}_{n+1}^{\mathcal{K}}) \simeq \mathcal{D}_\infty^{\mathcal{K}},$$

for any  $n \in \mathbb{Z}$ .

*Remark 18.9.* This is unsurprising since the knot and link surgery formulas are proven using surgery exact triangles, though it highlights the similarities with the original bordered theory, cf. [LOT18, Section 11.2].

*Remark 18.10.* It is straightforward to adapt our proof to construct morphisms and homotopy equivalences  $\mathcal{D}_{n+1}^{\mathcal{K}} \simeq \text{Cone}(g^1: \mathcal{D}_\infty^{\mathcal{K}} \rightarrow \mathcal{D}_n^{\mathcal{K}})$  and  $\mathcal{D}_n^{\mathcal{K}} \simeq \text{Cone}(h^1: \mathcal{D}_{n+1}^{\mathcal{K}} \rightarrow \mathcal{D}_\infty^{\mathcal{K}})$ .

*Proof.* Write  $\mathbf{x}_0, \mathbf{x}_1$  for the generators of  $\mathcal{D}_n^{\mathcal{K}}$  and  $\mathbf{y}_0, \mathbf{y}_1$  for the generators of  $\mathcal{D}_{n+1}^{\mathcal{K}}$ . We define  $f^1$  via the formula

$$f^1(\mathbf{x}_\varepsilon) = \mathbf{y}_\varepsilon \otimes (1 + \alpha)$$

for  $\varepsilon \in \{0, 1\}$ , where

$$\alpha = \sum_{s \geq 0} (\mathcal{U}^s + \mathcal{V}^s) U^{s(s-1)/2} = (\mathcal{U} + \mathcal{V}) + (\mathcal{U}^2 + \mathcal{V}^2)U + (\mathcal{U}^3 + \mathcal{V}^3)U^3 + \dots$$

(The element  $\alpha$  is discovered by writing  $\beta = 1 + \alpha$  as  $\beta = \sum_{i \in \mathbb{Z}} \beta_i$  where  $\beta_i$  has Alexander grading  $i$ , and then recursively solving the equation  $\mathcal{V}T(\beta_i) = \beta_{i+1}$  starting with  $\beta_0 = 1$ ).

It is straightforward to see that  $\partial_{\text{Mor}}(f^1) = 0$ . Write

$$\text{Cone}(f^1) = \begin{array}{ccc} \mathbf{x}_0 & \xrightarrow{1+\alpha} & \mathbf{y}_0 \\ \downarrow \sigma + \mathcal{V}^n \tau & & \downarrow \sigma + \mathcal{V}^{n+1} \tau \\ \mathbf{x}_1 & \xrightarrow{1+\alpha} & \mathbf{y}_1 \end{array}$$

Since  $1 + \alpha$  is a unit in the completion of  $\mathbf{I}_0 \cdot \mathcal{K} \cdot \mathbf{I}_0$ , the above complex is homotopy equivalent to the bottom row,  $\text{Cone}(1 + \alpha : \mathbf{x}_1 \rightarrow \mathbf{y}_1)$ . To construct a homotopy equivalence between  $\text{Cone}(1 + \alpha : \mathbf{x}_1 \rightarrow \mathbf{y}_1)$  and  $\mathcal{D}_\infty^{\mathcal{K}}$ , it is sufficient to show that  $1 + \alpha = (1 + \mathcal{V})u$  for some unit  $u$  in the completion of  $\mathbf{I}_1 \cdot \mathcal{K} \cdot \mathbf{I}_1$ . To see this, we simply recall that  $\mathcal{U} = U\mathcal{V}^{-1}$ . We use this expression for  $\mathcal{U}$  in our formula for  $\alpha$  and then regroup terms based over the powers of  $U$ , and we obtain the following expression:

$$1 + \alpha = \sum_{s \geq 0} (\mathcal{V}^s + \mathcal{V}^{-s+1}) U^{s(s-1)/2}$$

We observe that

$$(\mathcal{V}^s + \mathcal{V}^{-s+1}) U^{s(s-1)/2} = (1 + \mathcal{V}^{2s-1}) \mathcal{V}^{-s+1} U^{s(s-1)/2}$$

which clearly has a factor of  $(1 + \mathcal{V})$ , for all  $s \geq 0$ . Hence,  $1 + \alpha = (1 + \mathcal{V})(1 + Uf)$  for some series  $f$ , and  $(1 + Uf)$  is a unit in the completion of  $\mathbf{I}_1 \cdot \mathcal{K} \cdot \mathbf{I}_1$ , completing the proof.  $\square$

**18.4. Finite generation.** In this section we prove a basic property of the surgery modules that is useful in applications.

**Proposition 18.11.** *Suppose that  $L \subseteq S^3$  is a link with framing  $\Lambda$ , and  $L = K_1 \cup \dots \cup K_n$ . Suppose that  $0 < j < n$  and write  $L_{1,\dots,j} = K_1 \cup \dots \cup K_j$  and  $L_{j+1,\dots,n} = K_{j+1} \cup \dots \cup K_n$ . Let  $\mathcal{X}_\Lambda(L_{1,\dots,j}, L_{j+1,\dots,n})^{\mathcal{L}^{n-j}}$  denote the type- $D$  module obtained by tensoring by tensoring  $\kappa\mathcal{D}_0$  into each algebra component for  $L_{1,\dots,j}$ . Then  $\mathcal{X}_\Lambda(L_{1,\dots,j}, L_{j+1,\dots,n})^{\mathcal{L}^{n-j}}$  is homotopy equivalent to a finitely generated type- $D$  module.*

Our argument is similar to Manolescu and Ozsváth's truncation procedure [MO10, Section 10]. We will prove the claim in several steps. If  $j < n$ , we write  $\Lambda_{(j)}$  for the induced framing matrix on  $L_{1,\dots,j}$ . We will first verify the claim first when  $\Lambda_{(j)}$  is positive definite. We will then use the exact triangle from Section 18.3 to verify the claim for arbitrary framings.

If  $0 < j < n$  and we decompose  $L$  as  $L = L_{1,\dots,j} \cup L_{j+1,\dots,n}$ , then we may consider the subcube

$$\mathcal{X}_\Lambda^{(*,0)}(L_{1,\dots,j}, L_{j+1,\dots,n})^{\mathcal{L}^{n-j}}$$

generated by points of the cube  $\mathbb{E}_n$  which have  $L_{j+1,\dots,n}$  components 0. We will view this as a type- $D$  module over the algebra  $\mathbb{F}[\mathcal{U}_{j+1}, \mathcal{V}_{j+1}, \dots, \mathcal{U}_n, \mathcal{V}_n]$  which is continuous with respect to the topology induced by

$$\mathbf{E}_0 \cdot \mathcal{L}^{n-j} \cdot \mathbf{E}_0 \cong \mathbb{F}[\mathcal{U}_{j+1}, \mathcal{V}_{j+1}, \dots, \mathcal{U}_n, \mathcal{V}_n].$$

Recall from Section 8.2 that the solid torus module  $\kappa\mathcal{D}_0$  may be decomposed as a tensor product

$$\kappa[\mathcal{D}_0]^{\mathbb{F}[U]} \hat{\boxtimes}_{\mathbb{F}[U]} \mathbb{F}[U].$$

Hence there is a type- $D$  module  $\mathcal{X}_\Lambda(L_{1,\dots,j}, L_{j+1,\dots,n})^{\mathbb{F}[U_1, \dots, U_j] \otimes \mathcal{L}^{n-j}}$ , from which we get  $\mathcal{X}_\Lambda(L_{1,\dots,j}, L_{j+1,\dots,n})^{\mathcal{L}^{n-j}}$  by tensoring with  $\mathbb{F}[U_1, \dots, U_j] \mathbb{F}[U_1, \dots, U_j]$ .

**Lemma 18.12.** *Suppose  $L = K_1 \cup \dots \cup K_n$  is a link in  $S^3$ , and  $0 \leq j < n$ . Suppose that  $\Lambda_{(j)}$  is positive definite. Then*

$$\mathcal{X}_\Lambda^{(*,0)}(L_{1,\dots,j}, L_{j+1,\dots,n})^{\mathbb{F}[U_1, \dots, U_j, \mathcal{U}_{j+1}, \mathcal{V}_{j+1}, \dots, \mathcal{U}_n, \mathcal{V}_n]}$$

is homotopy equivalent to a finitely generated type- $D$  module. Furthermore, the maps appearing in the homotopy equivalence may be taken to be continuous if we equip  $\mathcal{X}_\Lambda^{(*,0)}(L_1, \dots, j, L_{j+1}, \dots, n)$  with the product topology over a monomial basis, and we equip

$$\mathbb{F}[U_1, \dots, U_j, \mathcal{U}_{j+1}, \mathcal{V}_{j+1}, \dots, \mathcal{U}_n, \mathcal{V}_n]$$

with the  $(U_1, \dots, U_n)$ -adic topology.

*Remark 18.13.* The fact that the morphisms in the homotopy equivalence may be taken to be continuous with respect to the  $(U_1, \dots, U_n)$ -adic topology, as opposed to being continuous with respect to the  $(U_1, \dots, U_j, \mathcal{U}_{j+1}, \mathcal{V}_{j+1}, \dots, \mathcal{U}_n, \mathcal{V}_n)$ -adic topology, allows us to use the homotopy equivalence constructed in the lemma for the complex at each subcube  $\mathbb{E}_j \times \{\varepsilon\}$ , for all  $\varepsilon \in \mathbb{E}_{n-j}$ .

*Proof.* Our proof will be by induction on  $j$ . The case that  $j = 0$  is automatic since  $\mathcal{X}_\Lambda^{(*,0)}(\emptyset, L_1, \dots, n) \cong \mathcal{CFL}(L)$ , which is a finitely generated type- $D$  module over  $\mathbb{F}[\mathcal{U}_1, \mathcal{V}_1, \dots, \mathcal{U}_n, \mathcal{V}_n]$ .

We define a shifted Alexander  $A_j$ -grading on  $\mathcal{X}_\Lambda^{(*,0)}(L_1, \dots, j, L_{j+1}, \dots, n)$ , as follows. We set

$$\omega(\mathbf{s}) = -(\text{lk}(K_1, K_j), \dots, \text{lk}(K_{j-1}, K_j)) \Lambda_{(j-1)}^{-1} (s_1, \dots, s_{j-1})^T.$$

In the above,  $\Lambda_{(j-1)}^{-1}$  is the inverse matrix (over  $\mathbb{Q}$ ) and  $T$  denotes transpose. Also, if  $\mathbf{s} \in \mathbb{H}(L)$  we are writing  $\mathbf{s} = (s_1, \dots, s_n)$ . On the link surgery formula, we define the  $\omega$ -shifted Alexander grading

$$A_j^\omega(\mathbf{s}) := s_j + \omega(\mathbf{s}).$$

We observe that if  $i \neq j$ , then

$$\omega(\mathbf{s} + \Lambda_{L, -K_i}) - \omega(\mathbf{s}) = -\text{lk}(K_i, K_j).$$

This verifies that if  $\vec{M} \subseteq L_{1, \dots, j}$  is a sublink which does not contain  $-K_j$ , then  $\Phi^{\vec{M}}$  preserves  $A_j^\omega$ . On the other hand

$$\begin{aligned} & \lambda_j + \omega(\mathbf{s} + \Lambda_{L, -K_j}) - \omega(\mathbf{s}) \\ &= \lambda_j - (\text{lk}(K_1, K_j), \dots, \text{lk}(K_{j-1}, K_j)) \Lambda_{(j-1)}^{-1} (\text{lk}(K_1, K_j), \dots, \text{lk}(K_{j-1}, K_j))^T. \end{aligned} \quad (18.5)$$

Note that the above is quantity, which we denote by  $\lambda'_j$ , is the Schur complement of  $\Lambda_{(j-1)}$  inside of  $\Lambda_{(j)}$ . In particular,  $\Lambda_{(j)}$  is positive definite if and only  $\Lambda_{(j-1)}$  is positive definite and  $\lambda'_j > 0$ . It follows from Equation (18.5) that if  $-K_j \subseteq \vec{M} \subseteq L_{1, \dots, j}$ , then  $\Phi^{\vec{M}}$  shifts  $A_j^\omega$  by  $\lambda'_j$ .

We may thus decompose the complex  $\mathcal{X}_\Lambda^{(*,0)}(L_1, \dots, j, L_{j+1}, \dots, n)$  as a sum of staircases

$$\begin{array}{ccccccc} \cdots & & \mathcal{A}_{s-\lambda'_j}^\omega & & \mathcal{A}_s^\omega & & \mathcal{A}_{s+\lambda'_j}^\omega & & \cdots \\ & \searrow & \downarrow & \searrow & \downarrow & \searrow & \downarrow & \searrow & \\ & & F^{-K_j} & & F^{-K_j} & & F^{-K_j} & & \\ & & \downarrow & & \downarrow & & \downarrow & & \\ & & \mathcal{B}_{s-\lambda'_j}^\omega & & \mathcal{B}_s^\omega & & \mathcal{B}_{s+\lambda'_j}^\omega & & \cdots \end{array}$$

The vertical direction is the direction of  $K_j$ . Here we are writing  $F^{-K_j}$  for the hypercube maps for all oriented sublinks  $\vec{M} \subseteq L_{1, \dots, j}$  which contain  $-K_j$ , and we define  $F^{K_j}$

similarly. In the above, we are writing  $\mathcal{A}_s^\omega \subseteq \mathcal{C}_\Lambda^{(*,0)}(L_{1,\dots,j}, L_{j+1,\dots,n})$  for the subspace of  $\mathbb{F}[U_1, \dots, U_j, \mathcal{U}_{j+1}, \mathcal{V}_{j+1}, \dots, \mathcal{U}_n, \mathcal{V}_n]$ -module generators with  $K_j$ -component 0 and Alexander  $A_j^\omega$ -grading  $s \in \mathbb{Q}$ . The subspace  $\mathcal{B}_s^\omega$  is similar, but has  $K_j$ -component 1. Since  $\mathbb{H}(L_{1,\dots,j})/\Lambda_{(j)}$  is finite, there are only finitely many such staircases. Here, the subscript  $s$  of  $\mathcal{A}_s^\omega$  and  $\mathcal{B}_s^\omega$  denotes their shifted Alexander grading.

Standard arguments (see [MO10, Lemma 10.1]) imply the following:

- (h-1) If  $s$  is sufficiently large, the map  $F^{K_j}$  is a homotopy equivalence between  $\mathcal{A}_s^\omega$  and  $\mathcal{B}_s^\omega$ .
- (h-2) If  $s$  is sufficiently negative, the map  $F^{-K_j}$  is a homotopy equivalence between  $\mathcal{A}_s^\omega$  and  $\mathcal{B}_{s+\lambda_j}^\omega$ .

Note that we may view  $\mathcal{A}_s^\omega \otimes \mathbb{F}[U_j]$  as being a subspace of  $\mathcal{X}_\Lambda^{(*,0)}(L_{1,\dots,j-1}, L_{j+1,\dots,n}) \otimes \mathbb{F}[\mathcal{U}_j, \mathcal{V}_j]$  in  $A_j^\omega$  Alexander grading  $s$ . Similarly we may view  $\mathcal{B}_s^\omega \otimes \mathbb{F}[U_j]$  as being the subspace of  $\mathcal{X}_\Lambda^{(*,0)}(L_{1,\dots,j-1}, L_{j+1,\dots,n}) \otimes \mathbb{F}[\mathcal{U}_j, \mathcal{V}_j, \mathcal{V}_j^{-1}]$  in  $A_j^\omega$ -Alexander grading  $s$ . By induction,  $\mathcal{X}_\Lambda^{(*,0)}(L_{1,\dots,j-1}, L_{j+1,\dots,n})$  is homotopy equivalent to a finitely generated type- $D$  module over  $\mathbb{F}[U_1, \dots, U_{j-1}, \mathcal{U}_j, \mathcal{V}_j, \dots, \mathcal{U}_n, \mathcal{V}_n]$  with respect to the topologies in the statement of the lemma.

In particular, we may replace  $\mathcal{X}_\Lambda^{(*,0)}(L_{1,\dots,j-1}, L_{j,\dots,n})$  with a finitely generated model  $\mathcal{C}'$ , and also replace the subcomplexes  $\mathcal{A}_s^\omega$  and  $\mathcal{B}_s^\omega$  with the finite dimensional subspaces of  $\mathcal{C}' \otimes \mathbb{F}[\mathcal{U}_j, \mathcal{V}_j]$  and  $\mathcal{C}' \otimes \mathbb{F}[\mathcal{U}_j, \mathcal{V}_j, \mathcal{V}_j^{-1}]$  which form an  $\mathbb{F}[U_j]$  basis in Alexander grading  $s$ . Properties (h-1) and (h-2) are preserved by homotopy equivalence, and hence still persist on the finitely generated models. Abusing notation, we write  $\mathcal{A}_s^\omega$  and  $\mathcal{B}_s^\omega$  also for the finitely generated models.

Using the same logic as for the ordinary knot surgery mapping cone formula [OS08b], each such staircase above admits a finitely generated truncation. We need additionally to show that the maps appearing in a homotopy equivalence with the finite truncation are continuous with respect to the topologies in the main statement. These maps may be described easily using homological perturbation theory. Compare the proof of Lemma 18.2. Since  $\mathcal{C}'$  is finitely generated, for  $s \gg 0$ , each generator of  $\mathcal{A}_s^\omega$  must be a multiple of  $\mathcal{V}_j^{r(s)}$  for some function  $r: \mathbb{Q} \rightarrow \mathbb{N}$  such that  $r(s) \rightarrow \infty$  as  $s \rightarrow \infty$ . Similarly for  $s \ll 0$ , each generator of  $\mathcal{A}_s^\omega$  must be a multiple of  $\mathcal{U}_j^{l(s)}$  for some  $l: \mathbb{Q} \rightarrow \mathbb{N}$  such that  $l(s) \rightarrow \infty$  as  $s \rightarrow -\infty$ . Using the equivariance of the maps  $F^{K_j}$  and  $F^{-K_j}$  from Lemma 7.7, we see that for  $s \ll 0$ , the map  $F^{K_j}$  sends  $\mathcal{A}_s^\omega$  into the ideal  $(U_j^{l(s)})$ . Similarly, for  $s \gg 0$ ,  $F^{-K_j}$  maps  $\mathcal{A}_s^\omega$  into the ideal  $(U_j^{r(s)})$ . This is sufficient to show that the maps appearing in the homotopy equivalence are continuous as stated.

Since  $\mathcal{X}_\Lambda^{(*,0)}(L_{1,\dots,j}, L_{j+1,\dots,j})$  decomposes as a sum of finitely many staircases, each of which is homotopy equivalent to a finitely generated truncation, as above, the direct sum is homotopy equivalent to a finitely generated complex, completing the proof.  $\square$

We now prove a basic lemma concerning homological algebra.

**Lemma 18.14.** *Write  $\mathcal{R} = \mathbb{F}[U_1, \dots, U_{j-1}, \mathcal{U}_{j+1}, \mathcal{V}_{j+1}, \dots, \mathcal{U}_n, \mathcal{V}_n]$ , where  $0 < j < n$ . Write  $\mathcal{R}[U_j]$  for  $\mathcal{R} \otimes \mathbb{F}[U_j]$ . Suppose that  $\mathcal{X}^{\mathcal{R}[U_j]}$  is a finitely generated type- $D$  module which admits a relative  $\mathbb{Q} \times \mathbb{Q}$ -valued  $(\text{gr}_w, \text{gr}_z)$ -bigrading. Suppose that  $U_j \simeq \mathcal{U}_n \mathcal{V}_n$  as type- $D$  morphisms (i.e. there is a morphism  $J^1$  satisfying  $\partial_{\text{Mor}}(J^1) = \text{id} \otimes (U_j + \mathcal{U}_n \mathcal{V}_n)$ ).*



Then

$$\left( \mathcal{X}^{\mathcal{R}[U_j]} \boxtimes_{\mathbb{F}[U_j]} \mathbb{F}[U_j] \right)^{\mathcal{R}}$$

is homotopy equivalent to a finitely generated type- $D$  module over  $\mathcal{R}$ .

*Remark 18.15.* The condition on the  $(\text{gr}_w, \text{gr}_z)$ -bigrading is likely not absolutely necessary, though it simplifies the discussion on completions.

*Proof.* Our proof uses homological perturbation theory. We view  $\mathcal{X}^{\mathcal{R}[U_j]}$  as being obtained from a  $DA$ -bimodule  ${}_{\Lambda}\mathcal{W}^{\mathcal{R}[U_j]}$  where  $\Lambda$  denotes the exterior algebra on one generator. We define  $\delta_{k+1}^1(\theta, \dots, \theta, \mathbf{x})$  on  $\mathcal{W}$  to consist of the components of  $\delta^1$  of  $\mathcal{X}$  which are weighted by an algebra element of total  $\mathcal{R}$ -degree equal to  $k$ . It is straightforward to see that  $\mathcal{W}$  satisfies the  $DA$ -bimodule structure relations.

Note that  $\delta_1^1$  on  $\mathcal{W}$  consists of exactly the terms of the differential of  $\mathcal{X}$  which are weighted by elements of  $\mathbb{F}[U_j]$ .

Let  $\mathcal{E}^{\Lambda}$  be the rank 1 type- $D$  module with  $\delta^1(1) = 1 \otimes \theta$ , so that

$$\mathcal{E}^{\Lambda} \boxtimes_{\Lambda} {}_{\Lambda}\mathcal{W}^{\mathcal{R}[U_j]} = \mathcal{X}^{\mathcal{R}[U_j]}.$$

We consider the type- $D$  module  $\mathcal{Y}^{\mathcal{R}[U_j]}$  obtained by applying the forgetful functor to

$${}_{\Lambda}\mathcal{W}^{\mathcal{R}[U_j]}.$$

The type- $D$  module  $\mathcal{Y}^{\mathcal{R}[U_j]}$  has  $\delta^1$  with algebra elements in  $\mathbb{F}[U_j]$ , i.e., we may view it as a finitely generated free chain complex over  $\mathbb{F}[U_j]$ . Setting all variables except  $U_j$  equal to 0, the map  $J^1$  induces a map  $h^1$  on  $\mathcal{Y}^{\mathcal{R}[U_j]}$  which satisfies  $\partial_{\text{Mor}}(j^1) = \text{id} \otimes U_j$ . The classification theorem for finitely generated chain complexes over a PID implies that we may find a basis of  $\mathcal{Y}$  so that  $\mathcal{Y}^{\mathcal{R}[U_j]}$  decomposes as a direct sum of 1-step complexes (i.e. generators with vanishing  $\delta^1$ ), and 2-step complexes (i.e. summands generated by two generators with  $\delta^1(\mathbf{y}) = 0$  and  $\delta^1(\mathbf{x}) = \mathbf{y} \otimes \alpha$ ). Our assumptions about the existence of a relative bigrading imply that  $\alpha$  may always be taken to be a power of  $U_j$ . The fact that  $\partial_{\text{Mor}}(j^1) = \text{id} \otimes U_j$  implies that there are no 1-step summands, and each 2-step summand is of the form  $\delta^1(\mathbf{x}) = \mathbf{y} \otimes U_j$ .

We define the finite dimensional subspace  $\mathcal{Q} \subseteq \mathcal{W} \boxtimes \mathbb{F}[U_j]$  as follows. Enumerate the generators of the  $U_j^s$ -weighted 2-step complexes as  $\mathbf{x}_t$  and  $\mathbf{y}_t$ , so that  $\delta^1(\mathbf{x}_t) = \mathbf{y}_t \otimes U_j$ , for  $t$  in some finite set. We define  $\mathcal{Q}$  to be the  $\mathbb{F}$  span of  $\mathbf{y}_t \otimes 1$ , ranging over all  $t$ . We view  $\mathcal{Q}$  as being a finitely generated type- $D$  module over  $\mathcal{R}$  with vanishing differential. There are maps forming a homotopy equivalence of type- $D$  modules

$$\begin{aligned} \pi^1: (\mathcal{W} \boxtimes \mathbb{F}[U_j])^{\mathcal{R}} &\rightarrow \mathcal{Q}^{\mathcal{R}}, & i^1: \mathcal{Q}^{\mathcal{R}} &\rightarrow (\mathcal{W} \boxtimes \mathbb{F}[U_j])^{\mathcal{R}}, \\ \text{and } h^1: (\mathcal{W} \boxtimes \mathbb{F}[U_j])^{\mathcal{R}} &\rightarrow (\mathcal{W} \boxtimes \mathbb{F}[U_j])^{\mathcal{R}}, \end{aligned}$$

which satisfy the assumptions of the homological perturbation lemma stated in Lemma 4.2.

The map  $\pi^1$  sends  $\mathbf{y}_t \otimes U_j^s$  to  $\mathbf{y}_t \otimes 1$  if  $s = 0$ , and is zero on all generators. The map  $i^1$  sends  $\mathbf{y}_t$  to  $(\mathbf{y}_t \otimes 1) \otimes 1$ . The map  $h^1$  sends  $\mathbf{y}_t \otimes U_j^s$  to  $(\mathbf{y}_t \otimes U_j^{s-1}) \otimes 1$  if  $s > 0$ , and  $h^1$  vanishes on all other generators. Applying the homological perturbation lemma endows  $\mathcal{Q}^{\mathcal{R}}$  with a left action of  $\Lambda$ . And also yields a homotopy equivalence  ${}_{\Lambda}\mathcal{Q}^{\mathcal{R}} \simeq {}_{\Lambda}\mathcal{W}^{\mathcal{R}[U_j]} \boxtimes_{\mathbb{F}[U_j]} \mathbb{F}[U_j]$ . Note that the induced  $A_{\infty}$ -module structure is operationally bounded by grading considerations. Finally, boxing with the identity morphism of  $\mathcal{E}^{\Lambda}$  gives a homotopy equivalence as in the statement.  $\square$

We are now able to prove finite generation in general:

*Proof of Proposition 18.11.* Suppose that  $L = K_1 \cup \cdots \cup K_n$  is a link in  $S^3$ , and  $\Lambda$  is an integral framing on  $L$ . Let  $0 \leq j < n$ . It is sufficient to show that

$$\mathcal{X}_\Lambda^{(*,0)}(L_{1,\dots,j}, L_{j+1,\dots,n})^{\mathbb{F}[\mathcal{U}_{j+1}, \mathcal{V}_{j+1}, \dots, \mathcal{U}_n, \mathcal{V}_n]}$$

is homotopy equivalent to a finitely generated type- $D$  module over  $\mathbb{F}[\mathcal{U}_{j+1}, \mathcal{V}_{j+1}, \dots, \mathcal{U}_n, \mathcal{V}_n]$ . This is sufficient since we may use this model at each point of the cube  $\mathbb{E}_{n-j}$  to obtain a finitely generated model of  $\mathcal{X}_\Lambda(L_{1,\dots,j}, L_{j+1,\dots,n})^{\mathcal{L}^{n-j}}$ .

By Proposition 13.2, changing the arc system on the components  $K_1, \dots, K_j$  does not change the homotopy type of  $\mathcal{X}_\Lambda(L_{1,\dots,j}, L_{j+1,\dots,n})^{\mathcal{L}^{n-j}}$ . Hence, we assume all of the arcs for  $K_1, \dots, K_j$  are alpha-parallel.

Lemma 18.12 verifies that if  $\Lambda_{(j)}$  is positive definite, then

$$\mathcal{X}_\Lambda^{(*,0)}(L_{1,\dots,j}, L_{j+1,\dots,n})^{\mathbb{F}[U_1, \dots, U_j, \mathcal{U}_{j+1}, \mathcal{V}_{j+1}, \dots, \mathcal{U}_n, \mathcal{V}_n]}$$

is homotopy equivalent to a finitely generated type- $D$  module. Furthermore, since  $\Lambda_{(j)}$  is positive definite (in particular non-singular), it is straightforward to see that this complex admits a relative  $\mathbb{Q} \times \mathbb{Q}$ -valued  $(\text{gr}_w, \text{gr}_z)$ -bigrading (compare [MO10, Section 9.3]). Lemma 13.29 implies that each  $U_1, \dots, U_j$  is chain homotopic to  $\mathcal{U}_n \mathcal{V}_n$  as a type- $D$  endomorphism on this subcube. (Note that on this subcube, the  $K_n$ -direction is never incremented, so the arc for  $K_n$  is irrelevant). Lemma 18.14 now implies that  $\mathcal{X}_\Lambda^{(*,0)}(L_{1,\dots,j}, L_{j+1,\dots,n})^{\mathbb{F}[\mathcal{U}_{j+1}, \mathcal{V}_{j+1}, \dots, \mathcal{U}_n, \mathcal{V}_n]}$  is homotopy equivalent to a finitely generated type- $D$  module.

Since  $\kappa \mathcal{D}_\infty^{\mathbb{F}[U]}$  is homotopy equivalent to a finitely generated type- $DA$  module by Lemma 18.7, we observe that the claim still holds if we replace any number of framings in a positive definite  $\Lambda_{(j)}$  with  $+\infty$ . The mapping cone of two finitely generated complexes is finitely generated, so the surgery exact triangle from Proposition 18.8 (cf. Remark 18.10), implies that  $\mathcal{X}_\Lambda(L_{1,\dots,j}, L_{j+1,\dots,n})^{\mathcal{L}^{n-j}}$  is homotopy equivalent to finitely generated type- $D$  module for any framing, concluding the proof.  $\square$

## APPENDIX A. SPLICING OPERATIONS

In this section, we describe some topology related to splicing knot complements. Everything in this section is well-known, and we only include it as a reference.

**A.1. Splices and connected sums.** Suppose that  $K_1$  and  $K_2$  are knots in  $S^3$ . The complements of  $K_1$  and  $K_2$  are manifolds with torus boundary. The following is well known, though we give a proof for the convenience of the reader. Compare [Gor83, Section 7].

**Lemma A.1.** *Suppose that  $\lambda_1$  and  $\lambda_2$  are integral framings on knots  $K_1$  and  $K_2$  in  $S^3$ , and let  $[\lambda_1]$  and  $[\lambda_2]$  denote the induced elements of  $H_1(\partial S^3 \setminus N(K_1))$  and  $H_1(\partial S^3 \setminus N(K_2))$ . Then  $S^3_{\lambda_1 + \lambda_2}(K_1 \# K_2)$  is diffeomorphic to the 3-manifold obtained by gluing  $S^3 \setminus N(K_1)$  to  $S^3 \setminus N(K_2)$  using the diffeomorphism which sends*

$$[\lambda_1] \mapsto -[\lambda_2] \quad \text{and} \quad [\mu_1] \mapsto [\mu_2].$$

*Proof.* Consider the manifold  $Z$  obtained by gluing the complements of  $K_1$  and  $K_2$  as described above. We may describe  $Z$  alternatively by first attaching a 3-dimensional 1-handle to connect  $S^3 \setminus \nu(K_1)$  and  $S^3 \setminus \nu(K_2)$ , and then attaching two 2-handles and one 3-handle. The first 2-handle is attached along  $\mu_1 * \bar{\mu}_2$  (where  $\bar{\mu}_2$  denotes  $\mu_2$  with orientation reverses), and the second 2-handle is attached along  $\lambda_1 * \lambda_2$ . In both cases, the curves are concatenated across the 1-handle.

We observe that joining  $S^3 \setminus \nu(K_1)$  and  $S^3 \setminus \nu(K_2)$  with the 1-handle and the 2-handle tracing  $\mu_1 * \bar{\mu}_2$  is the same as gluing  $S^3 \setminus \nu(K_1)$  and  $S^3 \setminus \nu(K_2)$  along meridians of  $K_1$  and  $K_2$ . This gives  $S^3 \setminus \nu(K_1 \# K_2)$ . Gluing the second 2-handle and then the 3-handle is the same as performing Dehn surgery on  $K_1 \# K_2$  with framing  $\lambda_1 + \lambda_2$ .  $\square$

*Remark A.2.* The argument above also holds for arbitrary knots in 3-manifolds, as long as the framings are Morse.

*Remark A.3.* The same argument works for links. Suppose that  $L_1$  and  $L_2$  are links in  $S^3$  with framings  $\Lambda_1$  and  $\Lambda_2$ . Suppose that  $K_1$  and  $K_2$  are two chosen components of  $L_1$  and  $L_2$ , respectively. Then

$$S^3_{\Lambda_1 + \Lambda_2}(L_1 \# L_2) \cong M_{\Lambda_1}(L_1, K_1) \cup_{\phi} M_{\Lambda_2}(L_2, K_2),$$

where  $M_{\Lambda_i}(L_i, K_i)$  is the manifold obtained by surgering along  $L_i - K_i$ , and removing a neighborhood of  $K_i$ . The diffeomorphism  $\phi$  which identifies  $\partial N(K_1)$  with  $\partial N(K_2)$  sends  $\lambda_1$  to  $-\lambda_2$ , and  $\mu_1$  to  $\mu_2$ . The framing  $\Lambda_1 + \Lambda_2$  is obtained by summing the framings for  $K_1$  and  $K_2$ , and leaving the remaining framings unchanged.

**A.2. The Hopf link and changes of parametrization.** We may naturally view the Hopf link as a link which changes the boundary parametrization. There are two ways to do this:

- (1) (Blow up) If  $K$  is the special component, and we connect sum with a Hopf link, and leave  $K$  the special component. If we give the other component of the Hopf link framing  $\pm 1$ , then we change the framing on  $\partial N(K)$  by a Dehn twist along the meridian.
- (2) (Rotating layer) Noting that the complement of the Hopf link is  $\mathbb{T}^2 \times [0, 1]$ , we may use the description from the previous remark to see the effect of connect summing the Hopf link to the special component, and using the new Hopf link component as the special component. The effect is to change the boundary parametrization by composing with one of the two maps:

$$\begin{aligned} \mu \mapsto \lambda \quad \text{and} \quad \lambda \mapsto -\mu, \quad \text{or} \\ \mu \mapsto -\lambda \quad \text{and} \quad \lambda \mapsto \mu. \end{aligned}$$

These two cases are distinguished by the sign of the Hopf link which is used in the connected sum.

## REFERENCES

- [AM69] M. F. Atiyah and I. G. MacDonald, *Introduction to commutative algebra*, Addison-Wesley Publishing Co., Reading, Mass.-London-Don Mills, Ont., 1969.
- [Bei08] A. Beilinson, *Remarks on topological algebras*, Mosc. Math. J. **8** (2008), no. 1, 1–20, 183.
- [Eft06] Eaman Eftekhary, *Heegaard Floer homology and Morse surgery*, 2006. e-print, arXiv:0603171 [math.GT].

- [Eft15] ———, *Floer homology and splicing knot complements*, *Algebr. Geom. Topol.* **15** (2015), no. 6, 3155–3213.
- [Gor83] C. McA. Gordon, *Dehn surgery and satellite knots*, *Trans. Amer. Math. Soc.* **275** (1983), no. 2, 687–708.
- [Gro54] A. Grothendieck, *Produits tensoriels topologiques et espaces nucléaires*, *Séminaire Bourbaki*, Vol. 2, 1954, pp. Exp. No. 69, 193–200.
- [Han17] Jonathan Hanselman, *Splicing integer framed knot complements and bordered Heegaard Floer homology*, *Quantum Topol.* **8** (2017), no. 4, 715–748.
- [HHSZ20] Kristen Hendricks, Jennifer Hom, Matthew Stoffregen, and Ian Zemke, *Surgery exact triangles and involutive Heegaard Floer homology*, 2020. e-print, arXiv:2011.00113 [math.GT].
- [HHSZ21] ———, *Naturality and functoriality in involutive Heegaard Floer homology*, 2021. e-print, [2201.12906](#) [math.GT].
- [HHSZ22] ———, *A dual knot mapping cone formula for involutive Heegaard Floer homology*, 2022. e-print, [2205.12798](#) [math.GT].
- [HK91] Johannes Huebschmann and Tornike Kadeishvili, *Small models for chain algebras*, *Math. Z.* **207** (1991), no. 2, 245–280.
- [HL16] Matthew Hedden and Adam Simon Levine, *Splicing knot complements and bordered Floer homology*, *J. Reine Angew. Math.* **720** (2016), 129–154.
- [HL19] ———, *A surgery formula for knot Floer homology*, 2019. e-print, arXiv:1901.02488 [math.GT].
- [HM17] Kristen Hendricks and Ciprian Manolescu, *Involutive Heegaard Floer homology*, *Duke Math. J.* **166** (2017), no. 7, 1211–1299.
- [Kad82] T. V. Kadeishvili, *The algebraic structure in the homology of an  $A(\infty)$ -algebra*, *Soobshch. Akad. Nauk Gruzin. SSR* **108** (1982), no. 2, 249–252 (1983).
- [Kel01] Bernhard Keller, *Introduction to  $A$ -infinity algebras and modules*, *Homology Homotopy Appl.* **3** (2001), no. 1, 1–35.
- [Kel02] ———, *Addendum to: “Introduction to  $A$ -infinity algebras and modules”*, *Homology Homotopy Appl.* **4** (2002), no. 1, 25–28.
- [KLT21] Çağrı Karakurt, Tye Lidman, and Eamonn Tweedy, *Heegaard Floer homology and splicing homology spheres*, *Math. Res. Lett.* **28** (2021), no. 1, 93–106.
- [KS01] Maxim Kontsevich and Yan Soibelman, *Homological mirror symmetry and torus fibrations*, *Symplectic geometry and mirror symmetry (Seoul, 2000)*, 2001, pp. 203–263.
- [Lef42] Solomon Lefschetz, *Algebraic Topology*, *American Mathematical Society Colloquium Publications*, Vol. 27, American Mathematical Society, New York, 1942.
- [Lip06] Robert Lipshitz, *A cylindrical reformulation of Heegaard Floer homology*, *Geom. Topol.* **10** (2006), 955–1097.
- [Liu14] Yajing Liu, *Heegaard Floer homology of surgeries on two-bridge links*, 2014. e-print, arXiv:1402.5727 [math.GT].
- [Lod11] Jean-Louis Loday, *The diagonal of the Stasheff polytope* **287** (2011), 269–292.
- [LOT14] Robert Lipshitz, Peter S. Ozsváth, and Dylan P. Thurston, *Bordered Floer homology and the spectral sequence of a branched double cover I*, *J. Topol.* **7** (2014), no. 4, 1155–1199.
- [LOT15] ———, *Bimodules in bordered Heegaard Floer homology*, *Geom. Topol.* **19** (2015), no. 2, 525–724.
- [LOT16] ———, *Bordered Floer homology and the spectral sequence of a branched double cover II: the spectral sequences agree*, *J. Topol.* **9** (2016), no. 2, 607–686.
- [LOT18] Robert Lipshitz, Peter S. Ozsváth, and Dylan P. Thurston, *Bordered Heegaard Floer homology*, *Mem. Amer. Math. Soc.* **254** (2018), no. 1216, viii+279.
- [LOT20] Robert Lipshitz, Peter Ozsváth, and Dylan Thurston, *Diagonals and  $A$ -infinity tensor products*, 2020. e-print, arXiv:2009.05222 [math.GT].
- [LS19] Robert Lipshitz and Sucharit Sarkar, *Khovanov homology detects split links*, 2019. e-print, arXiv:1910.04246 [math.GT].
- [MO10] Ciprian Manolescu and Peter S. Ozsváth, *Heegaard Floer homology and integer surgeries on links*, 2010. e-print, arXiv:1011.1317 [math.GT].
- [MS06] Martin Markl and Steve Shnider, *Associahedra, cellular  $W$ -construction and products of  $A_\infty$ -algebras*, *Trans. Amer. Math. Soc.* **358** (2006), no. 6, 2353–2372.

- [Ném05] András Némethi, *On the Ozsváth-Szabó invariant of negative definite plumbed 3-manifolds*, *Geom. Topol.* **9** (2005), 991–1042.
- [Ném08] ———, *Lattice cohomology of normal surface singularities*, *Publ. Res. Inst. Math. Sci.* **44** (2008), no. 2, 507–543.
- [Ni14] Yi Ni, *Homological actions on sutured Floer homology*, *Math. Res. Lett.* **21** (2014), no. 5, 1177–1197.
- [OS04a] Peter Ozsváth and Zoltán Szabó, *Holomorphic disks and knot invariants*, *Adv. Math.* **186** (2004), no. 1, 58–116.
- [OS04b] ———, *Holomorphic disks and topological invariants for closed three-manifolds*, *Ann. of Math. (2)* **159** (2004), no. 3, 1027–1158.
- [OS04c] Peter S. Ozsváth and Zoltán Szabó, *Holomorphic disks and three-manifold invariants: properties and applications*, *Ann. of Math. (2)* **159** (2004), no. 3, 1159–1245.
- [OS08a] Peter Ozsváth and Zoltán Szabó, *Holomorphic disks, link invariants and the multi-variable Alexander polynomial*, *Algebr. Geom. Topol.* **8** (2008), no. 2, 615–692.
- [OS08b] Peter S. Ozsváth and Zoltán Szabó, *Knot Floer homology and integer surgeries*, *Algebr. Geom. Topol.* **8** (2008), no. 1, 101–153.
- [OS11] Peter Ozsváth and Zoltán Szabó, *Knot Floer homology and rational surgeries*, *Algebr. Geom. Topol.* **11** (2011), no. 1, 1–68.
- [OS18] Peter Ozsváth and Zoltán Szabó, *Kauffman states, bordered algebras, and a bigraded knot invariant*, *Adv. Math.* **328** (2018), 1088–1198.
- [OS19] ———, *Algebras with matchings and knot Floer homology*, 2019. e-print arXiv:1912.01657 [math.GT].
- [Pos20] Leonid Positelski, *Exact categories of topological vector spaces with linear topology* (2020). e-print, arXiv:2012.15431 [math.CT].
- [Ras03] Jacob Rasmussen, *Floer homology and knot complements*, Ph.D. Thesis, 2003. arXiv:math/0306378.
- [Sar15] Sucharit Sarkar, *Moving basepoints and the induced automorphisms of link Floer homology*, *Algebr. Geom. Topol.* **15** (2015), no. 5, 2479–2515.
- [Sei08] Paul Seidel, *Fukaya categories and Picard-Lefschetz theory*, Zurich Lectures in Advanced Mathematics, European Mathematical Society (EMS), Zürich, 2008.
- [Sta61] James Dillon Stasheff, *Homotopy associativity of H-spaces*, ProQuest LLC, Ann Arbor, MI, 1961. Thesis (Ph.D.)–Princeton University.
- [SU04] Samson Sanedidze and Ronald Umble, *Diagonals on the permutahedra, multiplihedra and associahedra*, *Homology Homotopy Appl.* **6** (2004), no. 1, 363–411.
- [Zem15] Ian Zemke, *Graph cobordisms and Heegaard Floer homology*, 2015. e-print, arXiv:1512.01184 [math.GT].
- [Zem17] ———, *Quasistabilization and basepoint moving maps in link Floer homology*, *Algebr. Geom. Topol.* **17** (2017), no. 6, 3461–3518.
- [Zem19a] ———, *Link cobordisms and absolute gradings on link Floer homology*, *Quantum Topol.* **10** (2019), no. 2, 207–323.
- [Zem19b] ———, *Link cobordisms and functoriality in link Floer homology*, *J. Topol.* **12** (2019), no. 1, 94–220.
- [Zem21] ———, *The equivalence of lattice and Heegaard-Floer homology*, 2021. e-print, arXiv 2111.14962 [math.GT].
- [Zem] ———, *Bordered link surgery bimodules for satellite operations*. In progress.

DEPARTMENT OF MATHEMATICS, PRINCETON UNIVERSITY, PRINCETON, NJ, USA  
 Email address: izemke@math.princeton.edu