

ENERO: Efficient Real-Time Routing Optimization

Paul Almasan*, Shihan Xiao[†], Xiang Cheng[†], Xiang Shi[†], Pere Barlet-Ros*, Albert Cabellos-Aparicio*

*Barcelona Neural Networking Center, Universitat Politècnica de Catalunya, Spain

[†]Network Technology Lab., Huawei Technologies Co.,Ltd.

Abstract—Wide Area Networks (WAN) are a key infrastructure in today’s society. During the last years, WANs have seen a considerable increase in network’s traffic as well as in the number of network applications. To enable the deployment of emergent network applications (e.g., Vehicular networks, Internet of Things), existing Traffic Engineering (TE) solutions must be able to achieve high performance real-time network operation. In addition, TE solutions must be able to adapt to dynamic scenarios (e.g., changes in the traffic matrix or topology link failures). However, current TE technologies rely on hand-crafted heuristics or computationally expensive solvers, which are not suitable for highly dynamic TE scenarios.

In this paper we propose Enero, an efficient real-time TE engine. Enero is based on a two-stage optimization process. In the first one, it leverages Deep Reinforcement Learning (DRL) to optimize the routing configuration by generating a long-term TE strategy. We integrated a Graph Neural Network (GNN) into the DRL agent to enable efficient TE on dynamic networks. In the second stage, Enero uses a Local Search algorithm to improve DRL’s solution without adding computational overhead to the optimization process. Enero offers a lower bound in performance, enabling the network operator to know the worst-case performance of the DRL agent. We believe that the lower bound in performance will lighten the path of deploying DRL-based solutions in real-world network scenarios. The experimental results indicate that Enero is able to operate in real-world dynamic network topologies in 4.5 seconds on average for topologies up to 100 edges.

I. INTRODUCTION

In the last years, Wide Area Networks (WAN) have seen a considerable growth in network traffic and applications (e.g., video streaming, video games), imposing new requirements on existing network technologies [1], [2], [3]. Some examples of such requirements are to support sudden changes in traffic demands, to enable the deployment of applications with different requirements (e.g., low latency, high throughput) or to adapt to changes in the network topology (e.g., link failures). To ensure adequate network functioning, Internet Service Providers (ISP) need to efficiently and effectively manage the network infrastructure.

The networking community adapted the Software Defined Networking (SDN) paradigm [4] to enable efficient operation and management of network resources. SDN offers a centralized overview of the network state and enables the controller to flexibly change the flow’s routing policies. This problem is also known as Traffic Engineering (TE) and it consists of routing the traffic flows in a network with the goal of maximizing network’s performance and optimally using the network’s resources. TE is proven to be NP-hard [5], [6], meaning that it is a combinatorial optimization problem whose

solution can not be found in a deterministic polynomial time. To solve TE problems, the SDN controller uses optimization techniques to search for the best network configuration.

Existing network optimization techniques can be generally divided among optimizer-based solutions and heuristics. The optimizer-based solutions are those that formalize the original TE problem using mathematical expressions and use traditional optimization engines such as Gurobi [7] or CPLEX [8] to find a solution. These kinds of TE solutions suffer from scalability issues, meaning that the optimization time and the problem instance size scale at different speeds. Specifically, to optimize on large real-world scenarios using an optimization engine can take a long time (e.g., up to several weeks). The second category corresponds to the heuristics designed by human experts. These TE solutions make strong assumptions and simplifications on the original TE problem to reduce its complexity and make it easier for a human expert to design an algorithm. This makes the heuristic-based TE solvers reach far-from-optimal TE solutions.

In this paper, we explore the feasibility of designing a Deep Reinforcement Learning (DRL) based method for solving TE problems in real-time. We propose *Enero*¹, a high performance optimization engine for solving TE problems. Our solution is able to operate in real-time, which enables it to offer network reliability in front of link failures. In contrast to other existing solutions, our method does not require the network operators to design hand-tuned heuristics nor to use expert knowledge. Following the latest trends of self-driving networks [9], [10], we expect our work to bring the research community a step closer to achieve this goal.

DRL for hard combinatorial optimization problems has shown huge capabilities in problem solving [11], [12]. The TE problem can be seen as a combinatorial problem where traffic demands are assigned to routing policies such that the utilization of the most loaded link is minimized. We consider a traffic demand as an aggregate of flows between a source-destination node pair. The TE problem is a multi-step decision making process where the decisions have long term effects (i.e., we do not know if the assignment of a routing policy to a traffic demand is good until we have iterated over all traffic demands). Consequently, DRL is a promising technology to solve this problem because it’s evaluation process is defined by a multi-step episode where the actions can have delayed consequences (or rewards). To clarify, DRL is capable of

¹Efficient Real-time Routing Optimization

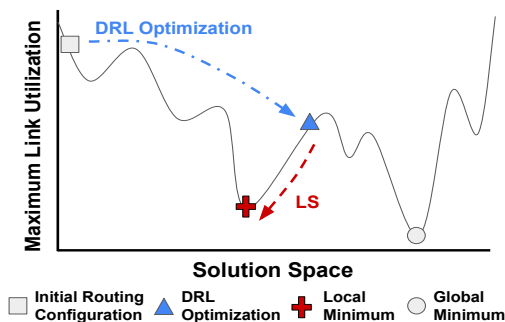

Fig. 1: Intuition behind combining Enero’s two-stage optimization process. In the first part, the DRL agent finds a good solution. Then, LS would improve DRL’s solution and approach a local minimum.

learning the relations between a given action and its delayed effect in the optimization objective.

The difficulty of TE combinatorial problems can make the DRL reach sub-optimal solutions. The reason behind this is that when the DRL agent makes a bad decision, it has no way to undo it and explore other actions. Consequently, Enero is composed of two optimization stages. In the first one, Enero leverages a DRL agent to allocate the traffic demands. The intuition behind the first stage is that the DRL agent creates a long-term routing policy by taking into the future expected rewards. In the second stage, we use a Local Search (LS) algorithm to improve DRL’s solution. With LS, we want to improve DRL’s solution and get closer to a good local minimum configuration (i.e., routing policy that minimizes the maximum link utilization). The motivation behind the combination of DRL with LS is to leverage DRL’s long-term planning capabilities and to improve DRL’s solution using LS. Figure 1 illustrates the intuition behind combining DRL with LS. Combining DRL with traditional optimization techniques has shown to achieve high performance in complex scenarios [13], [14]. We believe that DRL and LS complement each other, increasing the performance of the resulting solutions.

One of the problems of using DRL in real-world scenarios is that it does not offer performance bounds. This means that once a DRL agent is trained, there is no way to give a confidence interval over the DRL agent’s performance. Consequently, network operators might not feel confident to adapt such technology in a real-world industrial deployment. In our work, we designed a method to offer a lower bound in performance for the DRL agent. To do this, we made the DRL agent optimize over an existing routing configuration. Thus, the DRL agent will learn how to find the best solution given an initial routing policy. With our method, Enero will detect the DRL’s low performance and the network operator will have a worst-case guarantee of the DRL agent performance bound by the initial routing policy.

WANs suffer from changes constantly. Real-world physical links can be broken due to external factors and network users have different pattern behaviours that cause difficult-to-predict

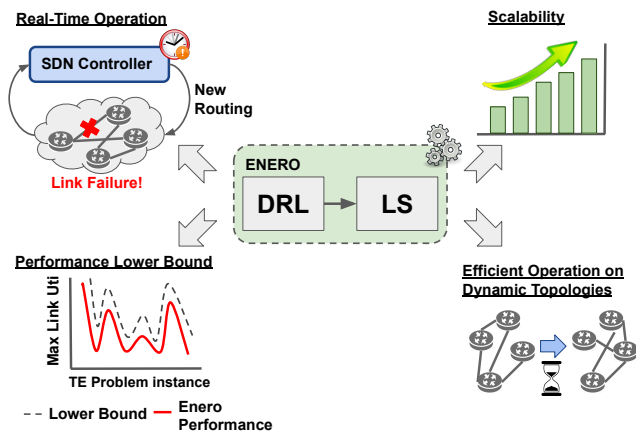

Fig. 2: Overview of Enero’s operation properties.

spikes in network’s resources utilization. In the SDN context, when such events take place the controller must provide an alternative routing configuration in a short period of time to ensure network reliability. When such an event occurs, existing TE solutions based on heuristics or exact solvers need to start the optimization process from scratch. This is very inefficient as the *knowledge* learned from old optimization scenarios (e.g., old topology) is not transferred to the new scenario (e.g., new topology). In our work, we designed a solution that is able to adapt to these changes and leverage the knowledge from past optimizations. To do this, we designed a DRL agent that incorporates Graph Neural Networks (GNN) [15]. GNNs are a novel family of Deep Learning techniques tailored for learning relational information. By using a GNN in the DRL agent we enable it to operate efficiently over different network scenarios when the traffic matrix or the network topology changes during time.

In summary, our work makes the following contributions:

- We propose Enero, a method that leverages DRL and LS to achieve high performance in real-time operation. Figure 2 shows Enero’s main operations properties.
- We design a DRL agent that is able to operate efficiently while link failures occur and is able to adapt to dynamic network scenarios (i.e., traffic matrix changes).
- We propose a method to offer a lower bound in the DRL agent’s operation performance.

II. BACKGROUND

We first describe the TE problem of minimizing the maximum link utilization. Then, we describe the shortcomings of existing solutions. Finally, we outline which are the main challenges that we need to face to enable efficient real-time TE.

A. Problem Statement

In our work, we abstract the real-world network topology as a graph. The physical routers are represented by nodes and in our case they have no features associated. This is because in our TE problem we only need to know the links’ utilization

and capacity. Between two nodes there are always two links which correspond to the upstream and downstream links. In real networks there can be multiple links between two nodes. However, we abstract from such technicality and we aggregate all the capacities into a single link.

We define the TE problem as minimizing the maximum link utilization. Initially, each traffic demand (i.e., an aggregate of flows for each source-destination node pair) is allocated using the OSPF protocol. These OSPF weights are initially assigned by the network operator. Then, the goal is to change the routing policies of all traffic demands such that the maximum link utilization is minimized. Ideally, the final solution should decrease the link utilization in a way that the amount of traffic bandwidth crossing the most loaded link is below the link's capacity.

We leverage Segment Routing (SR) [16] to enable fast and efficient centralized network management. SR is a protocol that includes routing related-information in the IP packet headers. This means that each packet will have assigned a SR path to reach a destination node. Then, SR Ingress routers encapsulate incoming packets to create a tunnel that traverses a SR path before reaching their respective destination. This SR path is composed by different segments, and in each of them, the endpoint node removes the outermost encapsulation label. This process is repeated until the packet reaches the SR Egress node. The packets within a segment are routed using the traditional OSPF routing protocol. In traffic engineering terms, SR can program detours in forwarding paths so that network packets avoid crossing congested links. Previous work showed that SR using 2-segment paths offers enough flexibility to achieve high network performance [17]. In our work we adapt a similar approach and we consider only one intermediate node between SR Ingress and Egress nodes.

Figure 3 shows an illustrative example of minimizing the maximum link utilization by changing the overlay routing for a single traffic demand. The traffic demands are composed by multiple IP packets. In this example, the traffic demand that goes from node A to node E has a bandwidth of 9 and initially uses OSPF to reach the destination. This corresponds to the left-hand side network state from the same figure. Then, a good action to minimize the maximum link utilization would be to re-route the traffic demand through the intermediate node C. This means that the SR path would be A - C - E, where C is the intermediate node. This process is repeated for all the traffic demands, where their routing policies are changed such that the maximum link utilization is minimized.

B. Shortcomings of existing solutions

The TE problem can be formulated as an Integer Linear Programming (ILP) problem and be solved using state-of-the-art optimizer engines such as Gurobi [7] or CPLEX [8]. However, when the problem size grows (i.e., the number of nodes and links grows), the solver could take weeks to find the exact solution. For example, real world production networks have in the order of hundreds of edges and an ILP solver would

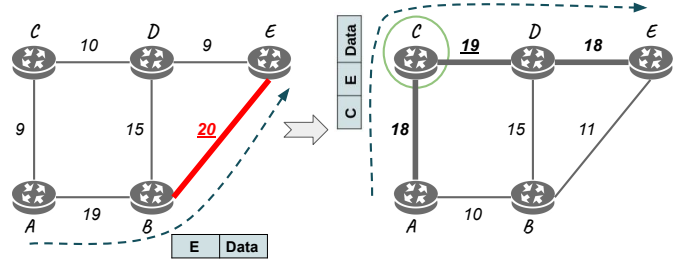

Fig. 3: Example where the routing from the traffic demand A to E is changed. Initially, the traffic demand uses OSPF to reach node E (left-hand side network). After optimization, it uses SR to go to node C before reaching node E.

take several weeks to find the solution to such scenarios [6], [18].

An alternative to ILP is the use of Constraint Programming (CP) [19]. This method defines the combinatorial problem to solve by a set of decision variables, a set of domains (i.e., potential values of the decision variables) and a set of constraints on the feasible solutions. When using CP, the user can indicate some time limit and the solver will return the best solution found within the specified time (e.g., DEFO [6]). This method has the problem of finding sub-optimal solutions if the specified time is not long enough. Therefore, when the network operator wants to find a TE solution to a specific problem, he must estimate how long he should execute the CP solver to get a reasonably good solution.

Finally, network operators can use heuristics. This method requires the network operator to use expert knowledge to design an algorithm to solve TE problems. In addition, they can also use heuristics to reduce the problem dimensionality by pruning the solution space and then use a traditional method to solve the smaller problem (e.g., CP, ILP). However, in the last years, the network's size and traffic has been growing by almost doubling every year [1], [2], [3]. This makes it difficult for experts to design a heuristic with a reasonable performance and it becomes more expensive for the network operator as they need to invest more resources. In addition, human experts typically use a trial-and-error process to design a good solution that can take months. Thus, this solution does not scale well with the recent trends.

C. Challenges

1) *Real-Time Operation:* In our work we prioritized real-time operation but we also wanted to design a solution that achieves high performance. As mentioned previously, optimizer-based solutions are not suitable for real-time operation as they take too long computational time to find a solution. Some solutions use heuristics to reduce the dimensionality of the TE problem, enabling the optimizer to deal with a smaller search space and to find a solution within minutes. However, we believe that minute-scale solutions are not fast enough for real-time operation. Therefore, we wanted to go further and create a method that finds good solutions within seconds. To

do that, we wanted to explore the use of DRL for solving the TE problem. In other words, we wanted to leverage the long-term planning capacity and the low execution overhead of DRL to solve TE problems in real-time.

2) *Performance Bounds*: One of the biggest problems of using heuristics or DRL in combinatorial optimization problems is that they do not offer performance bounds. This means that when we want to evaluate the solution on some problem instance we do not have any method to guarantee some performance threshold or a minimum optimality gap. This is contrary to optimizer-based solutions such as CP or ILP. In CP, once the solver finds a solution, it will try to find a better solution than the previous one. This is done by adding a constraint that impedes the solver to explore worse solutions than the previously found. On the other hand, ILP’s solution optimality is guaranteed [20]. Enero solves the performance bound issue by detecting when the DRL agent performs poorly. In this case, Enero will take the best routing configuration from the DRL stage and send it to the LS stage.

3) *Dynamic Network Topologies*: The TE problem is a combinatorial optimization problem of allocating traffic demands over different paths from the graph. Thus, the new routing policy assigned by the DRL agent for each traffic demand must take into account the current network state and avoid to route traffic demands through potential critical links. To efficiently solve the TE problem, the DRL agent must be able to understand the network topology and identify critical links that might become a bottleneck (i.e., they are likely to be congested quickly). In addition, real-world network topologies can change due to external factors. For example, there can be link failures that change the intrinsic network connectivity. Such failures trigger the SDN controller to re-compute the routing configuration over the new network topology. However, the combinatorial optimization problem is a different one because of the new topology. In other words, the best configuration found in the previous problem instance is not valid anymore as the critical links are different. In our work we leverage Graph Neural Networks to enable the DRL agent to learn graph-structured information and to efficiently plan over arbitrary network topologies.

4) *Scalability*: Finally, the last challenge we face is scalability. This means that our solution should be able to work efficiently on larger TE problem instances without losing performance and with computation times within a minute. In a network topology, there are $N*(N-1)$ traffic demands (i.e., one for each pair of source-destination nodes), being N the number of nodes. This number increases quadratically, making the TE problem more complex for larger topologies. This means that Enero must iterate over all traffic demands and change their routing policies, which can take some time in large topologies.

III. DESIGN

Enero is an efficient method for real-time routing optimization. It uses a two-stages process that combines DRL and LS. In the first stage, Enero leverages DRL to find a good initial solution to the TE problem by taking into account future traffic

demands. In the second stage, Enero tries to improve DRL’s solution using a LS technique. The intuition behind this step is to explore the neighbourhood of the DRL solution and try to find a better solution (i.e., a better local minimum for the optimization problem).

DRL is a technology capable of modeling future rewards, and thus, to optimize the routing configuration taking into account the future. That is to say, DRL can learn the relationships between actions and their delayed rewards. For example, to change a routing policy of a traffic demand might not lead to an immediate minimization of the maximum link utilization but to a delayed one that the DRL agent will observe later in the future. This is contrary to heuristics where they can not establish a relationship between local decisions (e.g., change a routing configuration for a traffic demand) and the long-term strategy to solve the optimization problem (i.e., minimize the most loaded link). This leads the heuristics to achieve sub-optimal performance.

Even though DRL is a key technology to learn long-term strategies, it can still make mistakes. DRL is a data-driven method and when evaluated in out-of-distribution data (i.e., data totally different than the one used in the learning process), it is to be expected that the performance will degrade. In our TE problem this can happen due to different bandwidth scales in the traffic matrices, due to different extreme topologies that can affect the action decision or because of the high complexity of exploring the solution space. To solve this problem and to enable the deployment of the DRL technology on real-world scenarios, we wanted to give some performance lower bound for the DRL agent. With this lower bound, the network operator can know for certain that the DRL agent won’t perform worse than a predefined threshold. To do this, we made the DRL agent return the best routing configuration from an evaluation episode. Notice that in the worst case (i.e., when the DRL agent is not capable of minimizing the maximum link utilization), the DRL agent’s performance will be the one from the initial routing configuration. In our paper we consider OSPF as the starting routing policy and the DRL agent learns to optimize over this configuration. Enero is designed to allow the starting routing policy (i.e., OSPF weights) to be substituted by any routing policy (e.g., expert-knowledge, heuristic-based routing policy).

The number of traffic demands grows quadratically with the number of nodes in a network. For instance, in a topology with 30 nodes we have $30*29 = 870$ traffic demands whose routing needs to be reconfigured to solve the TE problem. Ideally, we would like to take into account all traffic demands in our TE optimization problem to ensure that our solver can find the best routing configuration. However, the solution space becomes intractable for large TE problem instances and computationally expensive even when using heuristics. Inspired by [14], we decided to take a subset of these traffic demands. This is because it might be the case that only by changing a subset of the most critical demands can our DRL agent can achieve a high performance. We initially performed some experiments where we tried to optimize selecting different percentages of

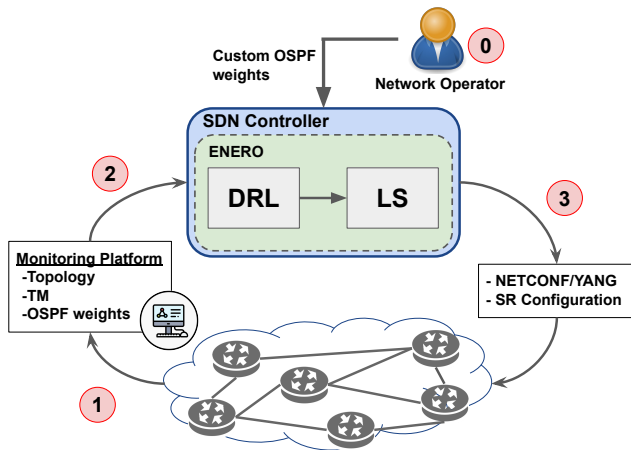

Fig. 4: Enero's workflow.

the most critical demands (i.e., 10, 15, 20 and 50). The results showed that 15% of the critical demands offered the best trade-off between computation time and performance. These demands are selected from the demands crossing the 5 most loaded links.

The complexity of the combinatorial problem can make the DRL agent achieve sub-optimal routing configurations. This is because, on the contrary to some existing solutions that use backtracking (e.g., DEFO [6]), the DRL agent has only one shot to converge to the optimal solution (i.e., a single iteration over all traffic matrices). To solve this issue, we improve DRL's solution using a LS technique without adding a large computational overhead. The LS algorithm makes small changes to the DRL's solution, finding new TE solutions that are fundamentally close to DRL's resulting configuration. In addition, we decided to adapt LS in the second stage for being an anytime optimization technique. This means that the LS search process can be stopped at any moment and the result returned will always be a valid one. Similarly to the DRL case, LS tries to change the routing policy of the 15% most critical traffic demands from DRL's solution.

A. Workflow

Enero is an optimization engine that is placed in the SDN controller. Enero uses a two-stage process to find the best routing configuration that minimizes the maximum link utilization. This optimization process takes as input the network topology, the traffic matrix (TM) and the initial routing configuration. Then, it starts the optimization process, which finishes in under a minute, enabling real-time operation.

Figure 4 shows *Enero's* step-by-step workflow. At the beginning (Step 0), the Network Operator must define the initial OSPF weights. These weights are used to initially route the traffic demands within SR segments [17]. Their values can be assigned either by the network operator using heuristics and expert knowledge or by using some well-established OSPF weights initialization (e.g., unitary weight values, the inverse of the link capacity). The DRL agent will take this OSPF configuration as the starting point in its optimization process.

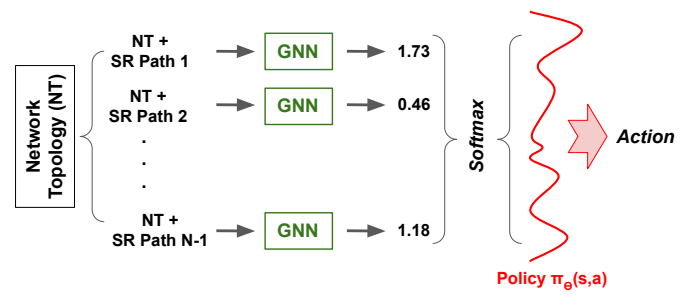

Fig. 5: DRL action space overview. For each candidate SR path, the DRL agent uses the GNN to output a probability distribution over the actions. The SR path with higher probability distribution is the action chosen by the DRL agent.

Then, Enero's optimization process will find the best SR intermediate node assignment for each traffic demand.

Once the initial OSPF routing policy is defined, a monitoring platform is in charge of retrieving the relevant information for the TE optimization problem (Step 1). This information consists of the network topology, the TM and the OSPF weights. Then, Enero takes this information (Step 2) and starts the optimization process. When the process finishes, the routing configuration (i.e., per-demand SR intermediate node assignment) is pushed down to the Data Plane (Step 3). This means that each traffic demand is going to be assigned a SR intermediate node. When there is some change in the Data Plane (e.g., the topology or the TM changed), the monitoring platform will detect these changes and will launch Enero again to optimize the new scenario. There are many efforts put on the design of fast and efficient monitoring platforms and we consider it to be outside the scope of this work [21], [22], [23].

B. Deep Reinforcement Learning

The DRL setup can be described by defining the environment state, the action representation and the reward. The *environment state* includes the network topology with the links' features (i.e., link capacity and utilization). When the DRL agent performs an action (i.e., applies a new routing policy to a given traffic demand), links' utilization is updated after applying the new routing policy. The *action* is represented directly on the network topology by marking the links that are part of the action. In other words, the links of the path going from a source node to a SR intermediate node and from this to the destination node are marked with a flag. All the nodes from the topology can be SR intermediate nodes. This process is repeated for each possible action of the current traffic demand whose routing needs to be changed. The DRL's GNN is then in charge of processing these graphs (i.e., one graph per action where the action is marked directly on the edges) and will output a probability distribution over the actions. Figure 5 shows an overview of this process. Finally, the reward is the difference between the maximum link utilization between two steps. This difference is relative to the links' capacities.

C. Training Algorithm

The DRL agent training process is an iterative process that takes as input a network topology, a set of traffic matrices, the links’ features and the initial OSPF weights defined by the network operator. Then, the DRL agent will learn how to optimize over the given routing configuration and for different TMs. To do this, the DRL agent iterates over the traffic demands following a decreasing bandwidth demand order, changing the routing policy for each demand. This means that for each traffic demand, the DRL agent will assign the best SR intermediate node before reaching the destination node. This process can be seen as changing the direct shortest path from the source node to the destination node by creating a detour. This is a trial-and-error process where at the beginning the agent will explore different routing configurations, and as the training advances, the agent will tend to exploit more of the action space instead.

Algorithm 1 shows the pseudo-code of the actor-critic training process. For the sake of simplicity, the pseudo-code describes the training process using a single network topology. The same process can be applied to multiple topologies by repeating the lines 3 to 9 for each topology. The training process starts in line 2 and finishes when the number of training episodes E has been reached. At the beginning of the training episode, the DRL environment is initialized (line 3). This means that the topology is built and the links’ utilization is updated according to the initial OSPF routing. The loop from line 4 indicates the iteration of the DRL agent over the most critical traffic demands. In each loop iteration, the DRL agent tries to change the routing policy of a single traffic demand (i.e., assign a SR intermediate node). In line 5 the DRL agent uses the GNN to output a probability distribution over the action space. Then, the critic network predicts the value of the current state. The DRL agent uses a

Algorithm 1 DRL Agent Training Process

```

1: Input: Network topology (G), link capacities, TMs, Initial
   OSPF Weights (OSPFw)
2: for  $i$  in  $0, \dots, E$  do
3:    $env, d \leftarrow init\_env(G, TM, OSPFw)$ 
4:   while not Done do
5:      $act\_dist \leftarrow pred\_act\_distrib(env, d)$ 
6:      $c\_val \leftarrow pred\_critic\_value(env)$ 
7:      $a \leftarrow choose\_action(act\_dist)$ 
8:      $d, Done, r \leftarrow step(a, d, env)$ 
9:      $store\_results(act\_dist, c\_val, a, d, Done, r)$ 
10:   $c\_val \leftarrow pred\_critic\_value(env)$ 
11:   $ret, adv \leftarrow compute\_GAE(c\_val', r')$ 
12:   $a\_loss \leftarrow compute\_actor\_loss(adv)$ 
13:   $c\_loss \leftarrow compute\_critic\_loss(ret)$ 
14:   $total\_loss \leftarrow a\_loss + c\_loss - entropy$ 
15:   $grads \leftarrow compute\_gradients(total\_loss)$ 
16:   $clip\_gradients(grads)$ 
17:   $apply\_gradients(grads)$ 

```

Hyperparameter	Value
GNN Hidden State	20
Message Passing Steps	5
Evaluation Episodes per Topology	20
Training Epochs	8
% critical demands	15%
Mini-batch size	55
Learning Rate	0.0002
Decay Rate (Decay Steps)	0.96 (60)
Entropy Beta (After 60 Episodes)	0.01 (0.001)
GAE Gamma, Lambda	0.99, 0.95
Gradient Clipping Value	0.5
Actor L2 Regularization	0.0001
Readout Units	20
Activation Function	Selu

TABLE I: Enero hyperparameter configuration.

random sampling of the action distribution to pick the action to perform (line 7). During evaluation, the sampling is changed by taking the action with higher probability. Then, the action is sent to the environment to be applied over the current network state and to update the links’ utilization. In line 9 the agent stores all the intermediate results that will later be used to compute the losses. The next step is to compute the Generalized Advantage Estimates (GAE), which is a method to reduce variance in policy gradient algorithms [24]. Then, we compute the actor loss [25] and the critic loss (i.e., mean squared error between the return ret (i.e., expected reward following the same policy from the given state) and the critic’s output value c_val). The losses are then combined and we subtract an entropy term which is used to guide the exploration during training [26]. Finally, we compute the gradients, we clip them to avoid the policy to change too much for a given training step and we apply the gradients over the actor and critic networks.

D. Implementation

Enero is implemented in Python, except the DRL part (training and evaluation) that was implemented using Tensorflow [27] and the DRL environment was implemented using the OpenAI Gym framework [28]. We implement the actor-critic PPO algorithm to train the DRL agent [25]. The LS stage is totally implemented in Python except for some operations where we used the Numpy library [29]. The LS execution cost could be improved by using more efficient libraries (e.g., Cython [30]), which we left as future work. For some graph-related operations we used the NetworkX library [31]. In Table I we can see the hyperparameters used during Enero’s DRL agent training stage.

IV. EXPERIMENTAL RESULTS

In this section, we first describe the methodology used to obtain the datasets and to train the DRL agent. Then, we make some experimental study to see the performance gap between DRL, LS and Enero. Finally, we perform a series of experiments on different real-world network scenarios. Specifically, we wanted to answer the following questions:

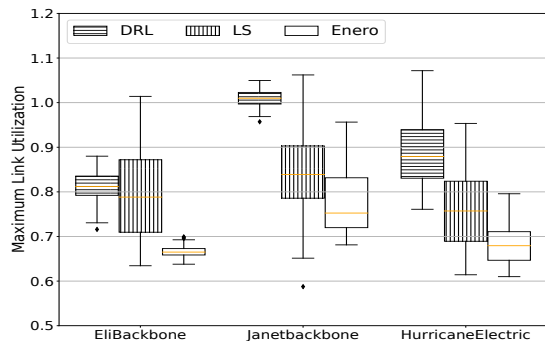

Fig. 6: Performance of LS, DRL and Enero for the EliBackbone, Janetbackbone and HurricaneElectric topologies.

- What is the performance gap between DRL, LS and Enero for solving TE problems? (Subsection IV-B)
- How does Enero perform when the traffic matrix changes during time? (Subsection IV-C)
- What is Enero’s performance when the topology changes as a result of link failures? (Subsection IV-D)
- What is Enero’s performance and execution cost compared with state-of-the-art TE solutions? (Subsection IV-E)

All the experiments were executed on off-the-shelf hardware without any specific hardware accelerator or high performance software optimization engine. Specifically, we used a machine with Ubuntu 20.04.1 LTS with processor AMD Ryzen 9 3950X 16-Core Processor.

A. Methodology

1) *Traffic Matrices*: The traffic matrices are generated using a uniform distribution. This means that the bandwidth values from the traffic demands are uniformly distributed from 0.5 to 1. Then, we scale this value to obtain the TM bandwidths in Kbps and to have the same unit for both bandwidth and link capacities. Each network topology has a total of 150 TMs.

2) *Network Topologies*: We obtain the network topologies from the TopologyZoo dataset [18], which contains real-world topologies from network operators. Specifically, we took all the topologies up to 100 edges and up to 30 nodes. In our TE problem we only consider the link capacities. This means that the nodes do not have any features associated.

3) *DRL Agent Training*: In all the experiments from this paper we are always evaluating the same DRL agent. This means that we have only trained *a single DRL agent* and incorporated it into Enero. To train this DRL agent, we arbitrarily picked 3 network topologies and we split the original 150 TMs into 100 TMs for training and 50 TMs for evaluation. Specifically, we used the BtAsiaPac, Garr199905 and Goodnet topologies.

4) *Comparison Baselines*: We compare Enero with three baselines which together represent widely used heuristics and close-to-optimal solutions. The first baseline is the Shortest Available Path (SAP) heuristic. SAP starts with the empty network and iterates over all traffic demands in decreasing order of bandwidth. This is done to allocate the bigger and

most critical traffic demands first. Then, each traffic demand is routed using the path with the highest available bandwidth. The second baseline corresponds to a LS algorithm. Specifically, we implemented the hill climbing search to improve an initial routing configuration in a greedy fashion. Similarly to Enero, this method starts in the same routing configuration using the OSPF protocol and tries to minimize the maximum link utilization. This is an iterative process where in each step applies the routing policy of the traffic demand that minimizes the maximum link utilization. This process finishes when the maximum link utilization does not improve anymore.

To compute the optimal solution for our TE problem it would require weeks of computation using ILP. As it is not feasible to do that, we chose DEFO [6] as our close-to-optimal baseline. In particular, we took the implementation from [32] and adapted it to have at most one intermediate SR node per traffic demand. DEFO is a CP-based solution and if left enough time executing it provides a close-to-optimal solution. This is the reason why we left DEFO executing for 180 seconds in all of our experiments. Following the recommendations from the experiments in the original paper [6] on very large topologies (i.e., a few hundreds of edges and more than 6.000 traffic demands to optimize), we expect that 180 seconds is enough to find close-to-optimal solutions in our topologies (i.e., we have topologies of up to 100 nodes and 900 traffic demands). DEFO uses Equal-cost multi-path routing (ECMP) to route the traffic demands. This enables DEFO to divide the traffic sent to a node among multiple paths, achieving a better traffic distribution and a lower link utilization. In our problem setup the traffic demands are routed using solely a single path, creating a natural gap between DEFO and Enero’s performance. We left the task of enabling Enero to optimize using ECMP for future work.

B. DRL and LS Hybrid Method

In this section we want to demonstrate the capabilities of combining DRL with LS. To do this we study the performance and execution cost of DRL and LS individually and compare them with Enero. In the experiments, we evaluate the DRL agent, the LS algorithm and Enero on three network topologies using 50 TMs per topology. Figures 6 and 7 show the resulting performance and the CDF of the execution cost respectively. Notice that the topologies from these figures weren’t seen by the DRL agent during the training process. The results indicate that DRL has a reasonably good performance in all three topologies. This is because it can minimize the maximum link utilization from ≈ 1.1 to below 1 for EliBackbone and HurricaneElectric topologies and to ≈ 1 for the Janetbackbone topology. LS can minimize the maximum link utilization in all three topologies, obtaining better performance than DRL. However, the CDF from Figure 7 indicates that the DRL is extremely fast while LS takes a considerable amount of time (up to minutes).

To demonstrate the capabilities of combining DRL with LS we also plot in Figure 6 and 7 Enero’s performance and execution cost. The results indicate that Enero reaches better

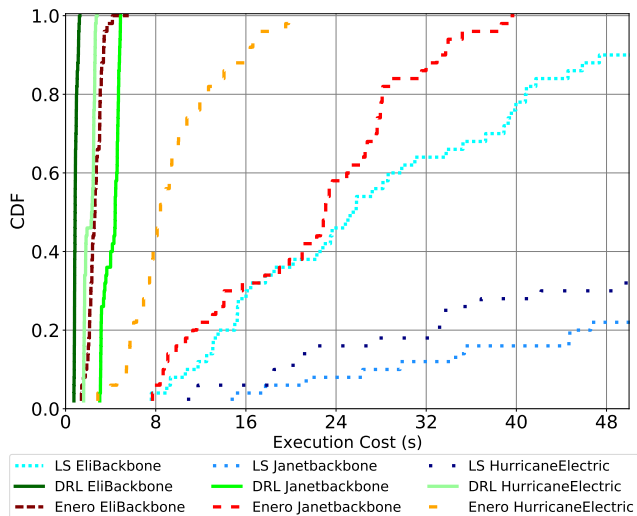

Fig. 7: Execution cost of LS, DRL and Enero for the EliBackbone, Janetbackbone and HurricaneElectric topologies. Best viewed in color.

TE solutions than DRL and LS in all three topologies while the execution time is below 40 seconds for the Janetbackbone topology. Notice that the Janetbackbone topology is a large topology with 812 traffic demands whose routing policy needs to be optimized, which explains the larger execution times.

C. Dynamic Traffic Matrix

In this scenario we want to evaluate Enero’s performance when the traffic matrix changes during time. In our experiments we took the extreme case where every 60 seconds the entire TM changes. The reason behind this is to simulate the worst-case scenario where Enero must re-compute the solution to the TE problem from scratch. We repeat this process until the TM has changed 50 times.

Figure 8 shows the evaluation results on three network topologies with 50 TMs per topology. Each line indicates the progress of the maximum link utilization while Enero is solving the TE problem for a given TM. In reality, the lines should be concatenated one after another but for visualization purposes we aggregated all the events where the TM changed into a single figure per-topology. From the same Figures we can observe Enero’s two-stage optimization process. When the monitoring platform detects a change in the TM (see Section III-A), Enero uses the pre-defined OSPF routing policy and then starts the optimization process. We can appreciate that in all topologies the DRL agent quickly finds a good TE solution and then LS improves it. Notice that the topologies are different than those used during the DRL agent training process. This showcases Enero’s capabilities to perform TE on different network topologies (than those seen during training) and with dynamic changes in the TM.

D. Link Failures

In this experiment we evaluate Enero’s capabilities to react to changes in the network topology resulting from link failures.

We simulated link failures by randomly removing links from the topology in each of the evaluation topologies. We made sure that there are no two topologies that are the same after removing some links. For each link in the topology, there are the upstream and downstream links, and thus, to ensure network connectivity when we drop a link we drop both upstream and downstream links. We simulate up to 8 link failures in total where for each failure we have 20 different topologies and for each topology we have 50 TMs.

We use the original TMs from the topologies in the link failure experiments. In other words, the bandwidths from the TM remain the same while link failures are happening. This means that while the traffic demands didn’t change, the network has less resources to accommodate the original TM. Figure 9 shows Enero’s results after optimization for each link failure and we compare Enero’s results with DEFO and SAP. Because the TM does not change and the topology has less resources to accommodate the bandwidths, the maximum link utilization should be increasing when we drop links from the topology. The results indicate that Enero’s performance has a similar behavior to DEFO regardless of the number of link failures. Recall that DEFO is our close-to-optimal baseline which has been executed during 180 seconds and uses ECMP to split the traffic demands among multiple paths.

E. Operation Performance and Cost

In this experiment we want to evaluate Enero’s performance while operating on a set of real-world topologies. To do this, we take all the topologies from the TopologyZoo dataset that have up to 100 edges and up to 30 nodes. This makes a total of 74 topologies, from which only 3 of them were used in the DRL agent’s training process. Figure 10 shows the evaluation results over all 74 topologies. Specifically, in Figure 10a we plot the relative performance with respect to the LS baseline. The topologies from 20 to 37 are ring, star or line topologies where there is no room for optimization. This explains why all the baselines have exactly the same performance. Figure 10b shows the execution cost of all the baselines. As a reminder, DEFO was set to execute for 180 seconds to ensure a close-to-optimal solution. The results indicate that Enero is capable of obtaining better performance than the SAP and LS baseline and in most of the topologies has a similar performance to DEFO. In addition, Enero’s execution cost is very small, with only 5 topologies with an operation cost of more than 20s.

V. DISCUSSION

Enero is a data-driven solution, where we use some synthetic or real-world data to train the DRL agent. This means that if we deploy our agent over topologies or TMs that are very different than those from the dataset used in the training process, we can expect that our agent’s performance will drop. This explains Enero’s poor performance for the top left topologies from Figure 10a. Specifically, the traffic demand values are all limited by the uniform distribution between 0.5 and 1, meaning that the TM can be discarded as the source of performance instability. Thus, we focused our attention on the

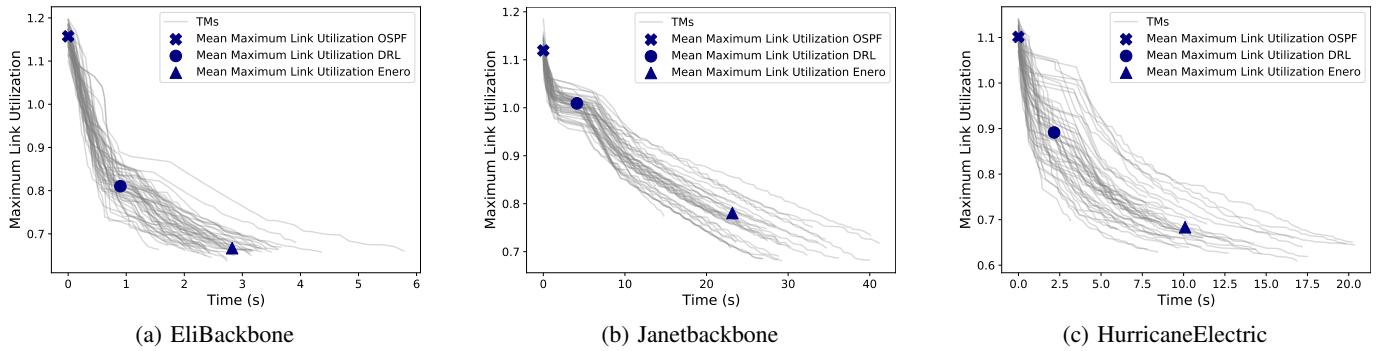

Fig. 8: Dynamic traffic matrix scenario. Eneo evaluation on different real-world network topologies. For each topology, we evaluate over 50 different TMs. Notice that the topologies from this figure weren't seen by the DRL agent during the training process.

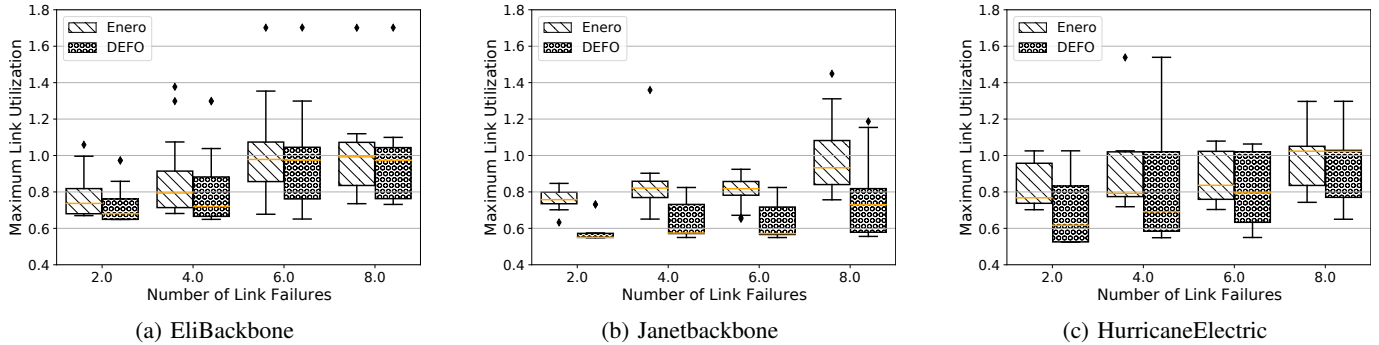

Fig. 9: Link failures scenario. For each number of link failures we have 20 different topologies and we evaluate using 50 TMs for each topology.

network topologies and we wanted to study what is different (in connectivity terms) in the top left topologies in Figure 10a.

We have identified two metrics that showcase the differences between the topologies used during training and those where Eneo's performance is worse. In Table II we can see the node degree and edge betweenness ranges for each topology used during training and for the 4 topologies where Eneo has worse performance. These metrics indicate that the topologies seen during training and the ones where our method performs worse are totally different. For example, the minimum and the average edge betweenness is much higher in the topologies 0, 1, 2 and 3. This indicates that the shortest paths are not well

distributed and they cross the same links, making them become critical links for the TE problem. In addition, the topologies used in the training process have a higher average and a wider range of the node degree. This indicates that the nodes are more interconnected between them than in the topologies 0, 1, 2 and 3.

There are several ways to solve the out-of-distribution problem. For example, we could work with specific Deep Learning techniques such as regularization or dropout. However, the most effective way would be to add more data to the training process. This is translated to our problem by adding more different topologies to the DRL's training phase.

The experimental results showed that the hybrid method of combining DRL with LS enables efficient real-time routing optimization. However, there is still room to push even further the combination of DRL with traditional search methods. The straight-forward approach would be to improve the LS implementation using high performance software (e.g., Cython [30]). Additionally, in our work we used a greedy approach in Eneo's second stage but we could substitute it by more advanced search algorithms (e.g., CP, Genetic Algorithms). For example, we could convert DRL's solution to constraints and then execute some CP solver (e.g., Gurobi [7]) to find a better solution. This would ensure that the solution of the CP phase should be better than the one from the DRL

Topology/Id	Node Degree	Edge Betweenness
BtAsiaPac	(2, 24, 6.2)	(0.010, 0.067, 0.04)
Goodnet	(2, 18, 7.3)	(0.014, 0.059, 0.03)
Garr199905	(2, 18, 4.35)	(0.0435, 0.083, 0.05)
0	(4, 8, 4.3)	(0.043, 0.167, 0.11)
1	(2, 14, 5.23)	(0.026, 0.117, 0.07)
2	(2, 8, 4.2)	(0.044, 0.164, 0.10)
3	(2, 6, 4.0)	(0.067, 0.162, 0.12)

TABLE II: TopologyZoo metrics. For each topology and each metric the tuple values correspond to the (min, max, mean) values respectively. The top 3 topologies are those used during DRL's agent training process.

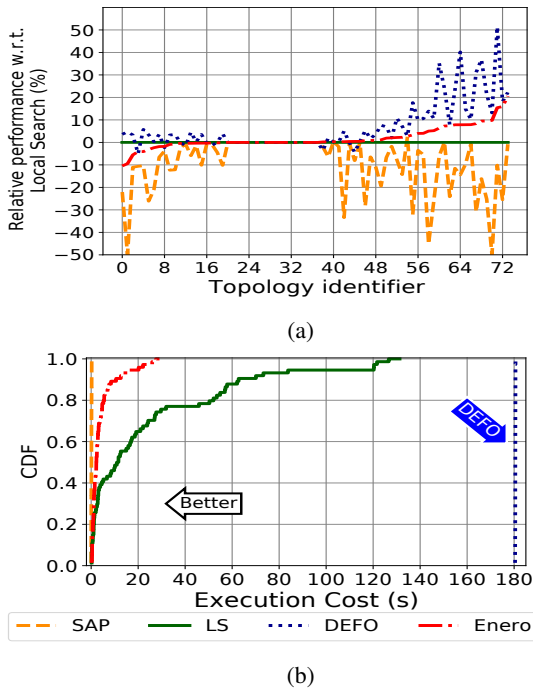

Fig. 10: Relative performance (a) and CDF of the execution cost (b) on the TopologyZoo dataset. The topologies from 20 to 37 are ring or star topologies where there is no room for optimization.

agent and it would enable the second optimization stage to explore better solutions.

VI. RELATED WORK

A. Routing Optimization

To find the optimal routing configuration given an estimated traffic matrix is a fundamental networking problem, which is known to be NP-hard [5], [6]. This problem has been largely studied in the past and we outline some of the most relevant works. The early work from [33] uses LS to find the best OSPF link weights to minimize congestion in the most congested link. In DEFO [6] they propose a solution that converts high-level optimization goals, indicated by the network operator, into specific routing configurations using CP. Their problem formulation leverages SR to find the best routing configuration for each traffic demand. Within a SR path, they spread the traffic among several flows using ECMP. In [34], the authors propose to use LS where they sacrifice space exploration to achieve lower execution times. In their design they also leverage heuristics to narrow down the LS neighbourhood and to make the algorithm converge faster to good solutions. A more recent work [35] leverages the ILP and the column generation algorithm to solve TE problems. Their solution also provides a bound to indicate how far the solution is from the optimal one.

B. Machine Learning for Communication Networks and Systems

Recently, numerous Machine Learning-based solutions have been proposed to solve networking problems. In [36], they propose a generic DRL framework for TE. In their TE problem formulation, their solution consists of defining the optimal split ratios over a set of pre-defined paths instead of changing the paths configuration. In the field of optical networks, the work [37] proposes an elaborated representation of the network state to help a DRL agent learn to efficiently route traffic demands. A more recent work [38] proposes a different approach where the authors combine DRL and GNN to optimize the resource allocation in optical circuit-switched networks. NeuroCuts [39] is a DRL-based solution for solving the packet classification problem. AuTO [40] performs on-line Traffic Optimization using DRL in data center scenarios. In their work they train a DRL agent to change the queue's thresholds and another DRL agent to determine the priorities and rate limit for long flows. Decima [41] leverages DRL and GNN for efficient scheduling of data processing jobs in data clusters. RouteNet [42] proposes to use GNN for network modeling and optimization.

VII. CONCLUSION

Efficient real-time TE is important for network operators and ISPs to ensure network reliability when external factors can disrupt the proper network functioning. We present Enero, a method that combines DRL with LS to solve TE problems in real-time. The experimental results show that Enero is able to operate efficiently in real-world scenarios (e.g., dynamic traffic matrix, link failures). In addition, the results indicate that Enero can achieve close-to-optimal performance in less than 30 seconds for a set of arbitrary real-world network topologies. We expect our solution to inspire future work on applying DRL for solving network optimization problems.

ACKNOWLEDGMENT

This work has been supported by the Spanish Government through project TRAINER-A (PID2020-118011GB-C21) with FEDER contribution, the Catalan Institution for Research and Advanced Studies (ICREA) and the Secretariat for Universities and Research of the Ministry of Business and Knowledge of the Government of Catalonia and the European Social Fund.

REFERENCES

- [1] H. Waldman, "The impending optical network capacity crunch," in *2018 SBFoton International Optics and Photonics Conference (SBFoton IOPC)*. Campinas, Brazil: IEEE, 2018, pp. 1–4.
- [2] G. Wellbrock and T. J. Xia, "How will optical transport deal with future network traffic growth?" in *2014 The European Conference on Optical Communication (ECOC)*. Cannes, France: IEEE, 2014, pp. 1–3.
- [3] A. Ellis, N. M. Suibhne, D. Saad, and D. Payne, "Communication networks beyond the capacity crunch," 2016.
- [4] K. Kirkpatrick, "Software-defined networking," *Commun. ACM*, vol. 56, no. 9, p. 16–19, Sep. 2013. [Online]. Available: <https://doi.org/10.1145/2500468.2500473>
- [5] D. Xu, M. Chiang, and J. Rexford, "Link-state routing with hop-by-hop forwarding can achieve optimal traffic engineering," *IEEE/ACM Transactions on networking*, vol. 19, no. 6, pp. 1717–1730, 2011.

- [6] R. Hartert, S. Vissicchio, P. Schaus, O. Bonaventure, C. Filsfils, T. Telkamp, and P. Francois, "A declarative and expressive approach to control forwarding paths in carrier-grade networks," *SIGCOMM Comput. Commun. Rev.*, vol. 45, no. 4, p. 15–28, Aug. 2015. [Online]. Available: <https://doi.org/10.1145/2829988.2787495>
- [7] Gurobi Optimization, LLC, "Gurobi Optimizer Reference Manual," 2021. [Online]. Available: <https://www.gurobi.com>
- [8] I. I. Cplex, "V12. 1: User's manual for cplex," *International Business Machines Corporation*, vol. 46, no. 53, p. 157, 2009.
- [9] A. Mestres, A. Rodriguez-Natal, J. Carner, P. Barlet-Ros, E. Alarcón, M. Solé, V. Muntés-Mulero, D. Meyer, S. Barkai, M. J. Hibbett *et al.*, "Knowledge-defined networking," *ACM SIGCOMM Computer Communication Review*, vol. 47, no. 3, pp. 2–10, 2017.
- [10] Z. M. Fadlullah, F. Tang, B. Mao, N. Kato, O. Akashi, T. Inoue, and K. Mizutani, "State-of-the-art deep learning: Evolving machine intelligence toward tomorrow's intelligent network traffic control systems," *IEEE Communications Surveys & Tutorials*, vol. 19, no. 4, pp. 2432–2455, 2017.
- [11] D. Silver, J. Schrittwieser, K. Simonyan, I. Antonoglou, A. Huang, A. Guez, T. Hubert, L. Baker, M. Lai, A. Bolton *et al.*, "Mastering the game of go without human knowledge," *nature*, vol. 550, no. 7676, pp. 354–359, 2017.
- [12] T. P. Lillicrap, J. J. Hunt, A. Pritzel, N. Heess, T. Erez, Y. Tassa, D. Silver, and D. Wierstra, "Continuous control with deep reinforcement learning," 2019.
- [13] Q. Cappart, T. Moisan, L.-M. Rousseau, I. Prémont-Schwarz, and A. Cire, "Combining reinforcement learning and constraint programming for combinatorial optimization," 2020.
- [14] J. Zhang, M. Ye, Z. Guo, C.-Y. Yen, and H. J. Chao, "Cfr-rl: Traffic engineering with reinforcement learning in sdn," *IEEE Journal on Selected Areas in Communications*, vol. 38, no. 10, pp. 2249–2259, 2020.
- [15] F. Scarselli, M. Gori, A. C. Tsoi, M. Hagenbuchner, and G. Monfardini, "The graph neural network model," *IEEE transactions on neural networks*, vol. 20, no. 1, pp. 61–80, 2008.
- [16] C. Filsfils, N. K. Nainar, C. Pignataro, J. C. Cardona, and P. Francois, "The segment routing architecture," in *2015 IEEE Global Communications Conference (GLOBECOM)*. San Diego, CA, USA: IEEE, 2015, pp. 1–6.
- [17] R. Bhatia, F. Hao, M. Kodialam, and T. Lakshman, "Optimized network traffic engineering using segment routing," in *2015 IEEE Conference on Computer Communications (INFOCOM)*. Hong Kong, China: IEEE, 2015, pp. 657–665.
- [18] S. Knight, H. X. Nguyen, N. Falkner, R. Bowden, and M. Roughan, "The internet topology zoo," *IEEE Journal on Selected Areas in Communications*, vol. 29, no. 9, pp. 1765–1775, 2011.
- [19] F. Rossi, P. Van Beek, and T. Walsh, *Handbook of constraint programming*. Elsevier, 2006.
- [20] A. Schrijver, *Theory of linear and integer programming*. John Wiley & Sons, 1998.
- [21] T. Yang, J. Jiang, P. Liu, Q. Huang, J. Gong, Y. Zhou, R. Miao, X. Li, and S. Uhlig, "Elastic sketch: Adaptive and fast network-wide measurements," in *Proceedings of the 2018 Conference of the ACM Special Interest Group on Data Communication*, ser. SIGCOMM '18. New York, NY, USA: Association for Computing Machinery, 2018, p. 561–575. [Online]. Available: <https://doi.org/10.1145/3230543.3230544>
- [22] Z. Liu, R. Ben-Basat, G. Einziger, Y. Kassner, V. Braverman, R. Friedman, and V. Sekar, "Nitrosketch: Robust and general sketch-based monitoring in software switches," in *Proceedings of the ACM Special Interest Group on Data Communication*, ser. SIGCOMM '19. New York, NY, USA: Association for Computing Machinery, 2019, p. 334–350. [Online]. Available: <https://doi.org/10.1145/3341302.3342076>
- [23] Q. Huang, X. Jin, P. P. C. Lee, R. Li, L. Tang, Y.-C. Chen, and G. Zhang, "Sketchvisor: Robust network measurement for software packet processing," in *Proceedings of the Conference of the ACM Special Interest Group on Data Communication*, ser. SIGCOMM '17. New York, NY, USA: Association for Computing Machinery, 2017, p. 113–126. [Online]. Available: <https://doi.org/10.1145/3098822.3098831>
- [24] S. L. e. a. John Schulman, Philipp Moritz, "High-dimensional continuous control using generalized advantage estimation," 2018.
- [25] J. Schulman, F. Wolski, P. Dhariwal, A. Radford, and O. Klimov, "Proximal policy optimization algorithms," 2017.
- [26] Z. Ahmed, N. Le Roux, M. Norouzi, and D. Schuurmans, "Understanding the impact of entropy on policy optimization," in *Proceedings of the 36th International Conference on Machine Learning*, ser. Proceedings of Machine Learning Research, K. Chaudhuri and R. Salakhutdinov, Eds., vol. 97. Long Beach, California, USA: PMLR, 09–15 Jun 2019, pp. 151–160. [Online]. Available: <http://proceedings.mlr.press/v97/ahmed19a.html>
- [27] A. A. Martín Abadi, P. Barham, E. Brevdo, Z. Chen, C. Citro, G. S. Corrado, A. Davis, J. Dean, M. Devin, S. Ghemawat, I. Goodfellow, A. Harp, G. Irving, M. Isard, Y. Jia, R. Jozefowicz, L. Kaiser, M. Kudlur, J. Levenberg, D. Mané, R. Monga, S. Moore, D. Murray, C. Olah, M. Schuster, J. Shlens, B. Steiner, I. Sutskever, K. Talwar, P. Tucker, V. Vanhoucke, V. Vasudevan, F. Viégas, O. Vinyals, P. Warden, M. Wattenberg, M. Wicke, Y. Yu, and X. Zheng, "TensorFlow: Large-scale machine learning on heterogeneous systems," 2015, software available from tensorflow.org. [Online]. Available: <https://www.tensorflow.org/>
- [28] L. P. e. a. Greg Brockman, Vicki Cheung, "Openai gym," 2016.
- [29] C. R. Harris, K. J. Millman, S. J. van der Walt, R. Gommers, P. Virtanen, D. Cournapeau, E. Wieser, J. Taylor, S. Berg, N. J. Smith, R. Kern, M. Picus, S. Hoyer, M. H. van Kerkwijk, M. Brett, A. Haldane, J. F. del Río, M. Wiebe, P. Peterson, P. Gérard-Marchant, K. Sheppard, T. Reddy, W. Weckesser, H. Abbasi, C. Gohlke, and T. E. Oliphant, "Array programming with NumPy," *Nature*, vol. 585, no. 7825, pp. 357–362, Sep. 2020. [Online]. Available: <https://doi.org/10.1038/s41586-020-2649-2>
- [30] S. Behnel, R. Bradshaw, C. Citro, L. Dalcin, D. S. Seljebotn, and K. Smith, "Cython: The best of both worlds," *Computing in Science and Engng.*, vol. 13, no. 2, p. 31–39, Mar. 2011. [Online]. Available: <https://doi.org/10.1109/MCSE.2010.118>
- [31] D. A. S. Aric A. Hagberg and P. J. Swart, "Exploring network structure, dynamics, and function using networkx," in *Proceedings of the 7th Python in Science Conference*, G. Varoquaux, T. Vaught, and J. Millman, Eds., Pasadena, CA USA, 2008, pp. 11 – 15.
- [32] S. Gay, P. Schaus, and S. Vissicchio, "Repetita: Repeatable experiments for performance evaluation of traffic-engineering algorithms," 2017.
- [33] B. Fortz and M. Thorup, "Internet traffic engineering by optimizing ospf weights," in *Proceedings IEEE INFOCOM 2000. Conference on Computer Communications. Nineteenth Annual Joint Conference of the IEEE Computer and Communications Societies (Cat. No.00CH37064)*, vol. 2. Tel Aviv, Israel: IEEE, 2000, pp. 519–528 vol.2.
- [34] S. Gay, R. Hartert, and S. Vissicchio, "Expect the unexpected: Sub-second optimization for segment routing," in *IEEE Conference on Computer Communications (INFOCOM)*. Atlanta, GA, USA: IEEE, 2017, pp. 1–9.
- [35] M. Jadin, F. Aubry, P. Schaus, and O. Bonaventure, "Cg4sr: Near optimal traffic engineering for segment routing with column generation," in *IEEE INFOCOM 2019 - IEEE Conference on Computer Communications*. Paris, France: IEEE, 2019, pp. 1333–1341.
- [36] Z. Xu, J. Tang, J. Meng, W. Zhang, Y. Wang, C. H. Liu, and D. Yang, "Experience-driven networking: A deep reinforcement learning based approach," in *IEEE INFOCOM 2018 - IEEE Conference on Computer Communications*. Honolulu, HI, USA: IEEE, 2018, pp. 1871–1879.
- [37] J. Suarez-Varela, A. Mestres, J. Yu, L. Kuang, H. Feng, P. Barlet-Ros, and A. Cabellos-Aparicio, "Feature engineering for deep reinforcement learning based routing," in *ICC 2019 - 2019 IEEE International Conference on Communications (ICC)*. Shanghai, China: IEEE, 2019, pp. 1–6.
- [38] P. Almasan, J. Suárez-Varela, A. Badia-Sampera, K. Rusek, P. Barlet-Ros, and A. Cabellos-Aparicio, "Deep reinforcement learning meets graph neural networks: exploring a routing optimization use case," 2020.
- [39] E. Liang, H. Zhu, X. Jin, and I. Stoica, "Neural packet classification," in *Proceedings of the ACM Special Interest Group on Data Communication*, ser. SIGCOMM '19. New York, NY, USA: Association for Computing Machinery, 2019, p. 256–269. [Online]. Available: <https://doi.org/10.1145/3341302.3342221>
- [40] L. Chen, J. Lingys, K. Chen, and F. Liu, "Auto: Scaling deep reinforcement learning for datacenter-scale automatic traffic optimization," in *Proceedings of the 2018 Conference of the ACM Special Interest Group on Data Communication*, ser. SIGCOMM '18. New York, NY, USA: Association for Computing Machinery, 2018, p. 191–205. [Online]. Available: <https://doi.org/10.1145/3230543.3230551>
- [41] H. Mao, M. Schwarzkopf, S. B. Venkatakrisnan, Z. Meng, and M. Alizadeh, "Learning scheduling algorithms for data processing clusters," in *Proceedings of the ACM Special Interest Group on Data Communication*, ser. SIGCOMM '19. New York, NY, USA:

Association for Computing Machinery, 2019, p. 270–288. [Online]. Available: <https://doi.org/10.1145/3341302.3342080>

- [42] K. Rusek, J. Suárez-Varela, P. Almasan, P. Barlet-Ros, and A. Cabellos-Aparicio, “Routenet: Leveraging graph neural networks for network modeling and optimization in sdn,” *IEEE Journal on Selected Areas in Communications*, vol. 38, no. 10, pp. 2260–2270, 2020.