

# Signaling Design for Cooperative Resource Allocation and its Impact to Reliability

RASMUS LIBORIUS BRUUN<sup>1</sup>, C. SANTIAGO MOREJÓN GARCÍA<sup>1</sup>, TROELS B. SØRENSEN<sup>1</sup>,  
NUNO K. PRATAS<sup>2</sup>, TATIANA KOZLOVA MADSEN<sup>1</sup> AND PREBEN MOGENSEN<sup>1,2</sup>

<sup>1</sup>Wireless Communication Networks Section, Department of Electronic Systems, Aalborg University, Denmark

<sup>2</sup>Nokia Standardization, Aalborg, Denmark

Corresponding author: Rasmus L. Bruun (e-mail: rlb@es.aau.dk).

**ABSTRACT** Decentralized cooperative resource allocation schemes for robotic swarms are essential to enable high reliability in high throughput data exchanges. These cooperative schemes require control signaling with the aim to avoid half-duplex problems at the receiver and mitigate interference. We propose two cooperative resource allocation schemes, device sequential and group scheduling, and introduce a control signaling design. We observe that failure in the reception of these control signals leads to non-cooperative behavior and to significant performance degradation. The cause of these failures are identified and specific countermeasures are proposed and evaluated. We compare the proposed resource allocation schemes against the NR sidelink mode 2 resource allocation and show that despite signaling has an important impact on the resource allocation performance, our proposed device sequential and group scheduling resource allocation schemes improve reliability by an order of magnitude compared to sidelink mode 2.

**INDEX TERMS** cooperative communication, distributed resource allocation, signaling, swarm communication

## I. INTRODUCTION

The density of connected devices is growing rapidly. Nowadays it is insufficient to have connectivity only in smartphones. Wireless connectivity is expanding to wearables, domotics, automotives, etc., to make our lives simpler, safer and more convenient. As connectivity becomes omnipresent, the basis for a new form of collaboration has been created. Nature has inspired many technological leaps, and the collaboration of simple entities is a well known phenomenon in the animal kingdom, where ants, birds, bees, fish and a plethora of other species have learned to benefit from collaboration, allowing them to unite efforts and enable them to achieve complex tasks. The behavior of swarming, flocking and schooling serves as inspiration for the collaboration which has become possible between connected electronic devices. The first use cases have already been envisioned, e.g:

- In manufacturing, swarms are envisioned to enhance production lines, by enhanced flexibility and adaptability enabled by better communication [1].
- In search and rescue flocks, drones are envisioned to cover land quickly and with short response time, thus

vastly cutting the critical time to find lost persons in the debris of a collapsed building, people lost at sea, in a forest, etc. In such operations it is life critical to locate the missing persons as soon as possible [2].

- Within the agricultural industry, in [3] a monitoring and mapping system guides autonomous weeding robots. This system maps the field by using a swarm of UAVs to patrol it. The system provides weed's presence identification and location of different intervention urgency areas.
- In domotics (smart home and office) the collection of connected smart devices (each with a distinct sensing, actuating or service function) will collaborate like the bee swarm maintaining the hive, to efficiently monitor the state of the building and provide an optimal indoor environment while minimizing the energy bill cost [4], [5]. The robot vacuum will operate where needed, but at the most convenient times and the heating, ventilation, and air-conditioning (HVAC) will be adjusted ad-hoc to provide the perfect indoor climate at all times of day and year [5], [6].

- In automotive, connected devices will be vital to maintain a streamlined transportation infrastructure where the transportation needs of humans, and goods can be met in the safest and most seamless way possible. The sensors around the transportation grid will provide real-time traffic updates to the active vehicles which will negotiate their optimal routes as they drive in dense platoons not unlike ants and migrating birds [7], [8].

These are just to mention a few of the present use cases. Undoubtedly, the most revolutionary applications of swarm robotics have yet to be discovered as technologies mature and become accessible. Common for the aforementioned use cases and the nature of swarms is the need for communication between devices within proximity. In theory, direct one hop communication between devices has the shortest possible latency and best utilization of time-frequency resources. Also, it provides good conditions to obtain high reliability which we define as the probability that a receiver successfully decodes a received message within an application's latency requirement. However, achieving these benefits will require smarter solutions. For that reason our efforts are concentrated on decentralized communication where all devices engage in communication on equal terms and no coordination from network or one specific device is needed for communications to take place. Additionally we are concerned with pushing beyond the current state of the art, thus focus on how to improve throughput and reliability at reduced latency.

#### A. DECENTRALIZED WIRELESS COMMUNICATION

Different solutions exist for decentralized wireless communications, however to achieve adoption and wide spread usage, standardization is indispensable. Standardized wireless communication technologies enable different manufacturers to produce compatible products. This aids competition and will result in larger supply of products at lower cost. The most known standards are governed by IEEE, Bluetooth SIG and 3GPP.

Bluetooth SIG governs the Bluetooth standard which is a personal area network technology. Bluetooth Classic refers to the original Bluetooth protocol stack which was originally meant as a wireless alternative to a cabled connection, e.g. between headset and phone. In version 4.0 of the Bluetooth Core Specification, the Bluetooth Low Energy protocol stack was introduced. Bluetooth Low Energy is incompatible with Bluetooth Classic and designed for low power consumption. Both Bluetooth stacks operate in the unlicensed 2.4 GHz Industrial, Scientific and Medical (ISM) band. The Bluetooth Mesh specification [9] was adopted in 2017 to allow Bluetooth technology to cater applications which include multiple device networks.

The IEEE 802.15.4 standard is a low-data-rate, low cost and low power physical and MAC layer specification [10]. It was originally conceived to enable low cost personal area networks between ad-hoc devices, and operates in the ISM bands between 0.8 and 2.4 GHz. IEEE also governs the 802.11 standard, which is a specification of pro-

ocols for wireless local area networks. The amendments 802.11a/b/g/n/ac/ax refer to WiFi networks, which connect computers and smartphones to the internet via an access point. However, 802.11s, 802.11p and 802.11bd are amendments directed at device to device applications. The 802.11s amendment enables mesh networking in which packets are routed according to one of the supported protocols. Dedicated short-range communication is supported by the 802.11p and the upcoming 802.11bd amendments. The target of these amendments is to enable vehicular communication in the 5.9 GHz Intelligent Transport Systems (ITS) band.

The main challenge that Bluetooth SIG and IEEE governed standards have is their operation in the unlicensed spectrum bands where they need to abide by either listen before talk or duty cycle restrictions [11], [12]. For this reason, these standards are vulnerable to interference and low spectral efficiency which limits their achievable throughput and latency performance [13].

In the United States, the 3.5 GHz Citizen Broadband Radio Service (CBRS) band with a bandwidth of 150 MHz was established in 2015 to allow shared commercial usage in the band [14]. Up to 70 MHz is licensed by census tract (limited geographical region) allowing factories, airports and the like to license the band and utilize it for a dedicated network. This licensing arrangement is interesting for future use cases of e.g. cellular technologies which already operate in this band in other parts of the world.

3GPP standardizes cellular communication. The concept of device-to-device communications appeared within 3GPP release 12, with the development of proximity services (ProSe). The most recent version of the standard is release 16. Among other things, it includes decentralized device-to-device communications in the form of NR sidelink resource allocation mode 2 (mode 2). The mode 2 resource allocation is explained in detail in section II-A. The main performance constraints of mode 2 are caused by the presence of half-duplex problems and multi-user interference [15]. Half-duplex refers to the limitation a transceiver has, since it is not able to receive and transmit simultaneously. The problem arise when two communicating transceivers transmit to each other simultaneously rendering both unable to receive. To overcome these issues, inter-UE coordination is being discussed for the upcoming release 17 [16]. Here the concept of cooperation/coordination is adopted as an option to be added on top of mode 2 which should aid in mitigating half-duplex and interference problems. Two coordination schemes are agreed upon: Inter-UE coordination scheme 1 and scheme 2. In the former, upon request, the receiving UE-A assists the transmitting UE-B in resource allocation by indicating a set of preferred/non-preferred resources for the transmitting UE-B; the latter allows the receiving UE-A to notify the transmitter that the resource selected by the transmitter results in expected/potential and/or detected conflicts.

The inter-UE coordination framework being introduced in 3GPP Rel.17 does not target swarm use cases where a group of UEs have to exchange information. In other words, the

signaling is pair based and not efficient for use cases where a group of UEs requires coordination information.

The scope of this paper is to introduce and evaluate a cooperative inter-UE coordination scheme suitable for group coordination.

### B. COOPERATIVE COMMUNICATIONS

Consensus on the use of time-frequency resources is the basis of multi-user communications. In decentralized communication systems one way to achieve high throughput, high reliability and low latency is to reach consensus in the usage of time-frequency resources via cooperative resource allocation. Authors in [17] introduced two consensus communication protocols, the first a gossip-based (multi-hop message diffusion) and the second a broadcast (single-hop message diffusion) communication protocol. In both protocols, a set of UEs (validators) validates and commits the proposed action (vacant frequency band) made by the proposer UE. The consensus protocols have low latency and high reliability that could support mission-critical and real-time tasks as long as consensus decisions change infrequently. The validation process may take some time due to the number of validators, and conversely if this number reduces, reliability may suffer. Therefore, there is a need for a balance between reliability and latency. The main advantage of the consensus algorithm is its resilience to UEs with malicious intent.

In systems without "malicious UEs", the consensus procedure is no longer necessary since it is assumed that all nodes will follow the specified resource allocation procedure. Consequently, an optimal resource allocation scheme can be reached faster. Authors in [18] developed resource allocation algorithms inspired by a bio-swarmling behavior. The presented methods rely on multiple iterations before they converge to an optimal resource allocation. In [19] the authors present a distributed resource allocation scheme which converges in quadratic time. The convergence is dependent on the number of devices, because each device is involved in execution of the algorithm.

Although these distributed consensus and resource allocation schemes achieve full alignment of the swarm members and an optimal resource allocation, the involvement of the majority of the swarm members in the allocation process is detrimental to the latency as the swarm size grows. Instead, it is desired that changes to the resource allocation can be performed locally among one or several sub-sets of swarm members, such that overhead in the form of control signals is limited. Mode 2 operates like this (a more detailed explanation is provided in Section II-A), where control signals are embedded with the data transmissions and thus only reach nearby swarm members (illustrated by control signal method 1 in Fig. 1).

In recent literature, cooperative extensions to the existing NR mode 2 standard have been suggested in an effort to address shortcomings in the current version. The continuous collision problem of the semi-persistently scheduled (SPS) transmissions is tackled in [20] by allowing a third UE to

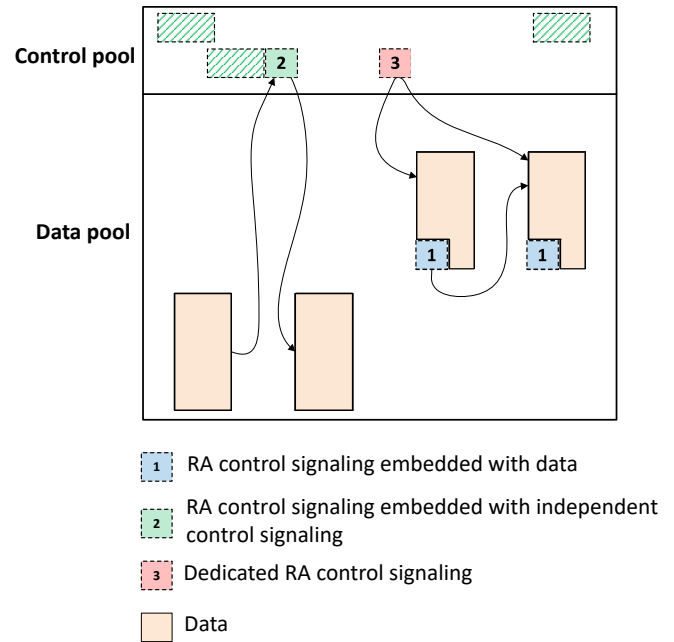

FIGURE 1: Methods to exchange signaling: i) Embedded with data (blue), ii) Embedded with independent signaling (green), and iii) Dedicated (red)

piggyback with its own transmission an indication that continuous collision is (likely) taking place in another resource (method 1 in Fig. 1). It is a reactive scheme where collisions are resolved rather than avoided. The scheme depends on other UEs being able to assist.

In [21] authors introduce a counter in the SPS signaling indicating the time of reselection, i.e. as method 1 in Fig. 1. Within each SPS transmission, a procedure is proposed to adjust the counters such that no UE will be reselecting in the same transmission time interval, thus mitigating SPS collisions. The procedure is proactive as it tries to mitigate future collisions, but the procedure is designed for low density swarms. Additionally, failures on the initial transmission are not handled.

The piggybacking of control signals to periodic safety messages in [22] indicates the future resource allocation of SPS transmissions (method 2 in Fig. 1). The next SPS allocation is performed before the end of the current SPS transmission, allowing time to reselect the SPS in case of potential conflicts.

With the aim of addressing the mode 2 limitations (i.e. susceptibility to half-duplex and interference), in [23] we introduced two cooperative resource allocation schemes, device sequential and group scheduling, which follow the framework of 3GPP but have different resource allocation algorithms and cooperation schemes. The coordination scheme of both the device sequential and group scheduling approach allow coordination where message exchange is only required for devices in proximity and with immediate need for communication resources. The additional signaling required

could partly be piggybacked to existing discovery messages (method 2 in Fig. 1) and by the introduction of a dedicated control signal (method 3 in Fig. 1). Under assumption of perfect exchange of control messages, the proposed schemes far outperformed mode 2 [23].

In this article we recapitulate the device sequential and group scheduling resource allocation schemes and additionally design the required signaling exchange to evaluate its impact on data reception reliability. We show how device sequential and group scheduling schemes provide significant performance improvement over the baseline despite introducing signaling overhead. Our evaluation focuses on the causes of data reception failures, thereby allowing a deeper analysis of the signaling design, its impact on the resource allocation, and the resulting data reception performance. Additionally, it provides us information to propose techniques to overcome such failures and evaluate their impact on the final data reception reliability. The specific contributions in this article are:

- Signaling design to enable distributed cooperation for the proposed device sequential and group scheduling cooperative resource allocation schemes.
- Evaluation of signaling overhead on the performance.
- A methodology of analysis for separating communication failures and identifying the most impacting causes, thereby deepening the understanding of performance differences and focal points for further enhancements.
- Techniques to enhance the signaling reliability and overall swarm application performance, based on the specific failure causes.

We continue with Section II presenting the assumptions, notation and the baseline mode 2 allocation scheme. In Section III we present the cooperative resource allocation schemes device sequential and group scheduling. Control signaling design for the cooperative schemes are presented in Section IV. Section V outlines the simulation setup and the simulation results and enhancement techniques are presented and evaluated in Section VI. Concluding remarks are made in Section VII.

## II. SYSTEM MODEL AND NOTATION

Consider a system of  $N$  UEs engaging in proximity communication, enabled by their omnidirectional antennas and half-duplex radios. At any point in time, a UE is either not involved in proximity communication, and therefore not transmitting data messages, or the UE is involved in proximity communication, defined by UEs being within (a device-centric) critical communication range of  $r_c$ . We differentiate between *data messages*, defined as the information bits transmitted for the purpose of some swarm application, and *control signals*, defined as the transmitted bits which serves a supporting function not directly related to the swarm application. The proximity communication consists of transmitting and receiving multi-casted data messages of size  $x_d$  bytes with a  $d_p$  seconds periodicity to and from all UEs within proximity; i.e., a UE will transmit data at a rate of  $t_d = x_d/d_p$

TABLE 1: Notation

Symbol	Meaning
$N$	Total number of autonomous robots
$W$	Bandwidth for data transmissions
$S$	Number of slots in the lifetime of the network
$r_e$	Extended cooperation range
$r_c$	Critical cooperation range
$n_s$	Number of slots requested by a UE for its transmission
$\mathcal{N}$	Set of UE IDs $\mathcal{N} = \{1, 2, \dots, N\}$
$\mathcal{S}$	Set of time slots $\mathcal{S} = \{1, 2, \dots, S\}$
$\mathcal{C}$	Set of indices of candidate slots for possible resource allocation $\mathcal{C} = \{1, 2, \dots, 40\}$ indicates the slots with indices 1 to 40
$\mathcal{R}$	Set of information about utilization of slots in $\mathcal{C}$
$\mathcal{R}_s$	Resource occupancy determined by sensing procedure
$\mathcal{R}_e$	Resource occupancy determined by exchange of control signals
$\mathcal{A}$	Slots allocated for requested transmission(s)
$s$	Indicates a unique slot in $\mathcal{S}$
$o$	Indication of the occupancy in a slot
$d_p$	Transmission periodicity
$x_d$	Size of data message in bytes
$t_d$	Data message data rate
$p_{tx}$	Transmission power
$T$	Thermal noise power
$g_{n,n'}^s$	Channel gain between UEs $n$ and $n'$ in slot $s$
$\gamma_{n,n'}^s$	SINR on transmission between UEs $n$ and $n'$ in slot $s$

bytes per second during proximity communication. The need to transmit data messages is determined based on proximity: the *ready time* is the moment in time when a data message is ready from application layer. A maximum latency of  $l$  seconds can be tolerated from the ready time until the message is delivered at all intended destinations. Combined, the ready time and latency budget defines the deadline of the data messages. The data message becomes useless after the deadline and will be discarded. Some control signals might be exchanged regardless of proximity.

We follow the 3GPP system framework [24] where communication is based on Orthogonal Frequency Division Multiplexing (OFDM) on a frequency band of bandwidth  $B$ . The frequency resource is shared between UEs by time division multiple access (TDMA). The smallest allocation unit is called a slot and has duration  $d_s$ , which is configurable based on the selected numerology. For simplicity we adhere to numerology 2, the highest numerology available for frequency range 1, which results in the shortest slot duration. We refer to time slots by their index  $s$  in the set  $\mathcal{S} = \{1, 2, \dots, S\}$ , which spans the lifetime of the network. For simplicity we assume UEs to have the same transmission requirements and be time synchronized, i.e. following the 5G NR procedure explained in [25]. In the following sections we use the notation in Table 1.

When a UE with id  $n \in \mathcal{N} = \{1, 2, \dots, N\}$  generates data in a slot  $s$ , this data is associated with a group of receivers  $\mathcal{N}' \subset \mathcal{N}$  where  $n' \in \mathcal{N}' : n \neq n', \text{dist}(n, n') < r_c$ . The function  $\text{dist}(n, n')$  returns the euclidean distance between UEs  $n$  and  $n'$ . For simplicity, we assume every transmission is subject to the same transmission power  $p_{tx}$ . The channel gain on transmission from  $n$  to  $n'$  in slot  $s$  is given as  $g_{n,n'}^s$  and the gain from interfering transmissions is given

as  $g_{k,n'} \{k : k \in \mathcal{K} \subset \mathcal{N}, k \neq n, k \neq n'\}$ . The channel gains are modeled as the combined effect of path loss and shadowing, where the shadowing component on different links is correlated.

When a slot is used for transmission, the SINR on a link between  $n$  and  $n'$  in slot  $s$  is calculated according to

$$\gamma_{n,n'}^s = \frac{p_{tx} g_{n,n'}^s}{T + \sum_{k \in \mathcal{K}} p_{tx} g_{k,n'}^s} \quad (1)$$

where  $T$  is the thermal noise power.

Based on the ready times and latency requirement, the 3-dimensional data transmission matrix can be obtained  $\mathbf{D}_{N \times N \times S} = [\delta_{n,n',s}]$

$$\delta_{n,n',s} = \begin{cases} s + \lfloor \frac{l}{d_s} \rfloor, & \text{if } n \text{ generates data in slot } s \text{ which} \\ & \text{should be transmitted to } n' \text{ within la-} \\ & \text{tency } l \\ 0, & \text{otherwise} \end{cases} \quad (2)$$

The problem is to determine an allocation, indicated by the allocation matrix  $\mathbf{A}_{N \times S} = [\alpha_{n,s}]$  where the maximum number of UEs can be supported in the swarm.

$$\alpha_{n,s} = \begin{cases} 1, & \text{if } n \text{ transmits in slot } s \\ 0, & \text{otherwise} \end{cases} \quad (3)$$

such that for each nonzero entry  $\delta_{n,n',s}$  in  $\mathbf{D}$ , the corresponding transmissions can be determined as the nonzero entries of  $\mathbf{A}$  in the corresponding row  $n$  and the columns in the interval  $[s; s + \lfloor \frac{l}{d_s} \rfloor]$ . We refer to this interval as the allocation interval, as it is the slot interval in which a UE can be allocated transmission resources for a given data packet. Let  $\Delta_{\delta_{n,n',s}} = \{\alpha_{n,r} : r \in S, s \leq r \leq s + l\}$  be the set of slots  $n$  utilize for the transmission of data  $\delta_{n,n',s}$  to  $n'$ . The combined SINR of the transmissions relating to the same data message is calculated as

$$\gamma_{\delta_{n,n',s}} = 2^{\frac{1}{K} \sum_{r \in \Delta_{\delta_{n,n',s}}} \log_2(1 + \gamma_{n,n'}^r)} - 1 \quad (4)$$

which is also known as the mean instantaneous capacity method used to determine an effective SINR mapping. Thus a set can be defined as  $\Gamma = \{\gamma_{\delta_{n,n',s}} : \delta_{n,n',s} \neq 0, n \in N, n' \in N', s \in S\}$  and the optimization problem is formulated as

$$\arg \max_{\mathbf{A}_{N \times S}} N \quad (5a)$$

$$\text{subject to} \quad \frac{1}{|\Gamma|} \sum_{\gamma_i \in \Gamma} \text{bler}(\gamma_i) < f_p, \quad (5b)$$

$$\sum_{i \in N'} \alpha_{i,s} \leq 1 \quad (5c)$$

where  $\text{bler}(x)$  is a mapping function which maps a certain SINR to a block error rate, following the physical layer abstraction given in [26]. The first constraint guarantees that the system failure probability does not exceed a required failure probability requirement,  $f_p$ . The second constraint ensures

that no two UEs within critical cooperation range transmit simultaneously, thereby avoiding half-duplex problems.

The problem of determining the allocation matrix  $\mathbf{A}$  (like the problem formulated in [27]) is NP-hard, thus no algorithm can be found to determine the optimal solution within polynomial time. Additionally, due to the potential overlap of allocation intervals of different UEs, in search of the optimal solution, the entire lifetime of the network should be considered. Therefore, it is not feasible to find an optimal solution to this problem, and instead we deal with heuristic methods to efficiently determine suboptimal solutions to the allocation problem in a decentralized manner. We note that these approaches limit the scope of each round of allocation such that only a subset of slots in  $S$  is considered. Furthermore, due to the decentralization of the system, the allocation decision can be delegated to each UE, which might have a limited knowledge about the allocation decisions of other UEs. We will see that knowledge of other UEs allocation decisions is important for the performance of the system, as it might help avoid half-duplex allocations and reduce interference. In the next section, the state of the art decentralized resource allocation algorithm of 5G NR is presented.

#### A. BASELINE RESOURCE ALLOCATION SCHEME (MODE 2)

On the sidelink, UEs can transmit directly to each other by performing 5G NR sidelink resource allocation mode 2. Mode 2 [28] relies on the signaling exchanged in the sidelink control information (SCI). The SCI is transmitted as part of a data message as depicted by control signal method 1 in Fig. 1. The SCI carries information which is necessary for decoding of the data transmission, but more importantly (in a resource allocation perspective) it indicates the periodicity of the transmission, i.e. the future resources reserved for this semi-persistently scheduled (SPS) transmission. SPS transmissions reduce the overhead of resource allocation by introducing predictability, which allow other UEs to avoid allocation of conflicting resources. In addition, the UEs can reuse the resource allocation of one data message of subsequent data messages. This is a key concept of mode 2 by which UEs autonomously allocate resources. For completeness, we summarize the two stages of mode 2 below.

##### 1) Sensing stage

Sensing is performed on a *sensing window* which spans the bandwidth configured for mode 2 transmissions and a time span no longer than 1 s leading up to the selection stage. The goal of the sensing is to determine a set of candidate resources. Initially a set of candidate resources of size  $M_{total}$  is defined. Resources are removed from the candidate set if a SCI received during the sensing window indicates that the candidate resource is reserved by another UE **and** the measured reference signal received power (RSRP) on the SCI is above a threshold. If the resulting candidate set is smaller than 20% of  $M_{total}$ , the threshold is increased by 3 dB and the discarded candidate resources are re-evaluated,

i.e. re-introduced to the candidate set if the RSRP is below the threshold.

## 2) Selection stage

In the selection stage the resource allocation algorithm is performed. It consists of selecting the requested resource(s) randomly among the candidate resources. If the resources are reoccurring with a given periodicity, the SPS re-selection counter is initialized [29]. At each transmission using the allocated resource, the counter is decremented. Once the counter reaches zero, re-selection is performed according to the mode 2 resource allocation.

The advantage of mode 2 is the autonomy of the procedure. It is only affected by the information it is able to obtain during the sensing window, and the delay introduced by determining the candidate slots is fixed. The disadvantage is that the simple coordination might cause two UEs with close ready times to allocate overlapping resources, resulting in half duplex problems. Additionally, the random nature of the allocation can cause sub-optimal performance.

Following, we introduce our cooperative resource allocation schemes. Both were built to comply with the 3GPP sidelink framework and its possible extensions. The sidelink framework is different from the framework of ISM-band technologies, where listen-before-talk and duty cycle restrictions are essential bounds on the resource allocation. Therefore, mode 2 acts as the baseline to which we compare our proposed allocation schemes.

## III. PROPOSED COOPERATIVE RESOURCE ALLOCATION SCHEMES

The cooperation scheme refers to the distribution of the resource allocation and related functions. It answers the question of who will perform the resource allocation, when, and based on what information. As in Fig. 1, we assume the bandwidth is divided into two adjacent frequency resource pools to accommodate control transmissions and data transmissions, respectively. The UEs are able to either transmit or receive in both resource pools simultaneously, but due to the half-duplex constraint, simultaneous reception and transmission is not possible. Section IV will explain what types of signals are transmitted in the control pool. The control pool signals are intended for UEs within extended communication range of  $r_e$  m.

Both proposed resource allocation schemes described here share the same basic resource allocation algorithm (Algorithm 1). We differentiate between the *allocating* UE which is the UE executing the resource allocation algorithm, and the *requesting* UE(s), which is the UE(s) requesting an allocation from the allocating UE. The allocating and requesting UE can be the same UE. The input is the tuple  $(n_s, \mathcal{R} = \{\mathcal{R}_s \cup \mathcal{R}_e\}, \mathcal{C})$  for each user  $k$  where  $n_s$  is the number of slots requested by the requesting UE. The set of candidate slots,  $\mathcal{C} \subset \mathcal{S}$  is every slot within the allocation interval of the requesting UE with respect to a data message.

---

### Algorithm 1 Resource allocation

---

**Input:**  $\{(n_s, \mathcal{R} = \{\mathcal{R}_s \cup \mathcal{R}_e\}, \mathcal{C})_k, k = 1, 2, \dots, K$

**Algorithm:**

- 1: **for** each  $k$  in descending order of number of UEs within *critical cooperation range* **do**
- 2:      $\mathcal{P} = \{(s, o)_i \in \mathcal{R}_k, o_i \neq \infty, s_i \in \mathcal{C}_k, i = 1 \dots |\mathcal{R}_k|\}$
- 3:     **for**  $n = 1, 2, \dots, n_{s,k}$  **do**
- 4:          $\arg \min_i o_i \in \mathcal{P}$
- 5:          $\mathcal{A}_k \leftarrow \mathcal{A}_k \cup s_i$
- 6:          $\mathcal{P} \leftarrow \mathcal{P} - (s, o)_i$
- 7:     **end for**
- 8: **end for**

**Output:**  $\{\mathcal{A}\}_k$

---

The predictability of SPS transmissions will be utilized in the proposed schemes. A benefit of SPS transmission is that one resource allocation can be valid for multiple data message transmissions. Allocation of a SPS transmission is triggered at the *trigger time*. The trigger time happens when the number of UEs within proximity is incremented to one (no longer zero) or after the resource re-selection counter expires. The resource re-selection counter is defined in [30] and decrements at each data transmission. The resource pool occupancy is given in the set  $\{\mathcal{R}_s \cup \mathcal{R}_e\} = \{(s, o) | s \in \mathcal{S} \text{ and } o \in \mathbb{R}\}$  where  $o_i$  is an indication of the occupancy defined as the strongest signal previously received from any of the UEs expected to transmit in slot  $s_i$ . If a slot  $s_i$  is occupied by a UE within critical cooperation range of the requesting UE, the corresponding  $o_i$  is set equal to infinity to avoid the half-duplex problem.  $\mathcal{R}_e$  is provided by the allocating UE and  $n_s, \mathcal{R}_s$  and  $\mathcal{S}$  are provided by the requesting UE.  $\mathcal{R}_s$  indicates the current resource utilization as observed by the requesting UE whereas  $\mathcal{R}_e$  indicates the resource utilization obtained (through control signaling) by the allocating UE. If  $K$  UEs are requesting an allocation from the same allocating UE simultaneously, their inputs will be ordered according to their priority, with  $k = 1$  indicating the highest priority UE and  $k = K$  the lowest priority UE.

Based on the resource occupancy from the requesting UE(s) and the received control signals, the resource allocation algorithm (Algorithm. 1) allocates the resources for UE $_k$  to avoid half-duplex problems and ensure the lowest interference from other UEs. If multiple requesting UEs are being assigned a resource allocation, the requesting UE with most potential half-duplex conflicts (most UEs in critical cooperation range) has resources allocated first. This greedy selection scheme is also known from greedy graph coloring algorithms. For each requesting UE, a set  $\mathcal{P}$  of potential resources is initialized based on the resource pool occupancy observed by UE  $k$ . Resources are allocated based on the lowest occupancy in lines 4 and 5 of Algorithm 1. In case multiple slots have identical minimum occupation in line 4, one will be randomly selected. A slot is allocated for UE  $k$  in line 5 and the corresponding entry is removed from set  $\mathcal{P}$

in line 6. As a result, the output of the resource allocation algorithm is the set of allocated resources,  $\mathcal{A}_k \subseteq \mathcal{C}_k$ , for each of the requesting UEs.

### A. DEVICE SEQUENTIAL RESOURCE ALLOCATION SCHEME

This scheme consists of coordinated resource selection by following a sequence in which UEs independently perform resource allocation in prioritized order. In our design, the UE priority is based on their trigger time and a unique ID. The UE with earliest trigger time has highest priority, and in case multiple UEs have identical trigger time, the unique UE ID determines the sequence such that lower ID has higher priority.

In Fig. 2 (a) the red boxes indicate the point in time when the trigger time is announced (in a discovery message discussed in Section IV-A). UEs 1, 4, 25, 2 and 3 have the same trigger time as indicated by the arrow pointing to the time slot for resource allocation. Due to the trigger time collision between the 5 UEs, they follow the prioritized order, which cause UEs 2, 3, 4 and 25 to perform resource allocation after their indicated trigger times (respectively a delay of 1, 2, 3 and 4 time slots). The coordination scheme for device sequential resource allocation follows the flow presented in Fig. 3. A UE continuously monitor the trigger time and position of other UEs within the extended cooperation range  $r_c$ . Once the UE requires resources, it initiates the resource allocation scheme. After determining the number of resources necessary for the transmission, the UE-Awaits the resource selection from higher priority UEs within  $r_c$  and continues when either resource selection has been received from all higher priority UEs or the *resource selection delay* expires (further discussed in section IV). The resource selection delay is a configurable parameter. Then, the UE executes the resource allocation algorithm, providing itself with a resource allocation. The allocated resources is signaled by broadcast intended for every other UE within  $r_c$ .

The advantage of the device sequential scheme is the autonomy with which each UE is performing its own resource allocation while simultaneously coordinating with UEs in extended cooperation range. Additionally, the prioritization scheme, while important for the coordination, is also a way of providing differentiated service to the swarm member UEs. The potential drawback of the scheme is the additional resource allocation delay which might be incurred if the trigger time of multiple UEs within extended coordination range overlap, and the control overhead from the signals which indicate trigger time and selected resources between UEs.

### B. GROUP SCHEDULING RESOURCE ALLOCATION SCHEME

As implied by the naming, the group scheduling resource allocation scheme rely on local groups in which a group leader is executing the resource allocation algorithm and supplying the group members with resource allocation. Coordination

happens within the group, but also between groups. For the latter, group leaders are either within extended cooperation range of, or have group members which collaborate with UEs in, another group. The group leader coordination is similar to the sequential scheme, where the prioritized order of allocation is determined by firstly group member trigger time (earlier trigger time is higher priority) and secondly the group leader unique ID (lower ID is higher priority). In Fig. 2 (b) UEs 1 and 3 have been elected as leaders with IDs  $L_1$  and  $L_3$ , respectively. Both leaders have group members with the same trigger time (UEs 1 and 25 for  $L_1$  and UEs 2, 3 and 4 for  $L_3$ ).  $L_1$  has highest priority, thus performs resource allocation for its group members before  $L_3$ . The flow of the group scheduling resource allocation scheme is presented in Fig. 4.

A UE continuously maintain membership of a group. It does so by periodically performing leader selection and broadcasting the choice of group leader. The candidate leaders are all UEs within  $r_c$ . Out of the candidate leaders, the leader is chosen as the candidate with most UEs within  $r_c$ . The unique UE ID will resolve any such that the candidate leader with the lowest ID UE will selected as the leader. Thereby, the group leaders are bound to be involved in swarm communication. Ahead of the trigger time, a UE informs its leader of its trigger time, the number of requested resources, the sensed resource occupation and the candidate slots. At the trigger time the leader executes the resource allocation algorithm after receiving any potential resource selection from higher priority leaders within  $r_c$ , or at latest when the resource selection delay has expired. The output from the resource allocation is signaled to the requesting UE and any lower priority leaders within  $r_c$ . Due to the range controlled leader selection procedure, the leaders of two collaborating UEs might be outside extended coordination range, potentially not being able to directly communicate. We refer to this as the *edge case*. In edge cases, the collaborating UEs need to forward the resource allocation received from their leader to allow the leaders to coordinate the resource allocation. Such forwarding is performed by UE 5 and 7 in Fig. 2.

The advantage of the group scheduling scheme is that leaders are able to perform resource allocation for multiple UEs simultaneously and combining their allocation in a single control message, thereby reducing the amount of messages used for control signaling. Additionally, the group leader has more information for resource occupation as each group member and the group leader itself collects resource occupation information. The disadvantages relate to the additionally required control signals. The resource allocation must be signaled between leader and requesting UE. Failure to receive this signal will cause the requesting UE to be without a resource allocation. The requesting UE must provide information to the leader which incurs additional signaling overhead. Lastly, the edge case where coordinating leaders are out of direct communication range will cause a coordination delay and additional overhead.

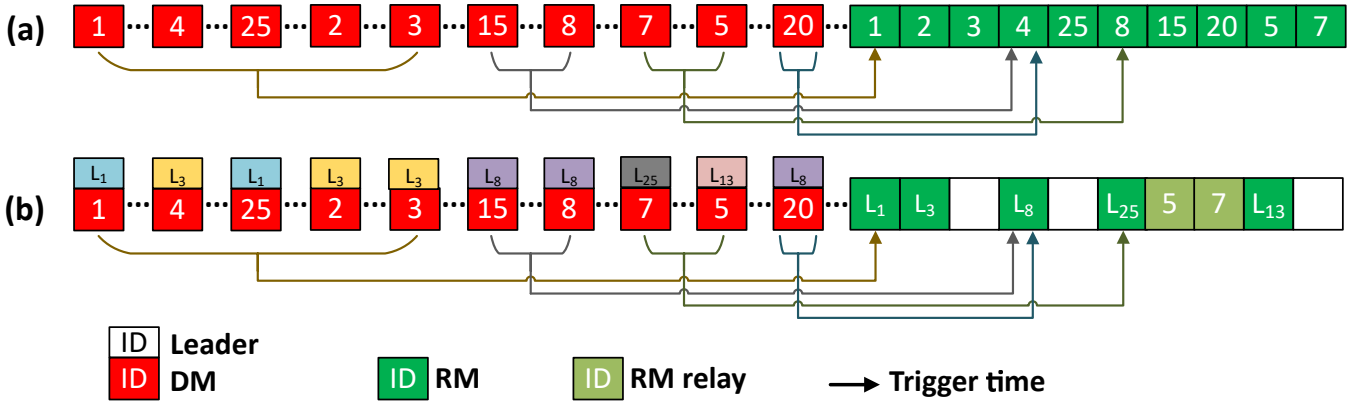

FIGURE 2: Relation between discovery messages (DMs) illustrated by red boxes and resource selection messages (RMs) illustrated by green boxes for (a) device sequential and (b) group scheduling schemes. ID is UE identification.

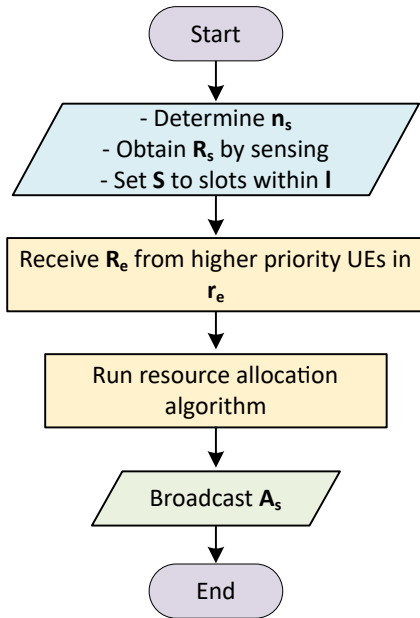

FIGURE 3: Device sequential coordination scheme for  $UE_i$

#### IV. CONTROL SIGNALING FOR COOPERATIVE SCHEMES

The decentralized cooperative resource allocation schemes require additional control signaling exchanges compared to mode 2. In this section we establish the control messages which will carry the control signals. For the cooperative schemes we utilize all three methods in Fig. 1 (RA control signaling embedded with data, embedded with independent control signaling and dedicated) for exchanging control signals. A summary of the control signals and their control information for each resource allocation scheme is presented in Table 2. The data message is identical for all schemes and simply include an indication of the periodicity of the message, making any receiver able to determine future resource reservation. The next subsections will elaborate on the discovery and resource selection message types.

##### A. DISCOVERY MESSAGE (DM)

The objective of DMs is for UEs to become aware of each others ID, position and heading direction. It is transmitted periodically with no exceptions. The DM is necessary regardless whether the resource allocation scheme is cooperative or non-cooperative, e.g. mode 2. Each DM is scheduled randomly within the discovery period.

For the device sequential and the group scheduling schemes the DMs are extended with information about the **trigger time**, when this is known by the UE. The UE can determine the trigger time either by estimating when another UE will be within  $r_c$  or when the re-selection counter reaches zero. We assume that the trigger time can be estimated far in advance and that the minimum value of the reselection counter is 750 ms as specified in [29]. A 100 ms discovery period would lead to each UE having at least 7 DM transmissions which results in sufficient discovery probability.

In the group scheduling scheme, the DM is extended with additional information. The leader selection is included in each discovery message such that leaders and collaborating UEs remain updated about the existing groups. When the trigger time approaches, the requesting UE will include the sensing result in its DM for the leader to use during resource allocation. Additionally, if UE-A identifies that its leader,  $L_A$ , and the leader,  $L_B$ , of a collaborating UE-B are out of direct communication range, UE-A will indicate in the DM the ID of  $L_B$  and the trigger time of UE-B. This allows  $L_A$  to determine the priority between the leaders and follow the coordination procedure. The size of DMs are enlarged by up to tenths of bytes due to the extensions needed by the cooperative schemes.

##### B. RESOURCE SELECTION MESSAGE (RM)

This control signal is exclusive to the cooperative resource allocation schemes. Its function is to carry information about the allocated resources for future data transmissions. Hence there is a direct connection between RM transmission and the trigger time indicated in the DMs. Compared to the non-cooperative scheme, the RM represents an additional



TABLE 2: Message content necessary for the three resource allocation schemes

	Mode 2	Device sequential	Group scheduling
<b>Discovery message (DM) content</b>	<ul style="list-style-type: none"> <li>• UE ID</li> <li>• Position &amp; heading</li> </ul>	<ul style="list-style-type: none"> <li>• UE ID</li> <li>• Position &amp; heading</li> <li>• Trigger time</li> </ul>	<ul style="list-style-type: none"> <li>• UE ID</li> <li>• Position &amp; heading</li> <li>• Trigger time(s)</li> <li>• Leader selection</li> <li>• Sensed resource occupation (<math>R_s</math>)</li> <li>• Special forward indication</li> </ul>
<b>Resource selection message (RM) content</b>	-	<ul style="list-style-type: none"> <li>• Resources allocated by UE (<math>A</math>)</li> </ul>	<ul style="list-style-type: none"> <li>• Resources allocated to group members (<math>A</math>)</li> </ul>
<b>Data message</b>	<ul style="list-style-type: none"> <li>• Message periodicity</li> <li>• Application data</li> </ul>	<ul style="list-style-type: none"> <li>• Message periodicity</li> <li>• Application data</li> </ul>	<ul style="list-style-type: none"> <li>• Message periodicity</li> <li>• Application data</li> </ul>

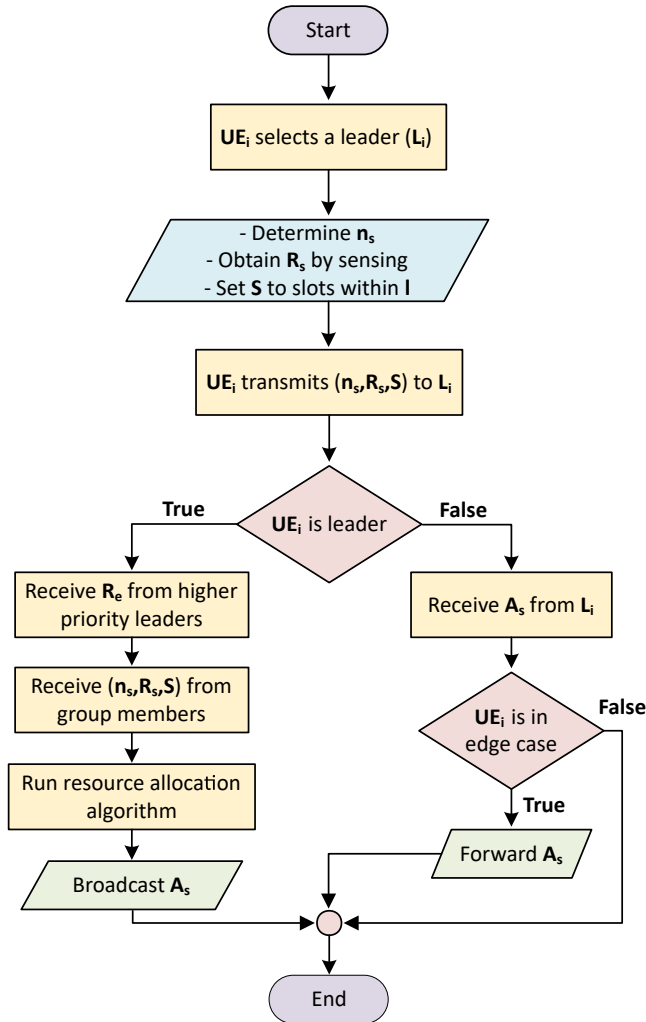
FIGURE 4: Group scheduling coordination scheme for  $UE_i$ 

overhead. However, it is transmitted only once per SPS period. Fig. 5 presents the RM transmission sequence diagram for each of the cooperative resource allocation schemes. The particularities of RMs for device sequential and group scheduling schemes are the following.

#### 1) Device sequential

At the trigger time a UE allocates resources and transmit its RM unless one of the two following conditions are true:

- 1) there are UEs with higher priority (lower unique ID) within  $r_e$  with the same trigger time (e.g. UE 3 waits for UE 2's RM in Fig. 5 (a)), or
- 2) there are UEs within  $r_e$ , with earlier trigger time, which are pending to perform resource allocation (e.g., UE 8 is waiting for UE 25's RM in Fig. 2 (a)).

Therefore, upon reception of RMs from higher priority UEs or when the predefined resource selection delay has expired, the UE will proceed to send its RM. Even though the delay to perform resource allocation scales linearly with the number of higher priority UEs in the sequence, it is bound by the resource selection delay. Resource allocation commences once the resource selection delay expires (e.g., resource selection delay expires for UE 4 and it performs its resource allocation as illustrated in Fig. 5 (a)).

#### 2) Group scheduling

RMs are transmitted from the group leaders to their respective group members at the trigger time. If two or more leaders within  $r_e$  have inferiors with the same trigger time (e.g. the leader, UE 3, waits for higher priority leaders resource allocation in Fig. 5 (b)), they must follow the sequential procedure explained in Section IV-B1. In cases where multiple group members have been given resources simultaneously (e.g. UEs 2, 3, and 4 in Fig. 5 (b)), the group leader combines the selected resources in one RM. This is beneficial in dense scenarios since it reduces the load of control signals in the control resource pool in comparison to the device sequential scheme. For the special forwarding procedure (edge case), group member UEs should forward the RMs (e.g. UEs 5 and 7 in Fig. 2 (b)) between leaders to enable leader-cooperation and hence, avoid half-duplex problems when allocating resources within their respective groups. The delay to perform resource allocation in the group scheduling scheme scales with the number of leaders within  $r_e$  of each other. In addition, the special forwarding procedure introduces the delay of up to two additional transmission times. However, initiation of the resource allocation is bounded by the configurable resource selection delay.

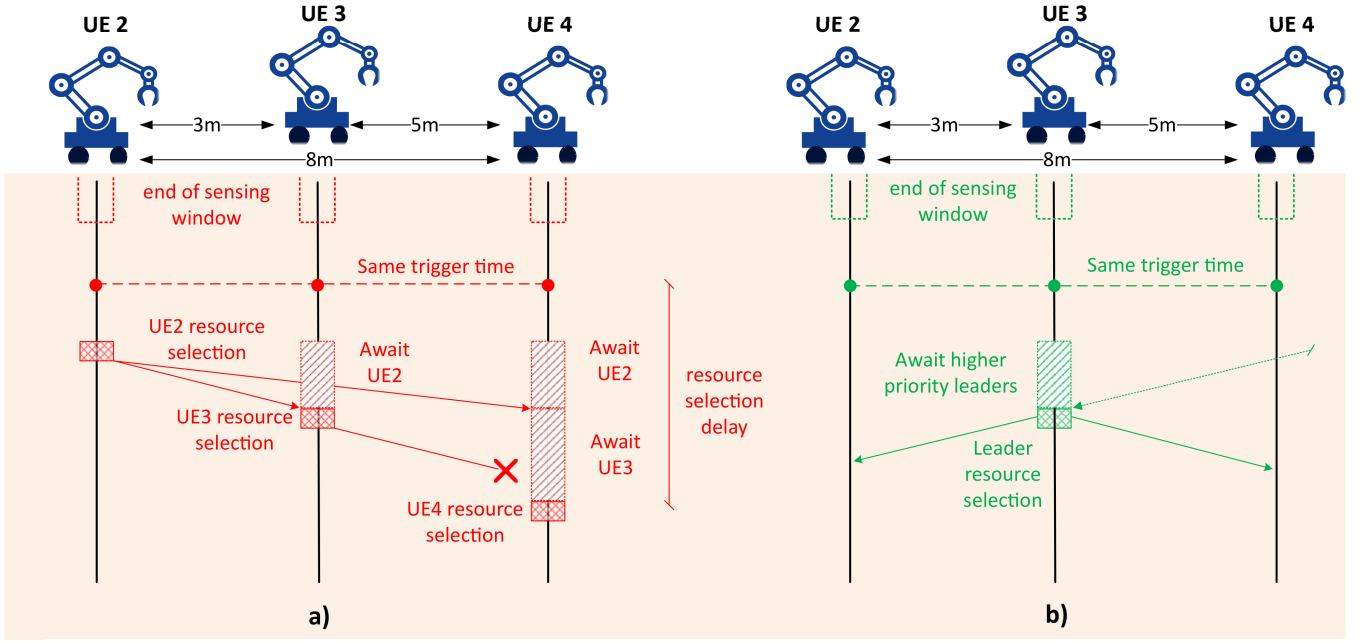

FIGURE 5: Control signaling exchange for (a) device sequential and (b) group scheduling

## V. SYSTEM LEVEL EVALUATION

We consider an application for collective environment perception, in which robots within a proximity of  $r_c = 5$  m must establish real-time high-throughput communication at high reliability for cooperative behavior, e.g. collision avoidance among robots and with external objects. This scenario is not unlike collective perception and cooperative collision avoidance use cases from vehicle to anything (V2X) envisioned by 3GPP in [31]. Specific requirements for this scenario are a 10 Mbps throughput where message latency does not exceed 10 ms at a reliability of 99.99 % [31].

The robots are driving in a rectangular indoor factory building. Each robot moves according to the random waypoint mobility model in which the robot moves at fixed speed between random points within the factory. The 3GPP non-line of sight indoor factory with sparse clutter and low base station (InF-SL) pathloss model from [32] is used for modeling the pathloss on links. UE antennas are omnidirectional. As multiple links are in use, we impose correlation on the shadowing component. The shadowing is computed according to the method in [33] where integration over a Gaussian random field enforces a 20 m de-correlation distance and 5.7 dB standard deviation. Fast fading is not explicitly modeled, but included in the link layer model.

Regarding 5G NR parameters we select numerology 2, dictating a  $d_s = 0.25$  ms slot duration. The data channel bandwidth is 100 MHz whereas the control data is carried on the smallest configurable sidelink sub-channel of twelve sub-carriers resulting in a 7.2 MHz bandwidth. The lowest modulation and coding scheme (MCS) for sidelink has modulation order 2 and coderate  $\frac{120}{1024}$ , leaving at most 196 bits for the control messages. The MCS for the data transmission

is dynamically adapted at the time of allocation. For each robot within  $r_c$ , the signal to interference and noise ratio (SINR) is measured on the most recent transmission. The worst SINR is used to determine the modulation and coding scheme from [34, Table 5.1.3.1-2] which can attain a 0.01 % target block error rate (BLER). The link level, hence the mapping from SINR to BLER, is modelled using a set of BLER curves generated from separate link level simulations [26]. The link level simulation includes all physical layer processing according to 5G NR. The required number of slots  $n_s$  are calculated based on the selected MCS, assuming that the transport block is bit padded to an integer number of slots. We do not differentiate between data and control signal transmission in the link level modeling which makes the control link performance slightly optimistic due to the much lower transmission bandwidth, i.e. 100MHz compared to 7.2MHz. Simulations parameters are listed in Table 3.

### A. KEY PERFORMANCE INDICATORS

The main key performance indicator is reliability - the probability that a data message is received within the latency constraint. We measure it in the form of failure probability. The target 99.99% reliability corresponds to a  $10^{-4}$  failure probability. As a complementary key performance indicator we capture the packet inter-reception (PIR) metric defined by 3GPP in [35]. It indicates the time in between successive packet receptions and is important for applications where regular updates are required. Multiple reasons might cause a reception failure, e.g. half-duplex errors arise when a UE is transmitting and therefore not able to receive a data transmission. We differentiate between whether a UE is transmitting a data message (half-duplex data), a discovery message (half-

TABLE 3: Simulation parameters

Parameter	Value/range
Carrier frequency, $f_c$	3.5 GHz
Swarm size (number of UEs)	[10, 20, 30, 40, 50, 60, 70]
Critical cooperation range, $r_c$	5 m
Extended Cooperation range, $r_e$	25 m
Facility dimensions	$120 \times 50 \text{ m}^2$ [32]
Transmission power, $P_{TX}$	0 dBm
Data channel bandwidth	100 MHz
Control channel bandwidth	7.2 MHz
Resource selection delay	1.25 ms
NR slot duration	250 $\mu\text{s}$
Thermal noise power spectral density	-174 dBm/Hz
Receiver noise figure	9 dB
Interference	Independent intra-system
UE speed	1 m/s
Mobility model	Random waypoint (RWP)
Pathloss model	InF-SL [32]
Propagation condition	Non line of sight
De-correlation distance $\delta$	20 m [33]
Discovery message periodicity	100 ms
Data message periodicity, $d_p$	10 ms
Data message size, $x_d$	100 kb
Data message latency requirement, $l$	10 ms
Simulation time	1000 s

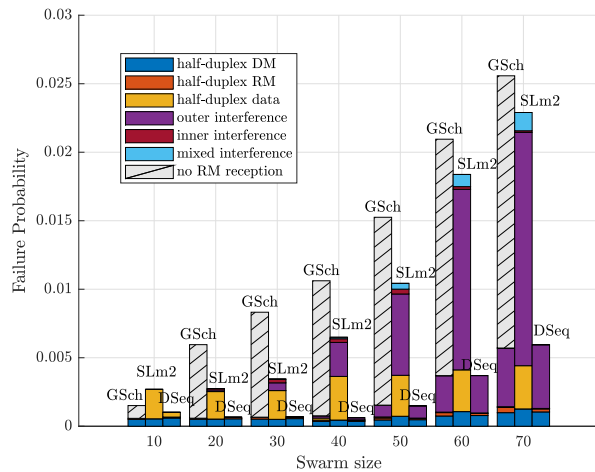

FIGURE 6: Failure probability and the causes of data transmission failures (half-duplex of DM, RM and data, inner, outer and mixed interference, and no RM reception) for three resource allocation schemes (SLm2, DSeq and GSch)

duplex DM), or a resource selection message (half-duplex RM).

Interference is another source of data reception failure. We differentiate between interference caused by UEs within  $r_c$ , denoted *inner* interference, and interference by UEs outside  $r_c$ , denoted *outer* interference. When UEs within and outside  $r_c$  simultaneously cause interference we denote it as *mixed* interference.

Lastly, when a group member has not received the resource selection message from its leader (no RM reception), it cannot perform a data transmission which will cause data reception failures at the receivers.

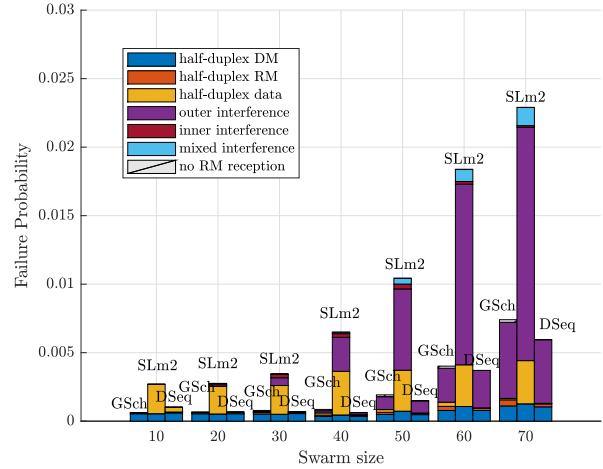

FIGURE 7: Failure probability and the causes of data transmission failures for three resource allocation schemes after enabling RM re-transmissions

## VI. SIMULATION RESULTS

The control signaling exchange has a direct impact on the data exchange performance. It is fundamental to fulfill two conditions. First, the random selection of DM transmission must not coincide with the reception of data transmissions since it will cause half-duplex problems (half-duplex DMs). Second, RMs failure probability should be sufficiently low such that it does not inhibit the performance of the cooperative schemes.

### A. RELIABILITY ANALYSIS AND ENHANCEMENT TECHNIQUES

In Fig. 6 we present the failure probability and the causes at various swarm sizes for the three resource allocation schemes group scheduling (GSch), mode 2 (SLm2) and device sequential (DSeq).

Failure to receive RMs in the cooperative resource allocation schemes can result in non-cooperative resource allocation. In the group scheduling scheme, a group member UE is dependent on receiving the RM from its leader. Failure of this RM reception will result in failure to transmit data for the entire SPS data transmission period (grey hatched bars in Fig. 6). To address this problem the *RM re-transmission* technique was incorporated. It enables the group member to send a non-acknowledgment (NACK) to its leader indicating that re-transmission of the RM is necessary. It might take several NACKs for successful reception of RM. Fig. 7 illustrates how failures caused by no RM receptions diminishes.

The second largest failure cause (at small swarm sizes) is half-duplex failures caused by transmission of discovery messages (blue bars in Fig. 6). The random transmission of DMs has a significant impact on total failure probability of the cooperative resource allocation schemes. Mode 2 is similarly affected by the half-duplex DM. To counteract this problem we propose the *non-overlapping* technique. It

utilizes the information about the current SPS transmissions acquired by UEs during the sensing procedure. The SPS transmission slots acquired by other UEs are not considered as possible options for the transmission of DMs to reduce potential half-duplex problems. Fig. 8 depicts the near disappearance of half-duplex DM failures.

Additionally, a few half-duplex problems occur in receiving data due to simultaneous data transmission (yellow bars for Gsch in Fig. 6) even at small sizes. This indicates that leaders were not cooperating. In the 40 UE swarm size, the device sequential scheme also experiences half-duplex failures to receive data due to simultaneous data transmissions (half-duplex data). This is an indication that some UEs failed to follow the sequential procedure. These described issues lead to the application of the *piggybacking* technique for the respective resource allocation schemes. Piggybacking builds on repeating the resource selection information by appending it to other RMs. It is done as follows in the two cooperative schemes:

- *Device sequential*: When a UE receives RMs from its predecessors, it includes this information in its respective RM, so that if UEs that follow the sequence did not receive previous RMs, they can recover them.
- *Group scheduling*: When the group leader sends an RM to a group member UE, it includes the information of prior transmitted RMs. It allows group member UEs an additional chance to receive its resource allocation when the leader schedules other inferiors

Fig. 9 illustrates that the effect of the piggybacking is negligible. This is a sign that the allocation sequences are not long enough even at swarm sizes of 70 UEs for the piggybacking technique to have an effect.

At large swarm sizes, outer interference becomes the main cause of failure. We plan to address it in our future work.

Even without the improvement techniques enabled, the device sequential RA scheme outperforms mode 2. At small swarm sizes the main difference lies in mode 2 having a considerable number of half-duplex data failures. The half-duplex failures caused by transmission of RMs in the cooperative schemes constitute a minor performance impact. As swarm size increases, interference becomes a dominant failure cause. The lack of cooperation and the resource selection procedure of mode 2 (described in II-A2) result in UEs experiencing data reception failures caused by high interference coming from UEs outside cooperation range (outer interference), UEs inside cooperation range (inner interference), or both (mixed interference).

### B. RELIABILITY PERFORMANCE WITH ENHANCEMENTS

Fig. 10 shows the failure probability for different swarm sizes in simulations with the following configurations:

- 1) **Error-free signaling** in which every control message is received at every intended receiver.
- 2) **Error-prone signaling** according to the prevailing signal conditions.

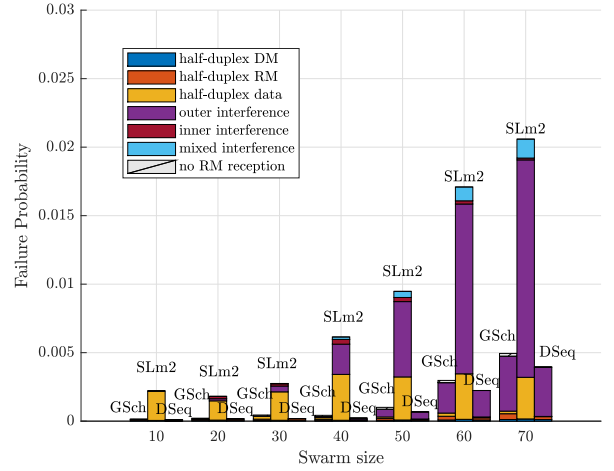

FIGURE 8: Failure probability and the causes of data transmission failures for three resource allocation schemes after enabling RM re-transmissions and non-overlapping techniques

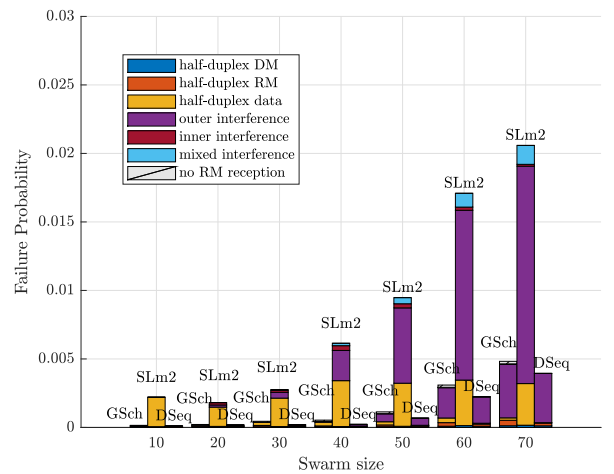

FIGURE 9: Failure probability and the causes of data transmission failures for three resource allocation schemes after enabling RM re-transmissions, non-overlapping and piggybacking techniques

- 3) **Signaling plus the RM re-transmission technique** in which in addition to 2) the RM re-transmission technique is utilized in the group scheduling scheme to mitigate data failures caused by failure to receive RMs.
- 4) **Signaling plus the RM re-transmission and the non-overlapping technique** in which in addition to 3) the non-overlapping technique is utilized to schedule DMs in time slots where no incoming data transmissions are expected.
- 5) **Signaling plus the non-overlapping and piggybacking techniques** in which in addition to 4), the piggybacking techniques are enabled for the cooperative RA

schemes.

Mode 2 (blue lines in Fig. 10) reaches failure probability below  $10^{-2}$  until swarm size of 50. The failure probability of mode 2 is barely affected by the simulation configuration. The highest failure probability is observed in the error prone signaling configuration, where in addition to half-duplex data and interference, errors were caused by half-duplex DM. Enabling the non-overlapping technique brings the error probability of mode 2 down to the level of error free control signaling.

Device sequential resource allocation is affected by the enhancement techniques. With error prone signaling the failure probability below  $10^{-3}$  can be maintained until swarm size of 40. Enabling the non-overlapping technique further reduces the failure probability and allow it to maintain failure probability below  $10^{-3}$  until 50 UE swarm sizes. The piggybacking technique has no impact. The device sequential scheme is able to meet the  $10^{-4}$  failure probability target at 10 UE swarm size when all enhancement techniques are enabled. With error-free signaling, the device sequential scheme experiences no failures at swam sizes smaller than 40 UEs.

Group scheduling with error prone signaling has the highest failure probability of all schemes and configurations due to the impact on non-received RMs. However, enabling RM re-transmissions reduces the failure probability by an order of magnitude and makes the performance comparable to the device sequential scheme in the error prone signaling configuration. Enabling non-overlapping further reduces the failure probability of the group scheduling scheme maintaining the failure probability below  $10^{-3}$  until swarm size of 50. With all features enabled the failure probability of group scheduling is still slightly higher than that of device sequential. With error free signaling, the group scheduling performance is as good as device sequential.

### C. PACKET INTER RECEPTION (PIR)

Fig. 11 (a) and (b) show the complementary cdf of the PIR for respectively 20 and 70 UE swarm size simulations. At both loads a PIR less than or equal to 10 ms is most frequent. This is expected, as the SPS period is exactly 10 ms, thus successive successful receptions of data messages in the same series of SPS transmissions will result in a 10 ms PIR. A PIR lower than 10 ms can occur as a result of re-selection of SPS transmission, and the same goes for PIR between 10 and 20 ms. However, PIRs longer than 20 ms are caused by reception failures. The configuration with the highest failure probability also experience the longest PIR, regardless of allocation scheme. At 20 UE swarm size, the PIRs exceed 20 ms with a probability less than  $10^{-3}$ . Only mode 2 and the group scheduling configuration with error prone signaling experience 30 ms, corresponding to 2 successive reception failures. At 70 UE swarm size all configurations experience PIRs greater than hundreds of milliseconds. The cooperative schemes perform similar in configurations with

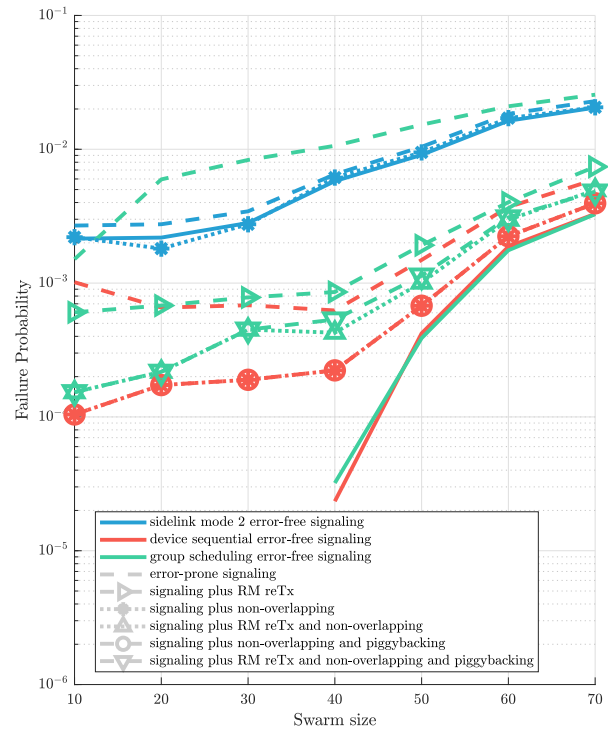

FIGURE 10: Failure probability for the resource allocation schemes at the five simulation configurations: error-free signaling, error-prone signaling, error-prone signaling with re-transmissions (only for group scheduling scheme), error prone with non-overlapping (re-transmissions), and error-prone signaling with non-overlapping plus piggybacking (re-transmissions)

RM-retransmissions enabled and outperform mode 2 at both swarm sizes.

## VII. CONCLUSION

5G NR sidelink mode 2 is the current baseline resource allocation scheme for swarm communication. However, the autonomy of mode 2 and its random resource allocation algorithm is an impediment for its ability to accommodate the growing demand for high performance in dense swarms. We proposed two cooperative resource allocation schemes - *device sequential* and *group scheduling* - each representing a different coordination scheme.

We evaluate the proposed resource allocation schemes against baseline mode 2 in a series of comprehensive system level simulations. Despite the increased signaling overhead necessary in the coordinated schemes, they still represent an order of magnitude reduction in failure probability when compared to mode 2.

The methodology of identifying distinct causes of data failure provided valuable insight. Three enhancement techniques, respectively, resource selection message re-

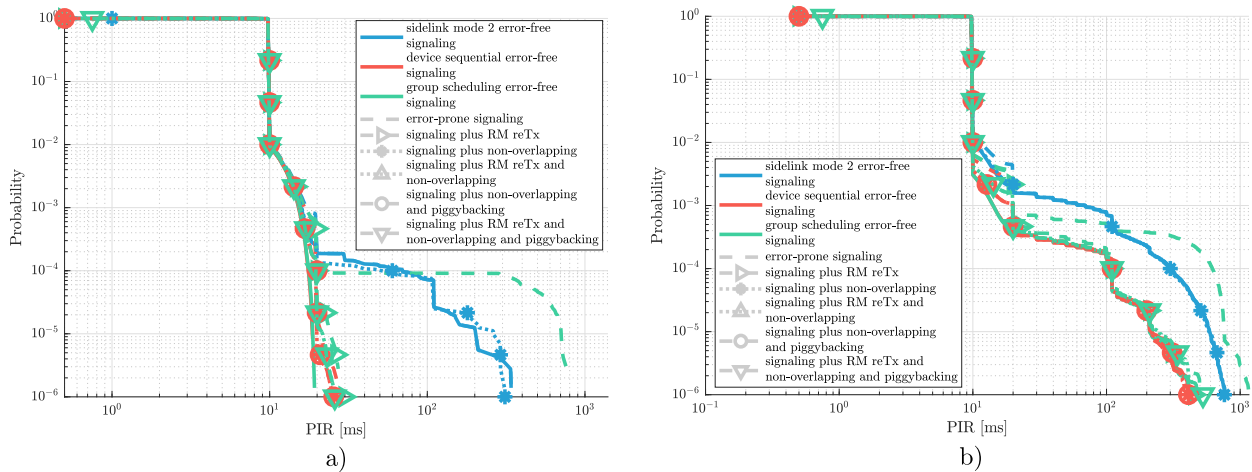

FIGURE 11: Packet inter reception (PIR) at swarm sizes of 20 UEs (a) and 70 UEs (b) for all simulation configurations

transmissions, non-overlapping allocation of discovery messages and piggybacking, were designed to address the data transmission failures caused by the error prone control signaling. Resource selection message re-transmission and non-overlapping allocation of discovery messages proved to significantly reduce failure probability in the coordinated schemes, whereas piggybacking did not introduce any significant gain.

The proposed resource allocation schemes, their associated control signaling and enhancement techniques provide a good trade-off between control overhead and performance in terms of latency and reliability. However, in order to achieve the stringent 99.99% reliability requirement additional interference management techniques are necessary. In our future work we will explore techniques to improve the reliability at larger swarm sizes.

## REFERENCES

- [1] I. Rodríguez, R. S. Mogensen, A. Schjørring, M. Razzaghpour, R. Maldonado, G. Berardinelli, R. Adeogun, P. H. Christensen, P. Mogensen, O. Madsen, C. Møller, G. Pocovi, T. Kolding, C. Rosa, B. Jørgensen, and S. Barbera, "5G Swarm Production: Advanced Industrial Manufacturing Concepts Enabled by Wireless Automation," *IEEE Communications Magazine*, vol. 59, no. 1, pp. 48–54, Jan. 2021. [Online]. Available: <https://ieeexplore.ieee.org/document/9356516/>
- [2] R. Arnold, J. Jablonski, B. Abruzzo, and E. Mezzacappa, "Heterogeneous uav multi-role swarming behaviors for search and rescue," in *2020 IEEE Conference on Cognitive and Computational Aspects of Situation Management (CogSIMA)*, 2020, pp. 122–128.
- [3] D. Albani, J. IJsselmuiden, R. Haken, and V. Trianni, "Monitoring and mapping with robot swarms for agricultural applications," in *2017 14th IEEE International Conference on Advanced Video and Signal Based Surveillance (AVSS)*, 2017, pp. 1–6.
- [4] A. R. Jordehi, "Optimal scheduling of home appliances in home energy management systems using grey wolf optimisation (gwo) algorithm," in *2019 IEEE Milan PowerTech*, 2019, pp. 1–6.
- [5] S. Malik, K. Lee, and D. Kim, "Optimal control based on scheduling for comfortable smart home environment," *IEEE Access*, vol. 8, pp. 218 245–218 256, 2020.
- [6] W. H. C. Wickramaarachchi, M. A. P. Chamikara, and R. A. C. H. Ratnayake, "Towards implementing efficient autonomous vacuum cleaning systems," in *2017 IEEE International Conference on Industrial and Information Systems (ICIS)*, 2017, pp. 1–6.
- [7] S. Hegde, O. Blume, R. Shrivastava, and H. Bakker, "Enhanced resource scheduling for platooning in 5g v2x systems," in *2019 IEEE 2nd 5G World Forum (5GWF)*, 2019, pp. 108–113.
- [8] Q. Wu, S. Zhou, C. Pan, G. Tan, Z. Zhang, and J. Zhan, "Performance analysis of cooperative intersection collision avoidance with c-v2x communications," in *2020 IEEE 20th International Conference on Communication Technology (ICCT)*, 2020, pp. 757–762.
- [9] Mesh Working Group, "Mesh Profile Rev. v1.0.1," Jan. 2019.
- [10] "Ieee standard for low-rate wireless networks," *IEEE Std 802.15.4-2020 (Revision of IEEE Std 802.15.4-2015)*, pp. 1–800, 2020.
- [11] CEPT, "ERC Recommendation 70-03 Relating to the use of Short Range Devices (SRD)," Feb. 2021.
- [12] ETSI, "Electromagnetic compatibility and Radio spectrum Matters (ERM); Short Range Devices (SRD); Radio equipment to be used in the 25 MHz to 1 000 MHz frequency range with power levels ranging up to 500 mW; Part 1: Technical characteristics and test methods," 2012.
- [13] S.-Y. Lien, C.-C. Chien, F.-M. Tseng, and T.-C. Ho, "3gpp device-to-device communications for beyond 4g cellular networks," *IEEE Communications Magazine*, vol. 54, no. 3, pp. 29–35, 2016.
- [14] K. Mun, "CBRS: New Shared Spectrum Enables Flexible Indoor and Outdoor Mobile Solutions and New Business Models," Tech. Rep., 2017.
- [15] Z. Yuan, Y. Ma, Y. Hu, and W. Li, "High-efficiency full-duplex v2v communication," in *2020 2nd 6G Wireless Summit (6G SUMMIT)*, 2020, pp. 1–5.
- [16] 3rd Generation Partnership Project (3GPP), "Feature lead summary for ai 8.11.1.2 inter-ue coordination for mode 2 enhancements," in *RAN WG1#105-e Elections*, May 2021.
- [17] H. Seo, J. Park, M. Bennis, and W. Choi, "Communication and consensus co-design for distributed, low-latency, and reliable wireless systems," *IEEE Internet of Things Journal*, vol. 8, no. 1, pp. 129–143, 2021.
- [18] P. Di Lorenzo and S. Barbarossa, "Swarming Algorithms for Distributed Radio Resource Allocation: A Further Step in the Direction of an Ever-Deeper Synergism Between Biological Mathematical Modeling and Signal Processing," *IEEE Signal Processing Magazine*, vol. 30, no. 3, pp. 144–154, May 2013.
- [19] A. O. Thinh Doan, "Distributed resource allocation on dynamic networks in quadratic time," *Systems & Control Letters*, vol. 99, pp. 57–63, 2017.
- [20] F. Peng, Z. Jiang, S. Zhang, and S. Xu, "Age of Information Optimized MAC in V2X Sidelink via Piggyback-Based Collaboration," *arXiv:2002.10242 [cs, math]*, Apr. 2020, arXiv: 2002.10242. [Online]. Available: <http://arxiv.org/abs/2002.10242>
- [21] N. Bonjorn, F. Foukalas, F. Canellas, and P. Pop, "Cooperative Resource Allocation and Scheduling for 5G eV2X Services," *IEEE Access*, vol. 7, pp. 58 212–58 220, 2019. [Online]. Available: <https://ieeexplore.ieee.org/document/8613007/>
- [22] Y. Jeon, S. Kuk, and H. Kim, "Reducing Message Collisions in Sensing-Based Semi-Persistent Scheduling (SPS) by Using Reselection Lookaheads in Cellular V2X," *Sensors*, vol. 18, no. 12, p. 4388, Dec. 2018. [Online]. Available: <http://www.mdpi.com/1424-8220/18/12/4388>

- [23] S. Morejon, R. Bruun, T. Sørensen, N. Pratas, T. Madsen, J. Liang-hai, and P. Mogensen, "Cooperative Resource Allocation for proximity Communication in Robotic Swarms in an indoor Factory (Forthcoming)," in *2021 IEEE Wireless Communications and Networking Conference (WCNC2021)*. Nanjing, China: IEEE, Mar. 2021.
- [24] 3rd Generation Partnership Project (3GPP), "Physical channels and modulation," in *3GPP TR 38.211 V16.0.0*, Dec. 2019.
- [25] S.-Y. Lien, D.-J. Deng, C.-C. Lin, H.-L. Tsai, T. Chen, C. Guo, and S.-M. Cheng, "3GPP NR Sidelink Transmissions Toward 5G V2X," *IEEE Access*, vol. 8, pp. 35 368–35 382, 2020. [Online]. Available: <https://ieeexplore.ieee.org/document/8998153/>
- [26] S. Lagen, K. Wanuga, H. Elkotby, S. Goyal, N. Patriciello, and L. Giupponi, "New Radio Physical Layer Abstraction for System-Level Simulations of 5G Networks," in *ICC 2020 - 2020 IEEE International Conference on Communications (ICC)*. Dublin, Ireland: IEEE, Jun. 2020, pp. 1–7. [Online]. Available: <https://ieeexplore.ieee.org/document/9149444/>
- [27] R. Zhang, X. Cheng, Q. Yao, C.-X. Wang, Y. Yang, and B. Jiao, "Interference Graph-Based Resource-Sharing Schemes for Vehicular Networks," *IEEE Transactions on Vehicular Technology*, vol. 62, no. 8, pp. 4028–4039, Oct. 2013, conference Name: IEEE Transactions on Vehicular Technology.
- [28] 3rd Generation Partnership Project (3GPP), "TS 38.214 V16.4.0 physical layer procedures for data," Dec. 2020.
- [29] —, "TS 38.321 V16.5.0 medium access control (mac) protocol specification," Dec. 2021.
- [30] —, "TS 38.321 V16.5.0," Jun. 2021.
- [31] —, "TR 22.886 V16.2.0," Dec. 2018.
- [32] —, "Study on channel model for frequencies from 0.5 to 100 ghz," in *3GPP TR 38.901 V16.1.0*, Dec. 2019.
- [33] S. Lu, J. May, and R. J. Haines, "Efficient modeling of correlated shadow fading in dense wireless multi-hop networks," in *2014 IEEE Wireless Communications and Networking Conference (WCNC)*. Istanbul, Turkey: IEEE, Apr. 2014, pp. 311–316.
- [34] 3rd Generation Partnership Project (3GPP), "Physical layer procedures for data," in *3GPP TR 38.214 V16.0.0*, Dec. 2019.
- [35] 3GPP, "TR 37.885 V15.3.0 study on evaluation methodology of new Vehicle-to-Everything (v2x) use cases for lte and nr," Jun. 2019.



networks, propagation modeling and radio resource management.

RASMUS L. BRUUN received his B.Sc. in engineering (internet technologies and computer systems) and M.Sc. in engineering (networks and distributed systems) from Aalborg University, Denmark in 2015 and 2018 respectively. He is currently pursuing a Ph.D. degree in the Wireless Communication Networks section at Aalborg University in collaboration with Nokia Standardizations at the Aalborg, Denmark office. His research activities include mobile wireless ad-hoc



agement and interference mitigation for decentralized networks using 3GPP sidelink.

C. SANTIAGO MOREJÓN GARCÍA received his Eng. degree in electronics and telecommunications from Escuela Politécnica Nacional, Ecuador in 2012 and his M.Sc. in mobile communications from Telecom ParisTech/Eurecom, France in 2017. He is currently pursuing a Ph.D. degree in the Wireless Communication Networks section at Aalborg University in collaboration with Nokia Standardizations at the Aalborg, Denmark office.

His research activities include radio resource management and interference mitigation for decentralized networks using 3GPP sidelink.



resource management, propagation characterisation and related experimental activities. He has successfully supervised more than 15 PhD students, and published more than 120 journal and conference papers.

TROELS B. SØRENSEN received the Ph.D. degree in wireless communications from Aalborg University in 2002. Upon completing his M.Sc. E.E. degree in 1990, he worked with type approval test methods as part of ETSI standardization activities. Since 1997 he has been at Aalborg University, where he is now Associate Professor in the section for Wireless Communication Networks. His research and teaching activities include cellular network performance and evolution, radio



systems for 5G and 6G communications systems, in particular for sidelink use cases.

NUNO K. PRATAS received the Licenciatura and M.Sc. degrees in electrical engineering from Instituto Superior Tecnico, Technical University of Lisbon, Lisbon, Portugal, in 2005 and 2007, respectively, and the Ph.D. degree in wireless communications from Aalborg University, Aalborg, Denmark, in 2012. He is currently a senior research specialist at Nokia. His research interests include wireless communications, networks and development of analysis tools for communication



for IoT systems and mesh networks and methods and tools for performance evaluation of communication systems. She has been involved in a number of national and international projects developing network architectures, network protocols and solutions for Intelligent Transportation Systems; Smart Grids; automotive and train industries.

TATIANA KOZLOVA MADSEN received Ph.D. in mathematics from Lomonosov Moscow State University, Russia in 2000. Since 2001 she is working at Department of Electronic Systems, Aalborg University, Denmark where she currently holds a position of an Associate Professor in Wireless Networking. Her research interests lie in the wide area of wireless networking, including Quality of Service and performance optimization of converging networks, communication protocols



PREBEN MOGENSEN became a full professor at Aalborg University in 2000, where he is currently leading the Wireless Communication Networks Section. He is also a principal scientist in the Standardization & Research Lab of Nokia Bell Labs. His current research interests include industrial use cases for 5G, 5G evolution, and 6G. He is a Bell Labs Fellow.