

FINDING AND COMBINING INDICABLE SUBGROUPS OF BIG MAPPING CLASS GROUPS

CAROLYN R. ABBOTT, HANNAH HOGANSON, MARISSA LOVING, PRIYAM PATEL,
AND RACHEL SKIPPER

ABSTRACT. We explicitly construct new subgroups of the mapping class groups of an uncountable collection of infinite-type surfaces, including, but not limited to, right-angled Artin groups, free groups, Baumslag-Solitar groups, mapping class groups of other surfaces, and a large collection of wreath products. For each such subgroup H and surface S , we show that there are countably many non-conjugate embeddings of H into $\text{Map}(S)$; in certain cases, there are uncountably many such embeddings. The images of each of these embeddings cannot lie in the isometry group of S for any hyperbolic metric and are not contained in the closure of the compactly supported subgroup of $\text{Map}(S)$. In this sense, our construction is new and does not rely on previously known techniques for constructing subgroups of mapping class groups. Notably, our embeddings of $\text{Map}(S')$ into $\text{Map}(S)$ are not induced by embeddings of S' into S . Our main tool for all of these constructions is the utilization of special homeomorphisms of S called shift maps, and more generally, multipush maps.

1. INTRODUCTION

A fundamental question in low-dimensional topology asks which groups can arise as subgroups of the diffeomorphism group, homeomorphism group, and mapping class group of a surface S , denoted by $\text{Homeo}(S)$, $\text{Diffeo}(S)$, and $\text{Map}(S)$, respectively. One approach to producing such subgroups is to consider embeddings of finite-type subsurfaces S' into an infinite-type surface S that induce injections of $\text{Map}(S')$ into $\text{Map}(S)$. In this case, every subgroup of $\text{Map}(S')$ is a subgroup of $\text{Map}(S)$. Another approach to this problem is to show that a particular group G acts by orientation-preserving isometries on a surface S , which implies that G can be realized as a subgroup of $\text{Homeo}(S)$, $\text{Diffeo}(S)$, and $\text{Map}(S)$. However, these two classical approaches have limitations. For example, the strong Tits alternative holds for finite-type mapping class groups, meaning every subgroup of $\text{Map}(S')$ is either virtually abelian or contains a free subgroup [Iva84, McC85]. In addition, Aougab, Patel, and Vlamis show that only finite groups can arise as the isometry group of a hyperbolic metric on S whenever S contains a *non-displaceable subsurface* (see [APV, Lemma 4.2]). They also show that no uncountable group can be obtained as the isometry group of a hyperbolic metric on any infinite-type surface. These observations indicate that in order to fully understand big mapping class groups, we need other constructions of subgroups in $\text{Map}(S)$, and we also need to understand the many different ways that a particular subgroup can embed in $\text{Map}(S)$. This is precisely the goal of this paper.

To streamline the statements of our results below, we construct two uncountable collections of surfaces for which particular results hold. The precise definitions will appear in Section 3.2; we give a brief idea of the types of surfaces contained in each collection here. The first

Date: September 1, 2023.

collection, which we call \mathcal{B}_∞ , contains the surface S whose end space is a Cantor set of nonplanar ends (the blooming Cantor tree surface) along with the connect sum of S and any surface S' with only planar ends; see Definition 3.7. When Π is a *distinguished surface*, we denote by $\mathcal{C}(\Pi)$ certain surfaces that admit a map which acts as a shift along a countable collection of copies of Π ; see Definition 3.5. For example, Π could be a torus with one boundary component, in which case $\mathcal{C}(\Pi)$ includes the ladder surface and the connect sum of a ladder surface and any surface with only planar ends.

Our first construction produces right-angled Artin groups in $\text{Map}(S)$ that do not lie in $\overline{\text{Map}_c(S)}$. Although constructions of right-angled Artin groups in the finite-type setting (e.g., the Clay–Leininger–Mangahas Embedding Theorem [CLM12]) port immediately to the infinite-type setting through subsurface inclusion, we emphasize that we construct subgroups of $\text{Map}(S)$ not arising from finite-type behavior.

Theorem 1.1. *For any surface $S \in \mathcal{B}_\infty$, there exists an infinite family of non-isomorphic right-angled Artin subgroups of $\text{Map}(S)$, each of which embeds into $\text{Map}(S)$ in countably many non-conjugate ways. Moreover, the image of each of these embeddings is not completely contained in $\text{Map}_c(S)$.*

See Corollary 6.6 for a more precise statement outlining which right-angled Artin subgroups we construct. As an example, each of the right-angled Artin groups defined by the graphs in Figure 1 can be found as subgroups of the mapping class group of the Loch Ness monster surface, the blooming Cantor tree surface, and the plane minus a Cantor set.

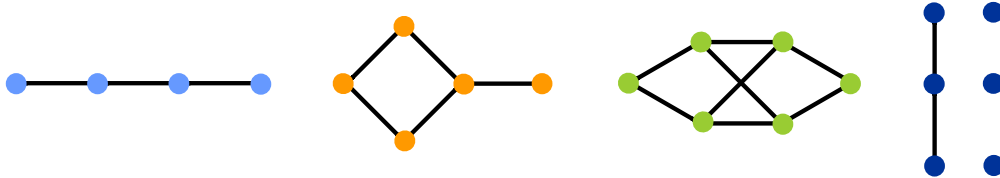

FIGURE 1. Defining graphs for a few of the right-angled Artin groups found as subgroups of big mapping class groups using Theorem 1.1.

Our second construction produces embeddings between big mapping class groups that are not induced by embeddings of the underlying surfaces and that do not preserve the notion of being compactly supported. Recall that a group is called *indicible* if it admits a surjection onto \mathbb{Z} .

Theorem 1.2. *Let Π be a distinguished surface. If $\text{Map}(\Pi)$ is indicible, then for any surface $S \in \mathcal{C}(\Pi)$, there exist countably many non-conjugate embeddings of $\text{Map}(\Pi)$ into $\text{Map}(S)$ that are not induced by an embedding of Π into S .*

The above theorem is in line with a body of work dedicated to understanding and constructing homomorphisms between mapping class groups; see, for example, [ALS09, AS13, ALM21]. There are uncountably many distinguished surfaces Π for which $\text{Map}(\Pi)$ is indicible; see Examples 5.4. When Π has at least two nonplanar ends, Theorem 1.2 holds with $\text{PMap}(\Pi)$ in place of $\text{Map}(\Pi)$; see Corollary 5.3.

Theorem 1.2 also answers Question 4.75 from the AIM problem list on surfaces of infinite type [AIM] which asks, “Given a homomorphism $f: \text{Map}(S) \rightarrow \text{Map}(S')$, does f preserve

the notion of being compactly supported?” Bavard, Dowdall and Rafi [BDR20] show that the answer is yes for surjective homomorphisms, and Aramayona, Leininger, and McLeay [ALM21] give an example of two surfaces and self-maps for which the answer is no. In proving the theorem above, we show that there is an uncountable family of surfaces and maps for which the answer is also no.

These first two constructions are consequences of Theorems 6.3 and 5.2, respectively. The latter is a general construction for embedding indicable subgroups of mapping class groups into $\text{Map}(S)$. Theorem 6.3 is a combination theorem for indicable subgroups of $\text{Map}(S)$, and we summarize its statement as Theorem 1.3 below. The \star -product used in the statement is a generalization of what is known in the literature as a “free product with commuting subgroups,” a natural construction that has been well-studied. Some basic group theoretic properties of such groups can be found in [MKS04, Section 4.2, Problems 22–25]. The \star -product provides a natural interpolation between free products and direct products and includes, for example, graph products of groups. In particular, every right-angled Artin group can be written as a \star -product.

Theorem 1.3. *Let G_i be indicable groups that embed in $\text{Map}(S_i)$, for $i = 1, \dots, n$, where S_i is a surface with exactly one boundary component. For each i , fix a surjective map $f_i: G_i \rightarrow \mathbb{Z}$, and let H_i be the kernel of f_i . The indicable group $(G_1, H_1) \star \dots \star (G_n, H_n)$ embeds in $\text{Map}(S)$ for $S = S_\Gamma(\Pi)$, where Π is obtained from $\#_n S_i$ by capping off $n - 1$ boundary components.*

We direct the reader to Section 3 for the definition of the surface $S_\Gamma(\Pi)$, the construction of which was inspired by work of Allcock [All06]. Importantly, the support of the homeomorphisms defined in our construction is not all of $S_\Gamma(\Pi)$. Consequently, we may change the topology outside the support of the homeomorphisms in any way we choose. In this way, Theorem 1.3 actually shows that $(G_1, H_1) \star \dots \star (G_n, H_n)$ embeds in the mapping class group of a wide class of infinite-type surfaces. For instance, we can arrange for the edited surface to have a non-displaceable subsurface so that the subgroups we construct cannot arise from a construction using isometries, as all such surfaces have finite isometry groups.

A key aspect of the proof of Theorem 1.3 is a set of criteria for a collection of *shift maps* (or *multipush maps*) on an infinite-type surface to generate a free group, given in Theorem 4.2. Shift maps are generalizations of handleshifts, introduced by Patel and Vlamis in [PV18], that have become integral to the theory of infinite-type surfaces. In particular, we augment the generators of the groups G_i in the statement of the theorem with these shift maps (or multipush maps). The fact that shift maps do not lie in $\overline{\text{Map}_c(S)}$ implies that the subgroups we construct are also not completely contained in $\overline{\text{Map}_c(S)}$. The only exceptions to this are when S is finite type or the Loch Ness Monster surface, for which $\overline{\text{Map}_c(S)} = \text{Map}(S)$. We avoid the technical statement of Theorem 4.2 here and direct the reader to Section 4.1.

There are a variety of indicable groups that can play the role of G_i in the statement of Theorem 1.3 (or the role of G in the statement of Theorem 5.2). In particular, one can let G_i be any indicable subgroup of the mapping class group of a finite-type surface with exactly one boundary component, for example, free groups (whose constructions come from pseudo-Anosov elements), right-angled Artin groups, and braid groups. In the constructions outlined below, we also produce new examples of indicable subgroups of big mapping class groups that can be used as input for these theorems, including solvable Baumslag-Solitar groups $BS(1, n)$ and a large class of wreath products $G \wr H$. The following theorem is a

particular case of Proposition 4.3 and Theorem 4.5, which both hold for a more general class of surfaces, including surfaces which contain a non-displaceable subsurface. For instance, the theorem holds when S is the connect sum of a Cantor tree surface with a closed finite genus surface, whose isometry group must be finite. We make the statement below to avoid technicalities.

Theorem 1.4. *If S is a Cantor tree surface, then solvable Baumslag-Solitar groups $BS(1, n)$ and wreath products $\mathbb{Z}^n \wr \mathbb{Z}$ for any $n \geq 1$ arise as subgroups of $\text{Map}(S)$.*

Note that solvable Baumslag-Solitar and $\mathbb{Z}^n \wr \mathbb{Z}$ cannot embed in the mapping class group of any finite-type surfaces. Our theorem gives the first construction of these groups (for $n > 1$) in the mapping class groups of many infinite-type surfaces. Lanier–Loving construct $\mathbb{Z} \wr \mathbb{Z}$ as a subgroup of the mapping class group of any infinite-type surface without boundary [LL20].

Outline. Section 2 contains preliminaries on infinite-type surfaces, mapping class groups, and shift and multipush maps. In Section 3, we give a construction of surfaces from Schreier graphs and describe how to obtain non-conjugate embeddings of subgroups generated by either shift or multipush maps. Our constructions of specific subgroups of big mapping class groups begins in Section 4, where we build embeddings of free groups, wreath products, and solvable Baumslag–Solitar groups into big mapping class groups (Theorem 1.4). In Section 5 we prove Theorem 1.2. Finally, in Section 6 we prove our combination theorem (Theorem 1.3) for indicable subgroups before ending with constructions of right-angled Artin subgroups, proving Theorem 1.1.

Acknowledgements. The authors would like to thank Women in Groups, Geometry, and Dynamics (WiGGD) for facilitating this collaboration, which was supported by NSF DMS–1552234, DMS–1651963, and DMS–1848346. The authors also thank Mladen Bestvina and Rylee Lyman for helpful conversations, as well as George Domat for productive discussions about surfaces with indicable mapping class groups.

In addition, the authors acknowledge support from NSF grants DMS–1803368 and DMS–2106906 (Abbott), DMS–1906095 and RTG DMS–1840190 (Hoganson), DMS–1902729 and DMS–2231286 (Loving), DMS–1937969 and DMS–2046889 (Patel), and DMS–2005297 (Skipper). Skipper was also supported by the European Research Council (ERC) under the European Union’s Horizon 2020 research and innovation program (grant agreement No.725773).

2. PRELIMINARIES

2.1. Ends of surfaces. Essential to the classification of infinite-type surfaces is the notion of an end of a surface and the space of ends for an infinite-type surface S .

Definition 2.1. An *exiting sequence* in S is a sequence $\{U_n\}_{n \in \mathbb{N}}$ of connected open subsets of S satisfying:

- (1) $U_n \subset U_m$ whenever $m < n$;
- (2) U_n is not relatively compact for any $n \in \mathbb{N}$, that is, the closure of U_n in S is not compact;
- (3) the boundary of U_n is compact for each $n \in \mathbb{N}$; and
- (4) any relatively compact subset of S is disjoint from all but finitely many of the U_n ’s.

Two exiting sequences $\{U_n\}_{n \in \mathbb{N}}$ and $\{V_n\}_{n \in \mathbb{N}}$ are equivalent if for every $n \in \mathbb{N}$ there exists $m \in \mathbb{N}$ such that $U_m \subset V_n$ and $V_m \subset U_n$. An *end* of S is an equivalence class of exiting sequences.

The *space of ends* of S , denoted by $E(S)$, is the set of ends of S equipped with a natural topology for which it is totally disconnected, Hausdorff, second countable, and compact. In particular, $E(S)$ is homeomorphic to a closed subset of a Cantor set. The definition of the topology on the space of ends is not relevant to this paper and so is omitted.

Ends of S can be isolated or not and can be *planar*, if there exists an i such that U_i is homeomorphic to an open subset of the plane \mathbb{R}^2 , or *nonplanar*, if every U_i has infinite genus. The set of nonplanar ends of S is a closed subspace of $E(S)$ and will be denoted by $E^g(S)$; these are frequently called the *ends accumulated by genus*. We have the following classification theorem of Kerékjártó [Ker23] and Richards [Ric63]:

Theorem 2.2 (Classification of infinite-type surfaces). *The homeomorphism type of an orientable, infinite-type surface S is determined by the quadruple*

$$(g, b, E^g(S), E(S))$$

where $g \in \mathbb{Z}_{\geq 0} \cup \infty$ is the genus of S and $b \in \mathbb{Z}_{\geq 0}$ is the number of (compact) boundary components of S .

There is a more complicated classification of infinite-type surfaces allowing for non-compact boundary components due to Prishlyak–Mischenko [PM07]. We use this classification once in Section 3.2, but in our setting, the surfaces we are comparing have precisely the same boundary, so the classification reduces to considering the triple $(g, E^g(S), E(S))$.

2.2. Mapping class group. The *mapping class group* of S , denoted $\text{Map}(S)$, is the set of orientation-preserving homeomorphisms of S up to isotopy that fix the boundary pointwise. The natural topology on the set of homeomorphisms of S is the compact-open topology, and $\text{Map}(S)$ is endowed with the induced quotient topology. Equipped with this topology, $\text{Map}(S)$ is a topological group. When S is a finite-type surface, this topology on $\text{Map}(S)$ agrees with the discrete topology, but when S is of infinite type, the two topologies are distinct. The *pure mapping class group*, denoted $\text{PMap}(S)$, is the subgroup of $\text{Map}(S)$ that fixes the set of ends of S pointwise, and $\text{Map}_c(S)$ is the subgroup of compactly supported mapping classes.

Definition 2.3. A mapping class $f \in \text{Map}(S)$ is of *intrinsically infinite type* if $f \notin \overline{\text{Map}_c(S)}$. A subgroup $H \leq \text{Map}(S)$ is of intrinsically infinite type if H is not completely contained in $\overline{\text{Map}_c(S)}$.

Note that $\overline{\text{Map}_c(S)} \leq \text{PMap}(S)$. When S has at most one nonplanar end, $\overline{\text{Map}_c(S)}$ is actually equal to $\text{PMap}(S)$ [APV20]. In this paper, all of the subgroups of $\text{Map}(S)$ that we construct contain many intrinsically infinite-type homeomorphisms and, therefore, cannot be completely contained in $\overline{\text{Map}_c(S)}$, except when S is finite-type or the Loch Ness Monster, in which case $\overline{\text{Map}_c(S)} = \text{Map}(S)$. Recall that the Loch Ness Monster surface is the unique infinite-genus surface with one end (up to homeomorphism).

We are particularly interested in indicable groups and various ways of embedding them in mapping class groups of infinite-type surfaces. A group G is *indicable* if there exists a surjective homomorphism $f: G \rightarrow \mathbb{Z}$. We show in Lemma 5.1 that a group G is indicable if

and only if there is a presentation for G where the relators all have total exponent sum zero in the generators of G . Importantly, many of our constructions require an indicable subgroup G of $\text{Map}(S)$ as an input, where S is a surface with exactly one boundary component. There are many examples of such groups that were mentioned in the introduction, but there are also some restrictions on what groups G can arise as subgroups of mapping class groups, as is evidenced by the following lemma, which generalizes the same result from the finite-type setting [FM12, Corollary 7.3].

Lemma 2.4 ([ACCL20, Corollary 3]). *If S is an orientable surface with nonempty compact boundary, the mapping class group fixing the boundary pointwise is torsion-free.*

2.3. Push and shift maps. In this section, we define shift maps and push maps, which are central to all of our constructions. A particular type of shift maps, called handle shifts, were first studied by Patel-Vlamis in [PV18]. This inspired the following definition of Abbott, Miller, and Patel [AMP]. A similar definition of shift maps appears in [MR19] and [LL20].

Definition 2.5. Let D_Π be the surface defined by taking the strip $\mathbb{R} \times [-1, 1]$, removing an open disk of radius $\frac{1}{4}$ with center $(n, 0)$ for $n \in \mathbb{Z}$, and attaching any fixed topologically nontrivial surface Π with exactly one boundary component to the boundary of each such disk. A *shift* on D_Π is the homeomorphism that acts like a translation, sending (x, y) to $(x + 1, y)$ for $y \in [-1 + \epsilon, 1 - \epsilon]$ and which tapers to the identity on ∂D_Π .

Given a surface S with a proper embedding of D_Π into S so that the two ends of the strip correspond to two different ends of S (see Figure 2), the shift on D_Π induces a *shift* on S , where the homeomorphism acts as the identity on the complement of D_Π . If instead, we have a proper embedding of D_Π into S where the two ends of the strip correspond to the same end, we call the resulting homeomorphism on S a *one-ended shift*. Given a shift or one-ended shift h on S , the embedded copy of D_Π in S is called the *domain* of h . By abuse of notation, we will sometimes say that the domain of the shift or one-ended shift h is D_Π rather than referring to it as an embedded copy of D_Π in S (when it is clear from context to which embedded copy of D_Π we are referring).

Remark 2.6. If the surface Π in Definition 2.5 has a nontrivial end space, then a shift or one-ended shift h on S with domain D_Π is not in $\text{PMap}(S)$ since there are ends of S that are not fixed by h . Thus, $h \notin \overline{\text{Map}_c(S)}$ and is of intrinsically infinite type. On the other hand, if h is a shift map and if Π is a finite-genus surface with no planar ends, then h is a power of a handle shift on S , and the proof of [PV18, Proposition 6.3] again tells us that $h \notin \overline{\text{Map}_c(S)}$. However, the second conclusion does not hold when h is a power of a one-ended handle shift since, in that case, it follows from work in [PV18] that $h \in \overline{\text{Map}_c(S)}$.

We now use the construction of shift maps to introduce *finite shifts*, which will be used in Section 4.3 to construct certain wreath products. These are constructed in a completely analogous way, starting with an annulus instead of a biinfinite strip.

Definition 2.7. Let A_Π be a surface defined by taking the annulus

$$([0, n]/0 \sim n) \times [-1, 1],$$

removing an open disk of radius $\frac{1}{4}$ centered at the integer points, and attaching any fixed topologically nontrivial surface Π with exactly one boundary component to the boundary of

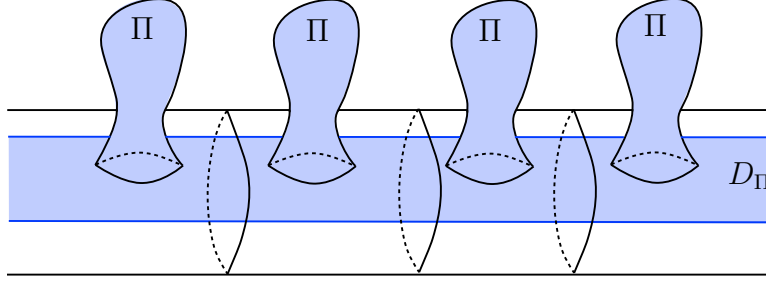

FIGURE 2. A surface S that admits a shift whose domain is an embedded copy of D_Π .

each disk. A *finite shift* on A_Π is the homeomorphism that acts like a translation, sending (x, y) to $(x + 1, y)$ (modulo n) for $y \in [-1 + \epsilon, 1 - \epsilon]$ and which tapers to the identity on ∂A_Π . Given a surface S with a proper embedding of A_Π into S , the finite shift on A_Π induces a *finite shift* on S , where the homeomorphism acts as the identity on the complement of A_Π . We call the embedded copy of A_Π the *domain* of the finite shift.

Definition 2.8. A *push* is any map that is a finite shift, a one-ended shift, or a shift map.

In Section 3, we will introduce the notion of a *multipush*, which is roughly a collection of push maps with disjoint supports, once we have developed some further notation and language.

3. SURFACES FROM GRAPHS AND NON-CONJUGATE EMBEDDINGS

In this section, we begin by constructing a broad class of surfaces using an underlying graph. We then introduce a specific type of homeomorphism called a *multipush* and show that these maps can be utilized to produce infinitely many non-conjugate embeddings of certain groups into mapping class groups.

3.1. A construction of surfaces. The basic building block for this construction is a d -holed sphere. The following definition of seams restricts to the normal notion of seams for a 3-holed sphere, i.e., a pair of pants.

Definition 3.1. A set of *seams* on a d -holed sphere is a collection of d disjointly embedded arcs such that each boundary component of the sphere intersects exactly two components of the seams at two distinct points and such that the collection of seams divides the sphere into two components. Call one component the *front side* and the other component the *back side*. These conditions imply that each component is homeomorphic to a disk.

Starting from any graph Γ with a countable vertex set and any surface Π with exactly one boundary component, we describe a procedure for building a surface $S_\Gamma(\Pi)$. This mirrors a construction of Allcock using the Cayley graph of a given group G [All06].

For each vertex v of valence $d + 1$, start with a $(d + 1)$ -holed sphere. Remove a disk on the interior of the front side, and attach the surface Π along the boundary component. Call the resulting surface the *vertex surface for v* , which we denote by V_v , and let Π_v be the copy of Π on V_v . For each edge of the graph, define the edge surface E to be the 2-holed sphere with seams; topologically this is an annulus.

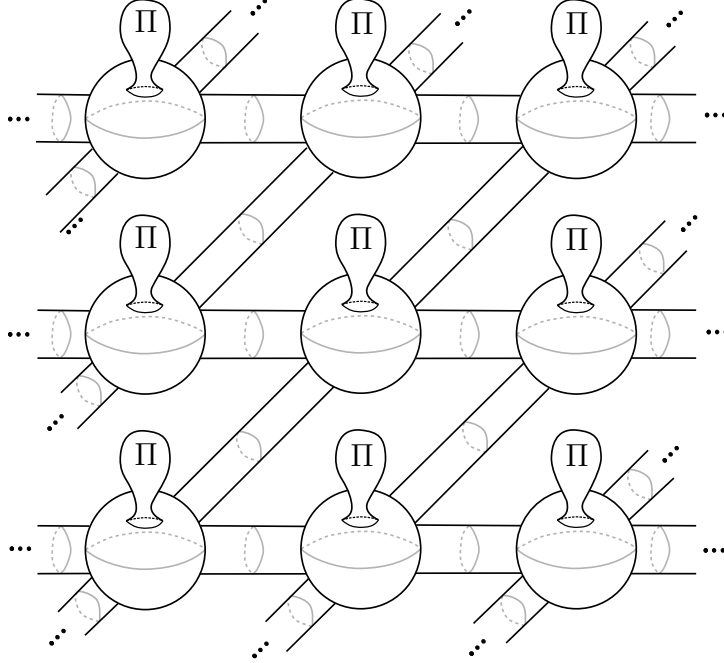

FIGURE 3. An example of the surface $S_\Gamma(\Pi)$ where the graph Γ is the Cayley graph of the group $\mathbb{Z}^2 = \langle a, b : [a, b] \rangle$.

Whenever u and v are vertices of Γ connected by an edge, connect the vertex surfaces V_u and V_v with an edge surface $E(u, v)$ by gluing one boundary component of the edge surface to a boundary component of V_u and the other boundary component of the edge surface to a boundary component of V_v so that the gluing is *compatible* in the following sense: the union of the seams separates S_Γ into two disjoint connected components, the *front* and the *back*, containing the front and, respectively, the back of each vertex and edge surface. Call the resulting surface $S_\Gamma(\Pi)$. See Figure 3 for an example. Notice that the assumption that the vertex set $V(\Gamma)$ of Γ is countable is necessary for this construction to yield a surface. In particular, if $V(\Gamma)$ is uncountable, then $S_\Gamma(\Pi)$ is not second countable, and therefore cannot be a surface.

We also define a more general class of surfaces constructed by editing the back of $S_\Gamma(\Pi)$ as follows. As above, fix a graph Γ with a countable vertex set and a surface with one boundary component Π , and let $S = S_\Gamma(\Pi)$. Given any collection of surfaces $\{\Omega_v\}_{v \in V(\Gamma)}$, only finitely many of which have boundary, we form the surface $S \#_{v \in V(\Gamma)} \Omega_v$ as follows. For each $v \in V(\Gamma)$, take the connect sum of V_v and the corresponding Ω_v . It is helpful to assume that the connect sum is done on the back of V_v , since we will perform certain homeomorphisms on the front of S later in the paper. We note that if every Ω_v is a sphere, then $S \#_{v \in V(\Gamma)} \Omega_v$ is homeomorphic to S . On the other hand, by choosing the Ω_v to be more complicated, we can change the homeomorphism type of S by changing the genus or the space of ends. Thus, even for a fixed surface Π , this construction will result in a large family of surfaces, formed by varying the Ω_v .

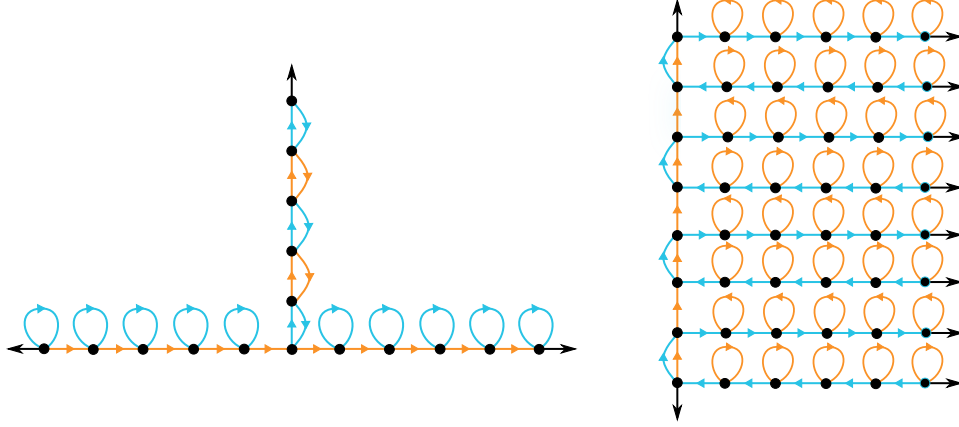

FIGURE 4. Each graph can be realized as a Schreier graph but not a Cayley graph. The graph on the left has 3 ends, and the graph on the right has end space homeomorphic to the 2-point compactification of \mathbb{Z} .

The underlying graph Γ used to build $S_\Gamma(\Pi)$ throughout this paper will often be a Schreier graph, which is defined as follows. Let G be a finitely generated group, H a subgroup of G , and T a finite generating set for G . The Schreier graph $\Gamma(G, T, H)$ is the graph whose vertices are the right cosets of H and in which, for each coset Hg and each $s \in T$, there is an edge from Hg to Hgs labeled by s . If $Hg = Hgs$, there is a loop labeled by s at the vertex corresponding to Hg . Our assumption on the finiteness of T ensures that $\Gamma(G, T, H)$ has a countable vertex set. When Γ is a Schreier graph, let Π_{Hg} be the copy of Π on the vertex surface corresponding to the coset Hg . In the special case when $H = \{1\}$, the Schreier graph $\Gamma(G, T, \{1\})$ is simply the Cayley graph of G with respect to the generating set T , which we denote by $\Gamma(G, T)$.

Definition 3.2. Let Γ be a Schreier graph for a triple (G, T, H) . A *Schreier surface associated to (G, T, H)* is a surface $S = S_\Gamma(\Pi) \#_{v \in V(\Gamma)} \Omega_v$ where Π has exactly one boundary component and is not a disk, and $\{\Omega_v\}$ is any collection of surfaces, only finitely many of which have boundary.

We use Schreier graphs in our construction rather than simply Cayley graphs to demonstrate the large class of surfaces our results apply to. When Π is compact, the surface $S_\Gamma(\Pi)$ will have the same end space as the graph Γ . A Cayley graph for a finitely generated group will have 1, 2 or a Cantor set of ends. On the other hand, there are many more possibilities for a Schreier graph; any regular graph with even degree can be realized as a Schreier graph [Gro77, Lub95]. For example, there are Schreier graphs with any finite number of ends, or end spaces isomorphic to $\mathbb{N} \cup \{\infty\}$ or $\{-\infty\} \cup \mathbb{Z} \cup \{\infty\}$, and so our construction yields surfaces with these end spaces, as well. See Figure 4 for two examples of Schreier graphs that cannot be realized as Cayley graphs.

We are now ready to define a *multipush* on a Schreier surface.

Definition 3.3. Let $\Gamma = \Gamma(G, T, H)$ be a Schreier graph. Fix a surface Π with exactly one boundary component. Let $S = S_\Gamma(\Pi) \#_{v \in V(\Gamma)} \Omega_v$ be a Schreier surface.

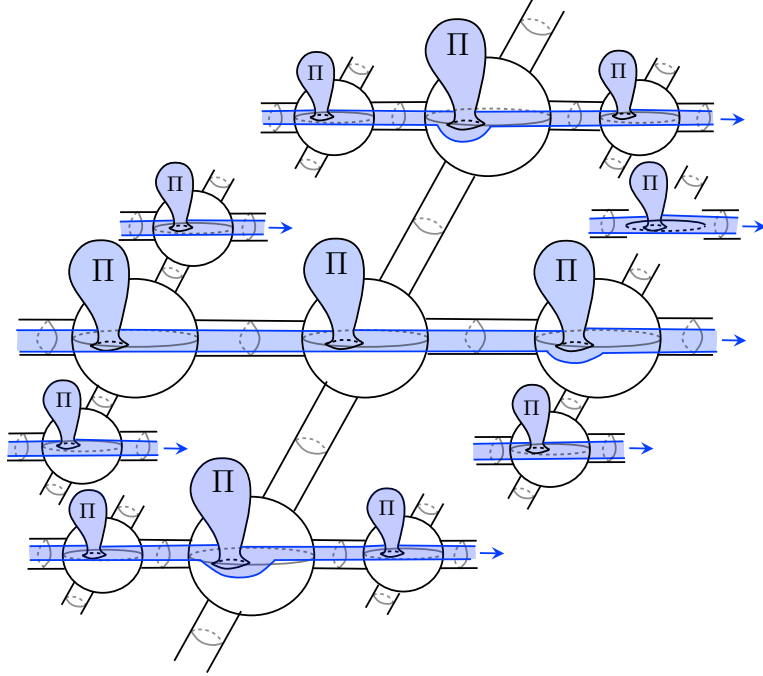

FIGURE 5. A portion of the domain D_a (in blue) of the multipush x_a on the surface $S_\Gamma(\Pi)$, where Γ is the Cayley graph $\Gamma = \Gamma(\mathbb{F}_2, \{a, b\})$ for $\mathbb{F}_2 = \langle a, b \rangle$.

For each $s \in T$, we will construct a collection of push maps whose support corresponds to connected components of the subgraph of Γ which includes only edges labeled by s (see Figure 5). Fix a transversal \mathcal{T} for the set of double cosets $\{Hg\langle s \rangle \mid g \in G\}$, so that \mathcal{T} contains exactly one element from each double coset in the set. In the case $H = \{1\}$, that is, when Γ is a Cayley graph, the set \mathcal{T} is simply a transversal for (left cosets of) $\langle s \rangle$. For each element t in the transversal, we define a push $h_{t\langle s \rangle}$ which maps Π_{Hts^i} to $\Pi_{Hts^{i+1}}$. The support of $h_{t\langle s \rangle}$ is contained in the front of

$$\left(\bigcup_{i \in \mathbb{Z}} V_{Hts^i} \right) \cup \left(\bigcup_{i \in \mathbb{Z}} E(Hts^i, Hts^{i+1}) \right).$$

Recall that V_{Hts^i} is the vertex surface associated to the vertex Hts^i and $E(Hts^i, Hts^{i+1})$ is the edge surface associated to the edge (Hts^i, Hts^{i+1}) for each $i \in \mathbb{Z}$. This support corresponds to a connected component of Γ with all edges labeled by s ; see Figure 5. The *multipush* x_s associated to s is the element of $\text{Map}(S)$ that acts simultaneously as the pushes $h_{t\langle s \rangle}$ for each $t \in \mathcal{T}$. We let D_s denote the domain of the multipush x_s . If $h_{t\langle s \rangle}$ is not a finite shift for any $t \in T$, we say x_s is an *infinite* multipush.

Since supports of the pushes $h_{t\langle s \rangle}$ are disjoint, the multipush x_s is a well-defined homeomorphism of the surface. Note that if $Hg = Hgs$, then the edge $E(Hgs^i, Hgs^{i+1})$ in the support of $h_{g\langle s \rangle}$ is a loop. In particular, finite pushes can occur as part of a multipush. In Figure 5, all pushes are infinite, but the multipush with the orange domain shown in Figure 6 has both a finite and infinite push.

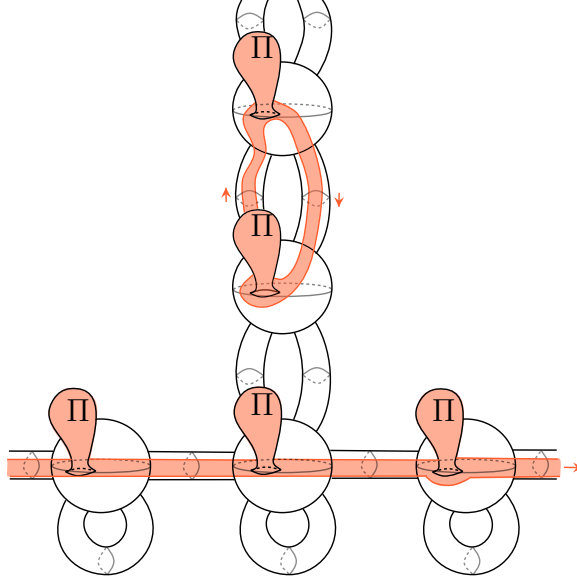

FIGURE 6. A multipush on a surface corresponding to the Schreier graph on the left in Figure 4 that contains both a finite and infinite push. The domain of the multipush is highlighted in orange.

Remark 3.4. We emphasize that multipushes are *not* induced by an action on the graph Γ , even when Γ is a Cayley graph. The construction simply uses the labeling of the vertices of Γ to define the homeomorphism x_s .

3.2. Non-conjugate embeddings. Given a shift map h corresponding to an embedding of D_Π into a surface S , one can define a new and distinct shift map h' on S by omitting some of the surfaces Π_i from the domain, as long as infinitely many remain. This gives another embedding of D_Π into S . See Figure 7. Since there are uncountably many infinite subsets of \mathbb{Z} , we can construct uncountably many distinct embeddings of D_Π into S , and thus uncountably many distinct shift maps on S , in this way. The same argument goes through for one-ended shifts as well. Similarly, one infinite multipush x_s associated to a generator $s \in T$ on a surface $S = S_\Gamma(\Pi)$ can be used to produce uncountably many distinct domains for multipushes associated to s by simply omitting some of the copies of Π from the domains of x_s for all $s \in T$.

In many cases, these distinct domains give rise to isomorphic but non-conjugate subgroups of $\text{Map}(S)$. First, consider the case of shift maps. Given a shift map h on S , we define a new shift map h' on S by removing some copies of Π from the domain of the shift. The groups $\langle h \rangle$ and $\langle h' \rangle$ are isomorphic subgroups of $\text{Map}(S)$. If they were conjugate, not only would $\text{supp}(h)$ and $\text{supp}(h')$ be homeomorphic, but their complements $S \setminus \text{supp}(h)$ and $S \setminus \text{supp}(h')$ would also be homeomorphic. There are many surfaces Π and S for which this latter condition fails. For example, Π could be a handle, that is, a torus with one boundary component, and $S = S_\Gamma(\Pi)$ could be obtained from $\Gamma(\mathbb{Z}, \{1\})$ and connect sum with a surface with only planar ends. In this case, $h = x_1$ is a shift map and $S \setminus \text{supp}(h)$ has genus zero, while $S \setminus \text{supp}(h')$ has nonzero genus coming from the copies of Π that were removed from the domain of h . Therefore, these complements are not homeomorphic and the embeddings of \mathbb{Z}

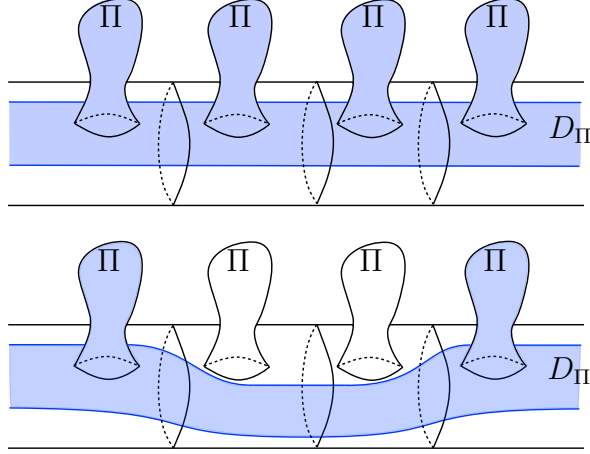

FIGURE 7. Two different embeddings of D_Π . The figure at the top corresponds to a shift h and the embedding shown at the bottom corresponds to a new and distinct shift h' obtained by leaving two copies of Π out of the domain of h .

as $\langle h \rangle$ and $\langle h' \rangle$ are non-conjugate. In this example, Π is a handle, but we can generalize to allow Π to be any surface with a countable end space and one boundary component, so long as removing copies of Π from the domain of the shift map still produces non-homeomorphic subsurfaces $S \setminus \text{supp}(h)$ and $S \setminus \text{supp}(h')$. This motivates the following definition.

Definition 3.5. A *distinguished surface* is a surface Π with exactly one boundary component, satisfying at least one of the following:

- (1) Π has finite genus,
- (2) $E(\Pi)$ consists of finitely many planar ends, or
- (3) $E(\Pi)$ consists of finitely many nonplanar ends.

For each distinguished surface Π , let $\mathcal{C}(\Pi)$ be the collection of surfaces S that admit an embedding of D_Π such that the following holds. If Π satisfies (1), then $S \setminus D_\Pi$ has finite (possibly zero) genus. If Π satisfies (2) or (3), then $S \setminus D_\Pi$ has finitely many planar or nonplanar ends, respectively. If Π falls into more than one of the above categories, then $\mathcal{C}(\Pi)$ should consist of surfaces that satisfy either of the conditions on $S \setminus D_\Pi$.

If Π is a distinguished surface and $S \in \mathcal{C}(\Pi)$, then S admits a shift h with domain D_Π . If h' is another shift on S whose domain is embedded by omitting finitely many copies of Π from D_Π , then each of the three conditions on Π ensures that $S \setminus \text{supp}(h)$ and $S \setminus \text{supp}(h')$ are not homeomorphic. In particular, $S \setminus \text{supp}(h)$ and $S \setminus \text{supp}(h')$ will have different genus or will contain a different number of planar or nonplanar ends. Similarly, if h' and h'' are obtained from h by omitting different (finite) numbers of copies of Π from D_Π , then the complements of their supports are not homeomorphic.

The collection $\mathcal{C}(\Pi)$ for a distinguished surface Π is uncountable. To see this, suppose Π has finite genus or $E(\Pi)$ consists of finitely many nonplanar ends. Then S can be any surface such that $S \setminus D_\Pi$ has only planar ends. On the other hand, if $E(\Pi)$ consists of finitely many planar ends, then S can be any surface so that $S \setminus D_\Pi$ has no planar ends. In either case, there are uncountably many such S .

The definition of a distinguished surface Π and the collection of surfaces $\mathcal{C}(\Pi)$ ensure that we can “count” the number of copies of Π that have been removed the domain of a shift, thus producing non-conjugate embeddings. We could expand the definition of a distinguished surface and the collection $\mathcal{C}(\Pi)$ to encompass a larger family of surfaces for which this is possible, but we choose the streamlined definition above for simplicity, while still demonstrating that our results hold for a broad class of surfaces.

We have shown that there are countably many non-conjugate infinite cyclic subgroups in $\text{Map}(S)$. In Section 5, we will use these different embeddings of \mathbb{Z} to construct non-conjugate embeddings of indicable subgroups into $\text{Map}(S)$ (Theorem 1.2). The following lemma summarizes the discussion above.

Lemma 3.6. *Let S be any surface in the uncountable collection $\mathcal{C}(\Pi)$ for a distinguished surface Π . There exist countably many non-conjugate embeddings of the subgroup generated by the shift map on S with domain D_Π into $\text{Map}(S)$.*

We now turn our attention to constructing non-conjugate embeddings of subgroups generated by multipushes. Let $S = S_\Gamma(\Pi)$ be infinite-type, and let x_s be the multipush defined by $s \in T$. In the same way as for a shift map, by omitting copies of Π from the domain of x_s so that the complements of the supports are not homeomorphic, we obtain a non-conjugate embedding of $\langle x_s \rangle$ in $\text{Map}(S)$.

If several multipushes x_s for $s \in T$ have common copies of Π in their supports, such as in Figure 14, more care needs to be taken. It is possible to remove copies of Π from the domains of all the multipushes to obtain new multipushes x'_s in such a way that $\langle x_s \mid s \in T \rangle \cong \langle x'_s \mid s \in T \rangle$ and so that the complements of the supports of the subgroups are not homeomorphic. One way to formalize this is to consider the surface $S_m = S \#_{v \in V(\Gamma)} \Omega_v$ where

exactly m of the Ω_v are homeomorphic to Π with the boundary component capped off, and the remainder of the Ω_v are spheres. By the classification of surfaces, the surfaces S and S_m are homeomorphic, and this homeomorphism induces an isomorphism of mapping class groups $\text{Map}(S) \cong \text{Map}(S_m)$. Let $x_s^{(m)}$ be the multipush on the surface S_m defined by $s \in T$. Notice that $G = \langle x_s \mid s \in T \rangle$ is isomorphic to $\langle x_s^{(m)} \mid s \in T \rangle$ because they are generated by multipushes with the same supports π_1 -embedded into different surfaces. Let $G_m \leq \text{Map}(S)$ be the image of $\langle x_s^{(m)} \mid s \in T \rangle \leq \text{Map}(S_m)$ under the isomorphism of mapping class groups, so that $G \cong G_m$. By construction, there are m copies of Π that are not in the support of G_m , while all copies of Π are in the support of G , and so G and G_m are not conjugate. Similarly, whenever $m \neq n$, the groups G_m and G_n are isomorphic and non-conjugate.

For the remainder of the paper, when we say that we remove copies of Π from the supports of multipushes, we will mean that we do so in the above manner, so that the resulting groups are isomorphic.

If the ends of Γ contain a Cantor set, then there are uncountably many non-conjugate copies of G in $\text{Map}(S)$. To see this, use the procedure above to edit the domains of the multipush maps by removing a collection of copies of Π that accumulate onto a closed subset of the Cantor set of ends of $S = S_\Gamma(\Pi)$. By removing copies of Π that accumulate onto non-homeomorphic closed subsets of the Cantor set, we obtain a non-conjugate embedding of G into $\text{Map}(S)$.

Above, we assumed that $S = S_\Gamma(\Pi)$. However, the argument applies more broadly. For example, if $S = S_\Gamma(\Pi) \#_{v \in V(\Gamma)} \Omega_v$ and each Ω_v has only planar ends and Π has nonzero finite genus, then adding two finite collections of handles of differing sizes to some Ω_v still results in the complements of the domains being non-homeomorphic subspaces. More generally, we could let Π be any surface with a countable end space and one boundary component (of which there are uncountably many), so long as removing two finite collections of Π of differing cardinalities still results in the complement subsurfaces being non-homeomorphic. This observation leads to the definition of the following family of surfaces.

Definition 3.7. Let \mathcal{B} be the collection of Schreier surfaces $S = S_\Gamma(\Pi) \#_{v \in V(\Gamma)} \Omega_v$ such that

$S_\Gamma(\Pi)$ is infinite-type, Π has a countable end space, and the surfaces Ω_v are compatible with Π in following sense: if $Y = \bigcup_{s \in T} \text{supp}(x_s)$, with $Y' = \bigcup_{s \in T} \text{supp}(x'_s)$ and $Y'' = \bigcup_{s \in T} \text{supp}(x''_s)$, respectively, where x'_s is obtained by moving m copies of Π out of the domain of x_s and x''_s is obtained by moving n copies of Π out of the domain of x_s with $m \neq n$, then $S \setminus Y'$ and $S \setminus Y''$ are non-homeomorphic in S . Let \mathcal{B}_∞ be the subset of \mathcal{B} consisting of those Schreier surfaces built from infinite-type surfaces Π .

The above discussion demonstrates that \mathcal{B} is uncountable and proves the following lemma.

Lemma 3.8. *Let S be any surface in the uncountable collection \mathcal{B} . Letting G be the subgroup of $\text{Map}(S)$ generated by the multipush maps x_s on S for $s \in T$, there exist countably many non-conjugate copies of G in $\text{Map}(S)$. If Γ has a Cantor set of ends, then there are uncountably many non-conjugate copies of G in $\text{Map}(S)$.*

3.3. Non-isometric embeddings. Throughout the paper, all constructions of subgroups will utilize push and multipush maps. If the complement of the domain of a (multi)push is not simply connected, then the map cannot act as an isometry for any hyperbolic metric on S . We can use the collection of subsurfaces $\{\Omega_v\}$ from the construction of a Schreier surface S to ensure this condition holds, and so all of our constructions can produce subgroups that are not contained in the isometry group of S for any hyperbolic metric on S .

For many surfaces, this is not simply an artifact of our particular construction. By choosing the collection $\{\Omega_v\}$ carefully, we can often ensure that the resulting surface S has a non-displaceable subsurface, and hence its isometry group (with respect to any hyperbolic metric) contains only finite groups [APV, Lemma 4.2]. In particular, the groups we construct could not arise from a construction using isometries for any such surface.

4. FREE GROUPS, WREATH PRODUCTS, AND BAUMSLAG-SOLITAR GROUPS

In this section, we use shift maps and multipushes to construct free groups, certain wreath products, and solvable Baumslag-Solitar groups as subgroups of big mapping class groups.

4.1. Free groups. The construction of Schreier surfaces from Section 3.1 was motivated by the following construction of a free subgroup of intrinsically infinite type.

Example 4.1. Let Γ be the Cayley graph of the free group $\mathbb{F}_2 = \langle a, b \rangle$, which is the Schreier graph $\Gamma(\mathbb{F}_2, \{a, b\}, \{\text{id}\})$, and build the Schreier surface $S = S_\Gamma(\Pi)$ with Π a torus with one boundary component. See Figure 5. This Schreier surface is homeomorphic to the blooming Cantor tree, that is, the surface with no boundary components, no planar ends, and a Cantor

set of nonplanar ends. The multipushes x_a and x_b generate a copy of \mathbb{F}_2 in $\text{PMap}(S)$. To see this, observe that for any $g \in \langle a, b \rangle$, the multipush x_a maps Π_g to Π_{ga} , and similarly for x_b . Thus, the only way for a word $w \in \langle x_a, x_b \rangle$ to act trivially on the surface is if the corresponding word in $\langle a, b \rangle$ is trivial. Moreover, Remark 2.6 shows that this copy of \mathbb{F}_2 in $\text{PMap}(S)$ is not contained in $\overline{\text{Map}_c(S)}$.

In this example, it is straightforward to prove that a non-trivial word $w \in \langle x_a, x_b \rangle$ acts non-trivially on the surface because \mathbb{F}_2 has no relations and Γ is a tree, so we only need to track where w sends Π_{id} . With a more nuanced analysis of the action of w , however, we can show that multipushes generate a free group in a much more general setting. Recall that the collection \mathcal{B} of Schreier surfaces was defined in Definition 3.7.

Theorem 4.2. *Let Γ be a Schreier graph for a triple (G, T, H) and S any associated Schreier surface. The set $\{x_\alpha \mid \alpha \in T\}$ generates a free group of rank $|T|$ in $\text{Map}(S)$. If $|T| = 1$ and Γ is finite, then we require that at least one Ω_v is not a sphere.*

Moreover, when $S \in \mathcal{B}$, there exist countably many non-conjugate embeddings of such a free group in $\text{Map}(S)$, none of which can lie entirely in the isometry group for any hyperbolic metric on S . If S is not finite type and not the Loch Ness monster surface, these free groups cannot be completely contained in $\overline{\text{Map}_c(S)}$.

Proof. Let $w = t_1 \dots t_k$ be a nontrivial, freely reduced word in the free group generated by the set T , and let $x_w := x_{t_k} \dots x_{t_1}$ be the product of multipushes. We aim to show that x_w is nontrivial in $\text{Map}(S)$. We first observe that if $x_w(\Pi_{Hg}) = \Pi_{Hgw} \neq \Pi_{Hg}$ for any coset Hg , then x_w is nontrivial in $\text{Map}(S)$. We may therefore assume that x_w returns each Π_{Hg} to itself. In particular, this implies that $Hgw = Hg$ for all $g \in G$, and so the edge path given by labels (t_1, \dots, t_k) in $\Gamma(G, T, H)$ based at any vertex describes a cycle.

First consider a one-generated group G . If Γ is infinite, then we must have $H = \{\text{id}\}$, in which case $\Gamma(G, T, H) = \Gamma(\mathbb{Z}, \{1\}, \{\text{id}\})$ is the Cayley graph of \mathbb{Z} with its standard generator. Since this graph has no cycles, each element x_w with $w \in G$ is non-trivial in $\text{Map}(S)$. On the other hand, suppose Γ is a finite cycle of order k , and consider the multipush x_t , where t is the generator of G . Then, x_t^k represents a cycle in Γ , but the requirement that some Ω_i is not a sphere guarantees that the curve γ and $x_t^k(\gamma)$ cobound a surface with non-trivial topology. See Figure 8 for the case $k = 3$. Thus γ and $x_t^k(\gamma)$ are not homotopic, so x_t^k is non-trivial and $\langle x_t \rangle \cong \mathbb{Z}$.

Now assume $|T| = n \geq 2$, so that every vertex of $\Gamma(G, T, H)$ has degree $2n \geq 4$. Let $p: \tilde{\Gamma} \rightarrow \Gamma$ be the universal cover of the labelled graph Γ , which is a tree of valency $2n$ with edge labels in the set T . Construct the Schreier surface $\tilde{S} = S_{\tilde{\Gamma}}(\Pi) \#_{\tilde{v} \in V(\tilde{\Gamma})} \Omega_{\tilde{v}}$, where $\Omega_{\tilde{v}} = \Omega_v$

whenever $p(\tilde{v}) = v$. By construction, \tilde{S} is a cover of $S = S_{\Gamma}(\Pi) \#_{v \in V(\Gamma)} \Omega_v$. See Figure 9 for an example.

For each $t \in T$, let \tilde{x}_t be the multipush on \tilde{S} obtained by identifying $\tilde{\Gamma}$ with the Cayley graph of the free group with basis T . The covering map $P: \tilde{S} \rightarrow S$ induces a homomorphism from the group generated by the multipushes on \tilde{S} to the group generated by the multipushes on S by mapping $\tilde{x}_t \mapsto x_t$. Recall that, by assumption, $w = t_1 \dots t_k$ is a non-trivial reduced word in the free generating set T and $x_w = x_{t_k} \dots x_{t_1}$. Let $\tilde{x}_w = \tilde{x}_{t_k} \dots \tilde{x}_{t_1}$.

Suppose towards a contradiction that x_w is trivial in $\text{Map}(S)$. Then the following commutative diagram of homeomorphisms shows that \tilde{x}_w is a deck transformation.

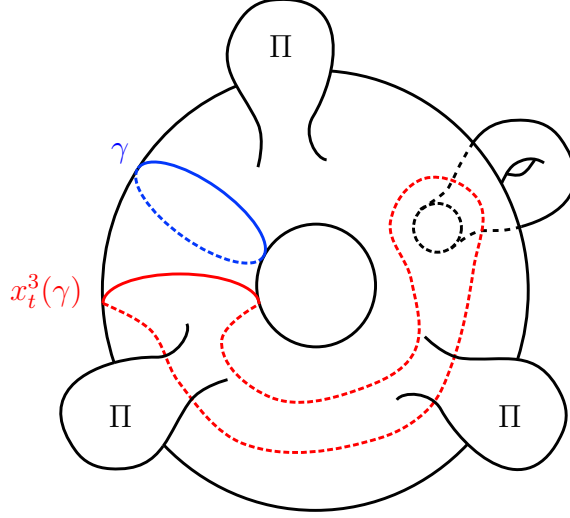

FIGURE 8. A surface S built from the Cayley graph of $\mathbb{Z}/3\mathbb{Z} = \langle t \rangle$. The curve γ is not homotopic to its image under x_t^3 due to the handle on the back of S .

$$\begin{array}{ccc}
 S_{\tilde{\Gamma}}(\Pi) & \xrightarrow{\tilde{x}_w} & S_{\tilde{\Gamma}}(\Pi) \\
 P \downarrow & & \downarrow P \\
 S_{\Gamma}(\Pi) & \xrightarrow{x_w = \text{id}} & S_{\Gamma}(\Pi)
 \end{array}$$

On the other hand, since \tilde{x}_w is a multipush, it moves every vertex surface of \tilde{S} at most k steps away from itself, a bounded distance. We claim this is a contradiction. Indeed, as the covering map sends vertex surfaces to vertex surfaces and edge surfaces to edge surfaces, respecting the edge labels in T , we see that any deck transformation of $P: \tilde{S} \rightarrow S$ is determined by a deck transformation of the covering $p: \tilde{\Gamma} \rightarrow \Gamma$. One readily checks that for any such nontrivial deck transformation and for all $j \geq 1$, there exists a vertex v in the tree $\tilde{\Gamma}$ such that the distance from v to its image is larger than j , and we have obtained our contradiction.

When $S \in \mathcal{B}$, it follows from Lemma 3.8 that there are countably many non-conjugate embeddings of the free group $\mathbb{F}_{|T|}$ in $\text{Map}(S)$. By the argument in Section 3.3, none of these embeddings lie in the isometry group for any hyperbolic metric on S . Finally, when S is not finite-type or the Loch Ness Monster (in which case $\overline{\text{Map}_c(S)} = \text{Map}(S)$), each multipush in the argument above is a collection of shift maps, so Remark 2.6 completes the proof. \square

It follows from the proof of Theorem 4.2 that the support of every non-trivial element of $\mathbb{F}_{|T|}$ is not contained in the union of the vertex surfaces. This is clear if w does not fix every Π_{Hg} , because the shift domains are contained in the support of x_w . On the other hand, suppose w fixes each Π_{Hg} . Since x_w is a collection of pushes, it therefore restricts to the identity on each vertex surface. However, the proof of the theorem shows that x_w is a non-trivial homeomorphism, and so the support of x_w cannot be contained in the union of the vertex surfaces. See Figure 10 for an example of what the image of a loop γ might look

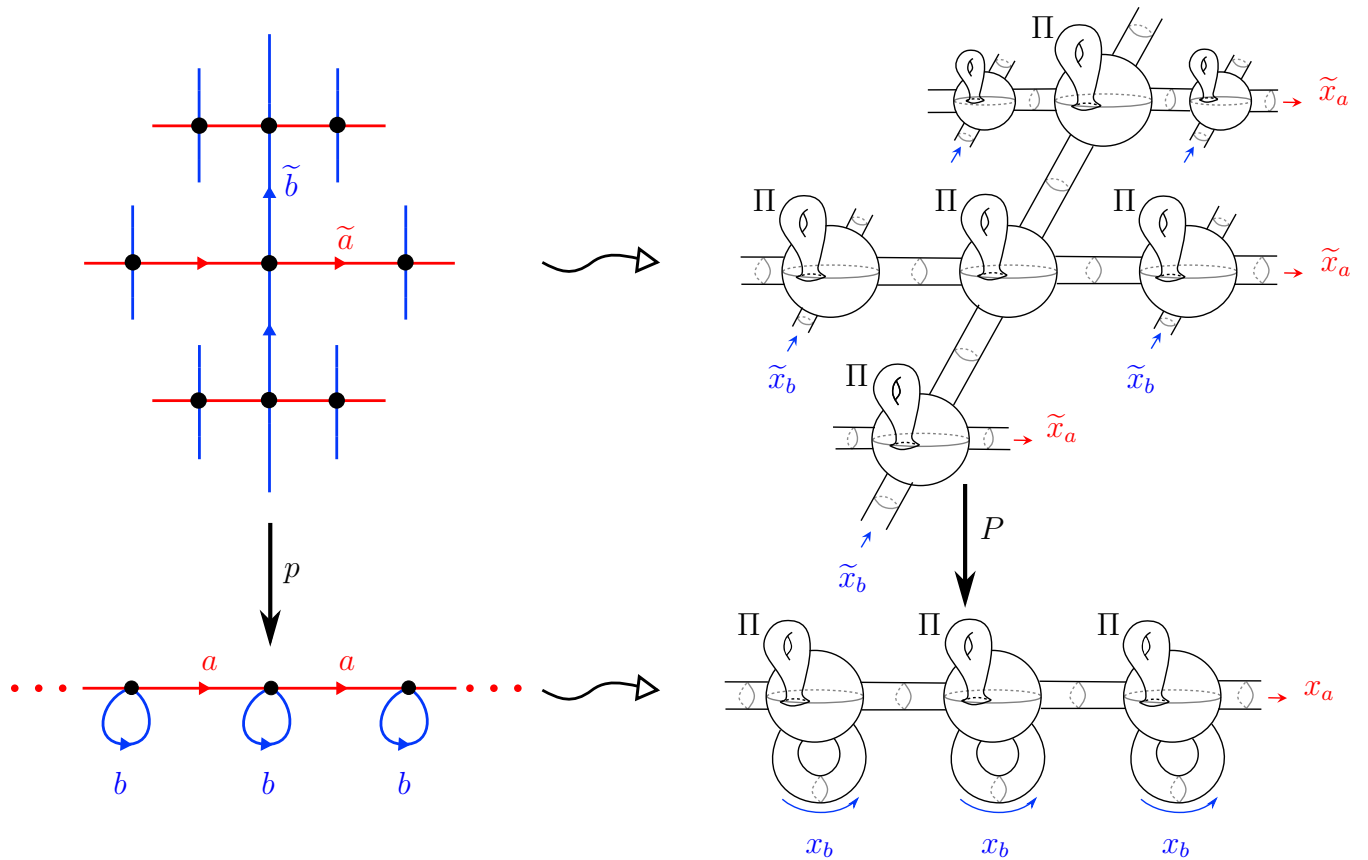

FIGURE 9. An example of the surface $\tilde{S} = S_{\tilde{F}}(\Pi)$ and lifts of multipushes x_a, x_b .

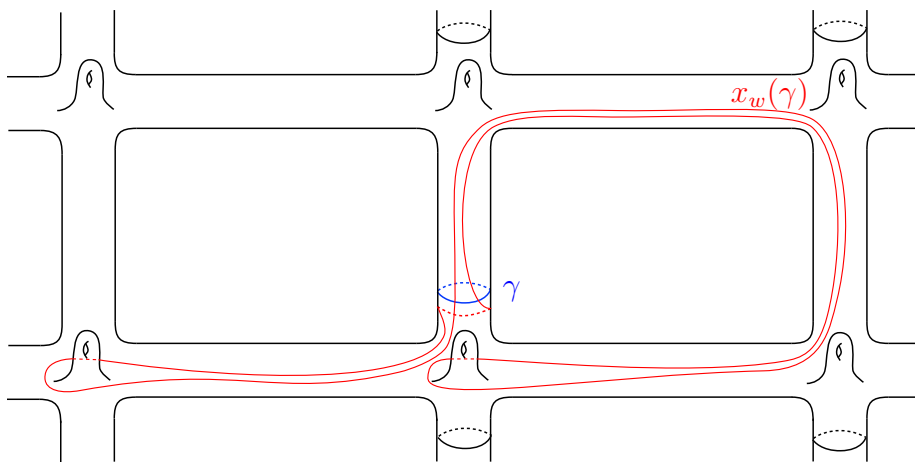

FIGURE 10. A portion of the Schreier surface for $(\mathbb{Z}^2, \{a, b\}, \{1\})$ and the image of the curve γ under the element $x_{bab^{-1}a^{-1}}$.

like after the application of x_w when w is trivial in G . This will be a crucial ingredient in the proof of Theorem 6.3.

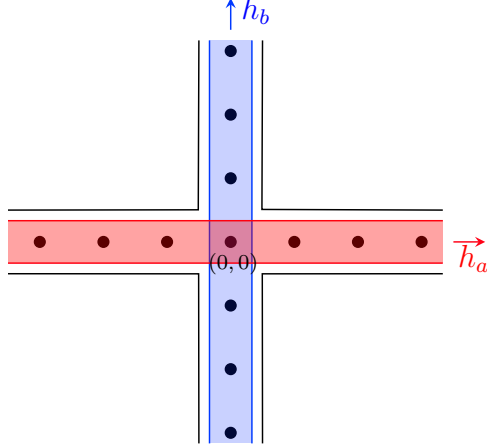

FIGURE 11. The shifts h_a and h_b do not generate a free group.

4.2. Shift Maps that do not generate a free group. The construction above uses a countable collection of intersecting push maps to ensure the resulting group is free. The following example demonstrates why this is necessary by showing that the group generated by two shift maps with minimal intersection is not free. We use the convention that $[x, y] = xyx^{-1}y^{-1}$ and choose a right action.

Let Γ be the four-ended tree with a single vertex of valence four and all other vertices of valence two. Identify Γ with the coordinate axes in \mathbb{R}^2 to get a labeling of the vertices as integer coordinates. Let Π be any surface with one boundary component that is not a disk, and construct the surface $S = S_\Gamma(\Pi)$. There is a horizontal shift h_a corresponding to the $+(1, 0)$ map on the x -axis and a vertical shift h_b corresponding to the $+(0, 1)$ map on the y -axis, as shown in Figure 11. The intersection of the supports of these shifts is contained in the front of $V_{(0,0)}$, the vertex surface at $(0, 0)$. It can be checked that the support of $[h_a, h_b]$ is contained in the fronts of $V_{(-1,0)}$, $V_{(0,0)}$, and $V_{(0,-1)}$ and the adjoining edge surfaces. The word $w = h_a h_b h_a^2$ maps $\{\Pi_{(0,-1)}, \Pi_{(-1,0)}, \Pi_{(0,0)}\}$ to the collection $\{\Pi_{(1,0)}, \Pi_{(2,0)}, \Pi_{(3,0)}\}$. Thus, the elements $[h_a, h_b]$ and $w[h_a, h_b]w^{-1}$ have disjoint supports and so commute. More generally, the words $w_n = h_a^{3n+1} h_b h_a^2$ map $\{\Pi_{(0,-1)}, \Pi_{(-1,0)}, \Pi_{(0,0)}\}$ to $\{\Pi_{(1+3n,0)}, \Pi_{(2+3n,0)}, \Pi_{(3+3n,0)}\}$. From this, we see that $H := \langle h_a, h_b \rangle$ is not a free group and actually contains copies of \mathbb{Z}^n for all n .

In fact, H is isomorphic to a 2-generated subgroup of an infinite strand braid group. To see this, note that the group structure of H is not dependent on the surface Π that we attach, so we may assume Π is a punctured disk. We can also realize each shift domains as a disk with countably many punctures with two distinct accumulation points on the boundary. Because braid groups are mapping class groups of punctured disks, this viewpoint allows us to realize H as a subgroup of the infinite strand braid group in which braids are allowed to have non-compact support. In particular, H is isomorphic to the subgroup of this braid group generated by the elements h_a and h_b , viewed as braids with non-compact support.

4.3. Wreath products. Recall that if H acts on a set Λ , then the (restricted) wreath product $G \wr_\Lambda H$ is defined as

$$G \wr_\Lambda H = G^\Lambda \rtimes_\gamma H,$$

that is, the semidirect product of H with the direct sum of copies of G indexed by Λ . Here, $G^\Lambda = \bigoplus_\Lambda G$ and is the set of $(g_\lambda)_{\lambda \in \Lambda}$. The automorphism $\gamma: H \rightarrow \text{Aut}(G^\Lambda)$ is defined by $\gamma(h)(G_\lambda) = hG_\lambda h^{-1} = G_{h\lambda}$, so that H acts on G^Λ by permuting the coordinates according to the action on the indices. When it is clear from context, or when $\Lambda = H$, we may simply write $G \wr H$.

We now construct a collection of wreath products in big mapping class groups. The most straightforward example of this construction is when S is a surface which admits a shift whose domain is an embedded copy of D_Π for some surface Π with one boundary component. For any $G \leq \text{Map}(\Pi)$, we generalize a construction of Lanier and Loving [LL20] to construct $G \wr \mathbb{Z}$ as a subgroup of $\text{Map}(S)$. When G is chosen to be the infinite cyclic group generated by a single Dehn twist, we recover [LL20, Theorem 4].

Proposition 4.3. *Let $G \leq \text{Map}(\Pi)$, where Π is a surface with a single boundary component. Let S be a surface and $H \leq \text{Map}(S)$ be generated by a collection of pushes and multipushes, all of whose domains are (unions of) embedded copies of A_Π or D_Π . Index the copies of Π in these domains by Λ . The wreath product $G \wr_\Lambda H$ is a subgroup of $\text{Map}(S)$.*

Proof. Let h_1, \dots, h_n be the generators of H , so Λ is a set indexing the copies of Π contained in the union of the domains of the h_i . Each h_i permutes the copies of Π in its domain and so acts on Λ : if $\lambda \in \Lambda$, then $h_i(\lambda)$ is defined to be the index of $h_i(\Pi_\lambda)$. This induces an action of H on Λ .

Let $G \leq \text{Map}(\Pi)$, and let $G_\lambda \cong G$ be the corresponding subgroup of $\text{Map}(S)$ supported on Π_λ . Whenever $\lambda \neq \lambda'$, the subgroups G_λ and $G_{\lambda'}$ have disjoint supports and commute, so $\langle G_\lambda \mid \lambda \in \Lambda \rangle = G^\Lambda$. For any $h \in H$ and $\lambda \in \Lambda$, we have $hG_\lambda h^{-1} = G_{h(\lambda)}$ and $H \cap G_\lambda = \{1\}$. Therefore, the subgroup of $\text{Map}(S)$ generated by $\langle H, G_\lambda \mid \lambda \in \Lambda \rangle$ is isomorphic to $G \wr_\Lambda H$. \square

We illustrate this proposition with several examples.

Example 4.4. Proposition 4.3 applies whenever S and H are one of the following.

- (1) Let S be a surface with an embedded copy of D_Π , and let H be generated by a (possibly one-ended) shift h , so that $H \cong \mathbb{Z}$. The index set Λ is simply \mathbb{Z} , and h acts on Λ as addition by 1.
- (2) Let S be a Schreier surface for a triple (A, T, B) such that $t_1, \dots, t_n \in T$ correspond to biinfinite geodesics in $\Gamma(A, T, B)$. Let H be the subgroup of $\text{Map}(S)$ generated by the multipushes x_{t_1}, \dots, x_{t_n} . By Theorem 4.2, $H \cong \mathbb{F}_n$. In this case, the index set Λ is the collection of right cosets $\{Ba \mid a \in A\}$. Each generator x_{t_i} acts on Λ as follows: if $Ba \in \Lambda$, then $x_{t_i} \cdot Ba = Bat_i$.
- (3) Let $S = S_\Gamma(\Pi)$ be the surface described in Section 4.2, and let $H = \langle h_a, h_b \rangle$ be the subgroup of $\text{Map}(S)$ constructed in that section. In this case, H is not free. The index set Λ is the set $\{(0, n), (n, 0) \mid n \in \mathbb{Z}\}$, and the generators h_a and h_b act on Λ as addition by $(1, 0)$ and $(0, 1)$, respectively.

When $S \in \mathcal{B}$, it follows from Lemma 3.8 that there are countably many non-conjugate embeddings of $G \wr H$ in $\text{Map}(S)$ for G, H as in the statements of Proposition 4.3. Moreover, none of these embeddings lie in the isometry group for any hyperbolic metric on S by the discussion in Section 3.3 or in $\overline{\text{Map}}_c(S)$ by Remark 2.6.

4.4. Solvable Baumslag-Solitar groups. For our third and final construction in this section, we focus on solvable Baumslag-Solitar groups. Fixing a positive integer n , recall

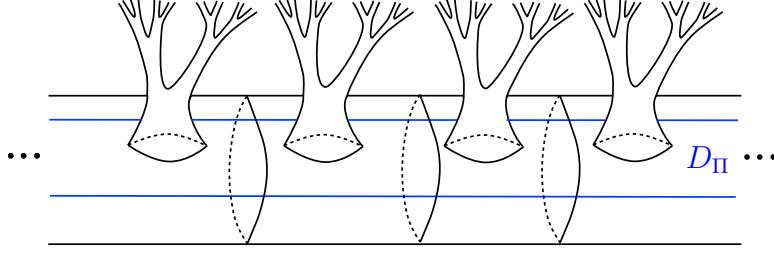

FIGURE 12. The most straightforward example of a surface S for which Theorem 4.5 shows that $BS(1, n) \leq \text{Map}(S)$ for all $n > 0$.

that the Baumslag-Solitar group $BS(1, n)$ is the group with presentation

$$BS(1, n) = \langle a, t \mid tat^{-1}a^{-n} \rangle.$$

The condition on the surface S in the following theorem involves a partial order on $E(S)$ and the notion of self-similarity of a set of ends. The precise definitions are not important for this paper; we only use that this condition implies that S admits a shift map of a Cantor set of ends [FPR22]. We refer the reader to [MR19] for precise definitions. The surfaces satisfying this condition include, for example, the Cantor tree, the blooming Cantor tree, and a Cantor tree with finite genus and finitely many punctures, but it is a much more general class of surfaces.

Theorem 4.5. *Let S be a surface such that $E(S)$ contains a self-similar subset that contains a Cantor set of maximal ends. Then $BS(1, n) \leq \text{Map}(S)$ for all $n > 0$.*

Proof. Let S be as in the statement of the theorem. By [FPR22, Lemma 3.4], the surface S admits a shift map h with domain D_Π , where Π is a surface with one boundary component that contains a Cantor set of maximal ends, called \mathcal{C} . Index the copies of Π in D_Π by \mathbb{Z} .

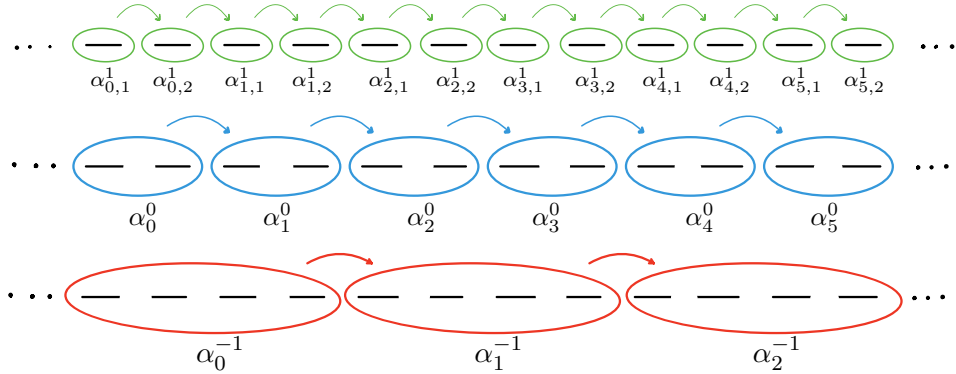

FIGURE 13. The curves for $k = -1, 0, 1$ when $n = 2$. The green, blue, and red arrows indicate ϕ_1, ϕ_0 , and ϕ_{-1} , respectively.

We will first construct a collection of homeomorphisms of Π . For each $k \in \mathbb{Z}$, we will define a collection of simple closed curves which divide \mathcal{C} into clopen sets. When $k = 0$, define an arbitrary countable collection of disjoint clopen sets of \mathcal{C} enclosed by a collection of simple closed curves $\{\alpha_i^0\}_{i \in \mathbb{Z}}$. When $k = 1$, for each i , divide the maximal ends contained

in α_i^0 into n clopen sets using simple closed curves $\alpha_{i,1}^1, \dots, \alpha_{i,n}^1$. Continue in this manner for all $k \geq 2$. When $k = -1$, for each $i \equiv 0 \pmod n$, let $l = i/n$ and let α_l^{-1} be a simple closed curve such that $\alpha_l^{-1}, \alpha_i^0, \alpha_{i+1}^0, \dots, \alpha_{i+n-1}^0$ cobound an $(n+1)$ -holed sphere. Thus, α_l^{-1} groups together the ends that are cut away by $\alpha_i^0, \alpha_{i+1}^0, \dots, \alpha_{i+n-1}^0$. Continue in this manner for all $k \leq -2$. See Figure 13.

We now define an element of $\text{Map}(\Pi)$ for each $k \in \mathbb{Z}$. The mapping class ϕ_0 is the shift that sends α_i^0 to α_{i+1}^0 for all $i \in \mathbb{Z}$. The mapping class ϕ_1 is the shift that sends $\alpha_{i,j}^1$ to $\alpha_{i,j+1}^1$ when $1 \leq j < n$ and $\alpha_{i,n}^1$ to $\alpha_{i+1,1}^1$. Define ϕ_k when $k \geq 2$ analogously. The mapping class ϕ_{-1} is the shift that sends α_l^{-1} to α_{l+1}^{-1} . Define ϕ_k for $k \leq -2$ analogously.

Let $\phi \in \text{Map}(S)$ be the element which simultaneously acts as ϕ_k on Π_k , the k -th copy of Π , for each $k \in \mathbb{Z}$ and as the identity elsewhere. Let $h \in \text{Map}(S)$ be the shift whose domain is D_Π . See Figure 12.

Let $f: BS(1, n) \rightarrow \text{Map}(S)$ be the map defined by $f(a) = \phi$ and $f(t) = h$. We will show that f is an isomorphism onto its image, i.e., $\text{Map}(S)$ contains an isomorphic copy of $BS(1, n)$.

For each $k \in \mathbb{Z}$, the mapping class $f(tat^{-1}) = h\phi h^{-1}$ first shifts Π_k to the left, applies ϕ , which now acts as ϕ_{k-1} on Π_k , and then shifts Π_k back to the right. By construction, ϕ_{k-1} applied to Π_i is equivalent to ϕ_k^n applied to Π_i . It follows that

$$f(tat^{-1}) = h\phi h^{-1} = \phi^n = f(a^n).$$

Therefore, f is a well-defined homomorphism.

Suppose there exists $g \in BS(1, n)$ such that $f(g)$ is the identity of $\text{Map}(S)$. Using the relation in $BS(1, n)$, the element g can be written as $g = t^i a^k t^{-j}$ for some $k \in \mathbb{Z}$ and $i, j \in \mathbb{Z}_{\geq 0}$. Since $f(g) = h^i \phi^k h^{-j}$ is the identity, it must fix each Π_i , and so we must have $i = j$. Consider the surface Π_0 . Then, $f(g)$ first shifts Π_0 to the left j times, applies ϕ^k (which acts as ϕ_{-j}^k on Π_{-j}), and then shifts back to Π_0 . The result is that $f(g)$ acts as the shift ϕ_{-j}^k on Π_0 . The only way that $f(g)$ can act as the identity on Π_0 is if $k = 0$. Thus, $g = t^i a^0 t^{-i} = 1$, and f is injective, as desired. \square

The construction above embeds solvable Baumslag-Solitar groups into mapping class groups of certain *infinite-type* surfaces. This is in contrast to the finite-type case, where $BS(1, n)$ is never a subgroup of the mapping class group due to the Tits alternative: every subgroup of such a mapping class group either contains a free subgroup or is virtually abelian [Iva84, McC85]. Since $BS(1, n)$ is solvable, it does not contain any free subgroups, but it is also not virtually abelian.

Note that the techniques in Section 3.2 show that given one embedding of $BS(1, n)$ into $\text{Map}(S)$, we can produce countably many non-conjugate copies of $BS(1, n)$ in $\text{Map}(S)$, but we must edit the surface Π to contain, for example, a single handle in order to satisfy the conditions in Definition 3.5. Once again, none of these embeddings lie in the isometry group for any hyperbolic metric on S by the discussion in Section 3.3 or in $\overline{\text{Map}}_c(S)$ by Remark 2.6.

We expect that a similar construction can be used to embed $BS(m, n)$ into $\text{Map}(S)$ when $m \neq 1$. However, the lack of a normal form for elements in $BS(m, n)$ significantly increases the complexity of the proof.

5. INDICABLE GROUPS

In this section, we give a general construction for embedding any indicable group which arises as a subgroup of a mapping class group of a surface with one boundary component into a big mapping class group in countably many non-conjugate and intrinsically infinite-type ways. We will need the following lemma in our construction.

Lemma 5.1. *A group G is indicable if and only if there exists a presentation $G = \langle T \mid R \rangle$ such that for each $r \in R$, the total exponent sum of r with respect to the generators T is zero.*

Before presenting the proof of the lemma, we give an example that motivates the argument. Consider the Baumslag-Solitar group $BS(1, n)$ with its standard presentation $BS(1, n) = \langle a, t \mid tat^{-1}a^{-n} \rangle$. This presentation does not have the desired property since the total exponent sum of the relator in the generators a and t is $1 - n$. However, there exists a homomorphism $f: BS(1, n) \rightarrow \mathbb{Z}$ defined by letting $f(a) = 0$ and $f(t) = 1$, so the lemma tells us that there must be a presentation of $BS(1, n)$ with the desired property. If we augment the generator a to be at instead, then

$$BS(1, n) = \left\langle at, t \mid (t \cdot at \cdot t^{-1} \cdot t^{-1}) \cdot \underbrace{t(at)^{-1} \cdots t(at)^{-1}}_{n \text{ times}} \right\rangle,$$

and the relator has zero total exponent sum in the generators at and t . In this presentation, the generators of $BS(1, n)$ both map to 1 under the homomorphism f , and we will use this property in the proof of the lemma.

Proof of Lemma 5.1. Given a group $G = \langle T \mid R \rangle$ with all relators having total exponent sum zero, there is a well-defined homomorphism $f: G \rightarrow \mathbb{Z}$ defined by sending each generator to $1 \in \mathbb{Z}$.

For the other direction, assume there exists a homomorphism $f: G \rightarrow \mathbb{Z}$, and let $N = \ker(f)$. Let $N = \langle V \mid W \rangle$ be a presentation for N , and let $a \in G$ be such that $f(a) = 1$. Then since $G/N \cong \mathbb{Z}$, the group G is generated by $T' = \{a\} \cup V$. If we augment the generators in $V \subseteq T'$ by a , then $T = \{a\} \cup \{av : v \in V\}$ is also a generating set for G . Importantly, the image of every one of these generators under f is $1 \in \mathbb{Z}$.

Let $G = \langle T \mid R \rangle$ be the presentation of G for the generating set T . If $r \in R$ is a relator, then r is a word in $\langle T \rangle$ that is the identity in G . Thus, $f(r) = 0$, and given that every element of T maps to $1 \in \mathbb{Z}$, the total exponent sum of r with respect to T must be zero. Therefore, $\langle T \mid R \rangle$ is one such desired presentation for G . \square

We can now begin our construction. Take any indicable group G that arises as a subgroup of $\text{Map}(\Pi)$, where Π is a surface with exactly one boundary component. Let h be a shift map on an infinite-type surface S whose domain is an embedded copy of D_Π in S . As discussed in Section 3, this includes a wide range of surfaces, including surfaces $S_\Gamma(\Pi)$ built from any graph with countable vertex set that contains a biinfinite path.

The most trivial way to embed G into $\text{Map}(S)$ is to let G act on one copy of Π in S . Indexing the copies of Π in D_Π by \mathbb{Z} and taking any subset of I of \mathbb{Z} , G can also act simultaneously on the subsurfaces Π_i of S for $i \in I$. Varying over all subsets of \mathbb{Z} gives an uncountable collection of copies of G in $\text{Map}(S)$. Unlike these embeddings, the construction

in the next theorem produces an uncountable collection of copies of G which do not lie in the isometry group of S , even if G lies in the isometry group of Π , and do not lie in $\overline{\text{Map}_c(S)}$, even if Π is compact. See Definition 3.5 for the definition of a distinguished surface and the family $\mathcal{C}(\Pi)$.

Theorem 5.2. *Let Π be a distinguished surface and $G \leq \text{Map}(\Pi)$ an indicable group. Given a surface $S \in \mathcal{C}(\Pi)$, there are countably many non-conjugate embeddings of G in $\text{Map}(S)$ such that no embedded copy is contained in $\overline{\text{Map}_c(S)}$ and no embedded copy is contained in the isometry group for any hyperbolic metric on S .*

Proof. Let $h \in \text{Map}(S)$ be a shift with domain D_Π , and let G be an indicable group. Fix a presentation $\langle T \mid R \rangle$ of G such that each $r \in R$ has total exponent sum zero with respect to T , which exists by Lemma 5.1. Since G is a subgroup of $\text{Map}(\Pi)$, G acts by homeomorphisms on each Π_i in D_Π . For each $g \in G$, let $\bar{g} \in \text{Map}(S)$ be the element that acts as g simultaneously on each Π_i in D_Π . We claim that the group generated by $\bar{T} = \{\bar{t}h : t \in T\}$ in $\text{Map}(S)$ is isomorphic to G . Let $\phi: F_T \rightarrow \langle \bar{T} \rangle \leq \text{Map}(S)$ be the surjective map defined by $t \mapsto \bar{t}h$ for all $t \in T$, where F_T is the free group on the generators T . We claim a word is in the kernel of this map if and only if it represents a trivial element in G .

Notice that h and \bar{t} commute as elements of $\text{Map}(S)$ so that for any word $w \in F_T$ with total exponent sum $k \in \mathbb{Z}$, the image $\phi(w)$ can be written as $\bar{w}h^k$. Thus, $\phi(w)$ acts trivially on S if and only if $k = 0$ and \bar{w} acts trivially on each copy of Π in S . The only elements w with this property are those that are trivial in G , and elements that are trivial in G have this property since products of conjugates of relators $r \in R$ have total exponent sum zero. Thus, the group G' generated by \bar{T} in $\text{Map}(S)$ is isomorphic to G .

Any element of G' that does not have total exponent sum zero with respect to \bar{T} is not in $\overline{\text{Map}_c(S)}$, since it must shift the surfaces Π_i . Remove finitely many copies of Π from the domain of h to obtain a new shift h'' , and construct the group $G'' = \langle \bar{t}h'' \mid t \in T \rangle \leq \text{Map}(S)$. This group G'' is isomorphic to G for the same reason that $G' \cong G$. By the same reasoning as in Section 3.2, the complements of the supports of G' and G'' are non-homeomorphic. In particular, G' and G'' are not conjugate. As in Lemma 3.8, this procedure produces countably many non-conjugate embeddings of G into $\text{Map}(S)$. Finally, no such embedding is contained in $\overline{\text{Map}_c(S)}$ by construction. \square

It was suggested to the authors by Mladen Bestvina that one can get around constructing the presentation in Lemma 5.1 for the indicable group G by working instead with the wreath product construction in Proposition 4.3. More specifically, let $f: G \rightarrow \mathbb{Z}$ be a surjection from the indicable group to \mathbb{Z} . Let Π be a surface with exactly one boundary component such that G arises as a subgroup of $\text{Map}(\Pi)$, and let S be a surface which admits a shift h with domain D_Π . For $g \in G$, let \bar{g} be the element which acts as g on each Π_i . Then, for $g \in G$, define a new map $\psi: G \wr \mathbb{Z} \leq \text{Map}(S)$ via $g \mapsto \bar{g}h^{f(g)}$. One readily checks that this map is an injective homomorphism by observing that the restriction of the image of G to $\bigoplus_{-\infty}^{\infty} G$ is the diagonal subgroup, and so the action of \mathbb{Z} is trivial. The embedding in the proof of Theorem 5.2 is exactly this map.

Theorem 5.2 applies to all subgroups constructed in Section 3. Another interesting class of examples produces embeddings of pure mapping class groups into a full mapping class group that are not induced by embeddings of the underlying surfaces.

The following corollary is immediate from Theorem 5.2 and work of Aramayona, Patel, and Vlamis [APV20, Corollary 6], which shows that the *pure* mapping class group of any surface with at least two nonplanar ends is indicable.

Corollary 5.3. *Let Π be an infinite-type surface with at least two nonplanar ends and exactly one boundary component. Given any surface S that admits a shift whose domain is D_Π , there exist uncountably many embeddings of $\text{PMap}(\Pi)$ into $\text{Map}(S)$ that are not induced by an embedding of Π into S . In addition, none of these embeddings preserve the notion of being compactly supported. When Π is a distinguished surface and $S \in \mathcal{C}(\Pi)$, countably many of these embeddings are non-conjugate.*

Corollary 5.3 is in line with a body of work aiming to find interesting homomorphisms between big mapping class groups. It also gives a natural set of examples of uncountable groups G to which one can apply Theorem 5.2. We note that determining which *full* mapping class groups are indicable is an important open question for both finite- and infinite-type surfaces. We now give a few examples of indicable big mapping class groups.

Examples 5.4. Mann and Rafi build continuous homomorphisms from finite-index subgroups of mapping class groups to \mathbb{Z}^k and to \mathbb{Z} in the proofs of [MR19, Lemma 6.7 & Theorem 1.7], respectively. To find surfaces whose full mapping class groups are indicable, we focus on the cases where the subgroup has index 1, a few of which we list below. We will define the homomorphism to \mathbb{Z} explicitly for example (1); the others are defined similarly.

- (1) Let Π be the surface with infinite genus whose end space is homeomorphic to the two-point compactification of \mathbb{Z} , that is, $E(\Pi) = \{-\infty\} \cup \mathbb{Z} \cup \{\infty\}$, where $E^g(\Pi) = \{\infty\}$. Let $A \subset E(\Pi)$ be the subset of ends corresponding to $-\mathbb{N}$, and let B be the subset of ends corresponding to $\{0\} \cup \mathbb{N}$. This surface is colloquially called the bi-infinite flute with one end accumulated by genus, and it admits a shift with domain D_Σ for a punctured disk Σ . A homomorphism $\ell: \text{Map}(\Pi) \rightarrow \mathbb{Z}$ can be defined by

$$\ell(\phi) = |\{x \in E \mid x \in A, \phi(x) \in B\}| - |\{x \in E \mid x \in B, \phi(x) \in A\}|.$$

The map ℓ counts the difference in the number of punctures mapped from negative to positive and punctures mapped from positive to negative. Note that the shift map mentioned above evaluates to 1 under ℓ , so the map ℓ is surjective.

- (2) Let Π be a surface of any genus whose end space consists of a Cantor set and $\{-\infty\} \cup \mathbb{Z} \cup \{\infty\}$, equipped with the same topology as in part (1), where the end $\{\infty\}$ is identified with a point in the Cantor set. The ends corresponding to $\{-\infty\} \cup \mathbb{Z} \cup \{\infty\}$ must all be planar or all nonplanar; the other Cantor set of ends can be planar or not. The homomorphism to \mathbb{Z} is defined as above, with sets $A = -\mathbb{N}$ and $B = \{0\} \cup \mathbb{N}$.
- (3) Let Π be the surface with infinite genus and end space $\mathbb{N} \cup \{\infty\}$, where only the ends corresponding to 1 and ∞ are nonplanar. This surface can be visualized as the ladder surface with punctures accumulating to one end. Here we can similarly define a homomorphism to \mathbb{Z} , which instead counts the number of genus that are moved across a simple closed curve separating the ends in E^G .

The common thread in the examples above is that the two ends of the shift map are of different topological types so that no element of $\text{Map}(\Pi)$ can exchange the two ends. This is the key fact necessary to ensure that the map ℓ above is a well-defined homomorphism of $\text{Map}(\Pi)$ and not of a proper subgroup of $\text{Map}(\Pi)$.

Each of the examples above can be modified to have exactly one boundary component. The third example can be extended to uncountably many more examples by replacing one of the isolated planar ends with a disk punctured by any closed subset of the Cantor set, of which there are uncountably many.

Moreover, in each case, Π is like a distinguished surface in the sense that if $S - D_\Pi$ has finitely many nonplanar ends in Cases (1) and (3), then $\text{Map}(S)$ can be used as the input for Theorem 5.2. In Case (2), if $S - D_\Pi$ has finitely many nonplanar (resp. planar) ends when the ends of $E(\Pi)$ corresponding to $\{-\infty\} \cup \mathbb{Z} \cup \{\infty\}$ are nonplanar (resp. planar), then $\text{Map}(S)$ can be used as the input for Theorem 5.2. Therefore, we can construct countably many non-conjugate embeddings of $\text{Map}(\Pi)$ into $\text{Map}(S)$ in all such cases.

6. COMBINATION THEOREM

In this section, we give a construction that takes as its input a set of indicable subgroups of mapping class groups of surfaces with one boundary component and outputs a new surface whose mapping class group contains a new indicable subgroup of intrinsically infinite type built from the original subgroups.

Definition 6.1. Given two subgroups H_1 and H_2 of groups G_1 and G_2 , respectively, the *free product of G_1 and G_2 with commuting subgroups H_1 and H_2* is

$$(G_1, H_1) \star (G_2, H_2) := (G_1 * G_2) / \langle\langle [H_1, H_2] \rangle\rangle.$$

More generally, the free product of G_1, \dots, G_n with commuting subgroups H_1, \dots, H_n is

$$(G_1, H_1) \star \cdots \star (G_n, H_n) := G_1 * \cdots * G_n / \langle\langle [H_i, H_j] : i \neq j \rangle\rangle.$$

These groups are a natural interpolation between free products (where the H_i are trivial) and direct products (where $H_i = G_i$ for all i). Free products with commuting subgroups arise in many natural contexts. For example, graph products of groups are a special kind of free product with commuting subgroups, where $H_i = G_i$ for some indices i and the remaining H_j are trivial.

We are interested in the case where the G_i are indicable groups and the H_i are the kernels of the surjections to \mathbb{Z} .

Lemma 6.2. *Let G_1, \dots, G_n be indicable groups with surjective maps $f_i: G_i \rightarrow \mathbb{Z}$, and let $H_i = \ker(f_i)$. Then the group $(G_1, H_1) \star \cdots \star (G_n, H_n)$ is also indicable.*

Proof. Let T_i be a generating set for G_i . Then there is a map $\phi: (G_1, H_1) \star \cdots \star (G_n, H_n) \rightarrow G_1$ defined by $\phi(t) = 1$ for each $t \in T_i$ with $i \neq 1$, and $\phi(t') = t'$ for each $t' \in T_1$. Here 1 is the identity element of G_1 . This map ϕ is a homomorphism which restricts to the identity on G_1 . By post-composing ϕ with f_1 , we obtain the desired map $(G_1, H_1) \star \cdots \star (G_n, H_n) \rightarrow \mathbb{Z}$. \square

We are now ready to prove our main combination theorem, of which Theorem 1.3 is a special case.

Theorem 6.3. *For $i = 1, \dots, n$, let S_i be a distinguished surface, and let Π be obtained from $\#_n S_i$ by capping off $n - 1$ boundary components. Let S be a Schreier surface in $\mathcal{C}(\Pi)$ for a triple (G, T, H) with $|T| = n$. Let G_i be an indicable group that embeds in $\text{Map}(S_i)$, fix a surjective map $f_i: G_i \rightarrow \mathbb{Z}$ for each i , and let $H_i = \ker f_i$. There are countably many non-conjugate embeddings of the indicable group $(G_1, H_1) \star \cdots \star (G_n, H_n)$ into $\text{Map}(S)$, none of which lie in $\overline{\text{Map}_c(S)}$.*

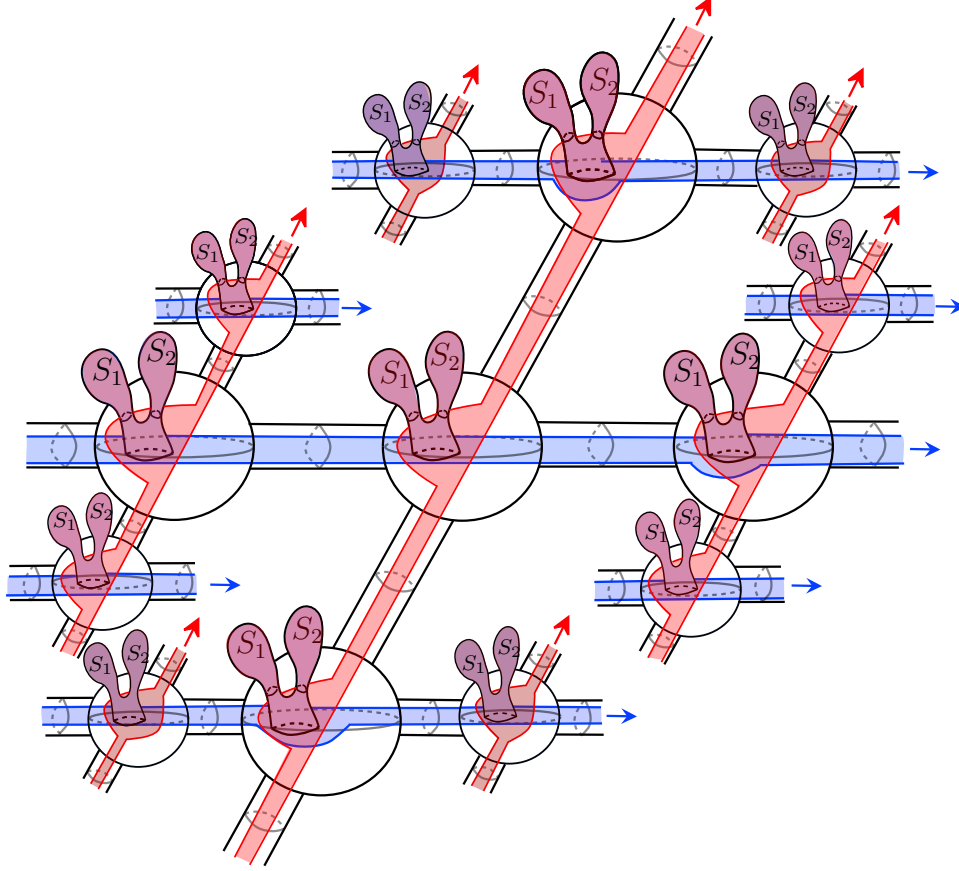

FIGURE 14. The domains of the two multipushes x_a (blue) and x_b (red) in the proof of Theorem 1.3 in the case that Γ is the Cayley graph of the free group generated by a and b .

Proof. We prove the theorem for $n = 2$ for simplicity of notation, but the same proof works for all n . Let a and b be two generators of G . By construction, S admits two multipushes x_a and x_b , where each acts as simultaneous pushes, as in Definition 3.3. See Figure 14.

By Lemma 5.1, each surjection $f_i: G_i \rightarrow \mathbb{Z}$ gives rise to a presentation $G_i = \langle T_i \mid R_i \rangle$ such that every $r \in R$ has total exponent sum zero with respect to T_i for $i = 1, 2$. Similarly to Theorem 5.2, for each $g \in G_i$, define an element $\bar{g} \in \text{Map}(S)$, where \bar{g} acts as g simultaneously on each copy of Π in the domains of x_a and x_b in S . For $i = 1, 2$, elements $g_i \in G_i$ act on the copies of S_i in Π , and the copies of S_1 and S_2 in each copy of Π are disjoint. Thus, \bar{g}_1 and \bar{g}_2 commute for any $g_1 \in G_1$ and $g_2 \in G_2$. Let $\bar{T}_1 = \{\bar{t}x_a : t \in T_1\}$ and let $\bar{T}_2 = \{\bar{t}x_b : t \in T_2\}$. We claim that the group generated by $\bar{T}_1 \cup \bar{T}_2$ in $\text{Map}(S)$ is isomorphic to $(G_1, H_1) \star (G_2, H_2)$.

For a set A , we let F_A denote the free group on generators A . Let $\phi: F_{\bar{T}_1 \cup \bar{T}_2} \rightarrow \langle \bar{T}_1 \cup \bar{T}_2 \rangle \leq \text{Map}(S)$ be the surjective map defined by $t \mapsto \bar{t}x_a$ for all $t \in T_1$ and $t \mapsto \bar{t}x_b$ for all $t \in T_2$. In order to show that $\langle \bar{T}_1 \cup \bar{T}_2 \rangle \leq \text{Map}(S)$ is isomorphic to $(G_1, H_1) \star (G_2, H_2)$, we must show that the kernel of ϕ is generated by all relators in $R_1 \cup R_2$ and the commutator $[H_1, H_2]$.

For any $t \in T_1 \cup T_2$, the element \bar{t} commutes with both x_a and x_b , and so we can write $\phi(w) = u\bar{w}$ where $u \in \langle x_a, x_b \rangle$. As in the proof of Theorem 5.2, if $r \in R_i$ for $i = 1, 2$, then $\phi(r)$ is the identity element in $\text{Map}(S)$, and so $R_1 \cup R_2 \subset \ker(\phi)$. Next, given $w_i \in H_i$,

we claim that $\phi(w_i) = \bar{w}_i$. This follows from the fact that the subgroup H_i is the kernel of f_i so that w_i has total exponent sum zero in the generators T_i . Therefore, $\phi(w_i)$ has total exponent sum zero with respect to \bar{T}_i . Since we can write $\phi(w_i) = u\bar{w}_i$, for $u \in \langle x_a \rangle$ when $i = 1$ and $u \in \langle x_b \rangle$ for $i = 2$, the total exponent sum zero condition implies that u is in fact trivial and $\phi(w_i) = \bar{w}_i$. The supports of w_1 and w_2 as elements of $\text{Map}(\Pi)$ are disjoint by the construction of Π so that the supports of \bar{w}_1 and \bar{w}_2 as elements $\text{Map}(S)$ are disjoint. Thus, these elements commute and the image $\phi(w_1w_2w_1^{-1}w_2^{-1}) = \bar{w}_1\bar{w}_2\bar{w}_1^{-1}\bar{w}_2^{-1}$ is the identity in $\text{Map}(S)$. It follows that $[H_1, H_2] \subset \ker(\phi)$.

Lastly, we show that if $w \in F_{T_1 \cup T_2}$ is in $\ker \phi$, then w is in the group generated by $R_1 \cup R_2 \cup [H_1, H_2]$. Fix any nontrivial w in $F_{T_1 \cup T_2}$ such that $\phi(w)$ acts as the identity on S , and write $\phi(w) = u\bar{w}$, where $u \in \langle x_a, x_b \rangle$. By Theorem 4.2, the group $\langle x_a, x_b \rangle$ is isomorphic to \mathbb{F}_2 . If u is non-trivial, then the support of u is not contained in the union of the vertex surfaces by the discussion at the end Section 4.1, while the support of \bar{w} is contained in the union of the vertex surfaces by definition. Thus, w could not be in $\ker(\phi)$, a contradiction. Therefore, $\phi(w) = \bar{w}$.

Since w is nontrivial by assumption, \bar{w} is a nontrivial word in the free group generated by $\{\bar{t} : t \in T_1 \cup T_2\}$. We will now show that since $\phi(w) = \bar{w}$ is the trivial homeomorphism and, therefore, acts trivially on each copy of Π , the element w is a product of elements in $[H_1, H_2]$ and $R_1 \cup R_2$.

There are natural maps from F_{T_i} to G_i and from $F_{T_1 \cup T_2}$ to $G_1 * G_2$. Decompose w as $w = c_1 d_1 \dots c_\ell d_\ell$ for some $\ell \geq 1$, where $c_j \in F_{T_1}$ and $d_j \in F_{T_2}$, and each c_j and d_j is non-trivial except possibly c_1 and d_ℓ . Then

$$\begin{aligned} \phi(w) &= \phi(c_1) \dots \phi(d_\ell) \\ &= x_a^{k_1} \bar{c}_1 x_b^{k_2} \bar{d}_1 \dots x_a^{k_{2\ell-1}} \bar{c}_\ell x_b^{k_{2\ell}} \bar{d}_\ell, \end{aligned}$$

so $u = x_a^{k_1} x_b^{k_2} \dots x_a^{k_{2\ell-1}} x_b^{k_{2\ell}}$. Since u is the trivial element in the free group $\langle x_a, x_b \rangle$, we must have $k_1 = k_2 = \dots = k_{2\ell} = 0$. In particular, using the fact that the surjections $f_i: G_i \rightarrow \mathbb{Z}$ send each element of T_i to 1, the image of each c_j under the natural maps defined above lies in $H_1 < G_1$, and the image of d_j lies in $H_2 < G_2$, for all $j = 1, \dots, \ell$. Thus, the image of w in $G_1 * G_2$ lies in $H_1 * H_2$. Moreover, because $\phi(w) \in \text{Map}(S)$ acts as the identity on every copy of S_1 and S_2 in S , the image of w under the projections from $H_1 * H_2$ to $H_i \leq G_i$ is trivial for $i = 1, 2$.

If $w = c_1$, the image of w in $G_1 * G_2$ lies completely in H_1 , and the fact that $\phi(w)$ acts trivially on S , and in particular on each copy of S_1 in S , means that $w \in R_1$. Similarly, if $w = d_1$, then $w \in R_2$. On the other hand, if the image of w is not completely contained in one factor of $H_1 * H_2$, then the fact the projections to each H_i are trivial, implies that $w \in [H_1, H_2]$. In all cases, we have proved that w is in the group generated by $R_1 \cup R_2 \cup [H_1, H_2]$.

We have shown that $(G_1, H_1) \star (G_2, H_2)$ embeds in $\text{Map}(S)$. As in the proof of Theorem 1.2, by removing finitely many copies of Π from the domains of x_a and x_b , we obtain countably many non-conjugate embeddings of $(G_1, H_1) \star (G_2, H_2)$ into $\text{Map}(S)$. By construction, no such embedding is contained in $\overline{\text{Map}_c(S)}$. \square

6.1. Constructing right-angled Artin groups. In this subsection, we describe how to use Theorem 1.3 to produce certain right-angled Artin groups A_Λ that embed in big mapping class groups in countably many non-conjugate ways. The groups A_Λ are never completely

contained in $\overline{\text{Map}_c(S)}$ and can never act by isometries for any hyperbolic metric on the infinite-type surface.

Theorem 1.3 produces embeddings of free products with commuting subgroups into $\text{Map}(S)$. In general, the free product of G_1 and G_2 with commuting subgroups H_1 and H_2 will not be finitely presented, even when the groups G_i are finitely presented. For example, consider the indicable group $\mathbb{F}_2 = \langle a, b \rangle$ with the map to \mathbb{Z} defined by $a \mapsto 1$ and $b \mapsto 0$. It is an exercise to see that the kernel K of this map is not finitely generated, see Exercise 7 of Section 1.A in [Hat02]. Therefore, if $G_1 = G_2 = \mathbb{F}_2$ and $H_1 = H_2 = K$, then $(G_1, H_1) \star (G_2, H_2)$ is a finitely generated but infinitely presented group.

However, there are instances where the free product of indicable groups with commuting subgroups is a recognizable finitely presented group. Let H_i be right-angled Artin groups with defining graphs Δ_i for $i = 1, \dots, n$, and let $G_i = \mathbb{Z} \times H_i$. The group $(G_1, H_1) \star \dots \star (G_n, H_n)$ is the right-angled Artin group defined by the graph shown in Figure 15.

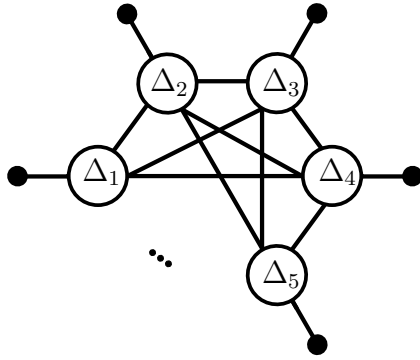

FIGURE 15. The lines between Δ_i and Δ_j signify that each vertex of Δ_i is adjacent to every vertex in Δ_j .

Examples 6.4. We now give some explicit examples of right-angled Artin groups arising as the free product with commuting subgroups $(G_1, H_1) \star (G_2, H_2)$. In each graph, the blue vertices correspond to generators of G_1 and the orange correspond to generators of G_2 .

- (1) Taking $G_1 = \mathbb{Z}^m$ and $G_2 = \mathbb{Z}^n$, we produce the right-angled Artin groups defined by the following graphs. Specifically, Figure 16 shows the defining graphs for $(\mathbb{Z}^2, \mathbb{Z}) \star (\mathbb{Z}^2, \mathbb{Z})$, $(\mathbb{Z}^3, \mathbb{Z}^2) \star (\mathbb{Z}^2, \mathbb{Z})$, $(\mathbb{Z}^3, \mathbb{Z}^2) \star (\mathbb{Z}^3, \mathbb{Z}^2)$ and a general schematic for the group $(\mathbb{Z}^{m+1}, \mathbb{Z}^m) \star (\mathbb{Z}^{n+1}, \mathbb{Z}^n)$.

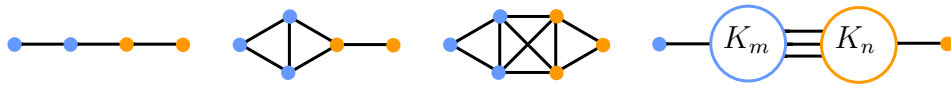

FIGURE 16.

- (2) Taking $G_1 = \mathbb{Z} \times \mathbb{F}_n$, $H_1 = \mathbb{F}_n$ and $G_2 = \mathbb{Z}^2$, with H_2 being one of the \mathbb{Z} factors, we produce the right-angled Artin groups defined by the following graphs. Specifically, Figure 17 shows the defining graphs for $n = 2$, $n = 3$, $n = 4$, and a schematic for general n .

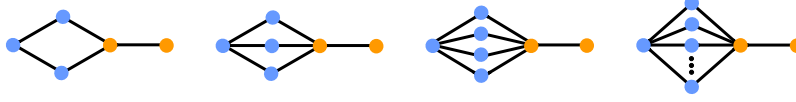

FIGURE 17.

- (3) Taking $G_1 = \mathbb{Z} \times \mathbb{F}_m$, $H_1 = \mathbb{F}_m$ and $G_2 = \mathbb{Z} \times \mathbb{F}_n$, $H_2 = \mathbb{F}_n$ we produce the right-angled Artin group defined by the graphs shown in Figure 18. These are the defining graphs for $m = n = 2$, $m = n = 3$, and a schematic for general m , n .

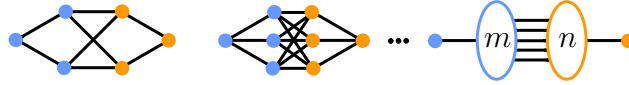

FIGURE 18.

Free products with commuting subgroups can also be used to construct free products of right-angled Artin groups with \mathbb{F}_n . We demonstrate this in the case $n = 2$ with the example below, using the fact that if Λ' is an induced subgraph of Λ , then the right-angled Artin group $A_{\Lambda'}$ is a subgroup of the right-angled Artin group A_{Λ} .

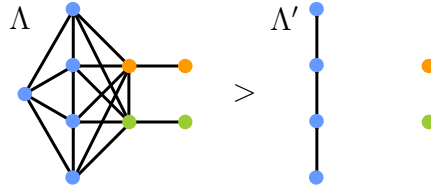

FIGURE 19. The induced subgraph Λ' of Λ corresponds to the right-angled Artin group $A_{\Lambda'} = A_{P_4} * \mathbb{F}_2$. This group can be found as a subgroup of the mapping class group of any surface in the collection \mathcal{B} .

Example 6.5. Let A_{Δ} be a right-angled Artin group. Let $G_1 = \mathbb{Z} \times A_{\Delta}$ and $G_2 = G_3 = \mathbb{Z}^2$. Denote by Λ the defining graph for $(G_1, A_{\Delta}) \star (\mathbb{Z}^2, \mathbb{Z}) \star (\mathbb{Z}^2, \mathbb{Z})$ given by Figure 15. Now, let Λ' be the induced subgraph on the vertices of Λ which are not adjacent to the copy of Δ in Λ , and the copy of Δ . The corresponding right-angled Artin group is $A_{\Lambda'} = A_{\Delta} * \mathbb{F}_2$. See Figure 19 for an example where $\Delta = P_4$, the path graph on four vertices.

We now show how to apply Theorem 1.3 to produce right-angled Artin subgroups of mapping class groups.

Corollary 6.6. *For any surface $S \in \mathcal{B}_{\infty}$ and any graph Λ from Examples 6.4 and Example 6.5, there are countably many non-conjugate embeddings of the right-angled Artin group A_{Λ} in $\text{Map}(S)$, such that no embedded copy is contained in $\overline{\text{Map}}_c(S)$ and such that no embedded copy is contained in the isometry group for any hyperbolic metric on S .*

Proof. We need to show that each of the groups G_i from Examples 6.4 and Example 6.5 arise as subgroups of mapping class groups of surfaces with one boundary component and

that, in each case, the subgroup H_i is the kernel of a surjection $G_i \rightarrow \mathbb{Z}$. The result will then follow immediately from Theorem 1.3.

The group \mathbb{Z}^m can be realized as a subgroup of the mapping class group of a surface S by considering the group generated by Dehn twists about m disjoint simple closed curves on S . The group $\mathbb{Z} \times \mathbb{F}_2$ is generated by suitably high powers of 2 independent partial pseudo-Anosov elements and a Dehn twist with disjoint support from both. Because \mathbb{F}_n is a subgroup of \mathbb{F}_2 for any n , the group $\mathbb{Z} \times \mathbb{F}_n$ is a subgroup of $\mathbb{Z} \times \mathbb{F}_2$. Thus, each of the groups G_i in Examples 6.4 and 6.5 can be found as subgroups of $\text{Map}(\Pi)$, where Π is a distinguished surface of sufficient topological complexity. Since every surface $S \in \mathcal{B}_\infty$ (see Definition 3.7) is built from a surface Π of infinite type, this condition on complexity is always satisfied.

Finally, in each example, the group G_i is the direct product of \mathbb{Z} and H_i , and so H_i is the kernel of the projection map onto the first factor. Thus, Theorem 1.3 applies, completing the proof of the corollary. \square

REFERENCES

- [ACCL20] Santana Afton, Danny Calegari, Lvzhou Chen, and Rylee Alanza Lyman. Nielsen realization for infinite-type surfaces. 2020. Preprint. arXiv: 2002.09760.
- [AIM] AIM Problem List: Surfaces of infinite type. available at <http://aimpl.org/genusinfinity>.
- [All06] Daniel Allcock. Hyperbolic surfaces with prescribed infinite symmetry groups. *Proc. Amer. Math. Soc.*, 134(10):3057–3059, 2006.
- [ALM21] Javier Aramayona, Christopher J. Leininger, and Alan McLeay. Homomorphisms between mapping class groups. 2021. Preprint. arXiv:2101.07188.
- [ALS09] Javier Aramayona, Christopher J Leininger, and Juan Souto. Injections of mapping class groups. *Geometry & Topology*, 13(5):2523–2541, 2009.
- [AMP] Carolyn Abbott, Nicholas Miller, and Priyam Patel. Infinite-type loxodromic isometries of the relative arc graph. In preparation.
- [APV] Tarik Aougab, Priyam Patel, and Nicholas G. Vlamis. Isometry groups of infinite genus hyperbolic surfaces. *Math. Ann.* To appear. arXiv:2007.01982.
- [APV20] Javier Aramayona, Priyam Patel, and Nicholas G. Vlamis. The first integral cohomology of pure mapping class groups. *Int. Math. Res. Not. IMRN*, (22):8973–8996, 2020.
- [AS13] Javier Aramayona and Juan Souto. Homomorphisms between mapping class groups. *Geometry & Topology*, 16(4):2285–2341, 2013.
- [BDR20] Juliette Bavard, Spencer Dowdall, and Kasra Rafi. Isomorphisms between big mapping class groups. *Int. Math. Res. Not. IMRN*, (10):3084–3099, 2020.
- [CLM12] Matt T. Clay, Christopher J. Leininger, and Johanna Mangahas. The geometry of right-angled Artin subgroups of mapping class groups. *Groups Geom. Dyn.*, 6(2):249–278, 2012.
- [FM12] Benson Farb and Dan Margalit. *A primer on mapping class groups*, volume 49 of *Princeton Mathematical Series*. Princeton University Press, Princeton, NJ, 2012.
- [FPR22] Elizabeth Field, Priyam Patel, and Alexander J. Rasmussen. Stable commutator length on big mapping class groups. *Bulletin of the London Mathematical Society*, 54(6):2492–2512, 2022.
- [Gro77] Jonathan L Gross. Every connected regular graph of even degree is a schreier coset graph. *Journal of Combinatorial Theory, Series B*, 22(3):227–232, 1977.
- [Hat02] Allen Hatcher. *Algebraic topology*. Cambridge University Press, Cambridge, 2002.
- [Iva84] N. V. Ivanov. Algebraic properties of the Teichmüller modular group. *Dokl. Akad. Nauk SSSR*, 275(4):786–789, 1984.
- [Ker23] B. v. Kerékjártó. *Vorlesungen über Topologie. I*. Spring, Berlin, 1923.
- [LL20] Justin Lanier and Marissa Loving. Centers of subgroups of big mapping class groups and the Tits alternative. *Glasnik Matematički*, 55:85–91, 06 2020.
- [Lub95] Alexander Lubotzky. Cayley graphs: eigenvalues, expanders and random walks. 1995.

- [McC85] John McCarthy. A “Tits-alternative” for subgroups of surface mapping class groups. *Trans. Amer. Math. Soc.*, 291(2):583–612, 1985.
- [MKS04] Wilhelm Magnus, Abraham Karrass, and Donald Solitar. *Combinatorial group theory*. Dover Publications, Inc., Mineola, NY, second edition, 2004. Presentations of groups in terms of generators and relations.
- [MR19] Kathryn Mann and Kasra Rafi. Large scale geometry of big mapping class groups. 2019. Preprint. arXiv: 1912.10914.
- [PM07] A. O. Prishlyak and K. I. Mischenko. Classification of noncompact surfaces with boundary. *Methods Funct. Anal. Topology*, 13(1):62–66, 2007.
- [PV18] Priyam Patel and Nicholas G. Vlamis. Algebraic and topological properties of big mapping class groups. *Algebr. Geom. Topol.*, 18(7):4109–4142, 2018.
- [Ric63] Ian Richards. On the classification of noncompact surfaces. *Trans. Amer. Math. Soc.*, 106:259–269, 1963.

DEPARTMENT OF MATHEMATICS, BRANDEIS UNIVERSITY, WALTHAM, MA 02543

Email address: carolynabbott@brandeis.edu

DEPARTMENT OF MATHEMATICS, UNIVERSITY OF MARYLAND, COLLEGE PARK, MD 20742

Email address: hoganson@umd.edu

DEPARTMENT OF MATHEMATICS, UNIVERSITY OF WISCONSIN-MADISON, MADISON, WI 53706

Email address: mloving2@wisc.edu

DEPARTMENT OF MATHEMATICS, UNIVERSITY OF UTAH, SALT LAKE CITY, UT 84112

Email address: patelp@math.utah.edu

DEPARTMENT OF MATHEMATICS, UNIVERSITY OF UTAH, SALT LAKE CITY, UT 84112

Email address: rachel.skipper@utah.edu