

A method for estimating the entropy of time series using artificial neural network

Andrei Velichko¹ and Hanif Heidari²

¹Institute of Physics and Technology, Petrozavodsk State University, 31 Lenina Str., 185910
Petrozavodsk, Russia,

²Department of Applied Mathematics, Damghan University, Damghan, P.O. Box 36715-364, Iran

Email:

A. Velichko velichko@petsu.ru

H. Heidari heidari@du.ac.ir, hanif.heidari@gmail.com

Abstract

Measuring the predictability and complexity of time series is an essential tool in designing and controlling the nonlinear system. Different entropy measures exist in the literature to analyze the predictability and complexity of time series. However, the existed methods have some drawbacks related to a strong dependence of entropy on the parameters of the methods, as well as on the length and amplitude of the time series. To overcome these difficulties, this study proposes a new method for estimating the entropy of a time series using the LogNNet neural network model. The LogNNet reservoir matrix is filled with the time series elements according to our algorithm. The network is trained on MNIST-10 dataset and the classification accuracy is calculated. The accuracy is considered as the entropy measure and denoted by NNetEn. The novelty of entropy calculation is that the time series is involved in mixing the input information in the reservoir. The greater complexity of the time series leads to the better ability of the neural network to learn, and to the higher classification accuracy and NNetEn values. The epochs number in the training process of LogNNet is considered as the control parameter. We introduce a new time series characteristic, called time series learning inertia, that determines the learning rate of the neural network. The robustness and efficiency of the method is verified on chaotic, periodic, random, binary and constant time series. The comparison of NNetEn with other methods of entropy estimation demonstrates that our method is more robust and accurate and can be widely used in practice.

Keywords: Entropy, time series, neural network, classification, MNIST-10 database, LogNNet.

1. Introduction

Measuring the regularity of dynamical system is one of hot topics in science and engineering. For example, it is used to investigate the health state in medical science [1][2], real time anomaly detection in the dynamical networks [3] and earthquake prediction [4]. Different statistical and mathematical methods are introduced to measure the degree of complexity in time series data, including Kolmogorov complexity measure [5], C_1/C_2 complexity measure [5] and entropy [6].

Entropy is a thermodynamics concept that measures the molecular disorder in a closed system. This concept is used in nonlinear dynamical systems to quantify the degree of complexity. Entropy is an interesting tool for analyzing the time series, as it does not consider any constraints on the probability distribution [7]. Shannon entropy (ShEn) and conditional entropy (ConEn) are the basic measures for evaluating the entropy. The ShEn and ConEn measure the amount of information and the rate of information generation, respectively [1]. Based on these measures, other entropy measures have been introduced for evaluating the complexity of time series. For example, Letellier used recurrence plots to estimate ShEn [8]. Permutation entropy (PerEn) is a popular entropy measure that investigates the permutation pattern in time series [9]. Pincus introduced the approximate entropy (ApEn) measure, which is commonly used in the literature [10]. Sample entropy (SaEn) is another entropy measure, which is introduced by Richman and

Moorman [11]. The ApEn and SaEn measures are based on ConEp. All these methods are based on the probability distribution and have shortcomings, such as sensitivity in short length time series [12], equality in time series [6] and lack of information related to the sample differences in amplitude [9]. To overcome these difficulties, many researchers attempted to modify the methods. For example, Azami and Escudero introduced fluctuation-based dispersion entropy to deal with the fluctuations of time series [1]. Letellier used recurrent plots to evaluate Shannon entropy in time series with noise contamination. Watt and Politi investigated the efficiency of PE method and introduced modifications to speed up the convergence of the method [13]. Molavipour et al used neural network to approximate the probabilities in mutual information equation, which is based on ShEn [14]. Deng introduced Deng entropy [15,16], which is the generalization of Shannon entropy. Martinez-Garcia et al applied deep recurrent neural network to approximate the probability distribution of the system outputs [17].

We propose a new method for evaluating the complexity of a time series that has completely different structure compared the other methods. It computes the entropy directly, without considering or approximating probability distributions. The proposed method is based on LogNNet, an artificial neural network model [18]. Velichko [16] showed a weak correlation between the classification accuracy of LogNNet and the Lyapunov exponent of the time series filling the reservoir. Subsequently, we found that the classification efficiency is proportional to the entropy of the time series [17], and this finding led to the development of the proposed method. LogNNet can be used for estimating the entropy of time series, as the transformation of inputs are done by the time series, and it affects the classification accuracy. More complex transformation of the input information, done by the time series in the reservoir part, results in higher classification accuracy in LogNNet. The accuracy is considered as the entropy measure and denoted as NNetEn. The model has advantages compared with the existing entropy-based methods.

The rest of the paper is organized as follows. Section 2 describes the structure of LogNNet and the methodology for calculating entropy. In addition, a new time series characteristic, called time series learning inertia, is described. The numerical examples and results are presented in Section 3. Section 4 summarizes the study with the discussion and future research ideas.

2. Methods

This study applies the LogNNet 784:25:10 model [16] to calculate the entropy value. LogNNet 784:25:10 model was designed to recognize the images of handwritten digits in the range 0-9 taken from the MNIST-10 dataset [18]. The database contains a training set of 60,000 images and a test set of 10,000 images. Each image has a size of $28 \times 28 = 784$ pixels and is presented in grayscale color.

2.1 LogNNet 784:25:10 model for entropy calculation

The model consists of two parts (see Fig. 1). The first part is the model reservoir that uses the matrix W_1 to transform the input vector Y into another vector S_h ($P = 25$). The second part of the model contains a single layer feedforward neural network that transforms vector S_h into digits 0-9 at the output layer S_{out} .

The algorithm has the following steps.

Step 1. The initial weights W_2 are set to 0.5. The constant initial weights ensure repeatable entropy results. The learning rate of back propagation method is set to 0.3 and the input images are transformed to the vectors array Y using T-pattern-3 [18].

Step 2. The reservoir matrix W_1 is constructed using the given time series (subsection 2.1.).

Step 3. The number of training epochs is set.

Step 4. The training process of the LogNNet 784:25:10 network is performed on a training set.

Step 5. The testing process of the LogNNet 784:25:10 network is performed on a test set and the classification accuracy is calculated.

Step 6. The value of NNetEn entropy is defined as follows:

$$\text{NNetEn} = \frac{\text{Classification accuracy}}{100\%} \quad (1)$$

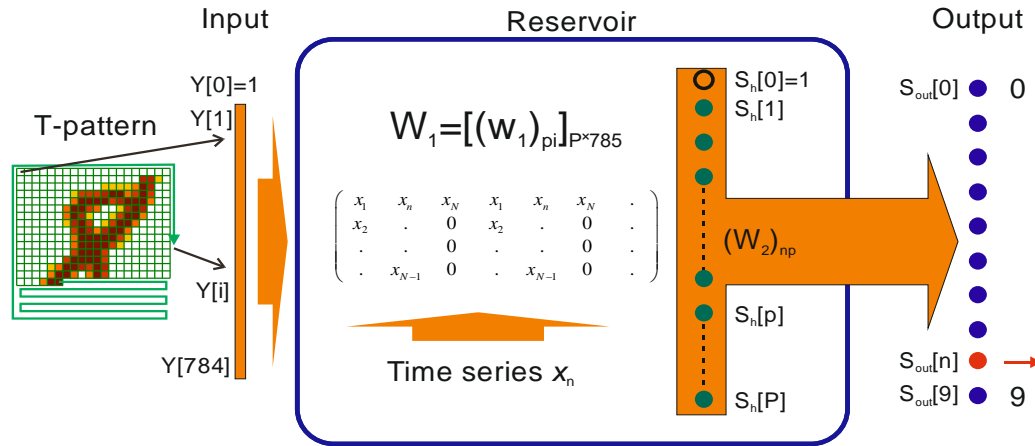

Fig. 1. The LogNNet model structure.

Therefore, the classification accuracy is considered as the new entropy measure, denoted as NNetEn (see Eq. (1)).

The classification accuracy distributed in the range from 0 to 100%, and NNetEn has the values between 0 and 1.

2.1 Matrix filling methods

Matrix W_1 contains 25 rows and 785 columns, and, therefore, requires 19625 elements. However, in real world problems, the length of the given time series can be either more or less than 19625 elements.

Let us suppose that we have a time series with N elements.

If $N \geq 19625$, it is necessary to ignore $N-19625$ elements of time series and fill the matrix with the remained 19625 elements, filling the matrix column by column. We suggest ignoring the first elements, as this may be the transient period of a dynamic process. Many mathematical and physical systems have the transient period before dynamics stabilizes. It also holds for discrete chaotic maps (Section 3).

If $N < 19625$, we propose a special method. This method implies column by column filling of the matrix W_1 . We set zero values for the remaining elements in the matrix row if the values are missing and row cannot be filled with the elements of the given time series. A schematic description of the method is given in Fig. 2a. As an example, a reduced matrix W_1 is filled with the series $x_n = n$, where n varies from 1 to 9 (Fig. 2b).

$$(a) \quad \begin{pmatrix} x_1 & x_n & x_N & x_1 & x_n & x_N & \cdot \\ x_2 & \cdot & 0 & x_2 & \cdot & 0 & \cdot \\ \cdot & \cdot & 0 & \cdot & \cdot & 0 & \cdot \\ \cdot & x_{N-1} & 0 & \cdot & x_{N-1} & 0 & \cdot \end{pmatrix} \quad (b) \quad \begin{pmatrix} 1 & 5 & 9 & 1 & 5 & 9 & 1 \\ 2 & 6 & 0 & 2 & 6 & 0 & 2 \\ 3 & 7 & 0 & 3 & 7 & 0 & 3 \\ 4 & 8 & 0 & 4 & 8 & 0 & 4 \end{pmatrix}$$

Fig. 2. The structure of matrix filling method (a); An example of time series with 9 elements (b).

3. Numerical results

To show the efficiency and robustness of the proposed method, we apply the method to the chaotic, random, periodic, binary and constant time series x_n with different lengths.

I. Discrete chaotic maps:

Because of the transient period, the first 1000 elements are ignored. The NNetEn measure is calculated for x_n where $n > 0$.

a) Logistic map:

$$x_{n+1} = r \cdot x_n \cdot (1 - x_n), \quad 1 \leq r \leq 4, \quad x_{.999} = 0.1, \quad (2)$$

b) Sine map:

$$x_{n+1} = r \cdot \sin(\pi \cdot x_n), \quad 0.7 \leq r \leq 2, \quad x_{.999} = 0.1, \quad (3)$$

c) Plank map:

$$x_{n+1} = \frac{r \cdot x_n^3}{1 + \exp(x_n)}, \quad 3 \leq r \leq 7, \quad x_{.999} = 4 \quad (4)$$

d) Henon map:

$$\begin{cases} x_{n+1} = 1 - r \cdot x_n^2 + y_n \\ y_{n+1} = r_1 \cdot x_n \end{cases}, \quad 0 \leq r \leq 1.4, \quad r_1 = 0.3, \quad x_{.999} = 0.1, \quad y_{.999} = 0.1 \quad (5)$$

II. Random discrete map:

$$x_n = \text{random} - 0.5 \quad (6)$$

III. Periodic discrete map:

$$x_n = A \cdot \sin\left(\frac{n \cdot 20\pi}{19625}\right) \quad (7)$$

IV. Binary discrete map:

$$\begin{aligned} x_n &= n \bmod 2 \\ x_n &= (1, 0, 1, 0, 1, 0, 1, 0, 1, \dots) \end{aligned} \quad (8)$$

V. Constant discrete map:

$$x_n = A \quad (9)$$

3.1 Calculation of NNetEn entropy measure

In this subsection, we consider time series with $N = 19625$ elements. To train the matrix W_2 , we used the number of epochs equal to 100.

The dependence of NNetEn on the control parameter r in the chaotic time series (Eqs. (2)-(5)) is presented in Figs. 7-10.

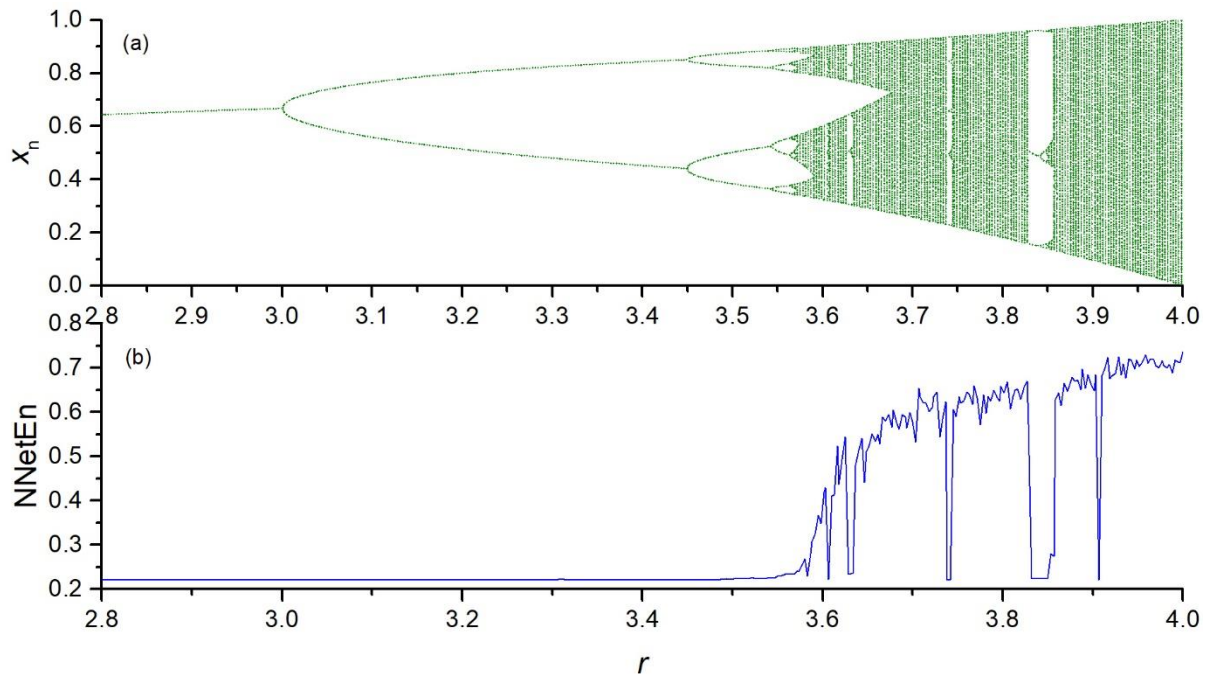

Fig. 3. Bifurcation diagrams for logistic map (Eq. (2)) (a); The dependence of NNetEn on the parameter r (number of epochs is 100) (b).

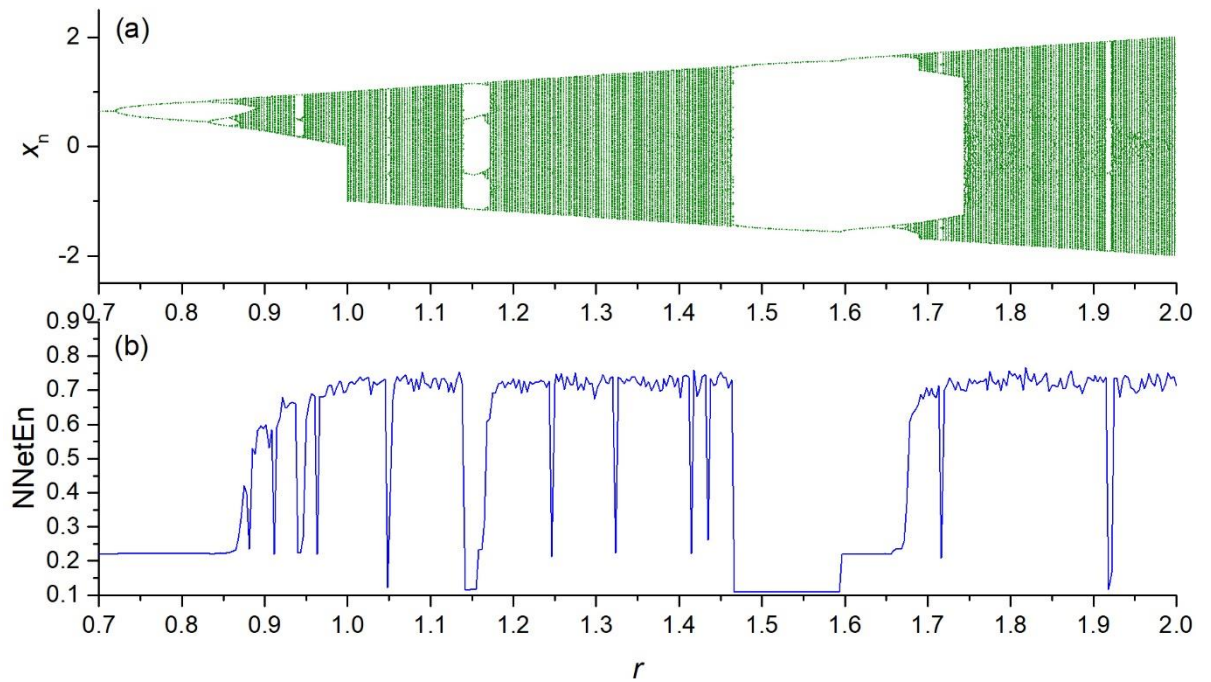

Fig. 4. Bifurcation diagrams for sine map (Eq. (3)) (a); The dependence of NNetEn on the parameter r (number of epochs is 100) (b).

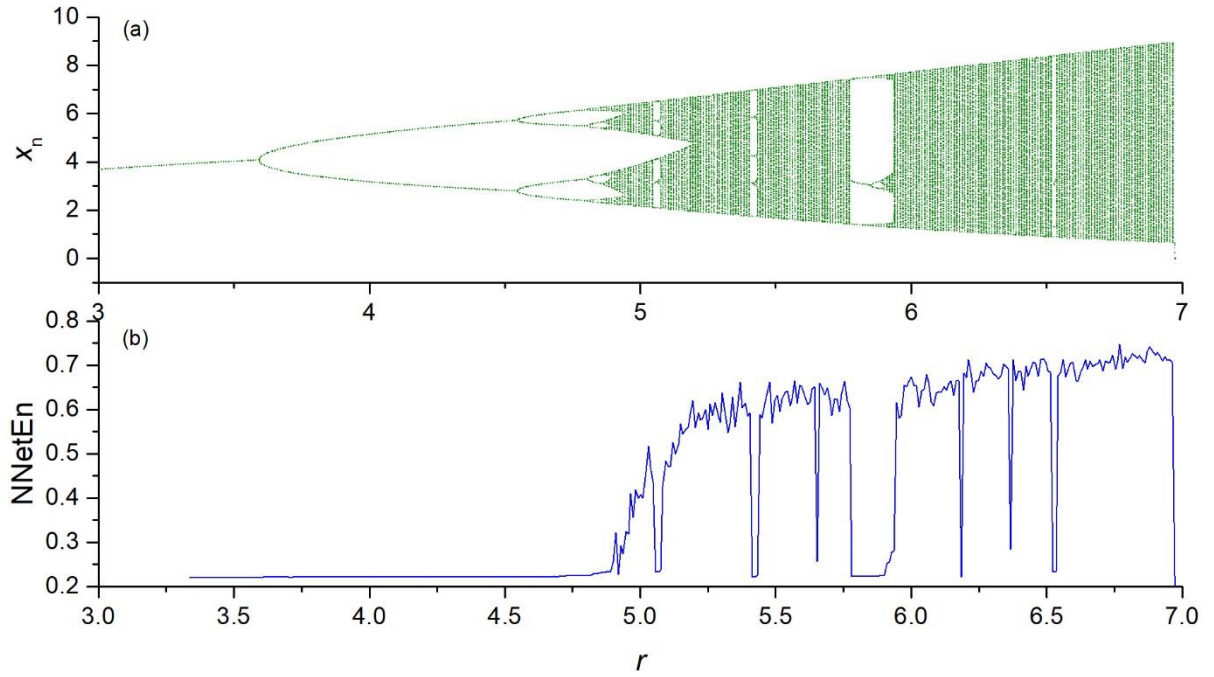

Fig. 5. Bifurcation diagrams for Planck map (Eq. (4)) (a); The dependence of NNetEn on the parameter r (number of epochs is 100) (b).

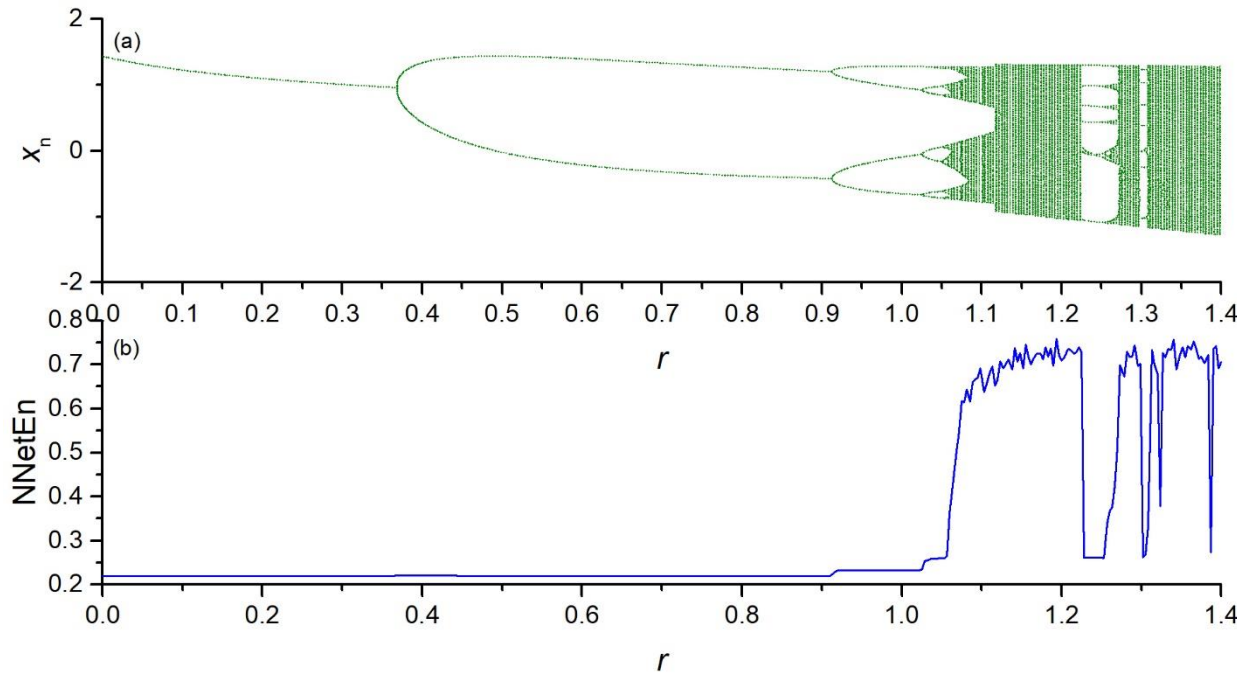

Fig. 6. Bifurcation diagrams for Hennon map (Eq. (5)) (a); The dependence of NNetEn on the parameter r (number of epochs is 100) (b).

For the random time series (Eq. (6)), the NNetEn equals to 0.744.

For the periodic time series (Eq. (7)), the NNetEn for different values of the parameter A is presented in the Fig. 7.a.

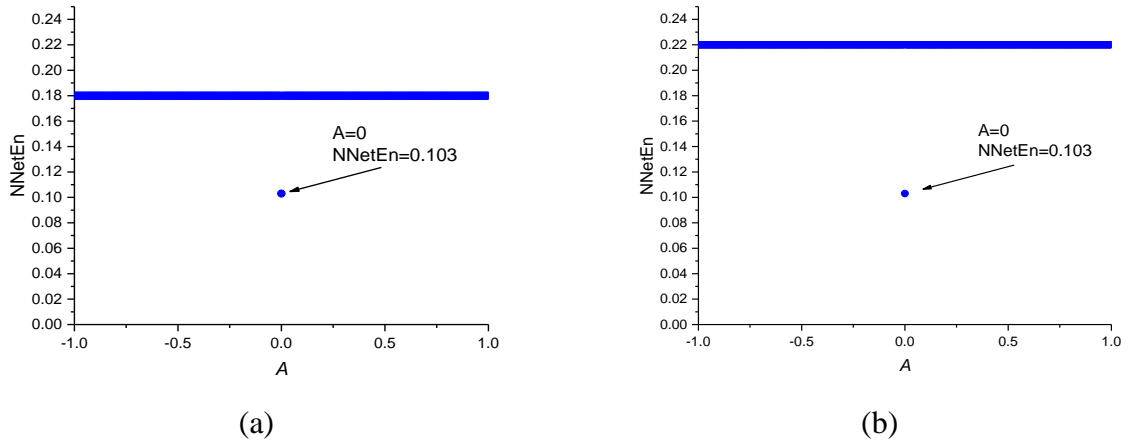

Fig. 7. The dependence of NNetEn on the parameter A for the periodic time series (Eq. (7)) (a); The dependence of NNetEn on the parameter A for constant time series (Eq. (9)) (b).

For the binary series described by Eq. (8), the NNetEn equals to 0.22.

The NNetEn values for constant time series are depicted in Fig. 7b. Entropy has the same value $\text{NNetEn} = 0.22$ for $|A| > 0$ and $\text{NNetEn} = 0.103$ for $A = 0$. Therefore, the lowest possible NNetEn value is about 0.1.

A comparison of NNetEn values for chaotic, random, periodic, and constant time series demonstrates that the NNetEn increases when the complexity of the time series increases. Therefore, there is a direct relation between the degree of complexity and NNetEn of time series. It confirms that NNetEn can be used for comparing the degree of complexity of a given time series. Another advantage of this methods is that NNetEn is independent of signal amplitude A . The entropy of the signal should not depend on the multiplication of the entire time series by a constant.

3.2 The influence of the number of training epochs on the NNetEn value

The influence of the number of epochs on the value of NNetEn was studied using a time series with $N = 19625$ elements, generated by the logistic mapping (Eq. (2)). The results are presented in the Fig. 8a.

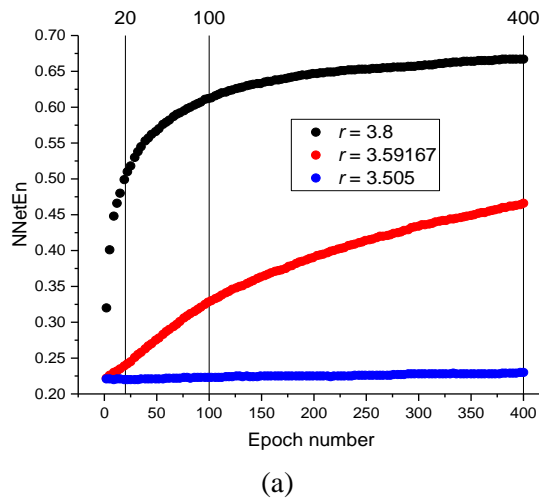

(a)

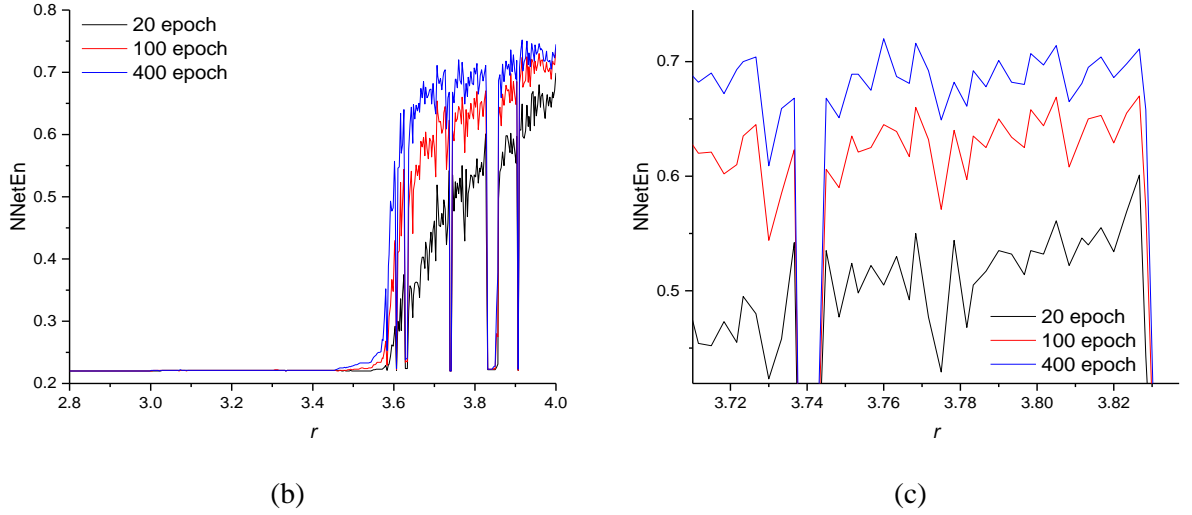

Fig. 8. The relation between NNetEn and the number of epochs for the time series on logistic map (Eq. (2)) (a); The dependence of NNetEn value on the parameter r using 20, 100 and 400 number of epochs (b); A magnification of subfigure (b) for r between 3.72 to 3.82 (c);

NNetEn gradually increases with increasing number of epochs till a plateau reached (Fig.8a). The speed of reaching the plateau depends on the type of signal. For example, the velocity of reaching the plateau at $r = 3.59167$ is slower than at $r = 3.8$ and $r = 3.505$. The Fig. 8(b) shows the dependence of NNetEn on the parameter r for different numbers of epochs. The trends are similar, although there are differences in details. The behaviors of NNetEn with 100 epochs and 400 epochs is more similar than NNetEn with 20 epochs and 400 epochs (Fig. 8c). This example demonstrates that a significant number of epochs is required for reaching the plateau in NNetEn, especially in chaotic time series. Therefore, it is necessary to indicate the number of epochs as a parameter of the model.

3.3 Learning inertia as a new characteristic of time series

To identify the speed of NNetEn convergence to plateau with respect to number of epochs, the parameter $\delta_{Ep1/Ep2}$ is proposed

$$\delta_{Ep1/Ep2} = \frac{\text{NNetEn}(Ep2 \text{ epoch}) - \text{NNetEn}(Ep1 \text{ epoch})}{\text{NNetEn}(Ep2 \text{ epoch})} \quad (10)$$

where $Ep1$ and $Ep2$ ($Ep1 < Ep2$) are the numbers of epochs used in calculating the entropy.

The parameter reflects the rate of change in NNetEn values when the number of epochs is decreased from $Ep2$ to $Ep1$. Figs. 9 demonstrates the dependence of $\delta_{100/400}$ on the parameter r in the logistic map (Eq. (2)). The maximum $\delta_{100/400}$ occurs at $r = 3.59167$. It means that the neural network has the lowest learning rate at $r = 3.59167$.

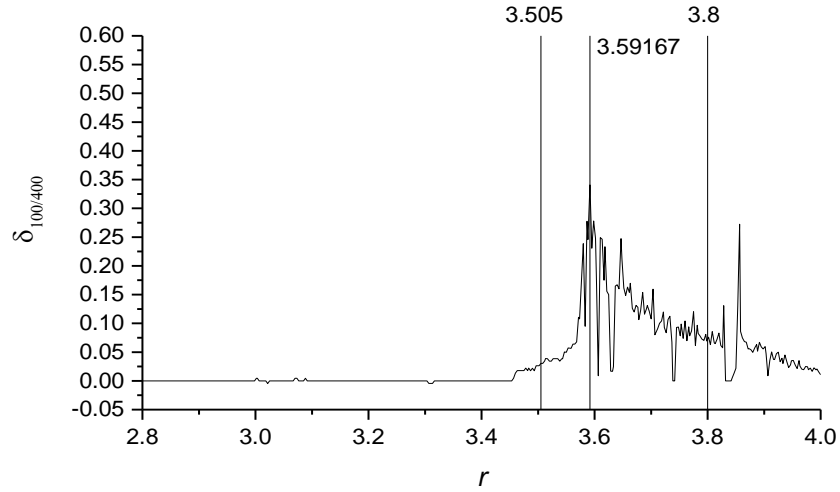

Fig. 9. The parameter $\delta_{100/400}$ (learning inertia) in relation to the parameter r .

The parameter $\delta_{Ep1/Ep2}$ can be considered as a new characteristic of the input time series and is named “learning inertia”.

3.4 Calculation of NNetEn entropy with variation in the length of the time series N .

Data obtained from financial markets [19], physical experiments [12,20] and biological or medical data [11,21] may have $N < 19625$ elements. To investigate the efficiency and stability of the matrix filling method (see paragraph 2.1), the method was applied on different types of time series with different N . The epochs number is set to 100 in this subsection.

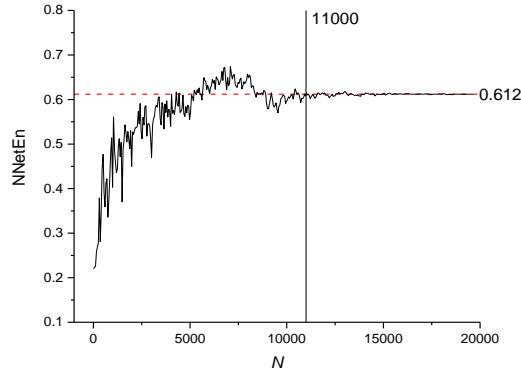

Fig. 10. The effect of time series length on NNetEn values for time series based on logistic map (Eq. (2)).

The NNetEn values for time series based on logistic map with $r=3.8$ and various number of elements (N) are presented in Fig. 10. The dashed red line indicates the reference level corresponding to NNetEn with $N = 19625$. A decrease in N below 19625 should not lead to a significant change in entropy relative to the reference level. The method of entropy measurement is the most stable for $N \geq 11000$, when the NNetEn values almost coincide with the reference level. For $N < 11000$, the dependence of NNetEn on N is observed, and it is reflected in the appearance of fluctuations in NnetEn relative to the reference level.

The NNetEn values for sine periodic map (Eq. (7)) and binary map (Eq. (8)) with various number of elements (N) are presented in Figs. 11 and 12, respectively.

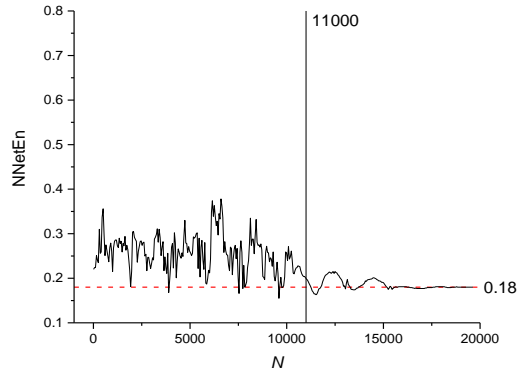

Fig. 11. The effect of time series length on NNetEn values for sine periodic time series (Eq. (7)).

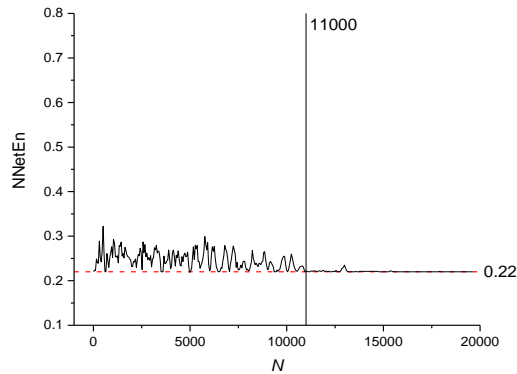

Fig. 12. The effect of time series length on NNetEn for binary time series (Eq. (8)).

It can be concluded that for all types of signals considered, the most stable result is obtained for $N > 11000$.

3.5 A comparison between the NNetEn measure and other entropy methods

A comparison between NNetEn (number of epochs is 100) and ApEn entropy values for the logistic map time series at $N = 19625$ is depicted in Fig. 13. Variables rr and m are the main parameters of ApEn [10]. Dependencies of NNetEn and ApEn on r almost repeat each other, except for some features. To describe these features, the following labels have been introduced: $r_1 = 3.60666667$, $r_2 = 3.68833333$, $r_3 = 3.835$ and $r_4 = 3.94833333$. The value of entropy has a local minimum for NNetEn and ApEn ($rr = 0.025$, $m = 2$) at $r = r_1$, while ApEn ($rr = 0.1$, $m = 2$) reaches a local maximum in this point. It demonstrates that ApEn is very sensitive in its parameters (rr and m). The proposed method resolves this problem, and the position of the minimum does not depend on the parameter of method. In addition, the proposed method is compared with other entropy measures (Table 1). All entropies have increasing r trend, and the entropy at $r = r_1$ is less than the entropy at $r = r_4$. All entropies have minimum at $r = r_1$ and maximum at $r = r_4$. Therefore, the entropy NNetEn gives similar results, like other methods for calculating entropy, while has the advantage of a small number of parameters and high computational stability, independent of the signal amplitude and the length of the time series.

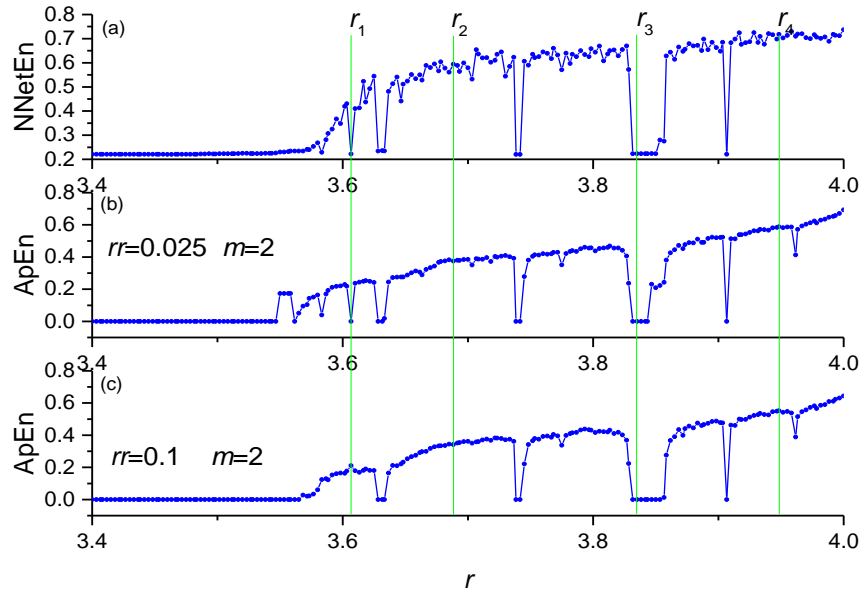

Fig. 13. A comparison between NNetEn and ApEn for the logistic mapping. NNetEn (number of epochs is 100) (a); ApEn ($rr = 0.025$, $m = 2$) (b); ApEn ($rr = 0.1$, $m = 2$) (c).

Table 1. Comparison between the NNetEn and other entropy measures.

	$r_1 = 3.60666667$	$r_2 = 3.68833333$	$r_3 = 3.835$	$r_4 = 3.94833333$
NNetEn Entropy	0.222	0.594	0.223	0.718
ApEn [10], $rr = 0.025$, $m = 2$	0	0.374	0	0.588
ApEn [10], $rr = 0.1$, $m = 2$	0.210	0.341	0	0.552
Topological entropy [22]	1.16	1.21	0.61	1.21
SampEn [1]	0.067	0.287	0	0.49
PerEn [1]	0.45	0.53	0.347	0.71
DispEn [1]	0.45	0.649	0.308	0.683
Shannon entropy from recurrence plots [8]	0.85	1.79	0.1	2.29
Shannon entropy from symbolic dynamics [8]	2.45	4.81	1.15	6.97

4. Discussion and future research

Investigating the complexity of non-linear time series becomes a hot topic in recent years, as it has many practical applications. Various entropy measures have been introduced to calculate the complexity of the given time series. However, almost all existing methods are based on Shannon entropy or conditional probability that suffers of sensitivity to the length of time series and its initial parameters. We propose NNetEn entropy measure to overcome these difficulties. NNetEn is an estimation method based on MNIST-10 classification using LogNet 784:25:10 neural network. Its calculation algorithm is different from other existing methods. NNetEn

algorithm needs a reservoir matrix with 19625 elements filled with time series. As many practical applications use the time series with $N < 19625$ elements, we propose a method for filling the matrix with $N < 19625$. The chosen method provides the most stable results for calculating NNetEn in comparison with similar methods of filling the matrix by rows or by stretching a row.

In the future studies, it is possible to investigate other network configurations with a different number of neurons, and it can lead to a change in the number of elements in the reservoir matrix. Nevertheless, the presented method of using LogNet 784:25:10 has the promising opportunities for practical application and may be of interest to the scientific community.

Figures 10-12 demonstrate that there are entropy modulations due to changes of time series length in the matrix fillings method. This is caused by the shift of the time series relative to the rows in the W_1 matrix.

The method is the most stable at $N \geq 11000$, when the NNetEn values almost coincide with the reference level. In practice, when comparing time series, we recommend using time series of the same length and, if possible, $N \geq 11000$.

The proposed method is applied on constant, binary, periodic and various chaotic time series. The results demonstrate that the NNetEn value lies between 0.1 and 1. The lower limit of NNetEn is 0.1, as the minimum classification accuracy is 10%. This is achieved when the images of the digits are recognized from 10 random options.

The NNetEn value converges on a plateau with the increase in the number of epochs. The number of epochs is considered as the input parameter of the method. The behavior of NNetEn values is approximately similar for the logistic map with the number of epochs 100 and 400. Therefore, we use 100 epochs in LogNet and suggest using at least 100 epochs in other examples.

In section 3.3, the parameter $\delta_{Ep1 / Ep2}$ is introduced to compare the effect of the number of epochs on NNetEn values. This parameter can be considered as a new characteristic of the input time series. We call it the learning inertia of the time series. This parameter characterizes the speed of training of a network for the given time series. Small values of $\delta_{Ep1 / Ep2}$ correspond to the rapid achievement of a plateau by NNetEn values with the increasing the number of epochs. The parameter $\delta_{Ep1 / Ep2}$ may depend on the initial distribution of the matrix W_2 elements or on the learning rate of the backpropagation method. Fig. 9 shows the bursts at the border of the order-chaos regions. Further study of the learning inertia of time series for various signals and the study of transitions from order to chaos may become the topics for the further research.

The proposed model has the following advantages compared to the existing entropy measurement methods:

- It is simple to use.
- It has one control parameter - the number of epochs, when training the network.
- Scaling the time series by amplitude does not affect the value of entropy
- It can be used for a series of any length. The most repeatable results are observed when N varies in the range $N = 11000-19626$.
- It outperforms the existing methods.
- The new characteristic of the time series is introduced - learning inertia. It can be used to identify additional patterns in the dynamics of the time series.

For example, the study [1] introduced a method of entropy estimation depending on the embedded dimension m , time delay d and constant value c . Any changes in these parameters lead to the different results. In contrast, the proposed method depends only on the number of epochs, and the position of the minima and maxima does not depend on the number of epochs.

Extending the current study to the multivariable time series can be considered as another direction for the future work. In addition, it would be beneficial to apply the method of calculating NNetEn in practice to process data from medical, physical, biological, and geophysical

experiments. The use of neural networks for calculating entropy and other characteristics of time series can become a promising scientific direction.

4. Conclusion

The study proposes a new entropy measure called NNetEn for evaluating the complexity of the given time series. NNetEn is the first entropy measure, which is based on artificial intelligence methods. The method modifies the structure of LogNet classification model in a way that the classification accuracy of MNIST-10 digits dataset indicates the degree of complexity of the given time series. The calculation results of the proposed model are similar to the existing methods, while the model structure is completely different and provides considerable advantages. For example, it overcomes such difficulties as the method sensitivity to the length and amplitude of time series. The method has only one input parameter and is easier to use that is important in practical applications. In addition to the method for measuring entropy, an equation for calculating a new characteristic of a time series, learning inertia, is given. The study results can be widely applied in practice and be of interest to the scientific community.

Acknowledgments: Authors express their gratitude to Andrei Rikkiev for the valuable comments in the course of the article's translation and revision.

References

- [1] H. Azami, J. Escudero, Amplitude- and Fluctuation-Based Dispersion Entropy, *Entropy* . 20 (2018). <https://doi.org/10.3390/e20030210>.
- [2] B. Yan, S. He, K. Sun, Design of a network permutation entropy and its applications for chaotic time series and EEG signals, *Entropy*. 21 (2019) 1–18. <https://doi.org/10.3390/e21090849>.
- [3] S.E. Benkabou, K. Benabdeslem, B. Canitia, Unsupervised outlier detection for time series by entropy and dynamic time warping, *Knowl. Inf. Syst.* 54 (2018) 463–486. <https://doi.org/10.1007/s10115-017-1067-8>.
- [4] A. Ramírez-Rojas, L. Telesca, F. Angulo-Brown, Entropy of geoelectrical time series in the natural time domain, *Nat. Hazards Earth Syst. Sci.* 11 (2011) 219–225. <https://doi.org/10.5194/nhess-11-219-2011>.
- [5] Y. Li, Y. Fan, Complexity measure applied to the analysis EEC signals, *Annu. Int. Conf. IEEE Eng. Med. Biol. - Proc.* (2005) 4610–4613. <https://doi.org/10.1109/iembs.2005.1615497>.
- [6] L. Zunino, F. Olivares, F. Scholkmann, O.A. Rosso, Permutation entropy based time series analysis: Equalities in the input signal can lead to false conclusions, *Phys. Lett. Sect. A Gen. At. Solid State Phys.* 381 (2017) 1883–1892. <https://doi.org/10.1016/j.physleta.2017.03.052>.
- [7] Y. Yin, P. Shang, Weighted permutation entropy based on different symbolic approaches

- for financial time series, *Phys. A Stat. Mech. Its Appl.* 443 (2016) 137–148.
<https://doi.org/10.1016/j.physa.2015.09.067>.
- [8] C. Letellier, Estimating the Shannon Entropy: Recurrence Plots versus Symbolic Dynamics, *Phys. Rev. Lett.* 96 (2006) 254102.
<https://doi.org/10.1103/PhysRevLett.96.254102>.
- [9] D. Cuesta-Frau, Permutation entropy: Influence of amplitude information on time series classification performance, *Math. Biosci. Eng.* 16 (2019) 6842–6857.
<https://doi.org/10.3934/mbe.2019342>.
- [10] S.M. Pincus, Approximate entropy as a measure of system complexity, *Proc. Natl. Acad. Sci.* 88 (1991) 2297–2301.
- [11] J.S. Richman, J.R. Moorman, Physiological time-series analysis using approximate entropy and sample entropy maturity in premature infants Physiological time-series analysis using approximate entropy and sample entropy, *Am. J. Physiol. Hear. Circ. Physiol.* 278 (2000) H2039–H2049.
- [12] J. Keum, P. Coulibaly, Sensitivity of Entropy Method to Time Series Length in Hydrometric Network Design, *J. Hydrol. Eng.* 22 (2017) 4017009.
[https://doi.org/10.1061/\(asce\)he.1943-5584.0001508](https://doi.org/10.1061/(asce)he.1943-5584.0001508).
- [13] S.J. Watt, A. Politi, Permutation entropy revisited, *Chaos, Solitons and Fractals.* 120 (2019) 95–99. <https://doi.org/10.1016/j.chaos.2018.12.039>.
- [14] S. Molavipour, H. Ghourchian, G. Bassi, M. Skoglund, Neural estimator of information for time-series data with dependency, *Entropy.* 23 (2021) 1–28.
<https://doi.org/10.3390/e23060641>.
- [15] Y. Deng, Deng entropy, *Chaos, Solitons & Fractals.* 91 (2016) 549–553.
<https://doi.org/https://doi.org/10.1016/j.chaos.2016.07.014>.
- [16] H. Zhang, Y. Deng, Entropy measure for orderable sets, *Inf. Sci. (Ny).* 561 (2021) 141–151. <https://doi.org/https://doi.org/10.1016/j.ins.2021.01.073>.
- [17] M. Martinez-Garcia, Y. Zhang, K. Suzuki, Y. Zhang, Measuring system entropy with a deep recurrent neural network model, *IEEE Int. Conf. Ind. Informatics.* 2019–July (2019) 1253–1256. <https://doi.org/10.1109/INDIN41052.2019.8972068>.
- [18] A. Velichko, Neural Network for Low-Memory IoT Devices and MNIST Image Recognition Using Kernels Based on Logistic Map, *Electronics.* 9 (2020) 1432.
<https://doi.org/10.3390/electronics9091432>.

- [19] X. Zhao, M. Ji, N. Zhang, P. Shang, Permutation transition entropy: Measuring the dynamical complexity of financial time series, *Chaos, Solitons and Fractals*. 139 (2020). <https://doi.org/10.1016/j.chaos.2020.109962>.
- [20] G. Litak, R. Taccani, R. Radu, K. Urbanowicz, J.A. Hołyst, M. Wendeker, A. Giadrossi, Estimation of a noise level using coarse-grained entropy of experimental time series of internal pressure in a combustion engine, *Chaos, Solitons & Fractals*. 23 (2005) 1695–1701. <https://doi.org/10.1016/j.chaos.2004.06.057>.
- [21] Y.H. Pan, Y.H. Wang, S.F. Liang, K.T. Lee, Fast computation of sample entropy and approximate entropy in biomedicine, *Comput. Methods Programs Biomed.* 104 (2011) 382–396. <https://doi.org/10.1016/j.cmpb.2010.12.003>.
- [22] L.M. Saha, S. Prasad, M. Yuasa, Measuring Chaos: Topological Entropy and Correlation Dimension in Discrete Maps, in: 2012.