

# High Performance and Optimal Configuration of Accurate Heterogeneous Block-Based Approximate Adder

Ebrahim Farahmand\*, *Student Member, IEEE*, Ali Mahani\*, Muhammad Abdullah Hanif†, *Student Member, IEEE*, Muhammad Shafique‡, *Senior Member, IEEE* \*Department of Electrical Engineering, Shahid Bahonar University of Kerman, Iran †Institute of Computer Engineering, Technische Universität Wien, Vienna, Austria ‡ Division of Engineering, New York University Abu Dhabi, UAE

**Abstract**—Approximate computing is an emerging paradigm to improve power and performance efficiency for error-resilient application. Recent approximate adders have significantly extended the design space of accuracy-power configurable approximate adders, and find optimal designs by exploring the design space. In this paper, a new energy-efficient heterogeneous block-based approximate adder (HBBA) is proposed; which is a generic/configurable model that can be transformed to a particular adder by defining some configurations. An HBBA, in general, is composed of heterogeneous sub-adders, where each sub-adder can have a different configuration. A set of configurations of all the sub-adders in an HBBA defines its configuration. The block-based adders are approximated through inexact logic configuration and truncated carry chains. HBBA increases design space providing additional design points that fall on the Pareto-front and offer better power-accuracy trade-off compared to other configurations. Furthermore, to avoid Mont-Carlo simulations, we propose an analytical modelling technique to evaluate the probability of error and Probability Mass Function (PMF) of error value. Moreover, the estimation method estimates delay, area and power of heterogeneous block-based approximate adders. Thus, based on the analytical model and estimation method, the optimal configuration under a given error constraint can be selected from the whole design space of the proposed adder model by exhaustive search. The simulation results show that our HBBA provides improved accuracy in terms of error metrics compared to some state-of-the-art approximate adders. HBBA with 32 bits length serves about 15% reduction in area and up to 17% reduction in energy compared to state-of-the-art approximate adders.

**Index Terms**—Approximate adders, Error analysis, Performance estimation, Low power, Low latency.

## I. INTRODUCTION

NOWADAYS, due to high computational requirements of advanced applications, computing systems are becoming more-and-more resource hungry. Based on energy/power, area and cost requirements issues computing systems cannot be used in edge-based applications. Approximate computing has achieved notable attention for its potential to increase computing efficiency in terms of performance, power, and area [1], specifically for error-resilient applications. Recent investigations have shown that approximate computing is an emerging paradigm for error-tolerant application, such as multimedia,

image processing, deep learning, and data mining, which do not necessarily need full precision output.

Adders are essential blocks in arithmetic circuits, as they are one of the fundamental building blocks of other arithmetic operations, such as a multiplication, division and subtraction. Hence, the approximation of adders may significantly improve the performance and energy/power efficiency of applications. Typically the critical path in adders is on the carry computation chain [2]. State-of-the-art low-latency and low power approximate adders exploit carry chain truncation and logic simplification to offer quality-efficiency trade-off. A variety of approximate adders were proposed in [3].

**Key Design Challenges:** The following constraint shows the importance of approximate adders and their statistical analysis hardware implementation:

- *Adder's hardware design bottleneck:* In digital design, power, area and delay of the circuit are considered as the key performance metrics. Generally, for adders, these metrics increase rapidly with bit-width ( $N$ ). From delay prospective, delay is determined by the length of carry propagation. In practical applications, the average length of carry propagation is shorter than  $\log_2 N$  as equating to bit-width [4]. Since the length of carry propagation is considered as the key criterion for designing low-latency approximate adders in the research works.
- *Limitations of Exhaustive Simulations:* The exact evaluation of the adder's error metrics needs to simulate all possible inputs combinations, i.e.  $2^{2N}$  for  $N$ -bit adder. Hence, simulation time exponentially increases with adder bit-width. The statistical analysis prevents the high computational burden and provides an insight into the relationship between adder structure and error.
- *Optimal Configuration Selection:* Selecting the optimal configuration, which offers the lowest area, power and delay while meeting the desired application accuracy, is a design space exploration problem and may be challenging if the number of potential adder configurations is large. To select the best configuration for a predefined accuracy constraint, different adder configurations must be compared, which leads to prolonged and practically-infeasible computational time. To select optimal configuration, the design space takes the following things into account:

- Error metrics, e.g., error rate, MED and MSE, that can be computed using the Probability Mass Function (PMF) of error value.
- Hardware design metrics, i.e., area, power and delay

**Related Works and Their Limitations:** In the earlier approaches, researchers have focused on transistor-level modifications to approximate the circuit [5], [6]. The well-known techniques, such as voltage over-scaling (VOS) technique [7]-[8], clock overgating [9] and transistors number reduction [10], are used to approximate the adder circuit. The researchers need to implement a circuit layout for these methods, which takes effort.

The next step in designing approximate adders is architectural-level modifications for quality-efficiency trade-off. In this step, adders can be classified into three categories.

- Variable Latency Adder (VLA), in which the carry for each individual bit location is dependent on its previous  $K$  bits instead of all  $N$  prior bits [11].
- Inexact Logic Configuration Adder (ILCA), in which the less significant bits (LSBs) are computed using approximate logic. The primary approximation adders that fall in this category are Lower-Part-OR Adder (LOA) [12] and approximate XOR/XNOR-based adders for inexact computing (AXA) [13]. The LOA uses OR gates instead of full adders at the LSB locations of the adder. The LOA's design space is limited and contains only a limited number of configurations, equivalent to the bit-width of the adder.
- Block-Based Adder (BBA), in which the adders are constructed using smaller approximate and accurate sub-adders that have smaller carry chain than the carry chain of the corresponding accurate adder. The approximate blocks can be formed by homogeneous approximate blocks or heterogeneous. The adder which utilizes homogeneous approximate blocks is called Homogeneous Block-Based Adder (Homo-BBA), and the heterogeneous approximate blocks are called Heterogeneous Block-Based Adder (HBBA). HBBA can further be classified into two sub-categories based on whether the adder contains redundant blocks or disjoint blocks. In redundant blocks sub-category, blocks have some overlapping region (in term of bit locations) with other blocks. Therefore, the size of the carry chain that defines the critical path depends on the length of the largest block. In disjoint blocks sub-category, the blocks are disjoint and the critical path depends on the length of the largest block. The BBA is commonly used due to its lower error ratio than the rest of adders type. Some adder designs that fall in this category are Almost Correct Adder (ACA-I) [14], Carry-Skip Approximate Adder (CSAA) [15] and Gracefully Degrading Adder (GDA) [16].

The BBAs have emerged as a promising architecture of approximate adder. Zhu *et al.* have proposed 4 variants of error-tolerant BBAs, i.e., ETA I and ETA II [17], ETA III [18], ETA IIM [19]. The Carry Cut-Back Adder (CCBA) [20] is monitored to detect the long path of the carry chain followed by cutting the carry chain. Another BBA has proposed in

[2]. In this technique the non-overlapping sub-adders uses a carry predictor unit and a selector unit to decide whether the carry out of each sub-adder is propagated or not. Generic Accuracy Configurable Adder (GeAr) [21] utilizes redundant blocks leading to excessive hardware overhead. The Reverse Carry Propagate Adder (RCPA) [22] propagates the carry-in a counter-flow manner from the MSB, i.e. carry-in, to the LSB, i.e. carry-out. The RCPA is not efficient in case of delay. In general, it should be noted that these methods have fixed configurations with limited flexibility and a massive error value.

On the other hand, Some methods contribute to flexibility in design by supporting multiple configurations. QuAd [23] is an enhanced model of GeAr with flexibility. In the QuAd adder, the sub-adders have different sizes as well as size of carry prediction which is part of sub-adders inside block-based adders. A reconfigurable approximate adder is proposed in [24], and it employs the carry look ahead (CLA) method. The adder is split into two disjoint segments, i.e., approximate part and augment part. This adder is reconfigurable, and it is possible to switch between the accurate and approximate operation by using a multiplexer. This technique imposes hardware overhead; henceforth, Xu *et al.* proposed another reconfigurable adder called Simple Accuracy-Reconfigurable Adder (SARA) [25]. In SARA, the adder is divided to  $K$  disjoint sub-adders. Moreover, it uses an error recovery circuit to reduce the error, which imposes additional hardware overhead. Additionally, the utilized ripple carry adder in sub-adder causes a long critical path. Note that in [23], [24] and [25], the flexibility offered by design comes with additional hardware cost, and moreover, these designs only consider homogeneous blocks.

Besides all the discussed methods, the other crucial factors in approximate computing are error probability and its evaluation. An analytical model for homogeneous overlapping blocks is proposed in [26]. In this article, in addition to proposing the generic methodology for error probability, the PMF of error value is also evaluated. Another analytical model is proposed in [27] which focuses on error metrics of adders with two segments, one accurate and the other inaccurate segment. In [28], error metrics are obtained based on an analytical model and generalized analytical model for equal redundant segments with homogeneous blocks. The authors have used optimization technique to optimize the design's estimated parameters such as delay, power, and area. Also, the given accuracy is considered as a constraint in the optimization framework. However, the adverse drawback of these analytical methods is not considering heterogeneous approximate blocks in precise evaluation of probability of approximate adders error. Moreover, estimation model for error metrics, e.g MSE, is proposed by the PEAL [29]. It estimated the error metrics by evaluating carry-out probability for each approximate FA. The PEMACx [30] is a novel analytical method for efficiently computing the error's PMF of adder that consist of cascaded approximate adder units. In this article, the probability of carry-out error is evaluated for each cascaded approximate adder unit and these probabilities are used recursively as carry-in probabilities for next stages to recursively evaluate the

probability of carry-out error for last stage. We have proposed an analytical model to cover the internal errors and the errors between the heterogeneous approximate blocks, allowing the blocks to be of various architectures in order to address the following limitations.

**Summary of Key Limitation:** In general, all the above-mentioned approaches suffer from the following limitations:

- The methods focused on homogeneous block-based adders, and they did not consider heterogeneous block-based adder.
- The methods have either fixed configurations with limited flexibility, which results fixed configuration adder neglects different configurations with the same accuracy. Furthermore, in the case of flexible configuration design, they have high hardware complexity and high computational burden.
- The error metrics are computed by exhaustive simulation and computer simulations, which are feasible for small sized adders. Moreover, the methods do not consider the use of inexact logic in BBA design, which is defined as internal block error.

**Overview of Our Novel Concept and Design Space:**

In this paper, we focus on heterogeneous block-based approximate adders. In the proposed structure, the adder is segmented into disjoint blocks, in which the carry-in depends only on carry generation part of the previous block. Also, the block’s carry-in is predicted considering only some of the previous bits to reach the small carry chain. The prediction of carry for the next block is selective based on the accuracy level. For approximating the LSB part, we replace the full adders with OR gates, which results in logic simplification but at the cost of some accuracy loss. We consider logic simplification as an internal error in the approximate block. For our HBBA each approximate sub-adder can have any number of inexact logic configuration (OR gates)  $L$  and carry chains  $S$  bits. An  $N - bit$  HBBA adder consist of  $k$  approximate sub-adder is defined using a inexact logic configuration vector,  $L_{vec} = [L_1, L_2, \dots, L_k]$  and carry chain vector,  $S_{vec} = [S_1, S_2, \dots, S_k]$  where,  $L_i$  and  $S_i$  represent the number of inexact logic and carry chain bits in the  $i^{th}$  sub-adder, respectively. Hence, the generic HBBA representation,  $HBBA\{[L_1, L_2, \dots, L_k], [S_1, S_2, \dots, S_k]\}$  fully defines any possible adder configuration. HBBA approximate adder provides a configuration that is still not considered by any prior adders, such as LOA configurations. Consider an example where we would like to develop an 8-bit approximate adder using 4-bit sub-adders. Figure1 illustrates the complete design space of HBBA against LOA. Here, MED and delay are used as error metric and digital design metric, respectively. Figure1 shows that different design configurations are overlooked in LOA, as these configurations may provide design points with less delay in the same accuracy. The optimal hardware configuration can lead to efficient and goal-oriented design based on accuracy-hardware metrics trade-off. Here, the trade-off is modelled by a hybrid methodology, including a statistical and analytical estimation model to improve the performance of the designed circuit. The statistical model is used to calculate

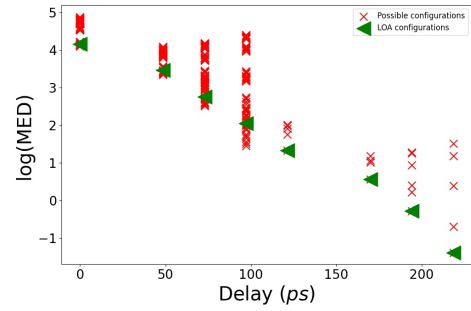

Figure 1. Design Space of an 8 bits approximate adder with 4 bits sub-adders

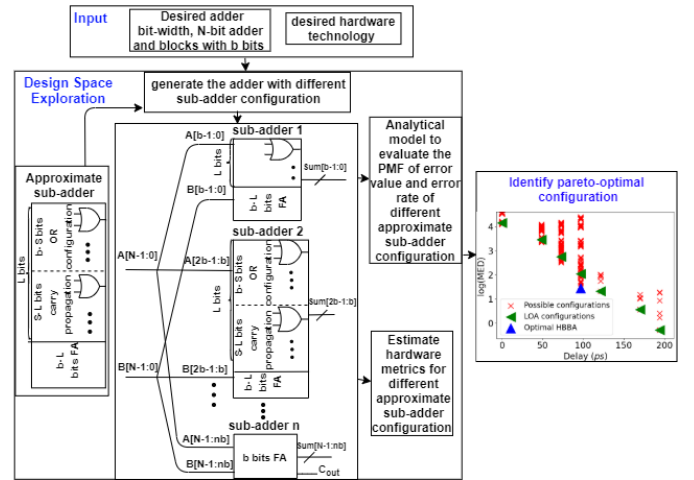

Figure 2. Diagram of Proposed adder

error metrics, including the probability of error and probability mass function (PMF) of error value in the output of the approximate adder. In our proposed analytical model, we are able to reorder blocks to attain accuracy. Besides, the analytical estimation model is proposed to estimate delay, power and area in hardware design.

**Key Novel Contributions:** The overall flow of our contribution is illustrated in figure 2. The steps are summarized in the following novel contributions:

- Heterogeneous block-based approximate adder design: We focus on heterogeneous block-based approximate adders, making the design flexible and improving hardware metrics such as area, delay, and power.
- Analytical analysis of error metrics and Estimate Model for Design Metrics: A generic methodology is proposed for analytical modelling of probability mass function (PMF) of error in the output of the approximate adder. The analytical model helps avoid the computer simulation. Moreover, estimation model is developed to estimate the delay, power and area as design metrics.
- Explore in flexible configuration of BBA: Proposed models help in fast exploration of the design space and in identifying the Pareto-optimal configurations for an  $N$  bits adder.

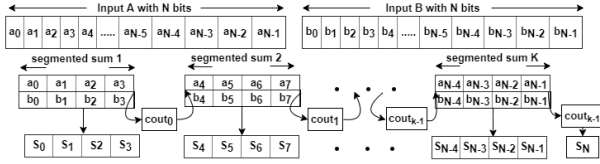

Figure 3. General block diagram of a segmented adder

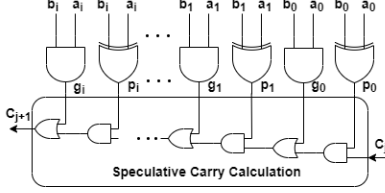

Figure 4. Logic expression of carry out generation

## II. PROPOSED METHODOLOGY

An HBBA adder operates on two  $N$ -bit inputs  $A = (a_N, a_{N-1}, \dots, a_i, \dots, a_1)$  and  $B = (b_N, b_{N-1}, \dots, b_i, \dots, b_1)$ . It is segmented to  $k$  disjoint blocks, as illustrated in Figure 3.

To explain our proposed adder design, we start by explaining the conventional carry look ahead (CLA) and then our modifications that generates a while new design space. In the CLA, carry-out of each BBA's block is calculated based on Eq. 1 in which it is assessed by generate and propagate signals of each bit location. The generate and propagate signals are described by Eq. 2 for each bit,  $i(1 \leq i \leq N)$ .

$$c_{i+1} = g_i + p_i g_{i-1} + \dots + g_1 \prod_{j=2}^i p_j + g_0 \prod_{j=1}^i p_j + c_i \prod_{j=0}^i p_j \quad (1)$$

$$p_i = a_i \oplus b_i, g_i = a_i \cdot b_i \quad (2)$$

Where,  $c_j$  is carry-in of  $j$ -th block,  $c_{j+1}$  is carry-out of each block, and  $g_i$  and  $p_i$  respectively correspond to generate bit and propagate bit. The carry-out logic circuit is illustrated in figure 4.

### A. The proposed adder

The proposed adder is segmented to  $S$  blocks where each block is an  $H$  bits sub-adder and  $S = \lceil N/H \rceil$ . The blocks used in this adder are not homogeneous and fall into two types, i.e., accurate and approximate blocks. The accurate block is mainly used for MSBs and the approximate block is used for LSBs. The accurate blocks add the  $H$  bits of the two inputs using a carry look ahead (CLA). The approximate blocks use combined logic simplification (OR gates replacement), full adders and carry look ahead to add the  $H$  bits of the inputs. In the calculation of the approximate block's carry-out, the number of bits in use is varied. Consequently, we are free to define the length of carry generations and propagation in every approximate block. For instance, Figure 5 shows a 4-bit approximate block with 3 bits to propagate the carry, and lower 2 FAs are replaced with OR gates for computing the corresponding sum bits. We have heterogeneous approximate blocks with various configurations placed in different position

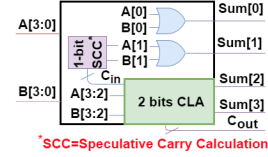
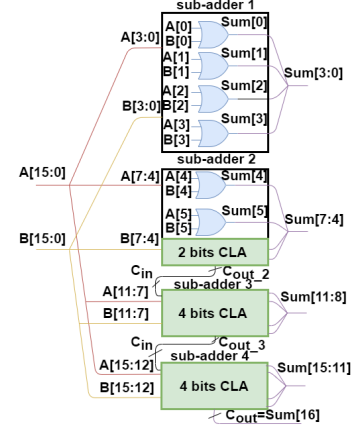

 Figure 5. Approximate block with  $H$  bits ( $H=4$ ) length

Figure 6. 16 bits approximate adder

in the proposed adder. As an example, a 16 bits adder with two heterogeneous approximate blocks is shown in figure 6. In order to obtain the output of sixteenth bit in figure 6, only ten bits are needed to propagate carry. However, in CLA, all sixteen bits are required to propagate carry. Follow up on the proposed HBBA; we elaborate on the analytical analysis method for heterogeneous approximate blocks. Afterwards, these analysis results are used in obtaining PMF of approximate adder error, which are further discussed in section II-F. Furthermore, the estimation model is developed for estimating the hardware metrics of HBBA. Finally, the optimal configurations are chosen for heterogeneous approximate blocks based on quality-efficiency trade-off.

### B. Error Analysis

In approximate adders, besides the conventional performance metrics such as delay, area and power, the error metrics are used to compare adders. The conventional error metrics: error rate (ER), error distance (ED), mean error distance (MED), mean square error (MSE), mean relative ED (MRED), and normalized ED (NED) [28]. Among these metrics, the error distance (ED), error rate (ER), and mean error distance (MED) are more important and applicable for comparison the adders [31]. These metrics can be calculated either through computer simulation or an analytical model. Due to the greater benefits of analytical model, an analytical model is proposed in this work. The primary advantages of a proposed analytical model consist of:

- It facilitates the comparison between the different accuracy level without compromising the computational time.
- This proposed analytical model is used in exploring design space in order to obtain optimal circuit parameters

such as carry chain length, number of approximate blocks and accurate blocks.

In this respect, it provides insight into the relation between circuit specifications and error statistics, which is helpful for the designers to tune circuit parameters based on the desired accuracy level.

In the following, we introduce the analytical analysis on the adder's error and compare them with numerical tests. The error in each approximate block is propagated to the final adder's output, in which the sources of error is the prediction of carry or inaccurate computation (internal block error). The error in the prediction of carry-out in the  $i$ -th approximate block is due to a truncation in the carry chain. Moreover, another error of inaccurate computation is due to the substitution of the OR gate instead of the full adder. So the probability of error in approximate adder's output corresponds to Eq.3

$$Probability(Error) = Probability(S_{app} \neq A + B) \quad (3)$$

Where  $A$  and  $B$  indicate inputs of the adder and  $S_{app}$  stands for the approximate sum calculated by the proposed adder. In addition to the probability of error, other metrics such as MSE, NMED and NED are considered for comparison between adders. However, these metrics are not satisfactorily informative since they are the average of different errors over all the inputs. So, it is more pertinent to use the PMF of error value as performance metrics. The PMF of error value indicates the probability of error enormity and significance of each error value. Hence, to evaluate the PMF of error value in the proposed heterogeneous approximate block, first, we identify the source of errors. Next, we evaluate probability error values, and eventually, we represent the error rate in a generalized form of the heterogeneous approximate adder. The proposed methodology is shown in figure 7, which consists of the following stages:

- Identification of the error sources (stage 1 and stage 2): The first and second stages are to identify the sources of errors in the approximate block, which cause the erroneous output. The analytical model for the approximate block is identified as the sum of the probability of joint internal block error and intermediate block error events. The sources of internal and intermediate block error are logic simplification, which is called  $E_1$ , and carry truncation called  $E_2$ , respectively. The analytical model of these errors individually are presented in sub-section II-C
- Find joint error events (stage 3): In this stage the analytical model is proposed to find the joint error events in approximate blocks. The evaluation of this stage is explained in figure 7 and elaborated in sub-section II-D.
- PMF of error value Evaluation for the approximate block (stage 4): The PMF of error value in the approximate block is obtained by evaluating the probability of the error sources and the joint probability of errors. The description of this step is presented in sub-section II-D.
- PMF of error value Evaluation in approximate adder (stage 5 and stage 6): PMF of error value in approximate adder is calculated by independent error events of all

blocks. This is given by the multiplication of error events. The PMF of error value is calculated by the inclusion-exclusion principle shown in stage 7. This approach is elaborated in sub-section II-F.

Moreover, the analysis for the evaluation of error rate is modeled based on the stages in figure 7 and the details explain in sub-section II-E.

### C. Identification of the sources of error

The calculations of PMF for two error types in figure 7 are explained in the following sub-sections.

1) *Replaced OR gates PMF error value evaluation:* In order to evaluate PMF of replaced OR gates error value, we evaluate the PMF of adder inputs.  $P_A$  and  $P_B$  are the probability distribution of adder's inputs, e.g.,  $A$  and  $B$ , respectively. Based on [26], if  $X = [a_{k2}, \dots, a_{k1}]$  is a sub-group of bits in  $A = [a_{N-1}, a_{N-2}, \dots, a_0]$ , where  $0 < k1 < k2 < N$ , we can drive a probability distribution of  $X$  ( $P_X(k)$ ) as follows:

$$P_X(k) = \sum_{i=0}^{2^{N-1}-k2-1} \left( \sum_{j=0}^{2^{k1}-1} P_A(2^{k2+1}i + 2^{k1}k + j) \right) \quad (4)$$

$$0 < k < 2^{k2-k1+1}$$

For the other input  $B$ ,  $P_Y$  is derived from  $P_B$  similar to  $P_X$ . Since the two inputs are independent, the PMF of the summation  $Z = X + Y$  is calculated by convolution of  $P_X$  and  $P_Y$ . Assuming that the probability distribution of  $A$  and  $B$  are uniform between 0 and  $2^N - 1$ , the  $X$  and  $Y$  are similarly uniform between 0 and  $2^n - 1$ . Therefore, PMF of the sum is represented as follows:

$$P_Z(k; n) = P_X(k; n) \otimes P_Y(k; n) \quad (5a)$$

$$P_Z(k; n) = \begin{cases} \frac{K+1}{2^{2n}} & 0 \leq k \leq 2^n - 1 \\ \frac{2^{n+1}-k-1}{2^{2n}} & 2^n - 1 \leq k \leq 2^{n+1} - 2 \\ 0 & \text{otherwise} \end{cases} \quad (5b)$$

When OR gates embed  $L$  bits of approximate block, an error value is obtained between 0 to  $2^L - 1$ . The probability of error can be calculated by the binary representation of error values at the bits, where the OR gate replaces the full adder, and the resulting output bits are calculated after applying OR gate to the input bits. The value at a given bit location is 1 when both values at the corresponding bit location in the inputs are 1. Conversely, value 0 occurs when the corresponding bit location in the inputs are not 1 simultaneously. Hence, the probability of error value for a given bit location ( $k$ ), which has the value 1, is evaluated by the probability intersection of its two inputs in that particular position ( $Pr_x(k) \cap Pr_y(k)$ ). For the bit, which has value 0, the probability of error value is evaluated by  $1 - (Pr_x(k) \cap Pr_y(k))$ . Since the inputs of every bit are independent of each other, the intersection can be replaced by the product of the two probabilities. In other words, the probability of error value in the position of  $k$  for a corresponding value of 1 is evaluated by  $Pr_x(k).Pr_y(k)$  and for the value 0 is evaluated by  $1 - (Pr_x(k).Pr_y(k))$ .

We present an example to demonstrate the proposed analogy

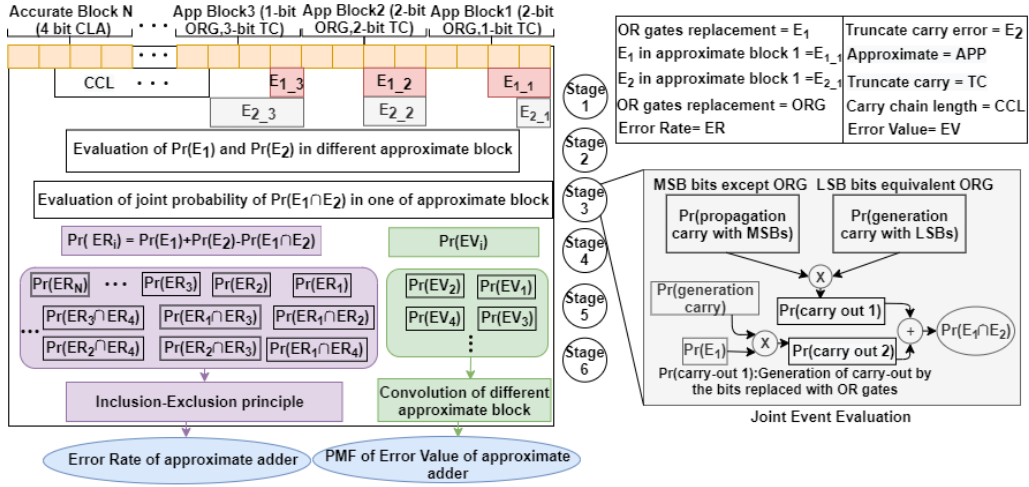

Figure 7. Proposed methodology

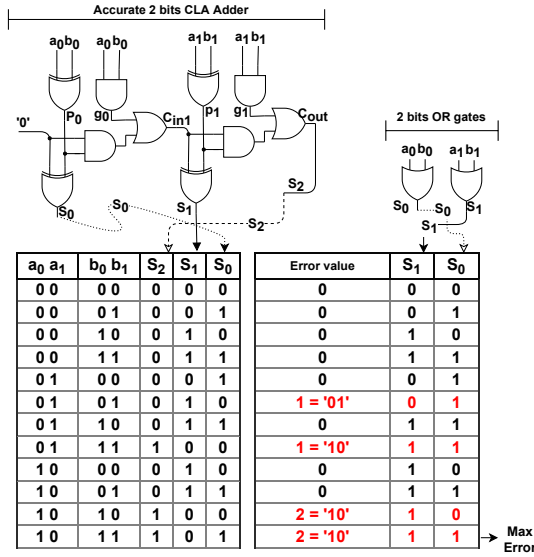

Figure 8. Error value of OR gates replacement

in a particular case. In the example, we assume uniformly distributed inputs and replace two bit's adder with two OR gates. For two bit's adder, the error value are  $1 \leq EV \leq 3$ . Figure 8 illustrates the difference between two bits adder and OR gates.

Based on figure 8 where  $L = 2$ , the probability of error value (EV) in this example is shown as follow:

$$Pr_{EV\_OR} = \begin{cases} \frac{9}{16} & x = 0 \\ \frac{3}{16} & x = 1, x = 2 \\ \frac{1}{16} & x = 3 \end{cases} \quad (6)$$

The probability of error value 1, which is represented by binary equivalent of '01' is calculated as follow:

$$x = '01' \Rightarrow Pr_{EV} = Pr(FBI = 1) \cap Pr(SIBS \neq 1) \quad (7)$$

Where  $FBI = 1$  is first bit of inputs are 1 and  $SIBS \neq 1$  is second bit of inputs are not 1 simultaneously.  $Pr(FBI =$

1) is evaluated by  $Pr_X(\text{first bit} = 1) \cap Pr_Y(\text{first bit} = 1)$ , and since two inputs are independent, this expression is simplified to  $Pr_X(\text{first bit} = 1) \cdot Pr_Y(\text{first bit} = 1)$ . Due to the uniformity in inputs distribution,  $Pr_X(\text{first bit} = 1) = \frac{1}{2}$  and  $Pr_Y(\text{first bit} = 1) = \frac{1}{2}$ , and as a result,  $Pr(FBI = 1) = \frac{1}{4}$  and in the same manner, the other term of Eq.7 is given as follow:

$$Pr(SIBS \neq 1) = 1 - (Pr_X(SB = 1) \cap Pr_Y(SB = 1)) = 1 - (Pr_X(SB = 1) \cdot Pr_Y(SB = 1)) = \frac{3}{4} \quad (8)$$

Where  $SIBS \neq 1$  is second bit of inputs are not 1 simultaneously and  $SB = 1$  is second bit is 1. Based on Eq.7 and as a result of the independence between input bits, this equation can be re-written as Eq.9.

$$Pr_{EV} = Pr(FI = 1) \cdot Pr(SIS \neq 1) = \frac{1}{4} \cdot \frac{3}{4} = \frac{3}{16} \quad (9)$$

The PMF of error values formula used for the above example verified by empirical results is shown in Eq.6. The example discussed above hints at the calculation of error value in two bits adders replaced with OR gate; furthermore, we can expand this trend for  $n$  bits adder.

According to the above description, we can formulate the summation of the probability of error values for replaced OR gates ( $Pr_{EV\_OR}$ ) by Eq.10.

$$\sum_{i=1}^L Pr_{EV\_OR} = \sum_{i=1}^L \binom{L}{i} \cdot (Pr(OBI = 1))^i \cdot Pr(OBIS \neq 1)^{L-i} \quad (10)$$

Where  $OBI = 1$  is one bit of inputs are 1 and  $OBIS \neq 1$  is one bit of inputs are not 1 simultaneously.

2) *Truncated Carry PMF Evaluation*: Truncated carry is done from the selected position in  $H$  bits approximate block. If the length of carry chain is  $S$  bits, the length of the truncated carry is  $H - S$  bits. In this case, the generated error value is equal to  $2^H$ , and the probability of error value depends on the position of carry truncation. In order to evaluate the PMF of error value of truncated carry, we divide the approximate block into two segments. The first segment has  $S$  bits length from MSB, and the other segment has the remaining bits with  $H - S$

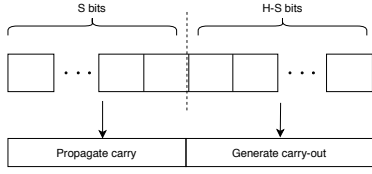

Figure 9. Truncated carry Approximate block

bits length. This segmentation is shown in figure 9. The error of truncated carry occurs when the first segment generates the carry, and the next segment propagates the carry.

Based on the above, the probability of error value for each approximate block has been formulated as Eq. 11.

$$Pr_{error\_carry\_truncated} = Pr(G_1 \cap P_2) \quad (11)$$

Let  $G_1$  and  $P_2$  represent the carry generation by the first segment and propagation carry by the second segment in the approximate block. Since two segments are independent, the probability of generation and propagation of carry can be consider as two independent events. Furthermore, the inputs of two segments are disjoint bits group. Eq.12 can represent the probability of error value of truncated carry.

$$Pr_{error\_carry\_truncated} = Pr(G_1).Pr(P_2) \quad (12)$$

Thus, the PMF of the error value of truncated carry is evaluated by Eq. 13.

$$Pr_{EV\_truncate} = \begin{cases} Pr(G_1).Pr(P_2) & x = 2^H \\ 1 - (Pr(G_1).Pr(P_2)) & x = 0 \end{cases} \quad (13)$$

Where  $Pr_{EV\_truncate}$  denotes the probability of error value of carry chain truncation. Propagation of the carry by  $S$  bits occurs when the pairwise inputs bits are unequal. So this condition is satisfied when the summation of these bits are equal to  $2^S - 1$ . Hence, the probability of propagation for two inputs is depicted as follows:

$$Pr(P_2) = P_Z(2^S - 1, S) \quad (14)$$

Where  $P_Z$  represents the PMF of the inputs' summation, the Eq. 5 is used to calculate  $P_Z$  when the inputs are uniformly distributed. Consequently, the probability of carry propagation for the first segment consisting of  $S$  bits is given by Eq.15

$$Pr(P_2) = \frac{1}{2^S} \quad (15)$$

Probability of carry-out generation of a second segment consisting of  $H - S$  bits can be formulated as follows:

$$\begin{aligned} Pr(G_1) &= Pr(X + Y > 2^{H-S} - 1) \\ &= Pr(Z > 2^{H-S} - 1) = P_Z(K > 2^{H-S} - 1, H - S) \end{aligned} \quad (16)$$

The probability of carry generation of the first segment is calculated by Eq. 17.

$$Pr(G_1) = \sum_{j=2^{H-S}}^{2^{H-S+1}-2} P_Z(j, H - S) \quad (17)$$

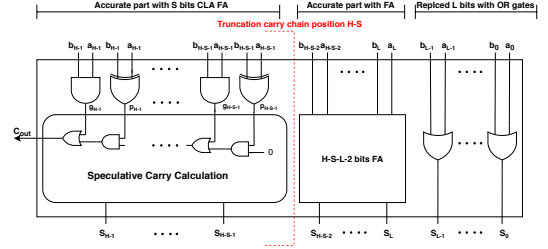

Figure 10. Truncated carry's bits greater than OR gates replaced bits

By substituting the Eqs. 15 and 17 in the Eq. 13, the PMF of error value of truncated carry for the approximate block is obtained by Eq. 18.

$$Pr_{EV\_truncate} = \begin{cases} (\sum_{j=2^{H-S}}^{2^{H-S+1}-2} P_Z(j, H - S)).(\frac{1}{2^S}) & x = 2^H \\ 1 - (\sum_{j=2^{H-S}}^{2^{H-S+1}-2} P_Z(j, H - S)).(\frac{1}{2^S}) & x = 0 \end{cases} \quad (18)$$

#### D. Approximate block's PMF Evaluation

In each block, the PMF of error value is expressed by union of the source of the error event. In the proposed adder,  $Pr_{EV\_OR}$  and  $Pr_{EV\_carry\_truncated}$  are the source of errors, hence the error value of approximate block ( $EV_{AppBlock}$ ) is shown by Eq. 19.

$$EV_{AppBlock} = EV_{ORGate} + EV_{CarryTruncated} \quad (19)$$

Assuming that the length of OR gates replaced with FAs is  $L$  bits, the carry chain's length is  $S$  bits. The PMF of error value in the approximate block falls into three cases shown in TABLE I. To obtain the error value in these three cases, the corresponding ranges in TABLE I should be considered.

Table I  
ERROR VALUE RANGES BASED ON DIFFERENT CASES

Case	Carry chain truncated and OR gates position	Error value ranges
First	$H - S > L$	$0 < error \leq 2^L - 1$
		$error = 2^H - 1$
		$2^H - 1 < error \leq (2^H - 1) + (2^L - 1)$
Second	$H - S = L$	$0 < error \leq 2^L - 1$
Third	$H - S < L$	$0 < error \leq 2^L - 1$
		$error = 2^L - X - 2^H, 2^{H-S} \leq X \leq 2^L - 1$

In the following, the PMF of an approximate block error value calculation for three cases will be explained. In the first case, ( $H - S > L$ ), the length of truncated carry is greater than the replaced OR gates. In this case, the approximate block configuration is shown in figure 10. The value of error in the first case is driven by the replacement of OR gates and the truncated carry. The replacement of OR gates cause error values between 0 to  $2^L - 1$ , and the truncated carry induce error value equal to  $2^H - 1$ . Hence, the total error value of approximate block ranges from 0 to  $2^L - 1$  and from  $2^H - 1$  to  $(2^H - 1) + (2^L - 1)$ . We use three stages to calculate the probability of error value in the approximate block in this stage, and hence describing these stages in the following paragraphs.

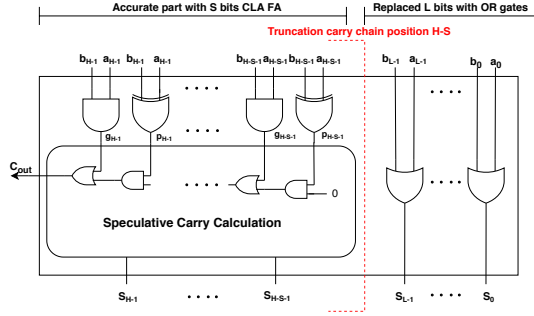

Figure 11. Truncated carry's bits equal to OR gates replaced bits

In the first stage, the probability of error value for the value of  $2^H - 1$  is calculated by Eq. 20.

$$Pr_{EV_{AppB}}(2^H - 1) = Pr_{SSBCO} \cdot Pr_{EV_{OR}}(EV = 0) \quad (20)$$

$Pr_{EV_{AppB}}$  stands for probability of approximate block. As the assumption of  $H - S > L$  is valid; the approximate block is split into two sub-blocks. The first sub-block has  $L$  bits length, whereas the second sub-block has  $H - L$  bits length.  $Pr_{EV_{OR}}(EV = 0)$  is the probability of error-free in the first sub-block, which is obtained by Eq. 10, when  $x = 0$ . The  $Pr_{SSBCO}$  is the probability of carry-out generation by second sub-block which is calculated by Eq. 18.

In the next stage, the probability of error value for the range  $EV > 2^{H-1}$  is calculated as follow:

$$Pr_{EV_{AppB}}(EV > 2^H - 1) = Pr_{SSBCO} \cdot SpO \quad (21)$$

Where  $Pr_{SSBCO}$  is computed in the same manner as the prior stage and  $SpO$  is summation of probability of error value of replaced OR gates is evaluated by Eq.22.

$$SpO = \sum_{i=1}^L Pr_{EV_{OR}} \quad (22)$$

Where  $Pr_{EV_{OR}}$  is the probability of error value in the first sub-block, and  $Pr_{SSBCO}$  is computed in the same manner as the prior stage.

In the third stage, the probability of error value for values between 0 to  $2^L - 1$  is calculated by Eq. 23

$$Pr_{EV_{AppB}}(0 < EV < 2^L - 1) = (1 - Pr_{SSBCO}) \cdot SpO \quad (23)$$

In the second case, ( $H - S = L$  bits), the length of truncated carry is equal to the replaced OR gates. The approximate block configuration, in this case, is shown in figure 11. the error value ranges in this case is from 0 to  $2^L - 1$ , where the probability of error value is calculated by Eq. 23. In this case,  $Pr_{SSBCO}$  is equal to zero. Thus, the probability of error is equal to the probability of the error value of the replaced OR gates.

In the last case, ( $H - S < L$ ), the length of the truncated carry chain is smaller than the replaced OR gates. The approximate block configuration, in this case, is indicated in figure 12.

The error value in this case has two ranges, from 0 to  $2^L - 1$  and  $(2^L - X) - 2^H$  where  $2^{H-S} \leq X \leq 2^L - 1$ . The corresponding values in the first range (from 0 to  $2^L - 1$ )

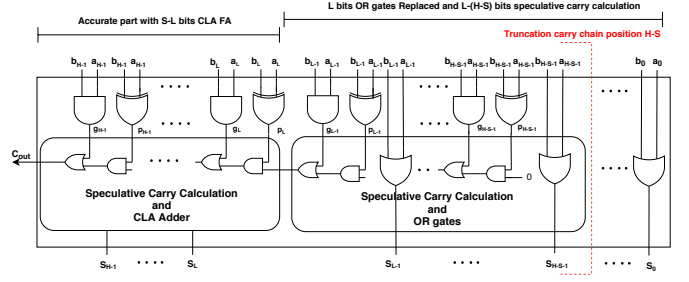

Figure 12. Truncated carry's bits smaller than OR gates replaced bits

are divided into 0 to  $2^{H-S} - 1$  and  $2^{H-S}$  to  $2^L - 1$ . The probability of error values for 0 to  $2^{H-S} - 1$  is equal to the probability of replaced OR gates in the corresponding values. The probability of error value for values  $2^{H-S}$  to  $2^L - 1$  ( $2^{H-S} \leq EV \leq 2^L - 1$ ) is similar to the first case by dividing the approximate block into two sub-blocks, and the probability of error value for corresponding values is calculated as in Eq. 24

$$Pr_{EV_{Approximate\ Block}}(x) = \begin{cases} (1 - Pr_{PSSB}) \cdot (SpO - \frac{1}{2^H}) + \frac{1}{2^H} & x = 2^{H-S}, \\ & 2^{H-S+1}, \dots, 2^L - 2 \\ (1 - Pr_{PSSB}) \cdot SpO & \text{Otherwise} \end{cases} \quad (24)$$

Where  $Pr_{PSSB}$  and  $SpO$  are probability of propagate carry with second sub-block and summation of probability of error value of replaced OR gates evaluated by Eq.22, respectively. This occurs when the sum of inputs is equal to  $2^{H-L} - 1$ .

The probability of error value in range  $(2^L - X) - 2^H$  is evaluated by Eq. 25. Where  $2^{H-S} \leq X \leq 2^L - 1$  is expressed as follow:

$$Pr_{EV_{AppB}}((2^L - X) - 2^H) = Pr_{PSSB} \cdot Pr_{EV_{LC}}(X) \quad (25)$$

Where  $Pr_{EV_{LC}}$  is probability of error value in last case which is evaluated by Eq.26.

$$Pr_{EV_{LC}}(X) = \begin{cases} (SpO - \frac{1}{2^H}) & X = 2^{H-S}, 2^{H-S+1}, \dots, 2^L - 2 \\ SpO & \text{Otherwise} \end{cases} \quad (26)$$

$SpO$  evaluates by Eq.22. To better describe this proposed analysis, an example is considered on a 4-bit approximate block. OR gates embed two LSBs, and the length of the carry chain is two bits, i.e., figure 5. The PMF of the approximate block error value is evaluated using Eqs.20,21. So the PMF of the error value of the approximate block is equal to:

$$Pr_{EV_{App\ Block}}(x) = \begin{cases} \frac{4}{512} & x = 19 \\ \frac{12}{512} & x = 17, 18 \\ \frac{36}{512} & x = 16 \\ \frac{28}{512} & x = 3 \\ \frac{84}{512} & x = 1, 2 \\ \frac{252}{512} & x = 0 \end{cases} \quad (27)$$



### E. Evaluation of Approximate block Error Rate

As described in the section II-C, two events, i.e., replaced OR gate and truncated carry, lead to erroneous blocks. The approximate block error rate will be evaluated by the union of these events. The error rate is calculated using the inclusion-exclusion principle [32] based on the Eq.28. Note that the two events of the approximate block are not mutually exclusive.

$$Pr(ER) = Pr(Event1 \cup Event2) = Pr(Event1) + Pr(Event2) - Pr(Event1 \cap Event2) \quad (28)$$

The first event ( $Event1$ ) and the second event ( $Event2$ ) represent the OR gates replaced and the carry truncated, respectively. The probability of the first event is calculated by the summation of overall values of the PMF of the replaced OR gates' error values, which is calculated by Eq.10. Hence, the probability of the first event ( $Pr(Event1)$ ) is given as follows:

$$Pr(Event1) = \sum_{x=1}^{x=2^L-1} Pr_{EV\_OR}(x) \quad (29)$$

The probability of the second event ( $Pr(Event2)$ ) is calculated by the summation over all the PMF of carry truncated error values. Hence, the probability of the second event ( $Pr(Event2)$ ) is calculated as follows:

$$Pr(Event2) = \sum_{x=1}^{x=2^H} Pr_{EV\_carry\_truncated}(x) \quad (30)$$

In order to calculate the probability of the union of error in two events, according to Eq.28, we need to calculate the probability of the intersection of events. To compute the probability of events intersection ( $Pr(Event1 \cap Event2)$ ), we consider three different cases as in sub-section II-D based on  $H - S$  and  $L$  values. In the first case,  $H - S > L$ ,  $H$  bits approximate block are split into two sub-blocks, The first sub-block has  $L$  bits and the second one has  $L - S$  bits. The probability of intersection of these two events, in this case, is given as follows:

$$Pr(Event1 \cap Event2) = Pr_{SSB}(G).Pr(Event1) + (Pr_{FSB}(G).Pr_{SSB}(Propagate)) \quad (31)$$

The  $Pr_{FSB}(G)$  and  $Pr_{SSB}(G)$  are the probabilities of generation carry-out by the first sub-block and the second sub-block, respectively. These are calculated by considering the bit length of the sub-block in Eq.16. The  $Pr_{SSB}(Propagate)$  is the probability of carry propagation by the second sub-block, which is calculated by Eq.14. In other cases,  $H - S = L$  and  $H - S < L$ , the intersection of two events is calculated similarly to the first case. However, in Eq.31, the probability of the generation carry-out by the second sub-block is equal to zero ( $Pr_{second\ sub\ block}(G) = 0$ ). Consequently, the probability of the intersection of two events in both cases is obtained as  $Pr(Event1 \cap Event2) = Pr(Event1)$ .

### F. Evaluation of the PMF of Heterogeneous BBA

The heterogeneous BBA with  $N$  bits is divided into  $K$  blocks with  $H$ -bits length.  $I$  blocks are heterogeneous approximate blocks, and the rest are accurate blocks. The source

of erroneous output is an error in the associated approximate block, and the blocks' errors are independent. Hence, the PMF of error value across the Heterogeneous BBA is calculated by the convolution of PMFs of error values in each heterogeneous approximate block. The PMF of error value of approximate adder ( $Pr_{EV\_A}$ ) is given as follows:

$$Pr_{EV\_A} = Pr_{EV\_AppB_1} \otimes Pr_{EV\_AppB_2} \otimes \dots \otimes Pr_{EV\_AppB_I} \quad (32)$$

Where  $Pr_{EV\_AppB_I}$  is PMF of error value of  $i^{th}$  approximate block. Beside the PMF of error value, the error rate (ER) in approximate adder with the same structure discussed above is acquired by the union of the error rate in all blocks. Henceforth, the probability of the union of such blocks can be obtained using the inclusion-exclusion principle [32] as in Eq. 33.

$$Pr_{ER\_A} = Pr[ERB_1 \cup ERB_2 \cup \dots \cup ERB_K] = \sum_{i=1}^K Pr[ERB_i] - \sum_{1 \leq i < j \leq K} Pr[ERB_i \cap ERB_j] + \sum_{1 \leq i < j < l \leq K} Pr[ERB_i \cap ERB_j \cap ERB_l] + \dots + (-1)^K Pr[\cap_{i=1}^K ERB_i] \quad (33)$$

Where  $Pr_{ER\_A}$  and  $Pr[ERB_i]$  are error rate of approximate adder and the error rate of  $i^{th}$  block, discussed in sub-section II-E, respectively. The error in each block happens independently; so, the probability of error rate for each block is also independent. The intersection of the error rate of blocks is simplified into the multiplication of them. So the error rate in approximate adder is calculated by Eq.34.

$$Pr_{ER\_A} = \sum_{i=1}^K Pr[ERB_i] - \sum_{1 \leq i < j \leq K} Pr[ERB_i].Pr[ERB_j] + \sum_{1 \leq i < j < l \leq K} Pr[ERB_i].Pr[ERB_j].Pr[ERB_l] + \dots + (-1)^K \prod_{i=1}^K Pr[ERB_i] \quad (34)$$

### G. Evaluation of Heterogeneous BBA's MED

Besides PMF and ER, mean error distance (MED) is considered as a criterion to compare the adders. MED is calculated by the average value of all error distance. Hence, it contains the information of ED and ER, and it uses as common performance parameters in approximate computing. Statistically, it is calculated by Eq. 35.

$$MED = E[ED] = \sum_{i=-\infty}^{\infty} |i| PMF(i) \quad (35)$$

Where  $PMF$  is the PMF of Heterogeneous BBA, and  $i$  is the value of each error in Heterogeneous BBA.

### III. SELECT OPTIMAL CONFIGURATION

In real error-resilient applications, given an acceptable accuracy level, which is identified by ED, ER, or MED, must be satisfied. In order to reach an acceptable accuracy level, the associated optimal configuration should be designed. The minimal area, delay and power are the main elements identified as hardware metrics in the optimal configuration. The optimal configuration selection is modelled as an optimisation problem, including the set of constraints and objective function. We evaluate ER, ED and MED as the acceptable accuracy level. These metrics are entered as constraints, and the hardware metrics are considered as an objective function. We use the estimation method proposed in [28] to formulate the hardware metrics in heterogeneous BBA. The detailed of estimation method for hardware metrics is explained in the following sub-sections.

#### A. Hardware Metrics Estimation Method

Common architecture is used for speculative adders composed of three parts as PG part, carry part and sum part. PG part generates propagation and generation signal. Detailed explanations are presented in [28] and in the textbook [33]. Various abstraction levels of digital design, from the highest behavioural level to the lowest device level, can be considered to estimate the design metrics. In this work, we perform gate-level to estimate the hardware metrics. We consider 2 inputs gates e.g., AND, OR, NAND and NOR as the basic gates. The other gates, like XOR and XNOR, are expressed by the basic gates. We neglect Inverter gates in the delay and area estimation. The circuit is modelled by 2-input gates, and gate-level depth and gate count are used, respectively, to estimate delay and area. In our estimation model, the XOR gate is constructed from three 2-input gates such as two 2-input AND and one 2-input OR. Thus, the gate level depth and gate count of the XOR gate are 2 and 3, respectively. Gate level implementation for the proposed adder is shown in figure 13, where we can evaluate the gate level depth and gate count.

1) *Delay*: The proposed adder architecture has shown in figure 13 consists of 3 parts. We evaluate gate-level depth for each block in the BBA independently. In the PG part and sum part, the XOR gate is crucial in gate level depth and therefore, gate-level depth is equal to 2 for both parts. The carry part's gate-level depth is dependent on the position of carry truncation and the number of bits that OR gates are replaced. If the carry truncated position ( $H - S$ ) for  $H$  bits block is greater than the OR gates replaced ( $L$ ), the gate level depth for this part will be  $2(H - S - L)$ . Thus, the gate level depth for the approximate block is equal to the summation of the gate-level depth of the PG part, sum part and carry part. Consequently, Delay for the approximate block with  $H$  bits are given as follows:

$$D_{AppB} = \begin{cases} 0 & S = 0 \\ 2C_d(S + 1) & H - S \leq L \\ 2C_d(H - S - L) & H - S > L \end{cases} \quad (36)$$

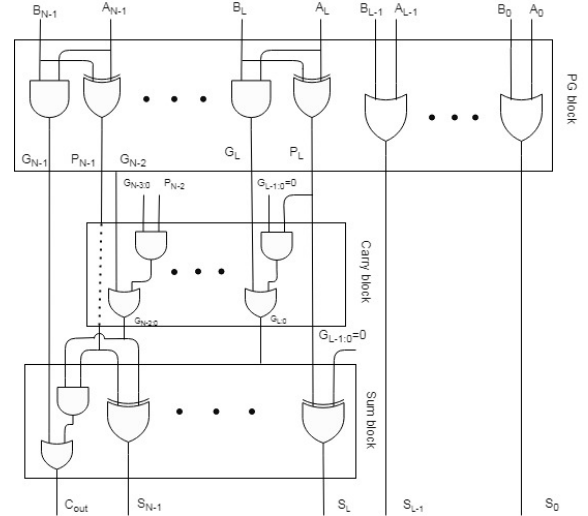

Figure 13. Gate level speculative adder

Where  $AppB$ ,  $S$  and  $L$  are approximate block, carry chain length and OR gates replacement, respectively.  $C_d$  is a constant factor of delay, which is derived from technology. Besides, delay for an accurate block with  $H$  bits length is evaluated as same as approximate block even though the gate level depth of carry block is  $2(H - 1)$ . Thus the delay for the accurate block is estimated by Eq.37.

$$D_{Accurate} = 2C_d(H + 1) \quad (37)$$

The estimation of  $N$  bits adder delay, which is consisted  $AC$  accurate block and  $AP$  approximate block, is obtained by the summation of delay of  $AC$  accurate block ( $D_{Accurate}$ ) and the delay of  $AP$  approximate block ( $D_{Approximate}(AP)$ ). Consequently, the estimation delay for heterogeneous BBA is given as follows:

$$D = AC.(D_{Accurate}) + AP.(D_{Approximate}) \quad (38)$$

2) *Area*: The estimate of the area in the proposed adder architecture, which has an accurate and approximate block, is calculated based on gate count. The accurate and approximate block consisted of the above three parts. Accordingly, in the accurate block, the PG part has a  $4H$  gate count, the sum part has  $3H + 2$  gate count, and the carry part has  $2(S - 1)$  gate count.

$$A_{Accurate} = 9H \quad (39)$$

The gate count of each part in approximate block is calculated as follows:

Where  $H$  refer to the bit-width of the approximate block,  $L$  and  $H - S$  is the number of bits replaced by OR gates and truncated carry, respectively. The area estimation for  $N$ -bits adder are equivalent to the total sum of the area of the accurate blocks and the approximate blocks. The estimation of area for heterogeneous BBA is calculated in Eq.40.

$$A = C_a(AC.(A_{Accurate}) + \sum_{i=1}^{AP} A_{Approximate}(i)) \quad (40)$$

Table II  
APPROXIMATE BLOCK'S GATE COUNT

Parts	Gate count
PG part	$Area_{PG} = \begin{cases} 4H - 3L & H - S > L \\ 4S + L & Otherwise \end{cases}$
Sum part	$Area_{Sum} = \begin{cases} 3(H - L) & S = 0 \\ 3(H - L) + 2 & Otherwise \end{cases}$
Carry part	$Area_{Carry} = \begin{cases} 0 & S = 0 \\ 2(S - 1) & H - S \leq L \\ 2(H - L - 1) & H - S > L \end{cases}$
$A_{Approximate}$	$Area_{PG} + Area_{sum} + Area_{Carry}$

Where  $AC$  and  $AP$  is the number of accurate blocks and approximate block, respectively.  $C_a$  is a constant factor for the area which depends on design technology.

3) *Power*: Power consumption in a digital circuit is estimated based on the following two components:

- **Dynamic power consumption**: The dynamic power consumption is directly proportional to its area a delay if the clock frequency is assumed to be fixed [28]. The dynamic power consumption ( $P_d$ ) at a fixed clock frequency for heterogeneous BBA architecture estimate by Eq. 41.

$$P_d \propto (area \cdot delay) \Rightarrow P_d = C_{pd}(A \cdot D) \quad (41)$$

Where  $C_{pd}$  is a constant factor of dynamic power derived from design technology.

- **Static power consumption**: According to [28] the static power consumption of a digital circuit is related to its area. Due to the direct proportional of the area to the static power consumption ( $P_s$ ), the static power consumption is calculated by Eq.42 for our proposed adder.

$$P_s \propto area \Rightarrow P_s = C_{Ps}(A) \quad (42)$$

Where  $C_{Ps}$  is a constant factor of static power which is derived from the technology of design.

As a result, the total power consumption can be estimated by the sum of dynamic and static power consumption.

$$P = P_s + P_d \quad (43)$$

Constant factors of delay, area and power are obtained using *Synopsys Hspice circuit simulator* with 32 nm technology design. Total consumption power obtains from the summation of dynamic and static power; therefore, the constant factor of power is evaluated by summation of those constant factors ( $C_p = C_{Pd} + C_{Ps}$ ). Based on [28] these constant factors of which is derived from 32 nm design technology are demonstrated in Table III

Table III  
CONSTANT FACTOR OF 32 nm TECHNOLOGY

Constant Factor	Value
$C_d$	12.14 ps
$C_a$	0.70 $\mu m^2$
$C_p$	9.24 $\mu W$

## IV. RESULT

We compare our proposed heterogeneous BBA with recent approximate adder designs in literature, based on the following aspects:

- Accuracy metrics
- Hardware metrics
- Trade-off between accuracy constraint and hardware metrics

In the following, we describe this aspect and comparison of a proposed adder with some recent adder.

### A. Accuracy Metrics Aspect

The accuracy of the proposed adder is compared with the five latest cutting edge approximate adders. These adders are HABA, [34], GeAr [21], RAP-CLA [24], simple Yet efficient accuracy-configurable adder (SARA) [25] and block-based carry speculative approximate adder (BCSA) [2]. The error metrics are obtained using Monte Carlo simulation.

In this study, the error metrics which are used for the comparison of the proposed adders are Mean Error Distance (MED, mean of all possible EDs), Normalized Mean Error Distance (NMED, the normalization of MED by the maximum output), Error Rate (ER) and Mean Relative Error Distance (MRED)[2]. ER and MED are described above, and NMED and MRED for  $n$ -bit adder are acquired by:

$$NMED = \frac{1}{2^n} \sum_{i=1}^N MED \quad (44)$$

$$MRED = \frac{1}{N} \sum_{i=1}^N \frac{|S_i - S'_i|}{S_i} \quad (45)$$

Where  $S_i$  and  $S'_i$  represent the total sum of the accurate adder and the approximate adder, respectively. Besides,  $N$  shows the number of samples, which is used in the Monte Carlo simulation.

We implement our proposed adder in python for calculating the above error metrics to compare with other proposed adders. The accuracy of the proposed adder under the different size of the block and various input bit length is shown in figure 14.

Hence, the error metrics are obtained using Monte Carlo simulation with 10 million samples with a uniform random number for 16 and 32 bits adders, though for 8 bits adders using  $2^{16}$  input combination in exhaustive simulation. The adder is divided into half heterogeneous approximate block and half accurate block. The heterogeneous approximate block is divided into two sub-groups. The carry is truncated, and half of the LSBs are replaced with OR gates in the first sub-group, whereas the length of carry chain is half of MSBs and half of LSBs are replaced with OR gates in the second sub-group.

The error metrics such as NMED and MRED are the lowest in the proposed adders. In comparison with BCSA, which has the lowest NMED and MRED among the other adders, we manage to reach, on average, 2 times lower in 8-bits adder, and 28 times and 7400 times lower in 16-bits and 32-bits, respectively. The MRED and NMED values are decreasing by

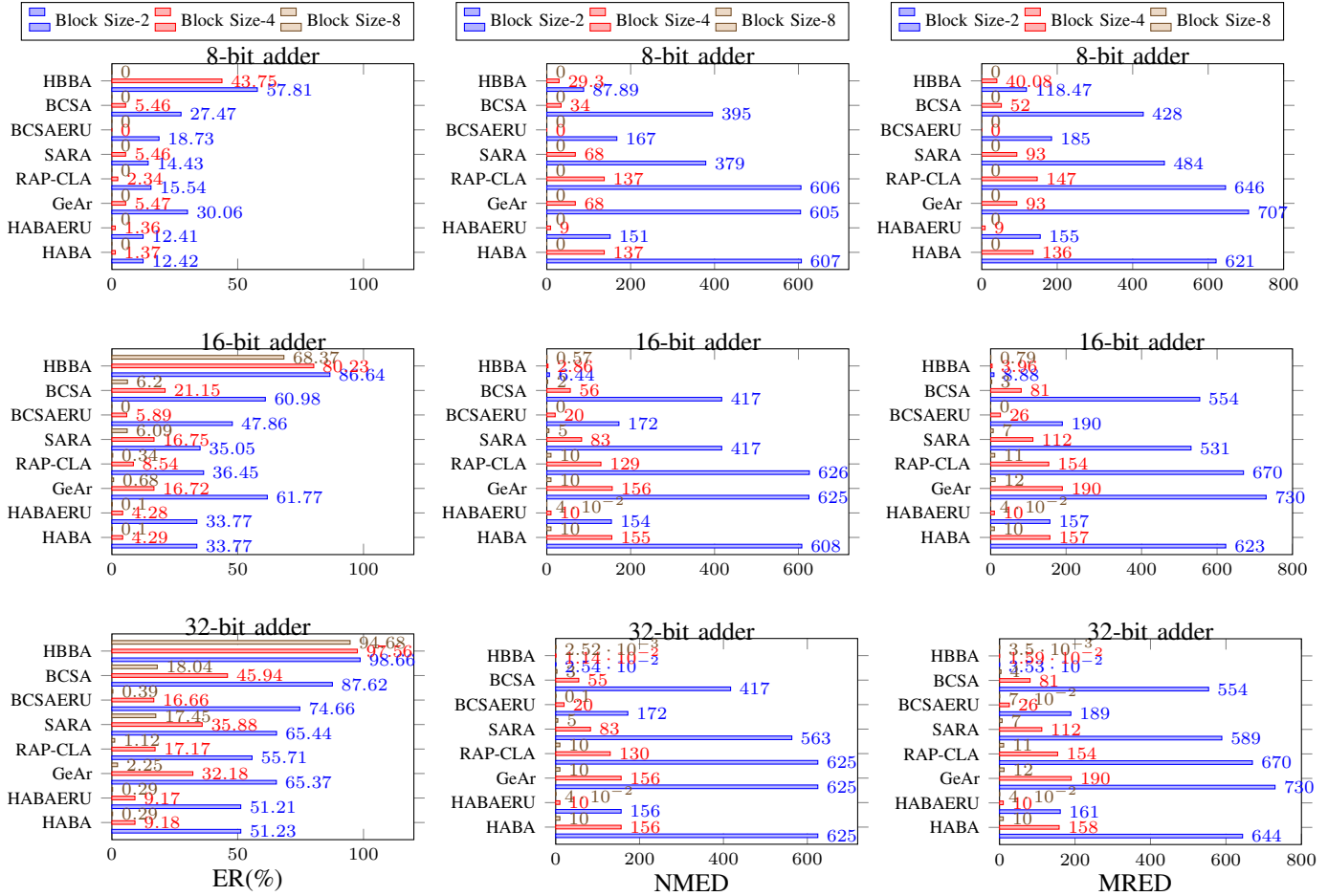

Figure 14. Compare Accuracy of Proposed Approximate Adder with State-of-the-Art Approximate Adders

increasing the size of the adder. In the proposed adder, every increment in block size causes a 3 times reduction in MRED and NMED. Similarly to the block size, by increasing the size of an adder, the accuracy increases; for example, the 16-bits adder has about 15 times NMED and MRED smaller than 32 bits adders. However, the result indicated that the error rate is the highest in the proposed adder due to the OR gates replacement. In comparison with HABA, which has the lowest ER among the other adders, our adder’s ER has about 3 times higher ER for 2-bit blocks size. The ER increases to 20 times and 300 times higher than HABA for 4 bits and 8 bits blocks size, respectively.

In order to validate the proposed analytical model of the heterogeneous approximate adder, we compared the analytical analysis with Monte Carlo simulation using 10 million uniform randomly inputs. We calculated error metrics (MED and ER) using Monte Carlo simulation as a benchmark for comparison. The MED values in the analytical model are obtained based on the PMF of error values using Eq. (35). Moreover, the ER is calculated based on the analytical Eq. 32. The comparison is performed for a range of Carry chain length values ( $S$ ) and the different number of replacement OR gates ( $L$ ).

The figure 15 shows PMF error values in 16-bit heteroge-

neous BBA, where we have 4 blocks, including 2 accurate and 2 approximate blocks. The heterogeneous adders are shown with different values of  $S$  and  $L$ . The PMF shown in each sub-figure is made up of discrete impulses, which show the probability of error values.

The comparison of MED explained above and the error rate is reported in the tableIV. The deviation is calculated as a percentage of the difference between simulation and analysis results. The deviation values represent the marginal difference between the simulation and analysis values of the heterogeneous approximate adder.

### B. Hardware Metrics Aspect

Verilog HDL is applied to describe our proposed adder and other adders mentioned in SectionIV-A. The case study is a 32-bit adder with 4 bits sub-block and synthesized by Synopsys Design Compiler. These studies are synthesised using nangate 15nm FinFET Open Cell Library with 0.8V operating voltage level and at a temperature of 25°C. The hardware metrics considered as a basis for the adders’ comparison are delay, area, power and energy. The result of these metrics for 32-bit adder that includes 8 4-bit sub-adder with configuration of HBBA{[4,4,4,2],[0,0,0,2]} is reported in the tableV. To obtain

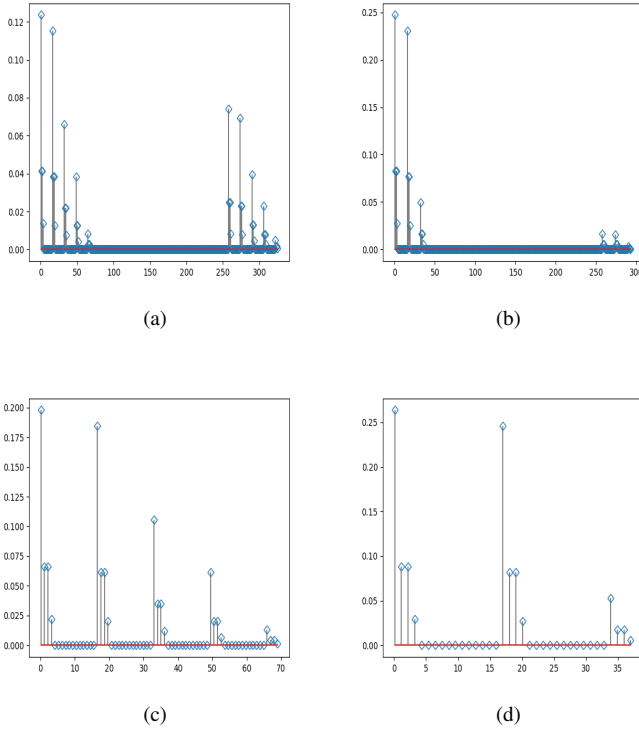

Figure 15. PMF of error value in 16-bit proposed adder using 4-bit sub-adder with uniformly distributed (a) HBBA{[2,2],[0,0]} (b) HBBA{[2,1],[0,2]} (c) HBBA{[2,2],[0,2]} (d) HBBA{[2,1],[0,3]}

Table IV  
MED COMPARISON OF SIMULATION AND ANALYSIS

Adders type	Error metrics	Simulation	Analysis
HBBA{[2,2],[0,0]}	MED	114.764395	114.75
HBBA{[2,2],[0,0]}	error_rate	0.876526	0.876403809
HBBA{[2,2],[0,1]}	MED	50.652665	50.75
HBBA{[2,2],[0,1]}	error_rate	0.826809	0.826965332
HBBA{[2,2],[0,2]}	MED	18.757755	18.75
HBBA{[2,2],[0,2]}	error_rate	0.802274	0.802246094
HBBA{[2,2],[0,3]}	MED	29.394021	29.42
HBBA{[2,2],[0,3]}	error_rate	0.802088	0.802246094
HBBA{[2,1],[0,2]}	MED	26.815995	26.75
HBBA{[2,1],[0,2]}	error_rate	0.752998	0.747314453
HBBA{[2,1],[0,3]}	MED	10.755323	10.75
HBBA{[2,1],[0,3]}	error_rate	0.736438	0.736328125
HBBA{[1,1],[0,3]}	MED	11.254259	11.25
HBBA{[1,1],[0,3]}	error_rate	0.683849	0.68359375

the adders' power and energy, we injected 10 million random inputs into the netlist of synthesized adders to evaluate the internal activity nodes. We stored them in a VCD format file by ModelSim tool. In addition, the power is extracted based on the VCD file by using Synopsys PrimeTime. Delay and area are determined by Synopsys Design Compiler as well.

As the table indicates, the delay of the heterogeneous proposed adder is higher from RAP-CLA and GeAr. However, in area and power, we have the lowest value among the other adders. The proposed adder has about 38% higher delay, but

Table V  
HARDWARE METRICS OF 32 BITS ADDER CONSIST OF 4 BITS SUB BLOCK

Adder	Delay (pS)	Area ( $\mu m^2$ )	Power ( $\mu W$ )	Energy (aJ)
CLA	99.44	89.8	58.22	5789
HABAERU	88.3	66.47	51.49	4547
GeAr	48.45	80.61	42.91	2079
RAP-CLA	44.84	65.66	41.8	1874
HBBA	61.87	55.984	25.93	1604

18% and 62% improved in area and power compared to RAP-CLA. Moreover, the proposed adder has the lowest energy among the other adders. Comparing to RAP-CLA, the energy of the proposed adder improve about 17%.

### C. The trade-off between error and hardware metrics aspect

Design metrics such as hardware and accuracy vary in different applications, and they depend on  $L$  and  $S$  in  $N$ -bits adder. Depending on the application, we need to perform a trade-off between accuracy identified by MED or ER and the hardware metrics such as area, delay and power. The optimal configuration can be modelled as an optimisation framework, including minimum hardware metrics as an objective function for a given accuracy level, where accuracy (MED) is modelled as a hard constraint.

The MED is measured by Eq. 35 and delay, area and power are assessed by Eqs.38, 40 and 43, respectively. Therefore, the designer can find optimal configuration subjected to specific MED for a given  $N$ -bit adder based on optimising framework. The optimal configuration is the value of  $L$  and  $S$  in a various number of the approximate block, which is used in  $N$ -bit adder. Figure 16 is shown the design point configurations for 16-bit adder consisting of 4 blocks with 4 bits length for each possible value of  $L$  and  $S$ . It can be observed the optimal configuration provide minimal delay, area and power for each given MED. Figures 16a, 16c and 16d compare the delay, area and power vs MED design space of LOA with HBBA. It can be observed the optimal HBBA provide the best possible configuration. Note that in figure 16 the efficient architecture can be selected from design spaces by considering MED and priority of delay, area or power for the desired application.

## V. CONCLUSION

In this paper, we propose the heterogeneous block-based approximate adder design. It consists of the non-overlap block, which can be an accurate block or approximate block. The approximate block generates an error which is consisted the inexact logic configuration and truncation carry chain. The probability of error analysis for HBBA is presented. The model can be applied to the different configuration of the proposed adder to evaluate the occurrence of error and the PMF of error value without the need for the Monte-Carlo simulation. The analytical model can provide useful error metrics to compare the various configuration of the approximate adder. We observed various configuration with the same accuracy. Therefore, in order to find the optimal configuration, we use the estimation model for hardware metrics such as delay, area

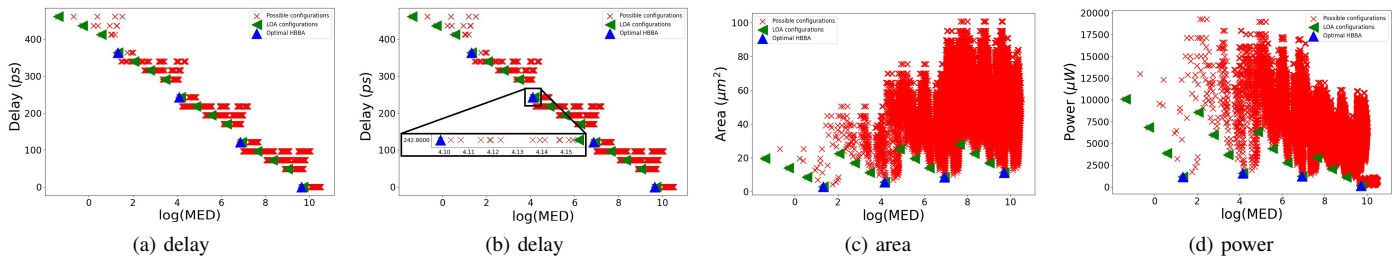

Figure 16. Optimal configuration for delay, area and power

and power. The designer can find the best optimal configuration by noticing the application's desire accuracy based on the analytical model and estimation model as the optimiser framework.

#### REFERENCES

- [1] Q. Xu, T. Mytkowicz, and N. S. Kim, "Approximate computing: A survey," *IEEE Design & Test*, vol. 33, no. 1, pp. 8–22, 2015.
- [2] F. Ebrahimi-Azandaryani, O. Akbari, M. Kamal, A. Afzali-Kusha, and M. Pedram, "Block-based carry speculative approximate adder for energy-efficient applications," *IEEE Transactions on Circuits and Systems II: Express Briefs*, 2019.
- [3] H. Jiang, J. Han, and F. Lombardi, "A comparative review and evaluation of approximate adders," in *Proceedings of the 25th edition on Great Lakes Symposium on VLSI*, 2015, pp. 343–348.
- [4] B. Parhami, *Computer arithmetic*, 00. Oxford university press, 2010, vol. 20.
- [5] V. Gupta, D. Mohapatra, S. P. Park, A. Raghunathan, and K. Roy, "Impact: Imprecise adders for low-power approximate computing," in *IEEE/ACM International Symposium on Low Power Electronics and Design*, IEEE, 2011, pp. 409–414.
- [6] B. S. Prabhakaran, S. Rehman, M. A. Hanif, S. Ullah, G. Mazaheri, A. Kumar, and M. Shafique, "Demas: An efficient design methodology for building approximate adders for fpga-based systems," in *2018 Design, Automation & Test in Europe Conference & Exhibition (DATE)*, IEEE, 2018, pp. 917–920.
- [7] G. Karakonstantis and K. Roy, "Voltage over-scaling: A cross-layer design perspective for energy efficient systems," in *2011 20th European Conference on Circuit Theory and Design (ECCTD)*, IEEE, 2011, pp. 548–551.
- [8] P. K. Krause and I. Polian, "Adaptive voltage over-scaling for resilient applications," in *2011 Design, Automation & Test in Europe*, IEEE, 2011, pp. 1–6.
- [9] Y. Kim, S. Venkataramani, K. Roy, and A. Raghunathan, "Designing approximate circuits using clock overgating," in *Proceedings of the 53rd Annual Design Automation Conference*, 2016, pp. 1–6.
- [10] V. Gupta, D. Mohapatra, A. Raghunathan, and K. Roy, "Low-power digital signal processing using approximate adders," *IEEE Transactions on Computer-Aided Design of Integrated Circuits and Systems*, vol. 32, no. 1, pp. 124–137, 2012.
- [11] Y. Chen, H. Li, J. Li, and C. Koh, "Variable-latency adder (vl-adder): New arithmetic circuit design practice to overcome nbtI," in *Proceedings of the 2007 international symposium on Low power electronics and design (ISLPED '07)*, 2007, pp. 195–200.
- [12] H. R. Mahdiani, A. Ahmadi, S. M. Fakhraie, and C. Lucas, "Bio-inspired imprecise computational blocks for efficient vlsi implementation of soft-computing applications," *IEEE Transactions on Circuits and Systems I: Regular Papers*, vol. 57, no. 4, pp. 850–862, 2009.
- [13] Z. Yang, A. Jain, J. Liang, J. Han, and F. Lombardi, "Approximate xor/xnor-based adders for inexact computing," in *2013 13th IEEE International Conference on Nanotechnology (IEEE-NANO 2013)*, 2013, pp. 690–693.
- [14] A. K. Verma, P. Brisk, and P. Jenne, "Variable latency speculative addition: A new paradigm for arithmetic circuit design," in *Proceedings of the conference on Design, automation and test in Europe*, 2008, pp. 1250–1255.
- [15] Y. Kim, Y. Zhang, and P. Li, "An energy efficient approximate adder with carry skip for error resilient neuromorphic vlsi systems," in *2013 IEEE/ACM International Conference on Computer-Aided Design (ICCAD)*, IEEE, 2013, pp. 130–137.
- [16] R. Ye, T. Wang, F. Yuan, R. Kumar, and Q. Xu, "On reconfiguration-oriented approximate adder design and its application," in *2013 IEEE/ACM International Conference on Computer-Aided Design (ICCAD)*, IEEE, 2013, pp. 48–54.
- [17] N. Zhu, W. L. Goh, W. Zhang, K. S. Yeo, and Z. H. Kong, "Design of low-power high-speed truncation-error-tolerant adder and its application in digital signal processing," *IEEE transactions on very large scale integration (VLSI) systems*, vol. 18, no. 8, pp. 1225–1229, 2009.
- [18] N. Zhu, W. L. Goh, G. Wang, and K. S. Yeo, "Enhanced low-power high-speed adder for error-tolerant application," in *2010 International SoC Design Conference*, IEEE, 2010, pp. 323–327.

- [19] N. Zhu, W. L. Goh, and K. S. Yeo, "Ultra low-power high-speed flexible probabilistic adder for error-tolerant applications," in *2011 International SoC Design Conference*, IEEE, 2011, pp. 393–396.
- [20] V. Camus, M. Cacciotti, J. Schlachter, and C. Enz, "Design of approximate circuits by fabrication of false timing paths: The carry cut-back adder," *IEEE Journal on Emerging and Selected Topics in Circuits and Systems*, vol. 8, no. 4, pp. 746–757, 2018.
- [21] M. Shafique, W. Ahmad, R. Hafiz, and J. Henkel, "A low latency generic accuracy configurable adder," in *2015 52nd ACM/EDAC/IEEE Design Automation Conference (DAC)*, IEEE, 2015, pp. 1–6.
- [22] M. Pashaeifar, M. Kamal, A. Afzali-Kusha, and M. Pedram, "Approximate reverse carry propagate adder for energy-efficient dsp applications," *IEEE Transactions on Very Large Scale Integration (VLSI) Systems*, vol. 26, no. 11, pp. 2530–2541, 2018.
- [23] M. A. Hanif, R. Hafiz, O. Hasan, and M. Shafique, "Quad: Design and analysis of quality-area optimal low-latency approximate adders," in *Proceedings of the 54th Annual Design Automation Conference 2017*, 2017, pp. 1–6.
- [24] O. Akbari, M. Kamal, A. Afzali-Kusha, and M. Pedram, "Rap-cla: A reconfigurable approximate carry look-ahead adder," *IEEE Transactions on Circuits and Systems II: Express Briefs*, vol. 65, no. 8, pp. 1089–1093, 2016.
- [25] W. Xu, S. S. Sapatnekar, and J. Hu, "A simple yet efficient accuracy-configurable adder design," *IEEE Transactions on Very Large Scale Integration (VLSI) Systems*, vol. 26, no. 6, pp. 1112–1125, 2018.
- [26] S. Mazahir, O. Hasan, R. Hafiz, M. Shafique, and J. Henkel, "Probabilistic error modeling for approximate adders," *IEEE Transactions on Computers*, vol. 66, no. 3, pp. 515–530, 2016.
- [27] D. Celia, V. Vasudevan, and N. Chandrathoodan, "Probabilistic error modeling for two-part segmented approximate adders," in *2018 IEEE International Symposium on Circuits and Systems (ISCAS)*, IEEE, 2018, pp. 1–5.
- [28] S. Dutt, S. Dash, S. Nandi, and G. Trivedi, "Analysis, modeling and optimization of equal segment based approximate adders," *IEEE Transactions on Computers*, vol. 68, no. 3, pp. 314–330, 2018.
- [29] M. K. Ayub, M. A. Hanif, O. Hasan, and M. Shafique, "Peal: Probabilistic error analysis methodology for low-power approximate adders," *ACM Journal on Emerging Technologies in Computing Systems (JETC)*, vol. 17, no. 1, pp. 1–37, 2020.
- [30] M. A. Hanif, R. Hafiz, O. Hasan, and M. Shafique, "Pemacx: A probabilistic error analysis methodology for adders with cascaded approximate units," in *2020 57th ACM/IEEE Design Automation Conference (DAC)*, IEEE, 2020, pp. 1–6.
- [31] Y. Wu, Y. Li, X. Ge, Y. Gao, and W. Qian, "An efficient method for calculating the error statistics of block-based approximate adders," *IEEE Transactions on Computers*, vol. 68, no. 1, pp. 21–38, 2018.
- [32] A. Leon-Garcia, "Probability, statistics, and random processes for electrical engineering," 2017.
- [33] N. Weste and D. Harris, "Cmos vlsi design: A circuits and systems perspective," 2010.
- [34] J. Hu and W. Qian, "A new approximate adder with low relative error and correct sign calculation," in *2015 Design, Automation Test in Europe Conference Exhibition (DATE)*, 2015, pp. 1449–1454.



**Ebrahim Farahmand** (S'20) is a Ph.D. student at the Department of Electrical Engineering, Shahid Bahonar University of Kerman (SBUK), Iran. He received the B.Sc. degree in Electrical Engineering-Communication systems in 2012 and the M.Sc. degree in Electrical Engineering-Electronics in 2016, both from Shahid Bahonar University of Kerman (SBUK). From 2016 to 2017, he worked as a Research Associate in the Reliable and Smart System (RSS) lab, SBUK, Iran. His research interests include brain-inspired computing, approximate

computing, machine learning accelerator, Fault-tolerant design and Network systems.



**Ali Mahani** received the B.Sc. degree in electronic engineering from Shahid Bahonar University of Kerman, Iran, in 2001, The M.Sc. and Ph.D. degrees both in Electronic Engineering from Iran University of Science and Technology (IUST), Tehran, Iran, in 2003 and 2009 respectively. Since then he has been with the electrical engineering department of Shahid Bahonar University of Kerman, where he is currently an associate professor. His research interests focus on Fault-tolerant design, FPGA-based accelerators, approximate digital circuits, stochastic computing

and Networked System.



**Muhammad Abdullah Hanif** is a Ph.D. student at the Faculty of Informatics, Technische Universität Wien (TU Wien), Vienna, Austria. In the past, he has worked as a Research Associate in Vision Processing (VISpro) lab, Information Technology University (ITU), Pakistan, and as a Lab Engineer in Ghulam Ishaq Khan Institute of Engineering Sciences and Technology (GIKI), Pakistan. He currently holds a Master of Science degree in Electrical Engineering from the School of Electrical Engineering and Computer Science (SEECs), National University of

Sciences and Technology (NUST), Islamabad, Pakistan, and a Bachelor of Science degree in Electronic Engineering from GIKI, Pakistan. His research interests include brain-inspired computing, machine learning, approximate computing, computer architecture, energy-efficient design, robust computing, system-on-chip design, and emerging technologies.



**Muhammad Shafique** received his Ph.D. in computer science from the Karlsruhe Institute of Technology (KIT), Germany, in 2011. From Oct.2016 to Aug.2020, he was a full professor at the Institute of Computer Engineering, Faculty of Informatics, TU Wien, Vienna, Austria. Since Sep.2020, he is with the Division of Engineering, New York University Abu Dhabi (NYU-AD), United Arab Emirates, and is a Global Network faculty at the NYU Tandon School of Engineering, USA. His research interests are in system level design for brain-inspired computing, AI & machine learning hardware, wearables, autonomous systems, energy-efficient and robust computing, with applications in Internet-of-Things and smart Cyber-Physical Systems. Dr. Shafique has given several Keynotes, Invited Talks, and Tutorials, as well as organized many special sessions at premier venues. He has served as the PC Chair, General Chair, Track Chair, and PC member for several prestigious IEEE/ACM conferences. He received the 2015 ACM/SIGDA Outstanding New Faculty Award, AI 2000 Chip Technology Most Influential Scholar Award in 2020, six gold medals, and several best paper awards and nominations at prestigious conferences.