

# IM-META: Influence Maximization Using Node Metadata in Networks With Unknown Topology

Cong Tran, *Student Member, IEEE*, Won-Yong Shin, *Senior Member, IEEE*, and Andreas Spitz

**Abstract**—In real-world applications of influence maximization (IM), the network structure is often *unknown*. In this case, we may identify the most influential seed nodes by exploring only a part of the underlying network given a small budget for node queries. Motivated by the fact that collecting node metadata is more cost-effective than investigating the relationship between nodes via *queried nodes*, we develop IM-META, an end-to-end solution to IM in networks with unknown topology by retrieving information from both queries and node metadata. However, using such metadata to aid the IM process is not without risk due to the noisy nature of metadata and uncertainties in connectivity inference. To tackle these challenges, we formulate an IM problem that aims to find two sets, i.e., seed nodes and queried nodes. We propose an effective method that *iteratively* performs three steps: 1) we learn the relationship between collected metadata and edges via a *Siamese neural network* model, 2) we select a number of inferred influential edges to construct a *reinforced* graph used for discovering an optimal seed set, and 3) we identify the next node to query by maximizing the inferred influence spread using a *topology-aware* ranking strategy. By querying only 5% of nodes, IM-META reaches 93% of the upper bound performance.

**Index Terms**—Inference; influence maximization; node metadata; node query; Siamese neural network; topologically unknown network.



## 1 INTRODUCTION

### 1.1 Background and Motivation

SOCIAL networks that encode the relationships and interactions of individuals play a vital role as a medium for facilitating the sharing of ideas, thoughts, and information through the building of virtual networks and communities. Well-known applications of such social networks include viral marketing—for example, a company would like to hire the most influential opinion leaders to advertise a new product. To this end, the so-called *influence maximization (IM)* problem that aims at identifying a set of seed nodes, leading to the maximum influence spread under given influence diffusion models, was introduced as a formalization [1]. In addition to (viral) marketing in social networks, efficient solutions to the IM problem stand to benefit applications in numerous domains such as microfinance [2] and healthcare [3].

In the original IM problem, the topological structure of the underlying social network is assumed to be fully available [1]. Despite the growing popularity of studies on IM, such an assumption is hardly realistic as the underlying *true* network is not initially known in various domains of

real-world network applications [4], [5]. Although we can reconstruct the complete network so that existing IM algorithms may be applied afterwards, retrieving relationships among nodes in a network is very labor-intensive and thus collecting a complete network structure is often considered impractical [4]. To overcome this problem, one could alternatively leverage social network data to infer unknown relationships. However, even with the increasing availability of social media platforms, this source of information is not without limitations such as restricted resources and privacy settings specified by users. For example, 52.6% of Facebook users hid their friends in a demographic analysis of Facebook in New York City in June 2011 [6]. Since June 2019, Twitter has begun limiting access to its Application Programming Interface (API) to 100,000 requests per day,<sup>1</sup> which may hamper the acquisition of a complete sample of the Twitter network. Moreover, such connectivity information often includes many weak links, which are not effective maximizing the influence spread, e.g., users may have hundreds of friends on Facebook whom they barely know [7]. Consequently, we are able to observe only a part of the network structure in many practical situations (see [8], [9], [10] and references therein).

On the other hand, when it comes to networks with unknown topology, a question that arises naturally is: “How can we identify a set of seed nodes that indeed necessitates the network structure?”. Recent studies have addressed this question by allowing a small budget for *node queries* so that a part of the underlying network is explored, corresponding to network discovery, while aiming to find a set of seed nodes from the explored subgraph that is expected to be as influential as the globally optimal seed set [3], [11], [12], [13], [14]. To aid the network discovery process, existing methods

- C. Tran is with the Department of Computer Science and Engineering, Dankook University, Yongin 16890, Republic of Korea, and also with the Machine Intelligence & Data Science Laboratory, Yonsei University, Seoul 03722, Republic of Korea.  
E-mail: congtran@ieee.org.
- W.-Y. Shin is with the School of Mathematics and Computing (Computational Science and Engineering), Yonsei University, Seoul 03722, Republic of Korea.  
E-mail: wy.shin@yonsei.ac.kr.
- A. Spitz is with the Department of Computer and Information Science, University of Konstanz, Konstanz 78457, Germany.  
E-mail: andreas.spitz@uni-konstanz.de.  
(Corresponding author: Won-Yong Shin.)

1. <https://developer.twitter.com>.

exploit rich complementary information such as the community structure [13] or a set of similar graphs [14]. However, such data are scarcely available under the topology-unaware setting of many real-world networks. Meanwhile, node metadata (i.e., node features) can be retrieved from various sources such as users’ created content and thus are much more readily collected than the relationship between individuals [15]. For example, in co-authorship networks, we may take advantage of the keywords in each author’s publications to infer a potential relationship between authors if their papers contain similar keywords. Although attempts have been made to exploit certain forms of *difficult-to-collect* node metadata [3], the metadata collection under consideration is entirely handcrafted, requiring a significant annotation effort by domain experts.

## 1.2 Main Contributions

In this paper, we consider real-world applications of IM in which the underlying network  $G$  is *initially unknown*. Motivated by the fact that collecting metadata of nodes such as node features is cost-effective, we present IM-META, an end-to-end framework for effectively solving the IM problem in  $G$  using node queries aided by *node metadata*. To this end, we aim at retrieving information from *jointly* discovering a sequence of node queries and a set of nodes maximizing the influence spread. However, unlike the conventional setting of IM [1], [16], [17], [18], our problem is ill-defined due to the uncertainty of the unexplored part of  $G$  that is not obtained from node queries. In our study, we resolve this issue by making full use of the available node metadata in order to infer the connections between two nodes in the unexplored part. From this inferred network structure, it is possible to formulate a new optimization problem that jointly finds the optimal discovered subgraph and seed set in the sense of maximizing an *estimate* of the expected influence spread.

Nonetheless, solving this optimization problem poses many practical challenges. First, using the node metadata to aid the IM process is not without risk due to the noisy nature of collected features. Second, we suffer from the lack of labels in training because of only a small budget for node queries. The redundancy of inherently noisy features along with a small number of queries leads to the curse of dimensionality, which would significantly degrade the performance in terms of inference accuracy. Third, the problem is highly intractable in not only searching for the two optimal sets (i.e., the optimal subgraph and seed nodes) but also dynamically updating an estimate of the expected influence spread for every query step.

Our proposed IM-META method, consisting of two phases for (I) network discovery and (II) seed set selection, tackles the aforementioned challenges by judiciously establishing new design principles, as illustrated in Fig. 1. As our main contributions, IM-META *iteratively* performs the following three steps for network discovery. As the first step of each iteration, we infer a set of probabilities of unexplored edges using both the node metadata and the currently explored subgraph. To this end, we design a minimally supervised learning architecture using the explored small-size subgraph as training data, which is based on a *Siamese neural network* model that is capable of learning the

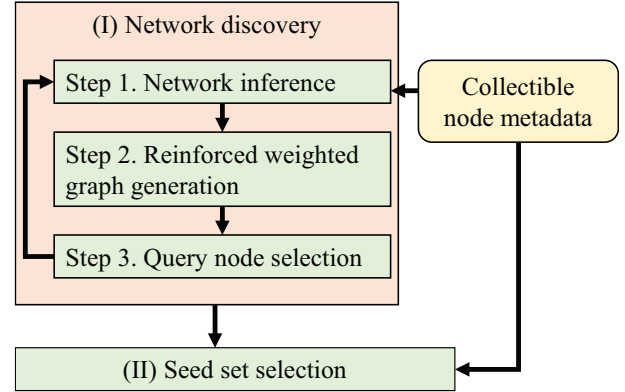

Fig. 1: Network discovery and seed set selection using node metadata in IM-META.

relationship between collected metadata and edge prediction. By learning embeddings that accurately capture the *homophily* effect of information diffusion networks, which reveals the tendency of an individual node to associate with similar other nodes, our trained Siamese neural network *inductively* maps new input data (i.e., unexplored nodes) whose connectivity information to the training data (i.e., explored nodes) is unknown. The learned embedding acts as a feature selection (or dimensionality reduction) module that captures the latent representation of collected data. As the second step, we generate a *reinforced* weighted graph by seamlessly combining the edge probabilities inferred in the previous step with the current explored subgraph. Toward this end, we select only a limited number of *confidence edges* based on the intuitions that i) using a large portion of uncertain edges leads to an accumulation of noise in the subsequent processes and that ii) this edge selection also reduces the computational complexity. As the third step, we select a queried node as the last step of an iteration for network discovery. As one of our main contributions, instead of choosing a queried node based on high degree centrality in the observable subgraph, we propose our own *topology-aware* ranking strategy for query node selection. Specifically, the proposed ranking measure balances between the degree centrality of a target node and its geodesic distance to potential seeds. The node selected from this ranking strategy at each query step potentially leads to a high expected influence spread. After the network discovery phase, we finally select a set of seed nodes similarly as in the standard IM problem [1], [16], [17], [18]. An analysis of the computational complexity of our IM-META method shows that the complexity is dominated by the seed set selection phase rather than the network discovery phase and falls within the same bound as that of a greedy algorithm that works on the fully known network.

To validate the superiority of the proposed IM-META method, we comprehensively perform empirical evaluation for various real-world attributed networks. Experimental results show that our method consistently outperforms benchmark IM approaches in terms of the expected influence spread. The results also demonstrate the robustness of our method in more difficult and challenging situations where

TABLE 1: Summary of notations

| Notation                    | Description   |
|-----------------------------|---|
| $G$                         | underlying graph  |
| $G_t$                       | explored subgraph at the $t$ -th query step             |
| $\mathcal{V}_t$             | set of nodes in $G_t$                                   |
| $\mathcal{E}_t$             | set of edges in $G_t$                                   |
| $\mathcal{X}$               | set of node features                                    |
| $k$                         | number of seed nodes                                    |
| $S$                         | set of influential seed nodes                           |
| $T$                         | number of node queries                                  |
| $\Theta^{(t)}$              | set of edge probabilities inferred at the $t$ -th query |
| $G_{\text{gen-prun}}^{(t)}$ | reinforced weighted graph after $t$ node queries        |

a large portion of node metadata are missing. Moreover, we investigate the hyperparameter sensitivity by showing the impact of each parameter on the performance of IM-META.

Our contributions are five-fold and are summarized as follows:

- We introduce IM-META, a novel end-to-end framework for solving the IM problem in topologically unknown networks;
- We formulate our optimization problem that aims to find both a set of seed nodes and another set of nodes to query by making use of node metadata;
- We design an effective approach for network discovery that iteratively performs network inference, reinforced weighted graph generation, and query node selection;
- We analyze the computational complexity of IM-META;
- We validate the superiority of our IM-META method over benchmark IM methods through extensive experiments using real-world datasets with node features across several domains.

To the best of our knowledge, this is the first proposed solution to the IM problem in attributed networks with unknown topology.

### 1.3 Organization and Notation

The remainder of this paper is organized as follows. In Section 2, we present prior studies related to our work. In Section 3, we explain the methodology of our study, including the problem formulation and an overview of our IM-META method. Section 4 describes technical details of the proposed method and analyzes its computational complexity. Experimental results are shown in Section 5. Finally, we provide a summary and concluding remarks in Section 6.

Table 1 summarizes the notation that is used in this paper. This notation will be formally defined in the following sections when we introduce our methodology and the technical details.

## 2 RELATED WORK

Our proposed method is related to three broader areas of research, namely IM in topologically known networks, IM in

topologically unknown networks, and link prediction using metadata.

**IM in topologically known networks.** Kempe et al. [1] originally introduced the problem formulation of IM when the network structure is initially known and proposed a greedy approach to solve it. Besides heuristic solutions that are scalable to large-scale networks [19], [20], many following-up studies in this field focused mostly on reducing the computational complexity of greedy algorithms, such as CELF [16], TIM/TIM+ [18], IMM [17], and SSA/D-SSA [21], while providing approximate solutions with performance guarantees. Apart from the complexity reduction, other approaches include but are not limited to new optimization methods [22], [23] and IM in multiplex networks [24]. For a more thorough summary, see [25], for an in-depth performance comparison and discussion of approaches in the literature, see [26].

**IM in topologically unknown networks.** More recently, researchers have paid attention to a more challenging IM problem where the structure of the underlying network is initially unknown. Following the concept of active learning for classification [27], [28], dynamic IM over a series of rounds in which information on edges is collected after each round has been studied [3], [12]. Exploratory IM (EIM) was introduced along with a solution that queries individual nodes to learn their edges by assuming that the underlying network is built upon a stochastic block model [13]. As follow-up studies on EIM, CHANGE [11] and Geometric-DQN [14] were presented using the friendship paradox and patterns learned from a set of similar graphs, respectively. A theoretical analysis on the performance of IM was studied in settings where a subgraph is retrieved via random node sampling [29], [30]. Another attempt to solve the IM problem in unknown networks involves learning an influence function based on observed cascades [31].

**Link prediction using metadata.** When the network structure is partially observable, several methods such as a matrix factorization-aided approach [32] were proposed to leverage node features for link prediction. Our study is rather related to the *inductive* link prediction problem, the so-called cold-start link prediction, in which no initial topological information is available. To achieve satisfactory prediction performance, deep learning-based techniques such as G2G [33] and DEAL [34] were presented, which use a deep encoder that embeds each node in a given network as Gaussian distributions and aligning both structure and feature embeddings, respectively.

**Discussions.** Despite many contributions to IM in unknown networks, our study is the first solution that exploits the collected *node metadata* to aid the process of discovering influential seed nodes. Unlike prior studies that perform inductive link prediction in a supervised manner, our solution tackles the challenge of a lack of explored edges that can be used as labels in training when only a small portion of the underlying network is observable via node queries. This motivates us to design a novel learning model for solving the IM problem in order to capture the relationship between the collected metadata and the underlying network structure.

### 3 METHODOLOGY

As a basis for the proposed IM-META method in Section 4, we first describe our network and influence diffusion models with basic assumptions. We then formulate a new problem under the model. Finally, we introduce our research methodology adopting a two-phase strategy to solve the problem of IM.

#### 3.1 System Model

##### 3.1.1 Network Model

Let us denote an underlying network as  $G = (\mathcal{V}, \mathcal{E})$ , which initially has an *unknown topology*, where  $\mathcal{V}$  is the set of  $n$  nodes and  $\mathcal{E}$  is the set of  $m$  edges. We assume  $G$  to be an undirected unweighted network without self-loops or repeated edges and to have collectible *node metadata* (i.e., node features)  $\mathcal{X}$  of all  $n$  nodes. The metadata in  $\mathcal{X}$  associated with each node  $v_i \in \mathcal{V}$  are assumed to be given in a vector form of  $d$  features, denoted as  $\mathbf{x}_i \in \mathbb{R}^d$ .

Following the definition by Kamarthi et al. [14], an induced subgraph  $G_0$  is assumed to be observable at a very early stage. When  $G_0$  is not initially available, such a subgraph can be obtained by querying a few nodes at random. To retrieve additional structural information from the underlying network  $G$ , we are allowed to perform  $T$  node queries. Specifically, when we query a single node, we are capable of discovering neighbors of the queried node. The observable subgraph can then be expanded accordingly, which essentially follows the same setting as prior work in the field [13], [14], [35].  $G_t = (\mathcal{V}_t, \mathcal{E}_t)$  is the subgraph discovered after  $t$  queries, where  $\mathcal{V}_t$  and  $\mathcal{E}_t$  are the set of nodes and the set of edges, respectively, in the subgraph  $G_t$ . During the  $(t + 1)$ -th node query, we choose a node  $v_t$  from  $G_t$ , which enables us to observe an expanded graph  $G_{t+1} = (\mathcal{V}_t \cup \mathcal{N}_G(v_t), \mathcal{E}_t \cup \mathcal{E}(\mathcal{N}_G(v_t), v_t))$ , where  $\mathcal{N}_G(v_t)$  indicates a set of neighbors of node  $v_t$  in  $G$  and  $\mathcal{E}(\mathcal{N}_G(v_t), v_t)$  is a set of all edges to which each node in  $\mathcal{N}_G(v_t)$  and node  $v_t$  are incident. An example of this query process is illustrated in Fig. 2, where an initially induced subgraph  $G_0$  consists of two nodes  $v_1$  and  $v_2$ , and we observe another graph  $G_1$  consisting of four nodes (i.e.,  $v_1, v_2, v_3$ , and  $v_5$ ) after querying node  $v_2$ . The finally discovered subgraph  $G_T = (\mathcal{V}_T, \mathcal{E}_T)$  is used as input of the IM process, where a set of seed nodes (i.e., a subset of observable nodes) of size  $k$ ,  $S \subseteq \mathcal{V}_T$ , is chosen to diffuse the influence.<sup>2</sup>

##### 3.1.2 Influence Diffusion Model

We consider two models of influence diffusion, namely the independent cascade (IC) and weighted cascade (WC) models [1], [19], [29]. Let us denote  $A_{u,v}$  as the event that a node  $u$  successfully activates another node  $v$  in the diffusion process. In the IC model, each edge  $(u, v)$ , incident to nodes  $u$  and  $v$ , is associated with a uniform diffusion probability  $p(A_{u,v})$  that represents the chance that the influenced node  $u$  successfully activates node  $v$ . In the WC model, this probability is modulated by the in-degree of node  $v$ , denoted as  $d_v$ , i.e., each edge from node  $u$  to  $v$  is assigned a probability

<sup>2</sup> Due to the limited availability of the network structure, it is typical to select seed nodes only among the retrieved nodes. We refer to [13], [14], [29] for more details.

$\frac{1}{d_v}$  of activating  $v$ . As in many previous studies [1], [17], [21], we assume that the diffusion process unfolds deterministically in discrete time steps. That is, the influence propagation occurs *only once* for each edge; this edge will not be used in the future spread of influence; and influenced nodes remain active during the whole diffusion process.

#### 3.2 Problem Formulation

In this subsection, we formulate a new IM problem under our setting assuming *topologically unknown* attributed networks with node features. In a given diffusion model, we define a function  $I(S) : 2^{\mathcal{V}_T} \rightarrow [0, n]$  that maps a seed set  $S$  to the number of influenced nodes in the underlying graph  $G$  at the end of the diffusion process, which is a random variable since the same set  $S$  results in different network realizations. In our study, based on the concept of active learning [27], [28], we aim to maximize the expected influence spread  $\sigma(S) = \mathbb{E}(I(S))$  by *jointly* finding a sequence of queries  $(v_0, v_1, \dots, v_{T-1})$  that leads to the finally discovered subgraph  $G_T$ , as well as a seed set  $S \subseteq \mathcal{V}_T$ , given a query budget  $T$  and a seed budget  $k$ . This is also referred to as an *exploratory IM* problem in the literature [13], [14]. In contrast to the conventional setting of IM [1], since the influence spread  $\sigma(\cdot)$  cannot be computed accurately from  $G$  due to the uncertainty of the unexplored part of  $G$ , our problem is ill-defined. Thus, we need to compute an estimate of  $\sigma(\cdot)$  based on the available information.

To this end, we first gradually infer the connections between two nodes in the unexplored part based on both the explored graph and the set of node features,  $\mathcal{X}$ , by repeatedly querying single nodes, which corresponds to *network inference* in our study. An edge  $(u, v) \notin \mathcal{E}_t$  that is incident to nodes  $u$  and  $v$  that have not yet been queried is referred to as an *uncertain edge*. We note that there are three types of such uncertain edges, including i) the edges connecting two nodes in  $\mathcal{V}_t$ , ii) the edges connecting one node in  $\mathcal{V}_t$  and another node in  $\bar{\mathcal{V}}_t$ , and iii) the edges connecting two nodes in  $\bar{\mathcal{V}}_t$ , where  $\bar{\mathcal{V}}_t$  is the set of unexplored nodes at the  $t$ -th query step such that  $\mathcal{V} = \mathcal{V}_t \cup \bar{\mathcal{V}}_t$  for two disjoint sets  $\mathcal{V}_t$  and  $\bar{\mathcal{V}}_t$ . Intuitively, during the  $t$ -th node query, we are capable of learning a *generative model of edges*, which approximates the distribution of all connections in  $G$  given the set of node features in  $\mathcal{V}_t$  and the subgraph  $G_t$  discovered after  $t$  queries as training samples. Using this learned model, we then predict the probability  $\theta_{uv}^{(t)} \in [0, 1]$  that an uncertain edge  $(u, v)$  is present, the so-called edge probability. The subgraph  $G_t$  and the set of  $\theta_{uv}^{(t)}$ 's for all uncertain edges are fed into the generator function of a weighted graph, denoted as  $G_{\text{gen}}^{(t)}$ , having all  $n$  nodes. By integrating the connectivity information of both observable and predicted edges via the generator function, we create  $G_{\text{gen}}^{(t)}$  whose adjacency matrix  $\mathbf{A}_{\text{gen}}^{(t)}$  is given by

$$a_{ij} = \begin{cases} 1, & \text{if } (i, j) \in \mathcal{E}_t \\ 0, & \text{if } (i, j) \notin \mathcal{E}_t \text{ and } i, j \notin \mathcal{Q}_t \\ \theta_{ij}^{(t)}, & \text{otherwise,} \end{cases}$$

where  $\mathcal{Q}_t$  is the set of all queried nodes until  $t$  queries and  $a_{ij}$  denotes the  $(i, j)$ -th element of  $\mathbf{A}_{\text{gen}}^{(t)}$  for  $i \neq j$ .

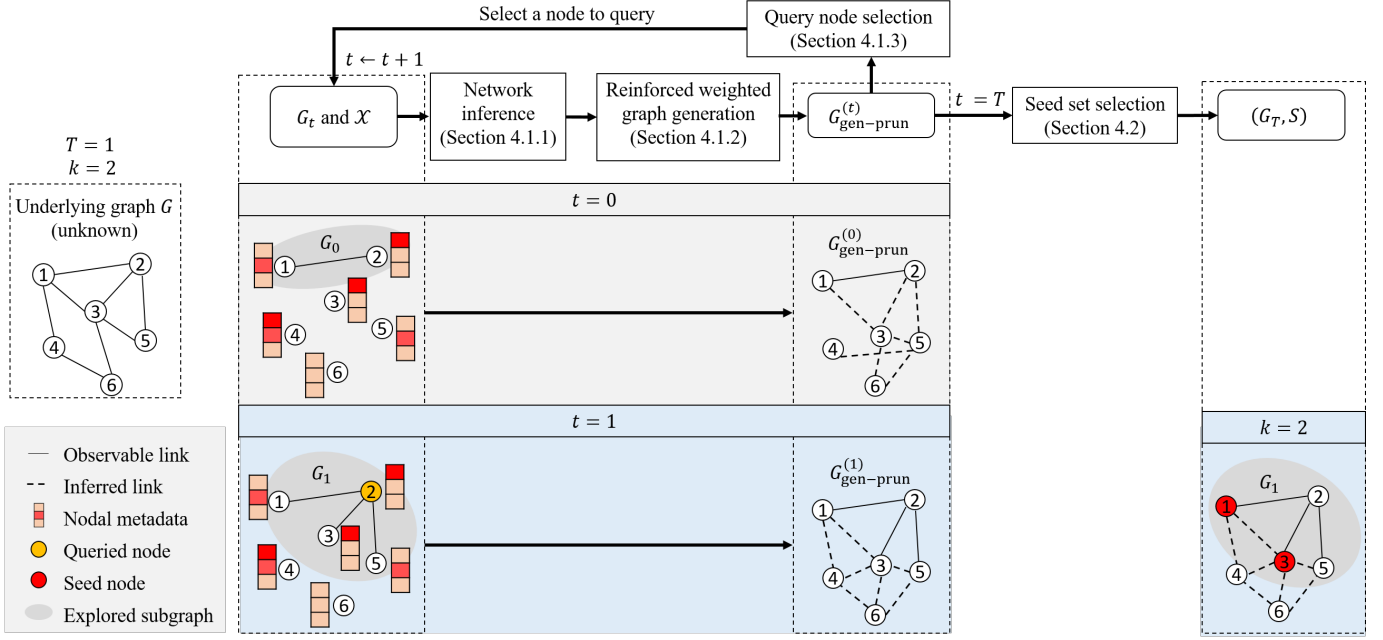

Fig. 2: Schematic overview of our proposed IM-META method. Here, after adding seven inferred edges to obtain  $G_{\text{gen-prun}}^{(0)}$ , node  $v_2$  (a filled-in yellow circle) is selected. Then, the seed set of two nodes  $v_1$  and  $v_3$  (filled-in red circles) is chosen from  $\mathcal{V}_1$  in the subgraph  $G_1$ .

Next, using the generated weighted graph  $G_{\text{gen}}^{(t)}$  we turn to explaining how to compute the estimate of the expected influence spread of  $\sigma(\cdot)$ , denoted as  $\hat{\sigma}(\cdot)$ . Let  $E_{u,v}$  denote the event that there exists an edge between nodes  $u$  and  $v$ . Then, it follows that  $p(E_{u,v}) = \theta_{uv}^{(t)}$ . From the fact that the event  $A_{u,v}$  is valid only when an incident edge  $(u,v)$  is present, the activation probability that models the strength of influence that node  $u$  has on another node  $v$  is expressed as the conditional probability  $p(A_{u,v}|E_{u,v})$ . Thus, we can compute the joint probability distribution  $p(E_{u,v}, A_{u,v})$  for each edge in  $\mathcal{E}_t$  using Bayes rule. Now, it is possible to compute an estimate  $\hat{\sigma}(S)$  given a set of seed nodes,  $S \subseteq \mathcal{V}_T$ , by taking the expectation over all edges  $(u,v)$  in  $G_{\text{gen}}^{(t)}$  via Monte-Carlo simulations. Finally, we are ready to formulate our new problem that aims at finding the optimal discovered subgraph and seed set  $(G_T^*, S^*)$  in the sense of maximizing  $\hat{\sigma}(S)$  as follows:

$$(G_T^*, S^*) = \arg \max_{G_T, S \subseteq \mathcal{V}_T, |S|=k} \hat{\sigma}(S). \quad (1)$$

We note that the inference accuracy of  $\hat{\sigma}(S)$  plays an important role in determining the influence (i.e., the number of activated nodes) in the network  $G$  since  $\hat{\sigma}(\cdot)$  is just an estimate of the actual expected spread. Thus, the designed method should consolidate an accurate estimate of  $\sigma(S)$ .

In our study, we tackle two practical challenges as follows: 1) we consider a realistic setting in which the number of queries that can be used to obtain training data for the generative model is strictly limited and 2) the problem of solving (1) is NP-hard with an exponential complexity in

searching for the two sets  $G_T$  and  $S$ .<sup>3</sup> This motivates us to present an *accurate* and *low-complexity* solution to this problem in (1).

### 3.3 Overview of IM-META

As an effective solution to the IM problem in (1), we propose the IM-META method consisting of two separate phases, namely *network discovery* and *seed set selection*, each of which is briefly summarized as follows.

**Network discovery.** During this phase, we *iteratively* perform the following three steps:

1. We infer the unexplored part of a network via a *Siamese neural network* model in a minimally supervised manner using the explored small-size subgraph as training data. More precisely, this newly designed model learns the relationship between collected metadata in  $\mathcal{X}$  and edges in the discovered subgraph  $G_T$ . This also acts as a feature selection module that captures the latent representation of  $\mathcal{X}$  for redundancy reduction.
2. Instead of imputing all uncertain edges with inferred values to form the weighted graph  $G_{\text{gen}}^{(t)}$ , for computational efficiency, we design an *edge pruning* strategy that selects only a small number of confidence edges. We generate a *reinforced* weighted graph  $G_{\text{gen-prun}}^{(t)}$  after edge pruning from  $G_{\text{gen}}^{(t)}$ .
3. We identify the next node to query that can lead to a potentially high expected influence spread by approximately solving (1) using a *topology-aware*

3. Since our problem maps to the original IM problem when  $G_T \equiv G$ , the proof of NP-hardness similarly follows that of the original problem [1].

---

**Algorithm 1: IM-META**

---

**Input:**  $G_0, \mathcal{X}, T, k$   
**Output:**  $G_T, S$

```

1 function IM-META
2   /* Network discovery */
3   for t from 0 to T - 1 do
4      $\Theta^{(t)} \leftarrow \text{NetInference}(\mathcal{X}, G_t)$ 
5      $G_{\text{gen-prun}}^{(t)} \leftarrow \text{GraphGen}(\Theta^{(t)}, G_t)$ 
6      $v_t \leftarrow \text{QNodeSelect}(G_{\text{gen-prun}}^{(t)}, k)$ 
7      $G_{t+1} \leftarrow (\mathcal{V}_t \cup \mathcal{N}_G(v_t), \mathcal{E}_t \cup \mathcal{E}(\mathcal{N}_G(v_t), v_t))$ 
8    $\Theta^{(T)} \leftarrow \text{NetInference}(\mathcal{X}, G_T)$ 
9    $G_{\text{gen-prun}}^{(T)} \leftarrow \text{GraphGen}(\Theta^{(T)}, G_T)$ 
10  /* Seed set selection */
11   $S \leftarrow \text{ModifiedGreedy}(G_{\text{gen-prun}}^{(T)}, k)$ 
12  return  $G_T, S$ 

```

---

ranking strategy. The queried node then discovers its neighbors.

**Seed set selection.** The finally reinforced weighted graph  $G_{\text{gen-prun}}^{(T)}$  is used as input of a modified greedy IM algorithm, which is designed to find a set of seed nodes only within  $G_T$ .

**Example 1.** A schematic overview of our IM-META method is visualized in Fig. 2, where we show one round of exploration from an unknown attributed network  $G$  consisting of six nodes. As output of the network inference and the reinforced weighted graph generation, we acquire a network  $G_{\text{gen-prun}}^{(0)}$  by adding seven inferred edges. Based on  $G_{\text{gen-prun}}^{(0)}$ , node  $v_2$  (filled-in yellow circle) is selected via the query node selection module. Afterwards, we similarly obtain  $G_{\text{gen-prun}}^{(1)}$ , which completes the network discovery phase. Under a given budget of  $k = 2$  seed nodes, the seed set of two nodes  $v_1$  and  $v_3$  (filled-in red circles) is chosen from  $\mathcal{V}_1$  in the subgraph  $G_1$  since the seed set maximizes the influence spread over the reinforced graph  $G_{\text{gen-prun}}^{(1)}$  by employing our own greedy algorithm.

## 4 PROPOSED IM-META METHOD

In this section, we present IM-META, an end-to-end solution to the problem of IM in a topologically unknown attributed network. The overall procedure of our method is described in Algorithm 1. Here, the algorithm starts with the network discovery phase consisting of the following three functions: 1) `NetInference` for network inference using metadata (refer to line 4); 2) `GraphGen` for reinforced weighted graph generation (refer to line 5); and 3) `QNodeSelect` for query node selection (refer to line 6). After querying  $T$  nodes by iteratively invoking the above three functions, we turn to the seed set selection phase along with a modified greedy IM function, dubbed `ModifiedGreedy`, which is invoked to obtain the set of influential seed nodes,  $S$ , from the reinforced weighted graph  $G_{\text{gen-prun}}^{(T)}$  (refer to line 11). We also analyze the computational complexity of our IM-META method.

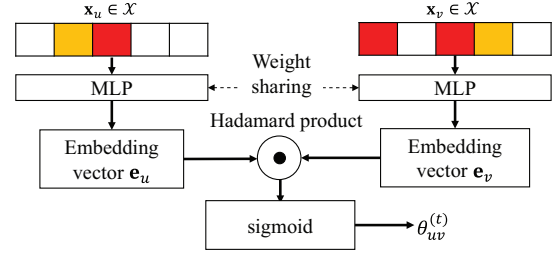

Fig. 3: Schematic overview of the architecture of our Siamese neural network for network inference.

### 4.1 Network discovery

The technical details of each function in the network discovery phase is described in the following.

#### 4.1.1 Network Inference Using Node Metadata

We elaborate on how to infer a set of uncertain edge probabilities, denoted as  $\Theta^{(t)}$ , at each query step  $t \in \{1, \dots, T\}$  using node metadata. Such network inference, treated as inductive link prediction, entails several practical challenges. First, not all collected features in the set  $\mathcal{X}$  are useful for the inference process due to redundancy and computational inefficiency. Second, a limited budget for node queries results in a small-size explored subgraph. Since none of the incident edges of each unexplored node in the subgraph are visible, we need to *inductively* infer  $\Theta^{(t)}$  based solely on the node metadata  $\mathcal{X}$ .

We tackle the aforementioned challenges by adopting a *Siamese neural network* model, which was originally introduced in image matching [36] and then has been actively applied to various pattern analyses [37], [38], [39]. In our work, we take advantage of the “homophily principle” in social networks, the tendency of an individual node to associate with similar others [40], and adopt the Siamese neural network model with the primary role of dimensionality reduction. To this end, we learn embeddings that accurately capture the *homophily* effect of information diffusion networks. Since a trained Siamese neural network inductively maps new input data (i.e., unexplored nodes) whose connectivity information to the training data (i.e., explored nodes) is unknown, it can easily be applied to our problem. Fig. 3 illustrates the architecture of our Siamese neural network for inductively predicting edges  $\Theta^{(t)}$ . As depicted in the figure, our Siamese neural network consists of twin multilayer perceptron (MLP) networks to which two feature vectors  $\mathbf{x}_u$  and  $\mathbf{x}_v$  associated with nodes  $u$  and  $v$ , respectively, are fed separately. The MLPs act as encoders that compute embedding vectors, denoted as  $\mathbf{e}_u$  and  $\mathbf{e}_v$  for nodes  $u$  and  $v$ , respectively. Finally, similarly as in [41], we compute the Hadamard product of two embedding vectors and then utilize a sigmoid output layer to infer  $\theta_{uv}^{(t)}$  from the product. That is,  $\theta_{uv}^{(t)} = \text{sigmoid}(\mathbf{e}_u \odot \mathbf{e}_v)$ , where  $\odot$  denotes the Hadamard product.

To train model parameters  $\mathbf{W}$  of the Siamese neural network, we establish a *contrastive loss* built upon the argument by Armandpour et al. [42]. Specifically, for each mini-batch used in stochastic gradient descent, we sample a pair of two nodes  $u, v \in G$  whose connection is certain. Here, we apply

negative sampling [43] to balance between sampled positive and negative node pairs since real-world networks tend to be sparse. Then, we aim to find the parameters  $\mathbf{W}$  in the sense of minimizing the loss function:

$$\begin{aligned} \mathcal{L}(\mathbf{W}, \mathbf{x}_u, \mathbf{x}_v) = & (1 - a_{uv}) \frac{1}{2} d_{\mathbf{W}}^2(u, v) \\ & + a_{uv} \frac{1}{2} \{\max(0, r - D_{\mathbf{W}}(u, v))\}^2, \end{aligned} \quad (2)$$

where  $a_{uv} = 1$  if there is an incident edge  $(u, v) \in \mathcal{E}_t$  and  $a_{uv} = 0$  if  $(u, v) \notin \mathcal{E}_t$  and  $u, v \notin \mathcal{Q}_t$ ;  $r$  is the so-called ‘‘margin’’ hyperparameter [42];  $\mathbf{W}$  indicates the learnable parameters of two MLPs that are shared with each other; and  $D_{\mathbf{W}}(\cdot, \cdot)$  is the distance function that measures the similarity between two input data and is expressed as

$$D_{\mathbf{W}}(u, v) = \cos(\mathbf{e}_u, \mathbf{e}_v), \quad (3)$$

where  $\cos(\cdot, \cdot)$  denotes the cosine distance between two vectors.<sup>4</sup> The intuition behind the loss function in (2) is 1) to provide an *attractive* force between embeddings of node pairs whose features are similar and 2) to push apart dissimilar node pairs with an *repulsive* force until the distance between them is greater than a certain radius  $r$  in the embedding space.

Note that the distance function  $D_{\mathbf{W}}(u, v)$  also captures the homophily for out-of-sample nodes, even with a small set of training data obtained from  $G_t$ . Thus, based on the Siamese neural network, the function NetInference is capable of accurately inferring edge connections for the unexplored part of the network.

#### 4.1.2 Reinforced Weighted Graph Generation

We now explain how to seamlessly generate a reinforced weighted graph. From the network inference, we obtain edge probabilities  $\Theta^{(t)}$  at each query step  $t$ . However, a large portion of these uncertain edges do not truly exist since real-world graphs are usually sparse. Thus, using non-existent edges certainly leads to an *accumulation of noise* in the subsequent processes. This motivates us to select edges that are predicted with high confidence to reduce noise while simultaneously reducing the computational complexity. To this end, we aim to select *confidence* edges whose inferred probabilities  $\Theta^{(t)}$  are greater than a given threshold as follows.

**Definition 1.** Suppose that the set  $\Theta^{(t)}$  indicating the probability of uncertain edges is inferred at the  $t$ -th query. Then, an edge  $(u, v) \in \Theta^{(t)}$  is called a *confidence edge* if  $\theta_{uv}^{(t)} \geq \epsilon$ , where  $\epsilon > 0$  is a predefined threshold.

Let  $H \in \{0, 1, \dots, |\Theta^{(t)}|\}$  denote the cardinality of the set of selected confidence edges. After selecting the top  $H$  confidence edges in the ranked list of  $\Theta^{(t)}$  in descending order, we transform the weighted graph  $G_{\text{gen}}^{(t)}$  into a *reinforced weighted graph*  $G_{\text{gen-prun}}^{(t)}$  via our *edge pruning* strategy. Then, we recompute the diffusion probabilities for all edges

4. In our study, we adopt the cosine distance for normalization. However, other distance measures such as the Euclidean distance could also be considered.

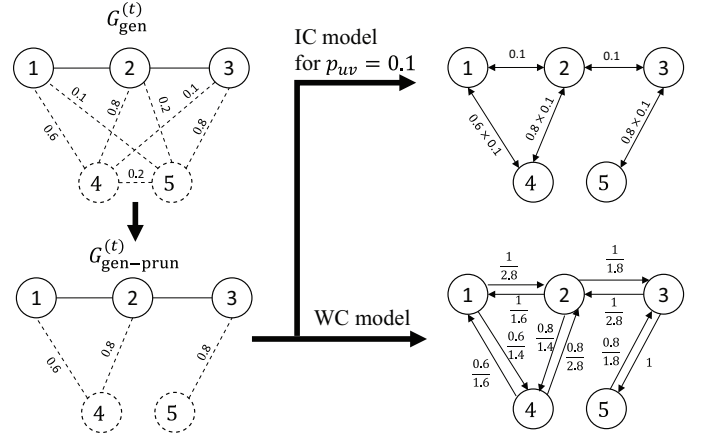

Fig. 4: An illustration of reinforced weighted graph generation for  $\epsilon = 0.5$  under the two diffusion models. Here, the value on each dashed line indicates  $\theta_{uv}^{(t)} \in \Theta^{(t)}$ , while the value on each solid line represents the diffusion probability in the reinforced weighted graph  $G_{\text{gen-prun}}^{(t)}$ .

in  $G_{\text{gen-prun}}^{(t)}$ . Specifically, we compute the joint probability distribution based on each diffusion model as follows. For the IC model, we have  $\Pr(A_{u,v}|E_{u,v}) = p_{uv} \sim \mathcal{U}(0, 1)$ . Thus, from Bayes’ rule, it follows that  $\Pr(E_{u,v}A_{u,v}) = \theta_{uv}^{(t)} p_{uv}$ . For the WC model, we have  $\Pr(A_{u,v}|E_{u,v}) = \frac{1}{d_v}$ , which is however unknown since  $d_v$  can only be computed from the fully observed network structure. To overcome this problem, we estimate the node degree at step  $t$  as  $\hat{d}_v^{(t)} := \sum_{u \in \mathcal{N}_v} \theta_{uv}^{(t)}$ , where  $\mathcal{N}_v$  is the set of all neighbors of  $v$  in  $G_{\text{gen-prun}}^{(t)}$  and  $\theta_{uv}^{(t)} = 1$  if  $(u, v) \in \mathcal{E}_t$ . Then, we have  $\Pr(E_{u,v}A_{u,v}) = \frac{1}{\hat{d}_v^{(t)}} \theta_{uv}^{(t)}$  for the WC model.

**Example 2.** An example of the reinforced weighted graph generation can be seen in Fig. 4, where  $\epsilon = 0.5$  and two reinforced weighted graphs  $G_{\text{gen-prun}}^{(t)}$  are constructed based on both IC and WC models. For the IC model, assuming that  $p_{uv} = 0.1$ , the diffusion probability in  $G_{\text{gen-prun}}^{(t)}$  can be simply computed as in the left-bottom of Fig. 4. For the WC model, we compute the diffusion probabilities of associated edges in  $G_{\text{gen-prun}}^{(t)}$  by using an estimate of the node degree,  $\hat{d}_v$  (see the right-bottom of Fig. 4). For example,  $\hat{d}_1^{(t)}$  is given by  $1 + \theta_{41}^{(t)} = 1 + 0.6 = 1.6$ ; thus, the diffusion probabilities associated with two edges  $(v_2, v_1)$  and  $(v_4, v_1)$  are  $\frac{1}{1.6}$  and  $\frac{0.6}{1.6}$ , respectively.

#### 4.1.3 Query Node Selection

As the last step of network discovery, we describe our query node selection module. As in prior studies [13], [14], it is natural to select a query node that has a high degree centrality since it enables the resulting explored subgraph to grow fast. In our work, selecting a high degree node to query would also be beneficial in providing more samples to train our Siamese neural network. Nevertheless, we pay attention to the *residual degree* of a node at each query step  $t$ , defined as  $r_u^{(t)} = \hat{d}_u^{(t)} - d_u^{(t)}$ , rather than the estimated degree  $\hat{d}_u^{(t)}$  itself, where  $d_u^{(t)}$  denotes the degree of an observable node at the  $t$ -th query step. Obviously, the residual degree  $r_u$  represents a better capability to explore more nodes when the inference

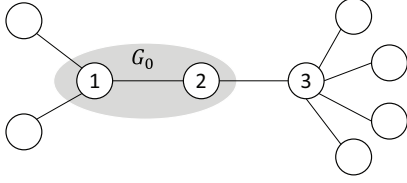

Fig. 5: An example illustrating that querying a high degree node is not always beneficial given an initial subgraph  $G_0$  when  $T = k = 1$  and  $G_{\text{gen-prun}}^{(0)}$  correctly reflects the underlying graph  $G$ .

accuracy is sufficiently high since the observable nodes in the explored subgraph no longer contribute to its growth.

However, such a selection strategy that chooses nodes whose residual degrees are high may not always be beneficial as depicted in Fig. 5. In this example, given an initial subgraph, querying node  $v_1$  ( $r_1^{(0)} = 2$ ) leads to an explored subgraph consisting of four nodes and three edges, while choosing node  $v_2$  ( $r_2^{(0)} = 1$ ) to query only discovers node  $v_3$  and one edge incident to  $v_3$ . Since it is certain that  $v_3$  is the most influential node, it should be contained in the explored graph for the seed node selection process. This observation motivates us to make use of the *geodesic distance* to potentially influential nodes, which represents the length in terms of the number of edges of the shortest path between two vertices, as a vital factor in the query node selection process. For example, in Fig. 5, if we choose one of two nodes  $v_1$  and  $v_2$  such that the shortest path to  $v_3$  yields a shorter geodesic distance as a queried node, then  $v_2$  should be selected.

In this context, we want to query each node by taking into account both 1) the residual degree (as high as possible) and 2) the sum of the shortest paths to potentially influential nodes (as low as possible). To this end, starting from the reinforced weighted graph  $G_{\text{gen-prun}}^{(t)}$ , we first execute an IM algorithm to find the set of  $k$  potentially influential nodes at the  $t$ -th query step, denoted as  $\hat{S}^{(t)} \subseteq \mathcal{V}$ .<sup>5</sup> Then, if a node  $v \in \hat{S}^{(t)}$  belongs to the current explored subgraph (i.e.,  $v \in \mathcal{V}_t$ ), it is excluded from  $\hat{S}^{(t)}$  (i.e.,  $\hat{S}^{(t)} \leftarrow \hat{S}^{(t)} \setminus \{v\}$ ) so that only the potentially influential nodes in the unexplored part are possible candidates to be queried. Using the set  $\hat{S}^{(t)}$ , we now propose our own *topology-aware* ranking strategy by defining a ranking measure:

$$\text{rank}^{(t)}(u) = r_u^{(t)} - \alpha \sum_{v \in \hat{S}^{(t)}} \text{GD}^{(t)}(u, v), \quad (4)$$

where  $\text{GD}^{(t)}(u, v)$  indicates the geodesic distance between two nodes  $u$  and  $v$ , and  $\alpha \geq 0$  is a hyperparameter balancing two terms in (4). The impact of  $\alpha$  is empirically validated in Section 5.4. The node whose  $\text{rank}^{(t)}(u)$  is the highest among  $u \in \mathcal{V}_t$  is finally chosen as the queried node in each query step. Intuitively, the potentially influential nodes serve as anchors providing a guidance on choosing the query node  $u$  in the sense of minimizing the sum of geodesic distances

<sup>5</sup> In our work, degree discount heuristics [19] are adopted to find  $\hat{S}^{(t)}$  for computational efficiency.

---

### Algorithm 2: ModifiedGreedy

---

**Input:**  $G_{\text{gen-prun}}^{(T)}, k$

**Output:**  $S$

```

1 function ModifiedGreedy
2    $S \leftarrow \phi$ 
3   for  $i$  from 0 to  $k$  do
4     for each  $v \in \mathcal{V}_T \setminus S$  do
5        $s_v \leftarrow \hat{\sigma}(S \cup \{v\})$ 
6      $S \leftarrow S \cup \arg \max_{v \in \mathcal{V}_T} \{s_v\}$ 
7   return  $S$ 

```

---

between  $u$  and nodes in  $\hat{S}^{(t)}$ ,  $\sum_{v \in \hat{S}^{(t)}} \text{GD}^{(t)}(u, v)$  in (4). It is worth noting that the number of seed nodes,  $k$ , is used not only in the seed set selection phase but also in the network discovery phase.

## 4.2 Seed Set Selection

We now turn to stating the seed set selection phase, which can be viewed as a generalization of the greedy IM algorithm [1]. As described in Algorithm 2, the function ModifiedGreedy gradually adds one node maximizing the so-called ‘‘marginal expected spread’’ (see [1]) to the seed set  $S$ , under the constraint that seed nodes can only be selected from the set of explored nodes,  $\mathcal{V}_T$  in the graph  $G_{\text{gen-prun}}^{(T)}$  (see lines 4 and 6). We note that the expected influence spread  $\hat{\sigma}(\cdot)$  in line 5 can be approximated via many approaches such as Monte-Carlo simulations, lazy update [16], or reverse reachable sets [17].

## 4.3 Complexity Analysis

To analyze the computational complexity of our IM-META method, it is not difficult to show that the complexity for the network discovery phase is dominated by the network inference step, whose complexity is given by  $\mathcal{O}(n^2)$ , where  $n$  is the number of nodes in  $\mathcal{V}$ , conditioned that the size of model parameters in MLPs does not scale with  $n$ . Of course, the computational complexity for this phase can be greatly reduced when parallelization is applied. Thus, the bottleneck of IM-META is the greedy IM algorithm in the seed set selection phase, whose complexity is bounded by  $\mathcal{O}(Rknm)$  (refer to [16] for more details), where  $R$  represents the number of Monte-Carlo simulations to estimate the expected influence spread and  $m$  is the number of edges in  $\mathcal{E}$ . As  $R$  and  $k$  are regarded as constants and  $n < m$ , the total complexity of IM-META is finally given by  $\mathcal{O}(nm)$ , which lies in the same line as that of the greedy IM algorithm on the underlying graph  $G$ .

## 5 EXPERIMENTAL EVALUATION

In this section, we first describe real-world datasets that we use in the evaluation. We also include three benchmark methods for IM as a comparison. After presenting our experimental settings, we comprehensively evaluate the performance of our IM-META method.



TABLE 2: Statistics of four datasets, where  $n$ ,  $m$ , and  $|\mathcal{X}|$  denote the numbers of nodes, edges, and features of each node, respectively.

| Name             | $n$   | $m$   | $ \mathcal{X} $ |
|------------------|-------|-------|-----------------|
| Coauthor-CS      | 3,000 | 5,462 | 6,805           |
| Coauthor-Physics | 3,000 | 4,750 | 8,415           |
| Douban           | 3,906 | 8,164 | 538             |
| Ego-Facebook     | 534   | 4,813 | 262             |

## 5.1 Datasets

Four real-world datasets across several domains (e.g., social and co-authorship networks with node metadata) commonly adopted in the literature are used as the underlying graph  $G$ . We also make use of the associated node features provided in these datasets as the collected node metadata  $\mathcal{X}$ . For all experiments, we treat graphs as undirected. The statistics of each dataset, including the number of nodes and the number of edges, and the number of node features, is described in Table 2. In the following, we summarize important characteristics of the datasets.

**Coauthorship-CS (CS)** and **Coauthorship-Physics (Physics)**. The Coauthorship-CS and Coauthorship-Physics datasets are two co-authorship graphs extracted via forest-fire sampling [44] from the Microsoft Academic Graph in the KDD Cup 2016 challenge 3.<sup>6</sup> Here, nodes are authors who are connected by an edge if they co-authored a paper. Node features represent paper keywords for each author’s papers.

**Douban**. The Douban dataset is an online social network providing user review and recommendation services for movies, books, and musics. Here, links are the relationship between users, and node features contain anonymized information such as users’ location and offline event participation.<sup>7</sup>

**Ego-Facebook** [45]. The Ego-Facebook dataset is a social friendship network extracted from Facebook via breadth-first search (BFS) sampling. Nodes and edges represent users and friendship ties, respectively. Node features are anonymized information on each user’s profile.

## 5.2 Benchmark Methods

In this subsection, we present one state-of-the-art IM approach and two baseline methods.

**Random (Rand)**. We randomly select a queried node for each round of exploration. Then, after  $T$  query rounds, the greedy IM algorithm in [1] is used to obtain  $k$  seed nodes from the explored graph  $G_T$  without network inference.

**Inference only with node features (NF-Only)**. We consider a special case of IM-META, where a logistic regression model is used to infer the set  $\Theta^{(t)}$  only from the node metadata,  $\mathcal{X}$ , instead of employing the Siamese neural network.

**CHANGE**. To facilitate an effective HIV intervention campaign, a state-of-art method was recently proposed [14]. This model was inspired by the friendship paradox, which

states that the expected degree of a random node’s neighbor(s) is larger than that of the random node itself [46]. In this context, a random neighbor of a node in  $G_t$  is selected to query at each query step  $t$  in the network discovery phase. Similarly as in Rand, the greedy IM algorithm is used to obtain  $k$  seed nodes from the explored graph  $G_T$ .

Furthermore, for comparison with the fundamental limit of IM in our setting, we evaluate the performance of another case, termed **Upper-Greedy**, using the greedy IM algorithm when the underlying graph  $G$  is assumed to be fully available.

## 5.3 Experimental Setup

In our experiments, the induced subgraph  $G_0$  with four nodes is initialized, similarly as in [14]. For each evaluation, we run experiments over 10 different initialization of  $G_0$  to compute the average score. The diffusion probability for the IC model is set to 0.1 typically as in the literature (see [1], [16] and references therein).

We now describe the settings of the neural networks. As for the function **NetInference**, the dimension of embedding vectors is set to 256, and the Siamese neural network model is trained via the Adam optimizer [47] with a learning rate of 0.1 and a batch size of 16 for all datasets. For computational efficiency, our model is trained just for a few epochs from the second round of queries based on the model parameters  $\mathbf{W}$  loaded from the previous query round, which is in line with a popular pre-training technique in the literature [48].

For each dataset, we randomly split the set of nodes into training/validation/test sets with a ratio of 85/5/10%. The parameter  $\alpha$  in (4) for designing our topology-aware ranking strategy and the threshold  $\epsilon$  in the reinforced weighted graph generation are set to 1 and 0.5, respectively, unless otherwise stated, where the impact of  $\alpha$  and  $\epsilon$  on the performance will be empirically examined in Section 5.4.4. For the function **ModifiedGreedy**, we employ the implementation of the CELF algorithm [16], in which the number of Monte-Carlo simulations is set to 20,000.

## 5.4 Experimental Results

Our empirical study in this subsection is designed to answer the following four key research questions.

- Q1. How does the explored subgraph of IM-META grow in the query process compared to that of benchmark methods?
- Q2. How much does the IM-META method improve the performance of IM in terms of the expected influence spread over the benchmark methods?
- Q3. How robust is IM-META in a more difficult situation where a portion of node metadata are missing?
- Q4. How do model parameters affect the performance of the IM-META method?

### 5.4.1 Growth of Explored Subgraphs (Q1)

Given a small budget of node queries, it would be desirable to acquire explored subgraphs that are as large as possible since the size of subgraphs primarily determines the performance of IM. To comprehensively understand the query process, we are interested in examining how the explored

<sup>6</sup>The two datasets are publicly available online (<https://github.com/shchur/gnn-benchmark/tree/master/data>).

<sup>7</sup>The dataset is publicly available online (<https://github.com/maffia92/FINAL-network-alignment-KDD16>).

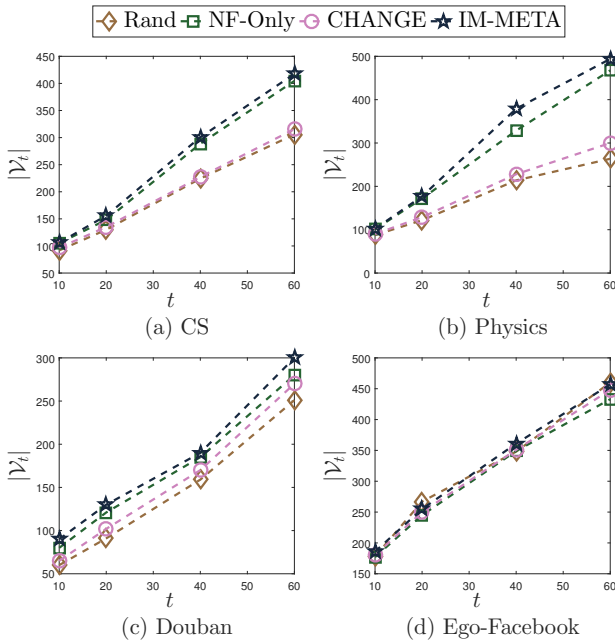

Fig. 6: The size of explored subgraphs,  $|\mathcal{V}_t|$ , as a function of the number of queried nodes,  $t$ .

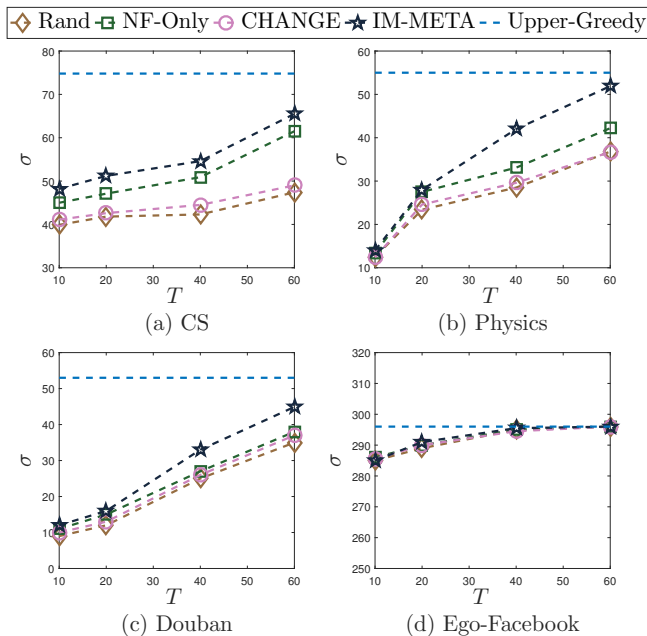

Fig. 7: The expected influence spread  $\sigma$  as a function of the query budget  $T$  when  $k$  is set to 5 and the IC model is applied.

subgraph  $G_t$  scales with the number of queried nodes,  $t$ , according to four real-world datasets. To this end, we empirically assess the growth of  $G_t$  resulting from four methods including IM-META, Rand, NF-Only, and CHANGE for all datasets, where the number of seed nodes,  $k$ , is set to 5 and the IC model is applied. Following the results in Fig. 6, our findings can be summarized as follows:

- The size of each subgraph  $G_t$  in the CS, Physics, and Douban datasets tend to be relatively small compared to that of the underlying network  $G$ . For example, from Table 2 and Fig. 6c, it is evident that  $|\mathcal{V}_t| < 0.1|\mathcal{V}|$  for the Douban dataset when  $t = 60$ .
- On the other hand, the Ego-Facebook network behaves differently from other three datasets in such a way that  $|\mathcal{V}_t|$  obtained by all three methods is close to  $|\mathcal{V}|$  even with querying only 60 nodes, which accounts for about 11.2% of the total number of nodes in the Ego-Facebook network. This is due to the fact that the diameter of ego-networks via BFS sampling is inherently small; thus, it is capable of exploring a large number of neighbors by querying even a randomly selected node.
- For the CS and Physics datasets, the subgraph growth rate of both methods using node features, IM-META and NF-Only, is much faster than that of the other two methods, Rand and CHANGE. This implies that the accuracy of network inference is sufficiently high thanks to the rich feature information of these two datasets (refer to Table 2).
- In contrast, no such tendency is observed for the Douban and Ego-Facebook datasets. For the Douban dataset, a relatively low accuracy of network inference achieved by IM-META and NF-Only comes from the fact that node features are heavily anonymized. For the Ego-Facebook dataset, there is only a negligible gap in the subgraph size  $|\mathcal{V}_t|$  among the four methods since querying only a small number of nodes leads to huge exploration of subgraphs.

Overall, we find that the explored subgraph of IM-META consistently grows at least as fast as it does for the baselines, and frequently outperforms them.

#### 5.4.2 Comparison With Benchmark Methods (Q2)

The performance comparison between our proposed IM-META and competitive methods as well as Upper-Greedy is made comprehensively by considering the expected influence spread  $\sigma(S)$  for a set of selected seed nodes,  $S$ , using all four real-world datasets.<sup>8</sup> Figs. 7–10 illustrate  $\sigma$  versus the number of node queries,  $T$ , where  $k = \{5, 10\}$  and both IC and WC models are employed. We make the following observations:

- IM-META consistently outperforms all benchmark methods except for the Ego-Facebook dataset.
- The highest gain of IM-META over the second best performer can be observed from the Douban dataset under the IC model when  $k = 10$  and  $T = 60$  (refer to Fig. 8c). In this case, NF-Only using the node metadata  $\mathcal{X}$  performs no better than Rand due to the heavy anonymization of node features in the Douban dataset. This implies that the Siamese neural network plays a vital role in accurate network inference.
- Overall, CHANGE is slightly superior to Rand, which confirms the results of a prior study [14].
- For the Ego-Facebook dataset, all methods achieve comparable performance to that of Upper-Greedy

<sup>8</sup>. To simplify notations,  $\sigma(S)$  will be written as  $\sigma$  unless otherwise specified.

even with a very small number of node queries, e.g.,  $T = 10$ . This is not surprising due to the enormous size of explored subgraphs as discussed in Section 5.4.1, which results in the inclusion of (almost) all influential nodes in any explored subgraph.

- In comparing the IC and WC models, it is likely that, for the WC model, the performance gap between the two methods using node features (i.e., IM-META and NF-Only) and other two methods (i.e., Rand and CHANGE) is higher than for the IC model. This is because IM-META and NF-Only are capable of estimating the expected degree of nodes; thus, the diffusion probability can be more precisely represented in the WC model by employing such methods that make use of node features.
- The performance of IM-META tends to be closer to that of Upper-Greedy when the number of seed nodes,  $k$ , is relatively smaller. As an example, in the Physics dataset, IM-META achieves about 93% of the expected influence spread resulting from Upper-Greedy by querying only 60 nodes, which accounts for 5% of the total number of nodes in the given network, when  $k = 5$  and the IC model is applied (see Fig. 7b).
- Interestingly, as depicted in Figs. 6 and 7, there is a correlation between the size of explored subgraphs,  $|\mathcal{V}_t|$ , and the expected influence spread  $\sigma$ . In other words, the method achieving a higher  $|\mathcal{V}_t|$  attains a higher  $\sigma$ .
- Moreover, from Figs. 6 and 7, it is worth noting that a gap in  $|\mathcal{V}_t|$  between IM-META and NF-Only leads to a much bigger performance gap in terms of  $\sigma$  between the two methods. This in turn means that the accuracy of network inference significantly influences the resulting  $\sigma$ .

Overall, IM-META best approaches the upper bound of the greedy algorithm (which has access to the entire network).

### 5.4.3 Robustness to the Degree of Available Node Metadata (Q3)

We now evaluate the performance of IM-META in a more difficult situation that often occurs in real environments where only a portion of node metadata in the set  $\mathcal{X}$  are collectible (available). To this end, we randomly remove  $\{20, 40, 60, 80\}$ % of node features associated with each node in a given dataset. In these experiments, we only show the results for the setting where  $T$  and  $k$  are set to 60 and 5, respectively. We only show the results for the IC model since the results from other settings follow similar trends.

The performance comparison between our IM-META and the three benchmark methods for all datasets is presented in Fig. 11. One can see that the performance of both IM-META and NF-Only gradually degrades when more node features are removed from  $\mathcal{X}$ . Our findings for the CS and Physics datasets demonstrate that, in fringe scenarios, e.g., the case where 80% of node features are removed, NF-Only performs slightly better than CHANGE while IM-META exhibits clear gains over all benchmark methods. This implies that, even under the circumstance where a number of node features are missing, the proposed IM-META method is capable of

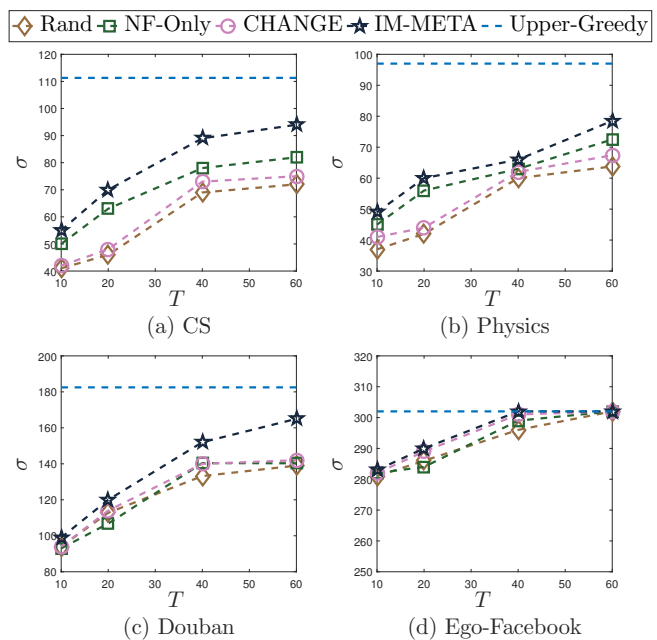

Fig. 8: The expected influence spread  $\sigma$  as a function of the query budget  $T$  when  $k$  is set to 10 and the IC model is applied.

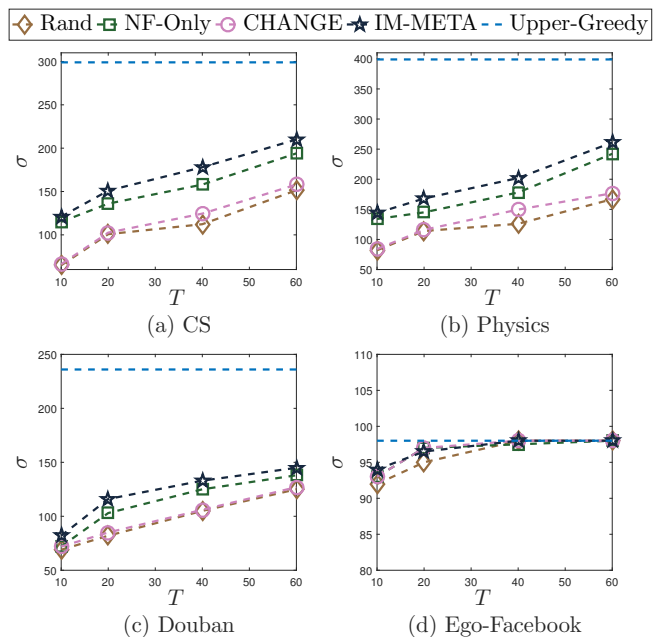

Fig. 9: The expected influence spread  $\sigma$  as a function of the query budget  $T$  when  $k$  is set to 5 and the WC model is applied.

correctly adding inferred edges in the subgraph exploration process, which enables us to better select the set of influential seed nodes. For the Douban dataset with 80% removal of node features, IM-META is slightly inferior to CHANGE yet still reveals promising gains over other two methods. On the other hand, for the Ego-Facebook dataset, all methods

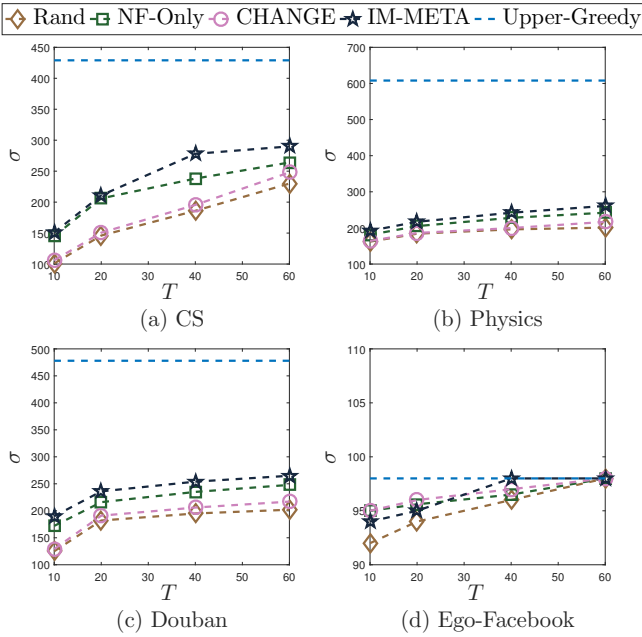

Fig. 10: The expected influence spread  $\sigma$  as a function of the query budget  $T$  when  $k$  is set to 10 and the WC model is applied.

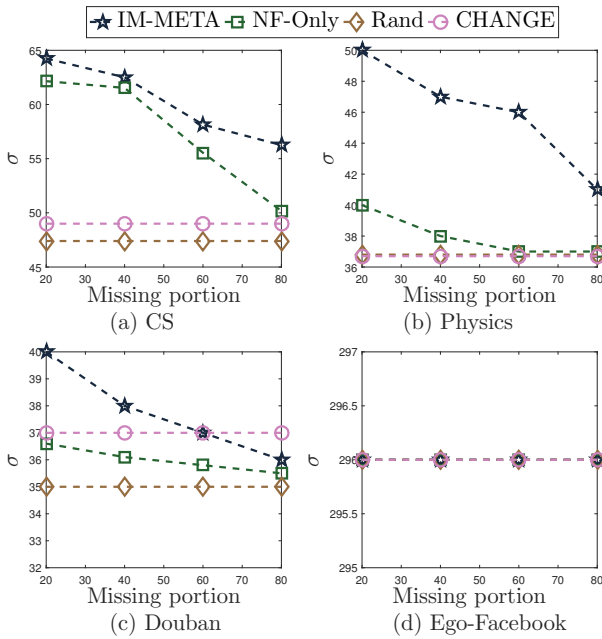

Fig. 11: The expected influence spread  $\sigma$  according to the missing portion of collected metadata when  $T$  and  $k$  are set to 60 and 5, respectively, and the IC model is applied.

achieve the performance of Upper-Greedy, meaning that the degree of available node metadata does not affect any performance degradation.

#### 5.4.4 Hyperparameter Sensitivity (Q4)

In Fig. 12, we investigate the impact of hyperparameters  $\alpha$  and  $\epsilon$  on the performance of IM-META when  $T = 60$

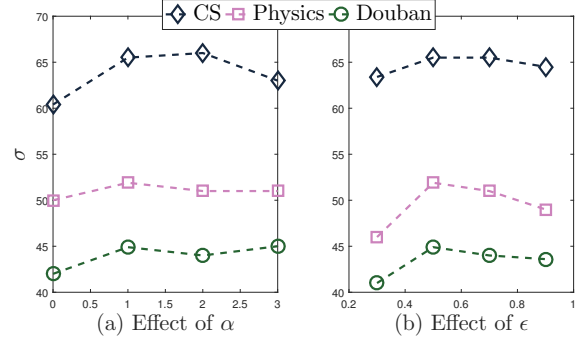

Fig. 12: The expected influence spread  $\sigma$  achieved by IM-META according to different values of hyperparameters  $\alpha$  and  $\epsilon$  when  $T$  and  $k$  are set to 60 and 5, respectively, and the IC model is applied.

and  $k = 5$ . Recall that  $\alpha$  adjusts the balance between two terms in (4), i.e., the residual degree and the sum of the shortest paths to potentially influential nodes, for the query node selection and  $\epsilon$  is the threshold that controls the number of confidence edges for the reinforced weighted graph generation. When a hyperparameter ( $\alpha$  or  $\epsilon$ ) varies so that its effect is clearly revealed, the other parameter is set to the pivot values  $\alpha = 1$  and  $\epsilon = 0.5$ . In these experiments, we only show the results from the IC model since those from the WC model follow a similar trend. Moreover, experimental results for the Ego-Facebook dataset are excluded since all combinations of hyperparameters return the same performance on this data set. We observe the following:

- The values of  $\alpha$  and  $\epsilon$  for which the highest  $\sigma$  is achieved tend to be almost identical for all datasets. Specifically, we find that the case of  $(\alpha, \epsilon) = (1, 0.5)$  exhibits the best performance almost consistently.
- We investigate the case of  $\alpha = 0$  where the residual degree is only taken into account in our topology-aware ranking strategy. In this case, the lowest performance is achieved over all  $\alpha$ 's regardless of datasets. This finding validates the necessity of the *shortest path to potentially influential nodes* in judiciously choosing queried nodes by setting the value of  $\alpha$  appropriately.
- We next examine the impact of  $\epsilon$  on the performance. Setting  $\epsilon$  to a high value (e.g.,  $\epsilon = 0.9$ ) leads to relatively low performance for all datasets. This setting is indeed undesirable since it makes our reinforced weighted graph  $G_{\text{gen-prun}}^{\alpha(t)}$  very sparse with only a small number of edges. Hence, it is crucial to suitably decide the value of  $\epsilon$  in guaranteeing satisfactory performance.

Overall, the results of our parameter sensitivity tests are as expected. The importance of our topology-aware ranking strategy, leveraging the residual degree and path information, for IM is clear from our empirical findings, and appropriately deciding the density of the generated weighted graphs is beneficial for the selection of seed nodes.

## 6 CONCLUDING REMARKS

In this paper, we investigated the impact and benefits of node metadata in aiding solutions to the IM problem in topologically unknown networks, which was an open and challenging problem due to the noisy nature of metadata and uncertainties in connectivity inference. To tackle this challenge, we introduced IM-META, a novel end-to-end solution that aims to find both a set of seed nodes and another set of nodes to query by making full use of the node metadata. Specifically, we developed the network discovery phase that iteratively performs three steps: 1) learning the relationship between collected metadata and edges via a Siamese neural network model, 2) constructing a reinforced weighted graph by selecting only a limited number of confidence edges, and 3) discovering the next node to query using the proposed topology-aware ranking strategy balancing between degree centrality of a target node and its geodesic distance to potential seeds. We then employed a modified IM algorithm to find the seed set, given the ultimately explored subgraph. Using four real-world datasets, we demonstrated that, for almost all cases, the proposed IM-META method consistently outperforms benchmark IM methods in terms of the expected influence spread. The results of our evaluation showed that IM-META achieves up to 93% of the performance of an upper-bound approach that has access to the full network, while IM-META queried only 5% of the underlying network. We also found that IM-META is robust to a lack of available node metadata (e.g., the performance even in extreme settings in which 80% of metadata are missing) and various hyperparameter settings. Overall, our results showed that even very limited access to node metadata and restricted queries to the network structure are sufficient to perform effective influence maximization.

Potential avenues of future research include the design of self-supervised learning models to further enhance the accuracy of network inference based on the node metadata of unexplored nodes. Alternatively, reinforcement learning could be incorporated into the framework for query node selection to further boost the performance.

## ACKNOWLEDGMENTS

This research was supported by the National Research Foundation of Korea (NRF) grant funded by the Korea government (MSIT) (No. 2021R1A2C3004345), by a grant of the Korea Health Technology R&D Project through the Korea Health Industry Development Institute (KHIDI), funded by the Ministry of Health & Welfare, Republic of Korea (HI20C0127), and by the Yonsei University, Republic of Korea Research Fund of 2021 (2021-22-0083).

## REFERENCES

- [1] D. Kempe, J. Kleinberg, and É. Tardos, "Maximizing the spread of influence through a social network," in *Proc. 9th ACM SIGKDD Int. Conf. Knowl. Disc. Data Mining (KDD '03)*, Washington, DC, Aug. 2003, pp. 137–146.
- [2] A. Banerjee, A. G. Chandrasekhar, E. Duflo, and M. O. Jackson, "The diffusion of microfinance," *Science*, vol. 341, no. 6144, pp. 1–9, Jul. 2013.
- [3] A. Yadav, H. Chan, A. X. Jiang, H. Xu, E. Rice, and M. Tambe, "Using social networks to aid homeless shelters: Dynamic influence maximization under uncertainty," in *Proc. Int. Conf. Autonomous Agents Multi-Agent Syst. (AAMAS '16)*, vol. 16, Singapore, Singapore, May 2016, pp. 740–748.
- [4] T. W. Valente and P. Pumpuang, "Identifying opinion leaders to promote behavior change," *Health Edu. Behavior*, vol. 34, no. 6, pp. 881–896, Jun. 2007.
- [5] E. Rice, E. Tulbert, J. Cederbaum, A. Barman Adhikari, and N. G. Milburn, "Mobilizing homeless youth for HIV prevention: A social network analysis of the acceptability of a face-to-face and online social networking intervention," *Health Edu. Research*, vol. 27, no. 2, pp. 226–236, Jan. 2012.
- [6] R. Dey, Z. Jelveh, and K. Ross, "Facebook users have become much more private: A large-scale study," in *Proc. IEEE Int. Conf. Pervasive Comput. Commun. Worksh. (PERCOM '12)*, Lugano, Switzerland, Mar. 2012, pp. 346–352.
- [7] R. M. Bond, C. J. Fariss, J. J. Jones, A. D. Kramer, C. Marlow, J. E. Settle, and J. H. Fowler, "A 61-million-person experiment in social influence and political mobilization," *Nature*, vol. 489, no. 7415, pp. 295–298, Sep. 2012.
- [8] M. Kim and J. Leskovec, "The network completion problem: Inferring missing nodes and edges in networks," in *Proceedings of the 11th SIAM International Conference on Data Mining (SDM '11)*, Mesa, AZ, Apr. 2011, pp. 47–58.
- [9] C. Tran, W.-Y. Shin, A. Spitz, and M. Gertz, "DeepNC: Deep generative network completion," *IEEE Trans. Pattern Analysis Machine Intell.*, to appear.
- [10] C. Tran, W.-Y. Shin, and A. Spitz, "Community detection in partially observable social networks," *ACM Trans. Knowl. Disc. Data*, to appear.
- [11] B. Wilder, L. Onasch-Vera, J. Hudson, J. Luna, N. Wilson, R. Petering, D. Woo, M. Tambe, and E. Rice, "End-to-end influence maximization in the field," in *Proc. Int. Conf. Autonomous Agents Multi-Agent Syst. (AAMAS '18)*, vol. 18, Stockholm, Sweden, Jul. 2018, pp. 1414–1422.
- [12] A. Yadav, B. Wilder, E. Rice, R. Petering, J. Craddock, A. Yoshioka-Maxwell, M. Hemler, L. Onasch-Vera, M. Tambe, and D. Woo, "Bridging the gap between theory and practice in influence maximization: Raising awareness about HIV among homeless youth," in *Proc. Int. Joint Conf. Artif. Intell. (IJCAI '18)*, Stockholm, Sweden, Jul. 2018, pp. 5399–5403.
- [13] B. Wilder, N. Immerlica, E. Rice, and M. Tambe, "Maximizing influence in an unknown social network," in *Proc. 32th Conf. Artif. Intell. (AAAI '18)*, New Orleans, LA, Feb. 2018, pp. 1–8.
- [14] H. Kamarthi, P. Vijayan, B. Wilder, B. Ravindran, and M. Tambe, "Influence maximization in unknown social networks: Learning policies for effective graph sampling," in *Proc. Int. Conf. Autonomous Agents Multi-Agent Syst. (AAMAS '20)*, Kaikoura, Canterbury, May 2020, pp. 575–583.
- [15] V. Leroy, B. B. Cambazoglu, and F. Bonchi, "Cold start link prediction," in *Proc. 16th Int. Conf. Knowl. Disc. Data Mining (KDD '10)*, Washington, DC, Jul. 2010, pp. 393–402.
- [16] J. Leskovec, A. Krause, C. Guestrin, C. Faloutsos, J. VanBriesen, and N. Glance, "Cost-effective outbreak detection in networks," in *Proc. 13th Int. Conf. Knowl. Disc. Data Mining*, San Jose, CA, Aug. 2007, pp. 420–429.
- [17] Y. Tang, Y. Shi, and X. Xiao, "Influence maximization in near-linear time: A martingale approach," in *Proc. Int. Conf. Management Data (SIGMOD '15)*, Melbourne, Australia, May 2015, pp. 1539–1554.
- [18] Y. Tang, X. Xiao, and Y. Shi, "Influence maximization: Near-optimal time complexity meets practical efficiency," in *Proc. Int. Conf. Management Data (SIGMOD '14)*, Snowbird, UT, Jun. 2014, pp. 75–86.
- [19] W. Chen, Y. Wang, and S. Yang, "Efficient influence maximization in social networks," in *Proc. 15th Int. Conf. Knowl. Disc. Data Mining (KDD '09)*, Paris, France, Jun. 2009, pp. 199–208.
- [20] K. Jung, W. Heo, and W. Chen, "IRIE: Scalable and robust influence maximization in social networks," in *Proc. Int. Conf. Data Mining (ICDM '12)*, Brussels, Belgium, Dec. 2012, pp. 918–923.
- [21] H. T. Nguyen, M. T. Thai, and T. N. Dinh, "Stop-and-stare: Optimal sampling algorithms for viral marketing in billion-scale networks," in *Proc. Int. Conf. Management Data (SIGMOD '16)*, San Francisco, CA, Jun. 2016, pp. 695–710.
- [22] E. Güneş, "An efficient linear programming based method for the influence maximization problem in social networks," *Inf. Sci.*, vol. 503, pp. 589–605, Jun. 2019.

- [23] L. Cui, H. Hu, S. Yu, Q. Yan, Z. Ming, Z. Wen, and N. Lu, "DDSE: A novel evolutionary algorithm based on degree-descending search strategy for influence maximization in social networks," *J. Netw. Comput. Appl.*, vol. 103, pp. 119–130, Feb. 2018.
- [24] S. Wang, J. Liu, and Y. Jin, "Finding influential nodes in multiplex networks using a memetic algorithm," *IEEE Trans. Cybernetics*, vol. 51, no. 2, pp. 900–912, Jun. 2019.
- [25] Y. Li, J. Fan, Y. Wang, and K. Tan, "Influence maximization on social graphs: A survey," *IEEE Trans. Knowl. Data Engineering*, vol. 30, no. 10, pp. 1852–1872, Oct. 2018.
- [26] A. Arora, S. Galhotra, and S. Ranu, "Debunking the myths of influence maximization: An in-depth benchmarking study," in *Proc. Int. Conf. Management Data (SIGMOD '17)*, Chicago, IL, May 2017, pp. 651–666.
- [27] B. Settles, "Active learning literature survey," 2009.
- [28] A. J. Joshi, F. Porikli, and N. P. Papanikolopoulos, "Scalable active learning for multiclass image classification," *IEEE Trans. Pattern Analysis Machine Intell.*, vol. 34, no. 11, pp. 2259–2273, Jan. 2012.
- [29] S. Eshghi, S. Maghsudi, V. Restocchi, S. Stein, and L. Tassiulas, "Efficient influence maximization under network uncertainty," in *Proc. Conf. Comput. Commun. Worksh.*, Paris, France, Apr.-May 2019, pp. 365–371.
- [30] D. Eckles, H. Esfandiari, E. Mossel, and M. A. Rahimian, "Seeding with costly network information," in *Proc. Conf. Econ. Comput. (EC '19)*, Phoenix, AZ, Jun. 2019, pp. 421–422.
- [31] B. Yan, K. Song, J. Liu, F. Meng, Y. Liu, and H. Su, "On the maximization of influence over an unknown social network," in *Proc. Int. Conf. Autonomous Agents Multi-Agent Syst. (AAMAS '19)*, Montreal, Canada, Jul. 2019, pp. 2279–2281.
- [32] Z. Wang, J. Liang, R. Li, and Y. Qian, "An approach to cold-start link prediction: Establishing connections between non-topological and topological information," *IEEE Trans. Knowl. Data Engineering*, vol. 28, no. 11, pp. 2857–2870, Aug. 2016.
- [33] A. Bojchevski and S. Günnemann, "Deep Gaussian embedding of graphs: Unsupervised inductive learning via ranking," in *Proc. Int. Conf. Learning Represent. (ICLR '18)*, Vancouver, Canada, Apr.-May 2018, pp. 2279–2281.
- [34] Y. Hao, X. Cao, Y. Fang, X. Xie, and S. Wang, "Inductive link prediction for nodes having only attribute information," in *Proc. Int. Joint Conf. Artif. Intell. (IJCAI '20)*, Virtual Event, Jan. 2021.
- [35] S. Mihara, S. Tsugawa, and H. Ohsaki, "Influence maximization problem for unknown social networks," in *Proc. Int. Conf. Advances Social Netw. Analysis Mining (ASONAM '15)*, Paris, France, Aug. 2015, pp. 1539–1546.
- [36] J. Bromley, J. W. Bentz, L. Bottou, I. Guyon, Y. LeCun, C. Moore, E. Säckinger, and R. Shah, "Signature verification using a "Siamese" time delay neural network," *Int. J. Pattern Recog. Artif. Intell.*, vol. 7, no. 04, pp. 669–688, Aug. 1993.
- [37] X. Liu, J. Van De Weijer, and A. D. Bagdanov, "Exploiting unlabeled data in CNNs by self-supervised learning to rank," *IEEE Trans. Pattern Analysis Machine Intell.*, vol. 41, no. 8, pp. 1862–1878, Feb. 2019.
- [38] J. Masci, M. M. Bronstein, A. M. Bronstein, and J. Schmidhuber, "Multimodal similarity-preserving hashing," *IEEE Trans. Pattern Analysis Machine Intell.*, vol. 36, no. 4, pp. 824–830, Nov. 2014.
- [39] Y. Qi, S. Zhang, L. Qin, Q. Huang, H. Yao, J. Lim, and M.-H. Yang, "Hedging deep features for visual tracking," *IEEE Trans. Pattern Analysis Machine Intell.*, vol. 41, no. 5, pp. 1116–1130, Apr. 2019.
- [40] J. Tang, H. Gao, X. Hu, and H. Liu, "Exploiting homophily effect for trust prediction," in *Proc. 6th ACM Int. Conf. Web Search Data Mining (WSDM '13)*, Rome, Italy, Feb. 2013, pp. 53–62.
- [41] Z. Wang, C. Chen, and W. Li, "Predictive network representation learning for link prediction," in *Proc. 40th Int. Conf. Research Dev. Inf. Retrieval (SIGIR '17)*, Tokyo, Japan, Aug. 2017, pp. 969–972.
- [42] R. Hadsell, S. Chopra, and Y. LeCun, "Dimensionality reduction by learning an invariant mapping," in *Proc. IEEE Comput. Society Conf. Comput. Vision Pattern Recognition (CVPR '06)*, vol. 2, New York, NY, Jun. 2006, pp. 1735–1742.
- [43] M. Armandpour, P. Ding, J. Huang, and X. Hu, "Robust negative sampling for network embedding," in *Proc. Conf. Artif. Intell. (AAAI '19)*, vol. 33, Honolulu, HI, Jan.-Feb. 2019, pp. 3191–3198.
- [44] J. Leskovec and C. Faloutsos, "Sampling from large graphs," in *Proceedings of the 12th International Conference on Knowledge Discovery and Data Mining (KDD '06)*, Philadelphia, PA, Aug. 2006, pp. 631–636.
- [45] J. Leskovec and A. Krevl, "SNAP datasets: Stanford large network dataset collection," Retrieved from <http://snap.stanford.edu/data>, Jun. 2014.
- [46] S. L. Feld, "Why your friends have more friends than you do," *American J. Sociology*, vol. 96, no. 6, pp. 1464–1477, 1991.
- [47] D. P. Kingma and J. Ba, "Adam: A method for stochastic optimization," in *Proc. Int. Conf. Learning Rep. (ICLR '15)*, San Diego, CA, May 2015.
- [48] D. Hendrycks, K. Lee, and M. Mazeika, "Using pre-training can improve model robustness and uncertainty," in *Proc. 36th Int. Conf. Machine Learning (ICML '19)*, Long Beach, CA, Jun. 2019, pp. 2712–2721.