

Grammar Index By Induced Suffix Sorting

Tooru Akagi

Dominik Köppl
Hideo Bannai

Yuto Nakashima
Masayuki Takeda

Shunsuke Inenaga

May 31, 2021

Abstract

Pattern matching is the most central task for text indices. Most recent indices leverage compression techniques to make pattern matching feasible for massive but highly-compressible datasets. Within this kind of indices, we propose a new compressed text index built upon a grammar compression based on induced suffix sorting [Nunes et al., DCC'18]. We show that this grammar exhibits a locality sensitive parsing property, which allows us to specify, given a pattern P , certain substrings of P , called *cores*, that are similarly parsed in the text grammar whenever these occurrences are extensible to occurrences of P . Supported by the cores, given a pattern of length m , we can locate all its occ occurrences in a text T of length n within $\mathcal{O}(m \lg |\mathcal{S}| + \text{occ}_C \lg |\mathcal{S}| \lg n + \text{occ})$ time, where \mathcal{S} is the set of all characters and non-terminals, occ is the number of occurrences, and occ_C is the number of occurrences of a chosen core C of P in the right hand side of all production rules of the grammar of T . Our grammar index requires $\mathcal{O}(g)$ words of space and can be built in $\mathcal{O}(n)$ time using $\mathcal{O}(g)$ working space, where g is the sum of the right hand sides of all production rules. We underline the strength of our grammar index with an exhaustive practical evaluation that gives evidence that our proposed solution excels at locating long patterns in highly-repetitive texts. Our implementation is available at https://github.com/TooruAkagi/GCIS_Index.

Keywords: grammar compression locality sensitive parsing induced suffix sorting text indexing data structure.

1 Introduction

Although highly-repetitive texts are perceived as a common problem instance nowadays due to use cases involving large sets of DNA sequences within a very narrow taxonomy group or huge numbers of slightly different versions of documents maintained in revision control systems, this problem is difficult to handle due to the large amount of data, but interesting in the sense that the data is highly compressible. Compressed text indexes have become the standard tool for tackling this problem when full-text search queries like locating all occurrences of a pattern are of importance. When working on indexes on highly-repetitive data, a desired property is to have a *self-index*, i.e., a data structure that supports queries on the underlying text without storing the text in its plain form. One type of such self-indexes are *grammar indexes*, which are an augmentation of the admissible grammar [25] produced by a grammar compressor. Grammar indexes exhibit strong compression ratios for semi-automatically generated or highly-repetitive texts. Unlike other indexes that perform pattern matching stepwise character-by-character, some grammar indexes have locality sensitive parsing properties, which allow them to match certain non-terminals of the admissible grammar built upon the pattern with the non-terminals of the text. Such a property helps us to compute fewer comparisons, and thus speeds up pattern matching for particularly long patterns, which could be large gene sequences in a genomic database or source code files in a database maintaining source code. Here, our focus is set on indexes that support $\text{locate}(P)$ queries retrieving the starting positions of all occurrences of a given pattern P in a given text.

Table 1: Needed space (in words) and query time for locate for a pattern of length m regarding the grammar indexes of Sect. 1.2.

Index	Space	Locate Time
Claude and Navarro [6]	$\mathcal{O}(\hat{g})$	$\mathcal{O}(m^2 \lg \lg_{\hat{g}} n + (m + \text{occ}) \lg \hat{g})$
Gagie et al. [19]	$\mathcal{O}(\hat{g} + z \lg \lg z)$	$\mathcal{O}(m^2 + (m + \text{occ}) \lg \lg n)$
Christiansen et al. [4]	$\mathcal{O}(\gamma \lg(n/\gamma))$	$\mathcal{O}(m + \lg^{\epsilon} \gamma + \text{occ} \lg^{\epsilon}(\gamma \lg(n/\gamma)))$
Christiansen et al. [4]	$\mathcal{O}(\gamma \lg(n/\gamma) \lg^{\epsilon}(\gamma \lg(n/\gamma)))$	$\mathcal{O}(m + \text{occ})$
Tsuruta et al. [39]	$\mathcal{O}(g_{\text{Lyn}})$	$\mathcal{O}(m + \lg m \lg n + \text{occ} \lg g_{\text{Lyn}})$

n is the length of T , z is the number of LZ77 [40] phrases of T , γ is the size of the smallest string attractor [24] of T , g_{Lyn} is the size of the Lyndon SLP of T , \hat{g} is the size of a given admissible grammar, $\epsilon > 0$ is a constant, m is the length of a pattern P , and occ is the number of occurrences of P in T .

1.1 Our Contribution

Our main contribution is the discovery of a locality sensitive parsing property in the grammar produced by the grammar compression by induced sorting (GCIS) [34], which helps us to answer locate with an index built upon GCIS with the following bounds:

Theorem 1.1. Given a text T of length n , we can compute an indexing data structure on T in $\mathcal{O}(n)$ time, which can locate all occ occurrences of a given pattern of length m in $\mathcal{O}(m \lg |\mathcal{S}| + \text{occ}_C \lg n \lg |\mathcal{S}| + \text{occ})$ time, where \mathcal{S} is the set of characters and non-terminals of the GCIS grammar and occ_C is the number of occurrences in the right side of the production rules of the GCIS grammar of a selected core of the pattern. Our index can be constructed in $\mathcal{O}(n)$ time and uses $\mathcal{O}(g)$ words of working space, where g is the sum of the right hand sides of all production rules.

Similar properties hold for other grammars such as the signature encoding [30], ESP [9], HSP [18], the Rsync parse [21], or the grammar of Christiansen et al. [4, Sect. 4.2]. A brief review of these and other self-indexes follows.

1.2 Related Work

In the field of self-indexes, grammar compression has won high popularity since a grammar can eliminate repetitions while exhibiting powerful query properties. A grammar index is a *self-index*, i.e., a data structure that supports queries on the underlying text without storing the text in its plain form.

With respect to indexing a grammar for answering locate, the first work we are aware of is due to Claude and Navarro [5] who studied indices built upon so-called *straight-line programs (SLPs)*. An SLP is a context-free grammar representing a single string in the Chomsky normal form. We present their complexity bounds along with improved versions [6, 8, 19] in Table 1.

Other research focused on particular types of grammar, such as the ESP-index [29, 37, 38], an index [7] combining Re-Pair [27] with the Lempel–Ziv-77 parsing [40], a dynamic index [31] based on signature encoding [30], the Lyndon SLP [39], or the grammar index of Christiansen et al. [4].

For the experiments in Sect. 6, we will additionally have a look at other self-indexes capable of locate-queries. There, we analyze Burrows–Wheeler-transform (BWT) [3]-based approaches, namely the FM-index [16] and the r -index [20].

Finally, the grammar GCIS has other interesting properties besides being locality sensitive. Nunes et al. [33] showed how to compute the suffix array and the longest-common-prefix array from GCIS during a decompression step restoring the original text. Recently, Díaz-Domínguez and Navarro [10] show how to compute the BWT directly from the GCIS grammar.

2 Preliminaries

With \lg we denote the logarithm \log_2 to base two. Our computational model is the standard word RAM with machine word size $\Omega(\lg n)$, where n denotes the length of a given input string $T[1..n]$, which we call *the text*, whose characters are drawn from an integer alphabet Σ small enough such that each element of it fits into a constant number of machine words. We call the elements of Σ *characters*. For a string $S \in \Sigma^*$, we denote with $S[i..]$ its i -th suffix, and with $|S|$ its length.

2.1 Induced Suffix Sorting

SAIS [32] is a linear-time algorithm for computing the suffix array [28]. We briefly review the parts of SAIS important for constructing the GCIS grammar. SAIS assigns each suffix a type, which is either L or S: $T[i..]$ is an L suffix if $T[i..] \succ T[i+1..]$, or $T[i..]$ is an S suffix otherwise, i.e., $T[i..] \prec T[i+1..]$, where we stipulate that $T[|T|]$ is always type S. Since it is not possible that $T[i..] = T[i+1..]$, SAIS assigns each suffix a type. An S suffix $T[i..]$ is additionally an S* suffix (also called LMS suffix in [32]) if $T[i-1..]$ is an L suffix. The substring between two succeeding S* suffixes is called an *LMS substring*. In other words, a substring $T[i..j]$ with $i < j$ is an LMS substring if and only if $T[i..]$ and $T[j..]$ are S* suffixes and there is no $k \in (i..j)$ such that $T[k..]$ is an S* suffix. Regarding the defined types, we make no distinction between suffixes and their starting positions (e.g., the statements that (a) $T[i]$ is type L and (b) $T[i..]$ is an L suffix are equivalent). In fact, we can determine L and S positions solely based on their succeeding positions with the equivalent definition: $T[i]$ is L if $T[i] > T[i+1]$, $T[i]$ is S if $T[i] < T[i+1]$, or $T[i]$ has the same type as $T[i+1]$ if $T[i] = T[i+1]$.

Nong et al. [32, A3.4] compute the lexicographic order of all LMS substrings with the induced sorting, which we omit here (we use it as a black box). The LMS substrings of $\#T$ for $\#$ being a special character smaller than all characters appearing in T such that $\#T$ starts with an S* position, induce a factorization of $T = F_1 \cdots F_z$, where each factor starts with an LMS substring. We call this factorization *LMS-factorization*. By replacing each factor F_i by the lexicographic rank of its respective LMS substring, we obtain a string $T^{(1)}$ of these ranks. We recurse on $T^{(1)}$ until we obtain a string $T^{(\tau_T-1)}$ whose rank-characters are all unique or whose LMS-factorization consists of at most two factors.

2.2 Constructing the Grammar

We assign each computed factor $F_j^{(h)}$ a non-terminal $X_j^{(h)}$ such that $X_j^{(h)} \rightarrow F_j^{(h)}$, but omit the delimiter $\#$. The order of the non-terminals $X_j^{(h)}$ is induced by the lexicographic order of their respective LMS-substrings. We now use the non-terminals instead of the lexicographic ranks in the recursive steps. If we set $X^{(\tau_T)} \rightarrow T^{(\tau_T-1)}$ as the start symbol, we obtain a context-free grammar $\mathcal{G}_T := (\Sigma, \Gamma, \pi, X^{(\tau_T)})$, where Γ is the set of non-terminals and a function $\pi : \Gamma \rightarrow (\Sigma \cup \Gamma)^+$ that applies (production) rules. For simplicity, we say that $\pi(c) = c$ for $c \in \Sigma$. Let g denote the sum of the right hand sides of all grammar rules. We say that a non-terminal ($\in \Gamma$) or a character ($\in \Sigma$) is a *symbol*, and denote the set of characters and non-terminals with $\mathcal{S} := \Sigma \cup \Gamma$. We understand π also as a string morphism $\pi : \mathcal{S}^* \rightarrow \mathcal{S}^*$ by applying π on each symbol of the input string. This allows us to define the *expansion* $\pi^*(X)$ of a symbol X , which is the iterative application of π until obtaining a string of characters, i.e., $\pi^*(X) \subset \Sigma^*$ and $\pi^*(X^{(\tau_T)}) = T$. Since $\pi(X)$ is deterministically defined, we use to say *the right hand side of X* for $\pi(X)$.

Lemma 2.1 ([34]). The GCIS grammar \mathcal{G}_T can be constructed in $\mathcal{O}(n)$ time. \mathcal{G}_T is *reduced*, meaning that we can reach all non-terminals of Γ from $X^{(\tau_T)}$.

\mathcal{G}_T can be visualized by its derivation tree, which has $X^{(\tau_T)}$ as its root. Each rule $X_k^{(h)} \rightarrow X_i^{(h-1)} \cdots X_j^{(h-1)}$ defines a node $X_k^{(h)}$ having $X_i^{(h-1)}, \dots, X_j^{(h-1)}$ as its children. The height of the derivation tree is $\tau_T = \mathcal{O}(\lg n)$ because the number of LMS substrings of $T^{(h)}$ is at most half of the length of $T^{(h)}$ for each recursion level h . The leaves of the derivation tree are the terminals at height 0 that constitute the characters of the text T . Reading the nodes on height $h \in [0.. \tau_T - 1]$ from left to right gives $T^{(h)}$ with $T^{(0)} = T$. Note that

we use the derivation tree only as a conceptual construct since it would take $\mathcal{O}(n)$ words of space. Instead, we merge (identical) subtrees of the same non-terminal together to form a directed acyclic graph (DAG), which we call DAG, which is implicitly represented by π .

By construction, each non-terminal appears exactly in one height of the grammar tree. We therefore can separate the non-terminals into the sets $\Gamma^{(1)}, \dots, \Gamma^{(\tau_T)}$ such that a non-terminal of height h belongs to $\Gamma^{(h)}$. More precisely, π maps a non-terminal on height $h > 1$ to a string of symbols on height $h - 1$. Hence, the grammar is acyclic.

Unfortunately, there are strings with $g = \Theta(n)$, so for a particular input, the grammar does not compress at all: Let $T = \prod_{i=0}^m \mathbf{a}^i \mathbf{b} = \mathbf{b} \cdot \mathbf{ab} \cdot \mathbf{aab} \cdot \mathbf{aaab} \cdots$ with $\Sigma = \{\mathbf{a}, \mathbf{b}\}$ and $\mathbf{a} < \mathbf{b}$. Then we have the rules $X_i^{(1)} \rightarrow \mathbf{a}^i \mathbf{b}$ for $i \in [0..m]$, with $X^{(2)} \rightarrow \prod_{i=0}^m X_i^{(1)}$ being the (production) rule of the start symbol $X^{(2)}$. Hence, $\tau_T = 2$ and $g = |T| + |\pi(X^{(2)})| = |T| + m + 1$. Nevertheless, the experiments in Sect. 6 show that the grammar is suitable for most highly-repetitive text collections.

3 GCIS Index

In what follows, we want to show that we can augment \mathcal{G}_T with auxiliary data structures for answering locate. Our idea stems from the classic pattern matching algorithm with the suffix tree [22, APL1]. The key difference is that we search the core of a pattern in the right hand sides of the rules. For that, we make use of the generalized suffix tree GST built upon $R := \prod_{X \in \Gamma} \pi(X)\$,$ i.e., the right hand sides of all rules, for a special delimiter symbol $\$$ being smaller than all symbols. Since we have a budget of $\mathcal{O}(g)$ words, we can afford to use a plain pointer-based tree topology. Each leaf λ stores a pointer to the non-terminal $X^{(h)}$ and an offset o such that $\pi(X^{(h)})[o..]$ is a prefix of λ 's string label. Next, we need the following operation on GST:

- **lca**(u, v): gives the lowest common ancestor (LCA) of two nodes u and v . We can augment GST with the data structure of Buchsbaum et al. [2] in linear time and space in the number of nodes of GST. This data structure answers lca in constant time.
- **child**(u, c): gives the child of the node u connected to u with an edge having a label starting with $c \in \Gamma$. Our GST implementation answers child in $\mathcal{O}(\lg |\mathcal{S}|)$ time. For that, each node stores the pointers to its children in a binary search tree with the first symbol of each connecting edge as key.
- **string_depth**(v): returns the string depth of a node v , i.e., the length of its string label, which is the string read from the edge labels on the path from the root to v . We can compute and store the string depth of each node during its construction.

The operation child allows us to compute the *locus* of a string S , i.e., the highest GST node u whose string label has S as a prefix, in $\mathcal{O}(|S| \lg |\mathcal{S}|)$ time. For each $\pi(X)$, we augment the locus u of $\pi(X)\$$ with a pointer to X such that we can perform **lookup**(S) returning the non-terminal X with $\pi(X) = S$ or an invalid symbol \perp if such an X does not exist. The time is dominated by the time for computing the locus of S .

The leaves of GST are connected with a linked list. Each internal node v stores a pointer to the leftmost leaf in the subtree rooted at v . With that we can use the function **lce**(X, Y, i, j) returning the longest common prefix of $\pi(X)[i..]$ and $\pi(Y)[j..]$ for $X, Y \in \Gamma$ and $i \in [1..|\pi(X)|], j \in [1..|\pi(Y)|]$. We can answer **lce**(X, Y, i, j) by selecting the leaves $X.P[i]$ and $Y.P[j]$, retrieve the LCA **lca**($X.P[i], Y.P[j]$) of both leaves, and take its string depth, all in constant time. More strictly speaking, we return $\min(|\pi(X)[i..]|, |\pi(Y)[j..]|, \mathbf{string_depth}(\mathbf{lca}(X.P[i], Y.P[j])))$, since the delimiter $\$$ is not a unique character, but appears at each end of each right hand side in the underlying string R of GST.

Each rule $X \in \Gamma$ stores an array $X.P$ of $\pi(X)$ pointers to the leaves in GST such that the $X.P[i]$ points to the leaf that points back to X and has offset i (its string label has $\pi(X)[i..]$ as a prefix). Additionally, each rule X stores the length of $\pi(X)$, an array $X.L$ of all expansion lengths of all its prefixes, i.e., $X.L[i] := \sum_{j=1}^i |\pi^*(\pi(X)[j])|$, and an array $X.R$ of the lengths of the right hand sides of all its prefixes, i.e., $X.R[i] := \sum_{j=1}^i |\pi(\pi(X)[j])|$.

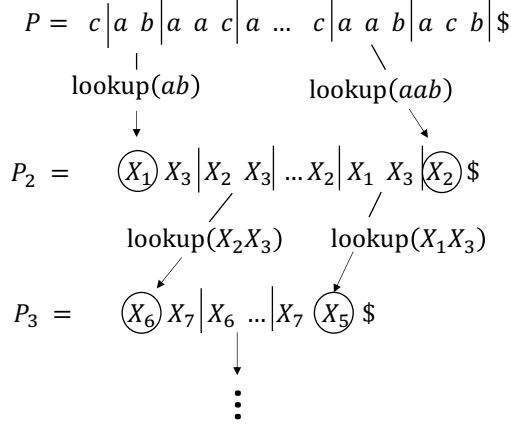

Figure 1: Computing \mathcal{G}_P in Sect. 4.1. For each height h , we compute the LMS factorization $P^{(h)} = F_1^{(h)} \dots F_z^{(h)}$ of $P^{(h)}$, query $X_i^{(h+1)} = \text{lookup}(F_i^{(h)})$ for $i \in [2..z-1]$, and continue with $P^{(h+1)} := \prod_{i=2}^{z_h-1} X_i^{(h+1)}$ unless there is one i with $X_i^{(h+1)} = \perp$, for which we abort the pattern matching.

Complexity Bounds GST can be computed in $\mathcal{O}(g)$ time [15]. The grammar index consists of the GCIS grammar, GST built upon $|R| = g + |\Gamma|$ symbols, and augmented with a data structure for lca [2]. This all takes $\mathcal{O}(g)$ space. Each non-terminal is augmented with an array $X.P$ of pointers to leaves, $X.L$ and $X.R$ storing the expansion lengths of all prefixes of $\pi(X)$, which take again $\mathcal{O}(g)$ space when summing over all non-terminals.

4 Pattern Matching Algorithm

Like Sahinalp and Vishkin [36, Sect. 2], our idea is to first fix a core C of a given pattern P , find the occurrences of C in the text, and then try to extend all these occurrences to occurrences of P . However, we do not try to find the occurrences of P directly, but rather the lowest DAG nodes (a) having C as a descendant and (b) having such a large expansion that we could extend C to P .

4.1 Cores

A core is a string of symbols C of the GCIS grammar \mathcal{G}_P built on the pattern P , which has the property that all occurrences of C whose expansion can be extended to an occurrence of P are (not necessarily proper) substrings of the right hand sides of the rules of \mathcal{G}_T . Put differently, given C consists of consecutive nodes on height $h \geq 0$ in the grammar tree, if there is an occurrence of C in the grammar tree that has at least two parent nodes on height $h+1$, then the expansion of this occurrence of C does *not* lead to an occurrence of P . We qualify a core by the difference in the number of occurrences of P and C in the grammar tree. On the one hand, although a character $P[i]$ always qualifies as a core, the appearance of $P[i]$ in T is unlikely to be an evidence of an occurrence of P . (Additionally, our algorithm would perform worse than a standard pattern matching with the suffix tree when resorting to single characters as cores). On the other hand, the non-terminal covering most of the characters of P might not be a core. Hence, we aim for the highest possible non-terminal, for which we are sure that it exhibits the core property.

Finding a Core We determine a core C of P during the computation of the GCIS grammar \mathcal{G}_P of P . During this computation, we want to assure that we only create a new non-terminal for a factor F whenever $\text{lookup}(F) = \perp$; if $\text{lookup}(F) = X$, we borrow the non-terminal X from \mathcal{G}_T . By doing so, we ensure that non-terminals of \mathcal{G}_P and \mathcal{G}_T are identical whenever their right hand sides of their productions are equal. In detail, if we create the factors $P^{(h)} = F_1^{(h)} \dots F_{z_h}^{(h)}$, we first retrieve $Y_i^{(h)} := \text{lookup}(P^{(h)})$ for each $i \in [2..z_h-1]$. If one of the lookup-queries returns \perp , we abort since we can be sure that the pattern does not occur in T . That is because all non-terminals $Y_2^{(h)}, \dots, Y_{z_h-2}^{(h)}$ classify as cores. To see this, we observe that prepending or appending symbols to $P^{(h)}$ does not change the factors $F_2^{(h)}, \dots, F_{z-1}^{(h)} =: C^{(h)}$. We give

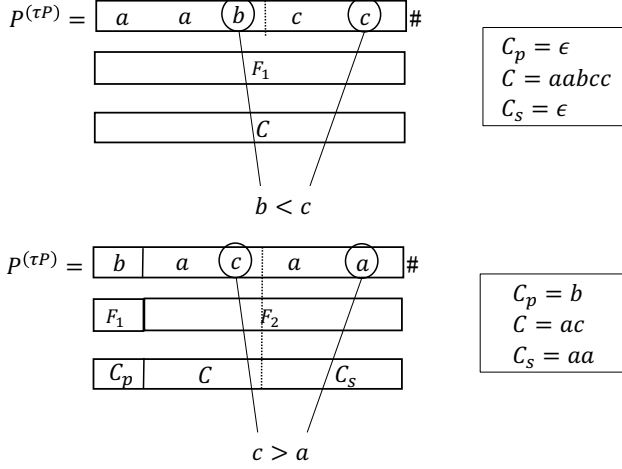

Figure 2: Determining the core C of P from $P^{(\tau_P)}$. Top: The LMS factorization of $P^{(\tau_P)}$ consists only of one factor F_1 , so C_p is empty. The last character run cc consists of a character larger than the previous character run with b run such that C_s is empty, too. Bottom: The factorization consists of two factors $F_1 F_2$, so $C_p = F_1$. Since the last character run aa is lexicographically smaller than the previous one with c , C_s is set to this last character run.

a visual interpretation in Fig. 1.

Correctness We show that when prepending or appending characters to $F_1^{(h)} C^{(h)} F_{z_h}^{(h)}$ does not modify the computed factorization of $C^{(h)} = F_2^{(h)}, \dots, F_{z-1}^{(h)}$. What we show is that we cannot change the type of any position $C^{(h)}[i]$ to \mathbf{S}^* : Firstly, the type of a position (\mathbf{S} or \mathbf{L}) depends only on its succeeding position, and hence prepending cannot change the type of a position in $C^{(h)}$. Secondly, appending characters can either prolong $F_{z_h}^{(h)}$ or create a new factor $F_{z_{h+1}}^{(h)}$ since $F_{z_h}^{(h)}$ starts with \mathbf{S}^* , and therefore appending cannot change $C^{(h)}$. An additional insight is that on the one side, prepending character can only introduce a new factor or extend $F_1^{(h)}$. On the other side, appending characters can introduce at most one new \mathbf{S}^* position in $F_{z_h}^{(h)}$ that can make it split into two factors. We will need this observation later for extending the core to the pattern, cf. Fig. 5.

The construction of \mathcal{G}_P iterates the LMS factorization until we are left with a string of symbols $P^{(\tau_P)}$ whose LMS factorization consists of at most two factors. In that case, we partition $P^{(\tau_P)}$ into three substrings $C_p C C_s$ with C_p and C_s possibly empty, and defined as follows: (1) If the LMS factorization consists of two non-empty factors $F_1 \cdot F_2$, then C_p is F_1 . (2) Given $P^{(\tau_P)} = (P^{(\tau_P)}[j_1])^{c_1} \dots (P^{(\tau_P)}[j_k])^{c_k}$ is the run-length-encoded representation of P with $1 = j_1 < \dots < j_k = |P^{(\tau_P)}|$, $c_{j_i} \geq 1$ for $i \in [1..k]$, and $P[j_i] \neq P[j_{i+1}]$ for $i \in [1..k-1]$, we set $C_s \leftarrow (P^{(\tau_P)}[j_k])^{c_k}$ if $P^{(\tau_P)}[j_k] < P^{(\tau_P)}[j_{k-1}]$. (3) In the other cases, C_p and/or C_s are empty. Figure 2 visualizes the cases. To see why C is a core, we only have to check the case when C_s is empty. The other cases have already been covered by the aforementioned analysis of the cores on the lower heights. If C_s is empty, then C ends with P , and as a border case, the last position of C is \mathbf{S}^* . In that case, when appending a symbol smaller than $P[m]$ to $F_1^{(h)} C$ changes the type of the last position of C to \mathbf{L} . If we append a symbol larger than $P[m]$, then the last position of C becomes \mathbf{S} , but does not become \mathbf{S}^* since $P^{(\tau_P)}[j_k] > P^{(\tau_P)}[j_{k-1}]$ due to construction (otherwise C_s would not be empty).

In total, there are symbols $A^{(1)}, \dots, A^{(\tau_P-1)}$ and $S^{(1)}, \dots, S^{(\tau_P-1)}$ such that

$$P = \pi(F_1^{(1)} \dots F_1^{(\tau_P-2)} A^{(1)} \dots A^{(\tau_P-2)} C S^{(\tau_P-2)} \dots S^{(1)} F_{z_{\tau_P-2}}^{(\tau_P-2)} \dots F_{z_1}^{(1)}), \quad (1)$$

and $A^{(h)}, S^{(h)} \in \Gamma^{(h)}$ are cores of P , while $F_1^{(h)}, F_{z_h}^{(h)} \in (\Gamma^{(h-1)})^*$ are factors.

4.2 Matching with GST

Having C , we now switch to GST and use it to find all DAG parents of C , whose number we denote by $\text{occ}_C \in \mathcal{O}(g)$. This number is also the number of occurrences of C in the right hand sides of all rules of \mathcal{G}_T . Having these parents, we want to find all lowest DAG ancestors of C whose expansions are large enough to

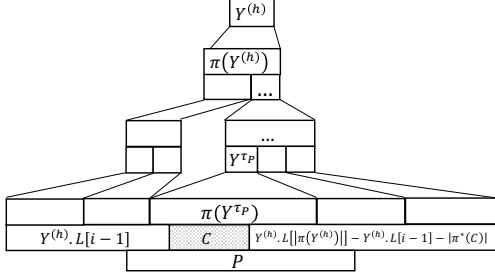

Figure 3: Deriving a non-terminal $Y^{(h)}$ with $\pi^*(Y^{(h)})$ containing P from a non-terminal $Y^{(\tau_P)}$ with $\pi^*(Y^{(\tau_P)})$ containing $\pi^*(C)$. The expansion of none of the descendants of $Y^{(h)}$ towards $Y^{(\tau_P)}$ is large enough for extending its contained occurrence of $\pi^*(C)$ to an occurrence of P . We can check the expansion lengths of the substrings in $\pi(Y^{(h)})$ via the array $Y^{(h)}.L$.

not only cover C but also P by extending C to its left and right side — see Fig. 3 for a sketch. We proceed as follows: We first compute the locus v of C in $\mathcal{O}(|C| \lg |\mathcal{S}|)$ time via `child`. Subsequently, we take the pointer to the leftmost leaf in the subtree rooted at v , and then process all leaves in this subtree by using the linked list of leaves. For each such leaf λ , we compute a path in form of a list λ_L from the non-terminal containing C on its right hand side up to an ancestor of it that has an expansion large enough to cover P if we would expand the contained occurrence of C to P . We do so as follows: Each of these leaf stores a pointer to a non-terminal X and a starting position i such that we know that $\pi^*(X)[i..]$ starts with $\pi^*(C)$. By knowing the expansion lengths $X.L[|\pi(X)|]$, $X.L[i-1]$, and $|\pi^*(C)|$, we can judge whether the expansion of X has enough characters to be able to extend its occurrence of C to P . If it has enough characters, we put (X, i) onto λ_L such that we know that $\pi^*(X)[X.L[i-1] + 1..]$ has C as a prefix. If X does not have enough characters, we exchange C with X and recurse on finding a non-terminal with a larger expansion. By doing so, we visit at most $\tau_T = \mathcal{O}(\lg n)$ non-terminals per occurrence of C in the right hand sides of \mathcal{G}_T . We perform all operations in $\mathcal{O}(\text{occ}_C \tau_T \lg |\mathcal{S}|)$ time because we query `child` in every recursion step.

The previous step computes, for each accessed leaf λ , a list λ_L containing a DAG path $(Y^{(h)}, \dots, Y^{(\tau_P)})$ of length $\mathcal{O}(\tau_T)$ and an offset $o^{(\tau_P)}$ such that $Y^{(\tau_P)}[o^{(\tau_P)}..]$ starts with C . By construction, these paths cover all occurrences of C in the grammar tree. Note that we process the DAG node $Y^{(\tau_P)}$ (but for different offsets $o^{(\tau_P)}$) as many times as C occurs in $\pi(Y^{(\tau_P)})$. In what follows, we try to expand the occurrence of C captured by $Y^{(\tau_P)}$ and $o^{(\tau_P)}$ to an occurrence of P . See Fig. 5 for a sketch of the setting. Naively, we would walk down from $Y^{(\tau_P)}[o^{(\tau_P)}]$ to the character level and extend the substring $\pi^*(C)$ in both directions by character-wise comparison with P . However, this would take $\mathcal{O}(\text{occ}_C m \tau_T)$ time since such a non-terminal $Y^{(h)}$ is of height $\mathcal{O}(\tau_T)$. Our claim is that we can perform the computation in $\mathcal{O}(m + \text{occ}_C \tau_T)$ time with the aid of `Ice` and an amortization argument.

For that, we use Eq. (1), which allows us to use LCE queries in the sense that we can try to extend an occurrence of C with an already extended occurrence (that maybe does not match P completely). For the explanation, we only focus on extending all occurrences of C to the right to CC_s (the left side side is done symmetrically), cf. Fig. 4. We maintain an array D of length τ_P storing pairs $(X^{(h)}, \ell_h)$ for each height $h \in [1.. \tau_P - 1]$ such that $\pi(X^{(h)})$ has the currently longest extension of length ℓ_h with the core $S^{(h-1)}$ of P in common (cf. Eq. (1)). By maintaining D , we can first query `Ice` with the specific non-terminal in D , and then resort to plain symbol comparison. We descend to the child where the mismatch happens and recurse until reaching the character level of the grammar tree. This all works since by the core property the mismatch of a child means that there is a mismatch in the expansion of this child. Since a plain symbol comparison with matching symbols lets us exchange the currently used non-terminal in D with a longer one, we can bound (a) the total number of naive symbol matches to $\mathcal{O}(m)$ and (b) the total number of naive symbol mismatches and LCE queries to $\mathcal{O}(\text{occ}_C \tau_T)$.

Put in technical terms, we start with D storing only invalid entries \perp to indicate that there is no candidate on any height for LCE queries. Suppose that we are given a DAG path $(Y^{(h)}, \dots, Y^{(\tau_P)})$ to an occurrence of C and an offset $o^{(\tau_P)}$ such that $Y^{(\tau_P)}[o^{(\tau_P)}..]$ starts with C . Set $Y^{(\tau_P-1)} := Y^{(\tau_P)}[o^{(\tau_P)} + |C| - 1]$. We scan the entries of D from $j = \tau_P - 1$ to $j = 1$ while checking whether $D[j] = \perp$: Suppose that $D[j] = (\tilde{Y}^{(j)}, \tilde{\ell}^{(j)})$ is not empty, we compute $\ell := \text{Ice}(\tilde{Y}^{(j)}, 1, Y^{(j)}, 1)$. We abort if $\ell < \tilde{\ell}^{(j)}$. Otherwise, we set $Y^{(j-1)} := Y^{(j)}[\tilde{\ell}^{(j)} + 1]$, and recurse. If $D[j] = \perp$, we compare $\pi(Y^{(j)})$ with the respective cores of the pattern at height $j - 1$, cf. Eq. (1) and Fig. 5. On reaching $j = 1$, we compare the right hand sides of $Y^{(1)}$ and its right siblings with

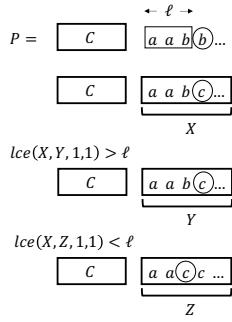
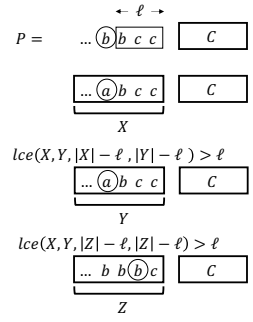

Figure 4: LCE queries issued in Sect. 4.2. Left: Let $X, Y, Z \in \Gamma^{(h)}$. Assume that the expansion of the first ℓ symbols of the non-terminal X coincide with the expansion of C_s , and that X is currently stored in D . When we want to compute the number of matching characters of the expansion of C_s with the expansion of Y or Z , we first issue LCE queries with X to decide whether there is a mismatch at one of the first ℓ symbols; in such a case we know that we cannot find an occurrence of the pattern, as it is the case with Z . Right: Symmetric application for matching the extension of C_p .



the remaining part of the pattern. On reaching a mismatch or completing $\pi^*(C_s)$, we update the entries of D while climbing up path , and store the node $Y^{(h)}$ with the starting position of the respective occurrence of P relative to its grammar subtree in a list W . The traversal, the update of D , and LCE queries take $\mathcal{O}(\tau_T)$ time per occurrence of C , while the total number of naive symbol matches accumulate to $\mathcal{O}(m)$ time. Note that we need the path of λ_L to start at $Y^{(h)}$, since otherwise selecting sibling nodes on the same height can cost $\mathcal{O}(\tau_T)$ time.

Finding the Starting Positions It is left to compute the starting position in T of each occurrence captured by an element in W . We can do this similarly to computing the pre-order ranks in a tree: For each pair $(X, \ell) \in W$, climb up DAG from X to the root while accumulating the expansion lengths of all left siblings of the nodes we visit (we can make use of $X.L$ for that). If this accumulated length is s , then $\ell + s$ is the starting position of the occurrence captured by (X, ℓ) . However, this approach would cost $\mathcal{O}(\tau_T)$ time per element of W . Here, we use the amortization argument of Claude and Navarro [6, Sect. 5.2], which works if we augment, in a pre-computation step, each non-terminal X in Γ with (a) a pointer to the lowest ancestor Y_X on every path from X to the DAG root that has X at least twice as a descendant, and (b) the lengths of the expansions of the left siblings of the child of Y_X being a parent of X or X itself. By doing so, when taking a pointer of a non-terminal X to its ancestor Y_X , we know that X has another occurrence in DAG (and thus there is another occurrence of P). Therefore, we can charge the cost of climbing up the tree with the amount of occurrences occ of the pattern.

Total Time To sum up, we spent $\mathcal{O}(m \lg |\mathcal{S}|)$ time for finding C , $\mathcal{O}(\text{occ}_C \tau_T \lg |\mathcal{S}|)$ time for computing the non-terminals covering C , $\mathcal{O}(m + \text{occ}_C \tau_T)$ time for reducing these non-terminals to W , and $\mathcal{O}(\text{occ})$ time for retrieving the starting positions of the occurrences of P in T from W . To be within our $\mathcal{O}(g)$ space bounds, we can process each DAG parent of C individually, and keep only D globally stored during the whole process. The total additional space is therefore $\mathcal{O}(\tau_T) \subset \mathcal{O}(g)$ for maintaining D and a path for each occurrence of C . So we finally obtain the claim of Thm. 1.1.

5 Implementation

The implementation deviates from theory with respect to the rather large hidden constant factor in the $\mathcal{O}(g)$ words of space. We drop GST, and represent DAG with multiple arrays. For that, we first enumerate the non-terminals as follows: The height and the lexicographic order induce a natural order on the non-terminals in Γ , which are ranked by first their height and secondly by the lexicographic order of their right hand sides, such that we can represent $\Gamma = \{X_1, \dots, X_{|\Gamma|}\}$. By stipulating that all characters are lexicographically smaller than all non-terminals, we obtain the property that $\pi(X_i) \prec \pi(X_{i+1})$ for all $i \in [1..|\Gamma| - 1]$. In the following, we first present a plain representation of DAG, called GCIS-nep, then give our modified locate

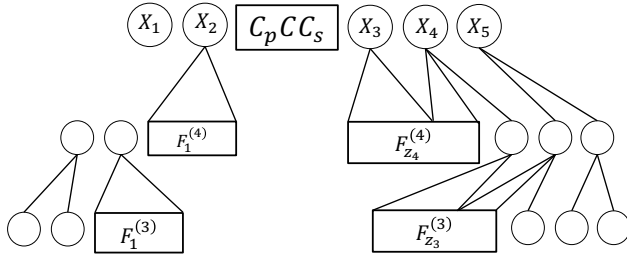

Figure 5: Occurrence of C in the grammar tree of T . Circles symbolize nodes, rectangles multiple sibling nodes. To check whether this occurrence corresponds to an occurrence of P , it suffices to check the extensions of $X_1X_2C_pCC_sX_3X_4X_5$. Although X_1, X_2, X_3, X_4, X_5 are not cores, $\pi(X_2)$, $\pi(X_3)$ and $\pi(X_4)$ extend to symbols that match with symbols in the grammar tree of P . For the pattern matching, it suffices to match $F_1^{(h)}$ and two symbols to its left, and $F_{z_h}^{(h)}$ and three symbols to its right (cf. Sect. 4.1).

algorithm, and subsequently present a compressed version of DAG using universal coding, called GCIS-uni. Finally, we evaluate both implementations in Sect. 6.

Our first implementation, called GCIS-nep (for **n**on-terminals **e**ncoded **p**lainly), represents each symbol with a 32-bit integer. We use $R := \prod_{i=1}^{|\Gamma|} \pi(X_i)$ again, but omit the delimiters $\$$ separating the right hand sides. To find the right hand side of a non-terminal X_i , we create an array of positions $Q[1..|\Gamma|]$ such that $Q[i]$ points to the starting position of $\pi(X_i)$ in R . Finally, we create an array $L[1..|\Gamma|]$ storing the length of the expansion $|\pi^*(X_i)|$ in $L[i]$, for each non-terminal X_i . Due to the stipulated order of the symbols, the strings $R[Q[i]..Q[i+1]-1]$ are sorted in ascending order. Hence, we can evaluate $\text{lookup}(S)$ for a string S in $\mathcal{O}(|S| \lg |\mathcal{S}|)$ time by a binary search on Q with $i \mapsto R[Q[i]..Q[i+1]-1]$ as keys.

Locate Our implementation follows theory for computing \mathcal{G}_P and C (cf. Sect. 4.1) in the same time bounds, but deviates after computing the core C : To find all non-terminals whose right hand sides contain C , we linearly scan the right hand sides of all non-terminals on height τ_P , which we can do cache-friendly since the right-hands of R are sorted by the height of their respective non-terminals. This takes $\mathcal{O}(g + |C|)$ time in total with a pattern matching algorithm [26]. (We can do faster if C_p is not empty: in that case we know that all occurrences of C are prefixes in the right hand sides of the rules of T , and thus can use $\text{lookup}(C)$ to find them.) Finally, for extending a found occurrence of the core C to an occurrence of P , we follow the naive approach to descend DAG to the character level and compare the expansion with P character-wise, which results in $\mathcal{O}(\text{occ}_C|P|\tau_T)$ time. The total time cost is $\mathcal{O}(g + |P|(\text{occ}_C\tau_T + \lg |\mathcal{S}|))$.

GCIS-uni To save space, we can leverage universal code to compress the right hand sides of the productions. First, we observe that Q and the first symbols $F := \pi(X_1)[1], \dots, \pi(X_{|\Gamma|})[1]$ form an ascending sequence, such that we represent both Q and F in Elias-Fano coding [13]. Next, we observe that each right hand side $\pi(X_i)$ form a bitonic sequence: the ranks of the first ℓ_i symbols are non-decreasing, while rest of the ranks are non-increasing. Our idea is to store ℓ_i and the rest of $\pi(X_i)[2..]$ in delta-coding, i.e., $\Delta[i][k] := |\pi(X_i)[k] - \pi(X_i)[k-1]|$ for $k \in [2..|\pi(X_i)|]$, which is stored in Elias- γ code [14]. Although $\pi(X_i)[k] - \pi(X_i)[k-1] < 0$ for $k > \ell_i$, we can decode $\pi(X_i)[k]$ by subtracting instead of adding the difference to $\pi(X_i)[k-1]$ as usual in delta-coding. Hence, we can replace R with Δ , but need to adjust Q such that $Q[i]$ points to the first bit of $\Delta[i]$. Finally, like in the first variant, we store the expansion lengths of all non-terminals in L . Here, we separate L in a first part using 8 bits per entry, then 16 bits per entry, and finally 32 bits per entry. To this end, we represent L by three arrays, start with filling the first array, and continue with filling the next array whenever we process a value whose bit representation cannot be stored in a single entry of the current array. Since Elias-Fano code supports constant-time random access and Elias- γ supports constant-time linear access, we can decode $\pi(X_i)$ by accessing $F[i]$ and then sequentially decode $\Delta[i]$. Hence, we can simulate GCIS-nep with this compressed version without sacrificing the theoretical bounds. We call the resulting index GCIS-uni. Figure 6 captures our compression steps.

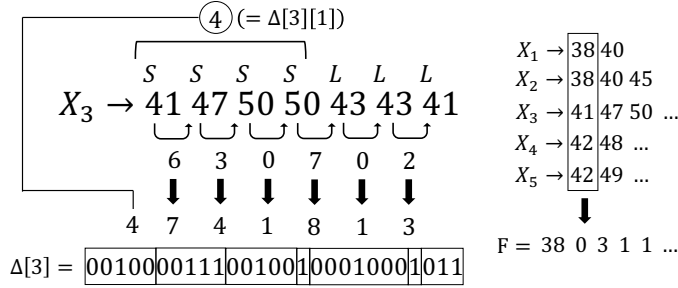

Figure 6: Encoding of GCIS-uni. *Right:* Encoding the first symbol of each right hand side with Elias-Fano and storing the sequence in an integer array F . *Left:* Storing the remaining characters of $\pi(X_3)$ in $\Delta[3]$ delta-encoded with Elias- γ . $\pi(X_3)$ is a bitonic sequence, where the first $\Delta[3][1] = 4$ symbols are increasing. The bottom row depicts the binary representation of $\Delta[3]$.

Table 2: Sizes of the used datasets and the indexes stored on disk. Sizes are in megabytes [MB].

dataset	input size	GCIS-nep	GCIS-uni	ESP-index	FM-index	r-index
COMMONCRAWL	221.180	220.119	138.856	156.006	122.575	454.124
DNA	403.927	527.553	327.852	297.001	216.153	2123.817
EINSTEIN.DE	92.758	1.139	0.428	0.697	40.291	1.1458
ENGLISH.001.2	104.857	14.784	7.489	10.464	46.981	14.389
FIB41	267.914	0.001	0.001	0.001	71.305	0.007
INFLUENZA	154.808	23.373	13.871	15.729	53.066	28.775
KERNEL	257.961	21.298	10.469	12.545	125.087	28.947
RS.13	216.747	0.002	0.001	0.002	57.653	0.009
TM29	268.435	0.002	0.001	0.002	69.347	0.009
WORLD LEADERS	46.968	5.415	2.573	3.611	21.097	5.627

6 Experiments

In the following we present an evaluation of our C++ implementation and different self-indexes for comparison, which are the FM-index [17] (<https://github.com/mpetri/FM-Index>), the ESP-Index [37] (<https://github.com/tkbtksms/esp-index-I>), and the r-index [20] (<https://github.com/nicolaprezza/r-index>). All code has been compiled with gcc-10.2.0 in the highest optimization mode -O3. We ran all our experiments on a Mac Pro Server with an Intel Xeon CPU X5670 clocked at 2.93GHz running Arch Linux.

Our datasets shown in Table 2 are from the Pizza&Chili and the tudocomp [11] corpus.¹ With respect to the index sizes, we have the empirically ranking GCIS-uni < ESP-index < GCIS-nep, followed by one of the BWT-based indexes. While the r-index needs less space than the FM-index on highly-compressible datasets, it is the least favorable option of all indexes for less-compressible datasets. Figure 7 gives the time and memory needed for constructing the indexes. Table 3 presents some characteristics of the GCIS grammar, where $|\pi(X^{(\tau\tau)})|$ is the size of the start symbol.

We can observe in Fig. 9 that our indexes answer $\text{locate}(P)$ fast when P is sufficiently long or has many occurrences occ in T . GCIS-uni is always slower than GCIS-nep due to the extra costs for decoding. In

¹To save space, we renamed the datasets COMMONCRAWL.ASCII.TXT and EINSTEIN.DE.TXT to COMMONCRAWL and EINSTEIN.DE, respectively.

Table 3: Characteristical sizes of the GCIS grammar.

dataset	$ \Gamma $	g	$ \pi(X^{(\tau\tau)}) $
COMMONCRAWL	8565089	37899804	7603482
DNA	21068903	89750482	11462490
EINSTEIN.DE	50554	183664	3491
ENGLISH.001.2	661175	2373818	152854
FIB41	67	173	22
INFLUENZA	971626	3900153	477072
KERNEL	943991	3436501	2478
TM29	104	311	16
WORLD LEADERS	246589	860611	31743

particular for ENGLISH.001.2, GCIS-nep is the fastest index when the pattern length reaches 10000 characters and more. At this time, the pattern grammar reached a height τ_P of almost six, which is the height τ_T . The algorithm can extend an occurrence of a core to a pattern occurrence by checking only 80 - 100 characters. However, when the pattern surpasses 5000 characters, the computation of \mathcal{G}_P becomes the time bottleneck. With that respect, the ESP-index shares the same characteristic. encoding make slow down the location time by about 2 to 10 times approximately. Let us have a look at the dataset FIB41, which is linearly recurrent [12], a property from which we can derive the fact that a pattern that occurs at least once in T has actually a huge number of occurrences in T . There are almost 3,000,000 occurrence of patterns with a length of 100. Here, we observe that our indexes are faster than ESP-index. ESP-index needs more time for locate than GCIS because GCIS can form a core than covers a higher percentage of the pattern than the core selected by ESP. FM-index, and ESP-index with $|P| = 10$ take 100 seconds or more on average – we omitted them in the graph to keep the visualization clear.

Next, we investigate the influence of the occurrences on the query time of locate of our indexes in Fig. 10. Instead of occ_C , which is almost always less than 5, we measure $occ'_C \geq occ_C$ with $occ'_C = \mathcal{O}(occ_C \lg n)$ being the number of all visited DAG nodes for finding the lowest ancestors of C that have a large enough expansion of its occurrence of C to P . For that, we focus again on ENGLISH.001.2 for patterns of fixed length $|P| = 100$, where we observe that occ'_C has a stronger influence on the running time than occ has.

In Fig. 8, we study the maximum height $\tau_P = \mathcal{O}(\lg |P|)$ that we achieved for the patterns with $|P| = 100$ in each dataset. For this experiment, we randomly select a position j in T and extracted $P = T[j..j + 99]$. For every dataset, we could observe that τ_P is logarithmic to the pattern length, especially for the artificial datasets FIB41, TM29, and RS.13, where τ_P is empirically larger than measured in other datasets. In DNA and COMMONCRAWL, τ_P is at most 3, but this is because $\tau_T = 3$ for these datasets.

As a practical optimization, we prematurely abort the computation of \mathcal{G}_T at a certain height $\tau' < \tau_T$ when the reduction of $T^{(\tau'-1)}$ to $T^{(\tau')}$ with the newly introduced rules would increase the grammar size (we measure the needed space in terms of GCIS-nep). Hence, we may end up with a larger right hand side of the start symbol $X^{(\tau')} \rightarrow T^{(\tau'-1)}$, which could be in fact the text itself if the text is incompressible with GCIS. This heuristic takes effect in non-highly-repetitive datasets such as DNA and COMMONCRAWL. It also has an effect on the height τ_P since the core must have a height less than the height of the start symbol of T . Without this heuristic, we reach a height $\tau_T = 9$ for DNA, and we also reach high values for τ_P , on average $\tau_P = 6.55$ for $|P| = 10000$, or $\tau_P = 5.81$ for $|P| = 5000$.

7 Future Work

After determining the occ_C leaves in GST witnessing the occurrences of the core C of P in DAG, the rest of the algorithm is parallelizable since we process each of the GST leaves witnessing an occurrence of C individually, and may obtain $\mathcal{O}(m \lg |\mathcal{S}| + occ_C \lg m \lg |\mathcal{S}|/p + occ/p)$ time for running p processors in parallel. We could also partition the data structures on the grammar per height such that we manage each $\Gamma^{(h)}$ individually. This can practically improve the running time, and the space for GCIS-uni. Further, we would like to add a run-length compression step like in other run-length compressed grammars [23, 30]. Applying GCIS on a run-length encoded text upper-bounds the number of symbols of $F_1^{(h)}$ and $F_{z_n}^{(h)}$ to $2|\Gamma^{(h-1)}|$, or $2|\Sigma|$ for $h = 1$. We also would like to study the impact of DAC codes [1] for representing L , and compressed bit vectors such as [35] with rank/select support for the array Q .

Acknowledgments

This work was supported by JSPS KAKENHI Grant Numbers JP20H04141 (HB), JP21K17701 (DK), JST PRESTO Grant Number JPMJPR1922 (SI).

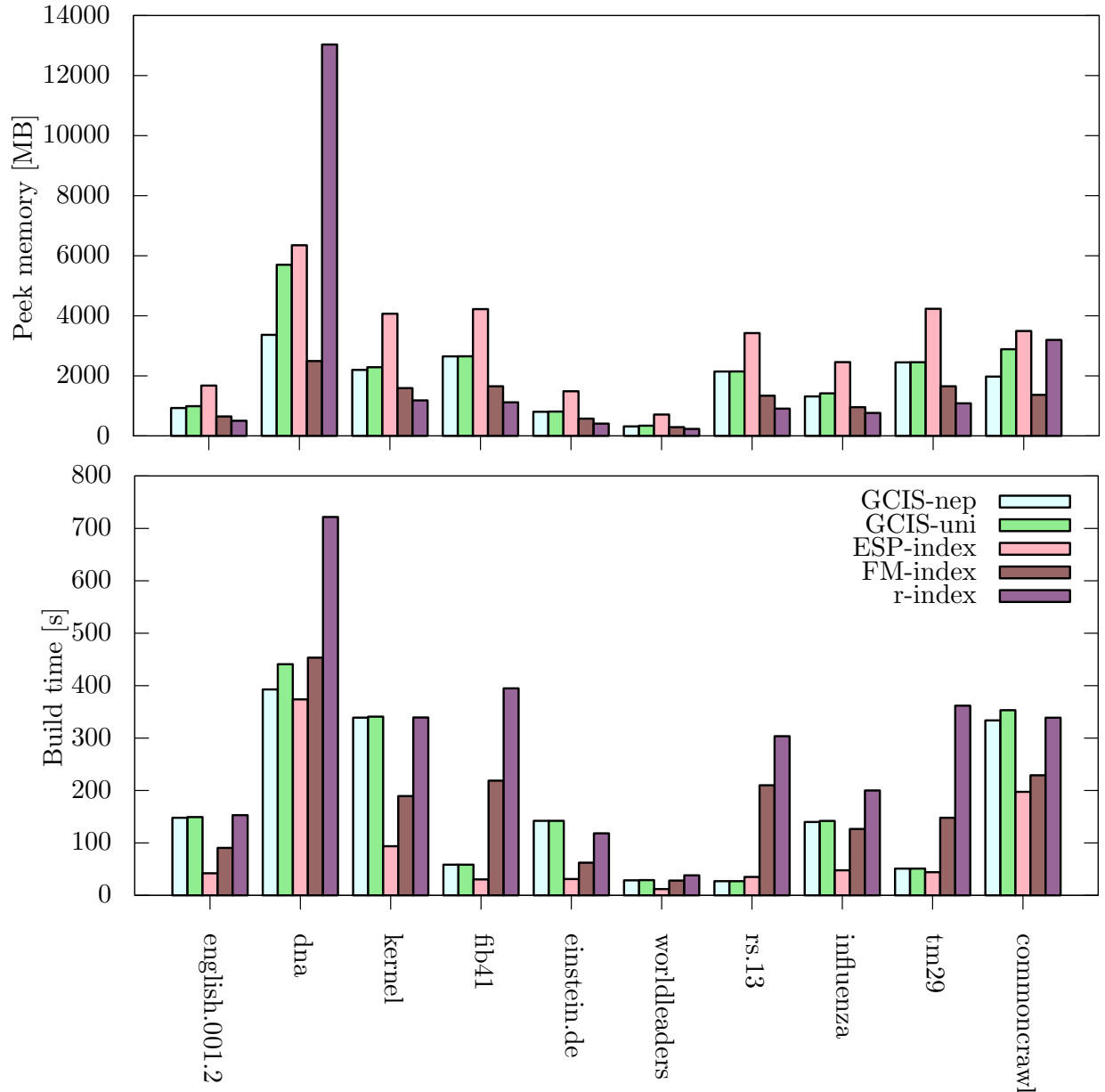

Figure 7: Maximum memory consumption (*top*) and time (*bottom*) during the construction of the indexes. We measured the memory as the *maximum resident set size* reported by `/usr/bin/time`.

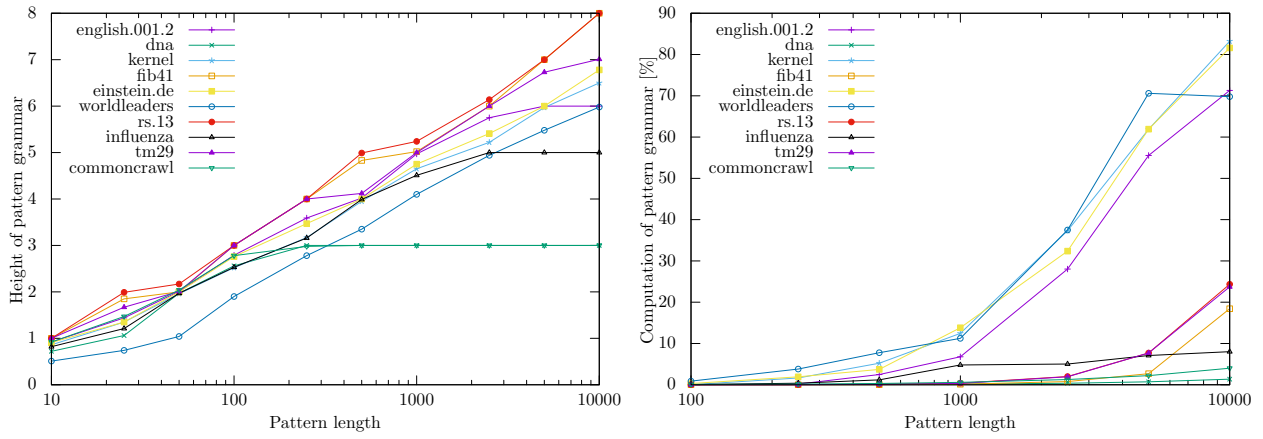

Figure 8: Left: The average height τ_P of \mathcal{G}_P for a pattern of a certain length. Right: Percentage of the computation of \mathcal{G}_P in relation to the whole running time for answering $\text{locate}(P)$ with GCIS-nep.

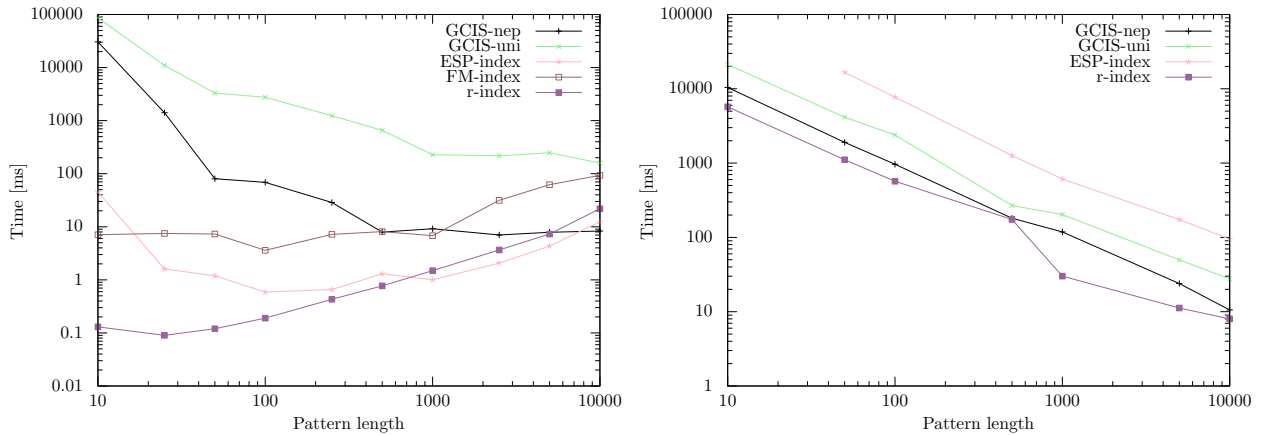

Figure 9: Time for locate while scaling the pattern length on the datasets ENGLISH.001.2 (left) and FIB41 (right). The plots are in logscale. The right figure does not feature the FM-index, which takes considerably more time than the other approaches. For the same reason, there is no data shown for the ESP-index for small pattern lengths, which needs 170 seconds on average for $|P| = 10$.

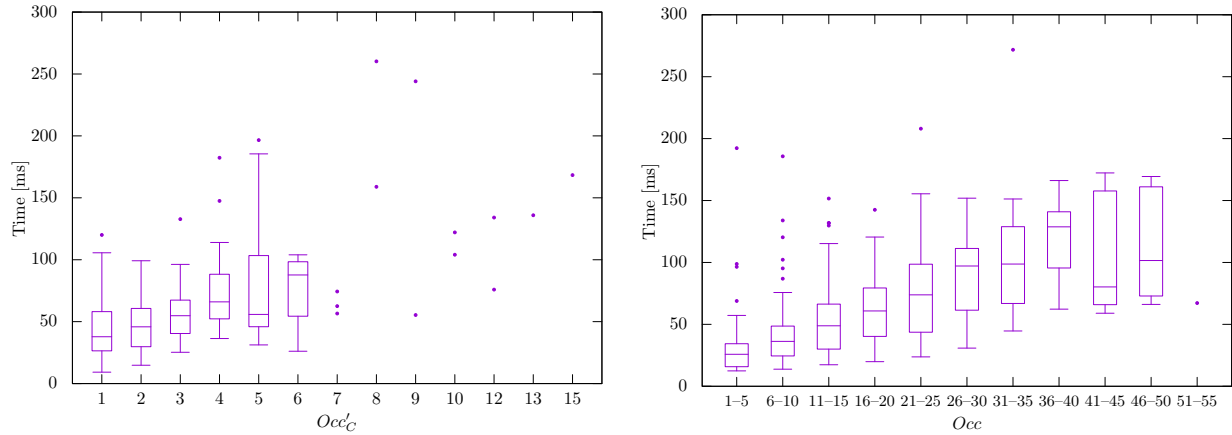

Figure 10: Relation of the number of visited DAG nodes $occ_{C'}$ (left) or the number of occurrences of the pattern occ (right) with the time needed by GCIS-nep for answering $locate(P)$ on the dataset ENGLISH.001.2 for patterns of fixed length $|P| = 100$.

References

- [1] Nieves R. Brisaboa, Susana Ladra, and Gonzalo Navarro. DACs: Bringing direct access to variable-length codes. *Inf. Process. Manage.*, 49(1):392–404, 2013.
- [2] Adam L. Buchsbaum, Haim Kaplan, Anne Rogers, and Jeffery R. Westbrook. Linear-time pointer-machine algorithms for least common ancestors, MST verification, and dominators. In *Proc. STOC*, pages 279–288, 1998.
- [3] Michael Burrows and David J. Wheeler. A block sorting lossless data compression algorithm. Technical Report 124, Digital Equipment Corporation, Palo Alto, California, 1994.
- [4] Anders Roy Christiansen, Mikko Berggren Ettiienne, Tomasz Kociumaka, Gonzalo Navarro, and Nicola Prezza. Optimal-time dictionary-compressed indexes. *ACM Trans. Algorithms*, 17(1):8:1–8:39, 2021.
- [5] Francisco Claude and Gonzalo Navarro. Self-indexed grammar-based compression. *Fundam. Inform.*, 111(3):313–337, 2011.
- [6] Francisco Claude and Gonzalo Navarro. Improved grammar-based compressed indexes. In *Proc. SPIRE*, volume 7608 of *LNCS*, pages 180–192, 2012.
- [7] Francisco Claude, Antonio Fariña, Miguel A. Martínez-Prieto, and Gonzalo Navarro. Universal indexes for highly repetitive document collections. *Inf. Syst.*, 61:1–23, 2016.
- [8] Francisco Claude, Gonzalo Navarro, and Alejandro Pacheco. Grammar-compressed indexes with logarithmic search time. *J. Comput. Syst. Sci.*, 118:53–74, 2021.
- [9] Graham Cormode and S. Muthukrishnan. The string edit distance matching problem with moves. *ACM Trans. Algorithms*, 3(1):2:1–2:19, 2007.
- [10] Diego Díaz-Domínguez and Gonzalo Navarro. A grammar compressor for collections of reads with applications to the construction of the BWT. In *Proc. DCC*, pages 83–92, 2021.
- [11] Patrick Dinklage, Johannes Fischer, Dominik Köppl, Marvin Löbel, and Kunihiko Sadakane. Compression with the tudocomp framework. In *Proc. SEA*, volume 75 of *LIPICs*, pages 13:1–13:22, 2017.

- [12] Chen Fei Du, Hamoon Mousavi, Luke Schaeffer, and Jeffrey O. Shallit. Decision algorithms for fibonacci-automatic words, with applications to pattern avoidance. *CoRR*, abs/1406.0670, 2014. URL <http://arxiv.org/abs/1406.0670>.
- [13] Peter Elias. Efficient storage and retrieval by content and address of static files. *J. ACM*, 21(2):246–260, 1974.
- [14] Peter Elias. Universal codeword sets and representations of the integers. *IEEE Trans. Inf. Theory*, 21(2):194–203, 1975.
- [15] Martin Farach-Colton, Paolo Ferragina, and S. Muthukrishnan. On the sorting-complexity of suffix tree construction. *J. ACM*, 47(6):987–1011, 2000.
- [16] Paolo Ferragina and Giovanni Manzini. Opportunistic data structures with applications. In *Proc. FOCS*, pages 390–398, 2000.
- [17] Paolo Ferragina, Rodrigo González, Gonzalo Navarro, and Rossano Venturini. Compressed text indexes: From theory to practice. *ACM Journal of Experimental Algorithmics*, 13:1.12:1 – 1.12:31, 2008.
- [18] Johannes Fischer, Tomohiro I, and Dominik Köppl. Deterministic sparse suffix sorting in the restore model. *ACM Trans. Algorithms*, 16(4):50:1–50:53, 2020.
- [19] Travis Gagie, Pawel Gawrychowski, Juha Kärkkäinen, Yakov Nekrich, and Simon J. Puglisi. A faster grammar-based self-index. In *Proc. LATA*, volume 7183 of *LNCS*, pages 240–251, 2012.
- [20] Travis Gagie, Gonzalo Navarro, and Nicola Prezza. Optimal-time text indexing in BWT-runs bounded space. In *Proc. SODA*, pages 1459–1477, 2018.
- [21] Travis Gagie, Tomohiro I, Giovanni Manzini, Gonzalo Navarro, Hiroshi Sakamoto, and Yoshimasa Takabatake. Rpair: Rescaling RePair with Rsync. *CoRR*, abs/1906.00809, 2019.
- [22] Dan Gusfield. *Algorithms on Strings, Trees, and Sequences: Computer Science and Computational Biology*. Cambridge University Press, 1997.
- [23] Artur Jez. Approximation of grammar-based compression via recompression. *Theor. Comput. Sci.*, 592:115–134, 2015.
- [24] Dominik Kempa and Nicola Prezza. At the roots of dictionary compression: string attractors. In *Proc. STOC*, pages 827–840, 2018.
- [25] John C. Kieffer and En-Hui Yang. Grammar-based codes: A new class of universal lossless source codes. *IEEE Trans. Information Theory*, 46(3):737–754, 2000.
- [26] Donald E. Knuth, James H. Morris, and Vaughan R. Pratt. Fast pattern matching in strings. *SIAM J. Comput.*, 6(2):323–350, 1977.
- [27] N. Jesper Larsson and Alistair Moffat. Offline dictionary-based compression. In *Proc. DCC*, pages 296–305, 1999.
- [28] Udi Manber and Eugene W. Myers. Suffix arrays: A new method for on-line string searches. *SIAM J. Comput.*, 22(5):935–948, 1993.
- [29] Shirou Maruyama, Masaya Nakahara, Naoya Kishiue, and Hiroshi Sakamoto. ESP-index: A compressed index based on edit-sensitive parsing. *J. Discrete Algorithms*, 18:100–112, 2013.
- [30] Kurt Mehlhorn, R. Sundar, and Christian Uhrig. Maintaining dynamic sequences under equality tests in polylogarithmic time. *Algorithmica*, 17(2):183–198, 1997.

- [31] Takaaki Nishimoto, Tomohiro I, Shunsuke Inenaga, Hideo Bannai, and Masayuki Takeda. Dynamic index and LZ factorization in compressed space. *Discret. Appl. Math.*, 274:116–129, 2020.
- [32] Ge Nong, Sen Zhang, and Wai Hong Chan. Two efficient algorithms for linear time suffix array construction. *IEEE Trans. Computers*, 60(10):1471–1484, 2011.
- [33] Daniel S. N. Nunes, Felipe A. Louza, Simon Gog, Mauricio Ayala-Rincón, and Gonzalo Navarro. Grammar compression by induced suffix sorting, 2020.
- [34] Daniel Saad Nogueira Nunes, Felipe Alves da Louza, Simon Gog, Mauricio Ayala-Rincón, and Gonzalo Navarro. A grammar compression algorithm based on induced suffix sorting. In *Proc. DCC*, pages 42–51, 2018.
- [35] Daisuke Okanohara and Kunihiko Sadakane. Practical entropy-compressed rank/select dictionary. In *Proc. ALENEX*, 2007.
- [36] Süleyman Cenk Sahinalp and Uzi Vishkin. Efficient approximate and dynamic matching of patterns using a labeling paradigm (extended abstract). In *Proc. FOCS*, pages 320–328, 1996.
- [37] Yoshimasa Takabatake, Yasuo Tabei, and Hiroshi Sakamoto. Improved ESP-index: A practical self-index for highly repetitive texts. In *Proc. SEA*, volume 8504 of *LNCS*, pages 338–350, 2014.
- [38] Yoshimasa Takabatake, Kenta Nakashima, Tetsuji Kuboyama, Yasuo Tabei, and Hiroshi Sakamoto. siEDM: an efficient string index and search algorithm for edit distance with moves. *Algorithms*, 9(2):26:1–26:18, 2016.
- [39] Kazuya Tsuruta, Dominik Köppl, Yuto Nakashima, Shunsuke Inenaga, Hideo Bannai, and Masayuki Takeda. Grammar-compressed self-index with Lyndon words. *IPSJ TOM*, 13(2):84–92, 2020.
- [40] Jacob Ziv and Abraham Lempel. A universal algorithm for sequential data compression. *IEEE Trans. Information Theory*, 23(3):337–343, 1977.