

HYPERBOLIC BRUNNIAN LINKS

SHENG BAI

ABSTRACT. We present practical methods to show a Brunnian link is hyperbolic. The methods, belonging to geometric topology, are based on observation, worked by hand and generally applicable. Typical examples illustrate their efficiency. We thus determine hyperbolicity for all of the known Brunnian links in literatures except two series. Especially, we discover 6 infinite series of hyperbolic Brunnian links.

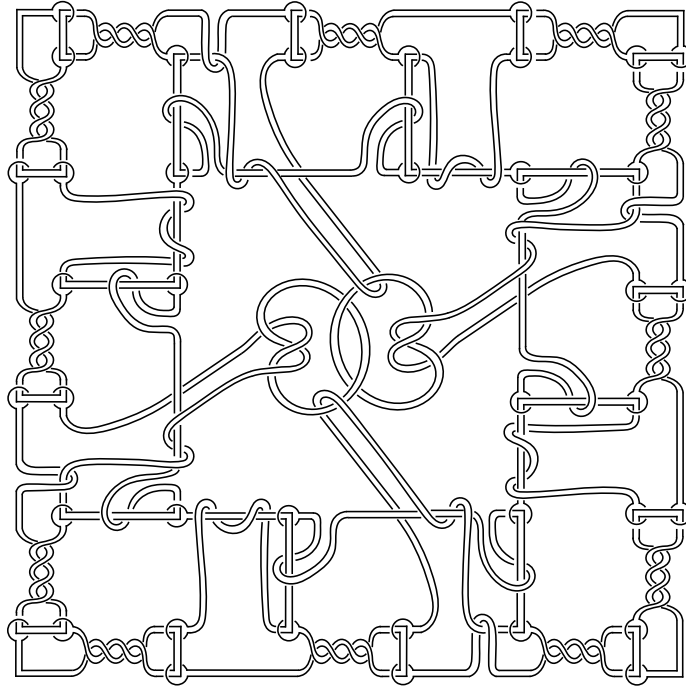

FIGURE 1. A hyperbolic Brunnian link: Cirrus in [5].

1. INTRODUCTION

Every minimal nontrivial sublink of a link is either a knot or a Brunnian link. [4] shows that hyperbolic Brunnian links and $(2, 2n)$ -torus links form building blocks

Date: 2021 Mar. 28.

Key words and phrases. Brunnian links, hyperbolic links, satellite links, essential torus.

of Brunnian links in that they generate all Brunnian links by satellite operations. In this paper, we give practical methods to show a Brunnian link is hyperbolic.

A classical theorem by Alexander states that every smooth torus bounds at least one solid torus in S^3 . We say a torus in S^3 is *knotted* if it bounds only one solid torus in S^3 ; otherwise, *unknotted*. In [4], A Brunnian link, other than Hopf link, is called *s-prime/untied* if there is no essential unknotted/knotted torus in its complement space. [4] further states that if a Brunnian link L is s-prime, untied and not a $(2, 2n)$ -torus link, then L is a hyperbolic link. So the two main tasks in this paper are to discriminate whether a Brunnian link is untied and s-prime.

Extending [5], we will cope with these two tasks using geometric topology methods. [5] provides two intuitive methods, generally effective and performed by handwork, for detecting Brunnian property of a link if each component is known to be unknot. In Section 4, we will prove a universal criterion to detect whether a Brunnian link is untied.

Theorem 1.1. (*Untiedness Criterion*)

Let $L = \cup_{i=1}^n C_i$ be an n -component Brunnian link and $k \in \{1, \dots, n\}$. For each $1 \leq i \leq k$, let D_i be a disk bounded by C_i so that $U = \cup_{i=1}^k D_i \cup L$ is a spanning complex. Suppose for every $1 \leq i \leq k$, D_i is (s7). Then L is untied if and only if there is no incompressible knotted torus in the complement of U .

To show that a Brunnian link is s-prime, instead of giving a criterion, we will first prove a universal intermediate theorem in Section 5, based on which we will provide four methods to show s-primeness in Section 6.

Theorem 1.2. (*Simple Intersection Pattern Theorem*)

Let $L = \cup_{i=1}^n C_i$ be an n -component Brunnian link. Let T be an essential torus in the complement of L , splitting S^3 into two solid tori V_I and V_J so that $L \cap V_I = L_I$ and $L \cap V_J = L_J$, where $L_I = \cup_{i \in I} C_i$ and $L_J = \cup_{j \in J} C_j$.

Suppose $Q \sqcup R \sqcup S \subset I$ and $J_0 \subset J$. Let $D_q^I (q \in Q)$, $D_j^J (j \in J_0)$, $D_r^E (r \in R)$ and $D_s^F (s \in S)$ be L_I -interior disks, L_J -interior disks, exterior cross disks, and free cross disks respectively, so that the cross disks are mutually disjoint and each disk is stable. If the union of these disks and L forms a spanning complex, then after an isotopy of T , every disk intersects T in simple intersection pattern.

We will define (s7), stable and spanning complex in Section 3, and L_I -interior disks, L_J -interior disks, exterior cross disks, free cross disks and simple intersection pattern in Subsection 5.1. In fact, the two corresponding theorems in the text will be stronger than the two presented here, but the conditions will be more complicated. We will illustrate our methods by typical examples.

Then we are interested in how many Brunnian links in history, which, to our best knowledge, all appear in [6, 8, 20, 1, 3, 2, 15, 12, 10, 18, 16, 5], are hyperbolic. Our methods work to detect s-primeness for all of them and untiedness for all except Fountains and Jade-pendants in [5]. Especially, we list some infinite series of Brunnian links:

- (1) $\text{Lamp}(n_1, n_2, \dots, n_{2k})$, where $k \in \mathbb{N}_+$ and each index is an odd integer indicating the number of half twists as shown in Fig. 2.
- (2) $\text{deBrunner}(n)$, where $n \leq 5$, as shown in Fig. 3. (c.f. [20])
- (3) $W(n)$, where $n > 1$, as shown in Fig. 4. (c.f. [20])
- (4) $\text{Torus}(m, n)$, where $m, n \in \mathbb{N}_+$, as shown in Fig. 5. (c.f. [2, 3])

- (5) Tube(m, n), where $m > 0, n > 1$, as shown in Fig. 6.[2, 3, 5]
- (6) Carpet(m, n, p), where $m, n, p \in \mathbb{N}_+$ and $m < n$, as shown in Fig. 7.[2, 3, 5]

Theorem 1.3. *The six series of links above are hyperbolic.*

Our methods are worked by hand. An alternative to showing a link is hyperbolic is to use SnapPy. However, a program cannot show hyperbolicity for infinite series of links. By the theorem of W. Menasco[17], it can be verified that every alternating Brunnian link is hyperbolic. Nevertheless, these newly discovered series are not alternating at least seen from the diagrams, and our methods provide alternative proofs for hyperbolicity of alternating Brunnian links in literatures.

In the last section, we will generalize our criteria and framework to wider classes of links.

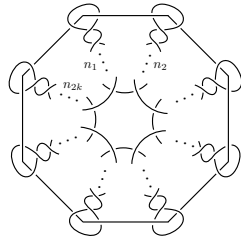

FIGURE 2. Lamp(n_1, n_2, \dots, n_{2k})

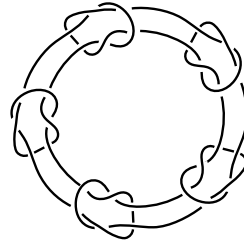

FIGURE 3. deBrunner(5).

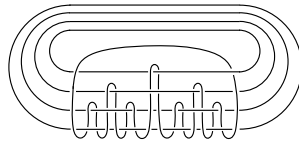

FIGURE 4. W(5), constructed by H. Brunn in [6].

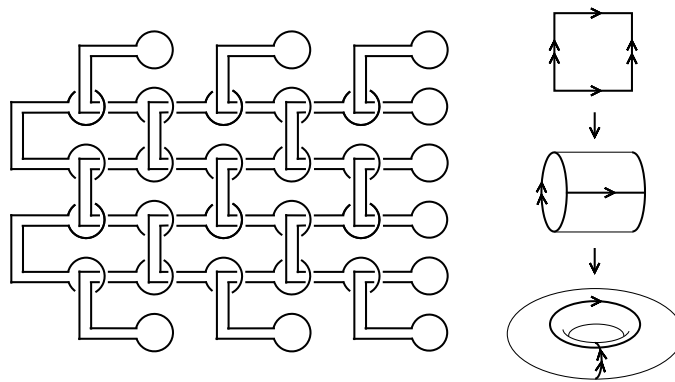

FIGURE 5. Torus(m, n) has $2m$ rows and each row has n components.

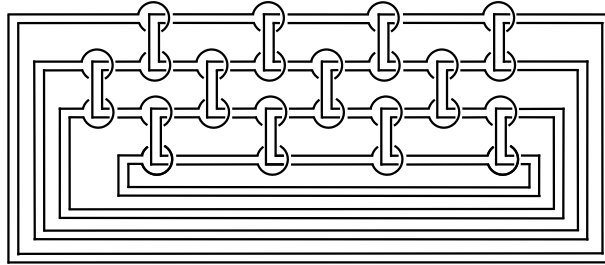

FIGURE 6. Tube(3,4), a tube with 3 rows and 4 columns.

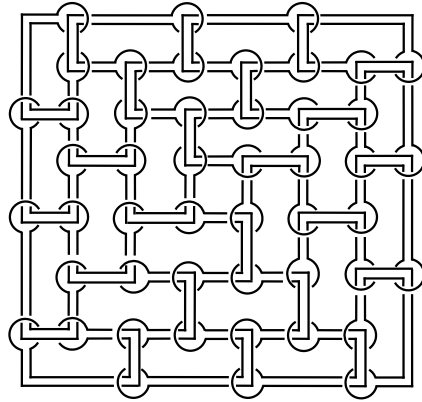

FIGURE 7. Carpet(1,3,4), see [5] for notations.

Acknowledgement: We are grateful to Weibiao Wang who drew most of the figures in this paper and verified Fig. 1 is hyperbolic.

CONTENTS

1. Introduction	1
2. Preliminaries	5
3. Credible disks and stable disks	5
3.1. Credible disks	6
3.2. Stable disks	6
3.3. Spanning complex	10
4. Criterion for Untiedness	10
4.1. Decision Theorem and Example analysis	10
4.2. Proof of Theorem 4.1	11
5. Simple intersection pattern Theorem	14
5.1. Simple intersection pattern	14
5.2. Proof of the main Theorem	15
6. Criteria for S-primeness	20
6.1. Analysis on plausible annuli	21
6.2. Components discarded	22

6.3. Interior disks only	25
6.4. Cross disk with the least intersection points	26
7. Conclusions	28
References	30
8. Appendix: An alternating example	31

2. PRELIMINARIES

In this paper, all objects and maps are smooth. Without special explanation, we always consider links in S^3 . All intersections are compact and transverse. Each arc is assumed to be simple. The notations C, L, D (maybe with subscripts) are always used to denote an unknot, a link and an embedded disk respectively. We use $N(\cdot)$ to denote a regular neighborhood.

For a compact set K in a solid torus, K is *geometrically essential* in it if any meridian disk intersects K . If V is a regular neighborhood of a knot K in S^3 , the *longitude* of V is the essential curve in ∂V that is null-homologous in $S^3 - \text{int}V$, oriented similarly to K ; the *meridian* is the essential curve in ∂V bounding a disk in V and having link number $+1$ with K . (c.f. [7])

Definition 2.1. [4] Let L and L' be links in S^3 , and $C \subset L$ and $C' \subset L'$ be oriented unknotted components. A homeomorphism $h : S^3 - \text{int}N(C') \rightarrow N(C)$ maps the oriented meridian of $N(C')$ to the oriented longitude of $N(C)$ and maps the oriented longitude of $N(C')$ to the oriented meridian of $N(C)$, where $N(C)$ is the regular neighborhood of C . Then the link $(L - C) \sqcup h(L' - C')$ is the *s-sum* of $L(C)$ and $L'(C')$.

Definition 2.2. [4] Let $L_0 \sqcup L^n$ be a link in S^3 where $L^n = \sqcup_{i=1}^n C^i$ is an oriented unlink, and $k_i, i = 1, \dots, n$, be nontrivial knot types. Let $h : U_n = S^3 - \text{int}N(L^n) \rightarrow S^3$ be an orientation-preserving embedding so that

$$S^3 - h(U_n) \cong \sqcup_{i=1}^n (S^3 - N(k_i)),$$

where $h(\partial N(C^i))$ corresponds to $\partial N(k_i)$, and the oriented meridian of $N(C^i)$ maps to the oriented null-homologous curve in $S^3 - h(U_n)$ corresponding to the oriented longitude of $N(k_i)$. Then $L = h(L_0)$ is an *s-tie*.

For Brunnian links, we have

Theorem 2.3. [4] *If a torus T in S^3 splits a Brunnian link L , then T is incompressible, and L is decomposed by T as an s-sum of two Brunnian links.*

Theorem 2.4. [4] *Every knotted essential torus in the complement of a Brunnian link bounds the whole link in the solid torus side.*

3. CREDIBLE DISKS AND STABLE DISKS

In this section, we introduce our main tools and some notions for links with some unknotted components, and confirm these tools are always available.

3.1. Credible disks. Our basic tool is credible disk.

Definition 3.1. Let C_i be a component of a link L and D_i be a disk bounded by C_i . D_i is *credible* if there is no circle C in the interior of D_i such that

- (i) the disk in D_i bounded by C intersects L ;
- (ii) there is a disk D_C bounded by C with $D_C \subset S^3 - L$.

To simplify the task of showing a disk is credible, we give a definition used for the proposition following it.

Definition 3.2. Let $L = \cup_{i=1}^n C_i$ be an n -component link and $I \subset \{1, \dots, n\}$. Take disjoint disks $D_i (i \in I)$ bounded by $C_i (i \in I)$ and set $U = \cup_{i \in I} D_i \cup L$. A circle C in the interior of D_i is *incredible* for U if

- (i) the disk in D_i bounded by C intersects L ;
- (ii) there is a disk D_C bounded by C with $\text{int}D_C \subset S^3 - U$.

Proposition 3.3. Let $L = \cup_{i=1}^n C_i$ be an n -component link and $I \subset \{1, \dots, n\}$. Take disjoint disks $D_i (i \in I)$ bounded by $C_i (i \in I)$ and set $U = \cup_{i \in I} D_i \cup L$. Then D_i is *credible* for each $i \in I$ if and only if there is no *incredible* circle for U .

Proof. Since the “only if” implication is obvious, we need only proof the “if” implication. Suppose for an $i \in I$, there is a circle $C \subset \text{int}D_i$ such that the disk in D_i bounded by C intersects L and there is a disk D_C bounded by C with $D_C \subset S^3 - L$. We wish to find an *incredible* circle for U .

After a perturbation near C , we may assume $D_C \cap \cup_{i \in I} D_i$ is a disjoint union of circles. Choose an innermost circle in D_C , which bounds a disk, say D_0 , in it. Suppose $C_0 = \partial D_0$ is in D_j for some $j \in I$. If C_0 encloses some intersection points with L in D_j , then C_0 is an *incredible* circle for U . Otherwise, D_0 caps a 3-ball with D_j . Replacing D_0 in D_C by the disk in D_j bounded by C_0 , a little beyond, we eliminate C_0 . Step by step, we find an *incredible* circle for U . \square

Noting that the complement of U is smaller than the component of L , this proposition reduces the task of showing a disk is credible in application. In fact, the main content of [5] is to show disks are credible, which proposes two widely applicable methods, including several criteria and a general procedure.

3.2. Stable disks. Sometimes we will use a special kind of credible disks, called stable disks. Let C_i be a component of a link L and D_i be a disk bounded by C_i . Let L_0 consist of the components of L which intersects the interior of D_i , and L_J be a sublink of $L - C_i$ containing L_0 .

Definition 3.4. The disk D_i is *stable* for L_J if $\sharp(D_i \cap L_J)$ is minimal among all disks bounded by C_i whose interior only intersect L_J , and D_i is *stable* if it is stable for L_0 .

Clearly a stable disk is credible and the converse is not true in general. To reduce the task of showing a disk is stable, we introduce the following definition.

Definition 3.5. A circle C in the interior of D_i is *unstable* for L_J if C bounds a disk D_{C1} such that

- (i) $D_{C1} \cap L = D_{C1} \cap L_J$;
- (ii) $\sharp(D_{C1} \cap L) < \sharp(D_{C0} \cap L)$, where D_{C0} is the disk in D_i bounded by C .

Obviously that D_i is stable for L_J implies that there is no unstable circle for L_J . The following lemma shows the converse is also true.

Lemma 3.6. *There is no unstable circle for L_J in D_i if and only if D_i is stable for L_J .*

Proof. Suppose there is no unstable circle for L_J on D_i . Assume for contradiction that D'_i is a disk bounded by C_i , having less number of intersection points with L_J than D_i . After perturbation, D'_i intersects D_i transversely in their interiors. Choose an innermost circle in D'_i . Using the same argument as in the proof of Lemma 3.8(2), we get a contradiction. \square

The task of showing a disk is stable can be further reduced by considering mutually disjoint disks. Let $L = \cup_{i=1}^n C_i$ be an n -component link and $I \subset \{1, \dots, n\}$. Take disjoint disks $D_i (i \in I)$ bounded by $C_i (i \in I)$.

Definition 3.7. For any $k \in I$, a circle C in the interior of D_k is *unstable avoiding* $\cup_{i \in I} D_i$ if C bounds a disk D_{C1} such that

- (i) $D_{C1} \cap \cup_{i \in I} D_i = C$;
- (ii) $\sharp(D_{C1} \cap L) < \sharp(D_{C0} \cap L)$, where D_{C0} is the disk in D_k bounded by C .

Lemma 3.8. (1) *Fix $k \in I$. Then there is no unstable circle in D_k avoiding $\cup_{i \in I} D_i$ if and only if there is no disk D bounded by C_k such that*

- (i) $D \cap \cup_{i \in I} D_i = C_k$, and
- (ii) $\sharp(D \cap (L - C_k)) < \sharp(D_k \cap (L - C_k))$.

(2) *For any $k \in I$ there is no unstable circle in D_k avoiding $\cup_{i \in I} D_i$ if and only if for any $k \in I$ there is no unstable circle in D_k for $L - \cup_{i \in I} C_i$.*

Proof. (1). The “only if” implication is trivial. For the “if” implication, suppose there is an unstable circle C bounding D_{C0} in D_k and D_{C1} as in Definition 3.7. Then the disk $(D_k - D_{C0}) \cup D_{C1}$ has less intersection points with $L - C_k$, and after perturbation, its interior is disjoint from D_k .

(2). Since the “if” implication is obvious, we need only proof the “only if” implication. Set $L_J = L - \cup_{i \in I} C_i$. Suppose there is a circle C in the interior of some D_k , bounding D_{C0} in D_k and bounding D_{C1} as in Definition 3.5. Then $D_{C1} \cap \cup_{i \in I} D_i$ is disjoint union of circles. Let C_0 be an innermost circle in D_{C1} , which bounds a disk D_0 in it and bounds a disk D_{j0} in some D_j . Since D_j is stable avoiding $\cup_{i \in I} D_i$, D_{j0} has no more number of intersection points with L_J than D_0 . Take the immersed disk $(D_{C1} - D_0) \cup D_{j0}$ and push the D_{j0} in it a little downward D_j to eliminate C_0 . We denote the obtained immersed disk by E_{C2} .

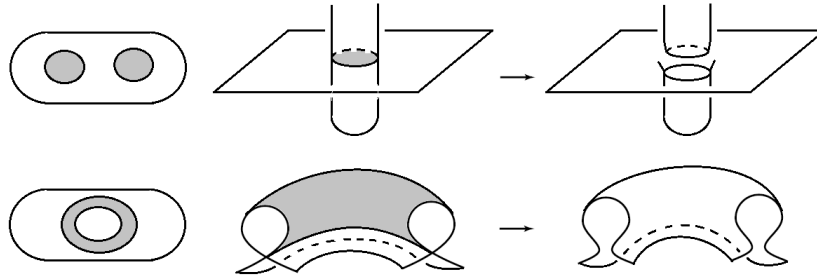

FIGURE 8. Two kinds of surgeries to eliminate double curves.

Generally E_{C_2} may not be embedded since C_0 may not be innermost in D_j . Nevertheless, its singularities consists of only double points, forming disjoint circles. This is an easy case of Dehn's Lemma([21, 9]), so we can revise it to get an embedding disk. For each self-intersection circle, change the immersion map either on two disks or in an annulus region, as illustrated in Figure 8, and then smooth the corners. We will get an embedding disk D_{C_2} having the same intersection points with L_J as E_{C_2} .

Step by step we eventually get a disk D_{C_N} , which intersects $\cup_{i \in I} D_i$ in C and has no more number of intersection points with L_J than D_{C_1} . Then D_{C_N} has less number of intersection points with L_J than D_{C_0} . Thus C is unstable avoiding $\cup_{i \in I} D_i$, a contradiction. \square

In summary, the following proposition simplifies significantly the task of showing a disk is stable.

Proposition 3.9. *Let $L = \cup_{i=1}^n C_i$ be an n -component link and $I \subset \{1, \dots, n\}$. Let $D_i (i \in I)$ be disjoint disks bounded by $C_i (i \in I)$. Then every $D_i (i \in I)$ is stable for $L - \cup_{i \in I} C_i$ if and only if for any $i \in I$ there is no disk D bounded by C_i such that*

- (i) $D \cap \cup_{k \in I} D_k = C_i$;
- (ii) $\sharp(D \cap (L - C_i)) < \sharp(D_i \cap (L - C_i))$.

Proof. This follows immediately from the previous two lemmas. \square

Applying this proposition, we present how to prove a disk is stable by two examples.

Example 3.10. Consider the Milnor link in Fig. 9(1). The components C_1, C_2, C_3 bound mutually disjoint oriented disks D_1, D_2, D_3 as Fig. 9(2), and the component C_0 is homotopically nontrivial in $S^3 - \cup_{i=1}^3 C_i$, whose fundamental group is freely generated by g_1, g_2, g_3 as Fig. 9(2). To obtain the representation of a loop in $\pi_1(S^3 - \cup_{i=1}^3 C_i)$, just record the intersections of the loop and the disks in order with orientations. Notice that C_0 intersects D_1 and D_2 both in 4 points, and intersects D_3 in two points. With the base point $P \in C_0$, we see C_0 represents $[[g_1, g_2], g_3]$ in $\pi_1(S^3 - \cup_{i=1}^3 C_i)$. We show D_1, D_2, D_3 are all stable.

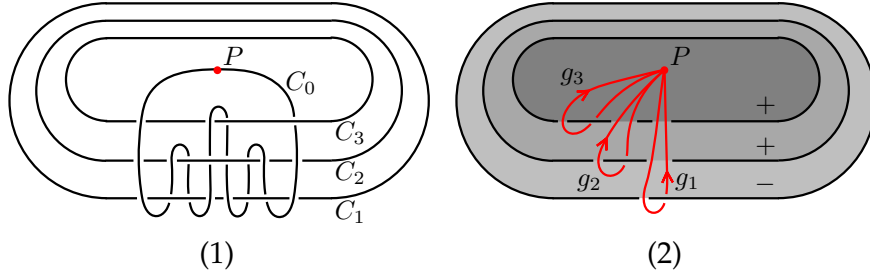

FIGURE 9. Stable disks for Milnor link.

Proof. Since $[[g_1, g_2], g_3]$ is a reduced word, unique when generators of the free group are fixed, any isotopy of $D_1 \cup D_2 \cup D_3$ cannot give less intersection points with C_0 for each disk. To show D_1 is stable, it suffices to show there is no disk bounded by C_1 , whose interior disjoint from $D_1 \cup D_2 \cup D_3$, has less intersection

points with C_0 than C_1 . Suppose such a disk D'_1 exists, then $S_1 = D_1 \cup D'_1$ is a sphere separating D_2 and D_3 . There are two cases.

CASE 1: The positive side of D_1 and C_2 belong to one side of S_1 . Consider the element C_0 represents in $\pi_1(S^3 - \cup_{i=1}^3 C_i)$, that is $g_1 g_2 g_1^{-1} g_2^{-1} g_3 g_2 g_1 g_2^{-1} g_1^{-1} g_3^{-1}$. We can assume the base point P is in the negative side of S_1 and find an arc from P representing $g_1 g_2 g_1^{-1}$, which avoids D'_1 . Then the fourth letter g_2^{-1} means we have to go to the positive side of S_1 to have an arc representing g_2^{-1} . But the third letter g_1^{-1} means the arc representing the fourth letter g_2^{-1} avoids D_1 , so it must intersect D'_1 . In other words, between the third letter and the fourth letter, C_0 intersects D'_1 . In the same way, between the fourth letter g_2^{-1} and the fifth letter g_3 , between the fifth letter g_3 and the sixth letter g_2 , and between the sixth letter g_2 and the seventh letter g_1 , our loop intersects D'_1 .

In short, in the representation $g_1 g_2 g_1^{-1} g_2^{-1} g_3 g_2 g_1 g_2^{-1} g_1^{-1} g_3^{-1}$, replacing g_2 and g_2^{-1} by 2, g_3 and g_3^{-1} by 3, g_1 by $1^- 1^+$, and g_1^{-1} by $1^+ 1^-$, we get a cyclic sequence

$$1^- 1^+ 2 1^+ 1^- \mid 2 \mid 3 \mid 2 \mid 1^- 1^+ 2 1^+ 1^- 3.$$

Since $1^+, 2$ belong to one side, and $1^-, 3$ belong to the other side, the number of how many adjacent pairs in this cyclic sequence cross through S_1 gives the minimum number of $D'_1 \cap C_0$, which is 4.

CASE 2: The positive side of D_1 and C_3 belong to one side of S_1 . Make replacement in the representation $g_1 g_2 g_1^{-1} g_2^{-1} g_3 g_2 g_1 g_2^{-1} g_1^{-1} g_3^{-1}$ as before. Now $1^+, 3$ belong to one side, and $1^-, 2$ belong to the other side. The number of adjacent pairs in this cyclic sequence cross through S_1 is 8, as

$$1^- 1^+ \mid 2 \mid 1^+ 1^- 2 \mid 3 \mid 2 1^- 1^+ \mid 2 \mid 1^+ 1^- \mid 3 \mid.$$

The same method applies to D_2, D_3 . □

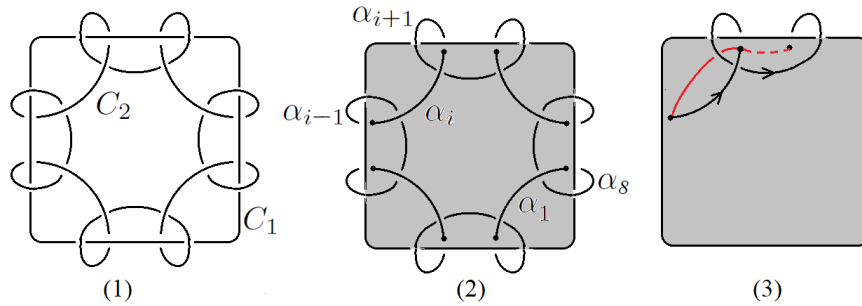

FIGURE 10. Lamp(1,1,1,1,1,1,1,1).

Example 3.11. Consider the link in Fig. 10(1). We show the grey disk D , bounded by C_1 in Fig. 10(2) is stable. Let D' be a disk bounded by C_1 whose interior avoids D . It suffices to show $\sharp(D' \cap C_2) \geq \sharp(D \cap C_2)$. The disk D cuts C_2 into 8 arcs $\alpha_1, \alpha_2, \dots, \alpha_8$, successively indexed along C_2 as shown in Fig. 10(2). Notice that each α_i can only intersect D' in even number of points, since the two endpoints of each α_i are on the same side of D . The result will be proved by showing that for any odd i , either $\sharp(D' \cap \alpha_i) \geq 2$ or $\sharp(D' \cap \alpha_{i\pm 1}) \geq 2$.

In fact, we can say $lk(\alpha_i, \alpha_{i\pm 1}) = 1$ in the sense that connecting the endpoints of α_i by an arc on the positive side of D and connecting the endpoints of $\alpha_{i\pm 1}$ by an arc on the negative side of D gives two curves with linking number equal to 1. See Fig. 10(3). If D' intersects neither α_i nor $\alpha_{i\pm 1}$, it would cap off α_i from $\alpha_{i\pm 1}$ and thus $lk(\alpha_i, \alpha_{i\pm 1}) = 0$, a contradiction.

3.3. Spanning complex. We now introduce our main tool in this paper.

Definition 3.12. Let $L = \cup_{i=1}^n C_i$ be an n -component link. Fix $I \subset \{1, \dots, n\}$ and for any $i \in I$, let D_i be a credible disk bounded by C_i . The union $U = \cup_{i \in I} D_i \cup L$ is a *spanning complex* for L if the following regularity conditions hold:

- (Ri) U has only generic singularities of double or triple points.
- (Rii) (No trivial intersection circle.) $\forall i, j \in I$, there is no circle component C of $D_i \cap D_j$ such that the disk bounded by C in D_i does not intersect L .
- (Riii) (No trivial annulus region.) $\forall i, j \in I$, there is no pair of circle components of $D_i \cap D_j$ such that they bound annuli in both D_i and D_j and neither annulus intersects L .

We point out that, given the credible disks $D_i (i \in I)$, one can always modify $\cup_{i \in I} D_i \cup L$ to meet the above regularity conditions. In fact, general differential topology guarantees condition (Ri). For condition (Rii), since D_j is also credible, if such C exists, then the disk bounded in D_j by C also does not intersect L . Suppose C bounds D_{C_i} and D_{C_j} in D_i and D_j respectively. Interchanging D_{C_i} by D_{C_j} and then smoothing the corners near C , we can eliminate C . The trouble is that the new D_i and D_j may have self-intersection. Notice that the singularities can only be double points. By changing the immersion map and smoothing the corners, as in the second paragraph of the proof of Lemma 3.8(2), we get embedded ones. For condition (Riii), if such pair of intersection circles exists, say $C_{01} \cup C_{02}$, which bounds A_i in D_i and bounds A_j in D_j . Interchanging A_j and A_i and then smoothing the corners, we can eliminate $C_1 \cup C_2$. The new D_i and D_j may have self-intersection, but we can get embedded new D_i and D_j from them as above.

We conclude this section with a definition used in the statements of our theorems.

Definition 3.13. Let C_i be a component of a link L and D_i be a credible disk bounded by C_i . For a natural number N , we say D_i is (sN) if either

- (i) $\sharp(D_i \cap (L - C_i)) < N$; or
- (ii) D_i is stable.

4. CRITERION FOR UNTIEDNESS

In this section we give a sufficient and necessary criterion to detect untiedness for Brunnian links and illustrate our method by examples.

4.1. Decision Theorem and Example analysis.

Theorem 4.1. (*Untiedness Criterion*)

Let $L = \cup_{i=1}^n C_i$ be an n -component Brunnian link and $k \in \{1, \dots, n\}$. For each $i \leq k$, let D_i be a disk bounded by C_i so that $U = \bigcup_{i=1}^k D_i \cup L$ is a spanning complex. Suppose for every $i \leq k$,

$$\begin{cases} D_i \text{ is } (s7), & \text{if } n = 2 \text{ and } lk(C_1, C_2) = 1; \\ D_i \text{ is } (s8), & \text{in other cases.} \end{cases}$$

Then L is untied if and only if there is no incompressible knotted torus in the complement of U .

The proof of this theorem will be given at the end of this section.

Recall that a spanning complex is always available. The “if” implication of this theorem gives a method to show a Brunnian link is untied. The “only if” implication indicates this method is theoretically universal. Furthermore, if a Brunnian link is an s-tie, we can always find a companion torus by choosing a spanning complex U satisfying the condition in Theorem 4.1, since an incompressible knotted torus in $S^3 - U$ is a desired companion.

Let us illustrate our method with an example.

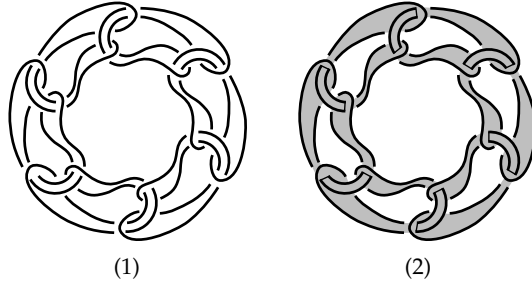

FIGURE 11. Brunn’s chain.

Example 4.2. Consider Brunn’s chain in Fig. 11(1). Take the disks as shown in Fig. 11(2), which are all credible as demonstrated in [5]. The union of these disks forms a spanning complex, say U . Since $S^3 - \text{int}N(U)$ is a handlebody, where $N(U)$ is a regular neighborhood of U , by Theorem 4.1, Brunn’s chains are untied.

From this example, we can see that this method is intuitive and efficient. It works conveniently to show all the Brunnian links in literatures, except Fountains and Jade-pendant in [5], are untied.

4.2. Proof of Theorem 4.1.

The “if” implication:

Suppose that L is an s-tie. Let T be an essential torus in $S^3 - L$, bounding a solid torus V in S^3 containing L . We may assume T is an *outermost* essential torus. More formally, there is no essential torus T_0 in $S^3 - L$ so that

- (0i) T_0 bounds a solid torus containing V ,
- (0ii) T_0 is not parallel to T .

The intersection $\cup_{i=1}^k D_i \cap T$ is a union of circles, forming a graph in T . We wish to make D_i into V one by one by an isotopy of T . First consider D_1 . We do this in three steps.

Step 1. Eliminate inessential circles in T .

Let C be a circle component of $D_1 \cap T$, bounding a disk D_{CT} in T and a disk D_{C1} in D_1 . Since D_1 is credible, D_{C1} does not intersect L . Thus we have the following two observations:

- (i) Any circle component of $D_1 \cap T$ contained in D_{C1} is inessential in T . This is because T is essential.

- (ii) For any $i > 1$, there is no circle component of $D_1 \cap D_i$ contained in D_{C_1} . This is by regularity condition (Rii).

By (i), we may assume C is innermost in D_1 as a circle component of $D_1 \cap T$. Then $D_{C_1} \cup D_{CT}$ bounds a 3-ball, say B . Pushing D_{CT} across B a little beyond D_{C_1} , we eliminate C . Do it inductively. After finitely many steps, $D_1 \cap T$ contains no inessential circles in T .

To guarantee the validity of making $D_i (i > 1)$ into V later, we will need the following two more observations:

- (iii) The singularities of U contained in D_{C_1} consists of proper arcs. This follows from that D_{C_1} does not intersect L and (ii).
- (iv) For any $i > 1$, $D_i \cap B$ is a proper surface, and each boundary component of it is either contained in D_{CT} or is an alternating sequence of properly embedded arcs in D_{CT} and in D_{C_1} . This follows from (iii).

See Fig. 12 for an example.

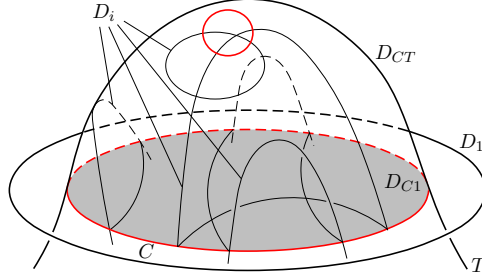

FIGURE 12. The red circles in D_{CT} are intersections with D_1 . The black graph is intersection with $D_i (i > 1)$.

Step 2. Eliminate exterior annulus regions in D_1 .

Consider a component of $D_1 \cap T$ innermost in D_1 . Since it bounds a disk in D_1 , it must be the meridian of V . Thus $D_1 \cap T$ is a union of meridians of V , cutting D_1 into regions alternatively in $\text{int}V$ and in $S^3 - V$. We call a component of $D_1 - T$ in $\text{int}V$ an *interior region* in D_1 , and call a component of $D_1 - T$ in $S^3 - V$ an *exterior region* in D_1 . Clearly every exterior region does not intersect L .

We claim that if annulus A is an exterior region in D_1 , then A is ∂ -parallel to T . In fact, if otherwise, then ∂A would cut T into two annuli A_1 and A_2 such that both $A \cup A_1$ and $A \cup A_2$ bound knot complements in $S^3 - \text{int}V$. This implies that the core of V is a connected sum of two knots, contradicting that T is outermost.

So we can isotope T to make A into V . Step by step, we can eliminate all the exterior annulus regions in D_1 .

Step 3. Verify $D_1 \subset V$.

Consider D_1 cut by $D_1 \cap T$. We have the following three observations on the regions in D_1 :

- (v) The outermost region and all of the innermost regions are interior, in view of $C_1 \subset V$ and that every intersection circle is a meridian of V .
- (vi) If the outermost region is an annulus, it must intersect $L - C_1$. In fact, if not, C_1 would be parallel to a meridian of T . However, by Brunnian property, $L - C_1$ is trivial in V . Then L would also be trivial in V , a contradiction.

- (vii) For any exterior region Ω , $\partial\Omega$ should be one outer circle enclosing odd number (≥ 3) of inner circles in D_1 , and the disk bounded by each inner circle intersects L in at least 2 points. In fact, since $\partial\Omega$ is null-homologous in $S^3 - \text{int}V$, $\partial\Omega$ has even number of components, and by Step 2, it can not have only 2 components.

We now show by cases that $D_1 \subset V$.

CASE 1: D_1 is stable. Suppose D_1 has exterior regions. Then the components of $D_1 \cap T$ can not be all innermost in D_1 . By (v), each innermost region in D_1 is a meridian disk of V . There exist such a disk region, say D_{u1} , and a component of $D_1 \cap T$ adjacent to ∂D_{u1} in T , say $C_{u+1,1}$, such that

- (1i) $\#(D_{u1} \cap L)$ is minimal among all the innermost regions,
- (1ii) $C_{u+1,1}$ is either not innermost in D_1 , or innermost but not achieving minimal intersection points with L .

Let A_T be the annulus in T between $C_{u+1,1}$ and ∂D_{u1} . Then by (vii), the disk $D_{u1} \cup A_T$ has less intersection points with L than the disk in D_1 bounded by $C_{u+1,1}$. So $C_{u+1,1}$ is an unstable circle on D_1 , a contradiction.

CASE 2: $\#(D_1 \cap L) < 7$, if $n = 2$ and $lk(C_1, C_2) = 1$; $\#(D_1 \cap L) < 8$, in other cases. Suppose D_1 has exterior regions. By (vi) and (vii), D_1 intersects $L - C_1$ in more than 6 points. If the outermost region intersects another component, say C_2 , in only one point, then $lk(C_1, C_2) = 1$ and $n = 2$. As shown in Fig 13(1), we have $\#(D_1 \cap L) \geq 7$. Otherwise, $\#(D_1 \cap L) \geq 8$, as shown in Fig. 13(2). So under this condition, $D_1 \subset V$.

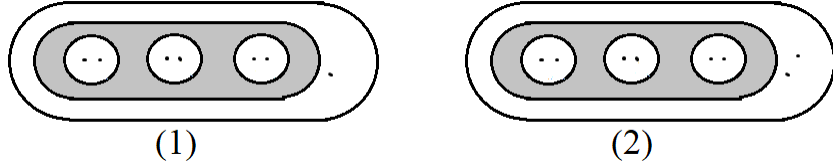

FIGURE 13.

Now we follow the three steps above to make D_2 into V by an isotopy of T . The key point is that this isotopy of T will keep $D_1 \cap T = \emptyset$.

Consider $D_2 \cap T$. For Step 1, by the same token, choose a circle C innermost in D_2 , which bounds a disk D_{CT} in T and a disk D_{C2} in D_2 , and then push D_{CT} across the 3-ball cobounded with D_{C2} to eliminate C . We have two similar observations for D_2 as clauses (iii) and (iv) for D_1 . Notice that D_{CT} and D_1 do not intersect. Thus D_{C2} also does not intersect D_1 . Therefore the isotopy of D_{CT} , replacing D_{CT} by D_{C2} , keeps $D_1 \cap T = \emptyset$. So we can eliminate all the inessential circles in T in finitely many steps. For Step 2, we can eliminate exterior annulus regions in D_2 just as before because D_1 is already contained in V . For Step 3, the same argument as demonstrated before shows that $D_2 \subset V$.

Performing the same procedure for D_i for i from 2 to k , we have $U \subset V$. Since T is incompressible in $S^3 - L$, clearly T is incompressible in $S^3 - U$.

The “only if” implication:

Suppose T is an incompressible torus in the complement of U . Let V be the solid torus bounded by T containing U . We proof by negation that L is an s-tie. If L is untied, then T is compressible in the complement of L and thus there is

a meridian disk D of V not intersecting L . Notice that any meridian disk of V intersects U . It follows that for any $i \in I$, $D \cap D_i$ is a disjoint union of circles. The intersection $\bigcup_{i \in I} D_i \cap D$ forms a graph.

Let C be a component of $D_1 \cap D$ innermost in D_1 , bounding D_{C1} in D_1 and bounding D_C in D . Since D_1 is credible, D_{C1} does not intersect L . By (Rii), the singularities of U contained in D_{C1} consists of proper arcs. Replacing D_C in D by D_{C1} and pushing it a little beyond D_{C1} , we get a new disk D with less intersection components with D_1 . After finitely many steps, D is disjoint from D_1 .

A careful examination shows that the same procedure for D_2 keeps $D_1 \cap D = \emptyset$. Step by step for each D_i , we eventually get a meridian disk of V not intersecting U , a contradiction.

5. SIMPLE INTERSECTION PATTERN THEOREM

To show a Brunnian link is s-prime is to prove no essential torus splits it into two sublinks. We divide our strategy in two steps. In this section, as the first step, we give a general intermediate result, stating that a spanning complex satisfying certain conditions can intersect a splitting torus in a simple form. In the next section, as the second step, we give criteria to negate the existence of such torus.

5.1. Simple intersection pattern. We first define several disks with respect to a partition of a link.

Definition 5.1. Let $L = \cup_{i=1}^n C_i$ be an n -component link. Let $L_I = \cup_{i \in I} C_i$ and $L_J = \cup_{j \in J} C_j$ be proper sublinks of L with $I \sqcup J = \{1, \dots, n\}$. For any $i \in I$ and $j \in J$, the credible disks defined as follows are called L_I -interior disk, L_J -interior disk, exterior cross disk and free cross disk respectively, denoted D_i^I , D_j^J , D_i^E and D_i^F respectively.

- D_i^I : bounded by C_i such that $D_i^I \cap L_J = \emptyset$;
- D_j^J : bounded by C_j such that $D_j^J \cap L_I = \emptyset$;
- D_i^E : bounded by C_i such that $D_i^E \cap (L_i - C_i) = \emptyset$ and $D_i^E \cap L_J \neq \emptyset$;
- D_i^F : bounded by C_i such that $D_i^F \cap (L_i - C_i) \neq \emptyset$ and $D_i^F \cap L_J \neq \emptyset$.

L_I -interior disk and L_J -interior disk are *interior disks*, and exterior cross disk and free cross disk are *cross disks*.

Consider a torus T splitting L as L_I and L_J and the intersection of T and the disks defined above.

Definition 5.2. An interior disk intersects T in *simple intersection pattern* if it does not intersect T , and a cross disk intersects T in *simple intersection pattern* if each intersection circle is innermost in the disk and is a meridian of V_J .

Remark 5.3. Let β_I and β_J be the core of V_I and V_J respectively. Consider a cross disk D_i intersecting T in simple intersection pattern.

(1) Recall that cross disks are credible. It is easy to see that each inner disk in it is a credible disk for $\beta_I \cup L_J$, and the outer region in it corresponds to a credible disk for $L_I \cup \beta_J$.

(2) If D_i is stable, consider $\beta_I \cup L_J$. It can be verified that each inner disk in D_i is a stable disk bounded by β_I , and thus all the inner disks have the same number of intersection points with L_J .

Now we turn to Brunnian links.

Proposition 5.4. *Let $L = \cup_{i=1}^n C_i$ be an n -component Brunnian link. Let $L_I = \cup_{i \in I} C_i$ and $L_J = \cup_{j \in J} C_j$ be proper sublinks of L with $I \sqcup J = \{1, \dots, n\}$.*

- (1) *For any exterior cross disk D_i^E , we have $\sharp(D_i^E \cap (L - C_i)) \geq 4$.*
- (2) *For any free cross disk D_i^F , we have $\sharp(D_i^F \cap (L - C_i)) \geq 6$.*

Remark 5.5. If $\sharp(D_i^E \cap (L - C_i)) = 4$, then D_i^E is stable for L_J .

The proofs of this proposition and the following main theorem will be given at the end of this section.

Theorem 5.6. *(Simple Intersection Pattern Theorem)*

Let $L = \cup_{i=1}^n C_i$ be an n -component Brunnian link. Let T be an essential torus in the complement of L , splitting S^3 into two solid tori V_I and V_J so that $L \cap V_I = L_I$ and $L \cap V_J = L_J$, where $L_I = \cup_{i \in I} C_i$ and $L_J = \cup_{j \in J} C_j$. Suppose $Q \sqcup R \sqcup S \subset I$ and $J_0 \subset J$. Let $D_q^I (q \in Q)$, $D_j^J (j \in J_0)$, $D_r^E (r \in R)$ and $D_s^F (s \in S)$ be L_I -interior disks, L_J -interior disks, exterior cross disks, and free cross disks respectively, so that the cross disks are mutually disjoint and

$$\left\{ \begin{array}{ll} D_q^I \text{ is (s8),} & \forall q \in Q; \\ D_j^J \text{ is (s8),} & \forall j \in J_0; \\ D_r^E \text{ is (s10),} & \forall r \in R; \\ D_s^F \text{ is stable, or contains a longitude of } V_I \text{ with } \sharp(D_s^F \cap (L - C_s)) < 8, & \forall s \in S. \end{array} \right.$$

If the union of these disks and L forms a spanning complex, then after an isotopy of T , every disk intersects T in simple intersection pattern.

Remark 5.7. We explain the conditions in this theorem in more detail.

(1) The cross disks $D_r^E (r \in R)$, $D_s^F (s \in S)$ are required to be mutually disjoint. As will be seen in the proof, $\cup_{q \in Q} D_q^I$ and $\cup_{j \in J_0} D_j^J$ are actually disjoint.

(2) In (iv), the condition “ D_s^F contains a longitude of V_I ” seems not natural. But actually once $R \neq \emptyset$, D_s^F has to contain a longitude of V_I , since the cross disks are mutually disjoint.

5.2. Proof of the main Theorem. We first present a simple lemma on s-sum decomposition of Brunnian links.

Lemma 5.8. [4] *Let T be an essential torus in the complement of a Brunnian link L , splitting L into proper sublinks $L_1 \subset V_1$ and $L_2 \subset V_2$, where V_i is a solid torus bounded by T , for $i = 1, 2$.*

- (1) *Any meridian disk in V_i intersects L_i with at least 2 points, for $i = 1, 2$;*
- (2) *If a component of L_1 bounds a disk whose intersection with T contains a meridian of V_2 , then the intersection contains at least two meridians of V_2 .*

Proof of Theorem 5.6. Let U denote the spanning complex formed by L and all the credible disks. Then $U \cap T$ is a union of circles, forming a graph in T . We will isotope T to make the L_I -interior disks, the L_J -interior disks and the cross disks into simple intersection pattern in turn. So we divide our proof in three steps.

Step 1. Make L_I -interior disks into V_I one by one by an isotopy of T .

We shall adopt the same procedure as in the proof of Theorem 4.1. Consider a disk D_q^I . We make it into V_I in three steps.

Step 1.1. Eliminate inessential circles in T .

Let C be a circle component of $D_q^I \cap T$, bounding a disk D_{CT} in T and a disk D_{Cq} in D_q^I . Using the same argument as in the proof of Theorem 4.1, we may assume

C is innermost in D_{Cq} . Then $D_{Cq} \cup D_{CT}$ bounds a 3-ball. Since no sphere splits a Brunnian link, this 3-ball does not intersect L . So we can eliminate C by an isotopy of T as demonstrated before. Do it inductively. After finitely many steps, $D_q^I \cap T$ contains no inessential circle in T .

Step 1.2. Eliminate annulus regions in V_J .

Now $D_q^I \cap T$ is a disjoint union of circles. Consider a circle component innermost in D_q^I . Since the disk in D_q^I bounded by this circle does not intersect L_J , it is the meridian disk of V_I . Thus all the components of $D_q^I \cap T$ are meridian of V_I .

The intersection $D_q^I \cap T$ cuts D_q^I into regions alternatively in V_I and in V_J . Let A be an annulus region contained in V_J . Since the boundary components of A are longitude of V_J , it follows that A must cut V_J into two solid tori. Notice that the core of each solid tori and the core of V_I form a Hopf link, which is Brunnian. By Theorem 2.3, one of the two solid tori does not intersect L_J . Isotope T across this solid torus to make A into V_I . Step by step, we can eliminate all the annulus regions in V_J .

Step 1.3. Verify $D_q^I \subset V_I$.

For either the case that D_q^I is stable or the case $\#(D_q^I \cap L_J) < 8$, an argument similar to the one used in Step 3 in the proof of Theorem 4.1 shows that $D_q^I \subset V_I$.

Next we isotope T to make another L_I -interior disk D_q^I into V_I by the same token. We now check that the isotopy of T keeps $D_q^I \cap T = \emptyset$. For Step 1.1, similarly as in the proof of Theorem 4.1, this is due to the regularity condition (Rii) and that D_q^I does not intersect any disk in T . For Step 1.2, it is guaranteed by that D_q^I is already contained in V_I .

Performing the same procedure for L_I -interior disks one by one, we have that $\cup_{q \in Q} D_q^I \subset V_I$.

Step 2. Make L_J -interior disks into V_J one by one by an isotopy of T .

With $\cup_{q \in Q} D_q^I$ already contained in V_I , we proceed as in Step 1 to make L_J -interior disks into V_J . Consider a disk D_j^J . We only need to check that in the similar three steps, the isotopy of T keeps $D_q^I \cap T = \emptyset$ for all $q \in Q$.

Step 2.1. Eliminate inessential circles in T .

In this step, the disk D_{Cj} contained in D_j^J , corresponding to D_{Cq} in Step 1.1, does not intersect any L_I -interior disk by (Rii). Thus the 3-ball it caps with T does not intersect any L_I -interior disk.

Step 2.2. Eliminate annulus regions in V_I .

In such a case, $D_j^J \cap L_I = \emptyset$ implies that $D_j^J \cap T$ can only be disjoint union of meridians of V_J . The intersection circles cut D_j^J into regions alternatively in V_I and in V_J . Let A be an annulus region contained in V_I . An argument similar to the one used in Step 1.2 shows that A caps a solid torus with T , say V_A , which does not intersect L_I .

We claim that $A \cap D_q^I = \emptyset$, and thus $V_A \cap D_q^I = \emptyset$, for all $q \in Q$. In fact, by (Rii), there is no component of $D_q^I \cap A$ inessential in A for any $q \in Q$. Suppose C_A is a component of $D_q^I \cap A$ essential in A for a $q \in Q$. Since C_A is a core of V_I , the disk in D_q^I bounded by C_A must intersect L_J , a contradiction.

An isotopy of T across V_A makes A into V_J .

Step 2.3. Verify $D_j^J \subset V_J$.

This step is a judgement, where everything is fixed.

Perform the same procedure for other L_J -interior disks one by one. We can verify that T keeps avoiding $\cup_{q \in Q} D_q^I$ and the L_J -interior disks already contained in V_J by the same arguments as in Step 1 and Step 2 respectively. Now we have $\cup_{j \in J_0} D_j^J \subset V_J$.

Step 3. Make the cross disks into simple intersection pattern.

Recall that all of the cross disks are mutually disjoint, so it is convenient to consider them together. We proceed as in the proof of Theorem 4.1.

Step 3.1. Eliminate inessential circles in T .

The intersection of the cross disks and T consists of mutually disjoint circles. Let D_i be one of the exterior or free cross disks. Let C be a circle component of $D_i \cap T$, bounding a disk D_{CT} in T and a disk D_{C_i} in D_i . Using the same argument as in Step 1 in the proof of Theorem 4.1, we may assume C is innermost in D_{C_i} . Then $D_{C_i} \cup D_{CT}$ bounds a 3-ball. As demonstrated in Step 1.1, this 3-ball does not intersect L , and thus we can eliminate C by an isotopy of T .

Step by step for all cross disks, we eliminate all inessential intersection circles in T .

Step 3.2. Eliminate annulus regions ∂ -parallel to T .

It is easy to see that each component of $(\cup_{r \in R} D_r^E \cup \cup_{s \in S} D_s^F) \cap T$ is either the longitude of V_I or the meridian of V_I . Let D_i be one of the exterior or free cross disks. The intersection $D_i \cap T$ cuts D_i into planar regions alternatively in V_I and in V_J . In this step, we eliminate all the proper annulus regions ∂ -parallel to T without intersecting L . Strictly speaking, let A be a proper annulus region contained in V_I which caps a solid torus with T , say V_A , such that $V_A \cap L = \emptyset$. We claim that $A \cap D_q^I = \emptyset$, and thus $V_A \cap D_q^I = \emptyset$, for any $q \in Q$. Then an isotopy of T across V_A makes A into V_J .

We now prove the claim. By (Rii), there is no component of $D_q^I \cap A$ inessential in A for any $q \in Q$. Suppose C_A is a component of $D_q^I \cap A$ essential in A for a $q \in Q$. Let P be a component of $D_q^I \cap V_A$ one of whose boundary components is C_A . Clearly the boundary components of P are all parallel in A . By (Riii), P is not an annulus. Then P is compressible in V_A . Let D_{P_1} be a compression disk for P in V_A . Since D_q^I is credible, the disk in D_q^I bounded by ∂D_{P_1} , denoted D_{P_0} , does not intersect L . Without loss of generality, we may reselect C_A so that it is contained in D_{P_0} . However, since C_A is essential in A , it is parallel to either the longitude or the meridian of V_I . In either case, any disk bounded by C_A intersects L , a contradiction.

We can eliminate such annulus regions contained in V_J in a similar manner.

Step 3.3. Verify simple intersection pattern.

Consider all of the cross disks cut by T . For both exterior and free cross disks, the following claim investigates the remaining annulus regions. To make length short, we arrange the proof of this claim after the end of the proof of the theorem.

Claim: After Step 3.2,

- (Ai) any proper annulus region in V_I intersects L_I , and intersects any component of L_I in even number of points;
- (Aii) any annulus region in V_J intersects L_J , and intersects any component of L_J in even number of points.

In the remainder of the proof, we discuss exterior cross disks and free cross disks separately.

Exterior cross disks. For any $r \in R$, the intersection $D_r^E \cap T$ cuts D_r^E into regions alternatively in V_I and V_J . Since D_r^E is an exterior cross disk, the intersection circles are longitudes of V_I . We have the following observations on the regions in D_r^E .

- (Ei) Each innermost region is a meridian disk of V_J . In view of linking number, each innermost disk intersects any components of L_J in even number of points unless L_J has only one component.
- (Eii) The outermost region is contained in V_I . It is not an annulus by Lemma 5.8. Its boundary consists of C_s and even number of intersection circles unless $L_I = C_r$, in view of linking number.
- (Eiii) No region in V_I intersects $L - C_r$. For each region Ω in V_I , except the outermost one, $\partial\Omega$ is one outer circle enclosing odd number (≥ 3) of inner circles in D_r^E . In fact, since $\partial\Omega$ is null-homologic in V_I , such a region has even number (> 2) of boundary components.

Now we show by cases that D_r^E is of simple intersection pattern.

CASE 1: D_r^E is stable. Let D_{ur} be an innermost region in D_r^E so that $\sharp(D_{ur} \cap L_J)$ is minimal among all the innermost regions in D_r^E . Let $C_{u+1,r}$ be a component of $D_r^E \cap T$ adjacent to ∂D_{ur} in T , and A_T be the annulus in T between ∂D_{ur} and $C_{u+1,r}$. Then the disk $D_{ur} \cup A_T$ has the same intersection points with L as D_{ur} . Since D_r^E is stable, the disk bounded in D_r^E by $C_{u+1,r}$ must be innermost and have the same number of intersection points as D_{ur} . It follows that all the intersection circles are innermost in D_r^E .

CASE 2: $\sharp(D_r^E \cap (L - C_r)) < 10$. Suppose there is an intersection circle in D_r^E which is not innermost. By (Aii), (Ei), (Eii) and (Eiii), D_r^E intersects $L - C_r$ in at least 10 points, as shown in Fig. 14.

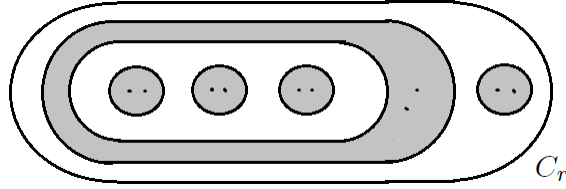

FIGURE 14. White regions are in V_I , and gray regions are in V_J .

Free cross disks. For any $s \in F$, the intersection $D_s^F \cap T$ cuts D_s^F into regions alternatively in V_I and V_J . The intersection circles can be either longitudes of V_I or meridians of V_I . We discuss the two possibilities separately.

First suppose that the circles are longitude of V_I . We have the following observations on the regions in D_s^F .

- (Fi) Each innermost region is a meridian disk of V_J , and it intersects any components of L_J in even number of points unless L_J has only one component.
- (Fii) The outermost region is contained in V_I . It is not an annulus by Lemma 5.8. Its boundary consists of C_s and even number of intersection circles.
- (Fiii) For each region Ω in V_I , except the outermost one, $\partial\Omega$ is one outer circle enclosing odd number of inner circles in D_s^F .

Now suppose that the intersection circles are meridian of V_I . We have the following observations on the regions in D_s^F .

- (F'i) The outermost region and all of the innermost regions are contained in V_I . Each innermost region is a meridian disk of V_I .
- (F'ii) If the outermost region is an annulus, it intersects $L_I - C_s$, and thus it intersects any component of $L_I - C_s$ in even number of points, in view of linking number. In fact, if not, C_s would be parallel to a meridian of V_I . By Brunnian property, $L_I - C_s$ is trivial in V_I . This would implies L_I is trivial in V_I , a contradiction.
- (F'iii) For any region Ω in V_J , $\partial\Omega$ is one outer circle enclosing odd number of inner circles in D_s^F , and each disk in D_s^F bounded by one of such inner circle intersects L_I .

We now show by cases that D_s^F is of simple intersection pattern.

CASE 1: D_s^F is stable. Suppose that the intersection circles are meridian of V_I . By (F'i), the components of $D_s^F \cap T$ can not be all innermost in D_s^F . Notice that each innermost region is a meridian disk of V_I . There exist an innermost region in D_s^F , say D_{us} , and a component of $D_1 \cap T$ adjacent to ∂D_{us} in T , say $C_{u+1,s}$, such that

- (1i) $\sharp(D_{us} \cap L_I)$ is minimal among all the innermost regions,
- (1ii) $C_{u+1,s}$ is either not innermost in D_s^F , or innermost but not achieving minimal intersection points with L_I .

Let A_T be the annulus in T between $C_{u+1,s}$ and ∂D_{us} . Then by (F'iii) and (Aii), the disk $D_{us} \cup A_T$ has less intersection points with L than the disk in D_s^F bounded by $C_{u+1,s}$. This implies that $C_{u+1,s}$ is an unstable circle on D_s^F , a contradiction.

Hence $D_s^F \cap T$ consists of longitudes of V_I . The remainder of the argument is analogous to that in Case 1 for exterior cross disks and is left to the reader.

CASE 2: $\sharp(D_s^F \cap (L - C_s)) < 8$ and D_s^F contains a longitude of V_I . All of the intersection circles are longitude of V_I . Suppose there is a circle in D_s^F which is not innermost. By Lemma 5.8(1), every meridian disk of V_J intersects L_J in at least 2 points. Then by (Fi), (Fii), (Fiii), (Ai) and (Aii), D_s^F intersects $L - C_s$ in at least 8 points, as shown in Fig. 15.

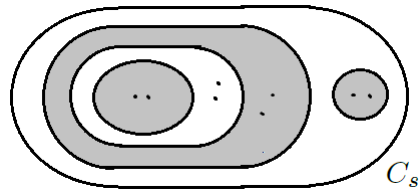

FIGURE 15. White regions are in V_I , and gray regions are in V_J .

□

Proof of the claim. We only prove (Ai), and (Aii) follows in a similar manner by interchanging V_I and V_J in the proof below.

Let A be a proper annulus region in V_I . Assume for contrary that $A \cap L_I = \emptyset$. First suppose that all the intersection circles are longitude of V_I . Then A must cut V_I into two solid tori. Since the core of each solid tori and the core of V_J form a Hopf link, by Theorem 2.3, one of the two solid tori does not intersect L_I . However, we have eliminated such A in Step 3.2, a contradiction.

Now suppose that all the intersection circles are meridian of V_I . If A is ∂ -parallel in V_I , then it cuts off a compression solid torus V_A in V_I . If V_A contains some components of L_I , by Proposition 3.2.1 in [4], the proper sublink in the closure of $V_I - V_A$ would not be geometrically essential. A compression disk in this solid torus, after isotopy, would be a meridian disk in V_I . However, again by Proposition 3.2.1 in [4], L_I is geometrically essential in V_I , a contradiction. So V_A does not intersect L . Recall that we have eliminated such A in Step 3.2. Hence A cannot be ∂ -parallel in V_I . Then ∂A cuts T into two annuli such that A and one of the annuli cobound a knotted solid torus V_{AI} in V_I . By Theorem 2.4, the sublink in V_{AI} is not geometrically essential. A compression disk in V_{AI} , after isotopy, would be a meridian disk in V_I , again a contradiction.

We have shown that A intersects L_I . Since A separates V_I , it intersects any component of L_I in even number of points. \square

Proof of Proposition 5.4. Let T be an essential torus in the complement of L , splitting S^3 into two solid tori V_I and V_J so that $L \cap V_I = L_I$ and $L \cap V_J = L_J$.

(1) Applying Theorem 5.6, we may assume D_i^E intersects T in simple intersection pattern. By Lemma 5.8, any meridian disk of V_I has more than one intersection points, and the outermost region has more than two boundary components. So if $\sharp(D_i^E \cap (L - C_i)) \leq 4$, the only possibility is as shown in Fig. 16(1).

(2) First suppose all the intersection circles in D_i^F are longitude of V_I . Applying Theorem 5.6, we may assume D_i^F is of simple intersection pattern. By Lemma 5.8(1) and (Fii) in the proof of Theorem 5.6, there are at least two inner disks each intersecting L_J in at least 2 points. In view of linking number, the outer region intersects $L_I - C_i$ in even number of points. So D_i^F with least number of intersection is as shown in Fig. 16(2).

Now suppose that all the intersection circles in D_i^F are meridian of V_I . By Lemma 5.8(1), and (Aii) and (Fii) in the proof of Theorem 5.6, if $\sharp(D_i^F \cap (L - C_i)) \leq 6$, the intersections in D_i^F can only be as shown in Fig. 16(3).

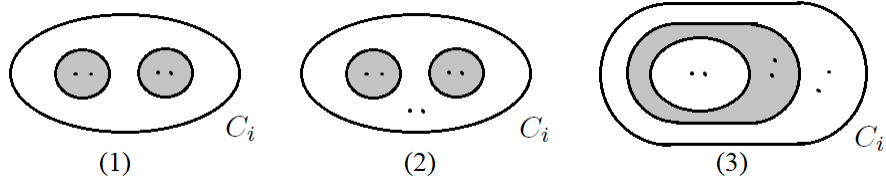

FIGURE 16. White regions are in V_I , and gray regions are in V_J .

\square

6. CRITERIA FOR S-PRIMENESS

Based on the theorem in the previous section, we present four methods to prove a Brunnian link is s-prime and illustrate them by typical examples. In this section, we call the following paragraph *Standard premise*:

Let $L = \cup_{i=1}^n C_i$ be an n -component Brunnian link. Let T be an essential torus in the complement of L , splitting S^3 into two solid tori V_I and V_J , such that $L \cap V_I = L_I = \cup_{j \in J} C_j$ and $L \cap V_J = L_J = \cup_{j \in J} C_j$. Suppose $Q \sqcup R \sqcup S \subset I$ and $J_0 \subset J$. Let

$D_q^I (q \in Q)$, $D_j^J (j \in J_0)$, $D_r^E (r \in R)$ and $D_s^F (s \in S)$ be L_J -interior disks, L_J -interior disks, exterior cross disks, and free cross disks respectively, such that

- the cross disks are mutually disjoint;
- the union of these disks and L forms a spanning complex U ;
- every disk intersects T in simple intersection pattern.

6.1. Analysis on plausible annuli. To show a hypothetical torus cannot exist, we may estimate the shape of the torus. We thus introduce some notations.

Under Standard premise, the components of the intersection of T and the cross disks are *plausible circles*, denoted $\tilde{C}_1, \tilde{C}_2, \dots, \tilde{C}_t$, successively indexed along T . For any $k = 1, 2, \dots, t$, the annulus in T between \tilde{C}_k and \tilde{C}_{k+1} is a *plausible annulus*, denoted \tilde{A}_k ; the disk bounded by \tilde{C}_k in a cross disk is a *plausible disk*, denoted \tilde{D}_k ; the connected component of $V_J - (\cup_{r \in R} D_r^E \cup_{s \in S} D_s^F)$ containing \tilde{A}_k is a *plausible cylinder*, denoted \tilde{B}_k .

Proposition 6.1. *Under Standard premise, let α be an arc component of $L_J - \cup_{r \in R} D_r^E \cup_{s \in S} D_s^F$.*

- (1) α connects two consecutive plausible disks on the corresponding sides of cross disks unless two endpoints of α are on one side of a cross disk.
- (2) If α connects two plausible disks \tilde{D}_k and \tilde{D}_{k+1} in one cross disk D_i , and α is unknotted, i. e. forming unknot with an arc connecting $\partial\alpha$ in D_i , then α is the core of \tilde{B}_k .

Here, a *core* of a plausible cylinder is a trivial arc in the plausible cylinder connecting its two bases.

Proof. Since (1) is obvious, we need only prove (2). There are two cases depending on whether \tilde{D}_k and \tilde{D}_{k+1} are on the same side of D_i . First suppose they are on the same side of D_i . Let β_α be an arc in D_i connecting $\partial\alpha$ so that β_α intersects both \tilde{C}_k and \tilde{C}_{k+1} in exactly one point. Let D_α be a disk bounded by $\alpha \cup \beta_\alpha$. Consider D_α and D_i . A standard innermost circle/outermost arc argument shows that we may assume $D_\alpha \cap D_i = \beta_\alpha$. Then consider D_α and \tilde{A}_k . By the choice of β_α , $D_\alpha \cap \tilde{A}_k$ consists of an arc connecting \tilde{C}_k and \tilde{C}_{k+1} and some trivial circles in \tilde{A}_k . We can eliminate all the circle components by a standard innermost circle argument. Notice that the remained arc component is parallel to the core of \tilde{B}_k . Thus α is the core of \tilde{B}_k . See Fig. 17(1).

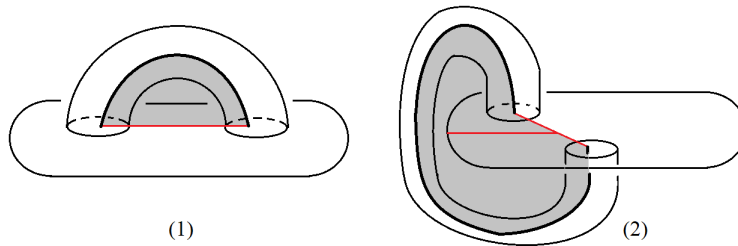

FIGURE 17. The arc α is the core of \tilde{B}_k .

Now suppose two plausible disks are on different sides of D_i . The proof is almost identical, the major change being the substitution of β_α into a shape “T” graph for $D_\alpha \cap D_i$. See Fig. 17(2). \square

Example 6.2. Recall the link in Fig. 10(1). Using the notations in Example 3.11, we prove it is s-prime. Suppose there is an essential torus T splitting the link. Take the stable exterior cross disk D_1 bounded by C_1 as shown in Fig. 10(2). Since $lk(C_1, C_2) = 0$ and C_1 and C_2 are symmetric, we may assume $lk(C_1, \beta_J) = 0$. Thus there is a plausible cylinder, say \tilde{B}_k , whose bases are on the same side of D_1 . Without loss of generality, assume its bases are on the positive side of D_1 . Clearly, \tilde{B}_k intersects C_2 in some odd labeled arcs.

Let α_i be a component of $\tilde{B}_k \cap C_2$. We claim α_i is the core of \tilde{B}_k . In fact, if not, $\partial\alpha_i$ would be in one plausible disk, say \tilde{D}_k . Then once delete all the other odd labeled arcs, $\tilde{A}_k \cup \tilde{D}_{k+1}$ would be a disk capping α_i with D_1 . This implies $lk(\alpha_i, \alpha_{i+1}) = 0$, a contradiction.

Hence all the components of $\tilde{B}_k \cap C_2$ are core of \tilde{B}_k . By Lemma 5.8(1), $\tilde{B}_k \cap C_2$ has more than one component. Consider two of the components. Then they are parallel to each other in \tilde{B}_k . Thus for any even labeled arc α_j , this two arcs have the same linking number with α_j . This is impossible as we know $lk(\alpha_i, \alpha_{i\pm 1}) = 1$ and otherwise the linking number is 0.

6.2. Components discarded. This method is powerful for large links.

Proposition 6.3. *Under Standard premise with $R \cup S \neq \emptyset$, if delete some connected components of U contained in V_I , there is no connected component of U contained in V_J split out by a sphere.*

Proof. By Theorem 2.3, the link $L_J \cup \beta_I$ is Brunnian. Thus no sphere splits $L_J \cup \beta_I$. By construction of U , no sphere splits $\beta_I \cup (U \cap V_J)$. Notice that a cross disk in simple intersection pattern contains a longitude of V_I , which is parallel to β_I . It follows from the construction of U that in the complex U with some connected components in V_I discarded, no connected component in V_J can be split out by a sphere. \square

This proposition provides a method to rule out essential torus splitting L_I and L_J , as the hypothetical torus T cannot exist if discarding some components of U in V_I makes some component of U in V_J split out.

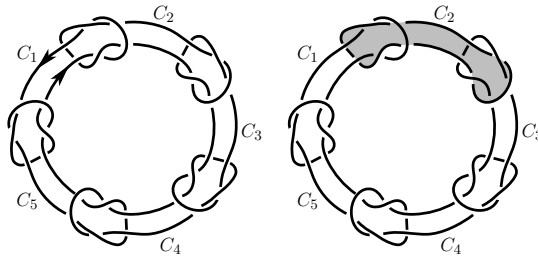

FIGURE 18. deBrunner(5).

Example 6.4. deBrunner(5) is s-prime. Denote the link in Fig 18 by L . In view of the symmetry of L , it suffices to show there is no essential torus splitting C_1 and

C_2 . Assume for contrary that T is a such torus. Take a cross disk D_2 bounded by C_2 as shown in Fig 18. Depending on whether T splits C_2 and C_3 , the following discussion is complete.

- (i) V_I contains only C_2 ;
- (ii) V_I contains exactly $C_2 \cup C_3$;
- (iii) V_I contains more than $C_2 \cup C_3$ and V_J contains more than C_1 ;
- (iv) V_J contains only C_1 ;
- (v) V_J contains exactly $C_1 \cup C_3$;
- (vi) V_J contains more than $C_1 \cup C_3$ and V_I contains more than C_2 .

None above is possible. The main point of our argument is that in $L \cup D_2$, after deleting a connected component other than $C_1 \cup D_2 \cup C_3$, then all the other components split out.

For (ii) and (iv), they are impossible by Proposition 5.4(2). Clause (i) is equivalent to (iv) by the symmetry of L , thus also impossible. For (iii) and (iv), they are impossible by Proposition 6.3. In fact, in $L \cup D$, once delete a circle component in V_I , each circle component in V_J splits out. Finally, (v) is contained in (iii) after a rotation of L .

Proposition 6.2.1 in [4], the uniqueness of s-sum decomposition for Brunnian links, can simplify the task of showing s-primeness. Specifically, as any two tori splitting L are disjoint after isotopy, if a torus T splits L into L_I and L_J and a torus T' splits L into $L_{I'}$ and $L_{J'}$, then one of $L_I \cap L_{I'}$, $L_I \cap L_{J'}$, $L_J \cap L_{I'}$ and $L_J \cap L_{J'}$ is empty.

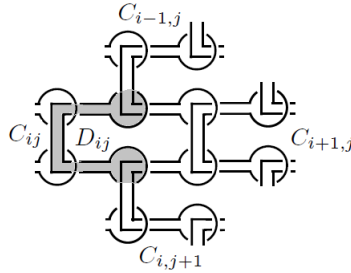

FIGURE 19. Torus(m, n) is s-prime.

Example 6.5. For any $m > 1, n > 2$, Torus(m, n) is s-prime. Up to symmetry, there is only one kind of component, as C_{ij} in Fig 19. It suffices to show that no essential torus splits any one of C_{ij} , $C_{i-1,j}$ and $C_{i+1,j}$ from the other two. Take the cross disk D_{ij} . By Proposition 5.4(2), no essential torus splits $C_{i+1,j}$ and $C_{ij} \cup C_{i-1,j}$ or splits $C_{i-1,j}$ and $C_{ij} \cup C_{i+1,j}$.

Suppose there is an essential torus T splitting C_{ij} and $C_{i-1,j} \cup C_{i+1,j}$. In $L \cup D_{ij}$, once delete a circle component other than $C_{i+1,j}$, all other circle components split out. Thus by Proposition 6.3, T either splits $C_{i-1,j} \cup C_{i+1,j}$ from all the other components, or splits $C_{ij} \cup C_{i+1,j}$ from all the other components. For the first case, by the symmetry of L , there would be a torus splits $C_{i-3,j} \cup C_{i-1,j}$ from all the other components. by Proposition 6.2.1 in [4], this is impossible. Similarly, the second case is impossible.

Definition 6.6. Let C be a component of a Brunnian link L . If there is an essential torus in $S^3 - L$ splitting C and $L - C$, then C is *multiple*; otherwise, *simple*.

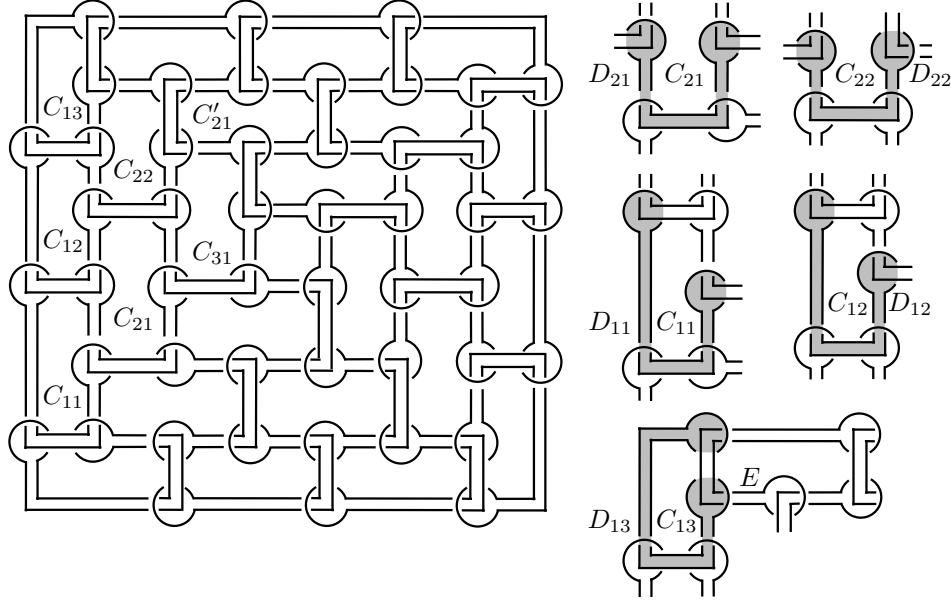

FIGURE 20. Carpet(1,3,4) is s-prime.

Example 6.7. Carpet(1,3,4) is s-prime. Denote this link by L . Up to symmetry, there are 6 kinds of components. We will take cross disks in Fig. 20 one by one to show L is s-prime.

On account of the symmetry of this link, the following discussion is complete.

- (i) No essential torus splits one of C_{11} , C_{12} and C_{21} from the other two;
- (ii) No essential torus splits one of C_{12} , C_{13} and C_{22} from the other two;
- (iii) No essential torus splits C_{31} and $C_{12} \cup C_{21}$;
- (iv) No essential torus splits C'_{21} and $C_{13} \cup C_{22}$;
- (v) Every component is simple.

For (iii), take cross disk D_{21} and use Proposition 5.4(2). For (i), take cross disk D_{11} . By Proposition 5.4(2), any essential torus neither splits C_{12} and $C_{11} \cup C_{21}$, nor splits C_{21} and $C_{11} \cup C_{12}$. Suppose there is an essential torus T splitting C_{11} and $C_{12} \cup C_{21}$. In $L \cup D_{11}$, once delete a circle component, all other circle components split out. By Proposition 6.3, either C_{11} is multiple or T splits $C_{12} \cup C_{21}$ from all the other components. By (iii), it only remains to show C_{11} is simple.

For (iv), take cross disk D_{22} and use Proposition 5.4(2). For (ii), take cross disk D_{12} . By Proposition 5.4(2), any essential torus neither splits C_{13} and $C_{12} \cup C_{22}$, nor splits C_{22} and $C_{12} \cup C_{13}$. As demonstrated before, by Proposition 6.3, it remains to show C_{12} is simple, which is proved in (i).

For (v), we have shown that C_{12} , C_{21} are simple when proving (i), C_{13} and C_{22} are simple when proving (ii), and C_{31} is simple by (iii). For the remained case that C_{11} is simple, take cross disk D_{13} intersecting C_{11} in 4 points. This is Case (1.0.0)

in Lemma 6.10(1). Delete the ear E . Then using the approach in Example 5.3 in [5], we can show the asserted incredible circle in Proposition 6.11(1) does not exist.

6.3. Interior disks only. If there is no cross disk, we can give a sufficient and necessary criterion to detect s-primeness, parallel to Theorem 4.1.

Theorem 6.8. *Let $L = \cup_{i=1}^n C_i$ be an n -component Brunnian link. Let I and J be disjoint nonempty subset of $\{1, \dots, n\}$, and let $D_i^I (i \in I)$ and $D_j^J (j \in J)$ be L_I -interior disks and L_J -interior disks respectively. Suppose each interior disk is (s8) and*

$$\begin{aligned} U_I &= L_I \cup_{i \in I} D_i^I \\ U_J &= L_J \cup_{j \in J} D_j^J \end{aligned}$$

are disjoint spanning complex. Then there is no essential torus in the complement of L splitting L_I and L_J if and only if any torus splitting U_I and U_J , if exists, is ∂ -parallel to a component of L .

Proof. We first prove the “if” implication. Suppose that T is an essential torus in the complement of L splitting L_I and L_J . Then by Theorem 5.6, $(U_I \cup U_J) \cap T = \emptyset$. Clearly T is incompressible in the complement of $U_I \cup U_J$. Thus by the condition, T is ∂ -parallel to a component of L , contradicting that T is essential in the complement of L .

Now we prove the “only if” implication. Suppose that T is torus in the complement of $U_I \cup U_J$ splitting U_I and U_J and not ∂ -parallel to any component of L . Then T splits L_I and L_J . By Theorem 2.3, T is incompressible in the complement of L . This completes the proof. \square

For Brunnian links with at least 3 components, the “if” implication of this theorem gives a method to prove s-primeness, while the “only if” implication indicates this method is theoretically universal. However, this method does not work for 2-component links, and will become complicated when the number of components is large.

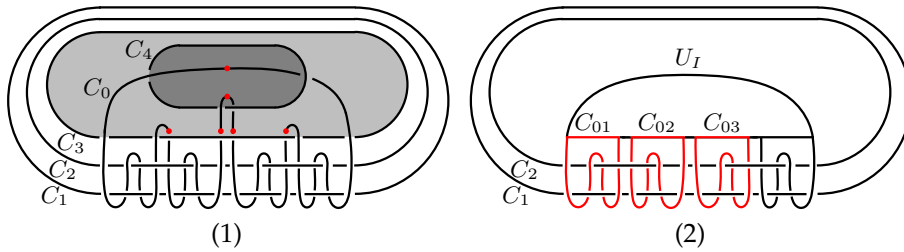

FIGURE 21. $W(5)$.

Example 6.9. For the link $W(5)$ in Fig. 21(1), we show no torus splits $C_1 \cup C_2$ and $C_0 \cup C_3 \cup C_4$. Take interior disks D_3^I and D_4^I as shown in Fig. 21(1). By Theorem 6.8, we only need to prove no torus splits $C_1 \cup C_2$ and $C_0 \cup D_3^I \cup D_4^I$. The regular neighborhood of the later complex is isotopic to the regular neighborhood of the graph U_I in Fig. 21(2). The result follows from the claim that no torus splits the red link $C_{01} \cup C_{02} \cup C_{03}$ and $C_1 \cup C_2$, which will be proved in the last paragraph of this paper by a generalized version of Theorem 6.8.

6.4. Cross disk with the least intersection points. Recall Proposition 5.4. From its proof we see that if a cross disk D_i intersects V_J in its meridian disks, then $\sharp(D_i \cap L_J) \geq 4$. In this subsection, we analyze cross disks intersecting L_J in the least number of points in detail.

Let $L = \cup_{i=1}^n C_i$ be an n -component Brunnian link. Let T be an essential torus in the complement of L , splitting S^3 into two solid tori V_I and V_J , such that $L \cap V_I = L_I = \cup_{j \in J} C_j$ and $L \cap V_J = L_J = \cup_{i \in I} C_i$. Let D_i be a cross disk bounded by C_i intersecting V_J in its meridian disks such that $\sharp(D_i \cap L_J) = 4$. We give the following 6 cases on the intersection relationship of D_i, T and L_j . See Fig. 22 for illustration.

If D_i intersects only one component of L_j :

Case	$lk(C_i, \beta_J)$	$lk(C_j, \beta_I), \forall j$	Case	$lk(C_i, \beta_J)$	$lk(C_j, \beta_I), \forall j$
(1.0.0) :	0	0	(1.2.0) :	2 ($L_I = C_i$)	0
(1.0.2) :	0	2 ($L_J = C_j$)	(1.2.2) :	2 ($L_I = C_i$)	2 ($L_J = C_j$)

If D_i intersects more than one component of L_j :

Case	$lk(C_i, \beta_J)$	$lk(C_j, \beta_I), \forall j$	Case	$lk(C_i, \beta_J)$	$lk(C_j, \beta_I), \forall j$
(2.0.0) :	0	0	(2.2.0) :	2 ($L_I = C_i$)	0

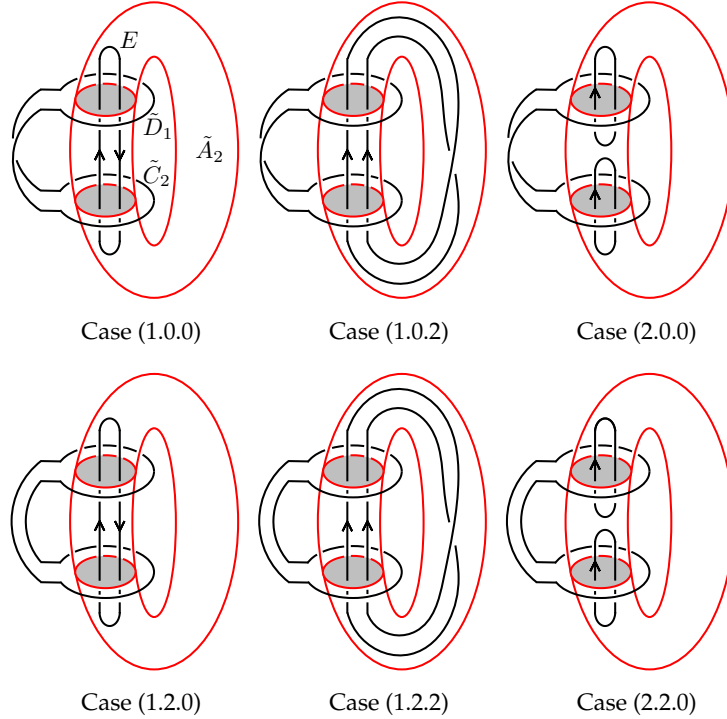

FIGURE 22. A cross disk with the least intersection points with L_j .

Lemma 6.10. (1) If D_i is an exterior cross disk, one of the 6 cases above happens.

(2) If D_i is a free cross disk, one of Case (1.0.0), (1.0.2) and (2.0.0) happens.

Proof. On account of linking number and Brunnian property, these are all the allowed cases. \square

In the following proposition, we call an arc component of $L_J - D_i$ an *ear* if its endpoints are on the same side of D_i .

Proposition 6.11. *Under Standard premise, suppose that there is only one cross disk, denoted D_i , and $\sharp(D_i \cap L_J) = 4$.*

(1) *In Case (1.0.0) (resp. (1.2.0)), there are 2 ears on one side (resp. different sides) of D_i such that after deleting each ear E , there is an incredible circle for $U - E$ on the same (resp. the other) side of D_i .*

(2) *In Case (2.0.0) (resp. (2.2.0)), once deleting an ear E , there is an incredible circle for $U - E$ on the same (resp. the other) side of D_i .*

Proof. We only give proof for Case (1.0.0), and other cases are similar. Using labels indicated in Fig. 22, after deleting E , the disk $\tilde{D}_1 \cup \tilde{A}_2$, after a perturbation, shows that \tilde{C}_2 is an incredible circle for $U - E$. \square

In the following example, we use this proposition in Step 2, and then use Proposition 6.1 in the first paragraph of Step 3. Finally we reduce the problem of showing s-primeness into showing two knotoids are not isotopic.

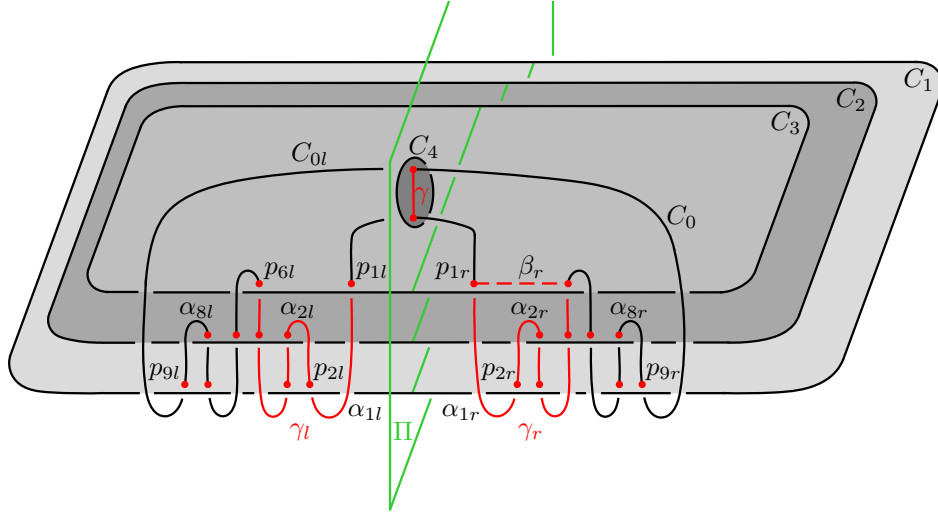

FIGURE 23. $W(5)$ and spanning complex.

Example 6.12. The link $W(5)$ is s-prime. Suppose T is an essential splitting torus.

Step 1. Take the disk D_4 bounded by C_4 as depicted in Fig 23. By Proposition 5.4, $C_0 \cup C_4$, also $C_0 \cup D_4$, are at the same side of T .

The red arc γ in D_4 and the left arc in C_0 form a circle, say C_{0l} , and $C_{0l} \cup C_1 \cup C_2 \cup C_3$ is just $W(4)$. Notice that $W(4)$ is a Milnor link, an s-sum of two Borromean rings, as there is a torus splits $C_{0l} \cup C_3$ and $C_1 \cup C_2$. Thus either T splits $C_0 \cup D_4$ and $C_1 \cup C_2 \cup C_3$, or splits $C_0 \cup D_4 \cup C_3$ and $C_1 \cup C_2$. As we have ruled out the second possibility in Example 6.9, T splits $C_0 \cup C_4$ and $C_1 \cup C_2 \cup C_3$.

Step 2. Take L_J -interior disk D_4^J and exterior cross disk D_3^E as depicted in Fig 23. Then $\sharp(D_3^E \cap C_0) = 4$ and this is Case (1.0.0) in Lemma 6.10. We claim $p_{1l} \cup p_{1r}$ are in one plausible disk and $p_{6l} \cup p_{6r}$ are in another plausible disk.

In fact, otherwise once delete γ_l , by Proposition 6.11(1), γ_r would be capped by a disk whose boundary is the asserted incredible circle. Let β_r be an arbitrary arc in the plausible disk connecting $\partial\gamma_r$. Then $\gamma_r \cup \beta_r$ is a circle capped by that disk. However, $\gamma_r \cup \beta_r$ is homotopically nontrivial in the complement of $C_1 \cup C_2$, a contradiction.

Step 3. Take L_J -interior disk D_4^J and exterior cross disk D_1^E, D_2^E and D_3^E as depicted in Fig. 23. Since p_{1l} and p_{1r} are in one plausible disk, by Proposition 6.1(1), α_{1l} and α_{1r} are in one plausible cylinder and p_{2l} and p_{2r} are in one plausible disk. Notice that by Example 3.10 the disks are all stable. It follows that $p_{il} \cup p_{ir}$ is the intersection of a plausible disk and C_0 for any $i = 1, 2, \dots, 9$, and α_{il} and α_{ir} are in one plausible cylinder, for any $i = 1, 2, \dots, 8$.

Consider $D_1^E \cup D_3^E \cup \alpha_{1l} \cup \alpha_{1r}$, then α_{1l} and α_{1r} are parallel. A standard innermost circle argument shows that α_{1l} and α_{1r} are parallel as well in the plausible cylinder. The shape in other plausible cylinders are similar. Consequently, there is a disk D_0 bounded by C_0 which is contained in V_J , intersects each plausible disk in a red arc and intersects D_4^J in two green arcs as shown in Fig. 24(1).

We see that D_1^E, D_2^E, D_3^E and L are all symmetric about the middle sphere Π , and we may assume $D_4^J \subset \Pi$. Clearly $D_0 \cap \Pi$ consists of circles and an arc connecting $\partial\gamma$. We can eliminate all the circle components by a standard innermost circle argument so that $D_0 \cap \Pi$ is an arc, say γ_Π , and then isotope D_0 so that the shape on D_0 of γ_Π and the red arcs in Fig. 24(1) are as shown in Fig. 24(2).

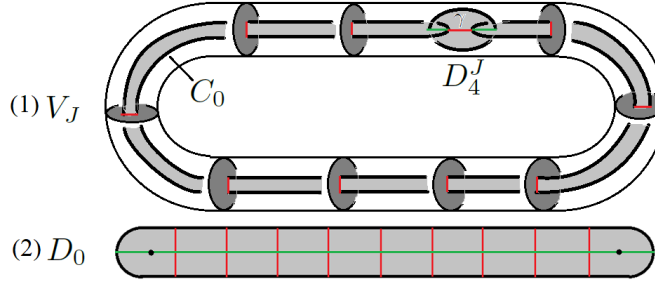

FIGURE 24. (1) $D_4^J \cup D_0$ in V_J . (2) The green arc is γ_Π .

Step 4. The left half of D_0 cut by γ_Π indicates that C_{0l} can be projected to Π as a planar curve $\gamma \cup \gamma_\Pi$, that is, parallel to $\gamma \cup \gamma_\Pi$ and intersecting the three cross disks in the left halves of red arcs. To complete the proof, it remains to show this is impossible. In fact, on account of how C_{0l} pass through the three cross disks, $\gamma \cup \gamma_\Pi$ can only be as shown in Fig 25(1). On the other hand, C_{0l} , projected to Π , is as shown in Fig 25(2). Our problem reduces to prove these two knotoids are not isotopic. In fact, connecting a_1, b_2, b_3 form two Brunnian links. One can verify that the left one is an s-sum of Whitehead link and Borromean ring, while the right one is s-prime, which can be proven by Proposition 6.11(1).

7. CONCLUSIONS

1. Series of Hyperbolic Brunnian links.

Based on the examples, we are now confident that Theorem 1.3 can be proved.

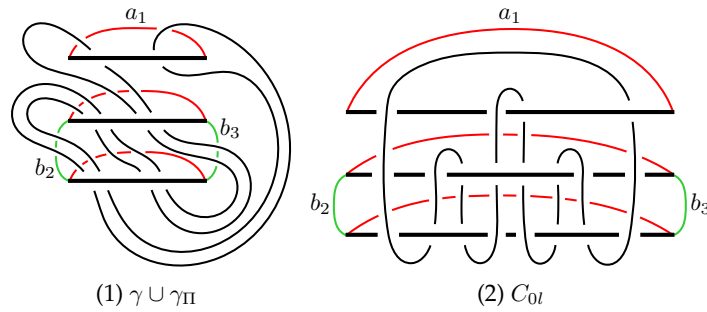

FIGURE 25. The thick arcs are the projection of left halves of C_1 , C_2 and C_3 .

Proof of Theorem 1.3. We have pointed out that all these links are untied in Subsection 4.1. We now prove they are s-prime.

(1) The proof in Example 6.2 is without loss of generality to show the links in this series are all s-prime.

(2) The proof in Example 6.4 is without loss of generality for $n \geq 5$. For $n = 3$, the proof is just simpler since it suffices to prove every component is simple. For deBrunner(2), use Case (1.2.0) in Proposition 6.11(1). For deBrunner(4), the case (ii) in the proof of Example 6.4 need to be modified by using Proposition 6.11(1) and then the approaches in [5] to show there is no incredible circle.

(3) A proof of s-primeness will follow Example 6.12 by induction on n . We know $W(5)$ is s-prime. For any $n > 5$, $W(n - 1)$ is s-prime, an argument similar to the one used in the first paragraph in Example 6.12 shows that the only possibility is that T splits $C_0 \cup D_n$ from all the other components of the link. The remainder of the proof is identical, except that in the last paragraph we distinguish two knotoids in a simpler manner as follows. For each thick arc, connecting the red arcs from below as shown in Fig. 25, we get two links. The left one will be a Milnor link, which is an s-sum[4], while the right one will be $W(n - 1)$, which is s-prime by induction.

(4) For any $m > 1, n > 2$, we have shown that $Torus(m, n)$ is s-prime in Example 6.5. For $m > 1, n = 2$, the proof is analogues to that when $m > 1, n > 2$ and is left to the reader. For $n = 1$, the link $Torus(m, 1)$ is isotopic to deBrunner(m). For $m = 1, n > 2$, $Torus(1, n)$ is Brunn's chain (See [6, 5] or recall Example 4.2). The proof of that Brunn's chains are s-prime is quite similar to that for deBrunner(n) and so is omitted.

(5) By suitable modification to the proof of $Torus(m, n)$ and Carpet (m, n, p) are s-prime, we can show Tube(m, n) is s-prime for $m > 0, n > 1$. We leave the details to the reader.

(6) When $n = 1$, Carpet(m, n, p) is the p -component Brunn's chain. When $n > 1$, the proof in Example 6.7 is without loss of generality to show Carpet(m, n, p) is s-prime. \square

2. More Hyperbolic Brunnian links.

By our methods, we discriminate s-primeness for all the Brunnian links in literatures. Recall Subsection 4.1 and the geometric classification theorem for Brunnian links in [4]. We thus get much more hyperbolic Brunnian links. Some complicated

series include Brunnian solids (Fig. 16 in [2]), Snakes, Cirrus and Wheels[5]. We only do not know whether Fountains and Jade-pendant[5] are hyperbolic.

3. Generalizations.

While we have considered only Brunnian links in this paper, the methods can be extended to links with some unknotted components. Replacing the conditions of disks all by “stable”, Theorem 4.1 detects whether there is a knotted torus containing the whole link in the solid torus side, Theorem 6.8 detects whether there is an unknotted essential torus splitting the link, and Theorem 5.6 holds as well. The proofs are almost identical, the major change being using “stable” condition instead of Brunnian property in Step 1.2 and Step 2.2 in the proof of Theorem 5.6. As an application, we can use the modified theorems to prove the links in [14] Section 5 (Fig. 2) are hyperbolic.

Our methods can be further generalized by using surfaces instead of disks. For instance, to show no torus splits $C_{01} \cup C_{02} \cup C_{03}$ and $C_1 \cup C_2$ in Fig 26, we may take the annulus A bounded by $C_{01} \cup C_{02}$, intersecting C_{03} in 4 points. Firstly, we can prove there is no incredible circle on A . Then if such a torus exists, say T , which bounds a solid torus V containing $C_{01} \cup C_{02} \cup C_{03}$, we can prove $A \subset V$ after isotopy. In fact, we can eliminate inessential circle in T as demonstrated before. To eliminate annulus regions in A outside V , the main point of our argument is that for any $i = 1, 2, 3$, $C_{0i} \cup C_1 \cup C_2$ is a Borromean ring, which is atoroidal, and thus C_{01} and C_{02} can only be the core of V , and such annulus regions in A can only be ∂ -parallel to T . Finally, it is easy to see no torus splitting $C_1 \cup C_2$ and $A \cup C_{03}$ by considering a deformation retraction of $A \cup C_{03}$.

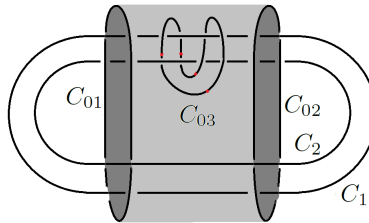

FIGURE 26. No torus splits $C_{01} \cup C_{02} \cup C_{03}$ and $C_1 \cup C_2$.

REFERENCES

- [1] N. A. Baas, D. V. Fedorov, A. S. Jensen, K. Riisager, A. G. Volosniev and N. T. Zinner. *Higher-order Brunnian structures and possible physical realizations*. arXiv:1205.0746v2 [quant-ph] 4 May 2012.
- [2] Nils A. Baas, Nadrian C. Seeman and Andrew Stacey. *Synthesising topological links*. J. Math Chem (2015) 53:183–199.
- [3] Nils A. Baas Andrew Stacey. *Investigations of higher order links*. arXiv:1602.06450v1 [math.AT].
- [4] Sheng Bai and Jiming Ma *Satellite constructions and geometric classification of Brunnian links* Submitted.
- [5] Sheng Bai and Weibiao Wang. *New criteria and constructions of Brunnian links*. Journal of Knot Theory and Its Ramifications
- [6] H. Brunn. *Über Verkettung*, *Sitzungsberichte der Bayerische Akad. Wiss. Math-Phys. Klasse*, 22 (1892), 77–99.
- [7] Ryan Budney. *JSJ-decompositions of knot and link complements in \mathbb{S}^3* . Enseign. Math, 2005 (3):319–359.
- [8] Debrunner, H. *Links of Brunnian type*, Duke Mathematical Journal 28.1 (1961): 17-23.
- [9] James W. Cannon and Michael Starbird. *On a diagram oriented proof of Dehn’s lemma*. Topology and its Applications 26 (1987) 193–205.

[10] Fedor Duzhin and Wong Shao Ming Zenas. *On two constructions of Brunnian links*. Journal of Knot Theory and Its Ramifications, Vol. 23, No. 3 (2014) 1420002 (6 pages).

[11] Tetsiya Ito. *Framing funtions and strengthened version of Dehn's lemma*. arXiv:1307.5115v3 [math.GT] 28 Sep 2014.

[12] Slavik V. Jablan. *Are Borromean Links So Rare?* Forma, 14, 269–277, 1999 <http://www.mi.sanu.ac.rs/vismath/bor/bor2.htm>.

[13] Taizo Kanenobu. *Satellite links with Brunnian properties*. Arch. Math., Vol. 44, 369–372 (1984)

[14] S. Lee. *Twisted torus knots that are unknotted*. International Mathematics Research Notices 2014, no. 18 (2014): 4958–4996.

[15] Guisong Li. *Some noninvertible links*. Proc. American Mathematical Society, Volume 126, Number 5, May 1998, Pages 1557–1563.

[16] Sergey A. Melikhov and Roman V. Mikhailov. *Finer Analogues of Milnor's Link Groups*. arXiv:math/0201022v1 [math.GT].

[17] William Menasco. *Closed incompressible surfaces in alternating knot and link complements*. Topology 23 (1984), no. 1, 37–44.

[18] John Milnor *Link groups*. Annals of Mathematics, Vol. 59, No. 2 (Mar., 1954), pp. 177–195.

[19] H. Miyazawa and A. Yasuhara. *Classification of n -component Brunnian links up to C_n -move*. Topology & Its Applications, 2004 , 153 (11) :1643–1650

[20] Dale Rolfsen. *Knots and Links*. Mathematics lecture series, Volume 7, Publish or Perish, 1976.

[21] C.D. Papkyriakopoulos. *On Dehn's Lemma and the asphericity of knots*. Ann. of Math. 66 (1957) 1–26.

8. APPENDIX: AN ALTERNATING EXAMPLE

We provide an alternative proof that a series of alternating Brunnian links are s-prime to illustrate the method in Subsection 6.3.

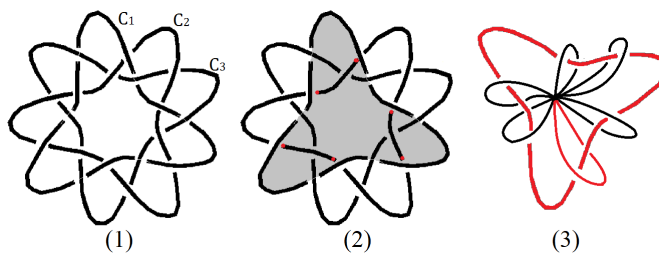

FIGURE 27. A link in one of Tait series in [12].

Example 8.1. Fig. 27(1) shows a link in a Tait series. In view of symmetry, we only need to prove no essential torus splits C_3 from C_1 and C_2 . Take the disk D_1 as shown in Fig. 27(2), which is stable by an argument similar to the one used in Example 3.11. Then a deformation retraction of $D_1 \cup C_2$ is as shown in Fig. 27(3). In view of the complement space of the red part, we see that the only splitting torus is ∂ -parallel to C_3 .

Email address: barries@163.com